

Projekt konstrukcije "Kulturoteka"

Latinčić, Ana

Master's thesis / Diplomski rad

2018

Degree Grantor / Ustanova koja je dodijelila akademski / stručni stupanj:

University of Split, Faculty of Civil Engineering, Architecture and Geodesy / Sveučilište u Splitu, Fakultet građevinarstva, arhitekture i geodezije

Permanent link / Trajna poveznica: <https://um.nsk.hr/um:nbn:hr:123:380757>

Rights / Prava: [In copyright](#)/[Zaštićeno autorskim pravom.](#)

Download date / Datum preuzimanja: **2024-08-25**



Repository / Repozitorij:

[FCEAG Repository - Repository of the Faculty of Civil Engineering, Architecture and Geodesy, University of Split](#)



UNIVERSITY OF SPLIT



SVEUČILIŠTE U SPLITU
FAKULTET GRAĐEVINARSTVA, ARHITEKTURE
I GEODEZIJE

Projekt konstrukcije „Kulturoteka“

Ana Latinčić

Split, 2018.

SVEUČILIŠTE U SPLITU
FAKULTET GRAĐEVINARSTVA, ARHITEKTURE I GEODEZIJE

Primljeno: 21.08.2018		
Jed.	Broj	Prilog
02	124/39	

STUDIJ: **DIPLOMSKI SVEUČILIŠNI STUDIJ GRAĐEVINARSTVA**

KANDIDAT: Ana Latinčić

BROJ INDEKSA: 609

KATEDRA: **Katedra za metalne i drvene konstrukcije**

PREDMET: Metalne konstrukcije

ZADATAK ZA DIPLOMSKI RAD

Tema: Izrada projekta konstrukcije za objekt „Kulturoteka“ u Šibeniku

Opis zadatka:

Prema podlogama iz arhitektonskog rješenja, kandidatkinja mora izraditi projekt konstrukcije predmetnog objekta. Rješenje sadrži odabir adekvatnog statičkog sustava, odabir materijala te optimalno dimenzionirano rješenje konstrukcije. Potrebno je odrediti djelovanja na konstrukciju, prema predmetnoj lokaciji te dimenzionirati čeličnu konstrukciju prema Eurocode normi. Fasadna konstrukcija ne spada u projektni zadatak. Od dinamičkih opterećenja potrebno je uzeti u obzir potresno djelovanje. Pored glavnih dijelova konstrukcije, potrebno je dimenzionirati karakteristične spojeve.

U Splitu, 12.03.2018.

Voditelj Diplomskog rada:

doc.dr.sc. Vladimir Divić

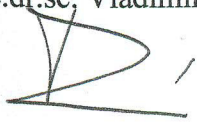

Predsjednik Povjerenstva
za završne i diplomske ispite:
Doc. dr. sc. Veljko Srzić

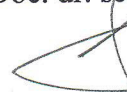

1. TEHNIČKI OPIS	4
1.1. OPIS KONSTRUKCIJE	4
1.2. OPIS MONTAŽE KONSTRUKCIJE.....	5
1.3. PRIMJENJENI PROPISI	5
1.4. ANTIKOROZIVNA ZAŠTITA	5
1.5. PROTUPOŽARNA ZAŠTITA.....	6
2. NUMERIČKI MODEL KONSTRUKCIJE	7
3. ANALIZA OPTEREĆENJA	11
3.1. STALNO OPTEREĆENJE.....	11
3.2. DODATNO STALNO OPTEREĆENJE.....	11
3.3. POKRETNOST OPTEREĆENJE.....	15
3.4. OPTEREĆENJE VJETROM.....	19
3.5. SNIJEG	28
2.4 TEMPERATURNO DJELOVANJE.....	31
4. DIMENZIONIRANJE	34
4.1. Dimenzioniranje amfiteatra-tribina.....	35
4.1.1. REZNE SILE- DONJA POJASNICA GLAVNOG REŠETKASTOG NOSAČA	35
4.1.2. DIMENZIONIRANJE- GORNJA POJASNICA GLAVNOG REŠETKASTOG NOSAČA.....	36
4.1.3. REZNE SILE-DONJA POJASNICA GLAVNOG REŠETKASTOG NOSAČA.	40
4.1.4. DIMENZIONIRANJE-DONJA POJASNICA GLAVNOG REŠETKASTOG NOSAČA.....	41
4.1.5. REZNE SILE-ISPUNA GLAVNOG REŠETKASTOG NOSAČA.....	44
4.1.6. DIMENZIONIRANJE- ISPUNA GLAVNOG REŠETKASTOG NOSAČA.....	44
4.1.7. REZNE SILE-GORNJA POJASNICA SEKUNDARNOG REŠETKASTOG NOSAČA.....	48
4.1.8. DIMENZIONIRANJE-GORNJA POJASNICA SEKUNDARNOG REŠETKASTOG NOSAČA	49
4.1.9. REZNE SILE-DONJA POJASNICA SEKUNDARNOG REŠETKASTOG NOSAČA.....	52
4.1.10. DIMENZIONIRANJE-DONJA POJASNICA SEKUNDARNOG REŠETKASTOG NOSAČA	53
4.1.11. REZNE SILE –ISPUNA SEKUNDARNOG REŠETKASTOG NOSAČA	56
4.1.12. DIMENZIONIRANJE –ISPUNA SEKUNDARNOG REŠETKASTOG NOSAČA	57
4.2. DIMENZIONIRANJE IZLOŽBENOG PROSTORA-1.KAT	60
4.2.1. REZNE SILE –DONJI POJAS SEKUNDARNOG REŠETKASTOG NOSAČA	60
4.2.2. DIMENZIONIRANJE –DONJI POJAS SEKUNDARNOG REŠETKASTOG NOSAČA.....	61

4.2.3. REZNE SILE – GORNJA POJASNICA SEKUNDARNOG REŠETKASTOG NOSAČA.....	65
4.2.4. DIMENZIONIRANJE – GORNJA POJASNICA SEKUNDARNOG REŠETKASTOG NOSAČA	66
4.2.5. DIMENZIONIRANJE – SEKUNDARNI NOSAČ 1	68
4.2.6. DIMENZIONIRANJE – SEKUNDARNI NOSAČ 2.....	72
4.3. DIMENZIONIRANJE PROSTORA ZA BALET- 2.KAT	76
4.3.1. REZNE SILE –GORNJI POJAS GLAVNOG REŠETKASTOG NOSAČA	76
4.3.2. DIMENZIONIRANJE –GORNJI POJAS GLAVNOG REŠETKASTOG NOSAČA	77
4.3.3. REZNE SILE –DONJI POJAS GLAVNOG REŠETKASTOG NOSAČA.....	82
4.3.4. DIMENZIONIRANJE –DONJI POJAS GLAVNOG REŠETKASTOG NOSAČA	83
4.3.5. REZNE SILE –DONJI POJAS SEKUNDARNOG REŠETKASTOG NOSAČA	85
4.3.6. DIMENZIONIRANJE –DONJI POJAS SEKUNDARNOG REŠETKASTOG NOSAČA.....	86
4.3.7. REZNE SILE-ISPUNA SEKUNDARNOG REŠETKASTOG NOSAČA	90
4.3.8. DIMENZIONIRANJE-ISPUNA SEKUNDARNOG REŠETKASTOG NOSAČA	90
4.3.9. REZNE SILE-SEKUNDARNI NOSAČ 1.....	94
4.3.10. DIMENZIONIRANJE-SEKUNDARNI NOSAČ 1	95
4.4. DIMENZIONIRANJE PROSTORA ZA BALET- POZICIJA 300	99
4.4.1. REZNE SILE-GORNJI POJAS GLAVNOG REŠETKASTOG NOSAČA.....	99
4.4.2. DIMENZIONIRANJE-GORNJI POJAS GLAVNOG REŠETKASTOG NOSAČA	100
4.4.3. REZNE SILE-DONJI POJAS GLAVNOG REŠETKASTOG NOSAČA.....	104
4.4.4. DIMENZIONIRANJE-DONJI POJAS GLAVNOG REŠETKASTOG NOSAČA	105
4.5. DIMENZIONIRANJE KINA-POZICIJA 600.....	109
4.5.1. REZNE SILE-DONJI POJAS GLAVNOG REŠETKASTOG NOSAČA.....	109
4.5.2. DIMENZIONIRANJE-DONJI POJAS GLAVNOG REŠETKASTOG NOSAČA	110
4.6. DIMENZIONIRANJE KROV-POZICIJA 700	114
4.6.1. REZNE SILE-DONJI POJAS GLAVNOG REŠETKASTOG NOSAČA.....	114
4.6.2. DIMENZIONIRANJE-DONJI POJAS GLAVNOG REŠETKASTOG NOSAČA	115
4.6.3. REZNE SILE-GORNJI POJAS SEKUNDARNOG REŠETKASTOG NOSAČA	118
4.6.4. DIMENZIONIRANJE-GORNJI POJAS GLAVNOG REŠETKASTOG NOSAČA	119
4.6.5. REZNE SILE-ISPUNA GLAVNOG REŠETKASTOG NOSAČA	123

4.6.6.	DIMENZIONIRANJE –ISPUNA GLAVNOG REŠETKASTOG NOSAČA	123
4.6.7.	REZNE SILE –GORNJI POJAS SEKUNDARNOG REŠETKASTOG NOSAČA 126	
4.6.8.	DIMENZIONIRANJE–GORNJI POJAS SEKUNDARNOG REŠETKASTOG NOSAČA.....	127
4.6.9.	REZNE SILE-ISPUNA SEKUNDARNOG REŠETKASTOG NOSAČA	131
4.6.10.	DIMENZIONIRANJE-ISPUNA SEKUNDARNOG REŠETKASTOG NOSAČA 131	
4.7.	DIMENZIONIRANJE GLAVNOG NOSAČA-STUBIŠTE POZ 100.....	136
4.7.1.	REZNE SILE –GLAVNI NOSAČ STUBIŠTE POZ 100	136
4.7.2.	DIMENZIONIRANJE – GLAVNI NOSAČ STUBIŠTE POZ 100	137
4.8.	DIMENZIONIRANJE GLAVNOG NOSAČA 2-STUBIŠTE POZ 100.....	141
4.8.1.	REZNE SILE –GLAVNI NOSAČ STUBIŠTE 2 POZ 100	141
4.8.2.	DIMENZIONIRANJE – GLAVNI NOSAČ STUBIŠTE 2 POZ 100	142
4.8.3.	granično stanje uporabljivosti- nosač 2 poz 100	145
4.9.	DIMENZIONIRANJE GLAVNOG NOSAČA-STUBIŠTE 3 POZ 100.....	146
4.9.1.	REZNE SILE –GLAVNI NOSAČ STUBIŠTE 3 POZ 100	146
4.9.2.	DIMENZIONIRANJE – GLAVNI NOSAČ STUBIŠTE 3 POZ 100	147
4.9.3.	granično stanje uporabljivosti- nosač 3 poz 100	152
4.10.	DIMENZIONIRANJE GLAVNOG NOSAČA-STUBIŠTE 1 POZ 200.....	152
4.10.1.	REZNE SILE –GLAVNI NOSAČ STUBIŠTE 1 POZ 200	152
4.10.2.	DIMENZIONIRANJE – GLAVNI NOSAČ STUBIŠTE 1 POZ 200.....	154
4.10.3.	granično stanje uporabljivosti- - nosač 1 poz 200.....	157
4.11.	DIMENZIONIRANJE GLAVNOG NOSAČA-STUBIŠTE 1 POZ 300.....	157
4.11.1.	REZNE SILE –GLAVNI NOSAČ STUBIŠTE 1 POZ 300	157
4.11.2.	DIMENZIONIRANJE – GLAVNI NOSAČ STUBIŠTE 1 POZ 300	159
4.12.	DIMENZIONIRANJE GLAVNOG NOSAČA-STUBIŠTE 1 POZ 400.....	162
4.12.1.	REZNE SILE –GLAVNI NOSAČ STUBIŠTE 1 POZ 400	162
4.12.2.	DIMENZIONIRANJE – GLAVNI NOSAČ STUBIŠTE 1 POZ 400	163
4.12.3.	granično stanje uporabljivosti- nosač 1 poz 400	167
4.13.	DIMENZIONIRANJE STUPA POZ 100.....	168
4.13.1.	REZNE SILE –STUP 1 POZ 100.....	168
4.13.2.	DIMENZIONIRANJE –STUP 1 POZ 100.....	168
4.13.3.	REZNE SILE –STUP 2-AMFITEATAR POZ 100.....	172
4.13.4.	DIMENZIONIRANJE –STUP 2-AMFITEATAR POZ 100.....	172
4.13.5.	REZNE SILE –STUP 3 POZ 200.....	176
4.13.6.	DIMENZIONIRANJE –STUP 3 POZ 200.....	176
4.13.7.	REZNE SILE –STUP 4 POZ 300.....	181
4.13.8.	DIMENZIONIRANJE –STUP 4 POZ 300.....	182

4.13.9.	REZNE SILE –STUP 5 POZ 400.....	185
4.13.10.	DIMENZIONIRANJE –STUP 5 POZ 400.....	185
4.13.11.	REZNE SILE –STUP 6 POZ 500	190
4.13.12.	DIMENZIONIRANJE –STUP 6 POZ 500.....	190
5.	NUMERIČKA ANALIZA.....	196
5.1.	MODALNA ANALIZA.....	197
6.	PRORAČUN PRIKLJUČAKA.....	199
6.1.	Priključak stup-greda.....	199
6.1.1.	Savijanje ploče od vlačnih vijaka	201
6.2.	PRORAČUN SPOJA STUP-TEMELJ.....	201
6.2.1.	IZRAČUN VARA	202
6.2.2.	PRORAČUN VIJAKA.....	202
6.2.3.	PRORAČUN PLOČE	203
6.3.	Vlačni nastavak rešetke – GORNJI pojas	204
6.4.	Vlačni nastavak rešetke – DONJI pojas	206
7.	ISKAZ MATERIJALA	208
8.	LITERATURA	209
9.	NACRTI.....	210

1. TEHNIČKI OPIS

1.1. OPIS KONSTRUKCIJE

Predmet ovog projekta je čelična konstrukcija Kulturnog centra Kulturoteka smještena na području Šibenika. Parcela predviđena za izgradnju objekta nalazi se u centru grada na trgu Poljana u samom centru grada.

Objekt je planiran kao višetažna konstrukcija sa kulturnim sadržajem koji uključuju amfiteatar na prvoj te kino na zadnjoj etaži.

Konstrukcija je organizirana kao jedan konstruktivno-funkcionalan sklop. Glavnu konstrukciju objekta čini 12 HEM stupova postavljenih u pravilnom rasteru te 2 armirano-betonska zida koja čine zapadnu i sjevernu fasadu od kojih sjeverni ima nepravilni, kosi oblik. Konstruktivni sistem je sastavljen od glavnih i sekundarnih čeličnih rešetkastih profila i sekundarnih vrućevaljanih HEA profila.

Međukatna ploča je čelična ortotropna postavljena između sekundarnih vrućevaljanih HEA profila postavljenih u čvorove rešetki.

Ukupna širina objekta je 17,43 m, dok duljina iznosi 24,96 m. Ukupna površina krovne plohe je cca 406,47 m². Visina objekta je 39,99 m.

Krovna rešetka se sastoji od 19 polja raspona 15,45 m. Sendvič paneli su direktno vezani za sekundarne nosače vijcima. Paneli su izrađeni od profiliranog čeličnog lima, debljine 0,5 mm, a ispuna je od 15cm polistirena.

Spoj stupa i rešetkaste konstrukcije proračunat je kao upeti. Veza stupa i rešetke ostvariti će se čeonim pločama i vijcima, gdje s vrh stupa direktno veže na donji pojas rešetke. Stupovi su vrućevaljanih profila te su upeto vezani za temelje.

Sekundarnu konstrukciju tvore krovne glavne i sekundarne rešetke kvadratnih profila te sekundarni HEA profili. Sekundarna konstrukcija je zglobno vezena za glavnu konstrukciju objekta.

Temelji su armirano betonske konstrukcije, izvedeni kao temelji samci, kvadratnog tlocrtnog oblika, dimenzije stranice 2,0 m. Visina temelja je 0,5 m. Iznad temelja je postavljena temeljena ploča debljine 20,0 cm koja nije predmet ovog projekta.

1.2. OPIS MONTAŽE KONSTRUKCIJE

Izvedba konstrukcije je montažna. Svi elementi konstrukcije predgotovljeni stižu na gradilište te se međusobno vežu vijcima.

Nulta faza montaže, nakon izvedenih svih prethodno potrebnih radova je montaža stupova. Kada se stup postavi na ankere koji su postavljeni u temelje, stup se pridržaje dizalicom dok se ne postigne vertikalnost pomoću dvostrukih vijaka. Nakon provjere vertikalnosti, vrši se ispunjenje prostora ispod spojne ploče i temelja ekspanzirajućim mortom.

Nakon toga se na stupove vežu glavne međukatne grede te glavni rešetkasti nosači koji tvore utaju konstrukcije. Sljedeći korak je postavljanje sekundarnih međukatnih greda kao isekundarnih rešetkastih nosača. Nakon toga se betonira betonska ploča koja nakon očvršćavanja tvori spregnutu konstrukciju.

Svi elementi konstrukcije se dovode na gradilište duljine do 12 m zbog transporta. Na gradilištu se poslije spajaju u veće segmente i takvi podižu dizalicom na predviđenu poziciju te vijčano spajaju na ostatak konstrukcije.

1.3. PRIMJENJENI PROPISI

Proračun i dimenzioniranje svih elemenata čelične konstrukcije provedeni su u skladu sa EUROCODE 3, a analiza dijelovanja na konstrukciju napravljena je u skladu sa EUROCODE 1. Proračun i dimenzioniranje betonskih elemenata konstrukcije te spregnute konstrukcije provedeno je u skladu sa EUROCODE 2 i EUROCODE 4. Posebno je proveden proračun zavarenih spojeva prema EN 1993, dio 1-8.

1.4. ANTIKOROZIVNA ZAŠTITA

Kod čelika pod korozijom se podrazumijeva oksidacija željeza pri dijelovanju vlage i raznih nečistoća. Agensi koji ubrzavaju hrđanje su zagađena atmosfera, industrijsko područje zagađeno sumporom, sol itd.

Zaštita čeličnih konstrukcija od hrđanja vrši se:

- premazima
- zaštita cinkom
- metalizacijom
- uporabom specijalnih čelika
- katodnom zaštitom

Zaštita premazima obavlja se u svrhu sprječavanja da kisik i vlaga dođu u dodir s čelikom. Premazivanje se obično vrši bojanjem u dva sloja: osnovni premaz i zaštitni premaz.

Osnovni premaz neposredno štiti čelik, a potrebno je da bude izrađen od tvari koje nisu štetne po ljudsko zdravlje. Zaštitni sloj služi za zaštitu osnovog premaza.

Prerano propadanje konstrukcije najčešće nastaje usljed loših detalja u konstrukciji (nepristupačna mjesta za bojenje, mjesta gdje se zadržava voda, oštri bridovi gdje se ne može nanijeti zahtjevana debljina premaza i sl.) koje treba nastojati izbjeavati.

Sistem zaštite bojanjem sastoji se iz:

- Priprema površine – trajnost premaza ovisi o prionjivosti boje za metalnu površinu, što ovisi o čistoći površine prije bojanja. Čišćenje se vrši četkama, pjeskarenjem, plamenikom ili kemijskim sredstvima.

- Nanošenje boje – bojenje se vrši četkom, valjkom ili prskanjem. Treba paziti na ograničenja za pojedine boje. Broj slojeva premaza obično se sastoji od dva a specifično od četiri ili više slojeva. Novi premaz može se vršiti tek kad je prethodni potpuno suh. Debljini

premaza potrebno je posvetiti posebnu pažnju. Općenito, deblji premaz povećava trajnost zaštite. Ukupna debljina suhih premaza treba se kretati između 0,1-0,4 mm.

Dobro izvedeni premazi traju:

- do 30 godina u zatvorenoj prostoriji
- do 20 godina kod konstrukcija zaštićenih od kiše
- do 10 godina u prirodi
- 2-3 godine u zagađenom okolišu

Zaštita pocinčavanjem podrazumijeva vrste zaštite koje se ostvaruju nanošenjem prevlake cinka i po toplom postupku. Mase i debljine prevlaka cinka za pojedine elemente određene su prema Pravilniku o tehničkim mjerama i uvjetima za zaštitu čeličnih konstrukcija

od korozije i ne mogu biti manje od 500g/m² elementa debljine 5 mm. Sve čelične konstrukcije prethodno treba odmastiti, očistiti razblaženom otopinom klorovodične kiseline te isprati hladnom vodom. Neposredno prije pocinčavanja čelična konstrukcija se stavlja u taljevinu ili otopinu za flusiranje.

Toplo pocinčavanje se izvodi stavljanjem tekućine u rastopljeni cink. Cink mora biti kvaliteta Zn 97,5 do Zn 99,5 prema HRN EN ISO 14713:2001. Prevlaka cinka dobivena toplim postupkom mora biti homogena i mora prekrivati osnovicu. Prevlaka cinka mora čvrsto prianjati za čeličnu površinu i ne smije se ljuštiti niti pucati pri uporabi.

Prije montaže potrebno je izvršiti kontrolu prevlake cinka prema HRN C.A1. 558, odnosno mase prevlake cinka prema HRN A6.021.

1.5. PROTUPOŽARNA ZAŠTITA

Pri izvedbi osigurat će se provedba svih propisa o zaštiti od požara. Pristup i intervencija vatrogasnog vozila omogućit će se sa zapadne strane parcele. Zahtijevana vatrootpornost elementa čelične konstrukcije F30. Osiguranje vatrootpornosti osiguravamo specijalnim ekspandirajućim premazima.

2. NUMERIČKI MODEL KONSTRUKCIJE

Numerički 3D render modela konstrukcije je izrađen u Scia Engineer 2017.

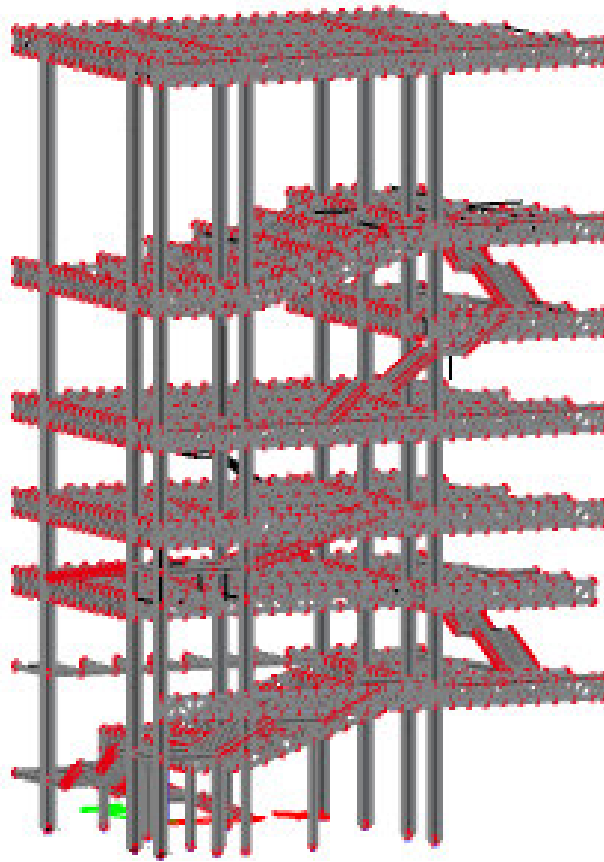

Slika 1: Izometrijski prikaz konstrukcije

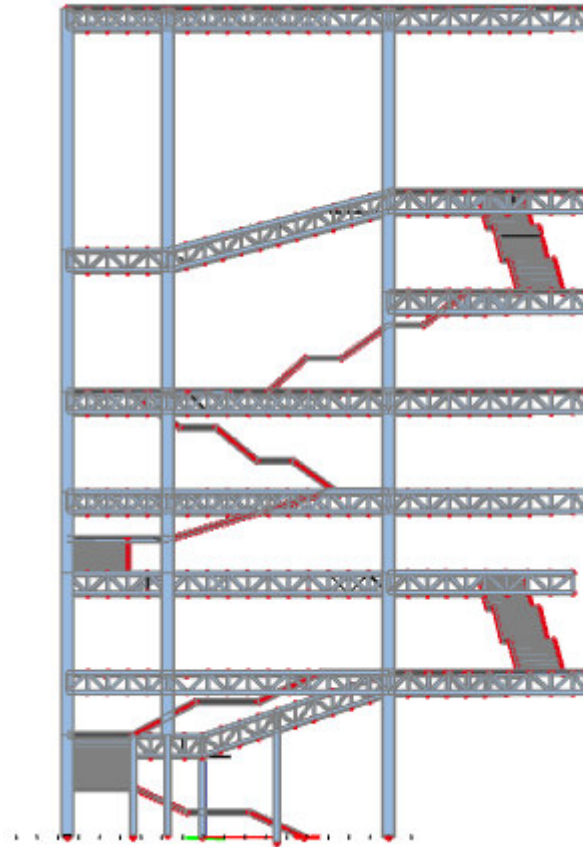

Slika 2: Pogled istočnog pročelja

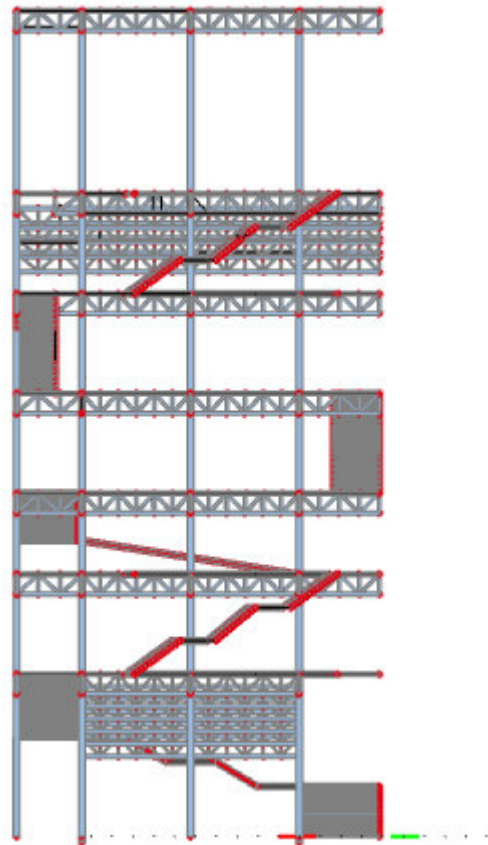

Slika 3: Pogled sjevernog pročelja



Slika 4: Pogled južnog pročelja

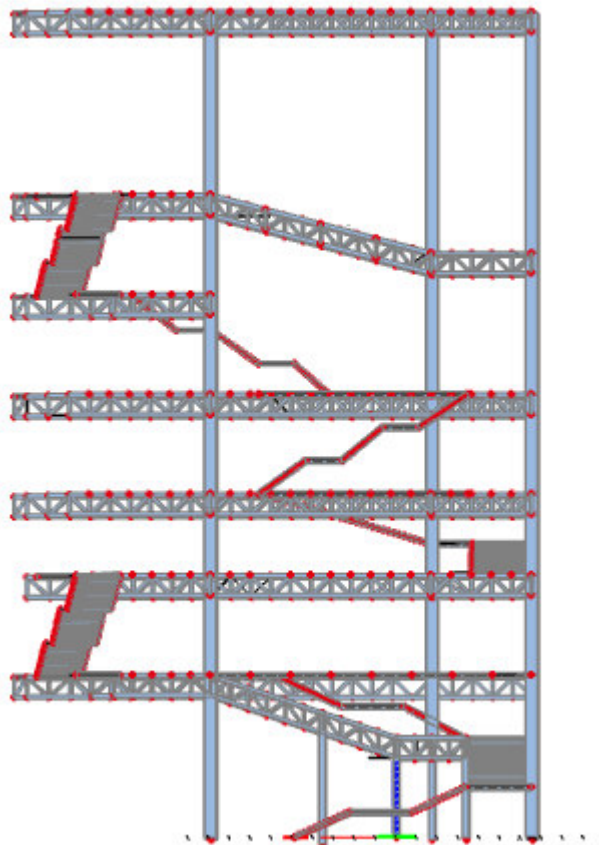

Slika 5: Pogled zapadnog pročelja

3. ANALIZA OPTEREĆENJA

3.1. STALNO OPTEREĆENJE

Stalno opterećenje uključeno je kroz numerički model.

3.2. DODATNO STALNO OPTEREĆENJE

a) pozicija 700 - krov

Pod dodatnim stalnim opterećenjem podrazumijevamo slojeve krovne konstrukcije. Naravno, ovdje nije uključena težina ploče jer je ona već zadana u numeričkom modelu.

Slojevi krovne konstrukcije	d (m)	γ (kN/m)	$d \cdot \gamma$ (kN/m ²)
Instalacije			0,11
Paneli			0,25

Ukupno dodatno stalno opterećenje: $g_{700}=0,36$ kN/m²

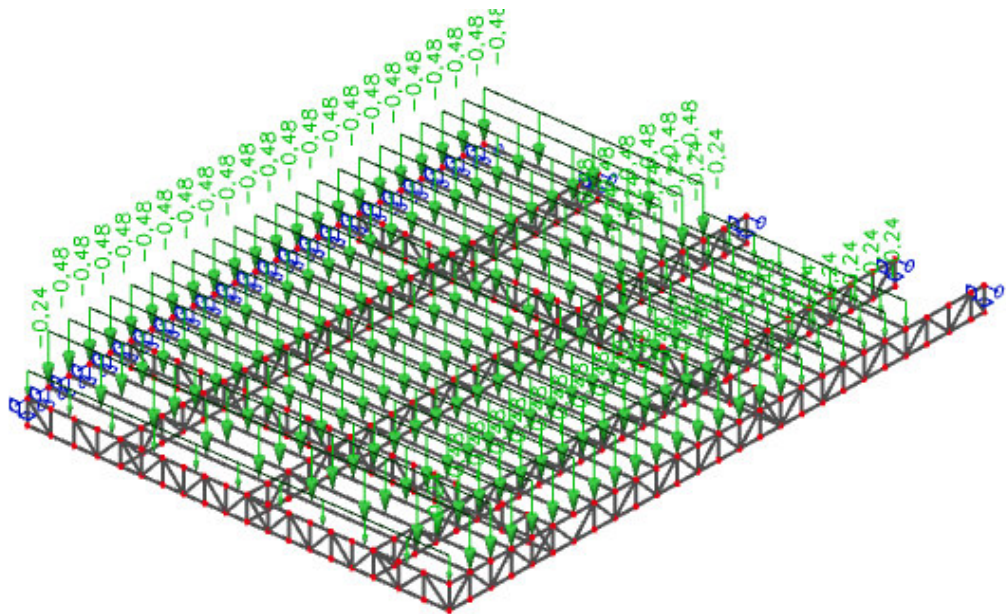

Slika 6: Prikaz raspodjele dodatnog stalnog opterećenja-krov

b) pozicija 600

amfiteatar - tribina

Slojevi međukatne konstrukcije	d (m)	γ (kN/m)	$d \cdot \gamma$ (kN/m ²)
Stolovi i stolice			0,4
Završna obrada poda	0,02	8	0,16
Toplinska izolacija	0,04	3,0	0,12
Zvučna izolacija	0,02	4,0	0,08
Ortotropna ploča	0,04	78,5	3,14

Ukupno dodatno stalno opterećenje: $g_{100}= 3,9$ kN/m²

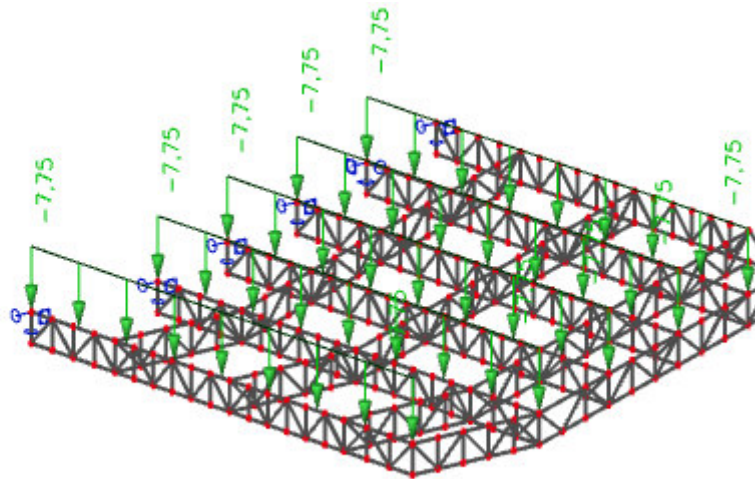

Slika 7: Prikaz raspodjele dodatnog stalnog opterećenja-kino

c) pozicija 500

Slojevi međukatne konstrukcije	d (m)	γ (kN/m)	$d \cdot \gamma$ (kN/m ²)
Završna obrada poda - parket	0,02	8	0,16
Toplinska izolacija	0,04	3,0	0,12
Zvučna izolacija	0,02	4,0	0,08
Ortotropna ploča	0,04	78,5	3,14

Ukupno dodatno stalno opterećenje: $g_{100} = 3,5 \text{ kN/m}^2$

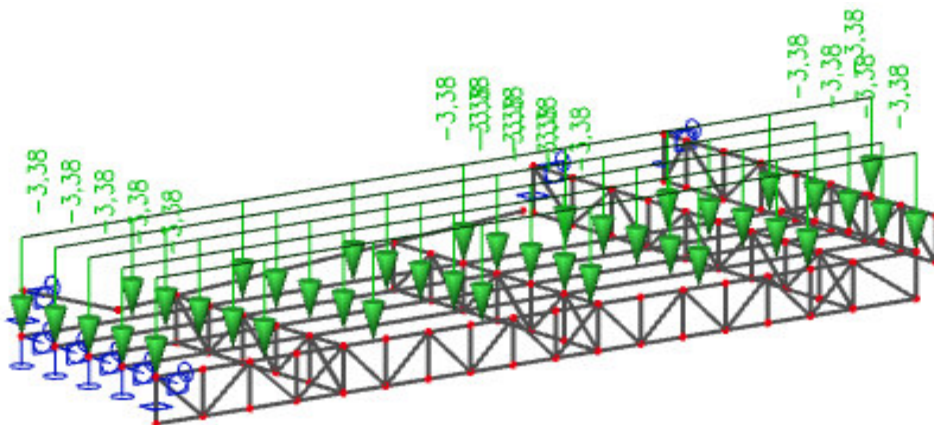

Slika 8: Prikaz raspodjele dodatnog stalnog opterećenje-galerija

d) pozicija 400

Slojevi međukatne konstrukcije	d (m)	γ (kN/m)	d · γ (kN/m ²)
Završna obrada poda - parket	0,02	8	0,16
Toplinska izolacija	0,04	3,0	0,12
Zvučna izolacija	0,02	4,0	0,08
Ortotropna ploča	0,04	78,5	3,14

Ukupno dodatno stalno opterećenje: $g_{100} = 3,5 \text{ kN/m}^2$

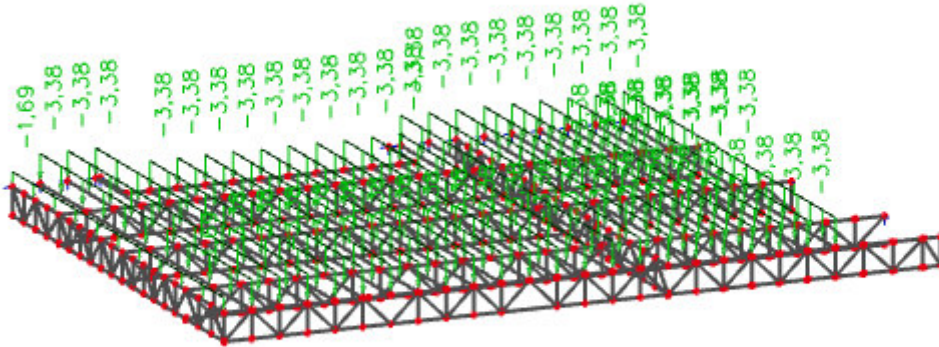

Slika 9: Prikaz raspodjele dodatnog stalnog opterećenja-restoran

e) pozicija 300

Slojevi međukatne konstrukcije	d (m)	γ (kN/m)	d · γ (kN/m ²)
Završna obrada poda - parket	0,02	8	0,16
Toplinska izolacija	0,04	3,0	0,12
Zvučna izolacija	0,02	4,0	0,08
Ortotropna ploča	0,04	78,5	3,14

Ukupno dodatno stalno opterećenje: $g_{100} = 3,5 \text{ kN/m}^2$

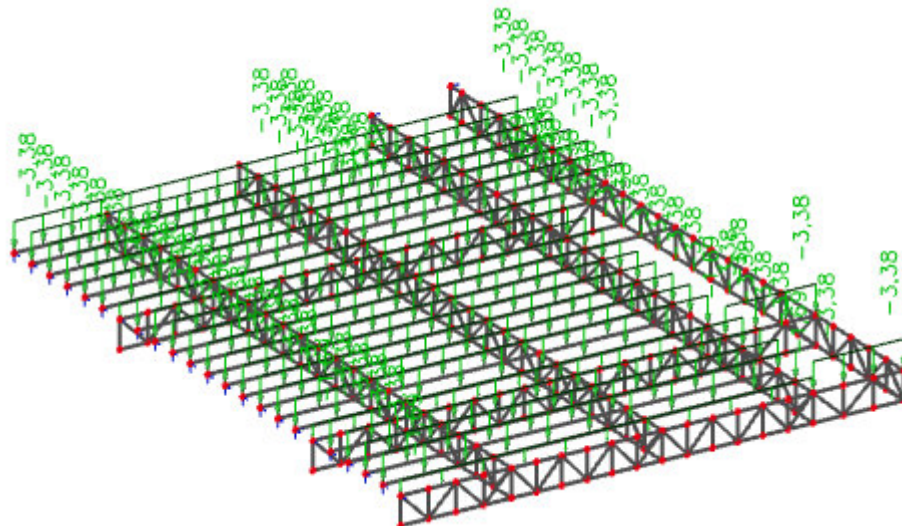

Slika 10: Prikaz raspodjele dodatnog stalnog opterećenja -dvorana

f) pozicija 200

Slojevi međukatne konstrukcije	d (m)	γ (kN/m)	$d \cdot \gamma$ (kN/m ²)
Završna obrada poda - parket	0,02	8	0,16
Toplinska izolacija	0,04	3,0	0,12
Zvučna izolacija	0,02	4,0	0,08
Ortotropna ploča	0,04	78,5	3,14

Ukupno dodatno stalno opterećenje: $g_{100} = 3,5 \text{ kN/m}^2$

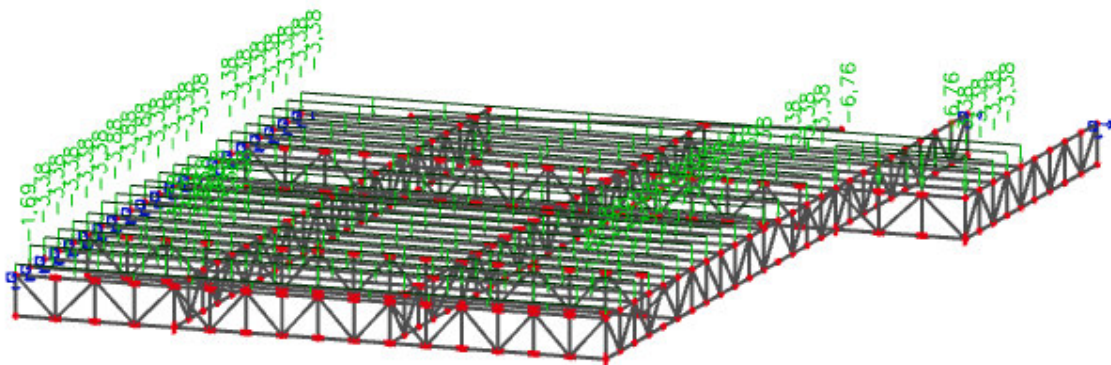

Slika 11: Prikaz raspodjele dodatnog stalnog opterećenja – baletni prostor

g) pozicija 100

Slojevi međukatne konstrukcije	d (m)	γ (kN/m)	$d \cdot \gamma$ (kN/m ²)
Završna obrada poda - parket	0,02	8	0,16
Toplinska izolacija	0,04	3,0	0,12
Zvučna izolacija	0,02	4,0	0,08
Ortotropna ploča	0,04	78,5	3,14

Ukupno dodatno stalno opterećenje: $g_{100} = 3,5 \text{ kN/m}^2$

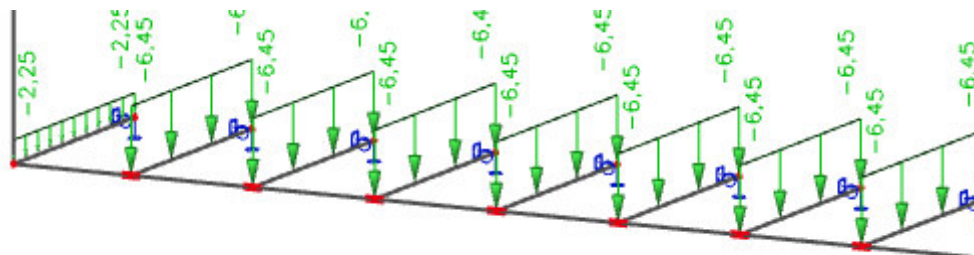

Slika 12: Prikaz raspodjele dodatnog stalnog opterećenja -Izložbeni prostor

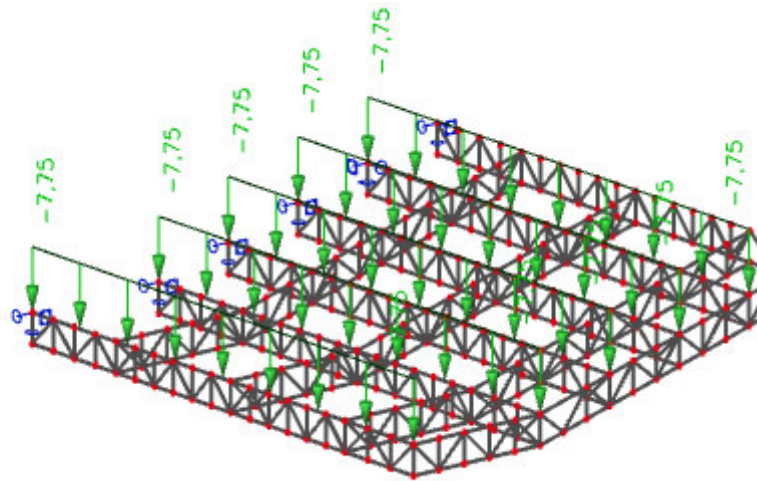

Slika 14: Prikaz raspodjele pokretnog opterećenja-kino

c) pozicija 500

- uredi, prostorije sa stolovima, kavane, restorani i recepcije – 3.0 kN/m^2

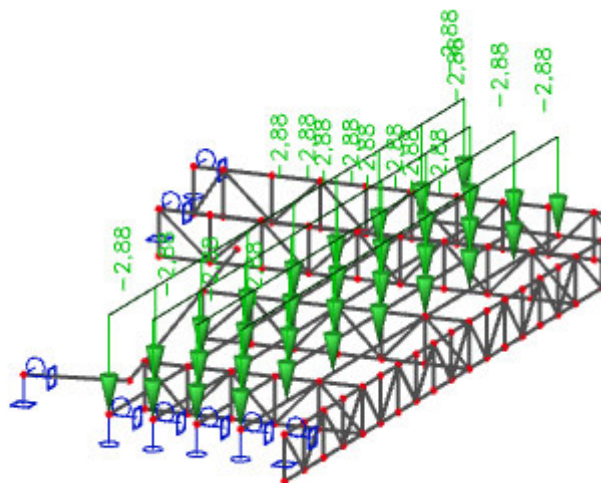

Slika 15: Prikaz raspodjele pokretnog opterećenja-galerija

d) pozicija 400

- uredi, prostorije sa stolovima, kavane, restorani i recepcije – 3.0 kN/m^2

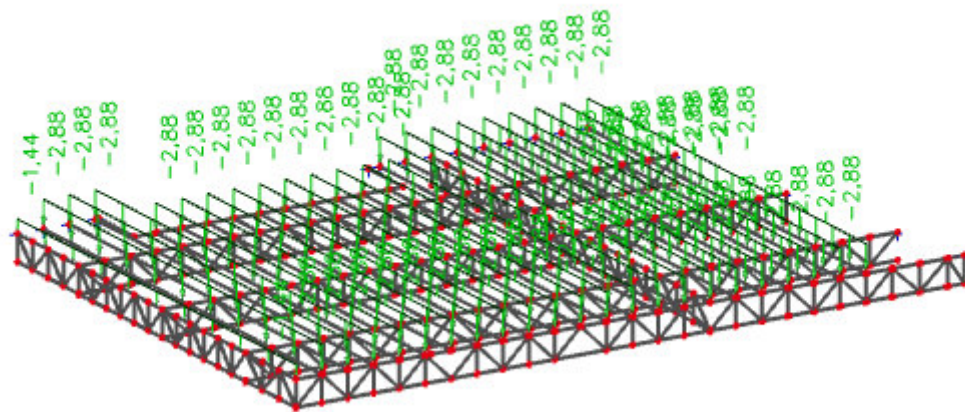

Slika 16: Prikaz raspodjele pokretnog opterećenja-restoran

e) pozicija 300

- prostorije s nepomičnim sjedalima, kina, predavaonice, čekaonice, konferencijske dvorane
- 4.0 kN/m²

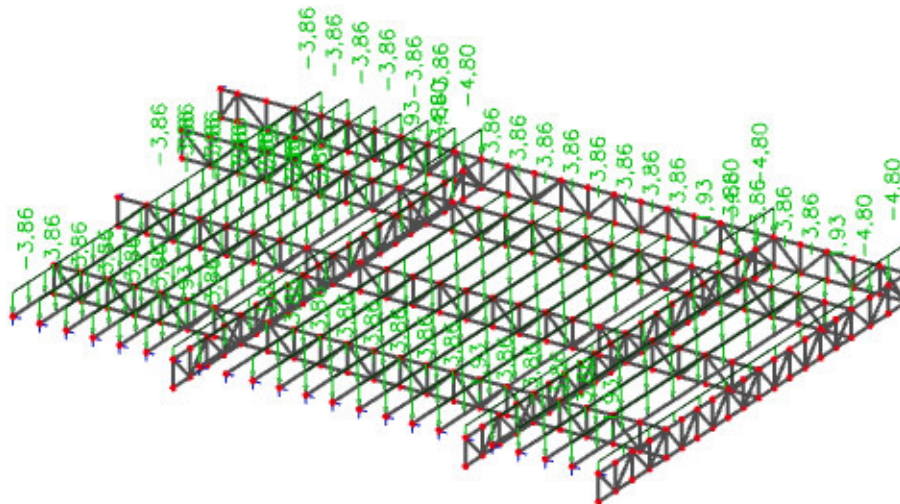

Slika 17: Prikaz raspodjele pokretnog opterećenja-dvorana

f) pozicija 200

- prostorije bez prepreka za kretanje ljudi, izložbeni prostori, pristupi u javnim i državnim zgradama - 5.0 kN/m

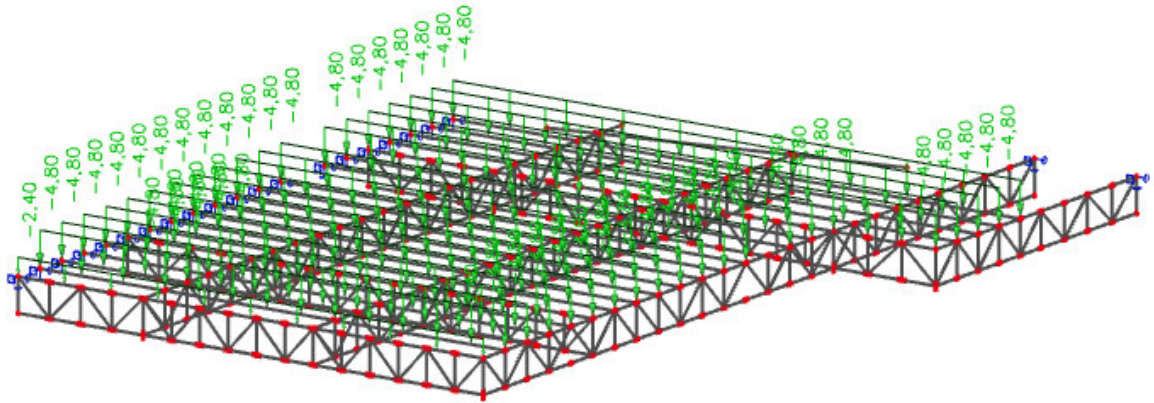

Slika 18: Prikaz raspodjele pokretnog opterećenja-baletni prostor

g) pozicija 100

- uredi, prostorije sa stolovima, kavane, restorani i recepcije – 3.0 kN/m^2

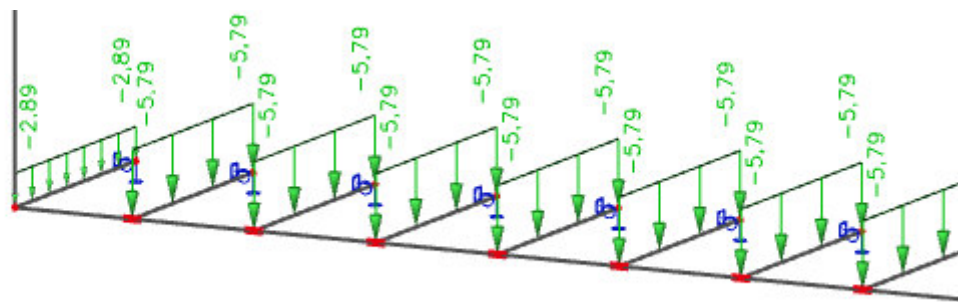

Slika 19: Prikaz raspodjele pokretnog opterećenja-izložbeni prostor

g) amfiteatar - tribina

- prostorije s nepomičnim sjedalima, kina, predavaonice, čekaonice, konferencijske dvorane
- 4.0 kN/m^2

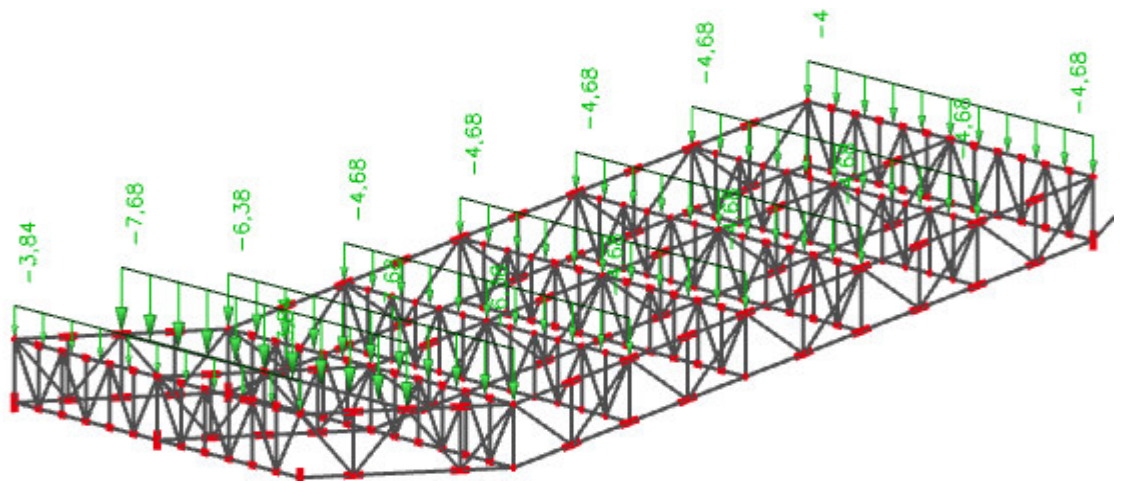

Slika 20: Prikaz raspodjele pokretnog opterećenja-amfiteatar

3.4. OPTEREĆENJE VJETROM

- pritisak vjetra na vanjske površine: $w_e = q_p(z_e) \cdot c_{pe}$ [kN/m²]
- pritisak vjetra na unutarnje površine: $w_i = q_p(z_i) \cdot c_{pi}$ [kN/m²]

gdje je:

$q_p(z_{e(i)})$ - pritisak brzine vjetra pri udaru,

z_e, z_i - referentna visina za vanjski (unutarnji) pritisak

c_{pe}, c_{pi} - koeficijent pritiska za vanjski (unutarnji) vjetar

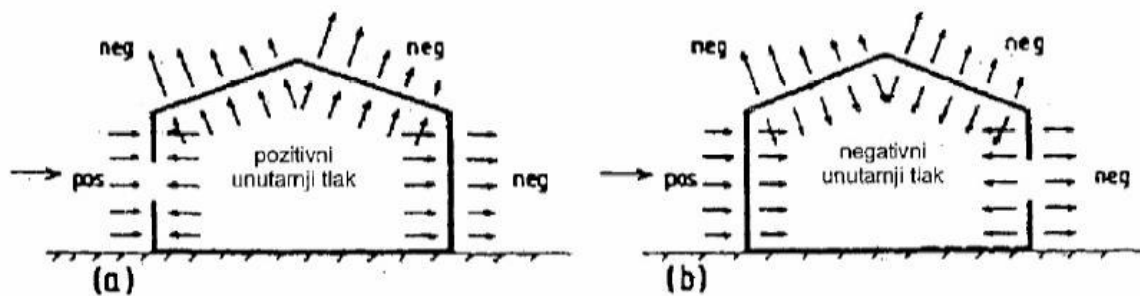

Slika 21: Pritisak vjetra

Određivanje pritiska brzine vjetra pri udaru

Osnovni pritisak vjetra q_b određuje se prema formuli:

$$q_b = \frac{\rho}{2} \cdot v_b^2$$

- ρ - gustoća zraka (usvaja se vrijednost iz propisa **1,25 kg/m³**)

- $v_b = c_{dir} \cdot c_{season} \cdot v_{b,0}$ - osnovna brzina vjetra

$v_{b,0}$ - fundamentalna vrijednost osnovne brzine vjetra (30m/s-očitano iz karte za Šibenik)

$c_{dir} = 1,0$ - faktor smjera vjetra

$c_{season} = 1,0$ - faktor doba godine

$$v_b = c_{dir} \cdot c_{season} \cdot v_{b,0} = 1,0 \cdot 1,0 \cdot 30 = 30 \text{ m/s}$$

$$q_b = \frac{\rho}{2} \cdot v_b^2 = \frac{1,25}{2} \cdot 30^2 = 0,56 \text{ kN/m}^2$$

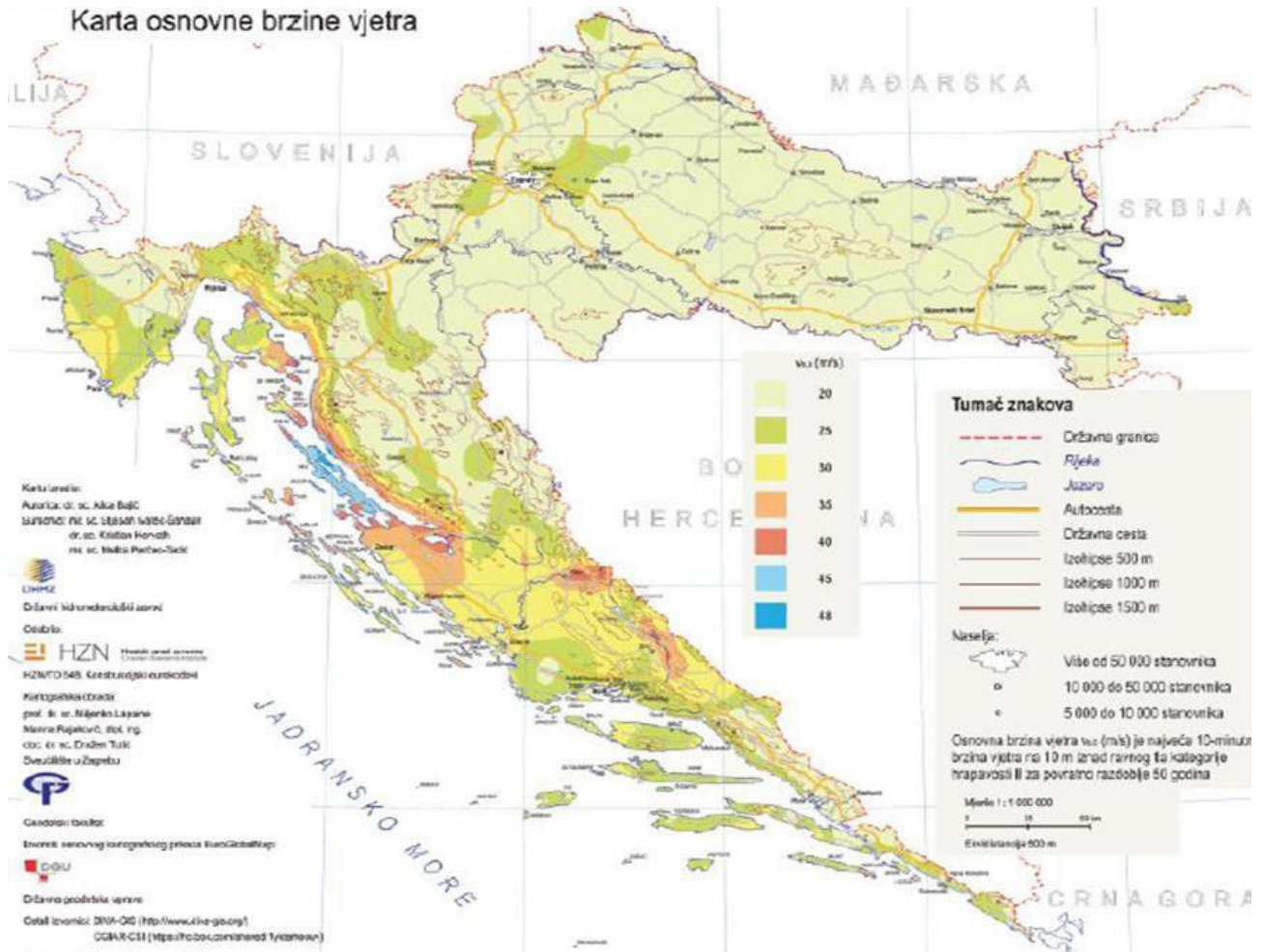

Slika 22: Zemljovid područja opterećenja vjetrom

Srednja brzina vjetra iznad terena

$$\Rightarrow v_m(z) = c_r(z) \cdot c_0(z) \cdot v_b \quad (m/s)$$

gdje je:

- $c_r(z)$ -faktor hrapavosti terena

- $c_0(z)$ -faktor orografije

Faktor hrapavosti terena:

$$\Rightarrow c_r(z) = k_r \cdot \ln\left(\frac{z}{z_0}\right) \quad (m/s) \quad \text{za } z_{\min} \leq z \leq z_{\max}$$

gdje je:

- z_0 - duljina hrapavosti

- k_r - faktor terena ovisan o duljini hrapavosti

- z_{\min} - minimalna visina hrapavosti

- z_{\max} - maksimalna visina hrapavosti (usvaja se vrijednost 200m)

Faktor terena određuje se:

$$k_r = 0,19 \left(\frac{z_0}{z_{0,II}} \right)^{0,07}$$

gdje je:

$z_{0,II}$ - duljina hrapavosti za kategoriju terena 0 (prema tablici iznosi 0,003m)

Vrijednosti z_0 i z_{min} za pojedinu kategoriju terena se očitavaju iz slijedeće tablice:

Kategorija terena		z_0 [m]	z_{min} [m]
0	More ili priobalna područja izložena otvorenom moru	0,003	1
I	Jezera ili ravna i horizontalno položena područja sa zanemarivom vegetacijom i bez prepreka	0,01	1
II	Područja s niskom vegetacijom, npr. travom, i izoliranim preprekama (drveće, zgrade) s razmakom najmanje 20 visina prepreke	0,05	2
III	Područja sa stalnim pokrovom od vegetacije ili zgrade ili područja s izoliranim preprekama s razmakom najviše 20 visina prepreke (npr. sela, predgrađa, stalna šuma)	0,3	5
IV	Područja s najmanje 15 % površine pokrivena zgradama čija prosječna visina premašuje 15 m	1,0	10

Tablica 1: Vrijednosti z_0 i z_{min} za pojedinu kategoriju terena

$$k_r = 0,19 \left(\frac{0,003}{0,003} \right)^{0,07} = 0,19(m/s)$$

$$c_r(z) = k_r \cdot \ln \left(\frac{z}{z_0} \right) (m/s)$$

$$z_0 = 0,003m$$

$$z_{min} = 1m$$

Visina objekta je 39,71 m pa je $z = 39,71m$, a z_{max} uzimamo 200m.

Budući da je $1m \leq z \leq 200m$, slijedi da se faktor hrapavosti računa prema izrazu:

$$c_r(z) = k_r \cdot \ln \left(\frac{z}{z_0} \right) (m/s) = 0,19 \cdot \ln \left(\frac{39,71}{0,003} \right) = 1,8$$

Srednja brzina vjetra iznad terena:

$$\Rightarrow v_m(z) = c_r(z) \cdot c_0(z) \cdot v_b = 1,8 \cdot 1,0 \cdot 30 = 54(m/s)$$

Proračun intenziteta turbulencije $I_V(z)$

$$\Rightarrow I_V(z) = \frac{k_1}{c_0(z) \cdot \ln \left(\frac{z}{z_0} \right)}$$

gdje je:

k_1 - faktor turbulencije (obično se uzima vrijednost 1,0 ukoliko nije drugačije definirano Nacionalnim dodatkom)

$$I_v(11,27) = \frac{1,0}{1,0 \cdot \ln\left(\frac{39,71}{0,003}\right)} = 0,11$$

Proračun pritiska za brzinu vjetra kod udara $q_p(z)$

$$q_p(z) = c_e(z) \cdot q_b = [1 + 7 \cdot I_v(z)] \cdot \frac{1}{2} \rho \cdot v_m^2(z)$$

gdje je :

$c_e(z)$ - faktor izloženosti i odnosi se na pritisak te ovisi o visini iznad terena z i kategoriji terena (očitava se iz karte)

$$c_e(z) = 3,7$$

$$q_p(39,71) = c_e(z) \cdot q_b = [1 + 7 \cdot I_v(39,71)] \cdot \frac{1}{2} \rho \cdot v_m^2(39,71)$$

$$q_p(39,71) = [1 + 7 \cdot 0,11] \cdot \frac{1}{2} 1,25 \cdot 54^2 \cdot 10^{-3} = 3,23 \text{ kN/m}^2$$

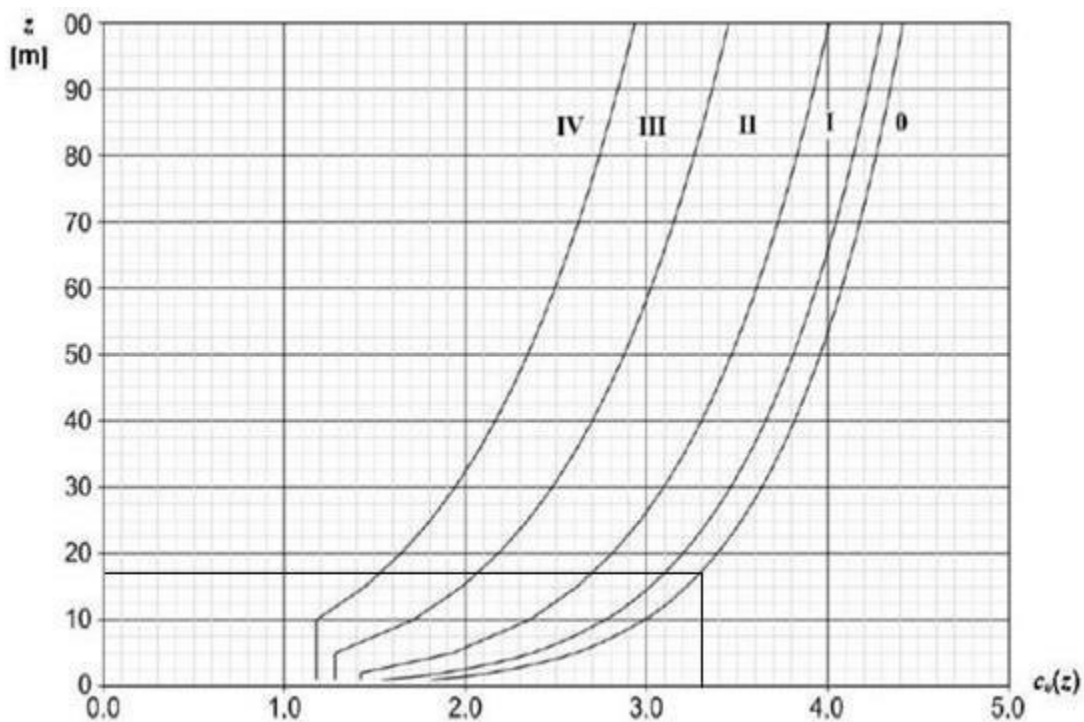

Slika 23: Grafički prikaz faktora izloženosti

Određivanje koeficijenta pritiska (c_{pe}) na vanjske površine konstrukcije

-Za vertikalne zidove

vjetar iz smjera x

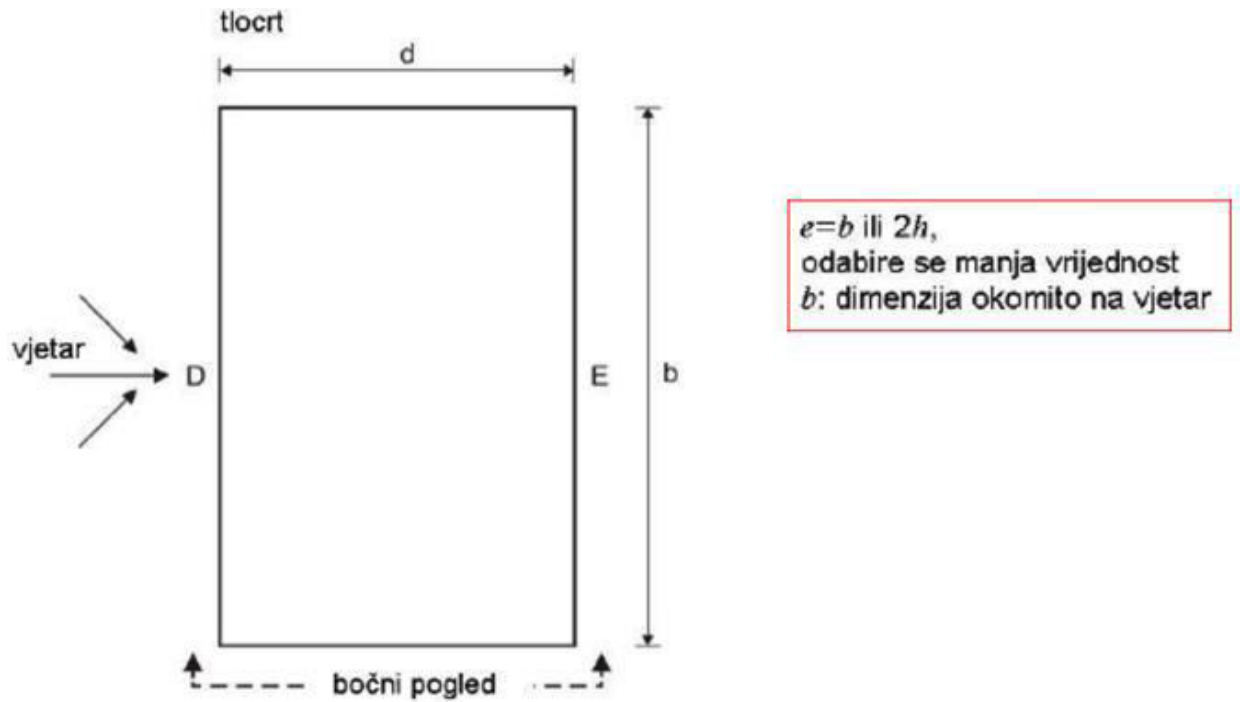

Slika 24: Definiranje područja vjetra za vertikalne zidove

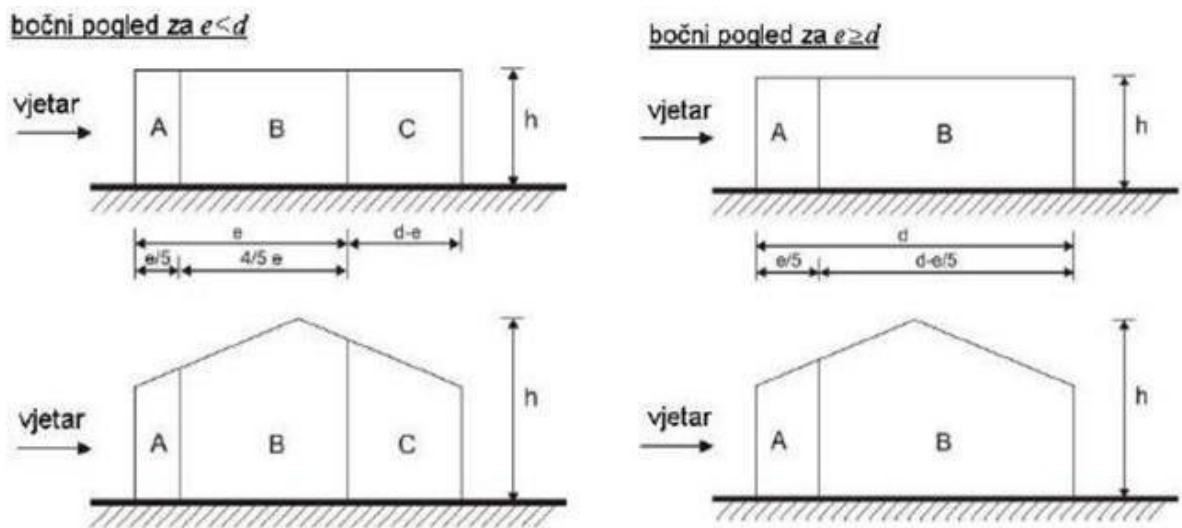

Slika 25: Prikaz područja vjetra za vertikalne zidove - bočni pogledi

$$b = 17,43 \text{ m} = e$$

$$e = 17,43 \text{ m}$$

$$d - e = 24,93 - 17,43 = 7,5 \text{ m}$$

$$2h = 2 \cdot 39,71 \text{ m} = 79,42 \text{ m}$$

$$e / 5 = 3,49 \text{ m} \quad 4 / 5e = 13,95 \text{ m}$$

Koeficijent vanjskog pritiska c_{pe} za vertikalne zidove

Područje	A		B		C		D		E	
	$c_{pe,10}$	$c_{pe,1}$	$c_{pe,10}$	$c_{pe,1}$	$c_{pe,10}$	$c_{pe,1}$	$c_{pe,10}$	$c_{pe,1}$	$c_{pe,10}$	$c_{pe,1}$
$h/d \geq 5$	-1,4	-1,7	-0,8	-1,1	-0,5	-0,7	+0,8	+1,0	-0,5	-0,7
1	-1,2	-1,4	-0,8	-1,1	-0,5		+0,8	+1,0	-0,5	
$\leq 0,25$	-1,2	-1,4	-0,8	-1,1	-0,5		+0,7	+1,0	-0,3	-0,5

NAPOMENA: Za pojedinačne zgrade na otvorenome terenu u područjima u zavjetrini mogu nastupiti i veće sile.
Međuvrijednosti se smiju linearno interpolirati.
Za zgrade čiji je omjer $h/d > 5$, ukupno opterećenje vjetrom smije se temeljiti na odredbama iz točaka od 7.6 do 7.8 i 7.9.2.

Slika 26: Vrijednosti koeficijenta vanjskog pritiska za vertikalne zidove

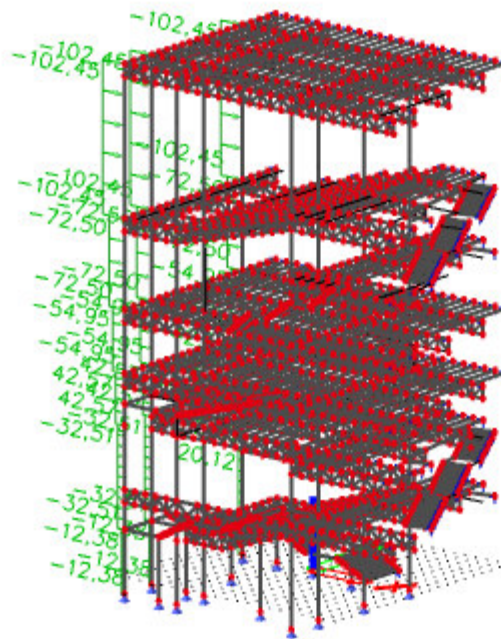

Slika 27: Prikaz opterećenja vjetera smjer x

Područje	A	B	C	D	E
$q_p(z)$ (kN/m ²)	3,23	3,23	3,23	3,23	3,23
$c_e(z)$	3,7	3,7	3,7	3,7	3,7
c_{pe}	-1,26	-0,8	-0,5	+0,8	-0,5
w_e (kN/m ²)	-4,07	-2,58	-1,62	+2,58	-1,62

Tablica 2: Izračunata vrijednost pritiska vjetera na vanjske površine zidova

Određivanje koeficijenta pritiska (c_{pe}) na vanjske površine konstrukcije

-Za vanjske površine krova

vjetar iz smjera x

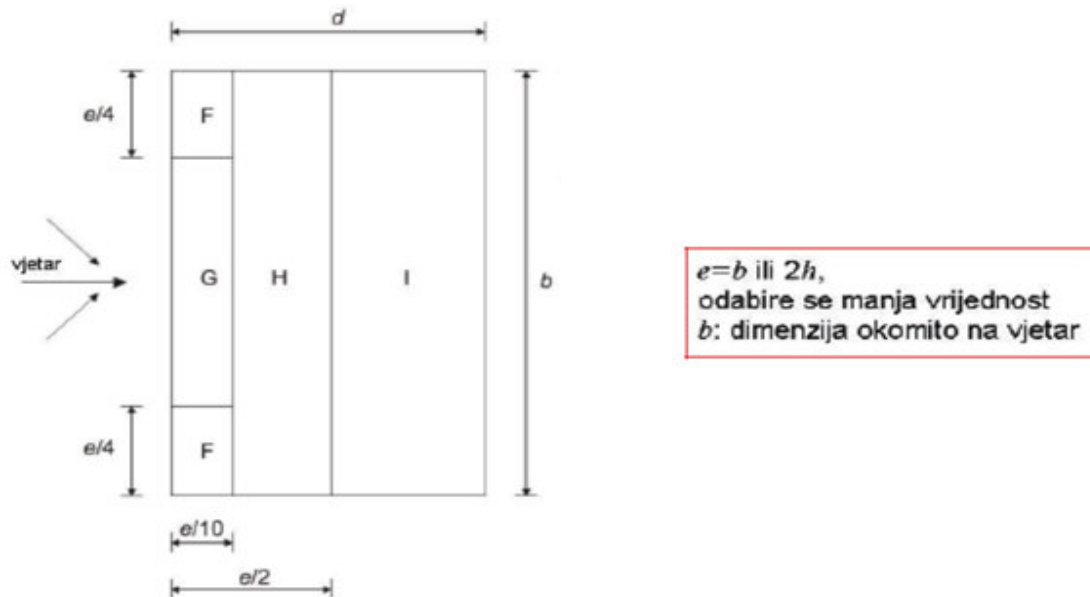

Slika 28: Prikaz područja vjetra na ravni krov

$$b = 17,43 \text{ m} = e$$

$$e = 17,43 \text{ m}$$

$$e / 4 = 4,36 \text{ m}$$

$$2h = 2 \cdot 39,71 \text{ m} = 79,42 \text{ m}$$

$$e / 2 = 8,72 \text{ m}$$

$$e / 10 = 1,74 \text{ m}$$

Vrsta krova		Područje							
		F		G		H		I	
		$c_{pe,10}$	$c_{pe,1}$	$c_{pe,10}$	$c_{pe,1}$	$c_{pe,10}$	$c_{pe,1}$	$c_{pe,10}$	$c_{pe,1}$
Oštri zabati		-1,8	-2,5	-1,2	-2,0	-0,7	-1,2	+0,2	-0,2
S nadozidima	$\lambda_p/h = 0,025$	-1,6	-2,2	-1,1	-1,8	-0,7	-1,2	+0,2	-0,2
	$\lambda_p/h = 0,05$	-1,4	-2,0	-0,9	-1,6	-0,7	-1,2	+0,2	-0,2
	$\lambda_p/h = 0,10$	-1,2	-1,8	-0,8	-1,4	-0,7	-1,2	+0,2	-0,2
Zaobljeni zabati	$r/h = 0,05$	-1,0	-1,5	-1,2	-1,8	-0,4		+0,2	-0,2
	$r/h = 0,10$	-0,7	-1,2	-0,8	-1,4	-0,3		+0,2	-0,2
	$r/h = 0,20$	-0,5	-0,8	-0,5	-0,8	-0,3		+0,2	-0,2
Izlomljeni zabati	$\alpha = 30^\circ$	-1,0	-1,5	-1,0	-1,5	-0,3		+0,2	-0,2
	$\alpha = 45^\circ$	-1,2	-1,8	-1,3	-1,9	-0,4		+0,2	-0,2
	$\alpha = 60^\circ$	-1,3	-1,9	-1,3	-1,9	-0,5		+0,2	-0,2

NAPOMENA 1: Za krovove s nadozidima ili zaobljenim zabatima, smije se upotrebljavati linearna interpolacija za međuvrijednosti λ_p/h i r/h .

NAPOMENA 2: Za krovove s izlomljenim zabatima, smije se upotrebljavati linearna interpolacija između $\alpha = 30^\circ$, 45° i 60° . Za $\alpha > 60^\circ$ smije se upotrebljavati linearna interpolacija između vrijednosti za $\alpha = 60^\circ$ i vrijednosti za ravne krovove s oštrim (izlomljenim) zabatima.

NAPOMENA 3: U području I, gdje su dane i pozitivne i negativne vrijednosti, u obzir treba uzeti obje vrijednosti.

NAPOMENA 4: Za sami izlomljeni zabat, koefijenti vanjskog saka dani su u tablici 7.43 „Koefijenti vanjskog saka za dvostrešne krovove; smjer vjetra 0°“, područje F i G, ovisno o nagibu izlomljenog zabata.

NAPOMENA 5: Za sami zaobljeni zabat, koefijent i vanjskog saka dani su linearnom interpolacijom duž krivulje, između vrijednosti na zidu i na krovu.

NAPOMENA 6: Za mansardne strehe čije su horizontalne dimenzije manje od $e/10$ treba uzeti vrijednosti za oštre strehe. Za definiciju e vidjeti sliku 7.6.

 Slika 29: Vrijednosti koeficijenta vanjskog pritiska z a područje ravnog krova

Područje	F	G	H	I
$q_p(z)$ (kN/m ²)	3,23	3,23	3,23	3,23
$c_e(z)$	3,7	3,7	3,7	3,7
c_{pe}	-1,8	-1,2	-0,7	(+0,2);(-0,2)
w_e (kN/m ²)	-5,81	-3,88	-2,26	(+0,65);(-0,65)

Tablica 3: Izračunata vrijednost pritiska vjetra na vanjske površine krova

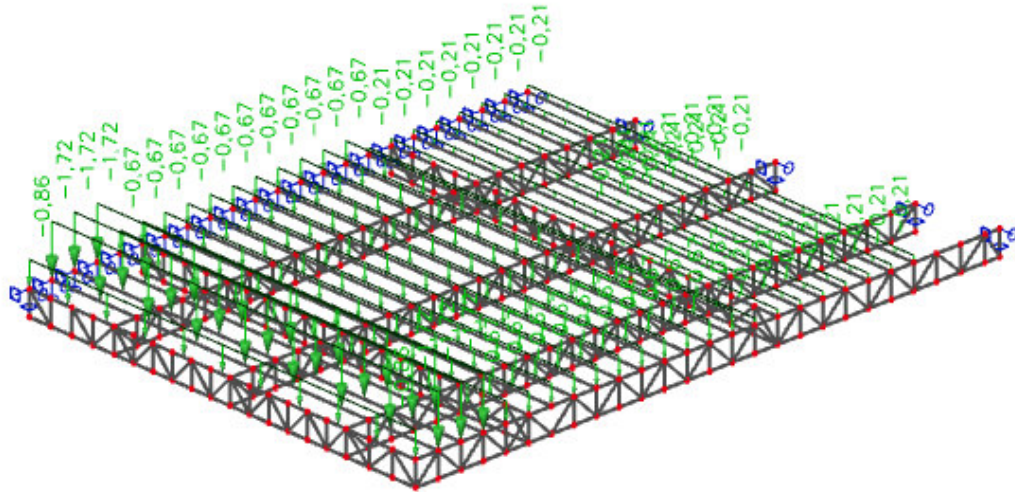

Slika 30: Prikaz raspodjele opterećenja vjetra-krov

3.5. SNIJEG

Opterećenje snijegom na krovu:

$$s = \mu_i \cdot C_e \cdot C_t \cdot s_k \text{ [kN/m}^2 \text{]}$$

- μ_i - koef. oblika za opterećenje snijegom
- s_k - karakteristična vrijednost opterećenja na tlu u (kN/m^2)
- C_e - koef. izloženosti $\Rightarrow C_e = 1,0$
- C_t - toplinski koef. $\Rightarrow C_t = 1,0$

Šibenik \rightarrow (očitana vrijednost iz karte) $\rightarrow s_k = 0.5 \text{ kN/m}^2$

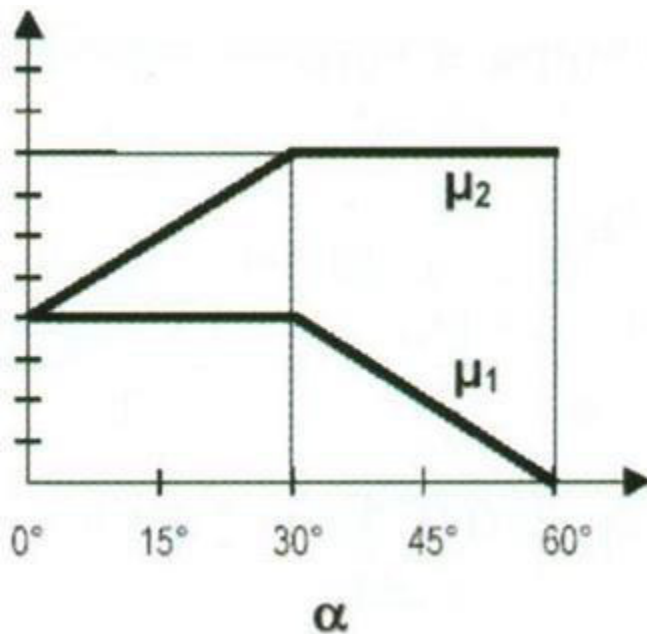

Slika 31: Koeficijenti oblika opterećenja snijegom

Za krov nagiba $\alpha = 0^\circ$, očitana vrijednost je $\Rightarrow \mu = 0,8$

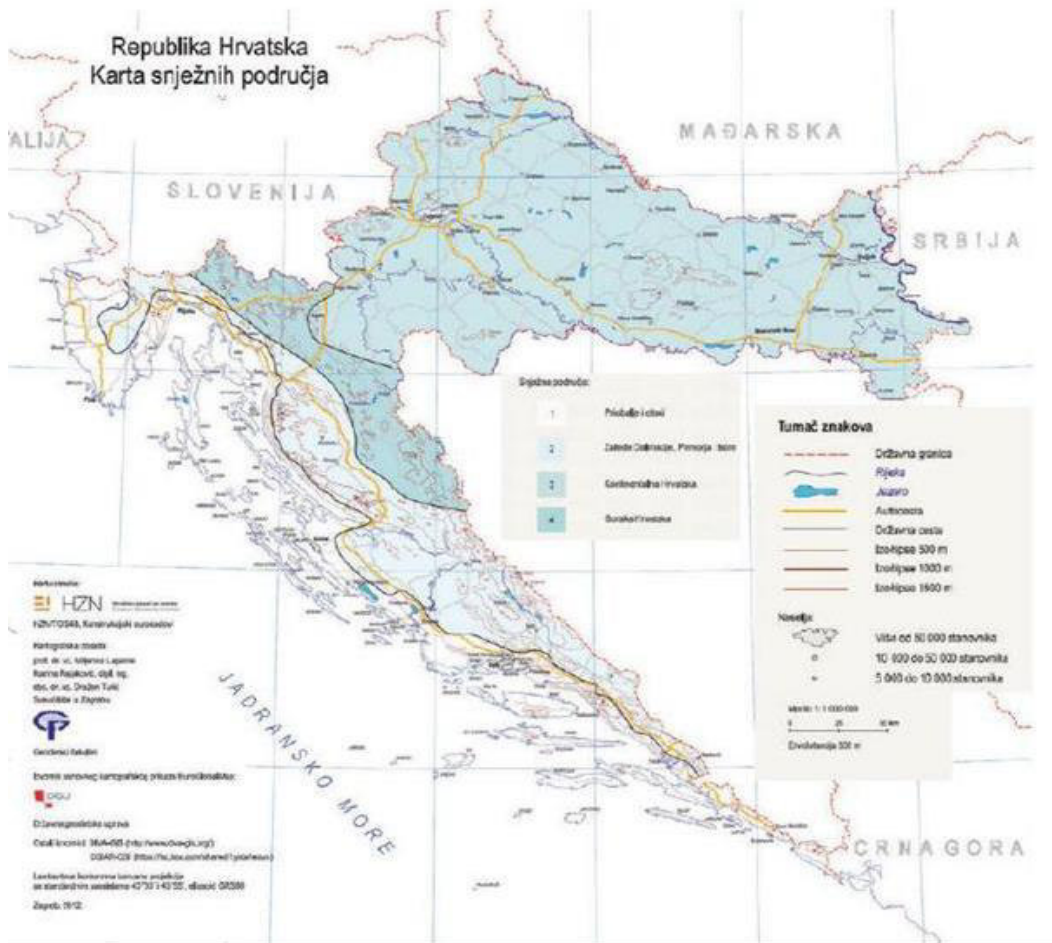

Slika 32: Karta snježnih područja

Nadmorska visina do [m]	1. područje – priobalje i otoci [kN/m ²]	2. područje – zaleđe Dalmacije, Primorja i Istre [kN/m ²]	3. područje – kontinentalna Hrvatska [kN/m ²]	4. područje – gorska Hrvatska [kN/m ²]
100	0,50	0,75	1,00	1,25
200	0,50	0,75	1,25	1,50
300	0,50	0,75	1,50	1,75
400	0,50	1,00	1,75	2,00
500	0,50	1,25	2,00	2,50
600	0,50	1,50	2,25	3,00
700	0,50	2,00	2,50	3,50
800	0,50	2,50	2,75	4,00
900	1,00	3,00	3,00	4,50
1 000	2,00	4,00	3,50	5,00
1 100	3,00	5,00	4,00	5,50
1 200	4,00	6,00	4,50	6,00
1 300	5,00	7,00		7,00
1 400	6,00	8,00		8,00
1 500		9,00		9,00
1 600		10,00		10,00
1 700		11,00		11,00
1 800		12,00		

Slika 33: Karakteristične vrijednosti opterećenja snijegom za pojedina područja i nadmorske visine

$$s = \mu_i \cdot C_e \cdot C_t \cdot s_k \text{ [kN/m}^2 \text{]}$$

$$s = 0.5 \cdot 0.8 \cdot 1.0 \cdot 1.0 = 0.4 \text{ [kN/m}^2\text{]}$$

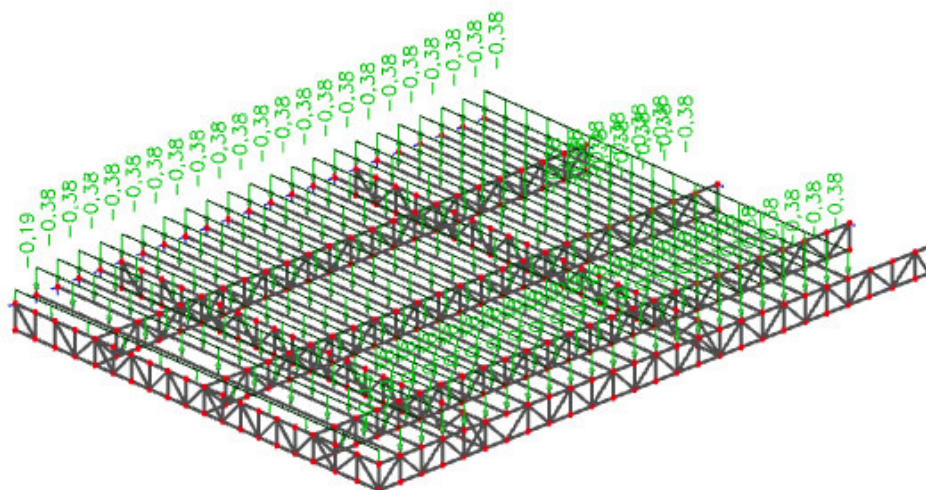

Slika 34: Prikaz raspodjele opterećenje snijegom-krov

2.4 TEMPERATURNO DJELOVANJE

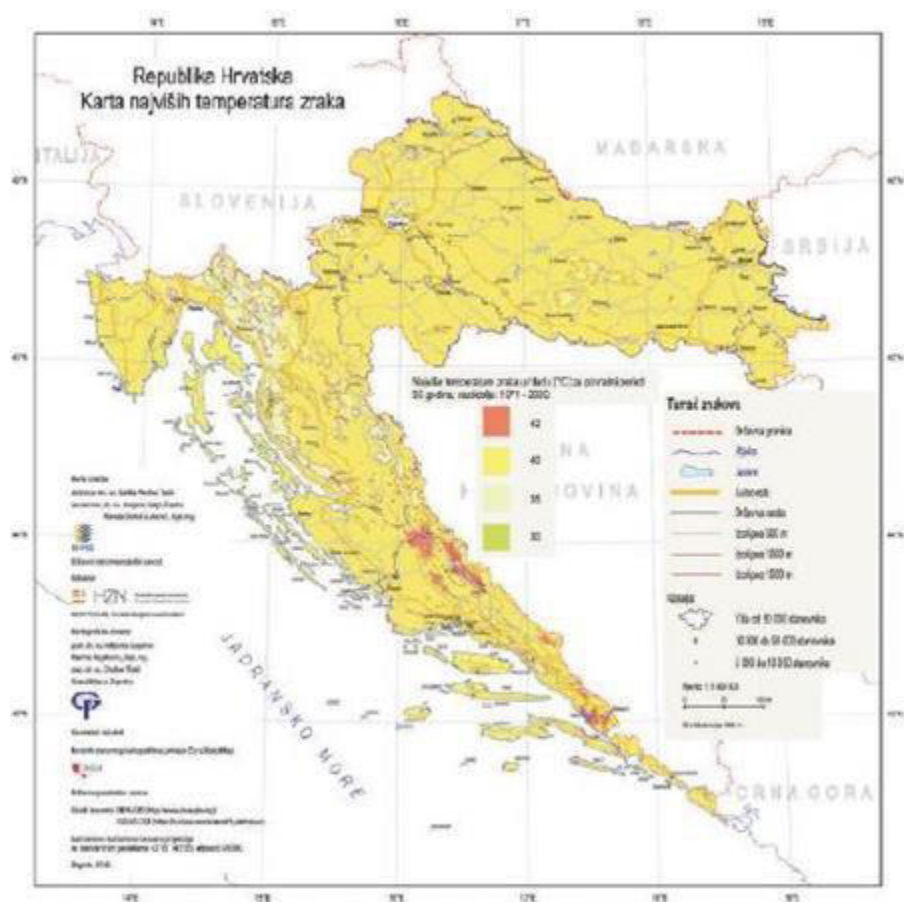

Slika 35: Karta najviših temperatura zraka

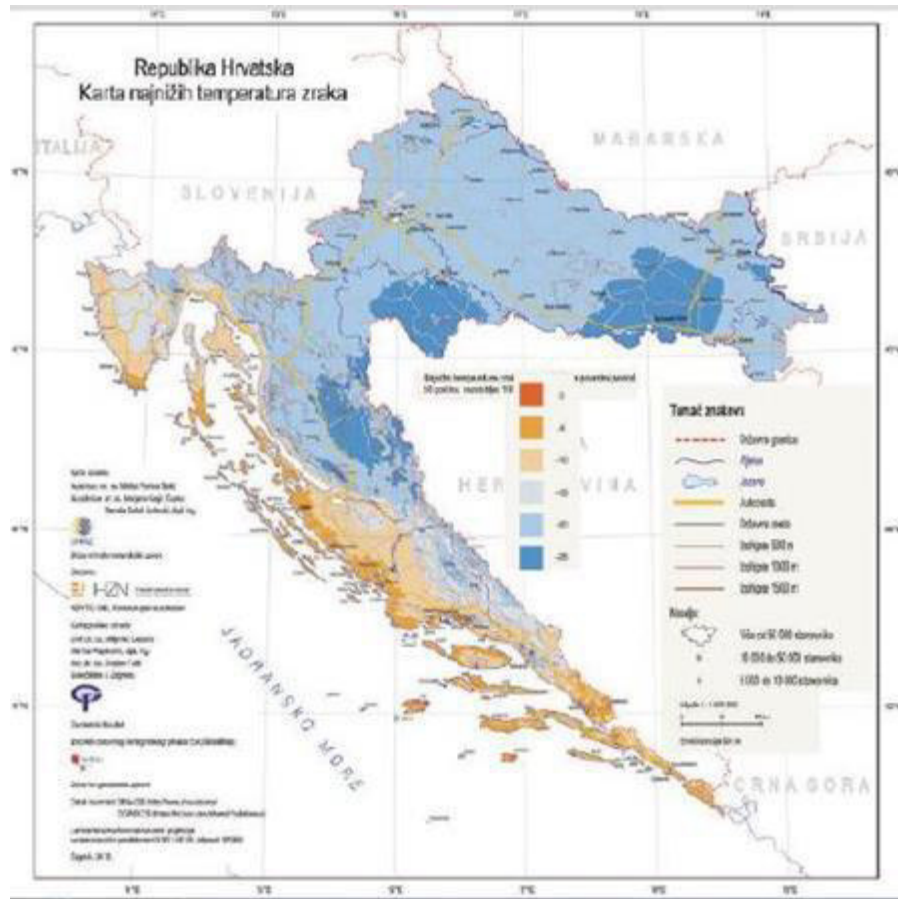

Slika 36: Karta najnižih temperatura zraka

Najviša temperatura u hladu: $T_{\max} = 42 \text{ }^{\circ}\text{C}$

Najniža temperatura u hladu: $T_{\min} = -10 \text{ }^{\circ}\text{C}$

Pretpostavlja se djelovanje jednolike temperature promjene u svim presjecima.

Pretpostavljena temperatura pri montaži konstrukcije $T = 12 \text{ }^{\circ}\text{C}$

- 1) Maksimalna pozitivna temperaturna promjena: $T_{\max} = 42 \text{ }^{\circ}\text{C} - 12 \text{ }^{\circ}\text{C} = 30 \text{ }^{\circ}\text{C}$

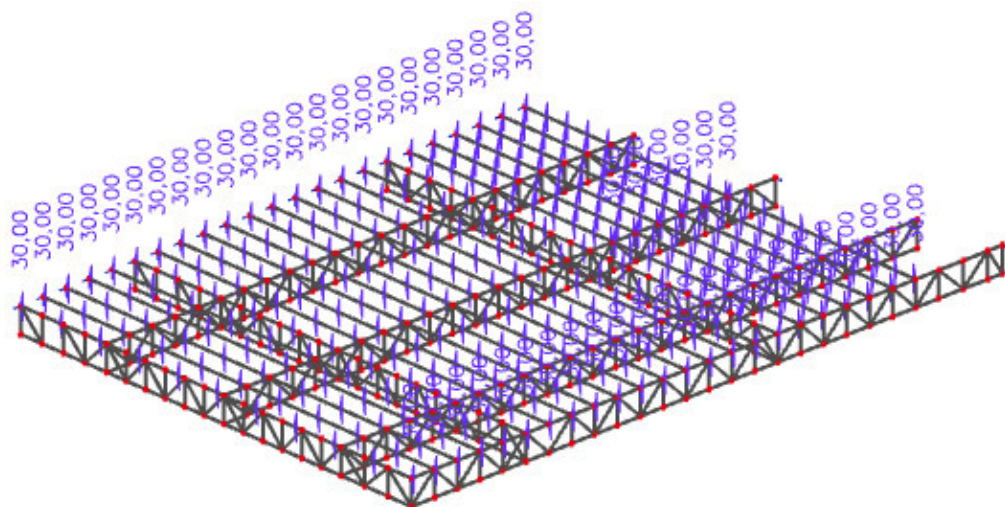

Slika 37: Prikaz raspodjele opterećenja pozitivne temperature-krov

2) Maksimalna negativna temperaturna promjena: $T_{\min} = -10^{\circ}\text{C} - 12^{\circ}\text{C} = -22^{\circ}\text{C}$

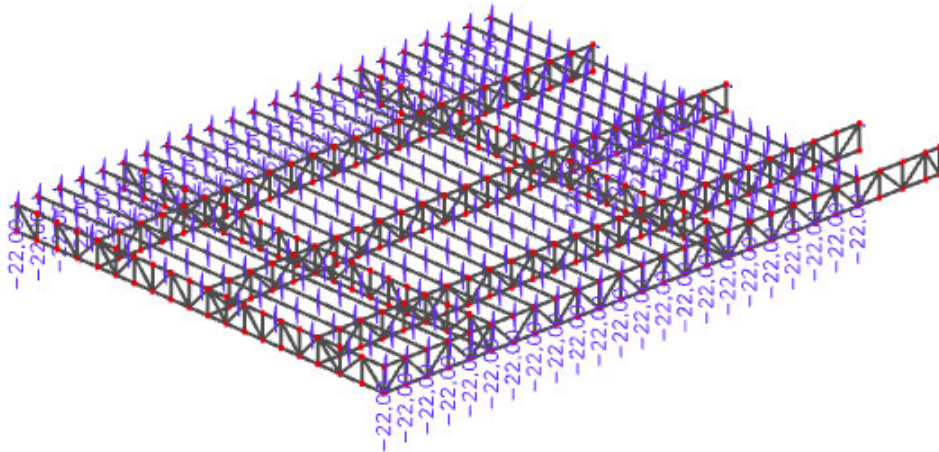

Slika 38: Prikaz raspodjele opterećenja negativne temperature-krov

4.DIMENZIONIRANJE

4.1. DIMENZIONIRANJE AMFITEATRA-TRIBINA

4.1.1. REZNE SILE- DONJA POJASNICA GLAVNOG REŠETKASTOG NOSAČA

My

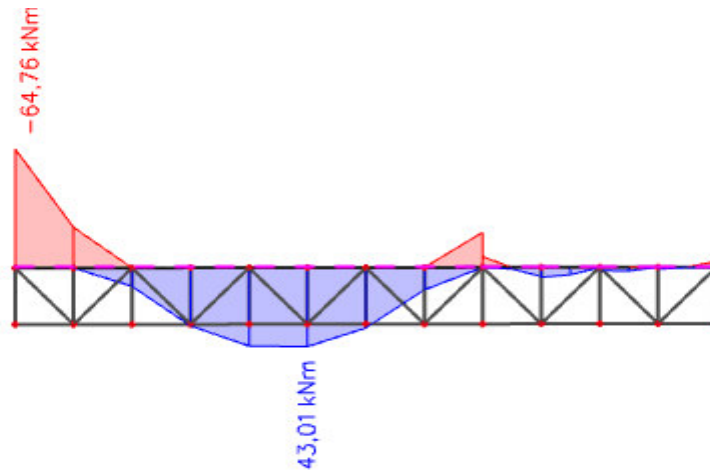

Vz

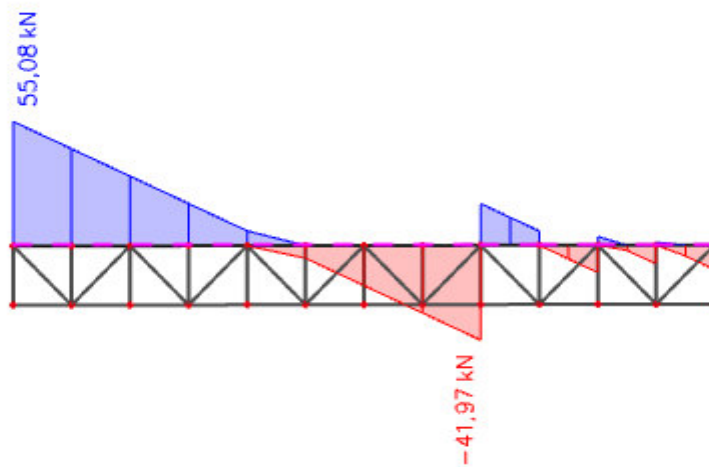

N

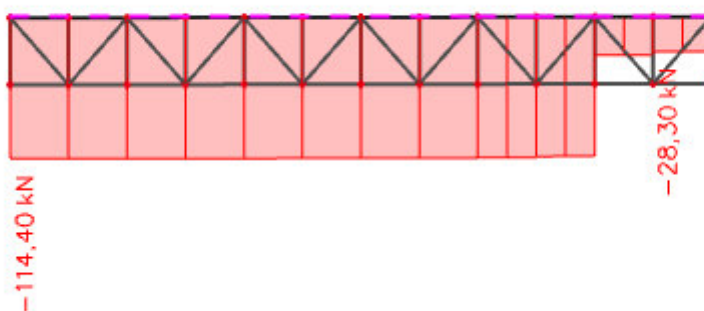

4.1.2. DIMENZIONIRANJE- GORNJA POJASNICA GLAVNOG REŠETKASTOG NOSAČA

EC-EN 1993 Steel check ULS

Linear calculation
Combination: GSN6
Coordinate system: Principal
Extreme ID: Member
Selection: B4731

EN 1993-1-1 Code Check

National annex: Standard EN

Member B4731	0,000 / 10,450 m	CFRHS200X200X10	S 355	GSN6	0,42 -
--------------	------------------	-----------------	-------	------	--------

Note: EN 1993-1-3 article 1.1(3) specifies that this part does not apply to cold formed CHS and RHS sections. The default EN 1993-1-1 code check is executed instead of the EN 1993-1-3 code check.

Combination key		
GSN6 / 1.35*vlastita težina + 1.50*pokretno + 1.35*dodatno stalno + 1.50*vjetar smjer x		
Partial safety factors		
γ_{M0} for resistance of cross-sections	1,00	
γ_{M1} for resistance to instability	1,00	
γ_{M2} for resistance of net sections	1,25	
Material		
Yield strength f_y	355,0	MPa
Ultimate strength f_u	490,0	MPa
Fabrication	Cold formed	

....SECTION CHECK:....

The critical check is on position 0,000 m

Internal forces	Calculated	Unit
N_{Ed}	-114,40	kN
$V_{y,Ed}$	1,00	kN
$V_{z,Ed}$	55,08	kN
T_{Ed}	0,12	kNm
$M_{y,Ed}$	-64,76	kNm
$M_{z,Ed}$	-6,07	kNm

Classification for cross-section design

Classification according to EN 1993-1-1 article 5.5.2
Classification of Internal and Outstand parts according to EN 1993-1-1 Table 5.2 Sheet 1 & 2

Id	Type	c [mm]	t [mm]	σ_1 [kN/m ²]	σ_2 [kN/m ²]	ψ [-]	k_{σ} [-]	α [-]	c/t [-]	Class 1 Limit [-]	Class 2 Limit [-]	Class 3 Limit [-]	Class
1	I	170	10	1,727e+05	1,484e+05	0,86		1,00	17,00	22,78	27,66	32,50	1
3	I	170	10	1,317e+05	-1,273e+05	-0,97		0,51	17,00	57,07	65,93	97,37	1
5	I	170	10	-1,412e+05	-1,169e+05								
7	I	170	10	-1,002e+05	1,589e+05	-0,63		0,61	17,00	43,20	50,91	71,21	1

Note: The Classification limits have been set according to Semi-Comp+. The cross-section is classified as Class 1

Compression check

According to EN 1993-1-1 article 6.2.4 and formula (6.9)

A	7,2570e-03	m ²
$N_{c,Rd}$	2576,24	kN
Unity check	0,04	-

Bending moment check for M_y

According to EN 1993-1-1 article 6.2.5 and formula (6.12),(6.13)

W_{ply}	5,0808e-04	m ³
$M_{ply,Rd}$	180,37	kNm
Unity check	0,36	-

Bending moment check for M_z

According to EN 1993-1-1 article 6.2.5 and formula (6.12),(6.13)

W_{plz}	5,0808e-04	m ³
$M_{plz,Rd}$	180,37	kNm
Unity check	0,03	-

Shear check for V_y

According to EN 1993-1-1 article 6.2.6 and formula (6.17)

η	1,20	
A_v	3,6285e-03	m ²
$V_{ply,Rd}$	743,69	kN
Unity check	0,00	-

Shear check for V_z

According to EN 1993-1-1 article 6.2.6 and formula (6.17)

η	1,20	
A_v	3,6285e-03	m ²
$V_{pl,z,Rd}$	743,69	kN
Unity check	0,07	-

Torsion check

According to EN 1993-1-1 article 6.2.7 and formula (6.23)

Fibre	1	
T_{Ed}	0,2	MPa
T_{Rd}	205,0	MPa
Unity check	0,00	-

Note: The unity check for torsion is lower than the limit value of 0,05. Therefore torsion is considered as insignificant and is ignored in the combined checks.

Combined bending, axial force and shear force check

According to EN 1993-1-1 article 6.2.9.1 and formula (6.41)

$M_{N,y,Rd}$	180,37	kNm
α	1,66	
$M_{N,z,Rd}$	180,37	kNm
β	1,66	

Unity check (6.41) = 0,18 + 0,00 = 0,19 -

Note: Since the shear forces are less than half the plastic shear resistances their effect on the moment resistances is neglected.

Decision tables for combined section check

Force presence	
Axial force N_{Ed}	Present
Shear force $V_{y,Ed}$	Not significant
Shear force $V_{z,Ed}$	Not significant
Torsional moment T_{Ed}	Not significant
Bending moment $M_{y,Ed}$	Present
Bending moment $M_{z,Ed}$	Present
Significant shear force without corresponding bending moment	No
Warping data	Not present or negligible

Check inputs	
Classification is supported	Yes
Section classification	Class 1
Elastic verification is set by the user	No
Plastic shear formula is available	Yes
Combined bending and axial force formula is available	Yes
Combined bending and axial force check can be calculated	Yes

Selected check	
According to EN 1993-1-1 article 6.2.9.1 and formula (6.41)	

The member satisfies the section check.

...:STABILITY CHECK:...:

Classification for member buckling design

Decisive position for stability classification: 0,000 m

Classification according to EN 1993-1-1 article 5.5.2

Classification of Internal and Outstand parts according to EN 1993-1-1 Table 5.2 Sheet 1 & 2

Id	Type	c [mm]	t [mm]	σ_1 [kN/m ²]	σ_2 [kN/m ²]	ψ [-]	k_o [-]	α [-]	c/t [-]	Class 1 Limit [-]	Class 2 Limit [-]	Class 3 Limit [-]	Class
1	I	170	10	1,727e+05	1,484e+05	0,86		1,00	17,00	22,78	27,66	32,50	1
3	I	170	10	1,317e+05	-1,273e+05	-0,97		0,51	17,00	57,07	65,93	97,37	1
5	I	170	10	-1,412e+05	-1,169e+05								
7	I	170	10	-1,002e+05	1,589e+05	-0,63		0,61	17,00	43,20	50,91	71,21	1

Note: The Classification limits have been set according to Semi-Comp+. The cross-section is classified as Class 1

Flexural Buckling check

According to EN 1993-1-1 article 6.3.1.1 and formula (6.46)

Buckling parameters	yy	zz	
Sway type	sway	non-sway	
System length L	6,967	10,450	m
Buckling factor k	0,00	0,00	
Buckling length L_{cr}	0,000	0,000	m
Critical Euler load N_{cr}	8810818901911,93	8810818901911,93	kN
Slenderness λ	0,00	0,00	

Buckling parameters	yy	zz	
Relative slenderness λ_{rel}	0,00	0,00	
Limit slenderness $\lambda_{rel,0}$	0,20	0,20	

Note: The slenderness or compression force is such that Flexural Buckling effects may be ignored according to EN 1993-1-1 article 6.3.1.2(4).

Torsional(-Flexural) Buckling check

According to EN 1993-1-1 article 6.3.1.1 and formula (6.46)

Note: The cross-section concerns a RHS section which is not susceptible to Torsional(-Flexural) Buckling.

Lateral Torsional Buckling check

According to EN 1993-1-1 article 6.3.2.1

Note: The cross-section concerns an RHS section with $h / b < 10 / \lambda_{rel,z}$. This section is thus not susceptible to Lateral Torsional Buckling.

LTB additional parameters		
Minimal z coordinate z_{min}	-100	mm
Maximal z coordinate z_{max}	100	mm
Relative slenderness $\lambda_{rel,z}$	0,00	
End moment ratio ψ	0,05	
Equivalent point load F	33,23	kN
Equivalent line load q	6,36	kN/m
Difference with M	579,04	kNm
Difference with F	327,45	kNm
Difference with q	397,15	kNm
Resulting load type	point load F	

Bending and axial compression check

According to EN 1993-1-1 article 6.3.3 and formula (6.61),(6.62)

Bending and axial compression check parameters		
Interaction method	alternative method 1	
Cross-section area A	7,2570e-03	m ²
Plastic section modulus $W_{pl,y}$	5,0808e-04	m ³
Plastic section modulus $W_{pl,z}$	5,0808e-04	m ³
Design compression force N_{Ed}	114,40	kN
Design bending moment (maximum) $M_{y,Ed}$	-64,76	kNm
Design bending moment (maximum) $M_{z,Ed}$	-6,07	kNm
Characteristic compression resistance N_{Rk}	2576,24	kN
Characteristic moment resistance $M_{y,Rk}$	180,37	kNm
Characteristic moment resistance $M_{z,Rk}$	180,37	kNm
Reduction factor χ_y	1,00	
Reduction factor χ_z	1,00	
Reduction factor χ_{LT}	1,00	
Interaction factor k_{yy}	0,98	
Interaction factor k_{yz}	0,59	
Interaction factor k_{zy}	0,59	
Interaction factor k_{zz}	0,98	

Maximum moment $M_{y,Ed}$ is derived from beam B4731 position 0,000 m.

Maximum moment $M_{z,Ed}$ is derived from beam B4731 position 0,000 m.

Interaction method 1 parameters		
Critical Euler load $N_{cr,y}$	8810818901911,93	kN
Critical Euler load $N_{cr,z}$	8810818901911,93	kN
Elastic critical load $N_{cr,T}$	487962,19	kN
Plastic section modulus $W_{pl,y}$	5,0808e-04	m ³
Elastic section modulus $W_{el,y}$	4,2511e-04	m ³
Plastic section modulus $W_{pl,z}$	5,0808e-04	m ³
Elastic section modulus $W_{el,z}$	4,2511e-04	m ³
Second moment of area I_y	4,2511e-05	m ⁴
Second moment of area I_z	4,2511e-05	m ⁴
Torsional constant I_t	7,0717e-05	m ⁴
Method for equivalent moment factor $C_{my,0}$	Table A.2 Line 2 (General)	
Design bending moment (maximum) $M_{y,Ed}$	-64,76	kNm
Maximum relative deflection δ_z	-19,7	mm
Equivalent moment factor $C_{my,0}$	1,00	
Method for equivalent moment factor $C_{mz,0}$	Table A.2 Line 2 (General)	
Design bending moment (maximum) $M_{z,Ed}$	-6,07	kNm
Maximum relative deflection δ_y	2,7	mm
Equivalent moment factor $C_{mz,0}$	1,00	
Factor μ_y	1,00	
Factor μ_z	1,00	
Factor ϵ_y	9,66	
Factor $\alpha_{1,T}$	0,00	
Critical moment for uniform bending $N_{cr,0}$	2147,68	kNm
Relative slenderness $\lambda_{rel,0}$	0,29	
Limit relative slenderness $\lambda_{rel,0,lim}$	0,27	
Equivalent moment factor C_{my}	1,00	
Equivalent moment factor C_{mz}	1,00	
Equivalent moment factor $C_{m1,T}$	1,00	

Interaction method 1 parameters		
Factor $b_{1,T}$	0,00	
Factor $c_{1,T}$	0,00	
Factor $d_{1,T}$	0,00	
Factor $e_{1,T}$	0,00	
Factor w_y	1,20	
Factor w_z	1,20	
Factor η_{pl}	0,04	
Maximum relative slenderness $\lambda_{rel,max}$	0,00	
Factor C_{yy}	1,02	
Factor C_{zz}	1,02	
Factor C_{xy}	1,02	
Factor C_{xz}	1,02	

Unity check (6.61) = $0,04 + 0,35 + 0,02 = 0,42$ -
 Unity check (6.62) = $0,04 + 0,21 + 0,03 = 0,29$ -

The member satisfies the stability check.

4.1.3. REZNE SILE-DONJA POJASNICA GLAVNOG REŠETKASTOG NOSAČA

My

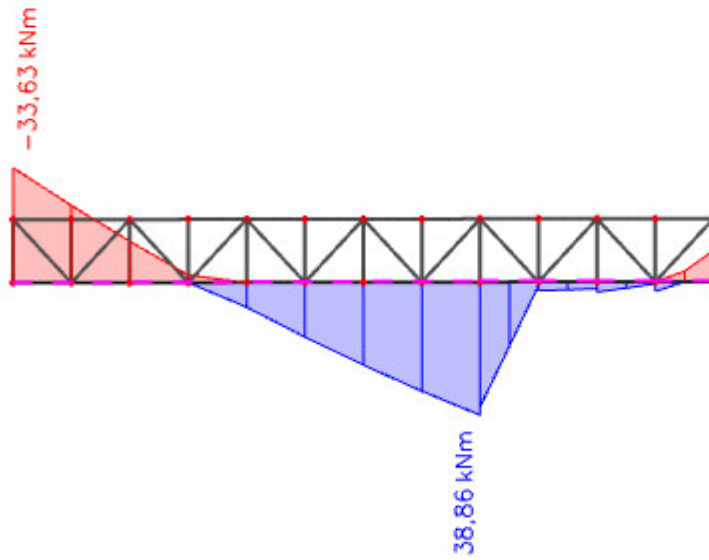

Vz

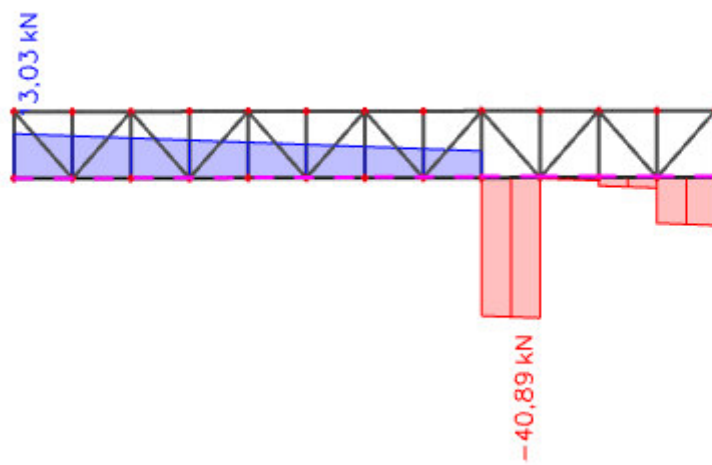

N

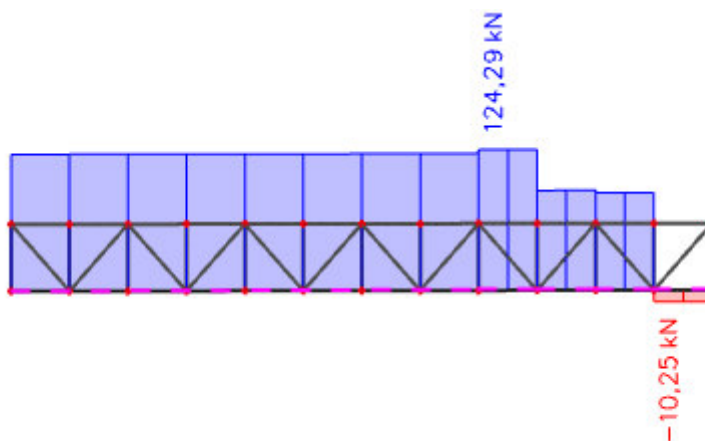

4.1.4. DIMENZIONIRANJE-DONJA POJASNICA GLAVNOG REŠETKASTOG NOSAČA

EC-EN 1993 Steel check ULS

Linear calculation

Combination: GSN6

Coordinate system: Principal

Extreme ID: Member

Selection: B4730

EN 1993-1-1 Code Check

National annex: Standard EN

Member B4730	6,967 / 10,450 m	CFRHS200X200X10	S 355	GSN6	0,22 -
--------------	------------------	-----------------	-------	------	--------

Note: EN 1993-1-3 article 1.1(3) specifies that this part does not apply to cold formed CHS and RHS sections.
The default EN 1993-1-1 code check is executed instead of the EN 1993-1-3 code check.

Combination key

GSN6 / 1.35*vlastita težina + 1.50*pokretno +
1.35*dodatno stalno + 1.50*vjetar smjer x

Partial safety factors

γ_{M0} for resistance of cross-sections	1,00
γ_{M1} for resistance to instability	1,00
γ_{M2} for resistance of net sections	1,25

Material

Yield strength f_y	355,0	MPa
Ultimate strength f_u	490,0	MPa
Fabrication	Cold formed	

....:SECTION CHECK:....

The critical check is on position 6,967 m

Internal forces	Calculated	Unit
N_{Ed}	120,84	kN
$V_{y,Ed}$	0,19	kN
$V_{z,Ed}$	7,78	kN
T_{Ed}	0,02	kNm
$M_{y,Ed}$	38,86	kNm
$M_{z,Ed}$	-0,86	kNm

Classification for cross-section design

Classification according to EN 1993-1-1 article 5.5.2

Classification of Internal and Outstand parts according to EN 1993-1-1 Table 5.2 Sheet 1 & 2

Id	Type	c [mm]	t [mm]	σ_1 [kN/m ²]	σ_2 [kN/m ²]	ψ [-]	k_{σ} [-]	α [-]	c/t [-]	Class 1 Limit [-]	Class 2 Limit [-]	Class 3 Limit [-]	Class
1	I	170	10	-1,018e+05	-1,052e+05								
3	I	170	10	-9,631e+04	5,914e+04	-1,63		0,38	17,00	76,99	88,75	169,20	1
5	I	170	10	6,848e+04	7,193e+04	0,95		1,00	17,00	22,78	27,66	31,44	1
7	I	170	10	6,299e+04	-9,245e+04	-1,47		0,41	17,00	72,28	83,32	150,80	1

Note: The Classification limits have been set according to Semi-Comp+.

The cross-section is classified as Class 1

Tension check

According to EN 1993-1-1 article 6.2.3 and formula (6.5)

A	7,2570e-03	m ²
$N_{pl,Rd}$	2576,24	kN
$N_{u,Rd}$	2560,27	kN
$N_{t,Rd}$	2560,27	kN
Unity check	0,05	-

Bending moment check for M_y

According to EN 1993-1-1 article 6.2.5 and formula (6.12),(6.13)

$W_{pl,y}$	5,0808e-04	m ³
$M_{pl,y,Rd}$	180,37	kNm
Unity check	0,22	-

Bending moment check for M_z

According to EN 1993-1-1 article 6.2.5 and formula (6.12),(6.13)

$W_{pl,z}$	5,0808e-04	m ³
$M_{pl,z,Rd}$	180,37	kNm
Unity check	0,00	-

Shear check for V_y

According to EN 1993-1-1 article 6.2.6 and formula (6.17)

I	1,20	
A_v	3,6285e-03	m ²
$V_{pl,y,Rd}$	743,69	kN
Unity check	0,00	-

Shear check for V_z

According to EN 1993-1-1 article 6.2.6 and formula (6.17)

η	1,20	
A_v	3,6285e-03	m ²
$V_{pl,z,Rd}$	743,69	kN
Unity check	0,01	-

Torsion check

According to EN 1993-1-1 article 6.2.7 and formula (6.23)

Fibre	1	
T_{Ed}	0,0	MPa
T_{Rd}	205,0	MPa
Unity check	0,00	-

Note: The unity check for torsion is lower than the limit value of 0,05. Therefore torsion is considered as insignificant and is ignored in the combined checks.

Combined bending, axial force and shear force check

According to EN 1993-1-1 article 6.2.9.1 and formula (6.41)

$M_{N,y,Rd}$	180,37	kNm
α	1,66	
$M_{N,z,Rd}$	180,37	kNm
β	1,66	

Unity check (6.41) = 0,08 + 0,00 = 0,08 -

Note: Since the shear forces are less than half the plastic shear resistances their effect on the moment resistances is neglected.

Decision tables for combined section check

Force presence	
Axial force N_{Ed}	Present
Shear force $V_{y,Ed}$	Not significant
Shear force $V_{z,Ed}$	Not significant
Torsional moment T_{Ed}	Not significant
Bending moment $M_{y,Ed}$	Present
Bending moment $M_{z,Ed}$	Present
Significant shear force without corresponding bending moment	No
Warping data	Not present or negligible

Check inputs	
Classification is supported	Yes
Section classification	Class 1
Elastic verification is set by the user	No
Plastic shear formula is available	Yes
Combined bending and axial force formula is available	Yes
Combined bending and axial force check can be calculated	Yes

Selected check	
According to EN 1993-1-1 article 6.2.9.1 and formula (6.41)	

The member satisfies the section check.

....:STABILITY CHECK:....

Classification for member buckling design

Decisive position for stability classification: 6,967 m

Classification according to EN 1993-1-1 article 5.5.2

Classification of Internal and Outstand parts according to EN 1993-1-1 Table 5.2 Sheet 1 & 2

Id	Type	c [mm]	t [mm]	σ_1 [kN/m ²]	σ_2 [kN/m ²]	ψ [-]	k_{σ} [-]	α [-]	c/t [-]	Class 1 Limit [-]	Class 2 Limit [-]	Class 3 Limit [-]	Class
1	I	170	10	-1,018e+05	-1,052e+05								
3	I	170	10	-9,631e+04	5,914e+04	-1,63		0,38	17,00	76,99	88,75	169,20	1
5	I	170	10	6,848e+04	7,193e+04	0,95		1,00	17,00	22,78	27,66	31,44	1
7	I	170	10	6,299e+04	-9,245e+04	-1,47		0,41	17,00	72,28	83,32	150,80	1

Note: The Classification limits have been set according to Semi-Comp+. The cross-section is classified as Class 1

Lateral Torsional Buckling check

According to EN 1993-1-1 article 6.3.2.1

Note: The cross-section concerns an RHS section with ' $h/b < 10 / \lambda_{rel,z}$ '. This section is thus not susceptible to Lateral Torsional Buckling.

LTB additional parameters		
Minimal z coordinate z_{min}	-100	mm
Maximal z coordinate z_{max}	100	mm
Relative slenderness $\lambda_{rel,z}$	1,19	
End moment ratio ψ	0,27	

LTB additional parameters		
Equivalent point load F	21,02	kN
Equivalent line load q	4,02	kN/m
Difference with M	393,59	kNm
Difference with F	75,36	kNm
Difference with q	169,21	kNm
Resulting load type	point load F	

The member satisfies the stability check.

4.1.5. REZNE SILE-ISPUNA GLAVNOG REŠETKASTOG NOSAČA

N

34224,
34,

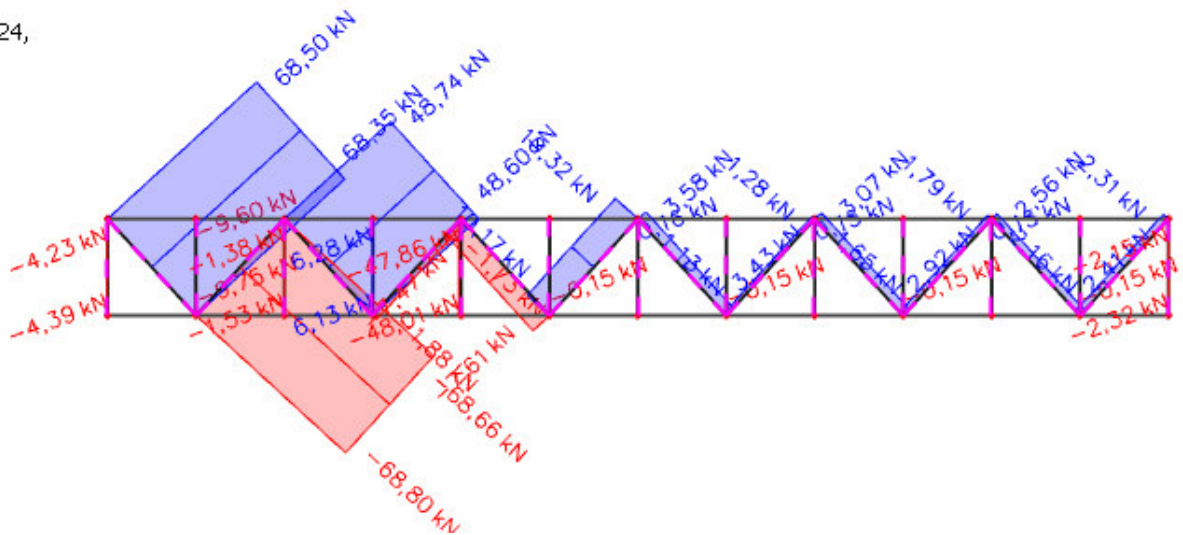

4.1.6. DIMENZIONIRANJE- ISPUNA GLAVNOG REŠETKASTOG NOSAČA

EN 1993-1-1 Code Check

National annex: Standard EN

Member B4166	0,950 / 0,950 m	CFRHS110X110X4	S 355	GSN6	0,85 -
--------------	-----------------	----------------	-------	------	--------

Note: EN 1993-1-3 article 1.1(3) specifies that this part does not apply to cold formed CHS and RHS sections. The default EN 1993-1-1 code check is executed instead of the EN 1993-1-3 code check.

Combination key	
GSN6 / 1.35*vlastita težina + 1.50*pokretno + 1.35*dodatno stalno + 1.50*vjetar smjer x	

Partial safety factors	
γ_{M0} for resistance of cross-sections	1,00
γ_{M1} for resistance to instability	1,00
γ_{M2} for resistance of net sections	1,25

Material		
Yield strength f_y	355,0	MPa
Ultimate strength f_u	490,0	MPa
Fabrication	Cold formed	

....:SECTION CHECK:....

The critical check is on position 0,950 m

Internal forces	Calculated	Unit
N_{Ed}	-3,67	kN
$V_{y,Ed}$	23,85	kN
$V_{z,Ed}$	-2,56	kN
T_{Ed}	0,82	kNm
$M_{y,Ed}$	-1,20	kNm
$M_{z,Ed}$	19,78	kNm

Classification for cross-section design

Classification according to EN 1993-1-1 article 5.5.2

Classification of Internal and Outstand parts according to EN 1993-1-1 Table 5.2 Sheet 1 & 2

Id	Type	c [mm]	t [mm]	σ_1 [kN/m ²]	σ_2 [kN/m ²]	ψ [-]	k_{α} [-]	α [-]	c/t [-]	Class 1 Limit [-]	Class 2 Limit [-]	Class 3 Limit [-]	Class
1	I	98	4	-2,939e+05	3,398e+05	-0,86		0,54	24,50	52,60	61,15	87,62	1
3	I	98	4	3,641e+05	3,258e+05	0,89		1,00	24,50	22,78	27,66	32,09	2
5	I	98	4	2,983e+05	-3,353e+05	-1,12		0,47	24,50	62,21	71,72	113,60	1
7	I	98	4	-3,596e+05	-3,213e+05								

Note: The Classification limits have been set according to Semi-Comp+.
The cross-section is classified as Class 2

Compression check

According to EN 1993-1-1 article 6.2.4 and formula (6.9)

A	1,6550e-03	m ²
$N_{c,Rd}$	587,52	kN
Unity check	0,01	-

Bending moment check for M_y

According to EN 1993-1-1 article 6.2.5 and formula (6.12),(6.13)

W_{ply}	6,5210e-05	m ³
$M_{ply,Rd}$	23,15	kNm
Unity check	0,05	-

Bending moment check for M_z

According to EN 1993-1-1 article 6.2.5 and formula (6.12),(6.13)

W_{plz}	6,5210e-05	m ³
$M_{plz,Rd}$	23,15	kNm
Unity check	0,85	-

Shear check for V_y

According to EN 1993-1-1 article 6.2.6 and formula (6.17)

η	1,20	
A_w	8,2750e-04	m ²
$V_{ply,Rd}$	169,60	kN
Unity check	0,14	-

Shear check for V_z

According to EN 1993-1-1 article 6.2.6 and formula (6.17)

η	1,20	
A_v	8,2750e-04	m ²
$V_{pl,z,Rd}$	169,60	kN
Unity check	0,02	-

Torsion check

According to EN 1993-1-1 article 6.2.7 and formula (6.23)

Fibre	1	
T_{Ed}	9,1	MPa
T_{Rd}	205,0	MPa
Unity check	0,04	-

Note: The unity check for torsion is lower than the limit value of 0,05. Therefore torsion is considered as insignificant and is ignored in the combined checks.

Combined bending, axial force and shear force check

According to EN 1993-1-1 article 6.2.9.1 and formula (6.41)

$M_{N,y,Rd}$	23,15	kNm
α	1,66	
$M_{N,z,Rd}$	23,15	kNm
β	1,66	

Unity check (6.41) = 0,01 + 0,77 = 0,78 -

Note: Since the shear forces are less than half the plastic shear resistances their effect on the moment resistances is neglected.

The member satisfies the section check.

...:STABILITY CHECK:...:

Classification for member buckling design

Decisive position for stability classification: 0,950 m

Classification according to EN 1993-1-1 article 5.5.2

Classification of Internal and Outstand parts according to EN 1993-1-1 Table 5.2 Sheet 1 & 2

Id	Type	c [mm]	t [mm]	σ_1 [kN/m ²]	σ_2 [kN/m ²]	ψ [-]	k_o [-]	α [-]	c/t [-]	Class 1 Limit [-]	Class 2 Limit [-]	Class 3 Limit [-]	Class
1	I	98	4	-2,939e+05	3,398e+05	-0,86		0,54	24,50	52,60	61,15	87,62	1
3	I	98	4	3,641e+05	3,258e+05	0,89		1,00	24,50	22,78	27,66	32,09	2
5	I	98	4	2,983e+05	-3,353e+05	-1,12		0,47	24,50	62,21	71,72	113,60	1
7	I	98	4	-3,596e+05	-3,213e+05								

Note: The Classification limits have been set according to Semi-Comp+. The cross-section is classified as Class 2

Flexural Buckling check

According to EN 1993-1-1 article 6.3.1.1 and formula (6.46)

Buckling parameters	yy	zz	
Sway type	sway	non-sway	
System length L	0,950	0,950	m
Buckling factor k	1,45	0,89	
Buckling length L_{cr}	1,374	0,848	m
Critical Euler load N_{cr}	3358,34	8812,27	kN
Slenderness λ	31,96	19,73	
Relative slenderness λ_{rel}	0,42	0,26	
Limit slenderness $\lambda_{rel,0}$	0,20	0,20	

Note: The slenderness or compression force is such that Flexural Buckling effects may be ignored according to EN 1993-1-1 article 6.3.1.2(4).

Torsional(-Flexural) Buckling check

According to EN 1993-1-1 article 6.3.1.1 and formula (6.46)

Note: The cross-section concerns a RHS section which is not susceptible to Torsional(-Flexural) Buckling.

Lateral Torsional Buckling check

According to EN 1993-1-1 article 6.3.2.1

Note: The cross-section concerns an RHS section with $h/b < 10 / \lambda_{rel,z}$.

This section is thus not susceptible to Lateral Torsional Buckling.

Bending and axial compression check

According to EN 1993-1-1 article 6.3.3 and formula (6.61),(6.62)

Bending and axial compression check parameters		
Interaction method	alternative method 1	
Cross-section area A	1,6550e-03	m ²
Plastic section modulus $W_{pl,y}$	6,5210e-05	m ³
Plastic section modulus $W_{pl,z}$	6,5210e-05	m ³
Design compression force N_{Ed}	3,67	kN
Design bending moment (maximum) $M_{y,Ed}$	1,23	kNm

Bending and axial compression check parameters		
Design bending moment (maximum) $M_{z,Ed}$	19,78	kNm
Characteristic compression resistance N_{Rk}	587,52	kN
Characteristic moment resistance $M_{y,Rk}$	23,15	kNm
Characteristic moment resistance $M_{z,Rk}$	23,15	kNm
Reduction factor χ_y	1,00	
Reduction factor χ_z	1,00	
Reduction factor χ_{LT}	1,00	
Interaction factor k_{yy}	0,59	
Interaction factor k_{yz}	0,46	
Interaction factor k_{zy}	0,35	
Interaction factor k_{zz}	0,76	

Maximum moment $M_{y,Ed}$ is derived from beam B4166 position 0,000 m.

Maximum moment $M_{z,Ed}$ is derived from beam B4166 position 0,950 m.

Interaction method 1 parameters		
Critical Euler load $N_{cr,y}$	3358,34	kN
Critical Euler load $N_{cr,z}$	8812,27	kN
Elastic critical load $N_{cr,T}$	109610,26	kN
Plastic section modulus $W_{pl,y}$	6,5210e-05	m ³
Elastic section modulus $W_{el,y}$	5,5620e-05	m ³
Plastic section modulus $W_{pl,z}$	6,5210e-05	m ³
Elastic section modulus $W_{el,z}$	5,5620e-05	m ³
Second moment of area I_y	3,0594e-06	m ⁴
Second moment of area I_z	3,0594e-06	m ⁴
Torsional constant I_t	4,8647e-06	m ⁴
Method for equivalent moment factor $C_{my,0}$	Table A.2 Line 1 (Linear)	
Ratio of end moments ψ_y	-0,97	
Equivalent moment factor $C_{my,0}$	0,59	
Method for equivalent moment factor $C_{mz,0}$	Table A.2 Line 1 (Linear)	
Ratio of end moments ψ_z	-0,15	
Equivalent moment factor $C_{mz,0}$	0,76	
Factor μ_y	1,00	
Factor μ_z	1,00	
Factor ϵ_y	10,00	
Factor a_{LT}	0,00	
Critical moment for uniform bending $M_{cr,0}$	1687,38	kNm
Relative slenderness $\lambda_{rel,0}$	0,12	
Limit relative slenderness $\lambda_{rel,lim}$	0,32	
Equivalent moment factor C_{my}	0,59	
Equivalent moment factor C_{mz}	0,76	
Equivalent moment factor C_{mLT}	1,00	
Factor b_{LT}	0,00	
Factor c_{LT}	0,00	
Factor d_{LT}	0,00	
Factor e_{LT}	0,00	
Factor w_y	1,17	
Factor w_z	1,17	
Factor η_{pl}	0,01	
Maximum relative slenderness $\lambda_{rel,max}$	0,42	
Factor C_{yy}	1,00	
Factor C_{yz}	1,00	
Factor C_{zy}	1,00	
Factor C_{zz}	1,00	

Unity check (6.61) = 0,01 + 0,03 + 0,39 = 0,43 -

Unity check (6.62) = 0,01 + 0,02 + 0,65 = 0,67 -

The member satisfies the stability check.

4.1.7. REZNE SILE-GORNJA POJASNICA SEKUNDARNOG REŠETKASTOG NOSAČA

My

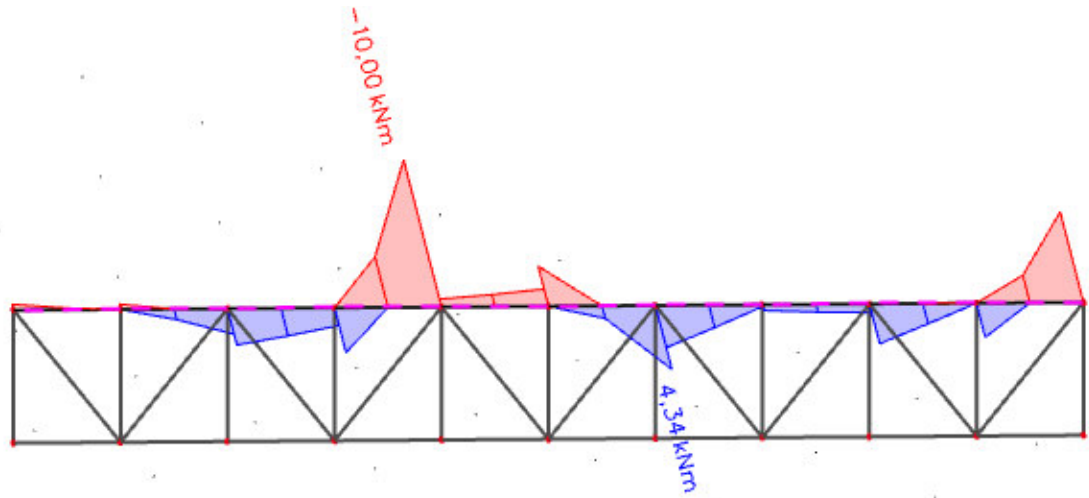

Vz

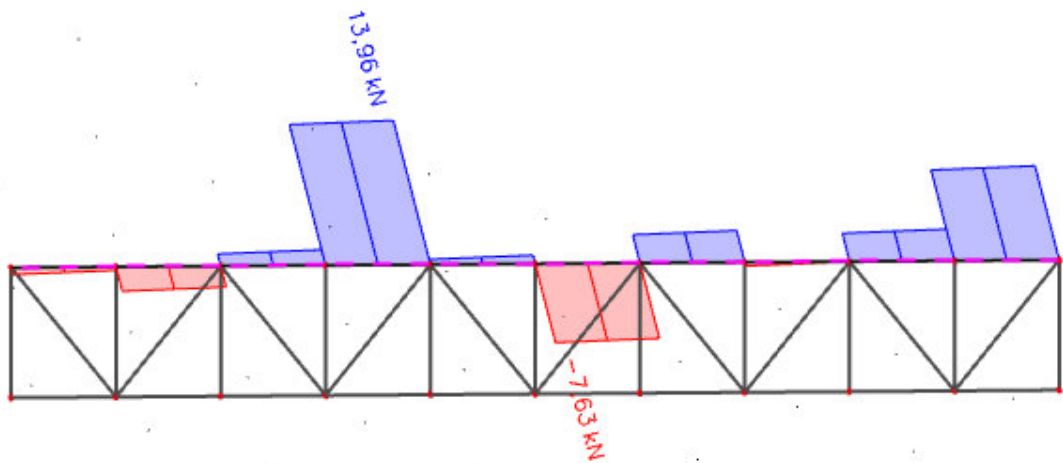

N

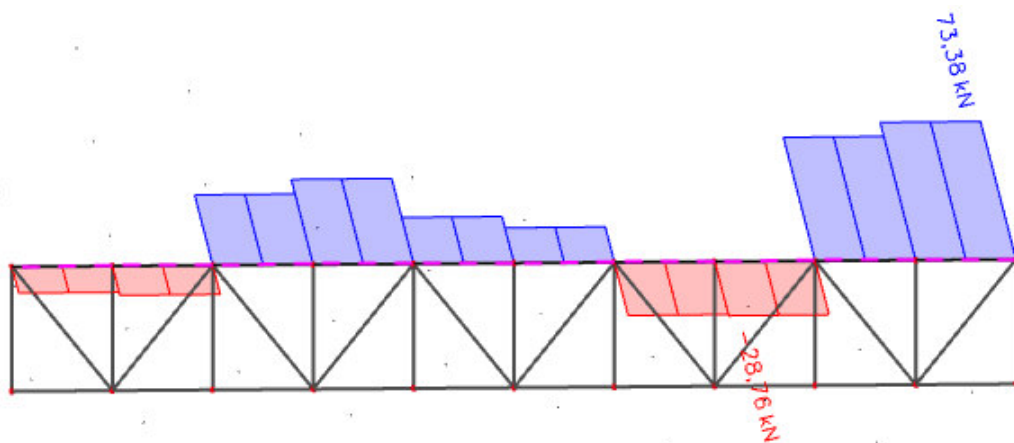

4.1.8. DIMENZIONIRANJE-GORNJA POJASNICA SEKUNDARNOG REŠETKASTOG NOSAČA

EC-EN 1993 Steel check ULS

Linear calculation
Combination: GSN6
Coordinate system: Principal
Extreme ID: Member
Selection: B4203

EN 1993-1-1 Code Check

National annex: Standard EN

Member B4203 7,566 / 9,457 m CFRHS160X160X6 S 355 GSN6 0,25 -

Note: EN 1993-1-3 article 1.1(3) specifies that this part does not apply to cold formed CHS and RHS sections. The default EN 1993-1-1 code check is executed instead of the EN 1993-1-3 code check.

Combination key
GSN6 / 1.35*vlastita težina + 1.50*pokretno + 1.35*dodatno stalno + 1.50*vjetar smjer x

Partial safety factors	
γ_{M0} for resistance of cross-sections	1,00
γ_{M1} for resistance to instability	1,00
γ_{M2} for resistance of net sections	1,25

Material		
Yield strength f_y	355,0	MPa
Ultimate strength f_u	490,0	MPa
Fabrication	Cold formed	

....SECTION CHECK:....

The critical check is on position 7,566 m

Internal forces	Calculated	Unit
N_{Ed}	-15,48	kN
$V_{y,Ed}$	-16,38	kN
$V_{z,Ed}$	-2,03	kN
T_{Ed}	-14,83	kNm
$M_{y,Ed}$	1,73	kNm
$M_{z,Ed}$	15,58	kNm

Classification for cross-section design

Classification according to EN 1993-1-1 article 5.5.2
Classification of Internal and Outstand parts according to EN 1993-1-1 Table 5.2 Sheet 1 & 2

Id	Type	c [mm]	t [mm]	σ_1 [kN/m ²]	σ_2 [kN/m ²]	ψ [-]	k_{σ} [-]	α [-]	c/t [-]	Class 1	Class 2	Class 3	Class
										Limit [-]	Limit [-]	Limit [-]	
1	I	142	6	-8,387e+04	7,356e+04	-1,14		0,47	23,67	62,69	72,26	115,28	1
3	I	142	6	8,095e+04	9,838e+04	0,82		1,00	23,67	22,78	27,66	32,94	2
5	I	142	6	9,246e+04	-6,496e+04	-0,70		0,59	23,67	45,96	53,95	75,56	1
7	I	142	6	-7,235e+04	-8,978e+04								

Note: The Classification limits have been set according to Semi-Comp+. The cross-section is classified as Class 2

Compression check

According to EN 1993-1-1 article 6.2.4 and formula (6.9)

A	3,6030e-03	m ²
$N_{c,Rd}$	1279,07	kN
Unity check	0,01	-

Bending moment check for M_y

According to EN 1993-1-1 article 6.2.5 and formula (6.12),(6.13)

$W_{pl,y}$	2,0624e-04	m ³
$M_{pl,y,Rd}$	73,22	kNm
Unity check	0,02	-

Bending moment check for M_z

According to EN 1993-1-1 article 6.2.5 and formula (6.12),(6.13)

$W_{pl,z}$	2,0624e-04	m ³
$M_{pl,z,Rd}$	73,22	kNm
Unity check	0,21	-

Shear check for V_y

According to EN 1993-1-1 article 6.2.6 and formula (6.17)

η	1,20	
A_v	1,8015e-03	m ²
$V_{pl,y,Rd}$	369,23	kN
Unity check	0,04	-

Shear check for V_z

According to EN 1993-1-1 article 6.2.6 and formula (6.17)

η	1,20	
A_v	1,8015e-03	m ²
$V_{pl,z,Rd}$	369,23	kN
Unity check	0,01	-

Torsion check

According to EN 1993-1-1 article 6.2.7 and formula (6.23)

Fibre	1	
T_{Ed}	52,1	MPa
T_{Rd}	205,0	MPa
Unity check	0,25	-

Combined Shear and Torsion check for V_y and $\tau_{L,Ed}$

According to EN 1993-1-1 article 6.2.6 & 6.2.7 and formula (6.25),(6.28)

$V_{pl,T,y,Rd}$	275,38	kN
Unity check	0,06	-

Combined Shear and Torsion check for V_z and $\tau_{L,Ed}$

According to EN 1993-1-1 article 6.2.6 & 6.2.7 and formula (6.25),(6.28)

$V_{pl,T,z,Rd}$	275,38	kN
Unity check	0,01	-

Combined bending, axial force and shear force check

According to EN 1993-1-1 article 6.2.9.1 and formula (6.41)

$M_{N,y,Rd}$	73,22	kNm
α	1,66	
$M_{N,z,Rd}$	73,22	kNm
β	1,66	

Unity check (6.41) = 0,00 + 0,08 = 0,08 -

Note: Since the shear forces are less than half the plastic shear resistances their effect on the moment resistances is neglected.

Decision tables for combined section check

Force presence	
Axial force N_{Ed}	Present
Shear force $V_{y,Ed}$	Not significant
Shear force $V_{z,Ed}$	Not significant
Torsional moment T_{Ed}	Present
Bending moment $M_{y,Ed}$	Present
Bending moment $M_{z,Ed}$	Present
Significant shear force without corresponding bending moment	No
Torsional moment without shear force	No
Warping data	Not present or negligible

Check inputs	
Classification is supported	Yes
Section classification	Class 2
Elastic verification is set by the user	No
Plastic shear formula is available	Yes
Combined shear and torsion formula is available	Yes
Combined shear and torsion check can be calculated	Yes
Combined bending and axial force formula is available	Yes
Combined bending and axial force check can be calculated	Yes

Selected check	
According to EN 1993-1-1 article 6.2.9.1 and formula (6.41)	

The member satisfies the section check.

....:STABILITY CHECK:....

Classification for member buckling design

Decisive position for stability classification: 3,783 m

Classification according to EN 1993-1-1 article 5.5.2

Classification of Internal and Outstand parts according to EN 1993-1-1 Table 5.2 Sheet 1 & 2

Id	Type	c [mm]	t [mm]	σ_1 [kN/m ²]	σ_2 [kN/m ²]	Ψ [-]	k_σ [-]	α [-]	c/t [-]	Class 1 Limit [-]	Class 2 Limit [-]	Class 3 Limit [-]	Class
1	I	142	6	-1,120e+05	5,397e+04	-2,07		0,33	23,67	90,05	103,81	223,39	1
3	I	142	6	6,284e+04	1,066e+05	0,59		1,00	23,67	22,78	27,66	36,06	2
5	I	142	6	1,015e+05	-6,446e+04	-0,64		0,61	23,67	43,37	51,10	71,47	1
7	I	142	6	-7,332e+04	-1,171e+05								

Note: The Classification limits have been set according to Semi-Comp+.
The cross-section is classified as Class 2

Flexural Buckling check

According to EN 1993-1-1 article 6.3.1.1 and formula (6.46)

Buckling parameters	yy	zz	
Sway type	sway	non-sway	
System length L	0,946	1,891	m
Buckling factor k	1,86	0,79	
Buckling length L_{cr}	1,760	1,489	m
Critical Euler load N_{cr}	9404,47	13139,21	kN
Slenderness λ	28,18	23,84	
Relative slenderness λ_{rel}	0,37	0,31	
Limit slenderness $\lambda_{rel,0}$	0,20	0,20	

Note: The slenderness or compression force is such that Flexural Buckling effects may be ignored according to EN 1993-1-1 article 6.3.1.2(4).

Torsional(-Flexural) Buckling check

According to EN 1993-1-1 article 6.3.1.1 and formula (6.46)

Note: The cross-section concerns a RHS section which is not susceptible to Torsional(-Flexural) Buckling.

Lateral Torsional Buckling check

According to EN 1993-1-1 article 6.3.2.1

Note: The cross-section concerns an RHS section with ' $h/b < 10 / \lambda_{rel,z}$ '.

This section is thus not susceptible to Lateral Torsional Buckling.

LTB additional parameters		
Minimal z coordinate z_{min}	-80	mm
Maximal z coordinate z_{max}	80	mm
Relative slenderness $\lambda_{rel,z}$	0,31	
End moment ratio ψ	-0,23	
Equivalent point load F	-1,69	kN
Equivalent line load q	-1,79	kN/m
Difference with M	1,52	kNm
Difference with F	0,22	kNm
Difference with q	0,48	kNm
Resulting load type	point load F	

Bending and axial compression check

According to EN 1993-1-1 article 6.3.3 and formula (6.61)/(6.62)

Bending and axial compression check parameters		
Interaction method	alternative method 1	
Cross-section area A	3,6030e-03	m ²
Plastic section modulus $W_{pl,y}$	2,0624e-04	m ³
Plastic section modulus $W_{pl,z}$	2,0624e-04	m ³
Design compression force N_{Ed}	15,48	kN
Design bending moment (maximum) $M_{y,Ed}$	1,73	kNm
Design bending moment (maximum) $M_{z,Ed}$	15,58	kNm
Characteristic compression resistance N_{Rk}	1279,07	kN
Characteristic moment resistance $M_{y,Rk}$	73,22	kNm
Characteristic moment resistance $M_{z,Rk}$	73,22	kNm
Reduction factor χ_y	1,00	
Reduction factor χ_z	1,00	
Reduction factor χ_{LT}	1,00	
Interaction factor k_{yy}	1,00	
Interaction factor k_{yz}	0,60	
Interaction factor k_{zy}	0,60	
Interaction factor k_{zz}	1,00	

Maximum moment $M_{y,Ed}$ is derived from beam B4203 position 7,566 m.

Maximum moment $M_{z,Ed}$ is derived from beam B4203 position 7,566 m.

Interaction method 1 parameters		
Critical Euler load $N_{cr,y}$	9404,47	kN
Critical Euler load $N_{cr,z}$	13139,21	kN
Elastic critical load $N_{cr,T}$	235680,89	kN
Plastic section modulus $W_{pl,y}$	2,0624e-04	m ³
Elastic section modulus $W_{el,y}$	1,7569e-04	m ³
Plastic section modulus $W_{pl,z}$	2,0624e-04	m ³
Elastic section modulus $W_{el,z}$	1,7569e-04	m ³
Second moment of area I_y	1,4055e-05	m ⁴
Second moment of area I_z	1,4055e-05	m ⁴
Torsional constant I_t	2,2389e-05	m ⁴
Method for equivalent moment factor $C_{m,y,0}$	Table A.2 Line 2 (General)	
Design bending moment (maximum) $M_{y,Ed}$	1,73	kNm
Maximum relative deflection δ_z	0,0	mm
Equivalent moment factor $C_{m,y,0}$	1,00	
Method for equivalent moment factor $C_{m,z,0}$	Table A.2 Line 2 (General)	
Design bending moment (maximum) $M_{z,Ed}$	15,58	kNm
Maximum relative deflection δ_y	-0,4	mm

Interaction method 1 parameters		
Equivalent moment factor $C_{m2,0}$	1,00	
Factor μ_1	1,00	
Factor μ_2	1,00	
Factor ϵ_y	2,26	
Factor α_{LT}	0,00	
Critical moment for uniform bending $M_{cr,0}$	3869,34	kNm
Relative slenderness $\lambda_{rel,0}$	0,14	
Limit relative slenderness $\lambda_{rel,0,lim}$	0,35	
Equivalent moment factor C_{my}	1,00	
Equivalent moment factor C_{mz}	1,00	
Equivalent moment factor C_{mLT}	1,00	
Factor b_{LT}	0,00	
Factor c_{LT}	0,00	
Factor d_{LT}	0,00	
Factor e_{LT}	0,00	
Factor w_y	1,17	
Factor w_z	1,17	
Factor n_{pl}	0,01	
Maximum relative slenderness $\lambda_{rel,max}$	0,37	
Factor C_{yy}	1,00	
Factor C_{yz}	1,00	
Factor C_{zy}	1,00	
Factor C_{zz}	1,00	

Unity check (6.61) = $0,01 + 0,02 + 0,13 = 0,16$ -

Unity check (6.62) = $0,01 + 0,01 + 0,21 = 0,24$ -

The member satisfies the stability check.

4.1.9. REZNE SILE-DONJA POJASNICA SEKUNDARNOG REŠETKASTOG NOSAČA

My

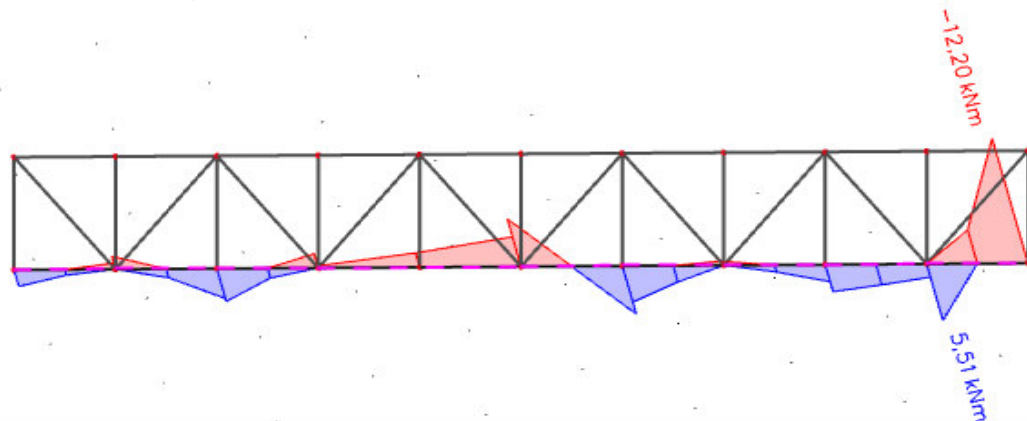

Vz

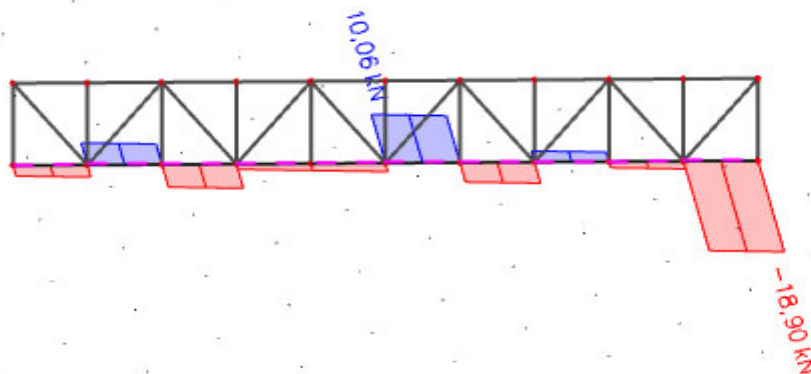

N

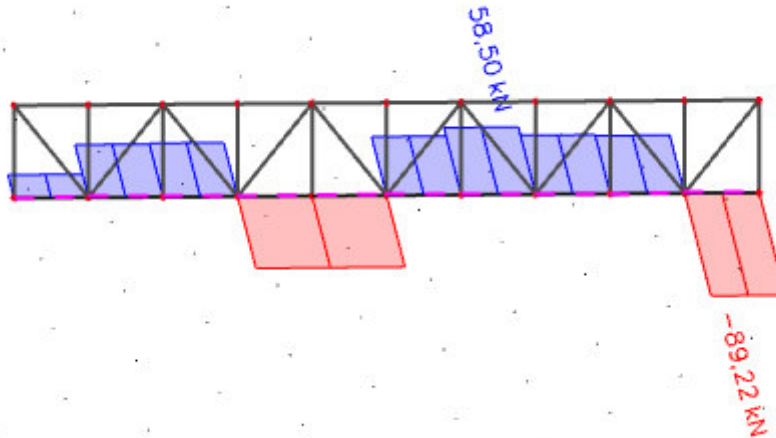

4.1.10. DIMENZIONIRANJE-DONJA POJASNICA SEKUNDARNOG REŠETKASTOG NOSAČA

EC-EN 1993 Steel check ULS

Linear calculation
Combination: GSN6
Coordinate system: Principal
Extreme ID: Member
Selection: B4202

EN 1993-1-1 Code Check
National annex: Standard EN

Member B4202 5,674 / 9,457 m **CFRHS160X160X6** **S 355** **GSN6** **0,31 -**

Note: EN 1993-1-3 article 1.1(3) specifies that this part does not apply to cold formed CHS and RHS sections. The default EN 1993-1-1 code check is executed instead of the EN 1993-1-3 code check.

Combination key
GSN6 / 1.35*vlastita težina + 1.50*pokretno + 1.35*dodatno stalno + 1.50*vjetar smjer x

Partial safety factors	
γ_{M0} for resistance of cross-sections	1,00
γ_{M1} for resistance to instability	1,00
γ_{M2} for resistance of net sections	1,25

Material	
Yield strength f_y	355,0 MPa
Ultimate strength f_u	490,0 MPa
Fabrication	Cold formed

....:SECTION CHECK:....

The critical check is on position 5,674 m

Internal forces	Calculated	Unit
N_{Ed}	58,39	kN
$V_{y,Ed}$	-36,82	kN
$V_{z,Ed}$	-4,03	kN
T_{Ed}	5,61	kNm
$M_{y,Ed}$	3,54	kNm
$M_{z,Ed}$	22,85	kNm

Classification for cross-section design

Classification according to EN 1993-1-1 article 5.5.2

Classification of Internal and Outstand parts according to EN 1993-1-1 Table 5.2 Sheet 1 & 2

Id	Type	c [mm]	t [mm]	σ_1 [kN/m ²]	σ_2 [kN/m ²]	ψ [-]	k_{σ} [-]	α [-]	c/t [-]	Class 1 Limit [-]	Class 2 Limit [-]	Class 3 Limit [-]	Class
1	I	142	6	-1,511e+05	7,988e+04	-1,89		0,35	23,67	84,68	97,62	200,56	1
3	I	142	6	9,115e+04	1,269e+05	0,72		1,00	23,67	22,78	27,66	34,27	2
5	I	142	6	1,187e+05	-1,123e+05	-0,95		0,51	23,67	56,15	64,95	95,25	1
7	I	142	6	-1,236e+05	-1,593e+05								

Note: The Classification limits have been set according to Semi-Comp+.

The cross-section is classified as Class 2

Tension check

According to EN 1993-1-1 article 6.2.3 and formula (6.5)

A	3,6030e-03	m ²
$N_{p1,Rd}$	1279,07	kN
$N_{u,Rd}$	1271,14	kN
$N_{t,Rd}$	1271,14	kN
Unity check	0,05	-

Bending moment check for M_y

According to EN 1993-1-1 article 6.2.5 and formula (6.12),(6.13)

$W_{pl,y}$	2,0624e-04	m ³
$M_{pl,y,Rd}$	73,22	kNm
Unity check	0,05	-

Bending moment check for M_z

According to EN 1993-1-1 article 6.2.5 and formula (6.12),(6.13)

$W_{pl,z}$	2,0624e-04	m ³
$M_{pl,z,Rd}$	73,22	kNm
Unity check	0,31	-

Shear check for V_y

According to EN 1993-1-1 article 6.2.6 and formula (6.17)

η	1,20	
A_v	1,8015e-03	m ²
$V_{pl,y,Rd}$	369,23	kN
Unity check	0,10	-

Shear check for V_z

According to EN 1993-1-1 article 6.2.6 and formula (6.17)

η	1,20	
A_v	1,8015e-03	m ²
$V_{pl,z,Rd}$	369,23	kN
Unity check	0,01	-

Torsion check

According to EN 1993-1-1 article 6.2.7 and formula (6.23)

Fibre	1	
T_{Ed}	19,7	MPa
T_{Rd}	205,0	MPa
Unity check	0,10	-

Combined Shear and Torsion check for V_y and $T_{y,Ed}$

According to EN 1993-1-1 article 6.2.6 & 6.2.7 and formula (6.25),(6.28)

$V_{pl,T,y,Rd}$	333,73	kN
Unity check	0,11	-

Combined Shear and Torsion check for V_z and $T_{z,Ed}$

According to EN 1993-1-1 article 6.2.6 & 6.2.7 and formula (6.25),(6.28)

$V_{pl,T,z,Rd}$	333,73	kN
Unity check	0,01	-

Combined bending, axial force and shear force check

According to EN 1993-1-1 article 6.2.9.1 and formula (6.41)

$M_{N,y,Rd}$	73,22	kNm
α	1,66	
$M_{N,z,Rd}$	73,22	kNm
β	1,66	

Unity check (6.41) = 0,01 + 0,14 = 0,15 -

Note: Since the shear forces are less than half the plastic shear resistances their effect on the moment resistances is neglected.

Decision tables for combined section check

Force presence	
Axial force N_{Ed}	Present
Shear force $V_{y,Ed}$	Not significant
Shear force $V_{z,Ed}$	Not significant
Torsional moment T_{Ed}	Present
Bending moment $M_{y,Ed}$	Present
Bending moment $M_{z,Ed}$	Present
Significant shear force without corresponding bending moment	No
Torsional moment without shear force	No
Warping data	Not present or negligible

Check inputs	
Classification is supported	Yes
Section classification	Class 2
Elastic verification is set by the user	No
Plastic shear formula is available	Yes
Combined shear and torsion formula is available	Yes
Combined shear and torsion check can be calculated	Yes
Combined bending and axial force formula is available	Yes
Combined bending and axial force check can be calculated	Yes

Selected check	
According to EN 1993-1-1 article 6.2.9.1 and formula (6.41)	

The member satisfies the section check.

....:STABILITY CHECK:....

Classification for member buckling design

Decisive position for stability classification: 5,674 m

Classification according to EN 1993-1-1 article 5.5.2

Classification of Internal and Outstand parts according to EN 1993-1-1 Table 5.2 Sheet 1 & 2

Id	Type	c [mm]	t [mm]	σ_1 [kN/m ²]	σ_2 [kN/m ²]	ψ [-]	k_σ [-]	α [-]	c/t [-]	Class 1 Limit [-]	Class 2 Limit [-]	Class 3 Limit [-]	Class
1	I	142	6	-1,511e+05	7,988e+04	-1,89		0,35	23,67	84,68	97,62	200,56	1
3	I	142	6	9,115e+04	1,269e+05	0,72		1,00	23,67	22,78	27,66	34,27	2
5	I	142	6	1,187e+05	-1,123e+05	-0,95		0,51	23,67	56,15	64,95	95,25	1
7	I	142	6	-1,236e+05	-1,593e+05								

Note: The Classification limits have been set according to Semi-Comp+.
 The cross-section is classified as Class 2

Lateral Torsional Buckling check

According to EN 1993-1-1 article 6.3.2.1

Note: The cross-section concerns an RHS section with $h / b < 10 / \lambda_{rel,z}$.
 This section is thus not susceptible to Lateral Torsional Buckling.

LTB additional parameters		
Minimal z coordinate z_{min}	-80	mm
Maximal z coordinate z_{max}	80	mm
Relative slenderness $\lambda_{rel,z}$	0,20	
End moment ratio ψ	0,47	
Equivalent point load F	-6,35	kN
Equivalent line load q	-6,71	kN/m
Difference with M	5,92	kNm
Difference with F	0,08	kNm
Difference with q	1,58	kNm
Resulting load type	point load F	

The member satisfies the stability check.

4.1.11. REZNE SILE –ISPUNA SEKUNDARNOG REŠETKASTOG NOSAČA

N

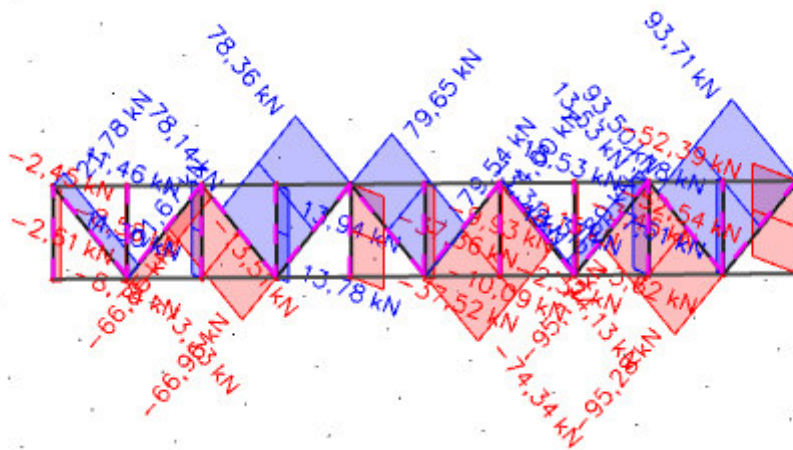

4.1.12. DIMENZIONIRANJE –ISPUNA SEKUNDARNOG REŠETKASTOG NOSAČA

EC-EN 1993 Steel check ULS

Linear calculation
Combination: GSN6
Coordinate system: Principal
Extreme ID: Member
Selection: 84186

EN 1993-1-1 Code Check

National annex: Standard EN

Member B4186 **1,108 / 1,108 m** **CFRHS110X110X4** **S 355** **GSN6** **0,72 -**

Note: EN 1993-1-3 article 1.1(3) specifies that this part does not apply to cold formed CHS and RHS sections. The default EN 1993-1-1 code check is executed instead of the EN 1993-1-3 code check.

Combination key
GSN6 / 1.35*vlastita težina + 1.50*pokretno + 1.35*dodatno stalno + 1.50*vjetar smjer x

Partial safety factors	
γ_{M0} for resistance of cross-sections	1,00
γ_{M1} for resistance to instability	1,00
γ_{M2} for resistance of net sections	1,25

Material		
Yield strength f_y	355,0	MPa
Ultimate strength f_u	490,0	MPa
Fabrication	Cold formed	

....SECTION CHECK:....

The critical check is on position 1,108 m

Internal forces	Calculated	Unit
N_{Ed}	-66,85	kN
$V_{y,Ed}$	19,86	kN
$V_{z,Ed}$	0,01	kN
T_{Ed}	3,28	kNm
$M_{y,Ed}$	0,22	kNm
$M_{z,Ed}$	16,72	kNm

Classification for cross-section design

Classification according to EN 1993-1-1 article 5.5.2

Classification of Internal and Outstand parts according to EN 1993-1-1 Table 5.2 Sheet 1 & 2

Id	Type	c [mm]	t [mm]	σ_1 [kN/m ²]	σ_2 [kN/m ²]	ψ [-]	k_{σ} [-]	α [-]	c/t [-]	Class 1 Limit [-]	Class 2 Limit [-]	Class 3 Limit [-]	Class
1	I	98	4	-2,312e+05	3,044e+05	-0,76	0,57	24,50	48,22	56,41	79,38	1	
3	I	98	4	3,265e+05	3,336e+05	0,98	1,00	24,50	22,78	27,66	31,14	2	
5	I	98	4	3,120e+05	-2,236e+05	-0,72	0,58	24,50	46,52	54,55	76,47	1	
7	I	98	4	-2,457e+05	-2,527e+05								

Note: The Classification limits have been set according to Semi-Comp+. The cross-section is classified as Class 2

Compression check

According to EN 1993-1-1 article 6.2.4 and formula (6.9)

A	1,6550e-03	m ²
$N_{c,Rd}$	587,52	kN
Unity check	0,11	-

Bending moment check for M_y

According to EN 1993-1-1 article 6.2.5 and formula (6.12),(6.13)

W_{ply}	6,5210e-05	m ³
$M_{ply,Rd}$	23,15	kNm
Unity check	0,01	-

Bending moment check for M_z

According to EN 1993-1-1 article 6.2.5 and formula (6.12),(6.13)

$W_{pl,z}$	6,5210e-05	m ³
$M_{pl,z,Rd}$	23,15	kNm
Unity check	0,72	-

Shear check for V_y

According to EN 1993-1-1 article 6.2.6 and formula (6.17)

η	1,20	
A_v	8,2750e-04	m ²
$V_{ply,Rd}$	169,60	kN
Unity check	0,12	-

Shear check for V_z

According to EN 1993-1-1 article 6.2.6 and formula (6.17)

η	1,20	
A_v	8,2750e-04	m ²
$V_{pl,z,Rd}$	169,60	kN
Unity check	0,00	-

Torsion check

According to EN 1993-1-1 article 6.2.7 and formula (6.23)

Fibre	1	
T_{Ed}	36,4	MPa
T_{Rd}	205,0	MPa
Unity check	0,18	-

Combined Shear and Torsion check for V_y and $\tau_{L,Ed}$

According to EN 1993-1-1 article 6.2.6 & 6.2.7 and formula (6.25),(6.28)

$V_{pl,T,y,Rd}$	139,45	kN
Unity check	0,14	-

Combined Shear and Torsion check for V_z and $\tau_{L,Ed}$

According to EN 1993-1-1 article 6.2.6 & 6.2.7 and formula (6.25),(6.28)

$V_{pl,T,z,Rd}$	139,45	kN
Unity check	0,00	-

Combined bending, axial force and shear force check

According to EN 1993-1-1 article 6.2.9.1 and formula (6.41)

$M_{N,y,Rd}$	23,15	kNm
α	1,68	
$M_{N,z,Rd}$	23,15	kNm
β	1,68	

Unity check (6.41) = 0,00 + 0,58 = 0,58 -

Note: Since the shear forces are less than half the plastic shear resistances their effect on the moment resistances is neglected.

Decision tables for combined section check

Force presence	
Axial force N_{Ed}	Present
Shear force $V_{y,Ed}$	Not significant
Shear force $V_{z,Ed}$	Not significant
Torsional moment T_{Ed}	Present
Bending moment $M_{y,Ed}$	Present
Bending moment $M_{z,Ed}$	Present
Significant shear force without corresponding bending moment	No
Torsional moment without shear force	No
Warping data	Not present or negligible

Check inputs	
Classification is supported	Yes
Section classification	Class 2
Elastic verification is set by the user	No
Plastic shear formula is available	Yes
Combined shear and torsion formula is available	Yes
Combined shear and torsion check can be calculated	Yes
Combined bending and axial force formula is available	Yes
Combined bending and axial force check can be calculated	Yes

Selected check
According to EN 1993-1-1 article 6.2.9.1 and formula (6.41)

The member satisfies the section check.

...:STABILITY CHECK:...

Classification for member buckling design

Decisive position for stability classification: 1,108 m

Classification according to EN 1993-1-1 article 5.5.2

Classification of Internal and Outstand parts according to EN 1993-1-1 Table 5.2 Sheet 1 & 2

Id	Type	c [mm]	t [mm]	σ_1 [kN/m ²]	σ_2 [kN/m ²]	ψ [-]	k_{σ} [-]	α [-]	c/t [-]	Class 1 Limit [-]	Class 2 Limit [-]	Class 3 Limit [-]	Class
1	I	98	4	-2,312e+05	3,044e+05	-0,76	0,57	24,50	48,22	56,41	79,38	1	
3	I	98	4	3,265e+05	3,336e+05	0,98	1,00	24,50	22,78	27,66	31,14	2	
5	I	98	4	3,120e+05	-2,236e+05	-0,72	0,58	24,50	46,52	54,55	76,47	1	
7	I	98	4	-2,457e+05	-2,527e+05								

Note: The Classification limits have been set according to Semi-Comp+.
The cross-section is classified as Class 2

Flexural Buckling check

According to EN 1993-1-1 article 6.3.1.1 and formula (6.46)

Buckling parameters	yy	zz	
Sway type	sway	non-sway	
System length L	1,108	1,108	m
Buckling factor k	1,50	0,76	
Buckling length L_{cr}	1,660	0,843	m
Critical Euler load N_{cr}	2301,25	8925,72	kN
Slenderness λ	38,61	19,60	
Relative slenderness λ_{rel}	0,51	0,26	
Limit slenderness $\lambda_{rel,0}$	0,20	0,20	

Note: The slenderness or compression force is such that Flexural Buckling effects may be ignored according to EN 1993-1-1 article 6.3.1.2(4).

Torsional(-Flexural) Buckling check

According to EN 1993-1-1 article 6.3.1.1 and formula (6.46)

Note: The cross-section concerns a RHS section which is not susceptible to Torsional(-Flexural) Buckling.

Lateral Torsional Buckling check

According to EN 1993-1-1 article 6.3.2.1

Note: The cross-section concerns an RHS section with ' $h/b < 10 / \lambda_{rel,z}$ '.
This section is thus not susceptible to Lateral Torsional Buckling.

LTB additional parameters		
Minimal z coordinate z_{min}	-55	mm
Maximal z coordinate z_{max}	55	mm
Relative slenderness $\lambda_{rel,z}$	0,26	
End moment ratio ψ	0,58	
Equivalent point load F	0,08	kN
Equivalent line load q	0,14	kN/m
Difference with M	0,02	kNm
Difference with F	0,00	kNm
Difference with q	0,00	kNm
Resulting load type	line load q	

Bending and axial compression check

According to EN 1993-1-1 article 6.3.3 and formula (6.61)/(6.62)

Bending and axial compression check parameters		
Interaction method	alternative method 1	
Cross-section area A	1,6550e-03	m ²
Plastic section modulus $W_{pl,y}$	6,5210e-05	m ³
Plastic section modulus $W_{pl,z}$	6,5210e-05	m ³
Design compression force N_{Ed}	66,85	kN
Design bending moment (maximum) $M_{y,Ed}$	0,22	kNm
Design bending moment (maximum) $M_{z,Ed}$	16,72	kNm
Characteristic compression resistance N_{Rk}	587,52	kN
Characteristic moment resistance $M_{y,Rk}$	23,15	kNm
Characteristic moment resistance $M_{z,Rk}$	23,15	kNm
Reduction factor χ_y	1,00	
Reduction factor χ_z	1,00	
Reduction factor χ_{LT}	1,00	
Interaction factor k_{FF}	1,01	
Interaction factor k_{Fz}	0,43	
Interaction factor k_{zy}	0,61	
Interaction factor k_{zz}	0,71	

Maximum moment $M_{y,Ed}$ is derived from beam B4186 position 1,108 m.

Maximum moment $M_{z,Ed}$ is derived from beam B4186 position 1,108 m.

Interaction method 1 parameters		
Critical Euler load $N_{cr,y}$	2301,25	kN
Critical Euler load $N_{cr,z}$	8925,72	kN
Elastic critical load $N_{cr,T}$	108728,60	kN
Plastic section modulus $W_{pl,y}$	6,5210e-05	m ³
Elastic section modulus $W_{el,y}$	5,5620e-05	m ³
Plastic section modulus $W_{pl,z}$	6,5210e-05	m ³
Elastic section modulus $W_{el,z}$	5,5620e-05	m ³
Second moment of area I_y	3,0594e-06	m ⁴
Second moment of area I_z	3,0594e-06	m ⁴
Torsional constant I_t	4,8647e-06	m ⁴
Method for equivalent moment factor $C_{m,0}$	Table A.2 Line 2 (General)	
Design bending moment (maximum) $M_{y,Ed}$	0,22	kNm
Maximum relative deflection δ_2	0,0	mm
Equivalent moment factor $C_{m,0}$	1,00	
Method for equivalent moment factor $C_{m,0}$	Table A.2 Line 1 (Linear)	
Ratio of end moments ψ_2	-0,32	
Equivalent moment factor $C_{m,0}$	0,72	

Interaction method 1 parameters		
Factor μ_x	1,00	
Factor μ_y	1,00	
Factor ϵ_y	0,10	
Factor a_{LT}	0,00	
Critical moment for uniform bending $M_{cr,0}$	1441,39	kNm
Relative slenderness $\lambda_{rel,0}$	0,13	
Limit relative slenderness $\lambda_{rel,0,lim}$	0,21	
Equivalent moment factor C_{my}	1,00	
Equivalent moment factor C_{mz}	0,72	
Equivalent moment factor $C_{m1,T}$	1,00	
Factor b_{LT}	0,00	
Factor c_{LT}	0,00	
Factor d_{LT}	0,00	
Factor e_{LT}	0,00	
Factor w_y	1,17	
Factor w_z	1,17	
Factor η_{pl}	0,11	
Maximum relative slenderness $\lambda_{rel,max}$	0,51	
Factor C_{yy}	1,02	
Factor C_{yz}	1,02	
Factor C_{zy}	1,01	
Factor C_{zz}	1,03	

Unity check (6.61) = $0,11 + 0,01 + 0,31 = 0,43$ -

Unity check (6.62) = $0,11 + 0,01 + 0,51 = 0,63$ -

The member satisfies the stability check.

4.2. DIMENZIONIRANJE IZLOŽBENOG PROSTORA-1.KAT

4.2.1. REZNE SILE –DONJI POJAS SEKUNDARNOG REŠETKASTOG NOSAČA

My

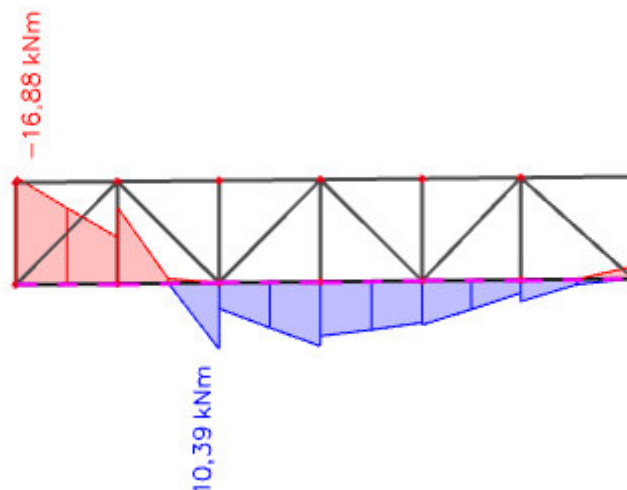

Vz

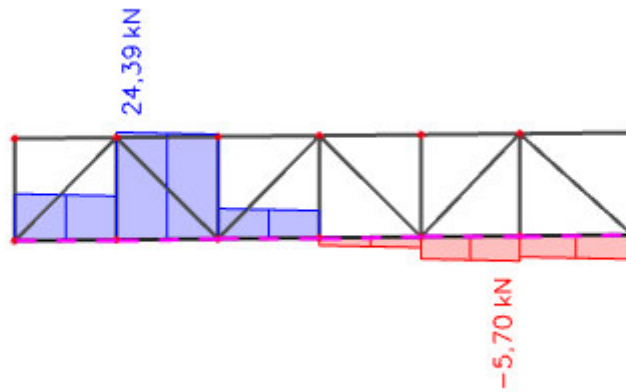

N

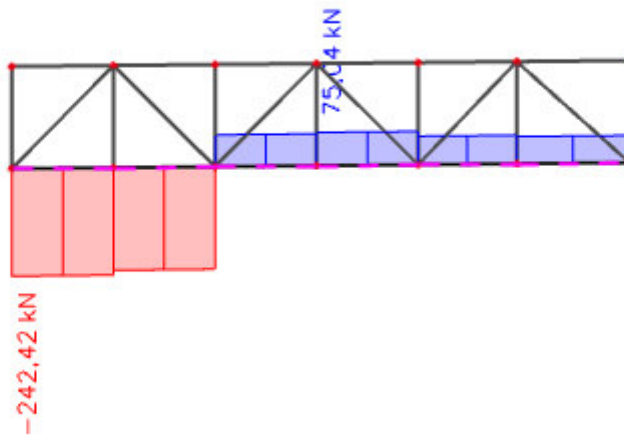

4.2.2. DIMENZIONIRANJE –DONJI POJAS SEKUNDARNOG REŠETKASTOG NOSAČA

EN 1993-1-1 Code Check

National annex: Standard EN

Member B199	0,932 / 5,670 m	CFRHS200X200X10	S 355	GSN6	0,28 -
-------------	-----------------	-----------------	-------	------	--------

Note: EN 1993-1-3 article 1.1(3) specifies that this part does not apply to cold formed CHS and RHS sections. The default EN 1993-1-1 code check is executed instead of the EN 1993-1-3 code check.

Combination key
GSN6 / 1.35*vlastita težina + 1.50*pokretno + 1.35*dodatno stalno + 1.50*vjetar smjer x

Partial safety factors	
γ_{M0} for resistance of cross-sections	1,00
γ_{M1} for resistance to instability	1,00
γ_{M2} for resistance of net sections	1,25
Material	
Yield strength f_y	355,0 MPa
Ultimate strength f_u	490,0 MPa
Fabrication	Cold formed

....SECTION CHECK:....

The critical check is on position 0,932 m

Internal forces	Calculated	Unit
N_{Ed}	-237,20	kN
$V_{y,Ed}$	1,54	kN
$V_{z,Ed}$	28,22	kN
T_{Ed}	-1,73	kNm
$M_{y,Ed}$	-15,25	kNm
$M_{z,Ed}$	4,14	kNm

Classification for cross-section design

Classification according to EN 1993-1-1 article 5.5.2

Classification of Internal and Outstand parts according to EN 1993-1-1 Table 5.2 Sheet 1 & 2

Id	Type	c [mm]	t [mm]	σ_1 [kN/m ²]	σ_2 [kN/m ²]	Ψ [-]	k_σ [-]	α [-]	c/t [-]	Class 1 Limit [-]	Class 2 Limit [-]	Class 3 Limit [-]	Class [-]
1	I	170	10	5,850e+04	7,506e+04	0,78		1,00	17,00	22,78	27,66	33,48	1
3	I	170	10	7,245e+04	1,145e+04	0,16		1,00	17,00	22,78	27,66	43,68	1
5	I	170	10	6,893e+03	-9,673e+03	-1,40		0,42	17,00	70,40	81,15	143,63	1
7	I	170	10	-7,060e+03	5,393e+04	-0,13		0,88	17,00	26,54	32,04	50,89	1

Note: The Classification limits have been set according to Semi-Comp+.

The cross-section is classified as Class 1

.....SECTION CHECK:.....

Compression check

According to EN 1993-1-1 article 6.2.4 and formula (6.9)

A	7,2570e-03	m ²
$N_{z,Rd}$	2576,24	kN
Unity check	0,09	-

Bending moment check for M_y

According to EN 1993-1-1 article 6.2.5 and formula (6.12),(6.13)

W_{ply}	5,0808e-04	m ³
$M_{ply,Rd}$	180,37	kNm
Unity check	0,08	-

Bending moment check for M_z

According to EN 1993-1-1 article 6.2.5 and formula (6.12),(6.13)

W_{plz}	5,0808e-04	m ³
$M_{plz,Rd}$	180,37	kNm
Unity check	0,02	-

Shear check for V_y

According to EN 1993-1-1 article 6.2.6 and formula (6.17)

η	1,20	
A_v	3,6285e-03	m ²
$V_{ply,Rd}$	743,69	kN
Unity check	0,00	-

Shear check for V_z

According to EN 1993-1-1 article 6.2.6 and formula (6.17)

η	1,20	
A_v	3,6285e-03	m ²
$V_{plz,Rd}$	743,69	kN
Unity check	0,04	-

Torsion check

According to EN 1993-1-1 article 6.2.7 and formula (6.23)

Fibre	1	
T_{Ed}	2,4	MPa
T_{Rd}	205,0	MPa
Unity check	0,01	-

Note: The unity check for torsion is lower than the limit value of 0,05. Therefore torsion is considered as insignificant and is ignored in the combined checks.

Combined bending, axial force and shear force check

According to EN 1993-1-1 article 6.2.9.1 and formula (6.41)

$M_{N,y,Rd}$	180,37	kNm
α	1,68	
$M_{N,z,Rd}$	180,37	kNm
β	1,68	

Unity check $(5.41) = 0,02 + 0,00 = 0,02$

Note: Since the shear forces are less than half the plastic shear resistances their effect on the moment resistances is neglected.

The member satisfies the section check.

....:STABILITY CHECK:....

Classification for member buckling design

Decisive position for stability classification: 0,932 m

Classification according to EN 1993-1-1 article 5.5.2

Classification of Internal and Outstand parts according to EN 1993-1-1 Table 5.2 Sheet 1 & 2

Id	Type	c [mm]	t [mm]	σ_1 [kN/m ²]	σ_2 [kN/m ²]	ψ [-]	k_σ [-]	α [-]	c/t [-]	Class 1 Limit [-]	Class 2 Limit [-]	Class 3 Limit [-]	Class
1	I	170	10	5,850e+04	7,506e+04	0,78		1,00	17,00	22,78	27,66	33,48	1
3	I	170	10	7,245e+04	1,145e+04	0,16		1,00	17,00	22,78	27,66	43,68	1
5	I	170	10	6,893e+03	-9,673e+03	-1,40		0,42	17,00	70,40	81,15	143,63	1
7	I	170	10	-7,060e+03	5,393e+04	-0,13		0,88	17,00	26,54	32,04	50,89	1

Note: The Classification limits have been set according to Semi-Comp+.

The cross-section is classified as Class 1

Flexural Buckling check

According to EN 1993-1-1 article 6.3.1.1 and formula (6.46)

Buckling parameters	yy	zz	
Sway type	sway	non-sway	
System length L	0,933	5,670	m
Buckling factor k	6,48	0,86	
Buckling length L_{cr}	6,044	4,848	m
Critical Euler load N_{cr}	2411,63	3748,46	kN
Slenderness λ	78,97	63,34	
Relative slenderness λ_{rel}	1,03	0,83	
Limit slenderness $\lambda_{rel,0}$	0,20	0,20	
Buckling curve	c	c	
Imperfection α	0,49	0,49	
Reduction factor χ	0,52	0,64	
Buckling resistance $N_{b,Rd}$	1341,48	1658,95	kN

Flexural Buckling verification		
Cross-section area A	7,2570e-03	m ²
Buckling resistance $N_{b,Rd}$	1341,48	kN
Unity check	0,18	-

Torsional(-Flexural) Buckling check

According to EN 1993-1-1 article 6.3.1.1 and formula (6.46)

Note: The cross-section concerns a RHS section which is not susceptible to Torsional(-Flexural) Buckling.

Lateral Torsional Buckling check

According to EN 1993-1-1 article 6.3.2.1

Note: The cross-section concerns an RHS section with $h/b < 10 / \lambda_{rel,z}$.

This section is thus not susceptible to Lateral Torsional Buckling.

Bending and axial compression check

According to EN 1993-1-1 article 6.3.3 and formula (6.61),(6.62)

Bending and axial compression check parameters		
Interaction method	alternative method 1	
Cross-section area A	7,2570e-03	m ²
Plastic section modulus $W_{pl,y}$	5,0808e-04	m ³
Plastic section modulus $W_{pl,z}$	5,0808e-04	m ³
Design compression force N_{Ed}	237,20	kN
Design bending moment (maximum) $M_{y,Ed}$	-15,25	kNm
Design bending moment (maximum) $M_{z,Ed}$	12,55	kNm
Characteristic compression resistance N_{Rk}	2576,24	kN
Characteristic moment resistance $M_{y,Rk}$	180,37	kNm
Characteristic moment resistance $M_{z,Rk}$	180,37	kNm
Reduction factor χ_y	0,52	
Reduction factor χ_z	0,64	
Reduction factor χ_{LT}	1,00	
Interaction factor k_{yy}	0,63	
Interaction factor k_{yz}	0,71	
Interaction factor k_{zy}	0,40	
Interaction factor k_{zz}	1,13	

Maximum moment $M_{y,Ed}$ is derived from beam B199 position 0,932 m.
Maximum moment $M_{z,Ed}$ is derived from beam B199 position 3,730 m.

Interaction method 1 parameters		
Critical Euler load $N_{cr,y}$	2411,63	kN
Critical Euler load $N_{cr,z}$	3748,46	kN
Elastic critical load $N_{cr,T}$	488997,41	kN
Plastic section modulus $W_{pl,y}$	5,0808e-04	m ³
Elastic section modulus $W_{el,y}$	4,2511e-04	m ³
Plastic section modulus $W_{pl,z}$	5,0808e-04	m ³
Elastic section modulus $W_{el,z}$	4,2511e-04	m ³
Second moment of area I_y	4,2511e-05	m ⁴
Second moment of area I_z	4,2511e-05	m ⁴
Torsional constant I_t	7,0717e-05	m ⁴
Method for equivalent moment factor $C_{my,0}$	Table A.2 Line 1 (Linear)	
Ratio of end moments ψ_1	-0,70	
Equivalent moment factor $C_{my,0}$	0,61	
Method for equivalent moment factor $C_{mz,0}$	Table A.2 Line 2 (General)	
Design bending moment (maximum) $M_{z,Ed}$	12,55	kNm
Maximum relative deflection δ_y	9,2	mm
Equivalent moment factor $C_{mz,0}$	1,06	
Factor μ_1	0,95	
Factor μ_2	0,98	
Factor ϵ_y	1,10	
Factor $a_{1,T}$	0,00	
Critical moment for uniform bending $M_{cr,0}$	3962,20	kNm
Relative slenderness $\lambda_{rel,0}$	0,21	
Limit relative slenderness $\lambda_{rel,0,lim}$	0,28	
Equivalent moment factor C_{my}	0,61	
Equivalent moment factor C_{mz}	1,06	
Equivalent moment factor $C_{m1,T}$	1,00	
Factor $b_{1,T}$	0,00	
Factor $c_{1,T}$	0,00	
Factor $d_{1,T}$	0,00	
Factor $e_{1,T}$	0,00	
Factor w_y	1,20	
Factor w_z	1,20	
Factor η_{pl}	0,09	
Maximum relative slenderness $\lambda_{rel,max}$	1,03	
Factor $C_{\alpha y}$	1,02	
Factor $C_{\alpha z}$	0,91	
Factor $C_{\alpha y}$	1,00	
Factor $C_{\alpha z}$	0,98	

Unity check (6.61) = 0,18 + 0,05 + 0,05 = 0,28 -

Unity check (6.62) = 0,14 + 0,03 + 0,08 = 0,26 -

The member satisfies the stability check.

4.2.3. REZNE SILE – GORNJA POJASNICA SEKUNDARNOG REŠETKASTOG NOSAČA

My



Vz

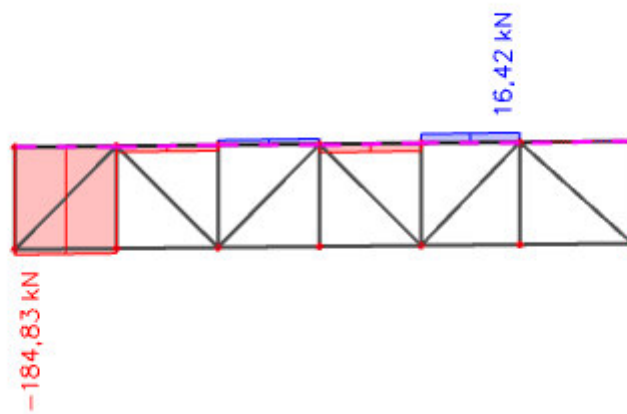

N

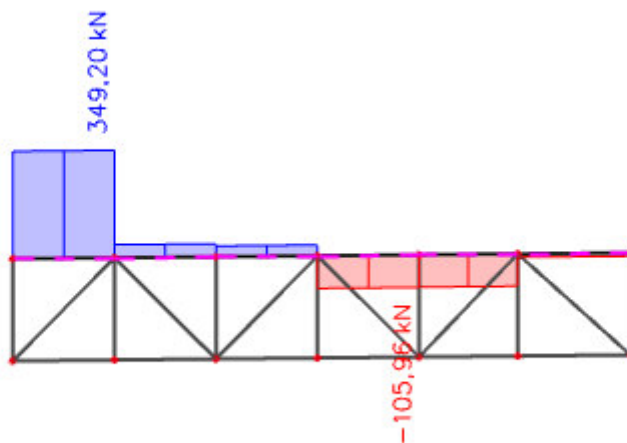

4.2.4. DIMENZIONIRANJE – GORNJA POJASNICA SEKUNDARNOG REŠETKASTOG NOSAČA

EC-EN 1993 Steel check ULS

Linear calculation
Combination: GSN6
Coordinate system: Principal
Extreme ID: Member
Selection: 8198

EN 1993-1-1 Code Check

National annex: Standard EN

Member B198 | **5,670 / 5,670 m** | **CFRHS200X200X10** | **S 355** | **GSN6** | **0,86 -**

Note: EN 1993-1-3 article 1.1(3) specifies that this part does not apply to cold formed CHS and RHS sections. The default EN 1993-1-1 code check is executed instead of the EN 1993-1-3 code check.

Combination key
GSN6 / 1.35*vlastita težina + 1.50*pokretno + 1.35*dodatno stalno + 1.50*vjetar smjer x

Partial safety factors	
γ_{M0} for resistance of cross-sections	1,00
γ_{M1} for resistance to instability	1,00
γ_{M2} for resistance of net sections	1,25

Material		
Yield strength f_y	355,0	MPa
Ultimate strength f_u	490,0	MPa
Fabrication	Cold formed	

....SECTION CHECK:....

The critical check is on position 5,670 m

Internal forces	Calculated	Unit
N_{Ed}	349,32	kN
$V_{y,Ed}$	-2,28	kN
$V_{z,Ed}$	-184,85	kN
T_{Ed}	-6,54	kNm
$M_{y,Ed}$	-156,01	kNm
$M_{z,Ed}$	-2,40	kNm

Classification for cross-section design

Classification according to EN 1993-1-1 article 5.5.2
Classification of Internal and Outstand parts according to EN 1993-1-1 Table 5.2 Sheet 1 & 2

Id	Type	c [mm]	t [mm]	σ_1 [kN/m ²]	σ_2 [kN/m ²]	ψ [-]	k_{σ} [-]	α [-]	c/t [-]	Class 1 Limit [-]	Class 2 Limit [-]	Class 3 Limit [-]	Class
1	I	170	10	3,054e+05	2,958e+05	0,97		1,00	17,00	22,78	27,66	31,26	1
3	I	170	10	2,585e+05	-3,656e+05	-1,41		0,41	17,00	70,71	81,51	144,81	1
5	I	170	10	-4,017e+05	-3,921e+05								
7	I	170	10	-3,548e+05	2,693e+05	-1,32		0,43	17,00	67,89	78,26	134,21	1

Note: The Classification limits have been set according to Semi-Comp+. The cross-section is classified as Class 1

Tension check

According to EN 1993-1-1 article 6.2.3 and formula (6.5)

A	7,2570e-03	m ²
$N_{pl,Rd}$	2576,24	kN
$N_{u,Rd}$	2560,27	kN
$N_{t,Rd}$	2560,27	kN
Unity check	0,14	-

Bending moment check for M_y

According to EN 1993-1-1 article 6.2.5 and formula (6.12),(6.13)

W_{ply}	5,0808e-04	m ³
$M_{ply,Rd}$	180,37	kNm
Unity check	0,86	-

Bending moment check for M_z

According to EN 1993-1-1 article 6.2.5 and formula (6.12),(6.13)

$W_{pl,z}$	5,0808e-04	m ³
$M_{pl,z,Rd}$	180,37	kNm
Unity check	0,01	-

Shear check for V_y

According to EN 1993-1-1 article 6.2.6 and formula (6.17)

η	1,20	
A_v	3,6285e-03	m ²
$V_{ply,Rd}$	743,69	kN
Unity check	0,00	-

Shear check for V_z

According to EN 1993-1-1 article 6.2.6 and formula (6.17)

η	1,20	
A_v	3,6285e-03	m ²
$V_{pl,z,Rd}$	743,69	kN
Unity check	0,25	-

Torsion check

According to EN 1993-1-1 article 6.2.7 and formula (6.23)

Fibre	1	
T_{Ed}	9,1	MPa
T_{Rd}	205,0	MPa
Unity check	0,04	-

Note: The unity check for torsion is lower than the limit value of 0,05. Therefore torsion is considered as insignificant and is ignored in the combined checks.

Combined bending, axial force and shear force check

According to EN 1993-1-1 article 6.2.9.1 and formula (6.41)

$M_{N,y,Rd}$	180,37	kNm
α	1,70	
$M_{N,z,Rd}$	180,37	kNm
β	1,70	

Unity check (6.41) = 0,78 + 0,00 = 0,78

Note: Since the shear forces are less than half the plastic shear resistances their effect on the moment resistances is neglected.

Decision tables for combined section check

Force presence	
Axial force N_{Ed}	Present
Shear force $V_{y,Ed}$	Not significant
Shear force $V_{z,Ed}$	Not significant
Torsional moment T_{Ed}	Not significant
Bending moment $M_{y,Ed}$	Present
Bending moment $M_{z,Ed}$	Present
Significant shear force without corresponding bending moment	No
Warping data	Not present or negligible

Check inputs	
Classification is supported	Yes
Section classification	Class 1
Elastic verification is set by the user	No
Plastic shear formula is available	Yes
Combined bending and axial force formula is available	Yes
Combined bending and axial force check can be calculated	Yes

Selected check

According to EN 1993-1-1 article 6.2.9.1 and formula (6.41)

The member satisfies the section check.

....:STABILITY CHECK:....

Classification for member buckling design

Decisive position for stability classification: 5,670 m

Classification according to EN 1993-1-1 article 5.5.2

Classification of Internal and Outstand parts according to EN 1993-1-1 Table 5.2 Sheet 1 & 2

Id	Type	c [mm]	t [mm]	σ_1 [kN/m ²]	σ_2 [kN/m ²]	ψ [-]	k_{σ} [-]	α [-]	c/t [-]	Class 1	Class 2	Class 3	Class
										Limit [-]	Limit [-]	Limit [-]	
1	I	170	10	3,054e+05	2,958e+05	0,97		1,00	17,00	22,78	27,66	31,26	1
3	I	170	10	2,585e+05	-3,656e+05	-1,41		0,41	17,00	70,71	81,51	144,81	1
5	I	170	10	-4,017e+05	-3,921e+05								
7	I	170	10	-3,548e+05	2,693e+05	-1,32		0,43	17,00	67,89	78,26	134,21	1

Note: The Classification limits have been set according to Semi-Comp+. The cross-section is classified as Class 1

Lateral Torsional Buckling check

According to EN 1993-1-1 article 6.3.2.1

Note: The cross-section concerns an RHS section with ' $h/b < 10 / \lambda_{rel,z}$ '.

This section is thus not susceptible to Lateral Torsional Buckling.

LTB additional parameters		
Minimal z coordinate z_{min}	-100	mm
Maximal z coordinate z_{max}	100	mm
Relative slenderness $\lambda_{rel,z}$	0,02	
End moment ratio ψ	-0,10	

LTB additional parameters		
Equivalent point load F	0,35	kN
Equivalent line load q	0,75	kN/m
Difference with M	0,08	kNm
Difference with F	0,00	kNm
Difference with q	0,00	kNm
Resulting load type	linear moment M	

The member satisfies the stability check.

4.2.5. DIMENZIONIRANJE – SEKUNDARNI NOSAČ 1

EC-EN 1993 Steel check ULS

Linear calculation

Combination: GSN5

Coordinate system: Principal

Extreme ID: Member

Selection: 82947

EN 1993-1-1 Code Check

National annex: Standard EN

Member B2947	0,000 / 15,450 m	HEA240	S 355	GSN5	0,79 -
--------------	------------------	--------	-------	------	--------

Combination key

GSN5 / 1.35*vlastita težina + 1.50*pokretno +
1.35*dodatno stalno + 1.50*vjetar smjer x +
0.90*temperatura negativna

Partial safety factors

γ_{M0} for resistance of cross-sections	1,00
γ_{M1} for resistance to instability	1,00
γ_{M2} for resistance of net sections	1,25

Material

Yield strength f_y	355,0	MPa
Ultimate strength f_u	490,0	MPa
Fabrication	Rolled	

....SECTION CHECK:....

The critical check is on position 0,000 m

Internal forces	Calculated	Unit
N_{Ed}	-37,22	kN
$V_{y,Ed}$	2,18	kN
$V_{z,Ed}$	65,34	kN
T_{Ed}	-0,02	kNm
$M_{y,Ed}$	-173,78	kNm
$M_{z,Ed}$	-2,67	kNm

Classification for cross-section design

Classification according to EN 1993-1-1 article 5.5.2

Classification of Internal and Outstand parts according to EN 1993 1-1 Table 5.2 Sheet 1 & 2

Id	Type	c [mm]	t [mm]	σ_1 [kN/m ²]	σ_2 [kN/m ²]	ψ [-]	k_o [-]	α [-]	c/t [-]	Class 1 Limit [-]	Class 2 Limit [-]	Class 3 Limit [-]	Class
1	SO	95	12	2,512e+05	2,604e+05	0,96	0,43	1,00	7,94	7,32	8,14	11,24	2
3	SO	95	12	2,464e+05	2,372e+05	0,96	0,44	1,00	7,94	7,32	8,14	11,38	2
4	I	164	8	1,884e+05	-1,787e+05	-0,95		0,54	21,87	51,66	60,14	95,47	1
5	SO	95	12	-2,415e+05	-2,507e+05								
7	SO	95	12	-2,367e+05	-2,275e+05								

Note: The Classification limits have been set according to Semi-Comp+.

The cross-section is classified as Class 2

Compression check

According to EN 1993-1-1 article 6.2.4 and formula (6.9)

A	7,6800e-03	m ²
$N_{c,Rd}$	2726,40	kN
Unity check	0,01	-

Bending moment check for M_y

According to EN 1993-1-1 article 6.2.5 and formula (6.12),(6.13)

W_{ply}	7,4583e-04	m ³
$M_{ply,Rd}$	264,77	kNm
Unity check	0,66	-

Bending moment check for M_z

According to EN 1993-1-1 article 6.2.5 and formula (6.12),(6.13)

$W_{pl,z}$	3,5167e-04	m ³
$M_{pl,z,Rd}$	124,84	kNm
Unity check	0,02	-

Shear check for V_y

According to EN 1993-1-1 article 6.2.6 and formula (6.17)

η	1,20	
A_v	5,9737e-03	m ²
$V_{ply,Rd}$	1224,38	kN
Unity check	0,00	-

Shear check for V_z

According to EN 1993-1-1 article 6.2.6 and formula (6.17)

η	1,20	
A_v	2,5140e-03	m ²
$V_{pl,z,Rd}$	515,27	kN
Unity check	0,13	-

Torsion check

According to EN 1993-1-1 article 6.2.7 and formula (6.23)

Fibre	2	
T_{Ed}	0,6	MPa
T_{Rd}	205,0	MPa
Unity check	0,00	-

Note: The unity check for torsion is lower than the limit value of 0,05. Therefore torsion is considered as insignificant and is ignored in the combined checks.

Combined bending, axial force and shear force check

According to EN 1993-1-1 article 6.2.9.1 and formula (6.41)

$M_{pl,y,Rd}$	264,77	kNm
α	2,00	
$M_{pl,z,Rd}$	124,84	kNm
β	1,00	

Unity check (6.41) = $0,43 + 0,02 = 0,45$

Note: Since the shear forces are less than half the plastic shear resistances their effect on the moment resistances is neglected.

Note: Since the axial force satisfies both criteria (6.33) and (6.34) of EN 1993-1-1 article 6.2.9.1(4) its effect on the moment resistance about the y-y axis is neglected.

Note: Since the axial force satisfies criteria (6.35) of EN 1993-1-1 article 6.2.9.1(4) its effect on the moment resistance about the z-z axis is neglected.

Decision tables for combined section check

Force presence	
Axial force N_{Ed}	Present
Shear force $V_{y,Ed}$	Not significant
Shear force $V_{z,Ed}$	Not significant
Torsional moment T_{Ed}	Not significant
Bending moment $M_{y,Ed}$	Present
Bending moment $M_{z,Ed}$	Present
Significant shear force without corresponding bending moment	No
Warping data	Not present or negligible

Check inputs	
Classification is supported	Yes
Section classification	Class 2
Elastic verification is set by the user	No
Plastic shear formula is available	Yes
Combined bending and axial force formula is available	Yes
Combined bending and axial force check can be calculated	Yes

Selected check

According to EN 1993-1-1 article 6.2.9.1 and formula (6.41)

The member satisfies the section check.

....:STABILITY CHECK:....

Classification for member buckling design

Decisive position for stability classification: 15,450 m

Classification according to EN 1993-1-1 article 5.5.2

Classification of Internal and Outstand parts according to EN 1993-1-1 Table 5.2 Sheet 1 & 2

Id	Type	c [mm]	t [mm]	σ_1 [kN/m ²]	σ_2 [kN/m ²]	ψ [-]	k_α [-]	α [-]	c/t [-]	Class 1 Limit [-]	Class 2 Limit [-]	Class 3 Limit [-]	Class
1	SO	95	12	2,409e+05	2,261e+05	0,94	0,45	1,00	7,94	7,32	8,14	11,49	2
3	SO	95	12	2,486e+05	2,634e+05	0,94	0,43	1,00	7,94	7,32	8,14	11,26	2
4	I	164	8	1,852e+05	-1,764e+05	-0,95		0,54	21,87	52,18	60,70	95,83	1
5	SO	95	12	-2,321e+05	-2,173e+05								
7	SO	95	12	-2,397e+05	-2,545e+05								

Note: The Classification limits have been set according to Semi-Comp+.

The cross-section is classified as Class 2

Flexural Buckling check

According to EN 1993-1-1 article 6.3.1.1 and formula (6.46)

Buckling parameters	yy	zz	
Sway type	sway	non-sway	
System length L	15,450	1,870	m
Buckling factor k	1,34	0,59	
Buckling length L_{cr}	20,757	1,108	m

Buckling parameters	yy	zz	
Critical Euler load N_{cr}	373,29	46752,16	kN
Slenderness λ	206,50	18,45	
Relative slenderness λ_{rel}	2,70	0,24	
Limit slenderness $\lambda_{rel,0}$	0,20	0,20	
Buckling curve	b	c	
Imperfection α	0,34	0,49	
Reduction factor χ	0,12	0,98	
Buckling resistance $N_{b,Rd}$	329,61	2668,86	kN

Flexural Buckling verification		
Cross-section area A	7,6800e-03	m ²
Buckling resistance $N_{b,Rd}$	329,61	kN
Unity check	0,11	-

Torsional(-Flexural) Buckling check

According to EN 1993-1-1 article 6.3.1.1 and formula (6.46)

Note: For this I-section the Torsional(-Flexural) buckling resistance is higher than the resistance for Flexural buckling. Therefore Torsional(-Flexural) buckling is not printed on the output.

Lateral Torsional Buckling check

According to EN 1993-1-1 article 6.3.2.1 & 6.3.2.3 and formula (6.54)

LTB parameters		
Method for LTB curve	Alternative case	
Plastic section modulus $W_{pl,y}$	7,4583e-04	m ³
Elastic critical moment M_{cr}	2861,25	kNm
Relative slenderness $\lambda_{rel,LT}$	0,30	
Limit slenderness $\lambda_{rel,LT,0}$	0,40	

Note: The slenderness or bending moment is such that Lateral Torsional Buckling effects may be ignored according to EN 1993-1-1 article 6.3.2.2(4).

Mcr parameters		
LTB length L	1,870	m
Influence of load position	no influence	
Correction factor k	1,00	
Correction factor k_{rel}	1,00	
LTB moment factor C_1	1,48	
LTB moment factor C_2	0,00	
LTB moment factor C_3	1,00	
Shear center distance d_s	0	mm
Distance of load application z_q	0	mm
Mono-symmetry constant β_y	0	mm
Mono-symmetry constant z_s	0	mm

Note: C parameters are determined according to ECCS 119 2006 / Galea 2002.

LTB additional parameters		
Minimal z coordinate z_{min}	-115	mm
Maximal z coordinate z_{max}	115	mm
End moment ratio ψ	0,30	
Equivalent point load F	0,75	kN
Equivalent line load q	0,80	kN/m
Difference with M	0,35	kNm
Difference with F	0,00	kNm
Difference with q	0,00	kNm
Resulting load type	linear moment M	

Bending and axial compression check

According to EN 1993-1-1 article 6.3.3 and formula (6.61),(6.62)

Bending and axial compression check parameters		
Interaction method	alternative method 1	
Cross-section area A	7,6800e-03	m ²
Plastic section modulus $W_{pl,y}$	7,4583e-04	m ³
Plastic section modulus $W_{pl,z}$	3,5167e-04	m ³
Design compression force N_{Ed}	37,22	kN
Design bending moment (maximum) $M_{y,Ed}$	-173,78	kNm
Design bending moment (maximum) $M_{z,Ed}$	-2,67	kNm
Characteristic compression resistance N_{Rk}	2726,40	kN
Characteristic moment resistance $M_{y,Rk}$	264,77	kNm
Characteristic moment resistance $M_{z,Rk}$	124,84	kNm
Reduction factor χ_y	0,12	
Reduction factor χ_z	0,98	
Modified reduction factor $\chi_{LT,mod}$	1,00	
Interaction factor k_{yy}	1,02	
Interaction factor k_{yz}	0,49	
Interaction factor k_{zy}	0,63	
Interaction factor k_{zz}	0,71	

Maximum moment $M_{y,Ed}$ is derived from beam B2947 position 0,000 m.
Maximum moment $M_{z,Ed}$ is derived from beam B2947 position 0,000 m.

Interaction method 1 parameters		
Critical Euler load $N_{cr,y}$	373,29	kN
Critical Euler load $N_{cr,z}$	46752,16	kN
Elastic critical load $N_{cr,T}$	16650,08	kN
Plastic section modulus $W_{pl,y}$	7,4583e-04	m ³
Elastic section modulus $W_{el,y}$	6,7500e-04	m ³
Plastic section modulus $W_{pl,z}$	3,5167e-04	m ³
Elastic section modulus $W_{el,z}$	2,3100e-04	m ³
Second moment of area I_y	7,7600e-05	m ⁴
Second moment of area I_z	2,7700e-05	m ⁴
Torsional constant I_t	4,1600e-07	m ⁴
Method for equivalent moment factor $C_{my,0}$	Table A.2 Line 2 (General)	
Design bending moment (maximum) $M_{y,Ed}$	-173,78	kNm
Maximum relative deflection δ_z	-76,4	mm
Equivalent moment factor $C_{my,0}$	0,93	
Method for equivalent moment factor $C_{mz,0}$	Table A.2 Line 1 (Linear)	
Ratio of end moments ψ_z	-0,53	
Equivalent moment factor $C_{mz,0}$	0,68	
Factor μ_y	0,91	
Factor μ_z	1,00	
Factor ϵ_y	53,13	
Factor a_{LT}	0,99	
Critical moment for uniform bending $M_{cr,0}$	1935,95	kNm
Relative slenderness $\lambda_{rel,0}$	0,37	
Limit relative slenderness $\lambda_{rel,lim}$	0,24	
Equivalent moment factor C_{my}	0,99	
Equivalent moment factor C_{mz}	0,68	
Equivalent moment factor $C_{m,T}$	1,00	
Factor b_{LT}	0,00	
Factor c_{LT}	0,18	
Factor d_{LT}	0,15	
Factor e_{LT}	4,00	
Factor w_y	1,10	
Factor w_z	1,50	
Factor η_{pl}	0,01	
Maximum relative slenderness $\lambda_{rel,max}$	2,70	
Factor C_{yy}	0,98	
Factor C_{yz}	0,88	
Factor C_{zy}	0,90	
Factor C_{zz}	0,95	

Unity check (6.61) = $0,11 + 0,67 + 0,01 = 0,79$ -

Unity check (6.62) = $0,01 + 0,41 + 0,02 = 0,44$ -

Shear Buckling check

According to EN 1993-1-5 article 5 & 7.1 and formula (5.10) & (7.1)

Shear Buckling parameters		
Buckling field length a	15,450	m
Web	unstiffened	
Web height h_w	206	mm
Web thickness t	8	mm
Material coefficient ϵ	0,81	
Shear correction factor η	1,20	

Shear Buckling verification		
Web slenderness h_w/t	27,47	
Web slenderness limit	48,82	

Note: The web slenderness is such that Shear Buckling effects may be ignored according to EN 1993-1-5 article 5.1(2).

The member satisfies the stability check.

4.2.6. DIMENZIONIRANJE – SEKUNDARNI NOSAČ 2

EC-EN 1993 Steel check ULS

Linear calculation

Combination: GSN6

Coordinate system: Principal

Extreme ID: Member

Selection: B3141, B3165..B3171

EN 1993-1-1 Code Check

National annex: Standard EN

Member B3141	0,000 / 9,065 m	HEA200	S 355	GSN6	0,72 -
---------------------	------------------------	---------------	--------------	-------------	---------------

....:SECTION CHECK:....

The critical check is on position 0,000 m

Internal forces	Calculated	Unit
N_{Ed}	-82,28	kN
$V_{y,Ed}$	0,33	kN
$V_{z,Ed}$	45,45	kN
T_{Ed}	0,00	kNm
$M_{y,Ed}$	-79,00	kNm
$M_{z,Ed}$	-0,64	kNm

Classification for cross-section design

Classification according to EN 1993-1-1 article 5.5.2

Classification of Internal and Outstand parts according to EN 1993-1-1 Table 5.2 Sheet 1 & 2

Id	Type	c [mm]	t [mm]	σ_1 [kN/m ²]	σ_2 [kN/m ²]	ψ [-]	k_{σ} [-]	α [-]	c/t [-]	Class 1 Limit [-]	Class 2 Limit [-]	Class 3 Limit [-]	Class
1	SO	79	10	2,088e+05	2,126e+05	0,98	0,43	1,00	7,88	7,32	8,14	11,22	2
3	SO	79	10	2,068e+05	2,030e+05	0,98	0,44	1,00	7,88	7,32	8,14	11,30	2
4	I	134	7	1,586e+05	-1,280e+05	-0,81		0,63	20,62	41,31	48,81	82,92	1
5	SO	79	10	-1,783e+05	-1,820e+05								
7	SO	79	10	-1,762e+05	-1,725e+05								

Note: The Classification limits have been set according to Semi-Comp+.
The cross-section is classified as Class 2

Compression check

According to EN 1993-1-1 article 6.2.4 and formula (6.9)

A	5,3800e-03	m ²
$N_{c,Rd}$	1909,90	kN
Unity check	0,04	-

Bending moment check for M_y

According to EN 1993-1-1 article 6.2.5 and formula (6.12),(6.13)

$W_{pl,y}$	4,2917e-04	m ³
$M_{pl,y,Rd}$	152,35	kNm
Unity check	0,52	-

Bending moment check for M_z

According to EN 1993-1-1 article 6.2.5 and formula (6.12),(6.13)

$W_{pl,z}$	2,0375e-04	m ³
$M_{pl,z,Rd}$	72,33	kNm
Unity check	0,01	-

Shear check for V_y

According to EN 1993-1-1 article 6.2.6 and formula (6.17)

η	1,20	
A_v	4,1592e-03	m ²
$V_{pl,y,Rd}$	852,48	kN
Unity check	0,00	-

Shear check for V_z

According to EN 1993-1-1 article 6.2.6 and formula (6.17)

η	1,20	
--------	------	--

A_v	1,8050e-03	m ²
$V_{pl,z,Rd}$	369,95	kN
Unity check	0,12	-

Combined bending, axial force and shear force check
 According to EN 1993-1-1 article 6.2.9.1 and formula (6.41)

$M_{pl,y,Rd}$	152,35	kNm
α	2,00	
$M_{pl,z,Rd}$	72,33	kNm
β	1,00	

Unity check (6.41) = 0,27 + 0,01 = 0,28 -

Note: Since the shear forces are less than half the plastic shear resistances their effect on the moment resistances is neglected.

Note: Since the axial force satisfies both criteria (6.33) and (6.34) of EN 1993-1-1 article 6.2.9.1(4) its effect on the moment resistance about the y-y axis is neglected.

Note: Since the axial force satisfies criteria (6.35) of EN 1993-1-1 article 6.2.9.1(4) its effect on the moment resistance about the z-z axis is neglected.

The member satisfies the section check.

...:STABILITY CHECK:...

Classification for member buckling design

Decisive position for stability classification: 0,000 m

Classification according to EN 1993-1-1 article 5.5.2

Classification of Internal and Outstand parts according to EN 1993-1-1 Table 5.2 Sheet 1 & 2

Id	Type	c [mm]	t [mm]	σ_1 [kN/m ²]	σ_2 [kN/m ²]	ψ [-]	k_σ [-]	α [-]	c/t [-]	Class 1 Limit [-]	Class 2 Limit [-]	Class 3 Limit [-]	Class
1	SO	79	10	2,088e+05	2,126e+05	0,98	0,43	1,00	7,88	7,32	8,14	11,22	2
3	SO	79	10	2,068e+05	2,030e+05	0,98	0,44	1,00	7,88	7,32	8,14	11,30	2
4	I	134	7	1,586e+05	-1,280e+05	-0,81		0,63	20,62	41,31	48,81	82,92	1
5	SO	79	10	-1,783e+05	-1,820e+05								
7	SO	79	10	-1,762e+05	-1,725e+05								

Note: The Classification limits have been set according to Semi-Comp+.

The cross-section is classified as Class 2

Flexural Buckling check

According to EN 1993-1-1 article 6.3.1.1 and formula (6.46)

Buckling parameters	yy	zz	
Sway type	sway	non-sway	
System length L	9,065	9,065	m
Buckling factor k	1,10	0,53	
Buckling length L_{cr}	9,970	4,805	m
Critical Euler load N_{cr}	769,34	1203,02	kN
Slenderness λ	120,39	96,28	
Relative slenderness λ_{rel}	1,58	1,26	
Limit slenderness $\lambda_{rel,0}$	0,20	0,20	
Buckling curve	b	c	
Imperfection α	0,34	0,49	
Reduction factor χ	0,32	0,41	
Buckling resistance $N_{b,Rd}$	603,23	775,69	kN

Flexural Buckling verification		
Cross-section area A	5,3800e-03	m ²
Buckling resistance $N_{b,Rd}$	603,23	kN
Unity check	0,14	-

Torsional(-Flexural) Buckling check

According to EN 1993-1-1 article 6.3.1.1 and formula (6.46)

Note: For this I-section the Torsional(-Flexural) buckling resistance is higher than the resistance for Flexural buckling. Therefore Torsional(-Flexural) buckling is not printed on the output.

Lateral Torsional Buckling check

According to EN 1993-1-1 article 6.3.2.1 & 6.3.2.3 and formula (6.54)

LTB parameters		
Method for LTB curve	Alternative case	
Plastic section modulus $W_{pl,y}$	4,2917e-04	m ³
Elastic critical moment M_{cr}	275,05	kNm
Relative slenderness $\lambda_{rel,LT}$	0,74	
Limit slenderness $\lambda_{rel,LT,0}$	0,40	
LTB curve	b	
Imperfection α_{LT}	0,34	
LTB factor β	0,75	
Reduction factor χ_{LT}	0,85	
Correction factor k_σ	0,54	
Correction factor f	0,77	

LTB parameters		
Modified reduction factor $\chi_{LT,mod}$	1,00	
Design buckling resistance $M_{b,Rd}$	152,35	kNm
Unity check	0,52	
MCR parameters		
LTB length L	9,065	m
Influence of load position	no influence	
Correction factor k	1,00	
Correction factor k_{cr}	1,00	
LTB moment factor C_1	3,37	
LTB moment factor C_2	1,66	
LTB moment factor C_3	0,41	
Shear center distance d_z	0	mm
Distance of load application z_D	0	mm
Mono-symmetry constant β_y	0	mm
Mono-symmetry constant z_j	0	mm

Note: C parameters are determined according to ECCS 119 2006 / Galea 2002.

Note: The correction factor k_c is determined from C_1 .

Bending and axial compression check

According to EN 1993-1-1 article 6.3.3 and formula (6.61),(6.62)

Bending and axial compression check parameters		
Interaction method	alternative method 1	
Cross-section area A	5,3800e-03	m ²
Plastic section modulus $W_{pl,y}$	4,2917e-04	m ³
Plastic section modulus $W_{pl,z}$	2,0375e-04	m ³
Design compression force N_{Ed}	82,28	kN
Design bending moment (maximum) $M_{y,Ed}$	-79,00	kNm
Design bending moment (maximum) $M_{z,Ed}$	2,36	kNm
Characteristic compression resistance N_{Rk}	1909,90	kN
Characteristic moment resistance $M_{y,Rk}$	152,35	kNm
Characteristic moment resistance $M_{z,Rk}$	72,33	kNm
Reduction factor χ_y	0,32	
Reduction factor χ_z	0,41	
Modified reduction factor $\chi_{LT,mod}$	1,00	
Interaction factor k_{yy}	1,05	
Interaction factor k_{yz}	1,08	
Interaction factor k_{zy}	0,60	
Interaction factor k_{zz}	0,75	

Maximum moment $M_{y,Ed}$ is derived from beam B3141 position 0,000 m.

Maximum moment $M_{z,Ed}$ is derived from beam B3141 position 9,065 m.

Interaction method 1 parameters		
Critical Euler load $N_{cr,y}$	769,34	kN
Critical Euler load $N_{cr,z}$	1203,02	kN
Elastic critical load $N_{cr,T}$	2105,53	kN
Plastic section modulus $W_{pl,y}$	4,2917e-04	m ³
Elastic section modulus $W_{el,y}$	3,8900e-04	m ³
Plastic section modulus $W_{pl,z}$	2,0375e-04	m ³
Elastic section modulus $W_{el,z}$	1,3400e-04	m ³
Second moment of area I_y	3,6900e-05	m ⁴
Second moment of area I_z	1,3400e-05	m ⁴
Torsional constant I_t	2,1000e-07	m ⁴
Method for equivalent moment factor $C_{my,0}$	Table A.2 Line 2 (General)	
Design bending moment (maximum) $M_{y,Ed}$	-79,00	kNm
Maximum relative deflection δ_z	-19,2	mm
Equivalent moment factor $C_{my,0}$	0,92	
Method for equivalent moment factor $C_{mz,0}$	Table A.2 Line 1 (Linear)	
Ratio of end moments ψ_z	-0,27	
Equivalent moment factor $C_{mz,0}$	0,72	
Factor μ_y	0,92	
Factor μ_z	0,96	
Factor ϵ_y	13,28	
Factor a_{LT}	0,99	
Critical moment for uniform bending $M_{cr,0}$	81,57	kNm
Relative slenderness $\lambda_{rel,0}$	1,37	
Limit relative slenderness $\lambda_{rel,0,lim}$	0,36	
Equivalent moment factor C_{my}	0,98	
Equivalent moment factor C_{mz}	0,72	
Equivalent moment factor C_{mLT}	1,01	
Factor b_{LT}	0,02	
Factor c_{LT}	1,30	
Factor d_{LT}	0,02	
Factor e_{LT}	0,47	
Factor w_y	1,10	
Factor w_z	1,50	
Factor η_{pl}	0,04	

Interaction method 1 parameters	
Maximum relative slenderness $\lambda_{rel,max}$	1,58
Factor C_{yy}	0,98
Factor C_{yz}	0,46
Factor C_{zy}	0,92
Factor C_{zz}	0,98

Unity check (6.61) = $0,14 + 0,54 + 0,04 = 0,72$ -
 Unity check (6.62) = $0,11 + 0,31 + 0,02 = 0,44$ -

Shear Buckling check

According to EN 1993-1-5 article 5 & 7.1 and formula (5.10) & (7.1)

Shear Buckling parameters	
Buckling field length a	9,065 m
Web	unstiffened
Web height h_w	170 mm
Web thickness t	7 mm
Material coefficient ε	0,81
Shear correction factor η	1,20

Shear Buckling verification	
Web slenderness h_w/t	26,15
Web slenderness limit	48,82

Note: The web slenderness is such that Shear Buckling effects may be ignored according to EN 1993-1-5 article 5.1(2).

The member satisfies the stability check.

4.3. DIMENZIONIRANJE PROSTORA ZA BALET- 2.KAT

4.3.1. REZNE SILE –GORNJI POJAS GLAVNOG REŠETKASTOG NOSAČA

My

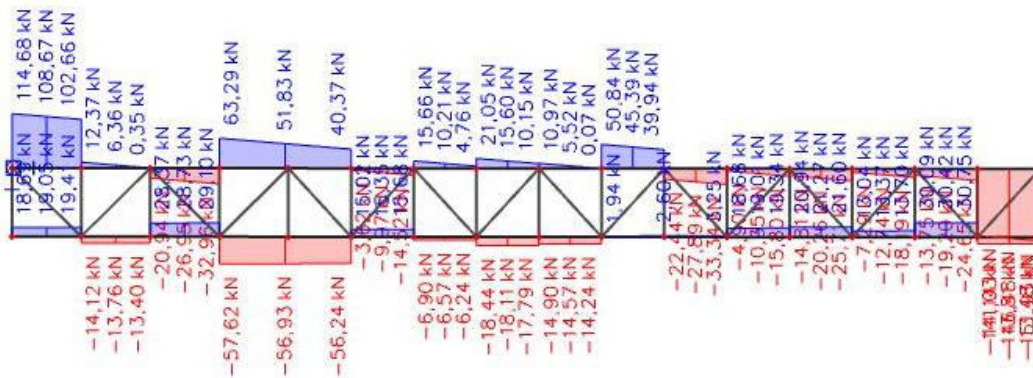

Vz

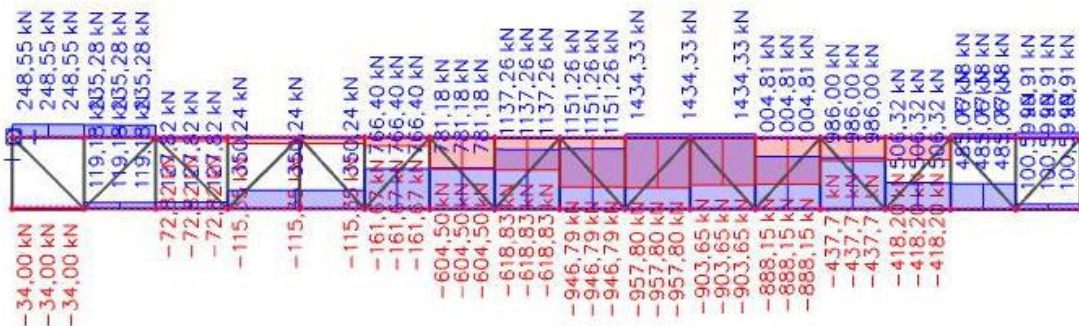

4.3.2. DIMENZIONIRANJE –GORNJI POJAS GLAVNOG REŠETKASTOG NOSAČA

EN 1993-1-1 Code Check

National annex: Standard EN

Member B2946 8,194 / 14,290 m CFRHS200X200X10 S 355 GSN5 0,84 -

Note: EN 1993-1-3 article 1.1(3) specifies that this part does not apply to cold formed CHS and RHS sections. The default EN 1993-1-1 code check is executed instead of the EN 1993-1-3 code check.

Combination key
GSN5 / 1.35*vlastita težina + 1.50*pokretno + 1.35*dodatno stalno + 1.50*vjetar smjer x + 0.90*temperatura negativna

Partial safety factors	
γ_{M0} for resistance of cross-sections	1,00
γ_{M1} for resistance to instability	1,00
γ_{M2} for resistance of net sections	1,25

Material		
Yield strength f_y	355,0	MPa
Ultimate strength f_u	490,0	MPa
Fabrication	Cold formed	

....SECTION CHECK:....

The critical check is on position 8,194 m

Internal forces	Calculated	Unit
N_{Ed}	-953,02	kN
$V_{y,Ed}$	-4,42	kN
$V_{z,Ed}$	51,33	kN
T_{Ed}	2,06	kNm
$M_{y,Ed}$	6,83	kNm
$M_{z,Ed}$	-6,31	kNm

Classification for cross-section design

Classification according to EN 1993-1-1 article 5.5.2

Classification of Internal and Outstand parts according to EN 1993-1-1 Table 5.2 Sheet 1 & 2

Id	Type	c [mm]	t [mm]	σ_1 [kN/m ²]	σ_2 [kN/m ²]	ψ [-]	k_σ [-]	α [-]	c/t [-]	Class 1 Limit [-]	Class 2 Limit [-]	Class 3 Limit [-]	Class
1	I	170	10	1,287e+05	1,035e+05	0,80		1,00	17,00	22,78	27,66	33,17	1
3	I	170	10	1,036e+05	1,309e+05	0,79		1,00	17,00	22,78	27,66	33,33	1
5	I	170	10	1,340e+05	1,592e+05	0,84		1,00	17,00	22,78	27,66	32,72	1
7	I	170	10	1,591e+05	1,318e+05	0,83		1,00	17,00	22,78	27,66	32,88	1

Note: The Classification limits have been set according to Semi-Comp+. The cross-section is classified as Class 1

Compression check

According to EN 1993-1-1 article 6.2.4 and formula (6.9)

A	7,2570e-03	m ²
N _{c,Rd}	2576,24	kN
Unity check	0,37	-

Bending moment check for M_y

According to EN 1993-1-1 article 6.2.5 and formula (6.12),(6.13)

W _{pl,y}	5,0808e-04	m ³
M _{pl,y,Rd}	180,37	kNm
Unity check	0,04	-

Bending moment check for M_z

According to EN 1993-1-1 article 6.2.5 and formula (6.12),(6.13)

W _{pl,z}	5,0808e-04	m ³
M _{pl,z,Rd}	180,37	kNm
Unity check	0,03	-

Shear check for V_y

According to EN 1993-1-1 article 6.2.6 and formula (6.17)

l _j	1,20	
A _v	3,6285e-03	m ²
V _{pl,y,Rd}	743,69	kN
Unity check	0,01	-

Shear check for V_z

According to EN 1993-1-1 article 6.2.6 and formula (6.17)

η	1,20	
A _v	3,6285e-03	m ²
V _{pl,z,Rd}	743,69	kN
Unity check	0,07	-

Torsion check

According to EN 1993-1-1 article 6.2.7 and formula (6.23)

Fibre	1	
T _{Ed}	2,8	MPa
T _{Rd}	205,0	MPa
Unity check	0,01	-

Note: The unity check for torsion is lower than the limit value of 0,05. Therefore torsion is considered as insignificant and is ignored in the combined checks.

Combined bending, axial force and shear force check

According to EN 1993-1-1 article 6.2.9.1 and formula (6.41)

M _{N,y,Rd}	146,53	kNm
α	1,96	
M _{N,x,Rd}	146,53	kNm
β	1,96	

Unity check (5.41) = 0,00 + 0,00 = 0,00

Note: Since the shear forces are less than half the plastic shear resistances their effect on the moment resistances is neglected.

Decision tables for combined section check

Force presence	
Axial force N _{Ed}	Present
Shear force V _{y,Ed}	Not significant
Shear force V _{z,Ed}	Not significant
Torsional moment T _{Ed}	Not significant
Bending moment M _{y,Ed}	Present
Bending moment M _{z,Ed}	Present
Significant shear force without corresponding bending moment	No
Warping data	Not present or negligible

Check inputs	
Classification is supported	Yes
Section classification	Class 1
Elastic verification is set by the user	No
Plastic shear formula is available	Yes
Combined bending and axial force formula is available	Yes
Combined bending and axial force check can be calculated	Yes

Selected check
According to EN 1993-1-1 article 6.2.9.1 and formula (6.41)

The member satisfies the section check.

....:STABILITY CHECK:....

Classification for member buckling design

Decisive position for stability classification: 14,290 m

Classification according to EN 1993-1-1 article 5.5.2

Classification of Internal and Outstand parts according to EN 1993-1-1 Table 5.2 Sheet 1 & 2

Id	Type	c [mm]	t [mm]	σ_1 [kN/m ²]	σ_2 [kN/m ²]	ψ [-]	k_σ [-]	α [-]	c/t [-]	Class 1 Limit [-]	Class 2 Limit [-]	Class 3 Limit [-]	Class
1	I	170	10	2,176e+05	2,866e+05	0,76		1,00	17,00	22,78	27,66	33,73	1
3	I	170	10	2,627e+05	-2,126e+05	-0,81		0,55	17,00	50,26	58,62	83,07	1
5	I	170	10	-2,446e+05	-3,136e+05								
7	I	170	10	-2,897e+05	1,856e+05	-1,56		0,39	17,00	75,01	86,47	161,39	1

Note: The Classification limits have been set according to Semi-Comp+.

The cross-section is classified as Class 1

Flexural Buckling check

According to EN 1993-1-1 article 6.3.1.1 and formula (6.46)

Buckling parameters	yy	zz	
Sway type	sway	non-sway	
System length L	0,871	9,065	m
Buckling factor k	1,91	0,56	
Buckling length L_{cr}	1,666	5,107	m
Critical Euler load N_{cr}	31750,88	3377,92	kN
Slenderness λ	21,77	66,73	
Relative slenderness λ_{rel}	0,28	0,87	
Limit slenderness $\lambda_{rel,0}$	0,20	0,20	
Buckling curve	c	c	
Imperfection α	0,49	0,49	
Reduction factor χ	0,96	0,62	
Buckling resistance $N_{b,Rd}$	2465,12	1587,77	kN

Flexural Buckling verification

Cross-section area A	7,2570e-03	m ²
Buckling resistance $N_{b,Rd}$	1587,77	kN
Unity check	0,60	-

Torsional(-Flexural) Buckling check

According to EN 1993-1-1 article 6.3.1.1 and formula (6.46)

Note: The cross-section concerns a RHS section which is not susceptible to Torsional(-Flexural) Buckling.

Lateral Torsional Buckling check

According to EN 1993-1-1 article 6.3.2.1

Note: The cross-section concerns an RHS section with ' $h / b < 10 / \lambda_{rel,z}$ '. This section is thus not susceptible to Lateral Torsional Buckling.

LTB additional parameters		
Minimal z coordinate z_{min}	-100	mm
Maximal z coordinate z_{max}	100	mm
Relative slenderness $\lambda_{rel,z}$	0,87	
End moment ratio ψ	-0,49	
Equivalent point load F	37,07	kN
Equivalent line load q	8,18	kN/m
Difference with M	544,63	kNm
Difference with F	638,19	kNm
Difference with q	774,71	kNm
Resulting load type	point load F	

Bending and axial compression check

According to EN 1993-1-1 article 6.3.3 and formula (6.61),(6.62)

Bending and axial compression check parameters		
Interaction method	alternative method 1	
Cross-section area A	7,2570e-03	m ²
Plastic section modulus $W_{pl,y}$	5,0808e-04	m ³
Plastic section modulus $W_{pl,z}$	5,0808e-04	m ³
Design compression force N_{Ed}	953,02	kN
Design bending moment (maximum) $M_{y,Ed}$	46,79	kNm
Design bending moment (maximum) $M_{z,Ed}$	16,46	kNm
Characteristic compression resistance N_{Rk}	2576,24	kN
Characteristic moment resistance $M_{y,Rk}$	180,37	kNm
Characteristic moment resistance $M_{z,Rk}$	180,37	kNm
Reduction factor χ_y	0,96	
Reduction factor χ_z	0,62	
Reduction factor χ_{LT}	1,00	
Interaction factor k_{yy}	1,03	
Interaction factor k_{yz}	0,63	
Interaction factor k_{zy}	0,64	
Interaction factor k_{zz}	0,85	

Maximum moment $M_{y,Ed}$ is derived from beam B2946 position 9,065 m.

Maximum moment $M_{z,Ed}$ is derived from beam B2946 position 0,000 m.

Maximum moment $M_{z,Ed}$ is derived from beam B2946 position 0,000 m.

Interaction method 1 parameters		
Critical Euler load $N_{cr,y}$	31750,88	kN
Critical Euler load $N_{cr,z}$	3377,92	kN
Elastic critical load $N_{cr,T}$	488104,28	kN
Plastic section modulus $W_{pl,y}$	5,0808e-04	m ³
Elastic section modulus $W_{el,y}$	4,2511e-04	m ³
Plastic section modulus $W_{pl,z}$	5,0808e-04	m ³
Elastic section modulus $W_{el,z}$	4,2511e-04	m ³
Second moment of area I_y	4,2511e-05	m ⁴
Second moment of area I_z	4,2511e-05	m ⁴
Torsional constant I_t	7,0717e-05	m ⁴
Method for equivalent moment factor $C_{my,0}$	Table A.2 Line 2 (General)	
Design bending moment (maximum) $M_{y,Ed}$	46,79	kNm
Maximum relative deflection δ_z	-0,3	mm
Equivalent moment factor $C_{my,0}$	0,99	
Method for equivalent moment factor $C_{mz,0}$	Table A.2 Line 2 (General)	
Design bending moment (maximum) $M_{z,Ed}$	16,46	kNm
Maximum relative deflection δ_y	1,2	mm
Equivalent moment factor $C_{mz,0}$	0,74	
Factor μ_1	1,00	
Factor μ_2	0,87	
Factor ϵ_y	0,84	
Factor a_{LT}	0,00	
Critical moment for uniform bending $M_{cr,0}$	2476,18	kNm
Relative slenderness $\lambda_{rel,0}$	0,27	
Limit relative slenderness $\lambda_{rel,0,lim}$	0,26	
Equivalent moment factor C_{my}	0,99	
Equivalent moment factor C_{mz}	0,74	
Equivalent moment factor C_{mLT}	1,00	
Factor b_{LT}	0,00	
Factor c_{LT}	0,00	
Factor d_{LT}	0,00	
Factor e_{LT}	0,00	
Factor w_y	1,20	
Factor w_z	1,20	
Factor η_{pl}	0,37	
Maximum relative slenderness $\lambda_{rel,max}$	0,87	
Factor C_{yy}	0,99	
Factor C_{yz}	0,97	
Factor C_{zy}	0,83	
Factor C_{zz}	1,06	

Unity check (6.61) = $0,39 + 0,27 + 0,06 = 0,71$ -

Unity check (6.62) = $0,60 + 0,17 + 0,08 = 0,84$ -

The member satisfies the stability check.

4.3.3. REZNE SILE –DONJI POJAS GLAVNOG REŠETKASTOG NOSAČA

My

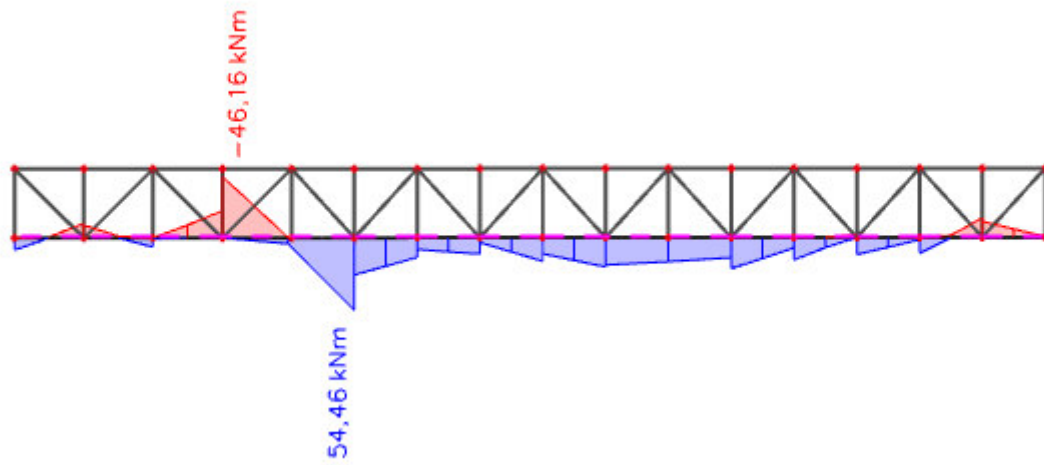

Vz

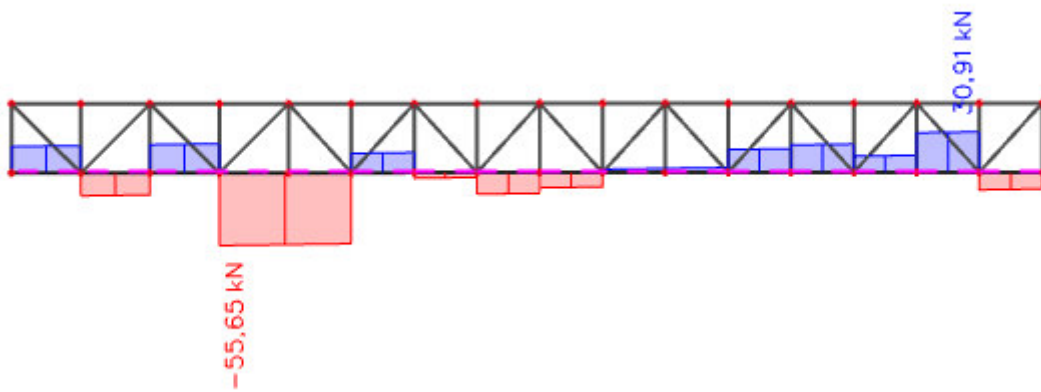

N

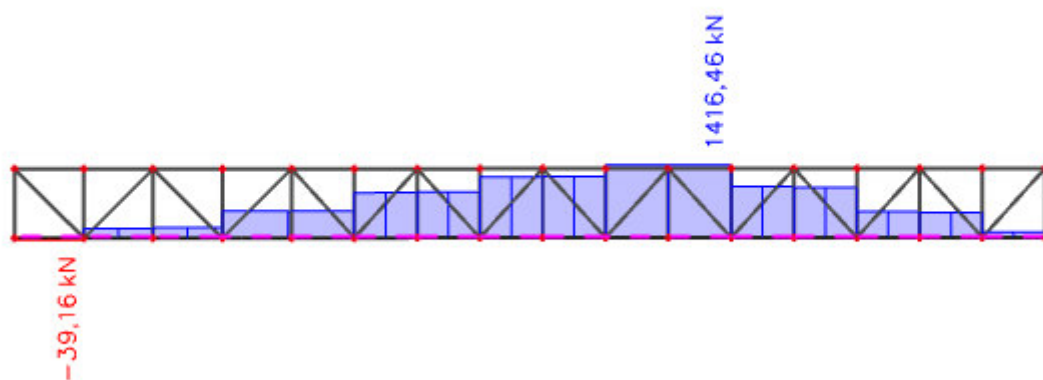

4.3.4. DIMENZIONIRANJE –DONJI POJAS GLAVNOG REŠETKASTOG NOSAČA

EN 1993-1-1 Code Check

National annex: Standard EN

Member B3031 4,354 / 14,290 m CFRHS200X200X10 S 355 GSN8 0,56 -

Note: EN 1993-1-3 article 1.1(3) specifies that this part does not apply to cold formed CHS and RHS sections. The default EN 1993-1-1 code check is executed instead of the EN 1993-1-3 code check.

Combination key	
GSN8 / 1.35*vestita težina + 1.50*pokretno + 1.35*dodatno stalno + 0.90*temperatura pozitivna	
Partial safety factors	
γ_{M2} for resistance of cross-sections	1,00
γ_{M1} for resistance to instability	1,00

....SECTION CHECK:....

The critical check is on position 4,354 m

Internal forces	Calculated	Unit
N_{Ed}	1430,12	kN
$V_{y,Ed}$	-0,86	kN
$V_{z,Ed}$	3,26	kN
T_{Ed}	-1,29	kNm
$M_{y,Ed}$	16,24	kNm
$M_{z,Ed}$	9,57	kNm

Classification for cross-section design

Classification according to EN 1993-1-1 article 5.5.2

Classification of Internal and Outstand parts according to EN 1993-1-1 Table 5.2 Sheet 1 & 2

Id	Type	c [mm]	t [mm]	σ_1 [kN/m ²]	σ_2 [kN/m ²]	ψ [-]	k_{σ} [-]	α [-]	c/t [-]	Class 1 Limit [-]	Class 2 Limit [-]	Class 3 Limit [-]	Class
1	I	170	10	-2,526e+05	-2,143e+05								
3	I	170	10	-2,082e+05	-1,433e+05								
5	I	170	10	-1,417e+05	-1,800e+05								
7	I	170	10	-1,860e+05	-2,510e+05								

Note: The Classification limits have been set according to Semi-Comp+. The cross-section is classified as Class 1.

Tension check

According to EN 1993-1-1 article 6.2.3 and formula (6.5)

A	7,2570e-03	m ²
N _{pl,Rd}	2576,24	kN
N _{u,Rd}	2560,27	kN
N _{t,Rd}	2560,27	kN
Unity check	0,56	-

Bending moment check for M_y

According to EN 1993-1-1 article 6.2.5 and formula (6.12),(6.13)

W _{pl,y}	5,0808e-04	m ³
M _{pl,y,Rd}	180,37	kNm
Unity check	0,09	-

Bending moment check for M_z

According to EN 1993-1-1 article 6.2.5 and formula (6.12),(6.13)

W _{pl,z}	5,0808e-04	m ³
M _{pl,z,Rd}	180,37	kNm
Unity check	0,05	-

Shear check for V_y

According to EN 1993-1-1 article 6.2.6 and formula (6.17)

η	1,20	
A _v	3,6285e-03	m ²
V _{pl,y,Rd}	743,69	kN
Unity check	0,00	-

Shear check for V_z

According to EN 1993-1-1 article 6.2.6 and formula (6.17)

η	1,20	
A _v	3,6285e-03	m ²
V _{pl,z,Rd}	743,69	kN
Unity check	0,00	-

Torsion check

According to EN 1993-1-1 article 6.2.7 and formula (6.23)

Fibre	1	
T _{Ed}	1,8	MPa
T _{Rd}	205,0	MPa
Unity check	0,01	-

Note: The unity check for torsion is lower than the limit value of 0,05. Therefore torsion is considered as insignificant and is ignored in the combined checks.

Combined bending, axial force and shear force check

According to EN 1993-1-1 article 6.2.9.1 and formula (6.41)

M _{N,y,Rd}	103,46	kNm
α	2,55	
M _{N,x,Rd}	103,46	kNm
β	2,55	

Unity check (5.41) = 0,01 + 0,00 = 0,01

Note: Since the shear forces are less than half the plastic shear resistances their effect on the moment resistances is neglected.

Decision tables for combined section check

Force presence	
Axial force N _{Ed}	Present
Shear force V _{y,Ed}	Not significant
Shear force V _{z,Ed}	Not significant
Torsional moment T _{Ed}	Not significant
Bending moment M _{y,Ed}	Present
Bending moment M _{z,Ed}	Present
Significant shear force without corresponding bending moment	No
Warping data	Not present or negligible

Check inputs	
Classification is supported	Yes
Section classification	Class 1
Elastic verification is set by the user	No
Plastic shear formula is available	Yes
Combined bending and axial force formula is available	Yes
Combined bending and axial force check can be calculated	Yes

Selected check

According to EN 1993-1-1 article 6.2.9.1 and formula (6.41)

The member satisfies the section check.

....:STABILITY CHECK:....

Classification for member buckling design

Decisive position for stability classification: 9,579 m

Classification according to EN 1993-1-1 article 5.5.2

Classification of Internal and Outstand parts according to EN 1993-1-1 Table 5.2 Sheet 1 & 2

Id	Type	c [mm]	t [mm]	σ_1 [kN/m ²]	σ_2 [kN/m ²]	ψ [-]	k_{σ} [-]	α [-]	c/t [-]	Class 1 Limit [-]	Class 2 Limit [-]	Class 3 Limit [-]	Class
1	I	170	10	-1,434e+05	-1,907e+05								
3	I	170	10	-1,809e+05	3,254e+04	-5,56		0,15	17,00	192,14	221,50	780,28	1
5	I	170	10	4,788e+04	9,521e+04	0,50		1,00	17,00	22,78	27,66	37,36	1
7	I	170	10	8,543e+04	-1,280e+05	-1,50		0,40	17,00	73,18	84,36	154,27	1

Note: The Classification limits have been set according to Semi-Comp+.
The cross-section is classified as Class 1

Lateral Torsional Buckling check

According to EN 1993-1-1 article 6.3.2.1

Note: The cross-section concerns an RHS section with 'h / b < 10 / $\lambda_{rel,z}$ '.
This section is thus not susceptible to Lateral Torsional Buckling.

LTB additional parameters		
Minimal z coordinate z_{min}	-100	mm
Maximal z coordinate z_{max}	100	mm
Relative slenderness $\lambda_{rel,z}$	1,55	
End moment ratio ψ	0,08	
Equivalent point load F	-12,63	kN
Equivalent line load q	-1,77	kN/m
Difference with M	316,29	kNm
Difference with F	790,48	kNm
Difference with q	929,62	kNm
Resulting load type	point load F	

The member satisfies the stability check.

4.3.5. REZNE SILE –DONJI POJAS SEKUNDARNOG REŠETKASTOG NOSAČA

My

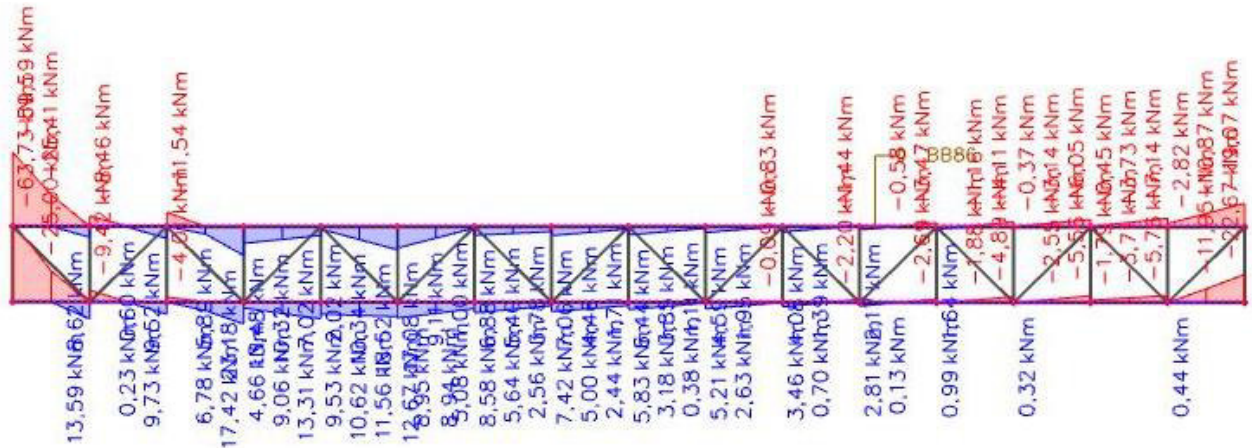

Vz

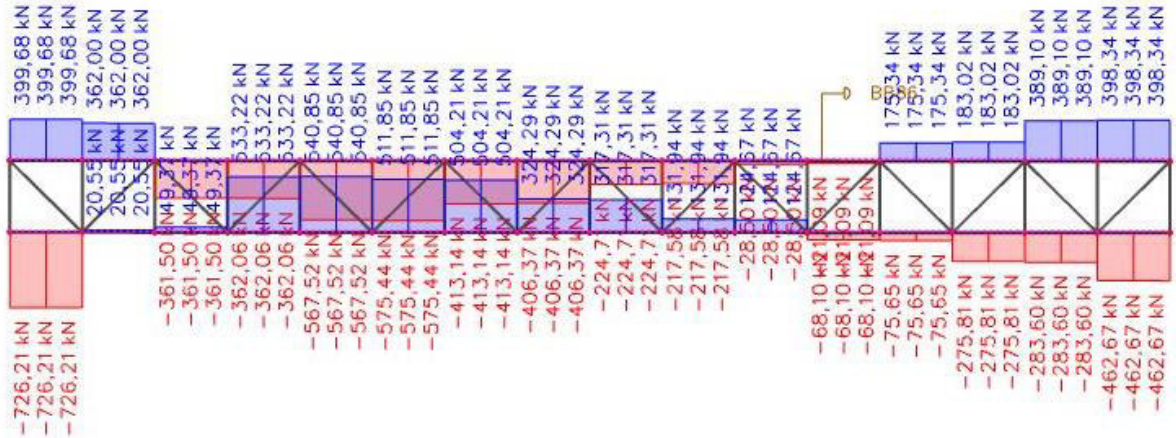

N

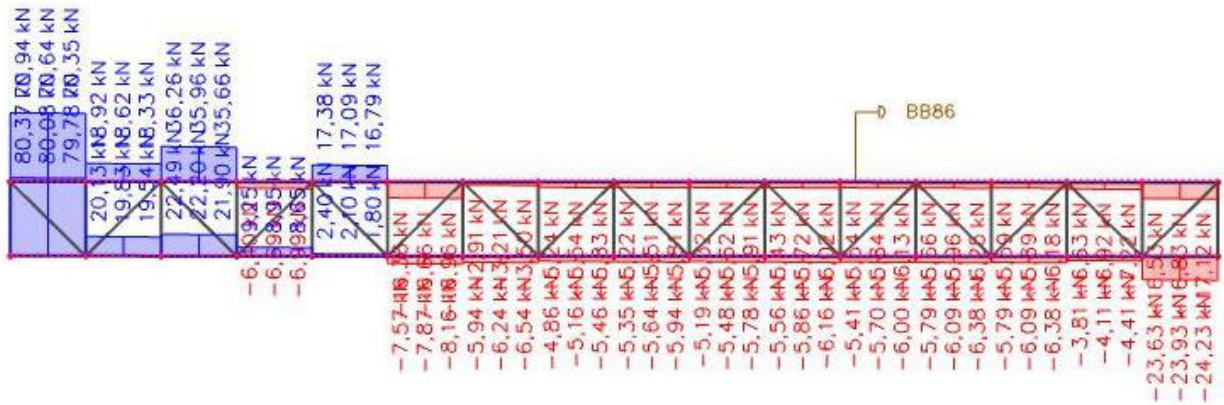

4.3.6. DIMENZIONIRANJE –DONJI POJAS SEKUNDARNOG REŠETKASTOG NOSAČA

EN 1993-1-1 Code Check

National annex: Standard EN

Member B659, **0,000 / 15,450 m**, **CFRHS200X200X8**, **S 355**, **GSN8**, **0,73 -**

Note: EN 1993-1-3 article 1.1(3) specifies that this part does not apply to cold formed CHS and RHS sections. The default EN 1993-1-1 code check is executed instead of the EN 1993-1-3 code check.

Combination key	
GSN8 / 1.35*vlastita težina + 1.50*pokretno + 1.35*dodatno stalno + 0.90*temperatura pozitivna	

Partial safety factors	
γ_{M0} for resistance of cross-sections	1,00
γ_{M1} for resistance to instability	1,00
γ_{M2} for resistance of net sections	1,25

Material		
Yield strength f_y	355,0	MPa
Ultimate strength f_u	490,0	MPa
Fabrication	Cold formed	

....:SECTION CHECK:....

The critical check is on position 0,000 m

Internal forces	Calculated	Unit
N_{Ed}	-728,77	kN
$V_{y,Ed}$	-10,20	kN
$V_{z,Ed}$	80,19	kN
T_{Ed}	-13,53	kNm
$M_{y,Ed}$	-63,69	kNm
$M_{z,Ed}$	5,57	kNm

Classification for cross-section design

Classification according to EN 1993-1-1 article 5.5.2

Classification of Internal and Outstand parts according to EN 1993-1-1 Table 5.2 Sheet 1 & 2

Id	Type	c [mm]	t [mm]	σ_1 [kN/m ²]	σ_2 [kN/m ²]	ψ [-]	k_{σ} [-]	α [-]	c/t [-]	Class 1 Limit [-]	Class 2 Limit [-]	Class 3 Limit [-]	Class
1	I	176	8	2,808e+05	3,083e+05	0,91		1,00	22,00	22,78	27,66	31,91	1
3	I	176	8	2,952e+05	-1,916e+04	-0,06		0,94	22,00	24,61	29,80	49,04	1
5	I	176	8	-3,470e+04	-6,222e+04								
7	I	176	8	-4,917e+04	2,652e+05	-0,19		0,84	22,00	28,17	33,93	52,52	1

Note: The Classification limits have been set according to Semi-Comp+.

The cross-section is classified as Class 1

Compression check

According to EN 1993-1-1 article 6.2.4 and formula (6.9)

A	5,9240e-03	m ²
$N_{c,Rd}$	2103,02	kN
Unity check	0,35	-

Bending moment check for M_y

According to EN 1993-1-1 article 6.2.5 and formula (6.12),(6.13)

W_{ply}	4,2086e-04	m ³
$M_{ply,Rd}$	149,41	kNm
Unity check	0,43	-

Bending moment check for M_z

According to EN 1993-1-1 article 6.2.5 and formula (6.12),(6.13)

W_{plz}	4,2086e-04	m ³
$M_{plz,Rd}$	149,41	kNm
Unity check	0,04	-

Shear check for V_y

According to EN 1993-1-1 article 6.2.6 and formula (6.17)

η	1,20	
A_v	2,9620e-03	m ²
$V_{pl,y,Rd}$	607,09	kN
Unity check	0,02	-

Shear check for V_z

According to EN 1993-1-1 article 6.2.6 and formula (6.17)

η	1,20	
A_v	2,9620e-03	m ²
$V_{pl,z,Rd}$	607,09	kN
Unity check	0,13	-

Torsion check

According to EN 1993-1-1 article 6.2.7 and formula (6.23)

Fibre	1	
T_{Ed}	22,9	MPa
T_{Rd}	205,0	MPa
Unity check	0,11	-

Combined Shear and Torsion check for V_y and $\tau_{t,Ed}$

According to EN 1993-1-1 article 6.2.6 & 6.2.7 and formula (6.25),(6.28)

$V_{pl,Ty,Rd}$	539,15	kN
Unity check	0,02	-

Combined Shear and Torsion check for V_z and $\tau_{t,Ed}$

According to EN 1993-1-1 article 6.2.6 & 6.2.7 and formula (6.25),(6.28)

$V_{pl,Tz,Rd}$	539,15	kN
Unity check	0,15	-

Combined bending, axial force and shear force check

According to EN 1993-1-1 article 6.2.9.1 and formula (6.41)

$M_{N,y,Rd}$	126,78	kNm
α	1,92	
$M_{N,z,Rd}$	126,78	kNm
β	1,92	

Unity check (6.41) = 0,27 + 0,00 = 0,27 -

Decision tables for combined section check

Force presence	
Axial force N_{Ed}	Present
Shear force $V_{y,Ed}$	Not significant
Shear force $V_{z,Ed}$	Not significant
Torsional moment T_{Ed}	Present
Bending moment $M_{y,Ed}$	Present
Bending moment $M_{z,Ed}$	Present
Significant shear force without corresponding bending moment	No
Torsional moment without shear force	No
Warping data	Not present or negligible

Check inputs	
Classification is supported	Yes
Section classification	Class 1
Elastic verification is set by the user	No
Plastic shear formula is available	Yes
Combined shear and torsion formula is available	Yes
Combined shear and torsion check can be calculated	Yes
Combined bending and axial force formula is available	Yes
Combined bending and axial force check can be calculated	Yes

Selected check
According to EN 1993-1-1 article 6.2.9.1 and formula (6.41)

The member satisfies the section check.

...:STABILITY CHECK:...:

Classification for member buckling design

Decisive position for stability classification: 0,000 m

Classification according to EN 1993-1-1 article 5.5.2

Classification of Internal and Outstand parts according to EN 1993-1-1 Table 5.2 Sheet 1 & 2

Id	Type	c [mm]	t [mm]	σ_1 [kN/m ²]	σ_2 [kN/m ²]	ψ [-]	k_σ [-]	α [-]	c/t [-]	Class 1 Limit [-]	Class 2 Limit [-]	Class 3 Limit [-]	Class
1	I	176	8	2,808e+05	3,083e+05	0,91		1,00	22,00	22,78	27,66	31,91	1
3	I	176	8	2,952e+05	-1,916e+04	-0,06		0,94	22,00	24,61	29,80	49,04	1
5	I	176	8	-3,470e+04	-6,222e+04								
7	I	176	8	-4,917e+04	2,652e+05	-0,19		0,84	22,00	28,17	33,93	52,52	1

Note: The Classification limits have been set according to Semi-Comp+.
The cross-section is classified as Class 1

Flexural Buckling check

According to EN 1993-1-1 article 6.3.1.1 and formula (6.46)

Buckling parameters	yy	zz	
Sway type	sway	non-sway	
System length L	0,966	21,120	m
Buckling factor k	0,98	0,04	
Buckling length L_{cr}	0,950	0,950	m
Critical Euler load N_{cr}	81899,95	81899,95	kN
Slenderness λ	12,24	12,24	
Relative slenderness λ_{rel}	0,16	0,16	
Limit slenderness $\lambda_{rel,0}$	0,20	0,20	

Note: The slenderness or compression force is such that Flexural Buckling effects may be ignored according to EN 1993-1-1 article 6.3.1.2(4).

Torsional(-Flexural) Buckling check

According to EN 1993-1-1 article 6.3.1.1 and formula (6.46)

Note: The cross-section concerns a RHS section which is not susceptible to Torsional(-Flexural) Buckling.

Lateral Torsional Buckling check

According to EN 1993-1-1 article 6.3.2.1

Note: The cross-section concerns an RHS section with ' $h/b < 10 / \lambda_{rel,z}$ '.

This section is thus not susceptible to Lateral Torsional Buckling.

LTB additional parameters		
Minimal z coordinate z_{min}	-100	mm
Maximal z coordinate z_{max}	100	mm
Relative slenderness $\lambda_{rel,z}$	0,16	
End moment ratio ψ	-0,02	
Equivalent point load F	12,47	kN
Equivalent line load q	1,18	kN/m
Difference with M	1398,68	kNm
Difference with F	1073,14	kNm
Difference with q	1246,86	kNm
Resulting load type	point load F	

Bending and axial compression check

According to EN 1993-1-1 article 6.3.3 and formula (6.61)/(6.62)

Bending and axial compression check parameters		
Interaction method	alternative method 1	
Cross-section area A	5,9240e-03	m ²
Plastic section modulus $W_{pl,y}$	4,2086e-04	m ³
Plastic section modulus $W_{pl,z}$	4,2086e-04	m ³
Design compression force N_{Ed}	728,77	kN
Design bending moment (maximum) $M_{y,Ed}$	-63,69	kNm
Design bending moment (maximum) $M_{z,Ed}$	-26,23	kNm
Characteristic compression resistance N_{Rk}	2103,02	kN
Characteristic moment resistance $M_{y,Rk}$	149,41	kNm
Characteristic moment resistance $M_{z,Rk}$	149,41	kNm
Reduction factor χ_y	1,00	
Reduction factor χ_z	1,00	
Reduction factor χ_{LT}	1,00	
Interaction factor k_{FT}	0,67	
Interaction factor k_{Fz}	0,54	
Interaction factor k_{Fy}	0,40	
Interaction factor k_{FT}	0,90	

Maximum moment $M_{y,Ed}$ is derived from beam B659 position 0,000 m.

Maximum moment $M_{z,Ed}$ is derived from beam B659 position 2,897 m.

Interaction method 1 parameters		
Critical Euler load $N_{cr,y}$	81899,95	kN
Critical Euler load $N_{cr,z}$	81899,95	kN
Elastic critical load $N_{cr,T}$	390188,10	kN
Plastic section modulus $W_{pl,y}$	4,2086e-04	m ³
Elastic section modulus $W_{el,y}$	3,5663e-04	m ³
Plastic section modulus $W_{pl,z}$	4,2086e-04	m ³
Elastic section modulus $W_{el,z}$	3,5663e-04	m ³
Second moment of area I_y	3,5662e-05	m ⁴
Second moment of area I_z	3,5662e-05	m ⁴
Torsional constant I_t	5,8152e-05	m ⁴
Method for equivalent moment factor $C_{my,0}$	Table A.2 Line 1 (Linear)	
Ratio of end moments ψ_T	-0,21	
Equivalent moment factor $C_{my,0}$	0,74	
Method for equivalent moment factor $C_{mz,0}$	Table A.2 Line 2 (General)	
Design bending moment (maximum) $M_{z,Ed}$	-26,23	kNm
Maximum relative deflection δ_y	-8,8	mm
Equivalent moment factor $C_{mz,0}$	0,99	

Interaction method 1 parameters		
Factor μ_x	1,00	
Factor μ_z	1,00	
Factor E_p	1,45	
Factor a_{LT}	0,00	
Critical moment for uniform bending $M_{cr,0}$	882,30	kNm
Relative slenderness $\lambda_{rel,0}$	0,41	
Limit relative slenderness $\lambda_{rel,0,lim}$	0,33	
Equivalent moment factor C_{my}	0,74	
Equivalent moment factor C_{mz}	0,99	
Equivalent moment factor $C_{mi,LT}$	1,00	
Factor b_{LT}	0,00	
Factor c_{LT}	0,00	
Factor d_{LT}	0,00	
Factor e_{LT}	0,00	
Factor w_y	1,18	
Factor w_z	1,18	
Factor η_{pl}	0,35	
Maximum relative slenderness $\lambda_{rel,max}$	0,16	
Factor C_{yy}	1,12	
Factor C_{yz}	1,12	
Factor C_{zy}	1,12	
Factor C_{zz}	1,11	

Unity check (6.61) = $0,35 + 0,29 + 0,09 = 0,73$ -

Unity check (6.62) = $0,35 + 0,17 + 0,16 = 0,68$ -

The member satisfies the stability check.

4.3.7. REZNE SILE-ISPUNA SEKUNDARNOG REŠETKASTOG NOSAČA

N



4.3.8. DIMENZIONIRANJE-ISPUNA SEKUNDARNOG REŠETKASTOG NOSAČA

EN 1993-1-1 Code Check

National annex: Standard EN

Member B2778 0,000 / 1,355 m CFRHS140X140X6 S 355 GSN8 0,31 -

Note: EN 1993-1-3 article 1.1(3) specifies that this part does not apply to cold formed CHS and RHS sections. The default EN 1993-1-1 code check is executed instead of the EN 1993-1-3 code check.

Combination key	
GSN8 / 1.35*vlastita težina + 1.50*pokretno + 1.35*dodatno stalno + 0.90*temperatura pozitivna	

Partial safety factors	
γ_{M0} for resistance of cross-sections	1,00
γ_{M1} for resistance to instability	1,00
γ_{M2} for resistance of net sections	1,25

Material		
Yield strength f_y	355,0	MPa
Ultimate strength f_u	490,0	MPa
Fabrication	Cold formed	

....SECTION CHECK:....

The critical check is on position 0,000 m

Internal forces	Calculated	Unit
N_{Ed}	-140,59	kN
$V_{y,Ed}$	0,38	kN
$V_{z,Ed}$	-1,43	kN
T_{Ed}	0,18	kNm
$M_{y,Ed}$	0,39	kNm
$M_{z,Ed}$	1,46	kNm

Classification for cross-section design

Classification according to EN 1993-1-1 article 5.5.2

Classification of Internal and Outstand parts according to EN 1993-1-1 Table 5.2 Sheet 1 & 2

Id	Type	c [mm]	t [mm]	σ_1 [kN/m ²]	σ_2 [kN/m ²]	ψ [-]	k_σ [-]	α [-]	c/t [-]	Class 1 Limit [-]	Class 2 Limit [-]	Class 3 Limit [-]	Class
1	I	122	6	3,249e+04	5,190e+04	0,63		1,00	20,33	22,78	27,66	35,53	1
3	I	122	6	5,311e+04	5,825e+04	0,91		1,00	20,33	22,78	27,66	31,89	1
5	I	122	6	5,755e+04	3,813e+04	0,66		1,00	20,33	22,78	27,66	35,02	1
7	I	122	6	3,693e+04	3,178e+04	0,86		1,00	20,33	22,78	27,66	32,49	1

Note: The Classification limits have been set according to Semi-Comp+. The cross-section is classified as Class 1

Compression check

According to EN 1993-1-1 article 6.2.4 and formula (6.9)

A	3,1230e-03	m ²
$N_{c,Rd}$	1108,66	kN
Unity check	0,13	-

Bending moment check for M_y

According to EN 1993-1-1 article 6.2.5 and formula (6.12),(6.13)

W_{ply}	1,5533e-04	m^3
$M_{ply,Rd}$	55,14	kNm
Unity check	0,01	-

Bending moment check for M_z

According to EN 1993-1-1 article 6.2.5 and formula (6.12),(6.13)

$W_{pl,z}$	1,5533e-04	m^3
$M_{pl,z,Rd}$	55,14	kNm
Unity check	0,03	-

Shear check for V_y

According to EN 1993-1-1 article 6.2.6 and formula (6.17)

η	1,20	
A_v	1,5615e-03	m^2
$V_{pl,y,Rd}$	320,04	kN
Unity check	0,00	-

Shear check for V_z

According to EN 1993-1-1 article 6.2.6 and formula (6.17)

η	1,20	
A_v	1,5615e-03	m^2
$V_{pl,z,Rd}$	320,04	kN
Unity check	0,00	-

Torsion check

According to EN 1993-1-1 article 6.2.7 and formula (6.23)

Fibre	1	
T_{Ed}	0,8	MPa
T_{Rd}	205,0	MPa
Unity check	0,00	-

Note: The unity check for torsion is lower than the limit value of 0,05. Therefore torsion is considered as insignificant and is ignored in the combined checks.

Combined bending, axial force and shear force check

According to EN 1993-1-1 article 6.2.9.1 and formula (6.41)

$M_{N,y,Rd}$	55,14	kNm
α	1,69	
$M_{N,z,Rd}$	55,14	kNm
β	1,69	

Unity check (6.41) = 0,00 + 0,00 = 0,00 -

Note: Since the shear forces are less than half the plastic shear resistances their effect on the moment resistances is neglected.

Decision tables for combined section check

Force presence	
Axial force N_{Ed}	Present
Shear force $V_{y,Ed}$	Not significant
Shear force $V_{z,Ed}$	Not significant
Torsional moment T_{Ed}	Not significant
Bending moment $M_{y,Ed}$	Present
Bending moment $M_{z,Ed}$	Present
Significant shear force without corresponding bending moment	No
Warping data	Not present or negligible

Check inputs	
Classification is supported	Yes
Section classification	Class 1
Elastic verification is set by the user	No
Plastic shear formula is available	Yes
Combined bending and axial force formula is available	Yes
Combined bending and axial force check can be calculated	Yes

Selected check
According to EN 1993-1-1 article 6.2.9.1 and formula (6.41)

The member satisfies the section check.

...:STABILITY CHECK:...:

Classification for member buckling design

Decisive position for stability classification: 1,355 m

Classification according to EN 1993-1-1 article 5.5.2

Classification of Internal and Outstand parts according to EN 1993-1-1 Table 5.2 Sheet 1 & 2

Id	Type	c [mm]	t [mm]	σ_1 [kN/m ²]	σ_2 [kN/m ²]	ψ [-]	k_{cr} [-]	α [-]	c/t [-]	Class 1 Limit [-]	Class 2 Limit [-]	Class 3 Limit [-]	Class
1	I	122	6	4,460e+04	7,088e+04	0,63		1,00	20,33	22,78	27,66	35,48	1
3	I	122	6	7,102e+04	4,768e+04	0,67		1,00	20,33	22,78	27,66	34,90	1
5	I	122	6	4,524e+04	1,896e+04	0,42		1,00	20,33	22,78	27,66	38,72	1
7	I	122	6	1,882e+04	4,216e+04	0,45		1,00	20,33	22,78	27,66	38,27	1

Note: The Classification limits have been set according to Semi-Comp+.
The cross-section is classified as Class 1

Flexural Buckling check

According to EN 1993-1-1 article 6.3.1.1 and formula (6.46)

Buckling parameters	yy	zz	
Sway type	sway	non-sway	
System length L	1,355	1,355	m
Buckling factor k	3,27	0,91	
Buckling length L_{cr}	4,435	1,231	m
Critical Euler load N_{cr}	969,80	12593,43	kN
Slenderness λ	81,70	22,67	
Relative slenderness λ_{rel}	1,07	0,30	
Limit slenderness $\lambda_{rel,0}$	0,20	0,20	
Buckling curve	c	c	
Imperfection α	0,49	0,49	
Reduction factor χ	0,50	0,95	
Buckling resistance $N_{b,Rd}$	555,30	1054,15	kN

Flexural Buckling verification

Cross-section area A	3,1230e-03	m ²
Buckling resistance $N_{b,Rd}$	555,30	kN
Unity check	0,25	-

Torsional(-Flexural) Buckling check

According to EN 1993-1-1 article 6.3.1.1 and formula (6.46)

Note: The cross-section concerns a RHS section which is not susceptible to Torsional(-Flexural) Buckling.

Lateral Torsional Buckling check

According to EN 1993-1-1 article 6.3.2.1

Note: The cross-section concerns an RHS section with $h/b < 10 / \lambda_{rel,z}$.
This section is thus not susceptible to Lateral Torsional Buckling.

LTB additional parameters		
Minimal z coordinate z_{min}	-70	mm
Maximal z coordinate z_{max}	70	mm
Relative slenderness $\lambda_{rel,z}$	0,30	
End moment ratio ψ	-0,22	
Equivalent point load F	0,16	kN
Equivalent line load q	0,23	kN/m
Difference with M	0,05	kNm
Difference with F	0,00	kNm
Difference with q	0,00	kNm
Resulting load type	point load F	

Bending and axial compression check

According to EN 1993-1-1 article 6.3.3 and formula (6.61),(6.62)

Bending and axial compression check parameters		
Interaction method	alternative method 1	
Cross-section area A	3,1230e-03	m ²
Plastic section modulus $W_{pl,y}$	1,5533e-04	m ³
Plastic section modulus $W_{pl,z}$	1,5533e-04	m ³
Design compression force N_{Ed}	140,59	kN
Design bending moment (maximum) $M_{y,Ed}$	-1,76	kNm
Design bending moment (maximum) $M_{z,Ed}$	1,98	kNm
Characteristic compression resistance N_{Rk}	1108,66	kN
Characteristic moment resistance $M_{y,Rk}$	55,14	kNm
Characteristic moment resistance $M_{z,Rk}$	55,14	kNm
Reduction factor χ_y	0,50	
Reduction factor χ_z	0,95	
Reduction factor χ_{LT}	1,00	
Interaction factor k_{yy}	1,00	
Interaction factor k_{yz}	0,59	
Interaction factor k_{zy}	0,71	
Interaction factor k_{zz}	0,97	

Maximum moment $M_{y,Ed}$ is derived from beam B2778 position 1,355 m.

Maximum moment $M_{z,Ed}$ is derived from beam B2778 position 1,355 m.

Interaction method 1 parameters		
Critical Euler load $N_{cr,y}$	969,80	kN
Critical Euler load $N_{cr,z}$	12593,43	kN
Elastic critical load $N_{cr,T}$	207780,23	kN

Interaction method 1 parameters		
Plastic section modulus $W_{pl,y}$	1,5533e-04	m ³
Elastic section modulus $W_{el,y}$	1,3149e-04	m ³
Plastic section modulus $W_{pl,z}$	1,5533e-04	m ³
Elastic section modulus $W_{el,z}$	1,3149e-04	m ³
Second moment of area I_y	9,2043e-06	m ⁴
Second moment of area I_z	9,2043e-06	m ⁴
Torsional constant I_t	1,4788e-05	m ⁴
Method for equivalent moment factor $C_{my,0}$	Table A.2 Line 2 (General)	
Design bending moment (maximum) $M_{y,Ed}$	-1,76	kNm
Maximum relative deflection δ_z	0,1	mm
Equivalent moment factor $C_{my,0}$	0,92	
Method for equivalent moment factor $C_{mz,0}$	Table A.2 Line 1 (Linear)	
Ratio of end moments ψ_z	0,74	
Equivalent moment factor $C_{mz,0}$	0,95	
Factor μ_y	0,92	
Factor μ_z	1,00	
Factor ϵ_y	0,30	
Factor a_{LT}	0,00	
Critical moment for uniform bending $M_{cr,0}$	3568,38	kNm
Relative slenderness $\lambda_{rel,0}$	0,12	
Limit relative slenderness $\lambda_{rel,0,lim}$	0,29	
Equivalent moment factor C_{my}	0,92	
Equivalent moment factor C_{mz}	0,95	
Equivalent moment factor C_{mLT}	1,00	
Factor b_{LT}	0,00	
Factor c_{LT}	0,00	
Factor d_{LT}	0,00	
Factor e_{LT}	0,00	
Factor w_y	1,18	
Factor w_z	1,18	
Factor η_{pl}	0,13	
Maximum relative slenderness $\lambda_{rel,max}$	1,07	
Factor C_{y1}	0,99	
Factor C_{y2}	0,90	
Factor C_{z1}	0,91	
Factor C_{z2}	0,98	

Unity check (5.61) = 0,25 + 0,03 + 0,02 = 0,31

Unity check (6.62) = 0,13 + 0,02 + 0,03 = 0,19

The member satisfies the stability check.

4.3.9. REZNE SILE-SEKUNDARNI NOSAČ 1

My

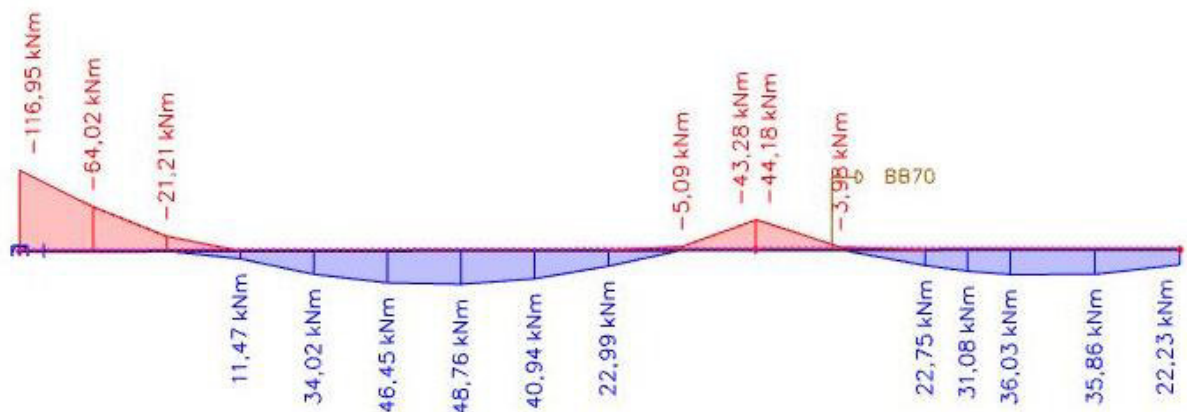

Vz

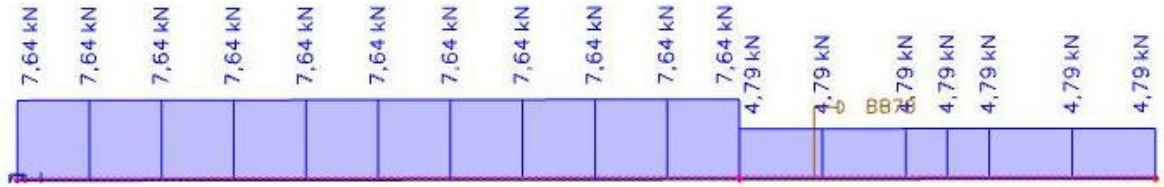

N

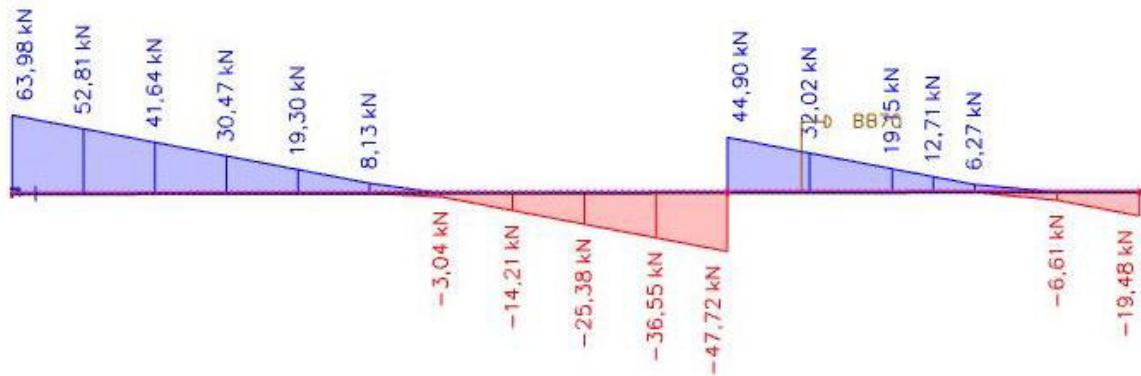

4.3.10. DIMENZIONIRANJE-SEKUNDARNI NOSAČ 1

EN 1993-1-1 Code Check
National annex: Standard EN

Member B4-593 0,000 / 14,290 m HEA200 S 355 GSN8 0,81 -

Combination key
GSN8 / 1.35*vlastita težina + 1.50*pokretno +
1.35*dodatno stalno + 0.90*temperatura pozitivna

Partial safety factors	
γ_{M0} for resistance of cross-sections	1,00
γ_{M1} for resistance to instability	1,00
γ_{M2} for resistance of net sections	1,25

Material	
Yield strength f_y	355,0 MPa
Ultimate strength f_u	490,0 MPa
Fabrication	Rolled

....:SECTION CHECK:....

The critical check is on position 0,000 m

Internal forces	Calculated	Unit
N_{Ed}	7,61	kN
$V_{y,Ed}$	0,85	kN
$V_{z,Ed}$	63,98	kN
T_{Ed}	0,00	kNm
$M_{y,Ed}$	-116,95	kNm
$M_{z,Ed}$	-3,54	kNm

Classification for cross-section design

Classification according to EN 1993-1-1 article 5.5.2

Classification of Internal and Outstand parts according to EN 1993-1-1 Table 5.2 Sheet 1 & 2

Id	Type	c [mm]	t [mm]	σ_1 [kN/m ²]	σ_2 [kN/m ²]	ψ [-]	k_σ [-]	α [-]	c/t [-]	Class 1 Limit [-]	Class 2 Limit [-]	Class 3 Limit [-]	Class
1	SO	79	10	2,892e+05	3,101e+05	0,93	0,44	1,00	7,88	7,32	8,14	11,27	2
3	SO	79	10	2,780e+05	2,571e+05	0,92	0,46	1,00	7,88	7,32	8,14	11,55	2
4	I	134	7	2,108e+05	-2,136e+05	-1,01		0,49	20,62	60,06	69,23	102,24	1
5	SO	79	10	-2,921e+05	-3,129e+05								
7	SO	79	10	-2,808e+05	-2,599e+05								

Note: The Classification limits have been set according to Semi-Comp+. The cross-section is classified as Class 2

Tension check

According to EN 1993-1-1 article 6.2.3 and formula (6.5)

A	5,3800e-03	m ²
$N_{pl,Rd}$	1909,90	kN
$N_{u,Rd}$	1898,06	kN
$N_{t,Rd}$	1898,06	kN
Unity check	0,00	-

Bending moment check for M_y

According to EN 1993-1-1 article 6.2.5 and formula (6.12),(6.13)

W_{ply}	4,2917e-04	m ³
$M_{ply,Rd}$	152,35	kNm
Unity check	0,77	-

Bending moment check for M_z

According to EN 1993-1-1 article 6.2.5 and formula (6.12),(6.13)

$W_{pl,z}$	2,0375e-04	m ³
$M_{pl,z,Rd}$	72,33	kNm
Unity check	0,05	-

Shear check for V_y

According to EN 1993-1-1 article 6.2.6 and formula (6.17)

η	1,20	
A_v	4,1592e-03	m ²
$V_{ply,Rd}$	852,48	kN
Unity check	0,00	-

Shear check for V_z

According to EN 1993-1-1 article 6.2.6 and formula (6.17)

η	1,20	
A_v	1,8050e-03	m ²
$V_{pl,z,Rd}$	369,95	kN
Unity check	0,17	-

Combined bending, axial force and shear force check

According to EN 1993-1-1 article 6.2.9.1 and formula (6.41)

$M_{pl,y,Rd}$	152,35	kNm
α	2,00	
$M_{pl,z,Rd}$	72,33	kNm
β	1,00	

Unity check (6.41) = $0,59 + 0,05 = 0,64$

Note: Since the shear forces are less than half the plastic shear resistances their effect on the moment resistances is neglected.

Note: Since the axial force satisfies both criteria (6.33) and (6.34) of EN 1993-1-1 article 6.2.9.1(4) its effect on the moment resistance about the y-y axis is neglected.

Note: Since the axial force satisfies criteria (6.35) of EN 1993-1-1 article 6.2.9.1(4) its effect on the moment resistance about the z-z axis is neglected.

Decision tables for combined section check

Force presence	
Axial force N_{Ed}	Present
Shear force $V_{y,Ed}$	Not significant
Shear force $V_{z,Ed}$	Not significant
Torsional moment T_{Ed}	Not present
Bending moment $M_{y,Ed}$	Present
Bending moment $M_{z,Ed}$	Present
Significant shear force without corresponding bending moment	No
Warping data	Not present or negligible

Check inputs	
Classification is supported	Yes
Section classification	Class 2
Elastic verification is set by the user	No
Plastic shear formula is available	Yes
Combined bending and axial force formula is available	Yes
Combined bending and axial force check can be calculated	Yes

Selected check
According to EN 1993-1-1 article 6.2.9.1 and formula (6.41)

The member satisfies the section check.

....STABILITY CHECK....

Classification for member buckling design

Decisive position for stability classification: 0,000 m

Classification according to EN 1993-1-1 article 5.5.2

Classification of Internal and Outstand parts according to EN 1993-1-1 Table 5.2 Sheet 1 & 2

Id	Type	c [mm]	t [mm]	σ_1 [kN/m ²]	σ_2 [kN/m ²]	ψ [-]	k_o [-]	α [-]	c/t [-]	Class 1 Limit [-]	Class 2 Limit [-]	Class 3 Limit [-]	Class
1	SO	79	10	2,892e+05	3,101e+05	0,93	0,44	1,00	7,88	7,32	8,14	11,27	2
3	SO	79	10	2,780e+05	2,571e+05	0,92	0,46	1,00	7,88	7,32	8,14	11,55	2
4	I	134	7	2,108e+05	-2,136e+05	-1,01		0,49	20,62	60,06	69,23	102,24	1
5	SO	79	10	-2,921e+05	-3,129e+05								
7	SO	79	10	-2,808e+05	-2,599e+05								

Note: The Classification limits have been set according to Semi-Comp+. The cross-section is classified as Class 2

Lateral Torsional Buckling check

According to EN 1993-1-1 article 6.3.2.1 & 6.3.2.3 and formula (6.54)

LTB parameters		
Method for LTB curve	Alternative case	
Plastic section modulus $W_{pl,y}$	4,2917e-04	m ³
Elastic critical moment M_{cr}	248,49	kNm
Relative slenderness $\lambda_{rel,LT}$	0,78	
Limit slenderness $\lambda_{rel,LT,0}$	0,40	
LTB curve	b	
Imperfection α_{LT}	0,34	
LTB factor β	0,75	
Reduction factor χ_{LT}	0,83	
Correction factor k_c	0,57	
Correction factor f	0,79	
Modified reduction factor $\chi_{LT,mod}$	1,00	
Design buckling resistance $M_{b,Rd}$	152,35	kNm
Unity check	0,77	
Mcr parameters		
LTB length L	9,065	m
Influence of load position	no influence	

Mcr parameters		
Correction factor k	1,00	
Correction factor k_{α}	1,00	
LTB moment factor C_1	3,05	
LTB moment factor C_2	1,32	
LTB moment factor C_3	0,41	
Shear center distance d_z	0	mm
Distance of load application z_g	0	mm
Mono-symmetry constant β_y	0	mm
Mono-symmetry constant z_j	0	mm

Note: C parameters are determined according to ECCS 119 2006 / Galea 2002.

Note: The correction factor k_c is determined from C_1 .

LTB additional parameters		
Minimal z coordinate z_{min}	-95	mm
Maximal z coordinate z_{max}	95	mm
End moment ratio ψ	0,37	
Equivalent point load F	55,85	kN
Equivalent line load q	12,32	kN/m
Difference with M	835,38	kNm
Difference with F	202,52	kNm
Difference with q	0,00	kNm
Resulting load type	line load q	

Bending and axial tension check

According to EN 1993-1-3 article 6.3

Design tension force N_{Ed}	7,61	kN
Design bending moment $M_{y,Ed}$	-116,95	kNm
Design bending moment $M_{z,Ed}$	-3,54	kNm
Tension resistance $N_{t,Rd}$	1898,06	kN
Bending resistance $M_{b,y,Rd}$	152,35	kNm
Bending resistance $M_{c,z,Rd,com}$	72,33	kNm

Unity check = $0,77 + 0,05 - 0,00 = 0,81$

Shear Buckling check

According to EN 1993-1-5 article 5 & 7.1 and formula (5.10) & (7.1)

Shear Buckling parameters		
Buckling field length a	14,290	m
Web	unstiffened	
Web height h_w	170	mm
Web thickness t	7	mm
Material coefficient ϵ	0,81	
Shear correction factor η	1,20	

Shear Buckling verification		
Web slenderness h_w/t	26,15	
Web slenderness limit	48,82	

Note: The web slenderness is such that Shear Buckling effects may be ignored according to EN 1993-1-5 article 5.1(2).

The member satisfies the stability check.

4.4. DIMENZIONIRANJE PROSTORA ZA BALET- POZICIJA 300

4.4.1. REZNE SILE-GORNJI POJAS GLAVNOG REŠETKASTOG NOSAČA

My

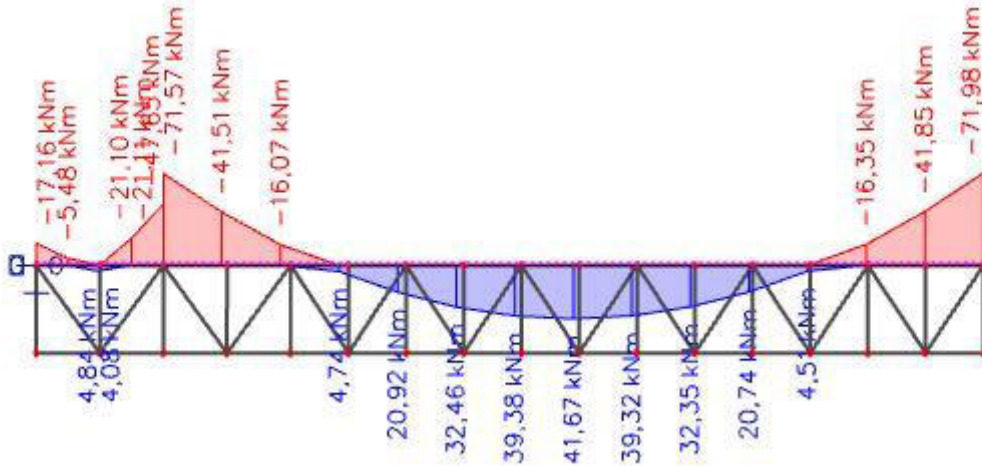

Vz

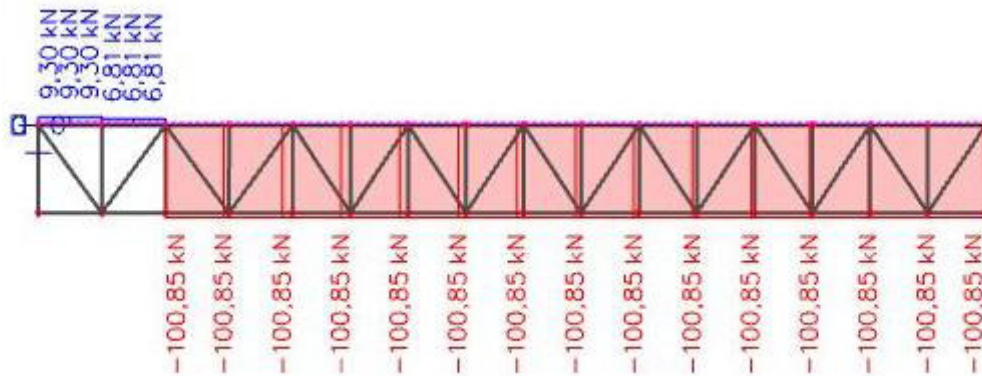

N

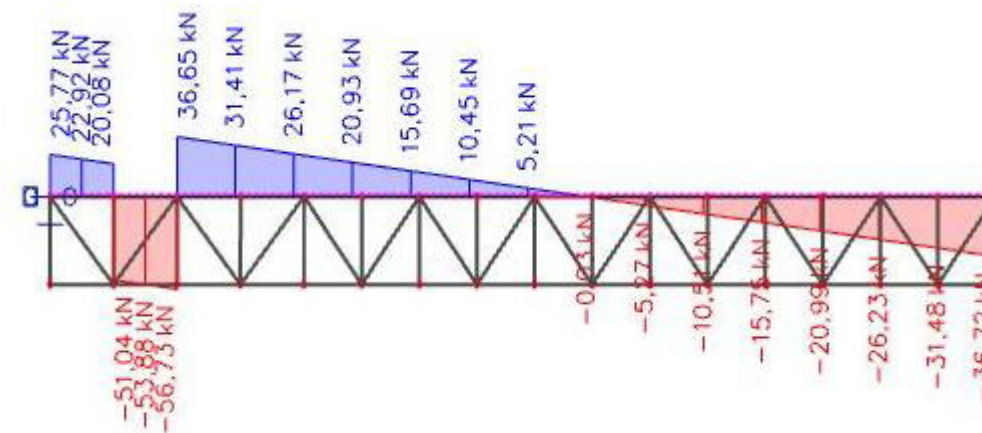

4.4.2. DIMENZIONIRANJE-GORNJI POJAS GLAVNOG REŠETKASTOG NOSAČA

EC-EN 1993 Steel check ULS

Linear calculation

Combination: GSN8

Coordinate system: Principal

Extreme 1D: Member

Selection: B4525, B4526, B4759, B4760

EN 1993-1-1 Code Check

National annex: Standard EN

Member B4525 | **14,290 / 14,290 m** | **CFRHS200X200X10** | **S 355** | **GSN8** | **0,89 -**

Note: EN 1993-1-3 article 1.1(3) specifies that this part does not apply to cold formed CHS and RHS sections. The default EN 1993-1-1 code check is executed instead of the EN 1993-1-3 code check.

Combination key	
GSN8 / 1.35*vlastita težina + 1.50*pokretno + 1.35*dodatno stalno + 0.90*temperatura pozitivna	

Partial safety factors	
γ_{M0} for resistance of cross-sections	1,00
γ_{M1} for resistance to instability	1,00
γ_{M2} for resistance of net sections	1,25

Material		
Yield strength f_y	355,0	MPa
Ultimate strength f_u	490,0	MPa
Fabrication	Cold formed	

....SECTION CHECK:....

The critical check is on position 14,290 m

Internal forces	Calculated	Unit
N_{Ed}	-99,44	kN
$V_{y,Ed}$	0,02	kN
$V_{z,Ed}$	-36,82	kN
T_{Ed}	-0,26	kNm
$M_{y,Ed}$	-72,71	kNm
$M_{z,Ed}$	0,07	kNm

Classification for cross-section design

Classification according to EN 1993-1-1 article 5.5.2

Classification of Internal and Outstand parts according to EN 1993-1-1 Table 5.2 Sheet 1 & 2

Id	Type	c [mm]	t [mm]	σ_1 [kN/m ²]	σ_2 [kN/m ²]	ψ [-]	k_{σ} [-]	α [-]	c/t [-]	Class 1 Limit [-]	Class 2 Limit [-]	Class 3 Limit [-]	Class
1	I	170	10	1,761e+05	1,764e+05	1,00		1,00	17,00	22,78	27,66	30,94	1
3	I	170	10	1,593e+05	-1,316e+05	-0,83		0,55	17,00	50,95	59,37	84,38	1
5	I	170	10	-1,487e+05	-1,490e+05								
7	I	170	10	-1,319e+05	1,590e+05	-0,83		0,55	17,00	51,10	59,54	84,68	1

Note: The Classification limits have been set according to Semi-Comp+.

The cross-section is classified as Class 1

Compression check

According to EN 1993-1-1 article 6.2.4 and formula (6.9)

A	7,2570e-03	m ²
$N_{c,Rd}$	2576,24	kN
Unity check	0,04	-

Bending moment check for M_y

According to EN 1993-1-1 article 6.2.5 and formula (6.12),(6.13)

W_{ply}	5,0808e-04	m ³
$M_{ply,Rd}$	180,37	kNm
Unity check	0,40	-

Bending moment check for M_z

According to EN 1993-1-1 article 6.2.5 and formula (6.12),(6.13)

$W_{pl,z}$	5,0808e-04	m ³
$M_{pl,z,Rd}$	180,37	kNm
Unity check	0,00	-

Shear check for V_y

According to EN 1993-1-1 article 6.2.6 and formula (6.17)

η	1,20	
A_v	3,6285e-03	m ²
$V_{ply,Rd}$	743,69	kN
Unity check	0,00	-

Shear check for V_z

According to EN 1993-1-1 article 6.2.6 and formula (6.17)

η	1,20	
A_v	3,6285e-03	m ²
$V_{pl,z,Rd}$	743,69	kN
Unity check	0,05	-

Torsion check

According to EN 1993-1-1 article 6.2.7 and formula (6.23)

Fibre	1	
T_{Ed}	0,4	MPa
T_{Rd}	205,0	MPa
Unity check	0,00	-

Note: The unity check for torsion is lower than the limit value of 0,05. Therefore torsion is considered as insignificant and is ignored in the combined checks.

Combined bending, axial force and shear force check

According to EN 1993-1-1 article 6.2.9.1 and formula (6.41)

$M_{N,y,Rd}$	180,37	kNm
α	1,66	
$M_{N,z,Rd}$	180,37	kNm
β	1,66	

Unity check (6.41) = 0,22 + 0,00 = 0,22 -

Note: Since the shear forces are less than half the plastic shear resistances their effect on the moment resistances is neglected.

Decision tables for combined section check

Force presence	
Axial force N_{Ed}	Present
Shear force $V_{y,Ed}$	Not significant
Shear force $V_{z,Ed}$	Not significant
Torsional moment T_{Ed}	Not significant
Bending moment $M_{y,Ed}$	Present
Bending moment $M_{z,Ed}$	Present
Significant shear force without corresponding bending moment	No
Warping data	Not present or negligible

Check inputs	
Classification is supported	Yes
Section classification	Class 1
Elastic verification is set by the user	No
Plastic shear formula is available	Yes
Combined bending and axial force formula is available	Yes
Combined bending and axial force check can be calculated	Yes

Selected check
According to EN 1993-1-1 article 6.2.9.1 and formula (6.41)

The member satisfies the section check.

...:STABILITY CHECK:...:

Classification for member buckling design

Decisive position for stability classification: 14,290 m

Classification according to EN 1993-1-1 article 5.5.2

Classification of Internal and Outstand parts according to EN 1993-1-1 Table 5.2 Sheet 1 & 2

Id	Type	c [mm]	t [mm]	σ_1 [kN/m ²]	σ_2 [kN/m ²]	ψ [-]	k_α [-]	α [-]	c/t [-]	Class 1 Limit [-]	Class 2 Limit [-]	Class 3 Limit [-]	Class
1	I	170	10	1,761e+05	1,764e+05	1,00		1,00	17,00	22,78	27,66	30,94	1
3	I	170	10	1,593e+05	-1,316e+05	-0,83		0,55	17,00	50,95	59,37	84,38	1
5	I	170	10	-1,487e+05	-1,490e+05								
7	I	170	10	-1,319e+05	1,590e+05	-0,83		0,55	17,00	51,10	59,54	84,68	1

Note: The Classification limits have been set according to Semi-Comp+. The cross-section is classified as Class 1

Flexural Buckling check

According to EN 1993-1-1 article 6.3.1.1 and formula (6.46)

Buckling parameters	yy	zz	
Sway type	sway	non-sway	
System length L	12,370	14,290	m
Buckling factor k	1,72	0,57	
Buckling length L_{cr}	21,311	8,077	m
Critical Euler load N_{cr}	194,00	1350,67	kN
Slenderness λ	278,45	105,53	

Buckling parameters	yy	zz	
Relative slenderness λ_{rel}	3,64	1,38	
Limit slenderness $\lambda_{rel,0}$	0,20	0,20	
Buckling curve	c	c	
Imperfection α	0,49	0,49	
Reduction factor χ	0,07	0,36	
Buckling resistance $N_{b,Rd}$	170,76	917,96	kN

Flexural Buckling verification		
Cross-section area A	7,2570e-03	m ²
Buckling resistance $N_{b,Rd}$	170,76	kN
Unity check	0,58	-

Torsional(-Flexural) Buckling check

According to EN 1993-1-1 article 6.3.1.1 and formula (6.46)

Note: The cross-section concerns a RHS section which is not susceptible to Torsional(-Flexural) Buckling.

Lateral Torsional Buckling check

According to EN 1993-1-1 article 6.3.2.1

Note: The cross-section concerns an RHS section with 'h / b < 10 / $\lambda_{rel,z}$ '.

This section is thus not susceptible to Lateral Torsional Buckling.

LTB additional parameters		
Minimal z coordinate z_{min}	-100	mm
Maximal z coordinate z_{max}	100	mm
Relative slenderness $\lambda_{rel,z}$	1,38	
End moment ratio ψ	0,24	
Equivalent point load F	25,59	kN
Equivalent line load q	3,58	kN/m
Difference with M	855,78	kNm
Difference with F	390,92	kNm
Difference with q	378,75	kNm
Resulting load type	line load q	

Bending and axial compression check

According to EN 1993-1-1 article 6.3.3 and formula (6.61),(6.62)

Bending and axial compression check parameters		
Interaction method	alternative method 1	
Cross-section area A	7,2570e-03	m ²
Plastic section modulus $W_{pl,y}$	5,0808e-04	m ³
Plastic section modulus $W_{pl,z}$	5,0808e-04	m ³
Design compression force N_{Ed}	99,44	kN
Design bending moment (maximum) $M_{y,Ed}$	-72,71	kNm
Design bending moment (maximum) $M_{z,Ed}$	1,55	kNm
Characteristic compression resistance N_{Rk}	2576,24	kN
Characteristic moment resistance $M_{y,Rk}$	180,37	kNm
Characteristic moment resistance $M_{z,Rk}$	180,37	kNm
Reduction factor χ_y	0,07	
Reduction factor χ_z	0,36	
Reduction factor χ_{LT}	1,00	
Interaction factor k_{yT}	0,76	
Interaction factor k_{yz}	0,59	
Interaction factor k_{zy}	1,08	
Interaction factor k_{zT}	1,10	

Maximum moment $M_{y,Ed}$ is derived from beam B4525 position 14,290 m.

Maximum moment $M_{z,Ed}$ is derived from beam B4525 position 0,000 m.

Interaction method 1 parameters		
Critical Euler load $N_{cr,y}$	194,00	kN
Critical Euler load $N_{cr,z}$	1350,67	kN
Elastic critical load $N_{cr,T}$	487761,21	kN
Plastic section modulus $W_{pl,y}$	5,0808e-04	m ³
Elastic section modulus $W_{el,y}$	4,2511e-04	m ³
Plastic section modulus $W_{pl,z}$	5,0808e-04	m ³
Elastic section modulus $W_{el,z}$	4,2511e-04	m ³
Second moment of area I_y	4,2511e-05	m ⁴
Second moment of area I_z	4,2511e-05	m ⁴
Torsional constant I_t	7,0717e-05	m ⁴
Method for equivalent moment factor $C_{my,0}$	Table A.2 Line 2 (General)	
Design bending moment (maximum) $M_{y,Ed}$	-72,71	kNm
Maximum relative deflection δ_z	-49,0	mm
Equivalent moment factor $C_{my,0}$	0,69	
Method for equivalent moment factor $C_{mz,0}$	Table A.2 Line 2 (General)	
Design bending moment (maximum) $M_{z,Ed}$	1,55	kNm
Maximum relative deflection δ_y	0,2	mm
Equivalent moment factor $C_{mz,0}$	0,93	
Factor μ_y	0,50	
Factor μ_z	0,95	
Factor ϵ_y	12,48	
Factor α_{LT}	0,00	

Interaction method 1 parameters		
Critical moment for uniform bending $M_{cr,0}$	1570,23	kNm
Relative slenderness $\lambda_{rel,0}$	0,34	
Limit relative slenderness $\lambda_{rel,0,lim}$	0,27	
Equivalent moment factor C_{my}	0,69	
Equivalent moment factor C_{mE}	0,93	
Equivalent moment factor $C_{m,LT}$	1,00	
Factor b_{1T}	0,00	
Factor c_{1T}	0,00	
Factor d_{1T}	0,00	
Factor e_{1T}	0,00	
Factor w_y	1,20	
Factor w_z	1,20	
Factor η_{pl}	0,04	
Maximum relative slenderness $\lambda_{rel,max}$	3,64	
Factor C_{yy}	0,93	
Factor C_{yz}	0,52	
Factor C_{zy}	0,74	
Factor C_{zz}	0,87	

Unity check (6.61) = $0,58 + 0,31 + 0,01 = 0,89$ -
 Unity check (6.62) = $0,11 + 0,44 + 0,01 = 0,55$ -

The member satisfies the stability check.

4.4.3. REZNE SILE-DONJI POJAS GLAVNOG REŠETKASTOG NOSAČA

My

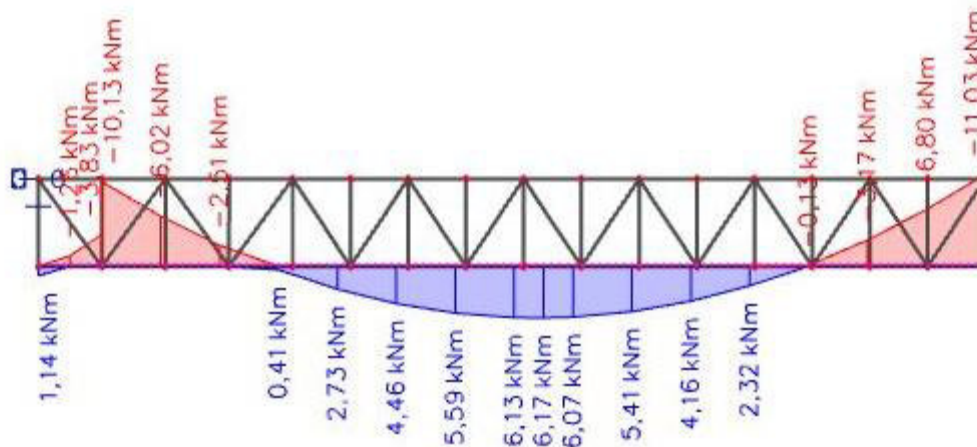

Vz

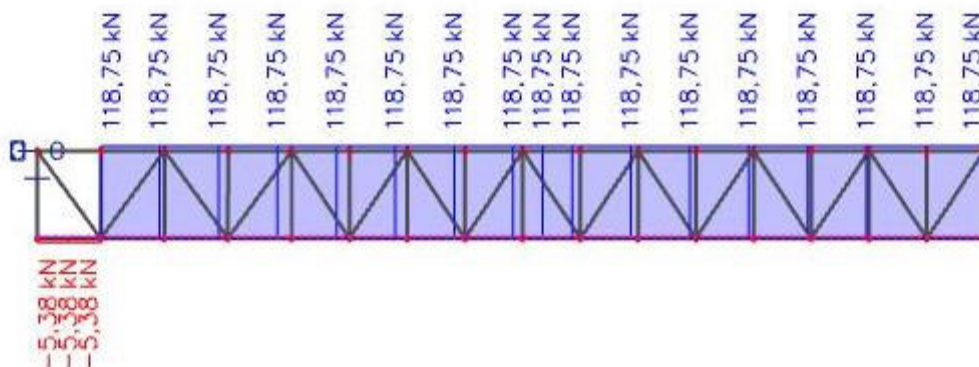

N

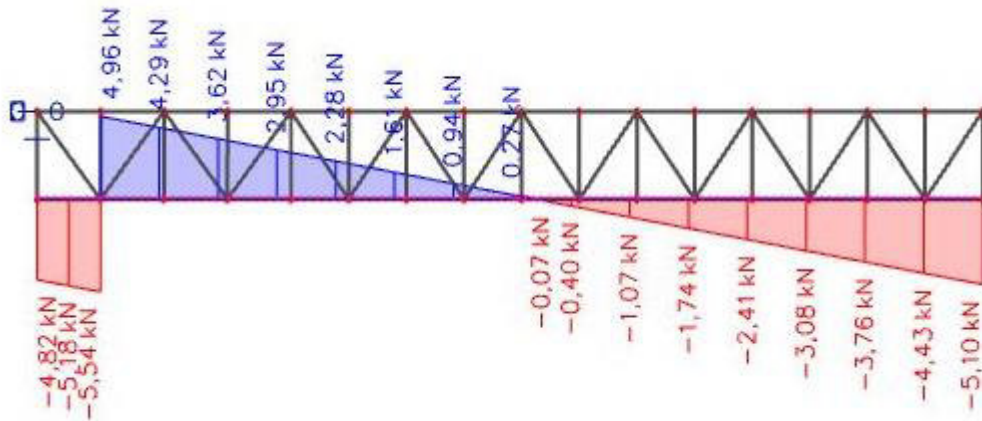

4.4.4. DIMENZIONIRANJE-DONJI POJAS GLAVNOG REŠETKASTOG NOSAČA

EN 1993-1-1 Code Check

National annex: Standard EN

Member B4525 14,290 / 14,290 m CFRHS200X200X10 S 355 GSN7 0,45 -

Note: EN 1993-1-3 article 1.1(3) specifies that this part does not apply to cold formed CHS and RHS sections. The default EN 1993-1-1 code check is executed instead of the EN 1993-1-3 code check.

Combination key
GSN7 / 1.35*vlastita težina + 1.50*pokretno + 1.35*dodatno stalno + 1.50*vjetar smjer x + 0.90*temperatura pozitivna

Partial safety factors	
γ_{M0} for resistance of cross-sections	1,00
γ_{M1} for resistance to instability	1,00
γ_{M2} for resistance of net sections	1,25

Material		
Yield strength f_y	355,0	MPa
Ultimate strength f_u	490,0	MPa
Fabrication	Cold formed	

...:SECTION CHECK:...

The critical check is on position 14,290 m

Internal forces	Calculated	Unit
N_{Ed}	-100,85	kN
$V_{y,Ed}$	0,03	kN
$V_{z,Ed}$	-36,72	kN
T_{Ed}	-0,06	kNm
$M_{y,Ed}$	-71,98	kNm
$M_{z,Ed}$	-0,12	kNm

Classification for cross-section design

Classification according to EN 1993-1-1 article 5.5.2

Classification of Internal and Outstand parts according to EN 1993-1-1 Table 5.2 Sheet 1 & 2

Id	Type	c [mm]	t [mm]	σ_1 [kN/m ²]	σ_2 [kN/m ²]	ψ [-]	k_{σ} [-]	α [-]	c/t [-]	Class 1 Limit [-]	Class 2 Limit [-]	Class 3 Limit [-]	Class
1	I	170	10	1,750e+05	1,746e+05	1,00		1,00	17,00	22,78	27,66	30,95	1
3	I	170	10	1,576e+05	-1,303e+05	-0,83		0,55	17,00	50,99	59,42	84,46	1
5	I	170	10	-1,472e+05	-1,468e+05								
7	I	170	10	-1,298e+05	1,581e+05	-0,82		0,55	17,00	50,74	59,15	83,98	1

Note: The Classification limits have been set according to Semi-Comp+.

The cross-section is classified as Class 1

Compression check

According to EN 1993-1-1 article 6.2.4 and formula (6.9)

A	7,2570e-03	m ²
$N_{c,Rd}$	2576,24	kN
Unity check	0,04	-

Bending moment check for M_y

According to EN 1993-1-1 article 6.2.5 and formula (6.12),(6.13)

W_{ply}	5,0808e-04	m ³
$M_{ply,Rd}$	180,37	kNm
Unity check	0,40	-

Bending moment check for M_z

According to EN 1993-1-1 article 6.2.5 and formula (6.12),(6.13)

$W_{pl,z}$	5,0808e-04	m ³
$M_{pl,z,Rd}$	180,37	kNm
Unity check	0,00	-

Shear check for V_y

According to EN 1993-1-1 article 6.2.6 and formula (6.17)

η	1,20	
A_v	3,6285e-03	m ²
$V_{ply,Rd}$	743,69	kN
Unity check	0,00	-

Shear check for V_z

According to EN 1993-1-1 article 6.2.6 and formula (6.17)

η	1,20	
A_v	3,6285e-03	m ²
$V_{pl,z,Rd}$	743,69	kN
Unity check	0,05	-

Torsion check

According to EN 1993-1-1 article 6.2.7 and formula (6.23)

Fibre	1	
T_{Ed}	0,1	MPa
T_{Rd}	205,0	MPa
Unity check	0,00	-

Note: The unity check for torsion is lower than the limit value of 0,05. Therefore torsion is considered as insignificant and is ignored in the combined checks.

Combined bending, axial force and shear force check

According to EN 1993-1-1 article 6.2.9.1 and formula (6.41)

$M_{N,y,Rd}$	180,37	kNm
α	1,66	
$M_{N,z,Rd}$	180,37	kNm
β	1,66	

Unity check (6.41) = 0,22 + 0,00 = 0,22 -

Decision tables for combined section check

Force presence	
Axial force N_{Ed}	Present
Shear force $V_{y,Ed}$	Not significant
Shear force $V_{z,Ed}$	Not significant
Torsional moment T_{Ed}	Not significant
Bending moment $M_{y,Ed}$	Present
Bending moment $M_{z,Ed}$	Present
Significant shear force without corresponding bending moment	No
Warping data	Not present or negligible

Check inputs	
Classification is supported	Yes
Section classification	Class 1
Elastic verification is set by the user	No
Plastic shear formula is available	Yes
Combined bending and axial force formula is available	Yes
Combined bending and axial force check can be calculated	Yes

Selected check
According to EN 1993-1-1 article 6.2.9.1 and formula (6.41)

The member satisfies the section check.

...:STABILITY CHECK:...:

Classification for member buckling design

Decisive position for stability classification: 14,290 m

Classification according to EN 1993-1-1 article 5.5.2

Classification of Internal and Outstand parts according to EN 1993-1-1 Table 5.2 Sheet 1 & 2

Id	Type	c [mm]	t [mm]	σ_1 [kN/m ²]	σ_2 [kN/m ²]	ψ [-]	k_o [-]	α [-]	c/t [-]	Class 1 Limit [-]	Class 2 Limit [-]	Class 3 Limit [-]	Class
1	I	170	10	1,750e+05	1,746e+05	1,00		1,00	17,00	22,78	27,66	30,95	1
3	I	170	10	1,576e+05	-1,303e+05	-0,83		0,55	17,00	50,99	59,42	84,46	1
5	I	170	10	-1,472e+05	-1,468e+05								
7	I	170	10	-1,298e+05	1,581e+05	-0,82		0,55	17,00	50,74	59,15	83,98	1

Note: The Classification limits have been set according to Semi-Comp+.

The cross-section is classified as Class 1

Flexural Buckling check

According to EN 1993-1-1 article 6.3.1.1 and formula (6.46)

Buckling parameters	yy	zz	
Sway type	sway	non-sway	
System length L	12,370	14,290	m
Buckling factor k	0,01	0,01	
Buckling length L_{cr}	0,100	0,100	m
Critical Euler load N_{cr}	8810818,90	8810818,90	kN
Slenderness λ	1,31	1,31	

Buckling parameters	yy	zz	
Relative slenderness λ_{rel}	0,02	0,02	
Limit slenderness $\lambda_{rel,0}$	0,20	0,20	

Note: The slenderness or compression force is such that Flexural Buckling effects may be ignored according to EN 1993-1-1 article 6.3.1.2(4).

Torsional(-Flexural) Buckling check

According to EN 1993-1-1 article 6.3.1.1 and formula (6.46)

Note: The cross-section concerns a RHS section which is not susceptible to Torsional(-Flexural) Buckling.

Lateral Torsional Buckling check

According to EN 1993-1-1 article 6.3.2.1

Note: The cross-section concerns an RHS section with ' $h/b < 10 / \lambda_{rel,z}$ '. This section is thus not susceptible to Lateral Torsional Buckling.

LTB additional parameters		
Minimal z coordinate z_{min}	-100	mm
Maximal z coordinate z_{max}	100	mm
Relative slenderness $\lambda_{rel,z}$	0,02	
End moment ratio ψ	0,24	
Equivalent point load F	25,46	kN
Equivalent line load q	3,56	kN/m
Difference with M	850,28	kNm
Difference with F	393,81	kNm
Difference with q	381,70	kNm
Resulting load type	line load q	

Bending and axial compression check

According to EN 1993-1-1 article 6.3.3 and formula (6.61),(6.62)

Bending and axial compression check parameters		
Interaction method	alternative method 1	
Cross-section area A	7,2570e-03	m ²
Plastic section modulus $W_{pl,y}$	5,0808e-04	m ³
Plastic section modulus $W_{pl,z}$	5,0808e-04	m ³
Design compression force N_{Ed}	100,85	kN
Design bending moment (maximum) $M_{y,Ed}$	-71,98	kNm
Design bending moment (maximum) $M_{z,Ed}$	4,04	kNm
Characteristic compression resistance N_{Rk}	2576,24	kN
Characteristic moment resistance $M_{r,yk}$	180,37	kNm
Characteristic moment resistance $M_{r,zk}$	180,37	kNm
Reduction factor χ_y	1,00	
Reduction factor χ_z	1,00	
Reduction factor χ_{LT}	1,00	
Interaction factor k_{yy}	0,99	
Interaction factor k_{yz}	0,59	
Interaction factor k_{zy}	0,59	
Interaction factor k_{zz}	0,99	

Maximum moment $M_{y,Ed}$ is derived from beam B4525 position 14,290 m.

Maximum moment $M_{z,Ed}$ is derived from beam B4525 position 0,000 m.

Interaction method 1 parameters		
Critical Euler load $N_{cr,y}$	8810818,90	kN
Critical Euler load $N_{cr,z}$	8810818,90	kN
Elastic critical load $N_{cr,T}$	487761,21	kN
Plastic section modulus $W_{pl,y}$	5,0808e-04	m ³
Elastic section modulus $W_{el,y}$	4,2511e-04	m ³
Plastic section modulus $W_{pl,z}$	5,0808e-04	m ³
Elastic section modulus $W_{el,z}$	4,2511e-04	m ³
Second moment of area I_y	4,2511e-05	m ⁴
Second moment of area I_z	4,2511e-05	m ⁴
Torsional constant I_t	7,0717e-05	m ⁴
Method for equivalent moment factor $C_{my,0}$	Table A.2 Line 2 (General)	
Design bending moment (maximum) $M_{y,Ed}$	-71,98	kNm
Maximum relative deflection δ_2	-49,2	mm
Equivalent moment factor $C_{my,0}$	1,00	
Method for equivalent moment factor $C_{mz,0}$	Table A.2 Line 2 (General)	
Design bending moment (maximum) $M_{z,Ed}$	4,04	kNm
Maximum relative deflection δ_y	0,7	mm
Equivalent moment factor $C_{mz,0}$	1,00	
Factor μ_y	1,00	
Factor μ_z	1,00	
Factor ϵ_y	12,18	
Factor a_{LT}	0,00	
Critical moment for uniform bending $M_{cr,0}$	1570,23	kNm
Relative slenderness $\lambda_{rel,0}$	0,34	
Limit relative slenderness $\lambda_{rel,0,lim}$	0,27	
Equivalent moment factor C_{my}	1,00	
Equivalent moment factor C_{mz}	1,00	
Equivalent moment factor C_{mLT}	1,00	

Interaction method 1 parameters		
Factor b_{LT}	0,00	
Factor c_{LT}	0,00	
Factor d_{LT}	0,00	
Factor e_{LT}	0,00	
Factor w_y	1,20	
Factor w_z	1,20	
Factor n_{pl}	0,04	
Maximum relative slenderness $\lambda_{rel,max}$	0,02	
Factor C_{yy}	1,02	
Factor C_{yz}	1,02	
Factor C_{zy}	1,02	
Factor C_{zz}	1,02	

Unity check (6.61) = 0,04 + 0,39 + 0,01 = 0,45 -

Unity check (6.62) = 0,04 + 0,24 + 0,02 = 0,30 -

The member satisfies the stability check.

4.5. DIMENZIONIRANJE KINA-POZICIJA 600

4.5.1. REZNE SILE-DONJI POJAS GLAVNOG REŠETKASTOG NOSAČA

My

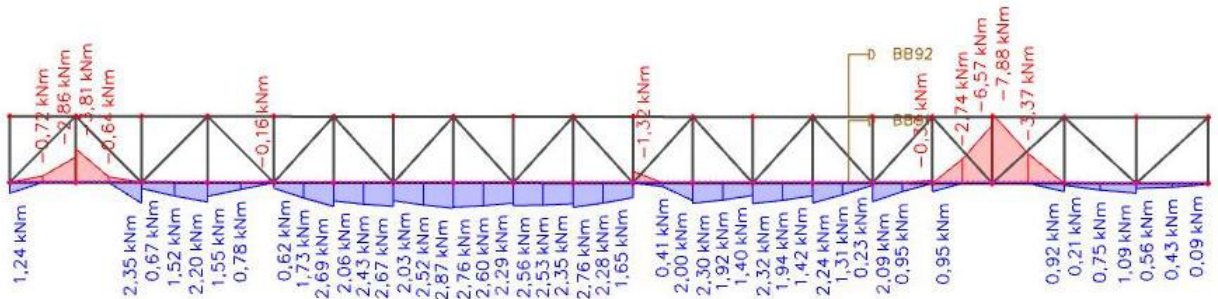

Vz

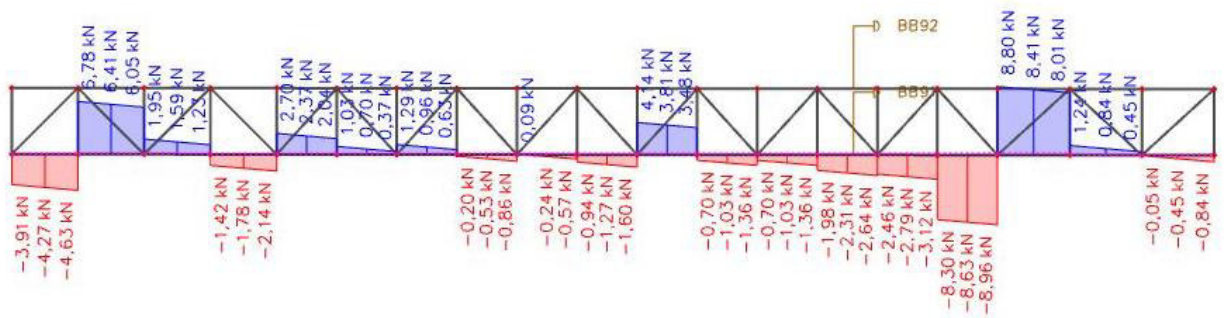

N

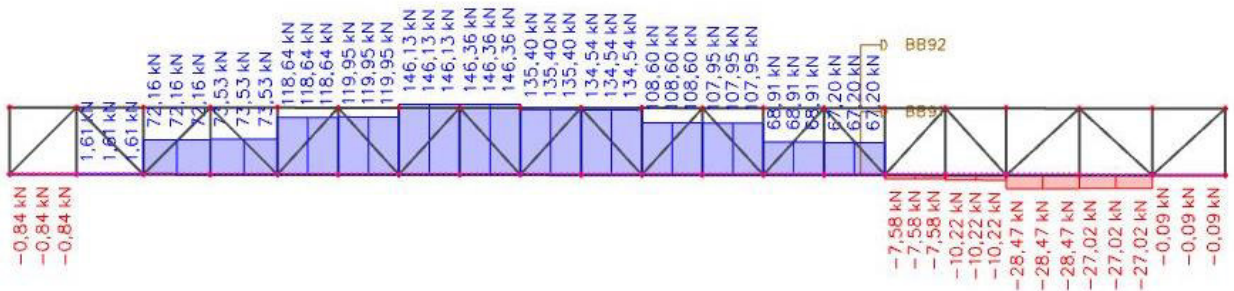

4.5.2. DIMENZIONIRANJE-DONJI POJAS GLAVNOG REŠETKASTOG NOSAČA

EC-EN 1993 Steel check ULS

Linear calculation
Combination: GSN6
Coordinate system: Principal
Extreme ID: Member
Selection: 84431

EN 1993-1-1 Code Check

National annex: Standard EN

Member B4431	0,960 / 17,430 m	CFRHS200X200X10	S 355	GSN6	0,34 -
---------------------	-------------------------	------------------------	--------------	-------------	---------------

Note: EN 1993-1-3 article 1.1(3) specifies that this part does not apply to cold formed CHS and RHS sections. The default EN 1993-1-1 code check is executed instead of the EN 1993-1-3 code check.

Combination key	
GSN6 / 1.35*vlastita težina + 1.50*pokretno + 1.35*dodatno stalno + 1.50*vjetar smjer x	

Partial safety factors	
γ_{M0} for resistance of cross-sections	1,00
γ_{M1} for resistance to instability	1,00
γ_{M2} for resistance of net sections	1,25

Material		
Yield strength f_y	355,0	MPa
Ultimate strength f_u	490,0	MPa
Fabrication	Cold formed	

...:SECTION CHECK:...:

The critical check is on position 0,960 m

Internal forces	Calculated	Unit
N_{Ed}	-0,68	kN
$V_{y,Ed}$	4,15	kN
$V_{z,Ed}$	-4,68	kN
T_{Ed}	-0,89	kNm
$M_{y,Ed}$	-2,90	kNm
$M_{z,Ed}$	9,35	kNm

Classification for cross-section design

Classification according to EN 1993-1-1 article 5.5.2

Classification of Internal and Outstand parts according to EN 1993-1-1 Table 5.2 Sheet 1 & 2

Id	Type	c [mm]	t [mm]	σ_1 [kN/m ²]	σ_2 [kN/m ²]	ψ [-]	k_{σ} [-]	α [-]	c/t [-]	Class 1 Limit [-]	Class 2 Limit [-]	Class 3 Limit [-]	Class
1	I	170	10	-1,212e+04	2,527e+04	-0,48		0,68	17,00	37,72	44,80	63,53	1
3	I	170	10	2,679e+04	1,518e+04	0,57		1,00	17,00	22,78	27,66	36,39	1
5	I	170	10	1,230e+04	-2,509e+04	-2,04		0,33	17,00	89,02	102,62	218,92	1
7	I	170	10	-2,660e+04	-1,500e+04								

Note: The Classification limits have been set according to Semi-Comp+.
The cross-section is classified as Class 1

Compression check

According to EN 1993-1-1 article 6.2.4 and formula (6.9)

A	7,2570e-03	m ²
$N_{c,Rd}$	2576,24	kN
Unity check	0,00	-

Bending moment check for M_y

According to EN 1993-1-1 article 6.2.5 and formula (6.12),(6.13)

W_{ply}	5,0808e-04	m ³
$M_{ply,Rd}$	180,37	kNm
Unity check	0,02	-

Bending moment check for M_z

According to EN 1993-1-1 article 6.2.5 and formula (6.12),(6.13)

$W_{pl,z}$	5,0808e-04	m ³
$M_{pl,z,Rd}$	180,37	kNm
Unity check	0,05	-

Shear check for V_y

According to EN 1993-1-1 article 6.2.6 and formula (6.17)

η	1,20	
A_v	3,6285e-03	m ²
$V_{ply,Rd}$	743,69	kN
Unity check	0,01	-

Shear check for V_z

According to EN 1993-1-1 article 6.2.6 and formula (6.17)

η	1,20	
A_v	3,6285e-03	m ²
$V_{pl,z,Rd}$	743,69	kN
Unity check	0,01	-

Torsion check

According to EN 1993-1-1 article 6.2.7 and formula (6.23)

Fibre	1	
T_{Ed}	1,2	MPa
T_{Rd}	205,0	MPa
Unity check	0,01	-

Note: The unity check for torsion is lower than the limit value of 0,05. Therefore torsion is considered as insignificant and is ignored in the combined checks.

Combined bending, axial force and shear force check

According to EN 1993-1-1 article 6.2.9.1 and formula (6.41)

$M_{N,y,Rd}$	180,37	kNm
α	1,66	
$M_{N,z,Rd}$	180,37	kNm
β	1,66	

Unity check (6.41) = 0,00 + 0,01 = 0,01 -

Note: Since the shear forces are less than half the plastic shear resistances their effect on the moment resistances is neglected.

Decision tables for combined section check

Force presence	
Axial force N_{Ed}	Present
Shear force $V_{y,Ed}$	Not significant
Shear force $V_{z,Ed}$	Not significant
Torsional moment T_{Ed}	Not significant
Bending moment $M_{y,Ed}$	Present
Bending moment $M_{z,Ed}$	Present
Significant shear force without corresponding bending moment	No
Warping data	Not present or negligible

Check inputs	
Classification is supported	Yes
Section classification	Class 1
Elastic verification is set by the user	No
Plastic shear formula is available	Yes
Combined bending and axial force formula is available	Yes
Combined bending and axial force check can be calculated	Yes

Selected check
According to EN 1993-1-1 article 6.2.9.1 and formula (6.41)

The member satisfies the section check.

....:STABILITY CHECK:....

Classification for member buckling design

Decisive position for stability classification: 3,840 m

Classification according to EN 1993-1-1 article 5.5.2

Classification of Internal and Outstand parts according to EN 1993-1-1 Table 5.2 Sheet 1 & 2

Id	Type	c [mm]	t [mm]	σ_1 [kN/m ²]	σ_2 [kN/m ²]	ψ [-]	k_σ [-]	α [-]	c/t [-]	Class 1 Limit [-]	Class 2 Limit [-]	Class 3 Limit [-]	Class
1	I	170	10	1,077e+05	-1,283e+05	-1,19		0,46	17,00	64,18	73,99	120,65	1
3	I	170	10	-1,421e+05	-1,423e+05								
5	I	170	10	-1,284e+05	1,075e+05	-1,19		0,46	17,00	64,28	74,10	120,99	1
7	I	170	10	1,214e+05	1,215e+05	1,00		1,00	17,00	22,78	27,66	30,93	1

Note: The Classification limits have been set according to Semi-Comp+. The cross-section is classified as Class 1

Flexural Buckling check

According to EN 1993-1-1 article 6.3.1.1 and formula (6.46)

Buckling parameters	yy	zz	
Sway type	sway	non-sway	
System length L	0,960	3,840	m
Buckling factor k	0,99	0,03	
Buckling length L_{cr}	0,950	0,100	m
Critical Euler load N_{cr}	97626,80	8810818,90	kN
Slenderness λ	12,41	1,31	

Buckling parameters	yy	zz
Relative slenderness λ_{rel}	0,16	0,02
Limit slenderness $\lambda_{rel,0}$	0,20	0,20

Note: The slenderness or compression force is such that Flexural Buckling effects may be ignored according to EN 1993-1-1 article 6.3.1.2(4).

Torsional(-Flexural) Buckling check

According to EN 1993-1-1 article 6.3.1.1 and formula (6.46)

Note: The cross-section concerns a RHS section which is not susceptible to Torsional(-Flexural) Buckling.

Lateral Torsional Buckling check

According to EN 1993-1-1 article 6.3.2.1

Note: The cross-section concerns an RHS section with ' $h / b < 10 / \lambda_{rel,z}$ '. This section is thus not susceptible to Lateral Torsional Buckling.

LTB additional parameters		
Minimal z coordinate z_{min}	-100	mm
Maximal z coordinate z_{max}	100	mm
Relative slenderness $\lambda_{rel,z}$	0,02	
End moment ratio ψ	-0,03	
Equivalent point load F	-4,49	kN
Equivalent line load q	-2,34	kN/m
Difference with M	11,90	kNm
Difference with F	19,83	kNm
Difference with q	21,57	kNm
Resulting load type	point load F	

Bending and axial compression check

According to EN 1993-1-1 article 6.3.3 and formula (6.61),(6.62)

Bending and axial compression check parameters		
Interaction method	alternative method 1	
Cross-section area A	7,2570e-03	m ²
Plastic section modulus $W_{pl,y}$	5,0808e-04	m ³
Plastic section modulus $W_{pl,z}$	5,0808e-04	m ³
Design compression force N_{Ed}	0,68	kN
Design bending moment (maximum) $M_{y,Ed}$	-2,90	kNm
Design bending moment (maximum) $M_{z,Ed}$	-58,97	kNm
Characteristic compression resistance N_{Rk}	2576,24	kN
Characteristic moment resistance $M_{y,Rk}$	180,37	kNm
Characteristic moment resistance $M_{z,Rk}$	180,37	kNm
Reduction factor χ_y	1,00	
Reduction factor χ_z	1,00	
Reduction factor χ_{LT}	1,00	
Interaction factor k_{FF}	1,00	
Interaction factor k_{yZ}	0,60	
Interaction factor k_{zy}	0,60	
Interaction factor k_{zz}	1,00	

Maximum moment $M_{y,Ed}$ is derived from beam B4431 position 0,960 m.

Maximum moment $M_{z,Ed}$ is derived from beam B4431 position 3,840 m.

Interaction method 1 parameters		
Critical Euler load $N_{cr,y}$	97626,80	kN
Critical Euler load $N_{cr,z}$	8810818,90	kN
Elastic critical load $N_{cr,T}$	490729,52	kN
Plastic section modulus $W_{pl,y}$	5,0808e-04	m ³
Elastic section modulus $W_{el,y}$	4,2511e-04	m ³
Plastic section modulus $W_{pl,z}$	5,0808e-04	m ³
Elastic section modulus $W_{el,z}$	4,2511e-04	m ³
Second moment of area I_y	4,2511e-05	m ⁴
Second moment of area I_z	4,2511e-05	m ⁴
Torsional constant I_t	7,0717e-05	m ⁴
Method for equivalent moment factor $C_{my,0}$	Table A.2 Line 2 (General)	
Design bending moment (maximum) $M_{y,Ed}$	-2,90	kNm
Maximum relative deflection δ_z	0,0	mm
Equivalent moment factor $C_{my,0}$	1,00	
Method for equivalent moment factor $C_{mz,0}$	Table A.2 Line 2 (General)	
Design bending moment (maximum) $M_{z,Ed}$	-58,97	kNm
Maximum relative deflection δ_y	-30,8	mm
Equivalent moment factor $C_{mz,0}$	1,00	
Factor μ_y	1,00	
Factor μ_z	1,00	
Factor ϵ_y	72,90	
Factor α_{LT}	0,00	
Critical moment for uniform bending $M_{cr,0}$	5861,18	kNm
Relative slenderness $\lambda_{rel,0}$	0,18	
Limit relative slenderness $\lambda_{rel,0,lim}$	0,24	
Equivalent moment factor C_{my}	1,00	
Equivalent moment factor C_{mz}	1,00	
Equivalent moment factor C_{mLT}	1,00	

Interaction method 1 parameters	
Factor b_{LT}	0,00
Factor c_{LT}	0,00
Factor d_{LT}	0,00
Factor e_{LT}	0,00
Factor w_y	1,20
Factor w_z	1,20
Factor η_{pl}	0,00
Maximum relative slenderness $\lambda_{rel,max}$	0,16
Factor C_{yy}	1,00
Factor C_{yz}	1,00
Factor C_{zy}	1,00
Factor C_{zz}	1,00

Unity check (6.61) = $0,00 + 0,02 + 0,20 = 0,21$ -

Unity check (6.62) = $0,00 + 0,01 + 0,33 = 0,34$ -

The member satisfies the stability check.

4.6. DIMENZIONIRANJE KROV-POZICIJA 700

4.6.1. REZNE SILE-DONJI POJAS GLAVNOG REŠETKASTOG NOSAČA

My

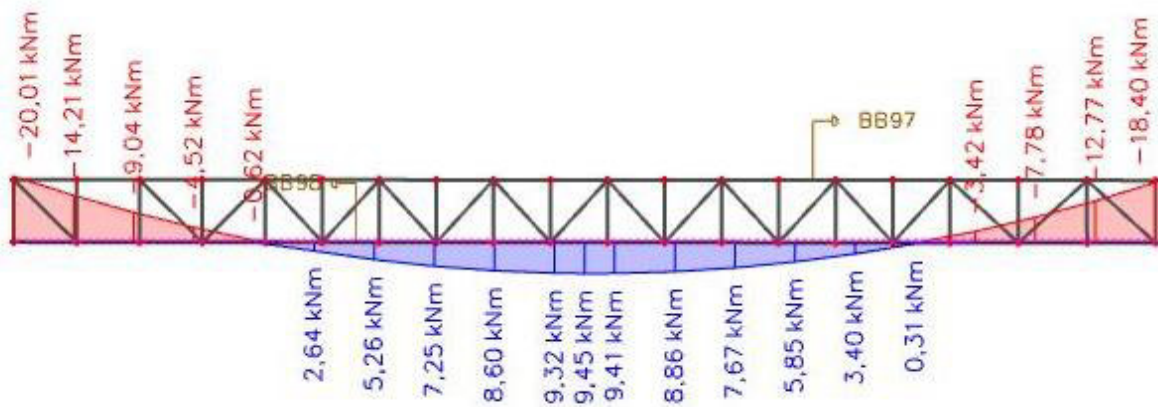

Vz

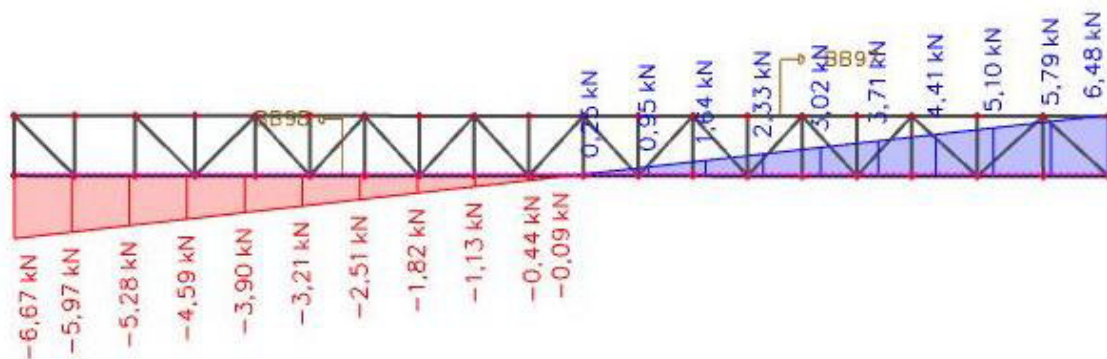

N

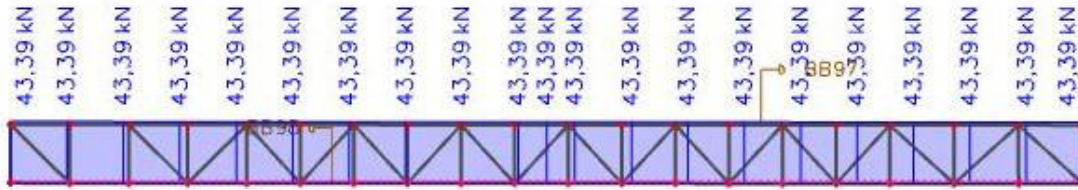

4.6.2. DIMENZIONIRANJE-DONJI POJAS GLAVNOG REŠETKASTOG NOSAČA

EC-EN 1993 Steel check ULS

Linear calculation
Combination: GSN4
Coordinate system: Principal
Extreme 1D: Member
Selection: B4630

EN 1993-1-1 Code Check

National annex: Standard EN

Member B4630	17,430 / 17,430 m	CFRHS200X200X10	S 355	GSN4	0,11 -
--------------	-------------------	-----------------	-------	------	--------

Note: EN 1993-1-3 article 1.1(3) specifies that this part does not apply to cold formed CHS and RHS sections.
The default EN 1993-1-1 code check is executed instead of the EN 1993-1-3 code check.

Combination key	
GSN4 / 1.35*vlastita težina + 1.50*pokretno + 1.35*dodatno stalno + 1.50*vjetar smjer x + 0.90*temperatura pozitivna	

Partial safety factors	
γ_{M0} for resistance of cross-sections	1,00
γ_{M1} for resistance to instability	1,00
γ_{M2} for resistance of net sections	1,25

Material	
Yield strength f_y	355,0 MPa
Ultimate strength f_u	490,0 MPa
Fabrication	Cold formed

...:SECTION CHECK:...

The critical check is on position 17,430 m

Internal forces	Calculated	Unit
N_{Ed}	43,39	kN
$V_{y,Ed}$	0,11	kN
$V_{z,Ed}$	-6,67	kN
T_{Ed}	-0,12	kNm
$M_{y,Ed}$	-20,01	kNm
$M_{z,Ed}$	0,44	kNm

Classification for cross-section design

Classification according to EN 1993-1-1 article 5.5.2

Classification of Internal and Outstand parts according to EN 1993-1-1 Table 5.2 Sheet 1 & 2

Id	Type	c [mm]	t [mm]	σ_1 [kN/m ²]	σ_2 [kN/m ²]	ψ [-]	k_{σ} [-]	α [-]	c/t [-]	Class 1 Limit [-]	Class 2 Limit [-]	Class 3 Limit [-]	Class
1	I	170	10	3,787e+04	3,962e+04	0,96		1,00	17,00	22,78	27,66	31,40	1
3	I	170	10	3,502e+04	-4,502e+04	-1,29		0,44	17,00	66,94	77,17	130,72	1
5	I	170	10	-4,983e+04	-5,158e+04								
7	I	170	10	-4,698e+04	3,306e+04	-1,42		0,41	17,00	70,92	81,75	145,60	1

Note: The Classification limits have been set according to Semi-Comp+.

The cross-section is classified as Class 1

Tension check

According to EN 1993-1-1 article 6.2.3 and formula (6.5)

A	7,2570e-03	m ²
$N_{pl,Rd}$	2576,24	kN
$N_{u,Rd}$	2560,27	kN
$N_{t,Rd}$	2560,27	kN
Unity check	0,02	-

Bending moment check for M_y

According to EN 1993-1-1 article 6.2.5 and formula (6.12),(6.13)

W_{ply}	5,0808e-04	m ³
$M_{ply,Rd}$	180,37	kNm
Unity check	0,11	-

Bending moment check for M_z

According to EN 1993-1-1 article 6.2.5 and formula (6.12),(6.13)

W_{plz}	5,0808e-04	m ³
$M_{plz,Rd}$	180,37	kNm
Unity check	0,00	-

Shear check for V_y

According to EN 1993-1-1 article 6.2.6 and formula (6.17)

η	1,20	
A_v	3,6285e-03	m ²
$V_{ply,Rd}$	743,69	kN

Unity check	0,00	-
-------------	------	---

Shear check for V_z

According to EN 1993-1-1 article 6.2.6 and formula (6.17)

η	1,20	
A_v	3,6285e-03	m ²
$V_{plz,Rd}$	743,69	kN
Unity check	0,01	-

Torsion check

According to EN 1993-1-1 article 6.2.7 and formula (6.23)

Fibre	1	
T_{Ed}	0,2	MPa
T_{Rd}	205,0	MPa
Unity check	0,00	-

Note: The unity check for torsion is lower than the limit value of 0,05. Therefore torsion is considered as insignificant and is ignored in the combined checks.

Combined bending, axial force and shear force check

According to EN 1993-1-1 article 6.2.9.1 and formula (6.41)

$M_{N,y,Rd}$	180,37	kNm
α	1,66	
$M_{N,z,Rd}$	180,37	kNm
β	1,66	

Unity check (6.41) = 0,03 + 0,00 = 0,03 -

Note: Since the shear forces are less than half the plastic shear resistances their effect on the moment resistances is neglected.

Decision tables for combined section check

Force presence	
Axial force N_{Ed}	Present
Shear force $V_{y,Ed}$	Not significant
Shear force $V_{z,Ed}$	Not significant
Torsional moment T_{Ed}	Not significant
Bending moment $M_{y,Ed}$	Present
Bending moment $M_{z,Ed}$	Present
Significant shear force without corresponding bending moment	No
Warping data	Not present or negligible

Check inputs	
Classification is supported	Yes
Section classification	Class 1
Elastic verification is set by the user	No
Plastic shear formula is available	Yes
Combined bending and axial force formula is available	Yes
Combined bending and axial force check can be calculated	Yes

Selected check
According to EN 1993-1-1 article 6.2.9.1 and formula (6.41)

The member satisfies the section check.

....STABILITY CHECK:....

Classification for member buckling design

Decisive position for stability classification: 17,430 m

Classification according to EN 1993-1-1 article 5.5.2

Classification of Internal and Outstand parts according to EN 1993-1-1 Table 5.2 Sheet 1 & 2

Id	Type	c [mm]	t [mm]	σ_1 [kN/m ²]	σ_2 [kN/m ²]	ψ [-]	k_o [-]	α [-]	c/t [-]	Class 1 Limit [-]	Class 2 Limit [-]	Class 3 Limit [-]	Class
1	I	170	10	3,787e+04	3,962e+04	0,96		1,00	17,00	22,78	27,66	31,40	1
3	I	170	10	3,502e+04	-4,502e+04	-1,29		0,44	17,00	66,94	77,17	130,72	1
5	I	170	10	-4,983e+04	-5,158e+04								
7	I	170	10	-4,698e+04	3,306e+04	-1,42		0,41	17,00	70,92	81,75	145,60	1

Note: The Classification limits have been set according to Semi-Comp+.

The cross-section is classified as Class 1

Lateral Torsional Buckling check

According to EN 1993-1-1 article 6.3.2.1

Note: The cross-section concerns an RHS section with ' $h / b < 10 / \lambda_{rel,z}$ '.

This section is thus not susceptible to Lateral Torsional Buckling.

LTB additional parameters		
Minimal z coordinate z_{min}	-100	mm
Maximal z coordinate z_{max}	100	mm
Relative slenderness $\lambda_{rel,z}$	0,16	

LTB additional parameters		
End moment ratio ψ	0,92	
Equivalent point load F	6,58	kN
Equivalent line load q	0,75	kN/m
Difference with M	390,56	kNm
Difference with F	90,48	kNm
Difference with q	0,00	kNm
Resulting load type	line load q	

The member satisfies the stability check.

4.6.3. REZNE SILE-GORNJI POJAS SEKUNDARNOG REŠETKASTOG NOSAČA

My

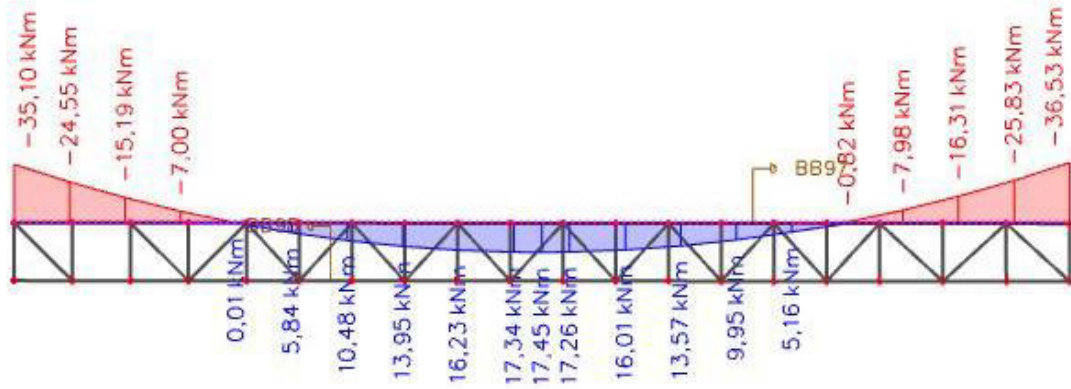

Vz

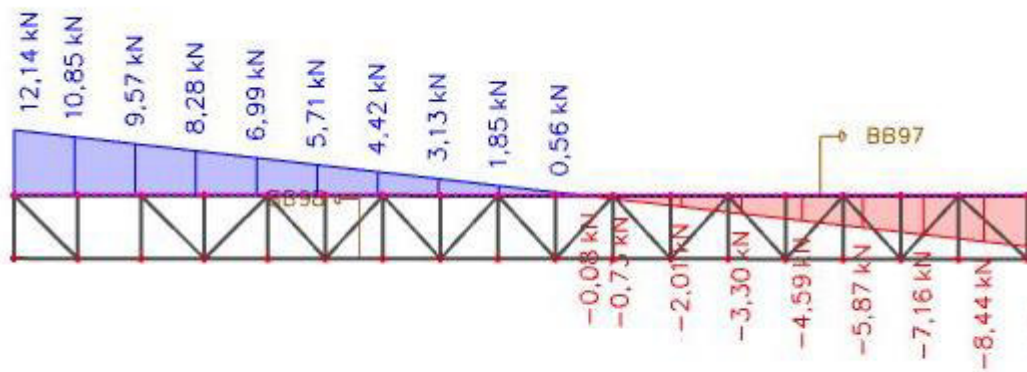

N

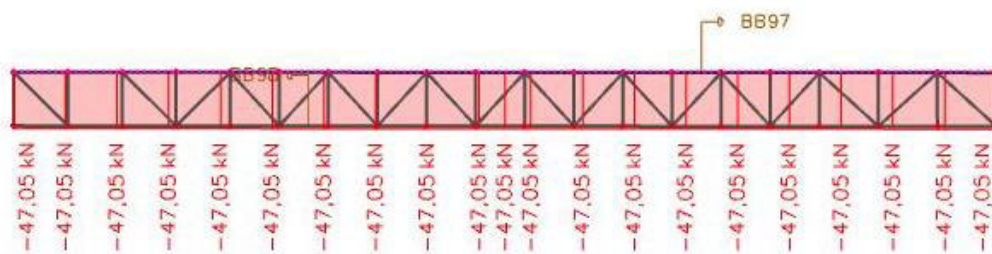

4.6.4. DIMENSIONIRANJE-GORNJI POJAS GLAVNOG REŠETKASTOG NOSAČA

EC-EN 1993 Steel check ULS

Linear calculation
Combination: GSN4
Coordinate system: Principal
Extreme 1D: Member
Selection: 83314

EN 1993-1-1 Code Check

National annex: Standard EN

Member B3314	17,431 / 17,431 m	CFRH5200X200X10	S 355	GSN4	0,22 -
--------------	-------------------	-----------------	-------	------	--------

Note: EN 1993-1-3 article 1.1(3) specifies that this part does not apply to cold formed CHS and RHS sections.
The default EN 1993-1-1 code check is executed instead of the EN 1993-1-3 code check.

Combination key	
GSN4 / 1.35*vlastita težina + 1.50*pokretno + 1.35*dodatno stalno + 1.50*vjetar smjer x + 0.90*temperatura pozitivna	

Partial safety factors	
γ_{M0} for resistance of cross-sections	1,00
γ_{M1} for resistance to instability	1,00
γ_{M2} for resistance of net sections	1,25

Material		
Yield strength f_y	355,0	MPa
Ultimate strength f_u	490,0	MPa
Fabrication	Cold formed	

....SECTION CHECK:....
The critical check is on position 17,431 m

Internal forces	Calculated	Unit
N_{Ed}	-47,05	kN
$V_{y,Ed}$	-0,10	kN
$V_{z,Ed}$	-12,30	kN
T_{Ed}	0,01	kNm
$M_{y,Ed}$	-36,53	kNm
$M_{z,Ed}$	-1,29	kNm

Classification for cross-section design

Classification according to EN 1993-1-1 article 5.5.2

Classification of Internal and Outstand parts according to EN 1993-1-1 Table 5.2 Sheet 1 & 2

Id	Type	c [mm]	t [mm]	σ_1 [kN/m ²]	σ_2 [kN/m ²]	ψ [-]	k_{σ} [-]	α [-]	c/t [-]	Class 1 Limit [-]	Class 2 Limit [-]	Class 3 Limit [-]	Class
1	I	170	10	9,073e+04	8,557e+04	0,94		1,00	17,00	22,78	27,66	31,54	1
3	I	170	10	7,667e+04	-6,947e+04	-0,91		0,52	17,00	54,37	63,05	91,31	1
5	I	170	10	-7,776e+04	-7,260e+04								
7	I	170	10	-6,370e+04	8,244e+04	-0,77		0,56	17,00	48,76	57,00	80,33	1

Note: The Classification limits have been set according to Semi-Comp+. The cross-section is classified as Class 1

Compression check

According to EN 1993-1-1 article 6.2.4 and formula (6.9)

A	7,2570e-03	m ²
$N_{c,Rd}$	2576,24	kN
Unity check	0,02	-

Bending moment check for M_y

According to EN 1993-1-1 article 6.2.5 and formula (6.12),(6.13)

$W_{pl,y}$	5,0808e-04	m ³
$M_{pl,y,Rd}$	180,37	kNm
Unity check	0,20	-

Bending moment check for M_z

According to EN 1993-1-1 article 6.2.5 and formula (6.12),(6.13)

$W_{pl,z}$	5,0808e-04	m ³
$M_{pl,z,Rd}$	180,37	kNm
Unity check	0,01	-

Shear check for V_y

According to EN 1993-1-1 article 6.2.6 and formula (6.17)

η	1,20	
A_v	3,6285e-03	m ²
$V_{pl,y,Rd}$	743,69	kN
Unity check	0,00	-

Shear check for V_z

According to EN 1993-1-1 article 6.2.6 and formula (6.17)

η	1,20	
A_v	3,6285e-03	m ²
$V_{pl,z,Rd}$	743,69	kN
Unity check	0,02	-

Torsion check

According to EN 1993-1-1 article 6.2.7 and formula (6.23)

Fibre	1	
T_{Ed}	0,0	MPa
T_{Rd}	205,0	MPa
Unity check	0,00	-

Note: The unity check for torsion is lower than the limit value of 0,05. Therefore torsion is considered as insignificant and is ignored in the combined checks.

Combined bending, axial force and shear force check

According to EN 1993-1-1 article 6.2.9.1 and formula (6.41)

$M_{N,y,Rd}$	180,37	kNm
α	1,66	
$M_{N,z,Rd}$	180,37	kNm
β	1,66	

Unity check (6.41) = 0,07 + 0,00 = 0,07 -

Note: Since the shear forces are less than half the plastic shear resistances their effect on the moment resistances is neglected.

Decision tables for combined section check

Force presence	
Axial force N_{Ed}	Present
Shear force $V_{y,Ed}$	Not significant
Shear force $V_{z,Ed}$	Not significant
Torsional moment T_{Ed}	Not significant
Bending moment $M_{y,Ed}$	Present
Bending moment $M_{z,Ed}$	Present
Significant shear force without corresponding bending moment	No
Warping data	Not present or negligible

Check inputs	
Classification is supported	Yes
Section classification	Class 1
Elastic verification is set by the user	No
Plastic shear formula is available	Yes
Combined bending and axial force formula is available	Yes
Combined bending and axial force check can be calculated	Yes

Selected check
According to EN 1993-1-1 article 6.2.9.1 and formula (6.41)

The member satisfies the section check.

STABILITY CHECK

Classification for member buckling design

Decisive position for stability classification: 17,431 m

Classification according to EN 1993-1-1 article 5.5.2

Classification of Internal and Outstand parts according to EN 1993-1-1 Table 5.2 Sheet 1 & 2

Id	Type	c [mm]	t [mm]	σ_1 [kN/m ²]	σ_2 [kN/m ²]	Ψ [-]	k_{σ} [-]	α [-]	c/t [-]	Class 1 Limit [-]	Class 2 Limit [-]	Class 3 Limit [-]	Class
1	I	170	10	9,073e+04	8,557e+04	0,94		1,00	17,00	22,78	27,66	31,54	1
3	I	170	10	7,667e+04	-6,947e+04	-0,91		0,52	17,00	54,37	63,05	91,31	1
5	I	170	10	-7,776e+04	-7,260e+04								
7	I	170	10	-6,370e+04	8,244e+04	-0,77		0,56	17,00	48,76	57,00	80,33	1

Note: The Classification limits have been set according to Semi-Comp+.

The cross-section is classified as Class 1

Flexural Buckling check

According to EN 1993-1-1 article 6.3.1.1 and formula (6.46)

Buckling parameters	yy	zz	
Sway type	sway	non-sway	
System length L	17,431	17,431	m
Buckling factor k	0,01	0,01	
Buckling length L_{cr}	0,100	0,100	m
Critical Euler load N_{cr}	8810818,90	8810818,90	kN
Slenderness λ	1,31	1,31	

Buckling parameters	yy	zz
Relative slenderness λ_{rel}	0,02	0,02
Limit slenderness $\lambda_{rel,0}$	0,20	0,20

Note: The slenderness or compression force is such that Flexural Buckling effects may be ignored according to EN 1993-1-1 article 6.3.1.2(4).

Torsional(-Flexural) Buckling check

According to EN 1993-1-1 article 6.3.1.1 and formula (6.46)

Note: The cross-section concerns a RHS section which is not susceptible to Torsional(-Flexural) Buckling.

Lateral Torsional Buckling check

According to EN 1993-1-1 article 6.3.2.1

Note: The cross-section concerns an RHS section with $h/b < 10 / \lambda_{rel,z}^2$.

This section is thus not susceptible to Lateral Torsional Buckling.

LTB additional parameters		
Minimal z coordinate z_{min}	-100	mm
Maximal z coordinate z_{max}	100	mm
Relative slenderness $\lambda_{rel,z}$	0,02	
End moment ratio ψ	0,96	
Equivalent point load F	12,22	kN
Equivalent line load q	1,40	kN/m
Difference with M	726,06	kNm
Difference with F	168,20	kNm
Difference with q	0,00	kNm
Resulting load type	line load q	

Bending and axial compression check

According to EN 1993-1-1 article 6.3.3 and formula (6.61),(6.62)

Bending and axial compression check parameters		
Interaction method	alternative method 1	
Cross-section area A	7,2570e-03	m ²
Plastic section modulus $W_{pl,y}$	5,0808e-04	m ³
Plastic section modulus $W_{pl,z}$	5,0808e-04	m ³
Design compression force N_{Ed}	47,05	kN
Design bending moment (maximum) $M_{y,Ed}$	-36,53	kNm
Design bending moment (maximum) $M_{z,Ed}$	-1,29	kNm
Characteristic compression resistance N_{Rk}	2576,24	kN
Characteristic moment resistance $M_{y,Rk}$	180,37	kNm
Characteristic moment resistance $M_{z,Rk}$	180,37	kNm
Reduction factor χ_y	1,00	
Reduction factor χ_z	1,00	
Reduction factor χ_{LT}	1,00	
Interaction factor k_{yy}	0,99	
Interaction factor k_{yz}	0,43	
Interaction factor k_{zy}	0,60	
Interaction factor k_{zz}	0,71	

 Maximum moment $M_{y,Ed}$ is derived from beam B3314 position 17,431 m.

 Maximum moment $M_{z,Ed}$ is derived from beam B3314 position 17,431 m.

Interaction method 1 parameters		
Critical Euler load $N_{cr,y}$	8810818,90	kN
Critical Euler load $N_{cr,z}$	8810818,90	kN
Elastic critical load $N_{cr,T}$	487685,45	kN
Plastic section modulus $W_{pl,y}$	5,0808e-04	m ³
Elastic section modulus $W_{el,y}$	4,2511e-04	m ³
Plastic section modulus $W_{pl,z}$	5,0808e-04	m ³
Elastic section modulus $W_{el,z}$	4,2511e-04	m ³
Second moment of area I_y	4,2511e-05	m ⁴
Second moment of area I_z	4,2511e-05	m ⁴
Torsional constant I_t	7,0717e-05	m ⁴
Method for equivalent moment factor $C_{my,0}$	Table A.2 Line 2 (General)	
Design bending moment (maximum) $M_{y,Ed}$	-36,53	kNm
Maximum relative deflection δ_z	-36,6	mm
Equivalent moment factor $C_{my,0}$	1,00	
Method for equivalent moment factor $C_{mz,0}$	Table A.2 Line 1 (Linear)	
Ratio of end moments ψ_z	-0,34	
Equivalent moment factor $C_{mz,0}$	0,72	
Factor μ_y	1,00	
Factor μ_z	1,00	
Factor ϵ_y	13,26	
Factor a_{LT}	0,00	
Critical moment for uniform bending $M_{cr,0}$	1287,20	kNm
Relative slenderness $\lambda_{rel,0}$	0,37	
Limit relative slenderness $\lambda_{rel,0,lim}$	0,33	
Equivalent moment factor C_{my}	1,00	
Equivalent moment factor C_{mz}	0,72	
Equivalent moment factor C_{mLT}	1,00	
Factor b_{LT}	0,00	

Interaction method 1 parameters		
Factor c_{LT}	0,00	
Factor d_{LT}	0,00	
Factor e_{LT}	0,00	
Factor w_y	1,20	
Factor w_z	1,20	
Factor η_{pl}	0,02	
Maximum relative slenderness $\lambda_{rel,max}$	0,02	
Factor C_{yy}	1,01	
Factor C_{yz}	1,01	
Factor C_{zy}	1,01	
Factor C_{zz}	1,01	

Unity check (6.61) = 0,02 + 0,20 + 0,00 = 0,22 -

Unity check (6.62) = 0,02 + 0,12 + 0,01 = 0,14 -

The member satisfies the stability check.

....:SECTION CHECK:....

The critical check is on position 0,000 m

Internal forces	Calculated	Unit
N_{Ed}	6,97	kN
$V_{y,Ed}$	43,39	kN
$V_{z,Ed}$	0,12	kN
T_{Ed}	-0,44	kNm
$M_{y,Ed}$	0,01	kNm
$M_{z,Ed}$	-21,21	kNm

Classification for cross-section design

Classification according to EN 1993-1-1 article 5.5.2

Classification of Internal and Outstand parts according to EN 1993-1-1 Table 5.2 Sheet 1 & 2

Id	Type	c [mm]	t [mm]	σ_1 [kN/m ²]	σ_2 [kN/m ²]	ψ [-]	K_σ [-]	α [-]	c/t [-]	Class 1 Limit [-]	Class 2 Limit [-]	Class 3 Limit [-]	Class
1	I	122	6	1,383e+05	-1,429e+05	-1,03		0,49	20,33	59,55	68,65	104,24	1
3	I	122	6	-1,567e+05	-1,566e+05								
5	I	122	6	-1,428e+05	1,384e+05	-1,03		0,49	20,33	59,50	68,59	104,07	1
7	I	122	6	1,523e+05	1,522e+05	1,00		1,00	20,33	22,78	27,66	30,92	1

Note: The Classification limits have been set according to Semi-Comp+.

The cross-section is classified as Class 1

Tension check

According to EN 1993-1-1 article 6.2.3 and formula (6.5)

A	3,1230e-03	m ²
$N_{p1,Rd}$	1108,66	kN
$N_{u,Rd}$	1101,79	kN
$N_{t,Rd}$	1101,79	kN
Unity check	0,01	-

Bending moment check for M_y

According to EN 1993-1-1 article 6.2.5 and formula (6.12),(6.13)

W_{ply}	1,5533e-04	m ³
$M_{ply,Rd}$	55,14	kNm
Unity check	0,00	-

Bending moment check for M_z

According to EN 1993-1-1 article 6.2.5 and formula (6.12),(6.13)

$W_{pl,z}$	1,5533e-04	m ³
$M_{pl,z,Rd}$	55,14	kNm
Unity check	0,38	-

Shear check for V_y

According to EN 1993-1-1 article 6.2.6 and formula (6.17)

η	1,20	
A_v	1,5615e-03	m ²
$V_{ply,Rd}$	320,04	kN

Unity check	0,14	-
-------------	------	---

Shear check for V_z

According to EN 1993-1-1 article 6.2.6 and formula (6.17)

η	1,20	
A_v	1,5615e-03	m ²
$V_{pl,z,Rd}$	320,04	kN
Unity check	0,00	-

Torsion check

According to EN 1993-1-1 article 6.2.7 and formula (6.23)

Fibre	1	
T_{Ed}	2,0	MPa
T_{Rd}	205,0	MPa
Unity check	0,01	-

Note: The unity check for torsion is lower than the limit value of 0,05. Therefore torsion is considered as insignificant and is ignored in the combined checks.

Combined bending, axial force and shear force check

According to EN 1993-1-1 article 6.2.9.1 and formula (6.41)

$M_{N,y,Rd}$	55,14	kNm
α	1,66	
$M_{N,z,Rd}$	55,14	kNm
β	1,66	

Unity check (6.41) = $0,00 + 0,20 = 0,20$

Note: Since the shear forces are less than half the plastic shear resistances their effect on the moment resistances is neglected.

Decision tables for combined section check

Force presence	
Axial force N_{Ed}	Present
Shear force $V_{y,Ed}$	Not significant
Shear force $V_{z,Ed}$	Not significant
Torsional moment T_{Ed}	Not significant
Bending moment $M_{y,Ed}$	Present
Bending moment $M_{z,Ed}$	Present
Significant shear force without corresponding bending moment	No
Warping data	Not present or negligible

Check inputs	
Classification is supported	Yes
Section classification	Class 1
Elastic verification is set by the user	No
Plastic shear formula is available	Yes
Combined bending and axial force formula is available	Yes
Combined bending and axial force check can be calculated	Yes

Selected check
According to EN 1993-1-1 article 6.2.9.1 and formula (6.41)

The member satisfies the section check.

...:STABILITY CHECK:...:

Classification for member buckling design

Decisive position for stability classification: 0,000 m

Classification according to EN 1993-1-1 article 5.5.2

Classification of Internal and Outstand parts according to EN 1993-1-1 Table 5.2 Sheet 1 & 2

Id	Type	c [mm]	t [mm]	σ_1 [kN/m ²]	σ_2 [kN/m ²]	Ψ [-]	k_σ [-]	α [-]	c/t [-]	Class 1 Limit [-]	Class 2 Limit [-]	Class 3 Limit [-]	Class
1	I	122	6	1,383e+05	-1,429e+05	-1,03		0,49	20,33	59,55	68,65	104,24	1
3	I	122	6	-1,567e+05	-1,566e+05								
5	I	122	6	-1,428e+05	1,384e+05	-1,03		0,49	20,33	59,50	68,59	104,07	1
7	I	122	6	1,523e+05	1,522e+05	1,00		1,00	20,33	22,78	27,66	30,92	1

Note: The Classification limits have been set according to Semi-Comp+.

The cross-section is classified as Class 1

Lateral Torsional Buckling check

According to EN 1993-1-1 article 6.3.2.1

Note: The cross-section concerns an RHS section with ' $h / b < 10 / \lambda_{rel,z}$ '.

This section is thus not susceptible to Lateral Torsional Buckling.

LTB additional parameters		
Minimal z coordinate z_{min}	-70	mm
Maximal z coordinate z_{max}	70	mm
Relative slenderness $\lambda_{rel,z}$	0,15	

LTB additional parameters		
End moment ratio ψ	0,06	
Equivalent point load F	0,00	kN
Equivalent line load q	0,00	kN/m
Difference with M	0,00	kNm
Difference with F	0,00	kNm
Difference with q	0,00	kNm
Resulting load type	linear moment M	

The member satisfies the stability check.

4.6.7. REZNE SILE – GORNJI POJAS SEKUNDARNOG REŠETKASTOG NOSAČA

My

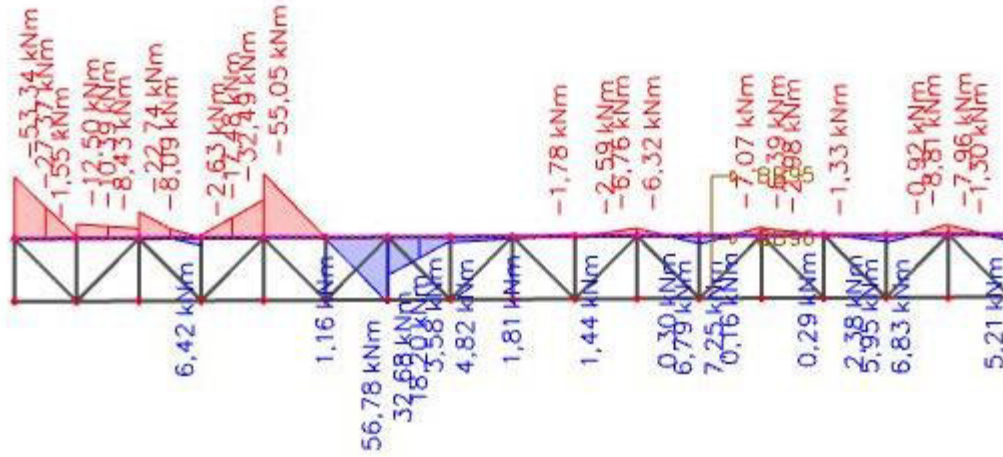

Vz

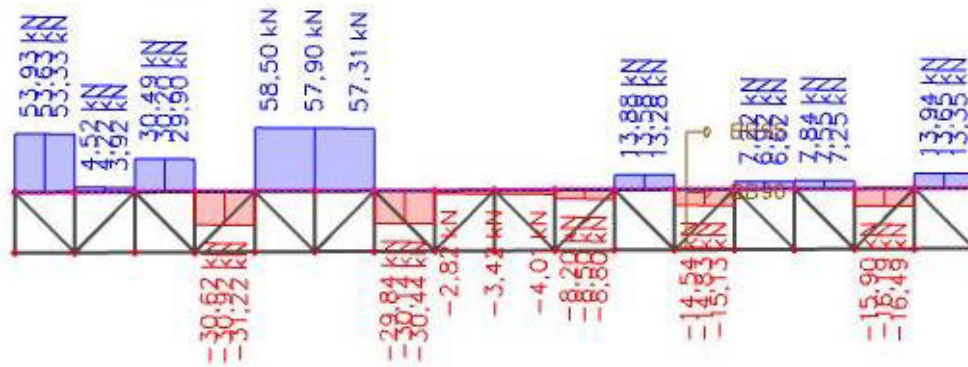

N

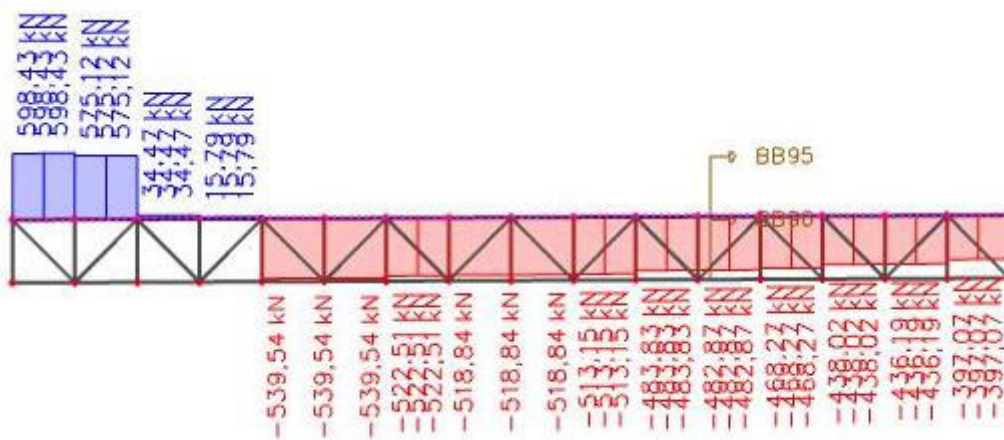

4.6.8. DIMENZIONIRANJE–GORNJI POJAS SEKUNDARNOG REŠETKASTOG NOSAČA

EC-EN 1993 Steel check ULS

Linear calculation
Combination: GSN4
Coordinate system: Principal
Extreme ID: Member
Selection: B857

EN 1993-1-1 Code Check
National annex: Standard EN

Member B857 | **3,862 / 15,450 m** | **CFRHS200X200X8** | **S 355** | **GSN4** | **0,15 -**

Note: EN 1993-1-3 article 1.1(3) specifies that this part does not apply to cold formed CHS and RHS sections. The default EN 1993-1-1 code check is executed instead of the EN 1993-1-3 code check.

Combination key
GSN4 / 1.35*vlastita težina + 1.50*pokretno + 1.35*dodatno stalno + 1.50*vjetar smjer x + 0.90*temperatura pozitivna

Partial safety factors	
γ_{M0} for resistance of cross-sections	1,00
γ_{M1} for resistance to instability	1,00
γ_{M2} for resistance of net sections	1,25

Material	
Yield strength f_y	355,0 MPa
Ultimate strength f_u	490,0 MPa
Fabrication	Cold formed

....:SECTION CHECK:....

The critical check is on position 3,862 m

Internal forces	Calculated	Unit
N_{Ed}	-189,63	kN
$V_{y,Ed}$	0,04	kN
$V_{z,Ed}$	9,11	kN
T_{Ed}	-0,34	kNm
$M_{y,Ed}$	-8,47	kNm
$M_{z,Ed}$	-0,43	kNm

Classification for cross-section design
Classification according to EN 1993-1-1 article 5.5.2
Classification of Internal and Outstand parts according to EN 1993-1-1 Table 5.2 Sheet 1 & 2

Id	Type	c [mm]	t [mm]	σ_1 [kN/m ²]	σ_2 [kN/m ²]	ψ [-]	k_{σ} [-]	α [-]	c/t [-]	Class 1 Limit [-]	Class 2 Limit [-]	Class 3 Limit [-]	Class [-]
1	I	176	8	5,589e+04	5,376e+04	0,96	1,00	22,00	22,00	22,78	27,66	31,33	1
3	I	176	8	5,176e+04	9,941e+03	0,19	1,00	22,00	22,78	27,66	42,96	1	
5	I	176	8	8,137e+03	1,027e+04	0,79	1,00	22,00	22,78	27,66	33,32	1	
7	I	176	8	1,227e+04	5,409e+04	0,23	1,00	22,00	22,78	27,66	42,25	1	

Note: The Classification limits have been set according to Semi-Comp+. The cross-section is classified as Class 1

Compression check

According to EN 1993-1-1 article 6.2.4 and formula (6.9)

A	5,9240e-03	m ²
$N_{c,Rd}$	2103,02	kN
Unity check	0,09	-

Bending moment check for M_y

According to EN 1993-1-1 article 6.2.5 and formula (6.12),(6.13)

W_{ply}	4,2086e-04	m ³
$M_{ply,Rd}$	149,41	kNm
Unity check	0,06	-

Bending moment check for M_z

According to EN 1993-1-1 article 6.2.5 and formula (6.12),(6.13)

W_{plz}	4,2086e-04	m ³
$M_{plz,Rd}$	149,41	kNm
Unity check	0,00	-

Shear check for V_y

According to EN 1993-1-1 article 6.2.6 and formula (6.17)

η	1,20	-
A_v	2,9620e-03	m ²
$V_{ply,Rd}$	607,09	kN
Unity check	0,00	-

Shear check for V_z

According to EN 1993-1-1 article 6.2.6 and formula (6.17)

η	1,20	
A_v	2,9620e-03	m ²
$V_{pl,z,Rd}$	607,09	kN
Unity check	0,02	-

Torsion check

According to EN 1993-1-1 article 6.2.7 and formula (6.23)

Fibre	1	
T_{Ed}	0,6	MPa
T_{Rd}	205,0	MPa
Unity check	0,00	-

Note: The unity check for torsion is lower than the limit value of 0,05. Therefore torsion is considered as insignificant and is ignored in the combined checks.

Combined bending, axial force and shear force check

According to EN 1993-1-1 article 6.2.9.1 and formula (6.41)

$M_{N,y,Rd}$	149,41	kNm
α	1,68	
$M_{N,z,Rd}$	149,41	kNm
β	1,68	

Unity check (6.41) = 0,01 + 0,00 = 0,01 -

Decision tables for combined section check

Force presence	
Axial force N_{Ed}	Present
Shear force $V_{y,Ed}$	Not significant
Shear force $V_{z,Ed}$	Not significant
Torsional moment T_{Ed}	Not significant
Bending moment $M_{y,Ed}$	Present
Bending moment $M_{z,Ed}$	Present
Significant shear force without corresponding bending moment	No
Warping data	Not present or negligible

Check inputs	
Classification is supported	Yes
Section classification	Class 1
Elastic verification is set by the user	No
Plastic shear formula is available	Yes
Combined bending and axial force formula is available	Yes
Combined bending and axial force check can be calculated	Yes

Selected check

According to EN 1993-1-1 article 6.2.9.1 and formula (6.41)

The member satisfies the section check.

....:STABILITY CHECK:....

Classification for member buckling design

Decisive position for stability classification: 3,862 m

Classification according to EN 1993-1-1 article 5.5.2

Classification of Internal and Outstand parts according to EN 1993-1-1 Table 5.2 Sheet 1 & 2

Id	Type	c [mm]	t [mm]	σ_1 [kN/m ²]	σ_2 [kN/m ²]	ψ [-]	k_{ϕ} [-]	α [-]	c/t [-]	Class 1 Limit [-]	Class 2 Limit [-]	Class 3 Limit [-]	Class
1	I	176	8	5,589e+04	5,376e+04	0,96		1,00	22,00	22,78	27,66	31,33	1
3	I	176	8	5,176e+04	9,941e+03	0,19		1,00	22,00	22,78	27,66	42,96	1
5	I	176	8	8,137e+03	1,027e+04	0,79		1,00	22,00	22,78	27,66	33,32	1
7	I	176	8	1,227e+04	5,409e+04	0,23		1,00	22,00	22,78	27,66	42,25	1

Note: The Classification limits have been set according to Semi-Comp+.

The cross-section is classified as Class 1

Flexural Buckling check

According to EN 1993-1-1 article 6.3.1.1 and formula (6.46)

Buckling parameters	yy	zz	
Sway type	sway	non-sway	
System length L	1,931	15,450	m
Buckling factor k	0,95	0,01	
Buckling length L_{cr}	0,100	0,100	m
Critical Euler load N_{cr}	7391470,11	7391470,11	kN
Slenderness λ	1,29	1,29	

Buckling parameters	yy	zz	
Relative slenderness λ_{rel}	0,02	0,02	
Limit slenderness $\lambda_{rel,0}$	0,20	0,20	

Note: The slenderness or compression force is such that Flexural Buckling effects may be ignored according to EN 1993-1-1 article 6.3.1.2(4).

Torsional(-Flexural) Buckling check

According to EN 1993-1-1 article 6.3.1.1 and formula (6.46)

Note: The cross-section concerns a RHS section which is not susceptible to Torsional(-Flexural) Buckling.

Lateral Torsional Buckling check

According to EN 1993-1-1 article 6.3.2.1

Note: The cross-section concerns an RHS section with ' $h / b < 10 / \lambda_{rel,z}$ '. This section is thus not susceptible to Lateral Torsional Buckling.

LTB additional parameters		
Minimal z coordinate z_{min}	-100	mm
Maximal z coordinate z_{max}	100	mm
Relative slenderness $\lambda_{rel,z}$	0,02	
End moment ratio ψ	0,03	
Equivalent point load F	1,80	kN
Equivalent line load q	0,23	kN/m
Difference with M	53,43	kNm
Difference with F	79,30	kNm
Difference with q	102,80	kNm
Resulting load type	point load F	

Bending and axial compression check

According to EN 1993-1-1 article 6.3.3 and formula (6.61),(6.62)

Bending and axial compression check parameters		
Interaction method	alternative method 1	
Cross-section area A	5,9240e-03	m ²
Plastic section modulus $W_{pl,y}$	4,2086e-04	m ³
Plastic section modulus $W_{pl,z}$	4,2086e-04	m ³
Design compression force N_{Ed}	189,63	kN
Design bending moment (maximum) $M_{y,Ed}$	-8,47	kNm
Design bending moment (maximum) $M_{z,Ed}$	-1,20	kNm
Characteristic compression resistance N_{Rk}	2103,02	kN
Characteristic moment resistance $M_{y,Rk}$	149,41	kNm
Characteristic moment resistance $M_{z,Rk}$	149,41	kNm
Reduction factor χ_y	1,00	
Reduction factor χ_z	1,00	
Reduction factor χ_{LT}	1,00	
Interaction factor k_{yy}	0,97	
Interaction factor k_{yz}	0,58	
Interaction factor k_{zy}	0,58	
Interaction factor k_{zz}	0,97	

Maximum moment $M_{y,Ed}$ is derived from beam B857 position 3,862 m.

Maximum moment $M_{z,Ed}$ is derived from beam B857 position 0,000 m.

Interaction method 1 parameters		
Critical Euler load $N_{cr,y}$	7391470,11	kN
Critical Euler load $N_{cr,z}$	7391470,11	kN
Elastic critical load $N_{cr,T}$	390259,62	kN
Plastic section modulus $W_{pl,y}$	4,2086e-04	m ³
Elastic section modulus $W_{el,y}$	3,5663e-04	m ³
Plastic section modulus $W_{pl,z}$	4,2086e-04	m ³
Elastic section modulus $W_{el,z}$	3,5663e-04	m ³
Second moment of area I_y	3,5662e-05	m ⁴
Second moment of area I_z	3,5662e-05	m ⁴
Torsional constant I_t	5,8152e-05	m ⁴
Method for equivalent moment factor $C_{my,0}$	Table A.2 Line 2 (General)	
Design bending moment (maximum) $M_{y,Ed}$	-8,47	kNm
Maximum relative deflection δ_z	0,0	mm
Equivalent moment factor $C_{my,0}$	1,00	
Method for equivalent moment factor $C_{mz,0}$	Table A.2 Line 2 (General)	
Design bending moment (maximum) $M_{z,Ed}$	-1,20	kNm
Maximum relative deflection δ_y	0,5	mm
Equivalent moment factor $C_{mz,0}$	1,00	
Factor μ_y	1,00	
Factor μ_z	1,00	
Factor E_f	0,74	
Factor α_{LT}	0,00	
Critical moment for uniform bending $M_{cr,0}$	1206,22	kNm
Relative slenderness $\lambda_{rel,0}$	0,35	
Limit relative slenderness $\lambda_{rel,lim}$	0,24	
Equivalent moment factor C_{my}	1,00	
Equivalent moment factor C_{mz}	1,00	
Equivalent moment factor C_{mLT}	1,00	

Interaction method 1 parameters		
Factor b_{LT}	0,00	
Factor c_{LT}	0,00	
Factor d_{LT}	0,00	
Factor e_{LT}	0,00	
Factor w_y	1,18	
Factor w_z	1,18	
Factor n_{pl}	0,09	
Maximum relative slenderness $\lambda_{rel,max}$	0,02	
Factor C_{yy}	1,03	
Factor C_{yz}	1,03	
Factor C_{zy}	1,03	
Factor C_{zz}	1,03	

Unity check (6.61) = 0,09 + 0,05 + 0,00 = 0,15 -

Unity check (6.62) = 0,09 + 0,03 + 0,01 = 0,13 -

The member satisfies the stability check.

4.6.9. REZNE SILE-ISPUNA SEKUNDARNOG REŠETKASTOG NOSAČA

N

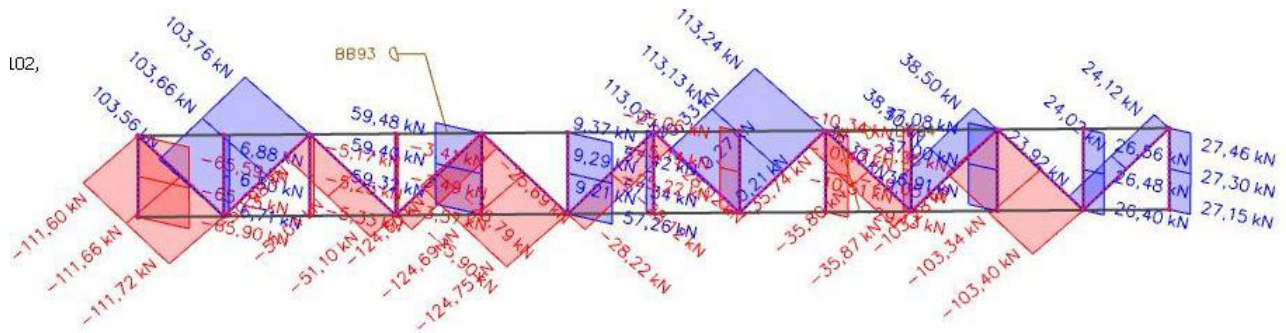

4.6.10. DIMENZIONIRANJE-ISPUNA SEKUNDARNOG REŠETKASTOG NOSAČA

EC-EN 1993 Steel check ULS

Linear calculation

Combination: GSN4

Coordinate system: Principal

Extreme 1D: Member

Selection: B2466

EN 1993-1-1 Code Check

National annex: Standard EN

Member B2466	1,355 / 1,355 m	CFRHS140X140X6	S 355	GSN4	0,57 -
--------------	-----------------	----------------	-------	------	--------

Note: EN 1993-1-3 article 1.1(3) specifies that this part does not apply to cold formed CHS and RHS sections. The default EN 1993-1-1 code check is executed instead of the EN 1993-1-3 code check.

Combination key

GSN4 / 1.35*vlastita težina + 1.50*pokretno + 1.35*dodatno stalno + 1.50*vjetar smjer x + 0.90*temperatura pozitivna

Partial safety factors

γ_{M0} for resistance of cross-sections	1,00
γ_{M1} for resistance to instability	1,00
γ_{M2} for resistance of net sections	1,25

Material

Yield strength f_y	355,0	MPa
Ultimate strength f_u	490,0	MPa
Fabrication	Cold formed	

...:SECTION CHECK:...

The critical check is on position 1,355 m

Internal forces	Calculated	Unit
N_{Ed}	-411,00	kN
$V_{y,Ed}$	-0,46	kN
$V_{z,Ed}$	7,39	kN
T_{Ed}	0,79	kNm
$M_{y,Ed}$	3,24	kNm
$M_{z,Ed}$	0,75	kNm

Classification for cross-section design

Classification according to EN 1993-1-1 article 5.5.2

Classification of Internal and Outstand parts according to EN 1993-1-1 Table 5.2 Sheet 1 & 2

Id	Type	c [mm]	t [mm]	σ_1 [kN/m ²]	σ_2 [kN/m ²]	ψ [-]	k_{σ} [-]	α [-]	c/t [-]	Class 1 Limit [-]	Class 2 Limit [-]	Class 3 Limit [-]	Class
1	I	122	6	1,030e+05	1,130e+05	0,91		1,00	20,33	22,78	27,66	31,90	1
3	I	122	6	1,156e+05	1,586e+05	0,73		1,00	20,33	22,78	27,66	34,13	1
5	I	122	6	1,602e+05	1,502e+05	0,94		1,00	20,33	22,78	27,66	31,60	1
7	I	122	6	1,476e+05	1,046e+05	0,71		1,00	20,33	22,78	27,66	34,39	1

Note: The Classification limits have been set according to Semi-Comp+. The cross-section is classified as Class 1

Compression check

According to EN 1993-1-1 article 6.2.4 and formula (6.9)

A	3,1230e-03	m ²
$N_{c,Rd}$	1108,66	kN
Unity check	0,37	-

Bending moment check for M_y

According to EN 1993-1-1 article 6.2.5 and formula (6.12),(6.13)

$W_{pl,y}$	1,5533e-04	m ³
$M_{pl,y,Rd}$	55,14	kNm
Unity check	0,06	-

Bending moment check for M_z

According to EN 1993-1-1 article 6.2.5 and formula (6.12),(6.13)

$W_{pl,z}$	1,5533e-04	m ³
$M_{pl,z,Rd}$	55,14	kNm
Unity check	0,01	-

Shear check for V_y

According to EN 1993-1-1 article 6.2.6 and formula (6.17)

η	1,20	
A_v	1,5615e-03	m ²
$V_{pl,y,Rd}$	320,04	kN
Unity check	0,00	-

Shear check for V_z

According to EN 1993-1-1 article 6.2.6 and formula (6.17)

η	1,20	
A_v	1,5615e-03	m ²
$V_{pl,z,Rd}$	320,04	kN
Unity check	0,02	-

Torsion check

According to EN 1993-1-1 article 6.2.7 and formula (6.23)

Fibre	1	
T_{Ed}	3,6	MPa
T_{Rd}	205,0	MPa
Unity check	0,02	-

Note: The unity check for torsion is lower than the limit value of 0,05. Therefore torsion is considered as insignificant and is ignored in the combined checks.

Combined bending, axial force and shear force check

According to EN 1993-1-1 article 6.2.9.1 and formula (6.41)

$M_{N,y,Rd}$	45,13	kNm
α	1,97	
$M_{N,z,Rd}$	45,13	kNm
β	1,97	

Unity check (6.41) = 0,01 + 0,00 = 0,01 -

Decision tables for combined section check

Force presence	
Axial force N_{Ed}	Present
Shear force $V_{y,Ed}$	Not significant
Shear force $V_{z,Ed}$	Not significant
Torsional moment T_{Ed}	Not significant
Bending moment $M_{y,Ed}$	Present
Bending moment $M_{z,Ed}$	Present
Significant shear force without corresponding bending moment	No
Warping data	Not present or negligible

Check inputs	
Classification is supported	Yes
Section classification	Class 1
Elastic verification is set by the user	No
Plastic shear formula is available	Yes
Combined bending and axial force formula is available	Yes
Combined bending and axial force check can be calculated	Yes

Selected check	
According to EN 1993-1-1 article 6.2.9.1 and formula (6.41)	

The member satisfies the section check.

....:STABILITY CHECK:....
Classification for member buckling design

Decisive position for stability classification: 0,000 m

Classification according to EN 1993-1-1 article 5.5.2

Classification of Internal and Outstand parts according to EN 1993-1-1 Table 5.2 Sheet 1 & 2

Id	Type	c [mm]	t [mm]	σ_1 [kN/m ²]	σ_2 [kN/m ²]	Ψ [-]	k_σ [-]	α [-]	c/t [-]	Class 1 Limit [-]	Class 2 Limit [-]	Class 3 Limit [-]	Class
1	I	122	6	1,732e+05	1,914e+05	0,90		1,00	20,33	22,78	27,66	31,97	1
3	I	122	6	1,878e+05	9,523e+04	0,51		1,00	20,33	22,78	27,66	37,30	1
5	I	122	6	8,979e+04	7,159e+04	0,80		1,00	20,33	22,78	27,66	33,26	1
7	I	122	6	7,524e+04	1,678e+05	0,45		1,00	20,33	22,78	27,66	38,24	1

Note: The Classification limits have been set according to Semi-Comp+.

The cross-section is classified as Class 1

Flexural Buckling check

According to EN 1993-1-1 article 6.3.1.1 and formula (6.46)

Buckling parameters	yy	zz	
Sway type	sway	non-sway	
System length L	1,355	1,355	m
Buckling factor k	1,52	0,93	
Buckling length L_{cr}	2,062	1,254	m
Critical Euler load N_{cr}	4485,91	12126,20	kN
Slenderness λ	37,99	23,10	

Buckling parameters	yy	zz	
Relative slenderness λ_{rel}	0,50	0,30	
Limit slenderness $\lambda_{rel,0}$	0,20	0,20	
Buckling curve	c	c	
Imperfection α	0,49	0,49	
Reduction factor χ	0,84	0,95	
Buckling resistance $N_{b,Rd}$	936,37	1050,95	kN

Flexural Buckling verification		
Cross-section area A	3,1230e-03	m ²
Buckling resistance $N_{b,Rd}$	936,37	kN
Unity check	0,44	-

Torsional(-Flexural) Buckling check

According to EN 1993-1-1 article 6.3.1.1 and formula (6.46)

Note: The cross-section concerns a RHS section which is not susceptible to Torsional(-Flexural) Buckling.

Lateral Torsional Buckling check

According to EN 1993-1-1 article 6.3.2.1

Note: The cross-section concerns an RHS section with ' $h / b < 10 / \lambda_{rel,z}$ '.

This section is thus not susceptible to Lateral Torsional Buckling.

LTB additional parameters		
Minimal z coordinate Z_{min}	-70	mm
Maximal z coordinate Z_{max}	70	mm
Relative slenderness $\lambda_{rel,z}$	0,30	
End moment ratio ψ	-0,46	
Equivalent point load F	0,16	kN
Equivalent line load q	0,23	kN/m
Difference with M	0,05	kNm
Difference with F	0,00	kNm
Difference with q	0,00	kNm
Resulting load type	line load q	

Bending and axial compression check

According to EN 1993-1-1 article 6.3.3 and formula (6.61),(6.62)

Bending and axial compression check parameters		
Interaction method	alternative method 1	
Cross-section area A	3,1230e-03	m ²
Plastic section modulus $W_{pl,y}$	1,5533e-04	m ³
Plastic section modulus $W_{pl,z}$	1,5533e-04	m ³
Design compression force N_{Ed}	411,00	kN
Design bending moment (maximum) $M_{y,Ed}$	-6,98	kNm
Design bending moment (maximum) $M_{z,Ed}$	1,37	kNm
Characteristic compression resistance N_{Rk}	1108,66	kN
Characteristic moment resistance $M_{y,Rk}$	55,14	kNm
Characteristic moment resistance $M_{z,Rk}$	55,14	kNm
Reduction factor χ_y	0,84	
Reduction factor χ_z	0,95	
Reduction factor χ_{LT}	1,00	
Interaction factor k_{yy}	0,95	
Interaction factor k_{yz}	0,53	
Interaction factor k_{zy}	0,59	
Interaction factor k_{zz}	0,87	

 Maximum moment $M_{y,Ed}$ is derived from beam B2466 position 0,000 m.

 Maximum moment $M_{z,Ed}$ is derived from beam B2466 position 0,000 m.

Interaction method 1 parameters		
Critical Euler load $N_{cr,y}$	4485,91	kN
Critical Euler load $N_{cr,z}$	12126,20	kN
Elastic critical load $N_{cr,T}$	207780,23	kN
Plastic section modulus $W_{pl,y}$	1,5533e-04	m ³
Elastic section modulus $W_{el,y}$	1,3149e-04	m ³
Plastic section modulus $W_{pl,z}$	1,5533e-04	m ³
Elastic section modulus $W_{el,z}$	1,3149e-04	m ³
Second moment of area I_y	9,2043e-06	m ⁴
Second moment of area I_z	9,2043e-06	m ⁴
Torsional constant I_t	1,4788e-05	m ⁴
Method for equivalent moment factor $C_{my,0}$	Table A.2 Line 2 (General)	
Design bending moment (maximum) $M_{y,Ed}$	-6,98	kNm
Maximum relative deflection δ_z	0,2	mm
Equivalent moment factor $C_{my,0}$	0,94	
Method for equivalent moment factor $C_{mz,0}$	Table A.2 Line 1 (Linear)	
Ratio of end moments ψ_z	0,55	
Equivalent moment factor $C_{mz,0}$	0,91	
Factor μ_y	0,98	
Factor μ_z	1,00	
Factor ε_y	0,40	
Factor $a_{l,T}$	0,00	
Critical moment for uniform bending $M_{cr,0}$	3568,38	kNm

Interaction method 1 parameters	
Relative slenderness $\lambda_{rel,0}$	0,12
Limit relative slenderness $\lambda_{rel,0,lim}$	0,30
Equivalent moment factor C_{my}	0,94
Equivalent moment factor C_{mz}	0,91
Equivalent moment factor C_{mLT}	1,00
Factor b_{LT}	0,00
Factor c_{LT}	0,00
Factor d_{LT}	0,00
Factor e_{LT}	0,00
Factor w_y	1,18
Factor w_z	1,18
Factor η_{pl}	0,37
Maximum relative slenderness $\lambda_{rel,max}$	0,50
Factor C_{yy}	1,07
Factor C_{yz}	1,05
Factor C_{zy}	1,05
Factor C_{zz}	1,08

Unity check (6.61) = $0,44 + 0,12 + 0,01 = 0,57$ -

Unity check (6.62) = $0,39 + 0,07 + 0,02 = 0,49$ -

The member satisfies the stability check.

4.7. DIMENZIONIRANJE GLAVNOG NOSAČA-STUBIŠTE POZ 100

4.7.1. REZNE SILE –GLAVNI NOSAČ STUBIŠTE POZ 100

My

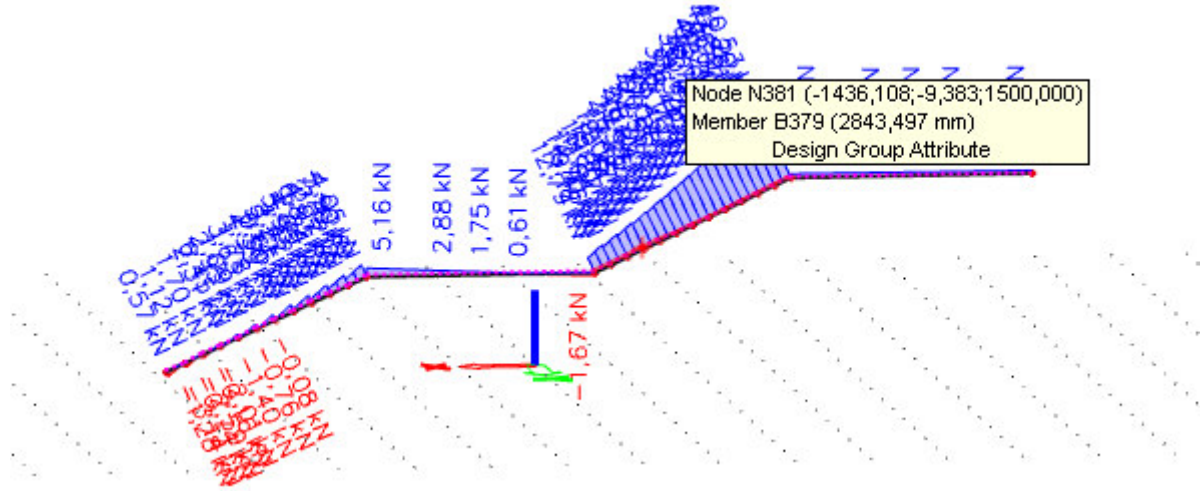

Vz

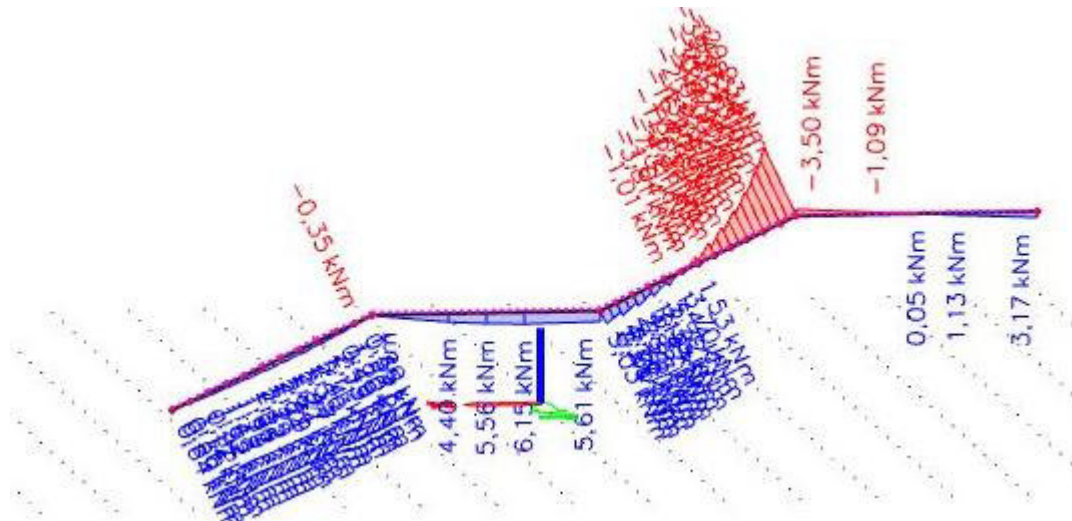

N

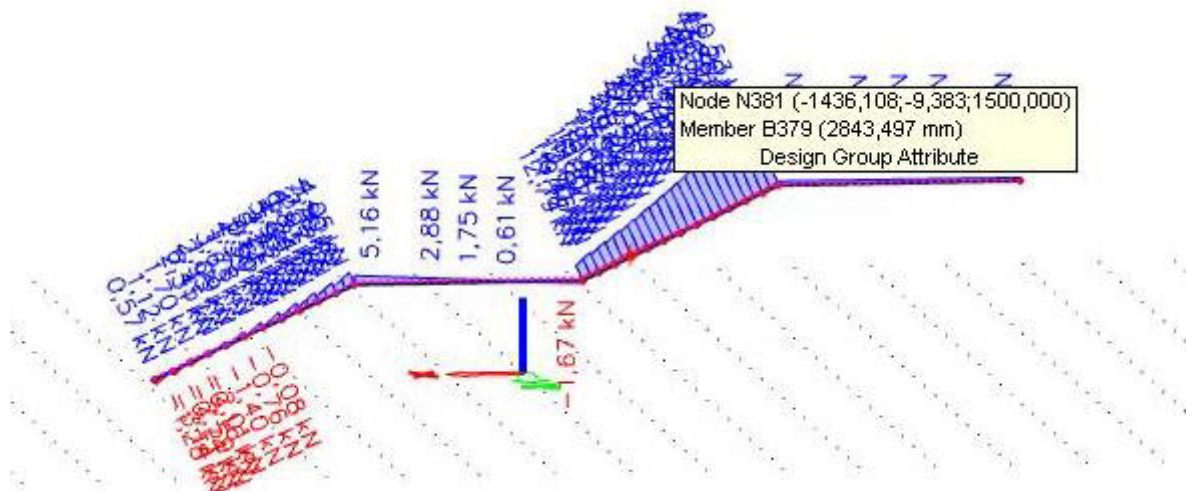

4.7.2. DIMENZIONIRANJE – GLAVNI NOSAČ STUBIŠTE POZ 100

EC-EN 1993 Steel check ULS

Linear calculation
Combination: GSN4
Coordinate system: Principal
Extreme ID: Member
Selection: B381

EN 1993-1-1 Code Check

National annex: Standard EN

Member B381 | **0,000 / 2,900 m** | **IPE300** | **S 355** | **GSN4** | **0,32 -**

Combination key

GSN4 / 1.35*vlastita težina + 1.50*pokretno +
1.35*dodatno stalno + 1.50*vjetar smjer x +
0.90*temperatura pozitivna

Partial safety factors

γ_{M0} for resistance of cross-sections	1,00
γ_{M1} for resistance to instability	1,00
γ_{M2} for resistance of net sections	1,25

Material

Yield strength f_y	355,0	MPa
Ultimate strength f_u	490,0	MPa
Fabrication	Rolled	

....SECTION CHECK:....

The critical check is on position **0,000 m**

Internal forces	Calculated	Unit
N_{Ed}	-22,96	kN
$V_{y,Ed}$	36,80	kN
$V_{z,Ed}$	8,97	kN
T_{Ed}	-0,47	kNm
$M_{y,Ed}$	5,29	kNm
$M_{z,Ed}$	-13,98	kNm

Classification for cross-section design

Classification according to EN 1993-1-1 article 5.5.2

Classification of Internal and Outstand parts according to EN 1993-1-1 Table 5.2 Sheet 1 & 2

Id	Type	c [mm]	t [mm]	σ_1 [kN/m ²]	σ_2 [kN/m ²]	ψ [-]	k_{σ} [-]	α [-]	c/t [-]	Class 1 Limit [-]	Class 2 Limit [-]	Class 3 Limit [-]	Class
1	SO	56	11	3,807e+04	1,688e+05	0,23	0,53	1,00	5,28	7,32	8,14	12,39	1
3	SO	56	11	-4,786e+04	-1,786e+05								
4	I	249	7	-3,606e+03	1,214e+04	-0,30		0,52	35,01	55,39	64,14	56,22	1
5	SO	56	11	-2,954e+04	-1,603e+05								
7	SO	56	11	5,639e+04	1,871e+05	0,30	0,51	1,00	5,28	7,32	8,14	12,24	1

Note: The Classification limits have been set according to Semi-Comp+.

The cross-section is classified as Class 1

Compression check

According to EN 1993-1-1 article 6.2.4 and formula (6.9)

A	5,3800e-03	m ²
N _{c,Rd}	1909,90	kN
Unity check	0,01	-

Bending moment check for M_y

According to EN 1993-1-1 article 6.2.5 and formula (6.12),(6.13)

W _{ply}	6,2800e-04	m ³
M _{pl,y,Rd}	222,94	kNm
Unity check	0,02	-

Bending moment check for M_z

According to EN 1993-1-1 article 6.2.5 and formula (6.12),(6.13)

W _{pl,z}	1,2500e-04	m ³
M _{pl,z,Rd}	44,38	kNm
Unity check	0,32	-

Shear check for V_y

According to EN 1993-1-1 article 6.2.6 and formula (6.17)

η	1,20	
A _v	3,3669e-03	m ²
V _{pl,y,Rd}	690,08	kN
Unity check	0,05	-

Shear check for V_z

According to EN 1993-1-1 article 6.2.6 and formula (6.17)

η	1,20	
A _v	2,5670e-03	m ²
V _{pl,z,Rd}	526,12	kN
Unity check	0,02	-

Torsion check

According to EN 1993-1-1 article 6.2.7 and formula (6.23)

Fibre	2	
T _{Ed}	25,0	MPa
T _{Rd}	205,0	MPa
Unity check	0,12	-

Combined Shear and Torsion check for V_y and τ_{t,Ed}

According to EN 1993-1-1 article 6.2.6 & 6.2.7 and formula (6.25),(6.26)

V _{pl,T,y,Rd}	655,59	kN
Unity check	0,06	-

Combined Shear and Torsion check for V_z and τ_{t,Ed}

According to EN 1993-1-1 article 6.2.6 & 6.2.7 and formula (6.25),(6.26)

V _{pl,T,z,Rd}	499,83	kN
Unity check	0,02	-

Combined bending, axial force and shear force check

According to EN 1993-1-1 article 6.2.9.1 and formula (6.41)

M _{pl,y,Rd}	222,94	kNm
α	2,00	
M _{pl,z,Rd}	44,38	kNm
β	1,00	

Unity check (6.41) = 0,00 + 0,32 = 0,32 -

Note: Since the shear forces are less than half the plastic shear resistances their effect on the moment resistances is neglected.

Note: Since the axial force satisfies both criteria (6.33) and (6.34) of EN 1993-1-1 article 6.2.9.1(4) its effect on the moment resistance about the y-y axis is neglected.

Note: Since the axial force satisfies criteria (6.35) of EN 1993-1-1 article 6.2.9.1(4) its effect on the moment resistance about the z-z axis is neglected.

Decision tables for combined section check

Force presence	
Axial force N _{Ed}	Present
Shear force V _{y,Ed}	Not significant
Shear force V _{z,Ed}	Not significant
Torsional moment T _{Ed}	Present
Bending moment M _{y,Ed}	Present
Bending moment M _{z,Ed}	Present
Significant shear force without corresponding bending moment	No
Torsional moment without shear force	No
Warping data	Not present or negligible

Check inputs	
Classification is supported	Yes
Section classification	Class 1
Elastic verification is set by the user	No
Plastic shear formula is available	Yes
Combined shear and torsion formula is available	Yes
Combined shear and torsion check can be calculated	Yes
Combined bending and axial force formula is available	Yes
Combined bending and axial force check can be calculated	Yes

Selected check	
According to EN 1993-1-1 article 6.2.9.1 and formula (6.41)	

The member satisfies the section check.

....:STABILITY CHECK:....

Classification for member buckling design

Decisive position for stability classification: 0,000 m

Classification according to EN 1993-1-1 article 5.5.2

Classification of Internal and Outstand parts according to EN 1993-1-1 Table 5.2 Sheet 1 & 2

Id	Type	c [mm]	t [mm]	σ_1 [kN/m ²]	σ_2 [kN/m ²]	ψ [-]	k_{σ} [-]	α [-]	c/t [-]	Class 1 Limit [-]	Class 2 Limit [-]	Class 3 Limit [-]	Class
1	SO	56	11	3,807e+04	1,688e+05	0,23	0,53	1,00	5,28	7,32	8,14	12,39	1
3	SO	56	11	-4,786e+04	-1,786e+05								
4	I	249	7	-3,606e+03	1,214e+04	-0,30		0,52	35,01	55,39	64,14	56,22	1
5	SO	56	11	-2,954e+04	-1,603e+05								
7	SO	56	11	5,639e+04	1,871e+05	0,30	0,51	1,00	5,28	7,32	8,14	12,24	1

Note: The Classification limits have been set according to Semi-Cc
The cross-section is classified as Class 1

Flexural Buckling check

According to EN 1993-1-1 article 6.3.1.1 and formula (6.46)

Buckling parameters	yy	zz	
Sway type	sway	non-sway	
System length L	2,900	0,264	m
Buckling factor k	4,51	0,84	
Buckling length L_{cr}	13,083	0,223	m
Critical Euler load N_{cr}	1011,80	252542,71	kN
Slenderness λ	104,98	6,64	
Relative slenderness λ_{rel}	1,37	0,09	
Limit slenderness $\lambda_{rel,0}$	0,20	0,20	

Note: The slenderness or compression force is such that Flexural I according to EN 1993-1-1 article 6.3.1.2(4).

Torsional(-Flexural) Buckling check

According to EN 1993-1-1 article 6.3.1.1 and formula (6.46)

Note: For this I-section the Torsional(-Flexural) buckling resistance for Flexural buckling. Therefore Torsional(-Flexural) buckling is not

Lateral Torsional Buckling check

According to EN 1993-1-1 article 6.3.2.1 & 6.3.2.3 and formula (6.4)

LTB parameters		
Method for LTB curve	Alternative case	
Plastic section modulus $W_{pl,y}$	6,2800e-04	m ³
Elastic critical moment M_{cr}	29483,23	kNm
Relative slenderness $\lambda_{rel,LT}$	0,09	
Limit slenderness $\lambda_{rel,LT,0}$	0,40	

Note: The slenderness or bending moment is such that Lateral To may be ignored according to EN 1993-1-1 article 6.3.2.2(4).

Mcr parameters		
LTB length L	0,264	m
Influence of load position	no influence	
Correction factor k	1,00	
Correction factor k_{σ}	1,00	
LTB moment factor C_1	1,13	
LTB moment factor C_2	0,01	
LTB moment factor C_3	1,00	
Shear center distance d_s	0	mm
Distance of load application z_p	0	mm
Mono-symmetry constant β_y	0	mm
Mono-symmetry constant z_1	0	mm

Note: C parameters are determined according to ECCS 119 2006 / Galea 2002.

LTB additional parameters		
Minimal z coordinate z_{min}	-150	mm
Maximal z coordinate z_{max}	150	mm
End moment ratio ψ	0,74	
Equivalent point load F	1,90	kN
Equivalent line load q	14,42	kN/m
Difference with M	0,13	kNm
Difference with F	0,00	kNm
Difference with q	0,00	kNm
Resulting load type	line load q	

Bending and axial compression check

According to EN 1993-1-1 article 6.3.3 and formula (6.61),(6.62)

Bending and axial compression check parameters		
Interaction method	alternative method 1	
Cross-section area A	5,3800e-03	m ²
Plastic section modulus $W_{pl,y}$	6,2800e-04	m ³
Plastic section modulus $W_{pl,z}$	1,2500e-04	m ³
Design compression force N_{Ed}	22,96	kN
Design bending moment (maximum) $M_{y,Ed}$	7,30	kNm
Design bending moment (maximum) $M_{z,Ed}$	-13,98	kNm
Characteristic compression resistance N_{Rk}	1909,90	kN
Characteristic moment resistance $M_{y,Rk}$	222,94	kNm
Characteristic moment resistance $M_{z,Rk}$	44,38	kNm
Reduction factor χ_y	1,00	
Reduction factor χ_z	1,00	
Modified reduction factor $\chi_{LT,mod}$	1,00	
Interaction factor k_{yy}	1,03	
Interaction factor k_{yz}	0,59	
Interaction factor k_{zy}	0,55	
Interaction factor k_{zz}	0,86	

Maximum moment $M_{y,Ed}$ is derived from beam B381 position 0,923 m.

Maximum moment $M_{z,Ed}$ is derived from beam B381 position 0,000 m.

Interaction method-1 parameters		
Critical Euler load $N_{cr,y}$	1011,80	kN
Critical Euler load $N_{cr,z}$	252542,71	kN
Elastic critical load $N_{cr,T}$	226592,87	kN
Plastic section modulus $W_{pl,y}$	6,2800e-04	m ³
Elastic section modulus $W_{el,y}$	5,5700e-04	m ³
Plastic section modulus $W_{pl,z}$	1,2500e-04	m ³
Elastic section modulus $W_{el,z}$	8,0500e-05	m ³
Second moment of area I_y	8,3560e-05	m ⁴
Second moment of area I_z	6,0400e-06	m ⁴
Torsional constant I_t	2,0100e-07	m ⁴
Method for equivalent moment factor $C_{my,0}$	Table A.2 Line 2 (General)	
Design bending moment (maximum) $M_{y,Ed}$	7,30	kNm
Maximum relative deflection δ_z	-0,4	mm
Equivalent moment factor $C_{my,0}$	1,00	
Method for equivalent moment factor $C_{mz,0}$	Table A.2 Line 1 (Linear)	
Ratio of end moments ψ_z	0,31	
Equivalent moment factor $C_{mz,0}$	0,85	
Factor μ_y	1,00	
Factor μ_z	1,00	
Factor ϵ_y	3,07	
Factor $a_{y,T}$	1,00	
Critical moment for uniform bending $M_{cr,0}$	26071,68	kNm
Relative slenderness $\lambda_{rel,0}$	0,09	
Limit relative slenderness $\lambda_{rel,0,lim}$	0,21	
Equivalent moment factor C_{my}	1,00	
Equivalent moment factor C_{mz}	0,85	
Equivalent moment factor $C_{mz,T}$	1,00	
Factor b_{LT}	0,00	
Factor c_{LT}	0,00	
Factor d_{LT}	0,02	
Factor e_{LT}	0,05	
Factor w_y	1,13	
Factor w_z	1,50	
Factor η_{pl}	0,01	
Maximum relative slenderness $\lambda_{rel,max}$	1,37	
Factor C_{yy}	1,00	
Factor C_{yz}	1,00	
Factor C_{zy}	0,98	
Factor C_{zz}	1,00	

Unity check (6.61) = 0,01 + 0,03 + 0,19 = 0,23 -

Unity check (6.62) = 0,01 + 0,02 + 0,27 = 0,30 -

Shear Buckling check

According to EN 1993-1-5 article 5 & 7.1 and formula (5.10) & (7.1)

Shear Buckling parameters		
Buckling field length a	2,900	m
Web	unstiffened	
Web height h_w	279	mm
Web thickness t	7	mm
Material coefficient ε	0,81	
Shear correction factor η	1,20	

Shear Buckling verification		
Web slenderness h_w/t	39,24	
Web slenderness limit	48,82	

Note: The web slenderness is such that Shear Buckling effects may be ignored according to EN 1993-1-5 article 5.1(2).

The member satisfies the stability check.

4.8. DIMENZIONIRANJE GLAVNOG NOSAČA 2-STUBIŠTE POZ 100

4.8.1. REZNE SILE –GLAVNI NOSAČ STUBIŠTE 2 POZ 100

My

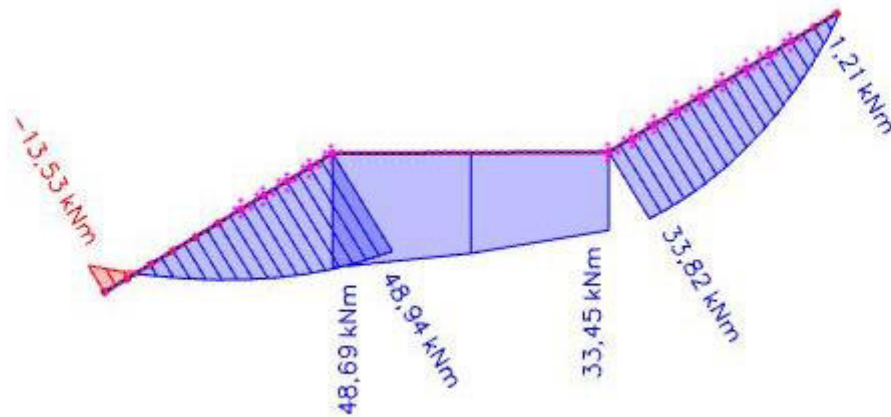

Vz

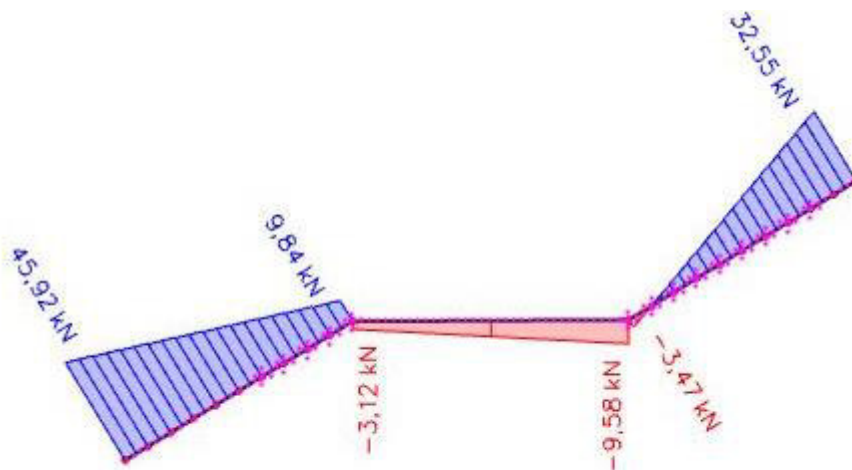

N

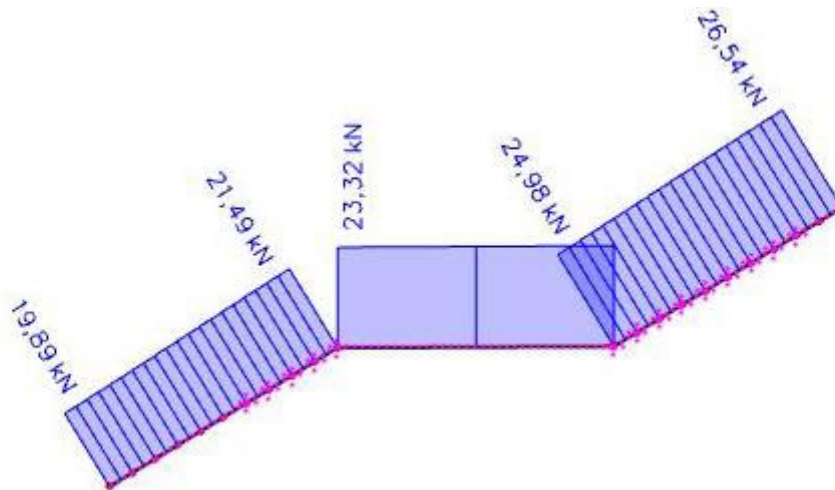

4.8.2. DIMENZIONIRANJE – GLAVNI NOSAČ STUBIŠTE 2 POZ 100

EC-EN 1993 Steel check ULS

Linear calculation
Combination: GSN4
Coordinate system: Principal
Extreme ID: Member
Selection: B369

EN 1993-1-1 Code Check
National annex: Standard EN

Member B369 2,315 / 2,315 m IPE300 S 355 GSN4 0,22 -

Combination key
GSN4 / 1.35*vlastita težina + 1.50*pokretno +
1.35*dodatno stalno + 1.50*vjetar smjer x +
0.90*temperatura pozitivna

Partial safety factors	
γ_{M0} for resistance of cross-sections	1,00
γ_{M1} for resistance to instability	1,00
γ_{M2} for resistance of net sections	1,25

Material		
Yield strength f_y	355,0	MPa
Ultimate strength f_u	490,0	MPa
Fabrication	Rolled	

....:SECTION CHECK:....

The critical check is on position 2,315 m

Internal forces	Calculated	Unit
N_{Ed}	21,49	kN
$V_{y,Ed}$	0,56	kN
$V_{z,Ed}$	9,84	kN
T_{Ed}	-0,03	kNm
$M_{y,Ed}$	48,94	kNm
$M_{z,Ed}$	0,38	kNm

Classification for cross-section design

Classification according to EN 1993-1-1 article 5.5.2

Classification of Internal and Outstand parts according to EN 1993 1-1 Table 5.2 Sheet 1 & 2

Id	Type	c [mm]	t [mm]	σ_1 [kN/m ²]	σ_2 [kN/m ²]	ψ [-]	k_o [-]	α [-]	c/t [-]	Class 1 Limit [-]	Class 2 Limit [-]	Class 3 Limit [-]	Class
1	SO	56	11	-8,985e+04	-9,338e+04								
3	SO	56	11	-8,753e+04	-8,400e+04								
4	I	249	7	-7,677e+04	6,879e+04	-1,12		0,48	35,01	60,66	69,93	112,77	1
5	SO	56	11	8,186e+04	8,539e+04	0,96	0,43	1,00	5,28	7,32	8,14	11,24	1
7	SO	56	11	7,954e+04	7,601e+04	0,96	0,45	1,00	5,28	7,32	8,14	11,41	1

Note: The Classification limits have been set according to Semi-Comp+.
The cross-section is classified as Class 1

Tension check

According to EN 1993-1-1 article 6.2.3 and formula (6.5)

A	5,3800e-03	m ²
$N_{p,Rd}$	1909,90	kN
$N_{u,Rd}$	1898,06	kN
$N_{t,Rd}$	1898,06	kN
Unity check	0,01	-

Bending moment check for M_y

According to EN 1993-1-1 article 6.2.5 and formula (6.12),(6.13)

W_{ply}	6,2800e-04	m ³
$M_{ply,Rd}$	222,94	kNm
Unity check	0,22	-

Bending moment check for M_z

According to EN 1993-1-1 article 6.2.5 and formula (6.12),(6.13)

$W_{pl,z}$	1,2500e-04	m ³
$M_{pl,z,Rd}$	44,38	kNm
Unity check	0,01	-

Shear check for V_y

According to EN 1993-1-1 article 6.2.6 and formula (6.17)

η	1,20	
A_v	3,3669e-03	m ²
$V_{pl,y,Rd}$	690,08	kN
Unity check	0,00	-

Shear check for V_z

According to EN 1993-1-1 article 6.2.6 and formula (6.17)

η	1,20	
A_v	2,5670e-03	m ²
$V_{pl,z,Rd}$	526,12	kN
Unity check	0,02	-

Torsion check

According to EN 1993-1-1 article 6.2.7 and formula (6.23)

Fibre	2	
T_{Ed}	1,7	MPa
T_{Rd}	205,0	MPa
Unity check	0,01	-

Note: The unity check for torsion is lower than the limit value of 0,05. Therefore torsion is considered as insignificant and is ignored in the combined checks.

Combined bending, axial force and shear force check

According to EN 1993-1-1 article 6.2.9.1 and formula (6.41)

$M_{ply,Rd}$	222,94	kNm
α	2,00	
$M_{pl,z,Rd}$	44,38	kNm
β	1,00	

Unity check (6.41) = 0,05 + 0,01 = 0,06 -

Note: Since the shear forces are less than half the plastic shear resistances their effect on the moment resistances is neglected.

Note: Since the axial force satisfies both criteria (6.33) and (6.34) of EN 1993-1-1 article 6.2.9.1(4) its effect on the moment resistance about the y-y axis is neglected.

Note: Since the axial force satisfies criteria (6.35) of EN 1993-1-1 article 6.2.9.1(4) its effect on the moment resistance about the z-z axis is neglected.

Decision tables for combined section check

Force presence	
Axial force N_{Ed}	Present
Shear force $V_{y,Ed}$	Not significant
Shear force $V_{z,Ed}$	Not significant
Torsional moment T_{Ed}	Not significant
Bending moment $M_{y,Ed}$	Present
Bending moment $M_{z,Ed}$	Present
Significant shear force without corresponding bending moment	No
Warping data	Not present or negligible

Check inputs	
Classification is supported	Yes
Section classification	Class 1
Elastic verification is set by the user	No
Plastic shear formula is available	Yes
Combined bending and axial force formula is available	Yes
Combined bending and axial force check can be calculated	Yes

Selected check	
According to EN 1993-1-1 article 6.2.9.1 and formula (6.41)	

The member satisfies the section check.

...:STABILITY CHECK:...

Classification for member buckling design

Decisive position for stability classification: 2,315 m

Classification according to EN 1993-1-1 article 5.5.2

Classification of Internal and Outstand parts according to EN 1993-1-1 Table 5.2 Sheet 1 & 2

Id	Type	c [mm]	t [mm]	σ_1 [kN/m ²]	σ_2 [kN/m ²]	ψ [-]	k_σ [-]	α [-]	c/t [-]	Class 1	Class 2	Class 3	Class
										Limit [-]	Limit [-]	Limit [-]	
1	SO	56	11	-8,985e+04	-9,338e+04								
3	SO	56	11	-8,753e+04	-8,400e+04								
4	I	249	7	-7,677e+04	6,879e+04	-1,12		0,48	35,01	60,66	69,93	112,77	1
5	SO	56	11	8,186e+04	8,539e+04	0,96	0,43	1,00	5,28	7,32	8,14	11,24	1
7	SO	56	11	7,954e+04	7,601e+04	0,96	0,45	1,00	5,28	7,32	8,14	11,41	1

Note: The Classification limits have been set according to Semi-Comp+.

The cross section is classified as Class 1

Lateral Torsional Buckling check

According to EN 1993-1-1 article 6.3.2.1 & 6.3.2.3 and formula (6.54)

LTB parameters		
Method for LTB curve	Alternative case	
Plastic section modulus $W_{pl,y}$	6,2800e-04	m ³
Elastic critical moment M_{cr}	34733,69	kNm
Relative slenderness $\lambda_{rel,LT}$	0,08	
Limit slenderness $\lambda_{rel,LT,0}$	0,40	

Note: The slenderness or bending moment is such that Lateral Torsional Buckling effects may be ignored according to EN 1993-1-1 article 6.3.2.2(4).

Mcr parameters		
LTB length L	0,232	m
Influence of load position	no influence	
Correction factor k	1,00	
Correction factor k_w	1,00	
LTB moment factor C_1	1,03	
LTB moment factor C_2	0,00	
LTB moment factor C_3	1,00	
Shear center distance d_s	0	mm
Distance of load application z_2	0	mm
Mono-symmetry constant β_y	0	mm
Mono-symmetry constant z_1	0	mm

Note: C parameters are determined according to ECCS 119 2006 / Galea 2002.

LTB additional parameters		
Minimal z coordinate z_{min}	-150	mm
Maximal z coordinate z_{max}	150	mm
End moment ratio ψ	0,95	
Equivalent point load F	1,67	kN
Equivalent line load q	14,39	kN/m
Difference with M	0,10	kNm
Difference with F	0,00	kNm
Difference with q	0,00	kNm
Resulting load type	linear moment M	

Shear Buckling check

According to EN 1993-1-5 article 5 & 7.1 and formula (5.10) & (7.1)

Shear Buckling parameters		
Buckling field length a	2,315	m
Web	unstiffened	
Web height h_w	279	mm
Web thickness t	7	mm
Material coefficient ϵ	0,81	
Shear correction factor η	1,20	

Shear Buckling verification		
Web slenderness h_w/t	39,24	
Web slenderness limit	48,82	

Note: The web slenderness is such that Shear Buckling effects may be ignored according to EN 1993-1-5 article 5.1(2).

The member satisfies the stability check.

4.8.3. GRANIČNO STANJE UPORABLJIVOSTI- NOSAČ 2 POZ 100

Uz

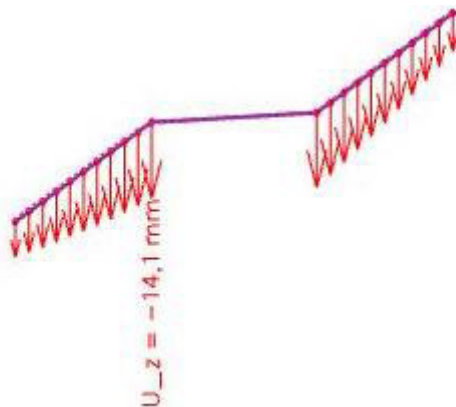

Dopušteni vertikalni pomak (progib):

$$L/300=7030/300= 23,43 \text{ mm} > 14,1 \text{ mm}$$

Iskoristivost:60 %

4.9. DIMENZIONIRANJE GLAVNOG NOSAČA-STUBIŠTE 3 POZ 100

4.9.1. REZNE SILE –GLAVNI NOSAČ STUBIŠTE 3 POZ 100

My

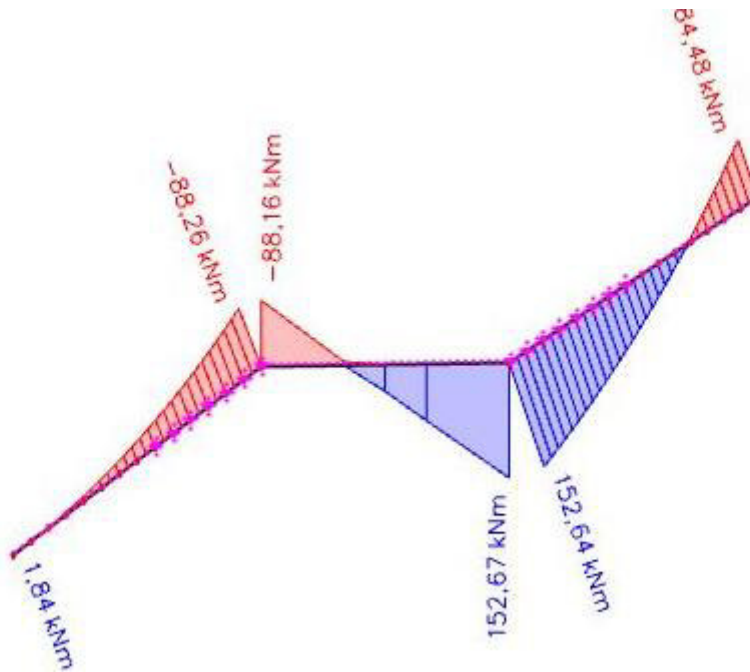

Vz

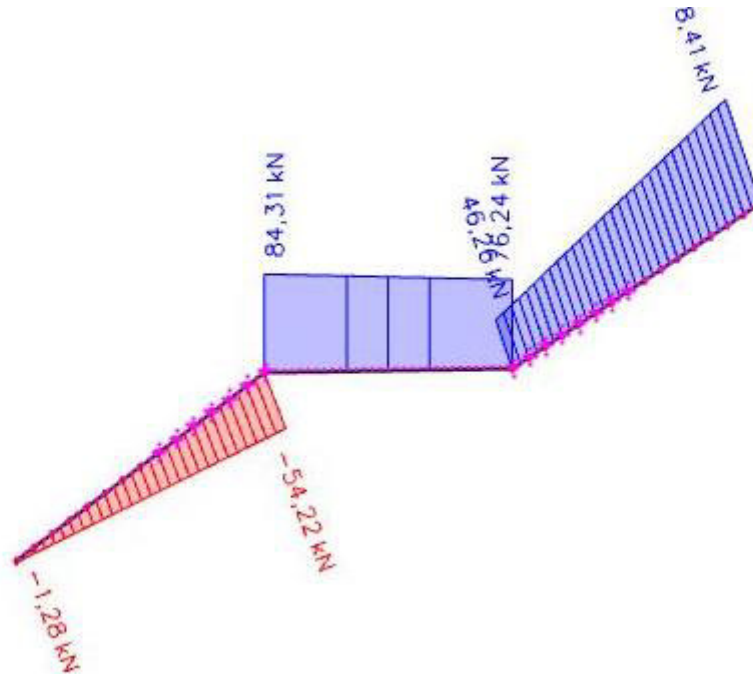

N

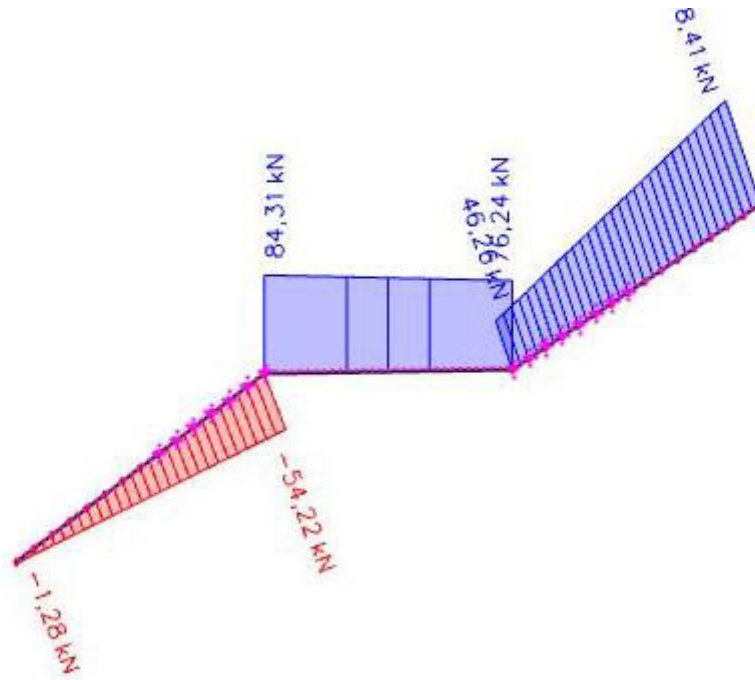

4.9.2. DIMENZIONIRANJE – GLAVNI NOSAČ STUBIŠTE 3 POZ 100

EC-EN 1993 Steel check ULS

Linear calculation
Combination: GSN6
Coordinate system: Principal
Extreme 1D: Member
Selection: 8359

EN 1993-1-1 Code Check
National annex: Standard EN

Member B359	0,221 / 3,311 m	IPE300	S 355	GSN6	0,96 -
-------------	-----------------	--------	-------	------	--------

Combination key	
GSN6 / 1.35*vlastita težina + 1.50*pokretno + 1.35*dodatno stalno + 1.50*vjetar smjer x	

Partial safety factors	
γ_{M0} for resistance of cross-sections	1,00
γ_{M1} for resistance to instability	1,00
γ_{M2} for resistance of net sections	1,25

Material		
Yield strength f_y	355,0	MPa
Ultimate strength f_u	490,0	MPa
Fabrication	Rolled	

...:SECTION CHECK:...

The critical check is on position 0,221 m

Internal forces	Calculated	Unit
N_{Ed}	-272,87	kN
$V_{y,Ed}$	1,99	kN
$V_{z,Ed}$	95,23	kN
T_{Ed}	0,03	kNm
$M_{y,Ed}$	-63,11	kNm
$M_{z,Ed}$	1,06	kNm

Classification for cross-section design

Classification according to EN 1993-1-1 article 5.5.2

Classification of Internal and Outstand parts according to EN 1993-1-1 Table 5.2 Sheet 1 & 2

Id	Type	c [mm]	t [mm]	σ_1 [kN/m ²]	σ_2 [kN/m ²]	ψ [-]	k_{σ} [-]	a [-]	c/t [-]	Class 1 Limit [-]	Class 2 Limit [-]	Class 3 Limit [-]	Class
1	SO	56	11	1,567e+05	1,468e+05	0,94	0,45	1,00	5,28	7,32	8,14	11,49	1
3	SO	56	11	1,632e+05	1,730e+05	0,94	0,43	1,00	5,28	7,32	8,14	11,26	1
4	I	249	7	1,446e+05	-4,317e+04	-0,30		0,72	35,01	34,78	41,49	56,28	2
5	SO	56	11	-5,529e+04	-4,542e+04								
7	SO	56	11	-6,178e+04	-7,165e+04								

Note: The Classification limits have been set according to Semi-Comp+.
The cross-section is classified as Class 2

Compression check

According to EN 1993-1-1 article 6.2.4 and formula (6.9)

A	5,3800e-03	m ²
$N_{c,Rd}$	1909,90	kN
Unity check	0,14	-

Bending moment check for M_y

According to EN 1993-1-1 article 6.2.5 and formula (6.12),(6.13)

W_{ply}	6,2800e-04	m ³
$M_{ply,Rd}$	222,94	kNm
Unity check	0,28	-

Bending moment check for M_z

According to EN 1993-1-1 article 6.2.5 and formula (6.12),(6.13)

$W_{pl,z}$	1,2500e-04	m ³
$M_{pl,z,Rd}$	44,38	kNm
Unity check	0,02	-

Shear check for V_y

According to EN 1993-1-1 article 6.2.6 and formula (6.17)

η	1,20	
A_v	3,3669e-03	m ²
$V_{ply,Rd}$	690,08	kN
Unity check	0,00	-

Shear check for V_z

According to EN 1993-1-1 article 6.2.6 and formula (6.17)

η	1,20	
--------	------	--

A_v	2,5670e-03	m ²
-------	------------	----------------

$V_{pl,z,Rd}$	526,12	kN
---------------	--------	----

Unity check	0,18	-
-------------	------	---

Torsion check

According to EN 1993-1-1 article 6.2.7 and formula (6.23)

Fibre	2	
T_{Ed}	1,5	MPa
T_{Rd}	205,0	MPa
Unity check	0,01	-

Note: The unity check for torsion is lower than the limit value of 0,05. Therefore torsion is considered as insignificant and is ignored in the combined checks.

Combined bending, axial force and shear force check

According to EN 1993-1-1 article 6.2.9.1 and formula (6.41)

$M_{pl,y,Rd}$	222,94	kNm
α	2,00	
$M_{pl,z,Rd}$	44,38	kNm
β	1,00	

Unity check (6.41) = 0,08 + 0,02 = 0,10 -

Note: Since the shear forces are less than half the plastic shear resistances their effect on the moment resistances is neglected.

Note: Since the axial force satisfies both criteria (6.33) and (6.34) of EN 1993-1-1 article 6.2.9.1(4) its effect on the moment resistance about the y-y axis is neglected.

Note: Since the axial force satisfies criteria (6.35) of EN 1993-1-1 article 6.2.9.1(4) its effect on the moment resistance about the z-z axis is neglected.

Decision tables for combined section check

Force presence	
Axial force N_{Ed}	Present
Shear force $V_{y,Ed}$	Not significant
Shear force $V_{z,Ed}$	Not significant
Torsional moment T_{Ed}	Not significant
Bending moment $M_{y,Ed}$	Present
Bending moment $M_{z,Ed}$	Present
Significant shear force without corresponding bending moment	No
Warping data	Not present or negligible

Check inputs	
Classification is supported	Yes
Section classification	Class 2
Elastic verification is set by the user	No
Plastic shear formula is available	Yes
Combined bending and axial force formula is available	Yes
Combined bending and axial force check can be calculated	Yes

Selected check

According to EN 1993-1-1 article 6.2.9.1 and formula (6.41)

The member satisfies the section check.

....:STABILITY CHECK:....

Classification for member buckling design

Decisive position for stability classification: 0,883 m

Classification according to EN 1993-1-1 article 5.5.2

Classification of Internal and Outstand parts according to EN 1993-1-1 Table 5.2 Sheet 1 & 2

Id	Type	c [mm]	t [mm]	σ_1 [kN/m ²]	σ_2 [kN/m ²]	Ψ [-]	k_{σ} [-]	α [-]	c/t [-]	Class 1 Limit [-]	Class 2 Limit [-]	Class 3 Limit [-]	Class
1	SO	56	11	5,626e+04	5,204e+04	0,93	0,46	1,00	5,28	7,32	8,14	11,55	1
3	SO	56	11	5,903e+04	6,324e+04	0,93	0,43	1,00	5,28	7,32	8,14	11,27	1
4	I	249	7	5,670e+04	4,526e+04	0,80		1,00	35,01	22,78	27,66	33,25	4
5	SO	56	11	4,571e+04	4,992e+04	0,92	0,44	1,00	5,28	7,32	8,14	11,29	1
7	SO	56	11	4,294e+04	3,872e+04	0,90	0,47	1,00	5,28	7,32	8,14	11,66	1

Note: The Classification limits have been set according to Semi-Comp+.

The cross-section is classified as Class 4

Effective section N-

Effective width calculation

According to EN 1993-1-5 article 4.4

Id	Type	b_0 [mm]	σ_1 [kN/m ²]	σ_2 [kN/m ²]	Ψ [-]	k_{σ} [-]	λ_p [-]	ρ [-]	b_0 [mm]	b_{e1} [mm]	b_{e2} [mm]
1	SO	56	3,550e+05	3,550e+05	1,00	0,43	0,35	1,00	56		
3	SO	56	3,550e+05	3,550e+05	1,00	0,43	0,35	1,00	56		
4	I	249	3,550e+05	3,550e+05	1,00	4,00	0,76	0,94	233	116	116

Id	Type	b_p [mm]	σ_1 [kN/m ²]	σ_2 [kN/m ²]	ψ [-]	k_σ [-]	λ_p [-]	ρ [-]	b_e [mm]	b_{e1} [mm]	b_{e2} [mm]
5	SO	56	3,550e+05	3,550e+05	1,00	0,43	0,35	1,00	56		
7	SO	56	3,550e+05	3,550e+05	1,00	0,43	0,35	1,00	56		

Effective section My-

Effective width calculation

According to EN 1993-1-5 article 4.4

Id	Type	b_p [mm]	σ_1 [kN/m ²]	σ_2 [kN/m ²]	ψ [-]	k_σ [-]	λ_p [-]	ρ [-]	b_e [mm]	b_{e1} [mm]	b_{e2} [mm]
1	SO	56	3,550e+05	3,550e+05	1,00	0,43	0,35	1,00	56		
3	SO	56	3,550e+05	3,550e+05	1,00	0,43	0,35	1,00	56		
4	I	249	3,051e+05	-3,051e+05	-1,00	23,90	0,31	1,00	124	50	75
5	SO	56	-3,550e+05	-3,550e+05							
7	SO	56	-3,550e+05	-3,550e+05							

Effective section Mz+

Effective width calculation

According to EN 1993-1-5 article 4.4

Id	Type	b_p [mm]	σ_1 [kN/m ²]	σ_2 [kN/m ²]	ψ [-]	k_σ [-]	λ_p [-]	ρ [-]	b_e [mm]	b_{e1} [mm]	b_{e2} [mm]
1	SO	56	-8,780e+04	-3,550e+05							
3	SO	56	3,550e+05	8,780e+04	0,25	0,52	0,32	1,00	56		
4	I	249	0,000e+00	0,000e+00							
5	SO	56	3,550e+05	8,780e+04	0,25	0,52	0,32	1,00	56		
7	SO	56	-8,780e+04	-3,550e+05							

Effective properties

Effective area	A_{eff}	5,2702e-03	m ²								
Effective second moment of area	$I_{eff,y}$	8,3577e-05	m ⁴	$I_{eff,z}$	6,0379e-06	m ⁴					
Effective section modulus	$W_{eff,y}$	5,5718e-04	m ³	$W_{eff,z}$	8,0505e-05	m ³					
Shift of the centroid	$e_{n,y}$	0	mm	$e_{n,z}$	0	mm					

Flexural Buckling check

According to EN 1993-1-1 article 6.3.1.1 and formula (6.46)

Buckling parameters	yy	zz	
Sway type	sway	non-sway	
System length L	3,311	0,221	m
Buckling factor k	1,18	0,93	
Buckling length L_{cr}	3,916	0,205	m
Critical Euler load N_{cr}	11293,66	299167,73	kN
Slenderness λ	31,42	6,11	
Relative slenderness λ_{rel}	0,41	0,08	
Limit slenderness $\lambda_{rel,0}$	0,20	0,20	

Note: The slenderness or compression force is such that Flexural Buckling effects may be ignored according to EN 1993-1-1 article 6.3.1.2(4).

Torsional(-Flexural) Buckling check

According to EN 1993-1-1 article 6.3.1.1 and formula (6.46)

Note: For this I-section the Torsional(-Flexural) buckling resistance is higher than the resistance for Flexural buckling. Therefore Torsional(-Flexural) buckling is not printed on the output.

Lateral Torsional Buckling check

According to EN 1993-1-1 article 6.3.2.1 & 6.3.2.3 and formula (6.54)

LTB parameters		
Method for LTB curve	Alternative case	
Effective section modulus $W_{eff,y}$	5,5718e-04	m ³
Elastic critical moment M_{cr}	42518,81	kNm
Relative slenderness $\lambda_{rel,LT}$	0,07	
Limit slenderness $\lambda_{rel,LT,0}$	0,40	

Note: The slenderness or bending moment is such that Lateral Torsional Buckling effects may be ignored according to EN 1993-1-1 article 6.3.2.2(4).

Mcr parameters		
LTB length L	0,221	m
Influence of load position	no influence	
Correction factor k	1,00	
Correction factor k_{sw}	1,00	
LTB moment factor C_1	1,14	
LTB moment factor C_2	0,00	
LTB moment factor C_3	1,00	
Shear center distance d_2	0	mm
Distance of load application z_0	0	mm
Mono-symmetry constant β_T	0	mm
Mono-symmetry constant z_j	0	mm

Note: C parameters are determined according to ECCS 119 2006 / Galea 2002.

LTB additional parameters		
Minimal z coordinate z_{min}	-150	mm
Maximal z coordinate z_{max}	150	mm
End moment ratio ψ	0,75	
Equivalent point load F	1,59	kN
Equivalent line load q	14,42	kN/m
Difference with M	0,09	kNm
Difference with F	0,00	kNm
Difference with q	0,00	kNm
Resulting load type	linear moment M	

Bending and axial compression check

According to EN 1993-1-1 article 6.3.3 and formula (6.61),(6.62)

Bending and axial compression check parameters		
Interaction method	alternative method 1	
Cross-section effective area A_{eff}	5,2702e-03	m ²
Effective section modulus $W_{eff,y}$	5,5718e-04	m ³
Effective section modulus $W_{eff,z}$	8,0505e-05	m ³
Design compression force N_{Ed}	272,87	kN
Design bending moment (maximum) $M_{y,Ed}$	152,64	kNm
Design bending moment (maximum) $M_{z,Ed}$	1,06	kNm
Additional moment $\Delta M_{y,Ed}$	0,00	kNm
Additional moment $\Delta M_{z,Ed}$	0,00	kNm
Characteristic compression resistance N_{Rk}	1870,93	kN
Characteristic moment resistance $M_{y,Rk}$	197,80	kNm
Characteristic moment resistance $M_{z,Rk}$	28,58	kNm
Reduction factor χ_y	1,00	
Reduction factor χ_z	1,00	
Modified reduction factor $\chi_{LT,mod}$	1,00	
Interaction factor k_{yy}	1,01	
Interaction factor k_{yz}	0,91	
Interaction factor k_{zy}	1,01	
Interaction factor k_{zz}	0,91	

Maximum moment $M_{y,Ed}$ is derived from beam B359 position 3,311 m.

Maximum moment $M_{z,Ed}$ is derived from beam B359 position 0,221 m.

Interaction method 1 parameters		
Critical Euler load $N_{cr,y}$	11293,56	kN
Critical Euler load $N_{cr,z}$	299167,73	kN
Elastic critical load $N_{cr,T}$	322885,80	kN
Effective section modulus $W_{eff,y}$	5,5718e-04	m ³
Second moment of area I_y	8,3560e-05	m ⁴
Second moment of area I_z	6,0400e-06	m ⁴
Torsional constant I_t	2,0100e-07	m ⁴
Method for equivalent moment factor $C_{my,0}$	Table A.2 Line 2 (General)	
Design bending moment (maximum) $M_{y,Ed}$	152,64	kNm
Maximum relative deflection δ_z	-4,6	mm
Equivalent moment factor $C_{my,0}$	0,99	
Method for equivalent moment factor $C_{mz,0}$	Table A.2 Line 1 (Linear)	
Ratio of end moments ψ_z	0,58	
Equivalent moment factor $C_{mz,0}$	0,91	
Factor μ_y	1,00	
Factor μ_z	1,00	
Factor ϵ_y	5,29	
Factor α_{LT}	1,00	
Critical moment for uniform bending $M_{cr,0}$	37175,03	kNm
Relative slenderness $\lambda_{rel,0}$	0,07	
Limit relative slenderness $\lambda_{rel,0,lim}$	0,21	
Equivalent moment factor C_{my}	0,99	
Equivalent moment factor C_{mz}	0,91	
Equivalent moment factor C_{mLT}	1,00	

Unity check (6.61) = 0,15 + 0,78 + 0,03 = 0,96 -

Unity check (6.62) = 0,15 + 0,78 + 0,03 = 0,96 -

Shear Buckling check

According to EN 1993-1-5 article 5 & 7.1 and formula (5.10) & (7.1)

Shear Buckling parameters		
Buckling field length a	3,311	m
Web	unstiffened	
Web height h_w	279	mm
Web thickness t	7	mm
Material coefficient ϵ	0,81	
Shear correction factor η	1,20	

Shear Buckling verification	
Web slenderness h_w/t	39,24
Web slenderness limit	48,82

Note: The web slenderness is such that Shear Buckling effects may be ignored according to EN 1993-1-5 article 5.1(2).

The member satisfies the stability check.

4.9.3. GRANIČNO STANJE UPORABLJIVOSTI- NOSAČ 3 POZ 100

Uz

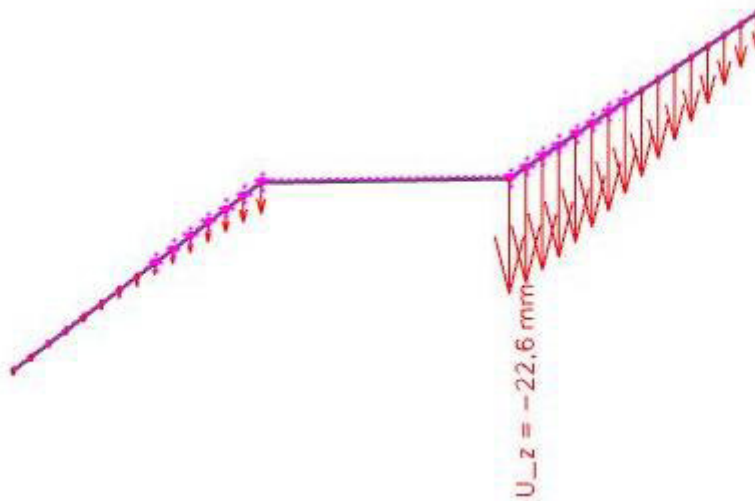

Dopušteni vertikalni pomak (progib):

$$L/300=9710/300= 32,37 \text{ mm} >22,6 \text{ mm}$$

Iskoristivost:70 %

4.10. DIMENZIONIRANJE GLAVNOG NOSAČA-STUBIŠTE 1 POZ 200

4.10.1. REZNE SILE –GLAVNI NOSAČ STUBIŠTE 1 POZ 200

My

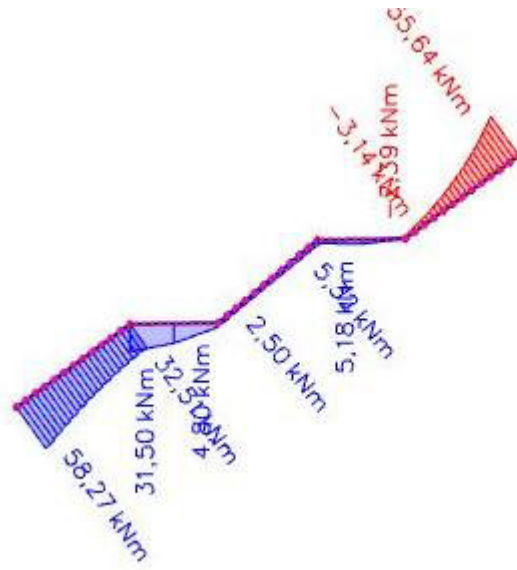

Vz

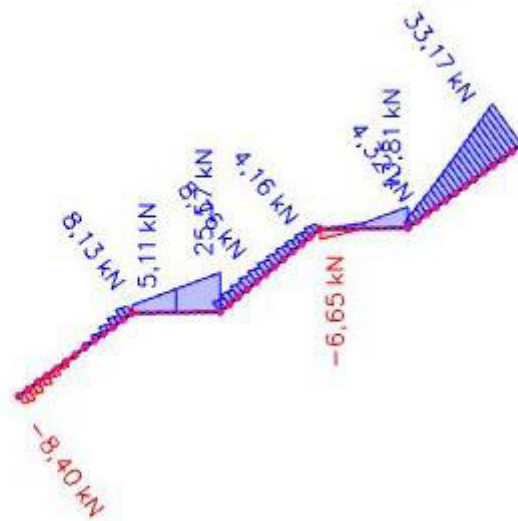

N

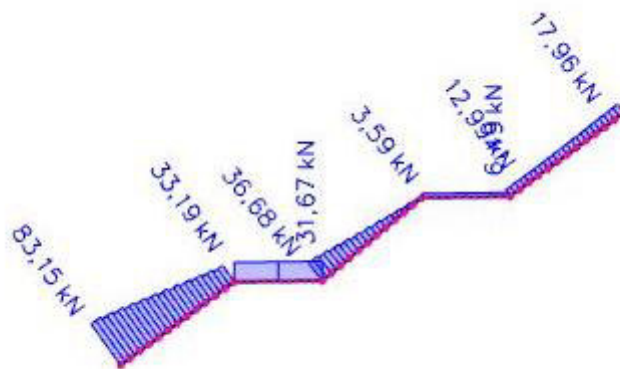

4.10.2. DIMENZIONIRANJE – GLAVNI NOSAČ STUBIŠTE 1 POZ 200

EC-EN 1993 Steel check ULS

Linear calculation

Combination: GSN4

Coordinate system: Principal

Extreme ID: Member

Selection: 8397

EN 1993-1-1 Code Check

National annex: Standard EN

Member B397	1,740 / 1,740 m	IPE300	S 355	GSN4	0,37 -
--------------------	------------------------	---------------	--------------	-------------	---------------

Combination keyGSN4 / 1.35*vlastita težina + 1.50*pokretno +
1.35*dodatno stalno + 1.50*vjetar smjer x +
0.90*temperatura pozitivna**Partial safety factors**

γ_{M0} for resistance of cross-sections	1,00
γ_{M1} for resistance to instability	1,00
γ_{M2} for resistance of net sections	1,25

Material

Yield strength f_y	355,0	MPa
Ultimate strength f_u	490,0	MPa
Fabrication	Rolled	

....SECTION CHECK:....

The critical check is on position 1,740 m

Internal forces	Calculated	Unit
N_{Ed}	31,66	kN
$V_{y,Ed}$	-17,00	kN
$V_{z,Ed}$	5,10	kN
T_{Ed}	-0,02	kNm
$M_{y,Ed}$	31,49	kNm
$M_{z,Ed}$	-15,39	kNm

Classification for cross-section design

Classification according to EN 1993-1-1 article 5.5.2

Classification of Internal and Outstand parts according to EN 1993-1-1 Table 5.2 Sheet 1 & 2

Id	Type	c [mm]	t [mm]	σ_1 [kN/m ²]	σ_2 [kN/m ²]	ψ [-]	k_{σ} [-]	α [-]	c/t [-]	Class 1 Limit [-]	Class 2 Limit [-]	Class 3 Limit [-]	Class
1	SO	56	11	-1,311e+04	1,308e+05	-0,10	0,59	0,91	5,28	8,06	8,95	13,14	1
3	SO	56	11	-1,077e+05	-2,515e+05								
4	I	249	7	-5,271e+04	4,095e+04	-1,29		0,47	35,01	61,70	71,12	130,91	1
5	SO	56	11	1,343e+03	-1,425e+05	-106,12	23,80	0,01	5,28	8118,41	9020,46	83,35	1
7	SO	56	11	9,589e+04	2,398e+05	0,40	0,50	1,00	5,28	7,32	8,14	12,05	1

Note: The Classification limits have been set according to Semi-Comp+.

The cross-section is classified as Class 1

Tension check

According to EN 1993-1-1 article 6.2.3 and formula (6.5)

A	5,3800e-03	m ²
$N_{pl,Rd}$	1909,90	kN
$N_{u,Rd}$	1898,06	kN
$N_{t,Rd}$	1898,06	kN
Unity check	0,02	-

Bending moment check for M_y

According to EN 1993-1-1 article 6.2.5 and formula (6.12),(6.13)

W_{ply}	6,2800e-04	m ³
$M_{pl,y,Rd}$	222,94	kNm
Unity check	0,14	-

Bending moment check for M_z

According to EN 1993-1-1 article 6.2.5 and formula (6.12),(6.13)

$W_{pl,z}$	1,2500e-04	m ³
$M_{pl,z,Rd}$	44,38	kNm
Unity check	0,35	-

Shear check for V_y

According to EN 1993-1-1 article 6.2.6 and formula (6.17)

η	1,20	
A_v	3,3669e-03	m ²
$V_{pl,y,Rd}$	690,08	kN
Unity check	0,02	-

Shear check for V_z

According to EN 1993-1-1 article 6.2.6 and formula (6.17)

η	1,20	
A_v	2,5670e-03	m ²
$V_{pl,z,Rd}$	526,12	kN
Unity check	0,01	-

Torsion check

According to EN 1993-1-1 article 6.2.7 and formula (6.23)

Fibre	2	
T_{Ed}	1,3	MPa
T_{Rd}	205,0	MPa
Unity check	0,01	-

Note: The unity check for torsion is lower than the limit value of 0,05. Therefore torsion is considered as insignificant and is ignored in the combined checks.

Combined bending, axial force and shear force check

According to EN 1993-1-1 article 6.2.9.1 and formula (6.41)

$M_{pl,y,Rd}$	222,94	kNm
α	2,00	
$M_{pl,z,Rd}$	44,38	kNm
β	1,00	

Unity check (6.41) = 0,02 + 0,35 = 0,37 -

Note: Since the shear forces are less than half the plastic shear resistances their effect on the moment resistances is neglected.

Note: Since the axial force satisfies both criteria (6.33) and (6.34) of EN 1993-1-1 article 6.2.9.1(4) its effect on the moment resistance about the y-y axis is neglected.

Note: Since the axial force satisfies criteria (6.35) of EN 1993-1-1 article 6.2.9.1(4) its effect on the moment resistance about the z-z axis is neglected.

Decision tables for combined section check

Force presence	
Axial force N_{Ed}	Present
Shear force $V_{y,Ed}$	Not significant
Shear force $V_{z,Ed}$	Not significant
Torsional moment T_{Ed}	Not significant
Bending moment $M_{y,Ed}$	Present
Bending moment $M_{z,Ed}$	Present
Significant shear force without corresponding bending moment	No
Warping data	Not present or negligible

Check inputs	
Classification is supported	Yes
Section classification	Class 1
Elastic verification is set by the user	No
Plastic shear formula is available	Yes
Combined bending and axial force formula is available	Yes
Combined bending and axial force check can be calculated	Yes

Selected check	
According to EN 1993-1-1 article 6.2.9.1 and formula (6.41)	

The member satisfies the section check.

...:STABILITY CHECK:...:

Classification for member buckling design

Decisive position for stability classification: 1,740 m

Classification according to EN 1993-1-1 article 5.5.2

Classification of Internal and Outstand parts according to EN 1993-1-1 Table 5.2 Sheet 1 & 2

Id	Type	c [mm]	t [mm]	σ_1 [kN/m ²]	σ_2 [kN/m ²]	ψ [-]	k_o [-]	α [-]	c/t [-]	Class 1 Limit [-]	Class 2 Limit [-]	Class 3 Limit [-]	Class
1	SO	56	11	-1,311e+04	1,308e+05	-0,10	0,59	0,91	5,28	8,06	8,95	13,14	1
3	SO	56	11	-1,077e+05	-2,515e+05								
4	I	249	7	-5,271e+04	4,095e+04	-1,29		0,47	35,01	61,70	71,12	130,91	1
5	SO	56	11	1,343e+03	-1,425e+05	-106,12	23,80	0,01	5,28	8118,41	9020,46	83,35	1
7	SO	56	11	9,589e+04	2,398e+05	0,40	0,50	1,00	5,28	7,32	8,14	12,05	1

Note: The Classification limits have been set according to Semi-Comp+. The cross-section is classified as Class 1

Lateral Torsional Buckling check

According to EN 1993-1-1 article 6.3.2.1 & 6.3.2.3 and formula (6.54)

LTB parameters		
Method for LTB curve	Alternative case	
Plastic section modulus $W_{pl,y}$	6,2800e-04	m ³
Elastic critical moment M_{cr}	889,60	kNm
Relative slenderness $\lambda_{rel,LT}$	0,50	
Limit slenderness $\lambda_{rel,LT,0}$	0,40	

Note: The slenderness or bending moment is such that Lateral Torsional Buckling effects may be ignored according to EN 1993-1-1 article 6.3.2.2(4).

Mcr parameters		
LTB length L	1,740	m
Influence of load position	no influence	
Correction factor k	1,00	
Correction factor k_{sw}	1,00	
LTB moment factor C_1	1,37	
LTB moment factor C_2	0,07	
LTB moment factor C_3	1,00	
Shear center distance d_z	0	mm
Distance of load application z_g	0	mm
Mono-symmetry constant β_y	0	mm
Mono-symmetry constant z_j	0	mm

Note: C parameters are determined according to ECCS 119 2006 / Galea 2002.

LTB additional parameters		
Minimal z coordinate z_{min}	-150	mm
Maximal z coordinate z_{max}	150	mm
End moment ratio ψ	0,15	
Equivalent point load F	10,23	kN
Equivalent line load q	11,76	kN/m
Difference with M	4,45	kNm
Difference with F	0,00	kNm
Difference with q	0,00	kNm
Resulting load type	line load q	

Shear Buckling check

According to EN 1993-1-5 article 5 & 7.1 and formula (5.10) & (7.1)

Shear Buckling parameters		
Buckling field length a	1,740	m
Web	unstiffened	
Web height h_w	279	mm
Web thickness t	7	mm
Material coefficient ϵ	0,81	
Shear correction factor η	1,20	

Shear Buckling verification

Web slenderness h_w/t	39,24
Web slenderness limit	48,82

Note: The web slenderness is such that Shear Buckling effects may be ignored according to EN 1993-1-5 article 5.1(2).

The member satisfies the stability check.

4.10.3. GRANIČNO STANJE UPORABLJIVOSTI- - NOSAČ 1 POZ 200

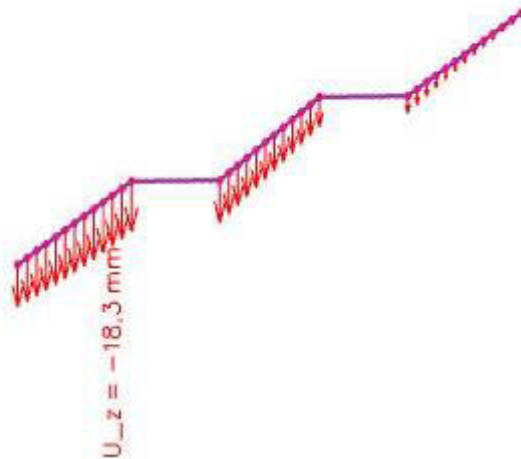

Dopušteni vertikalni pomak(progib):

$$L/300=11510/300= 38,36 \text{ mm} >18,3 \text{ mm}$$

Iskoristivost:48 %

4.11. DIMENZIONIRANJE GLAVNOG NOSAČA-STUBIŠTE 1 POZ 300

4.11.1. REZNE SILE –GLAVNI NOSAČ STUBIŠTE 1 POZ 300

My

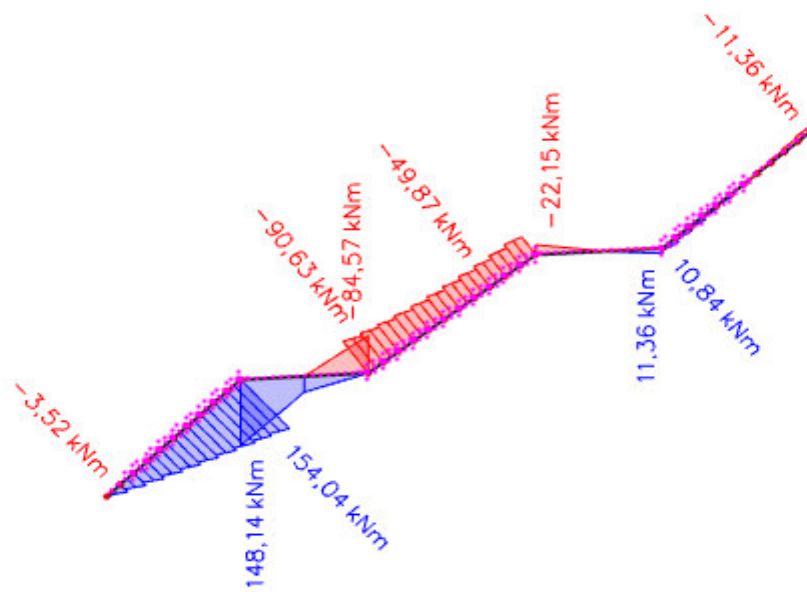

Vz

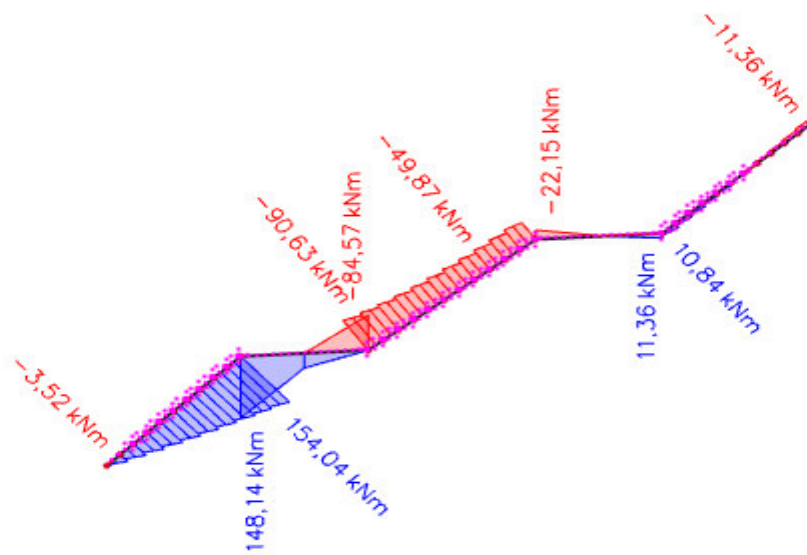

N

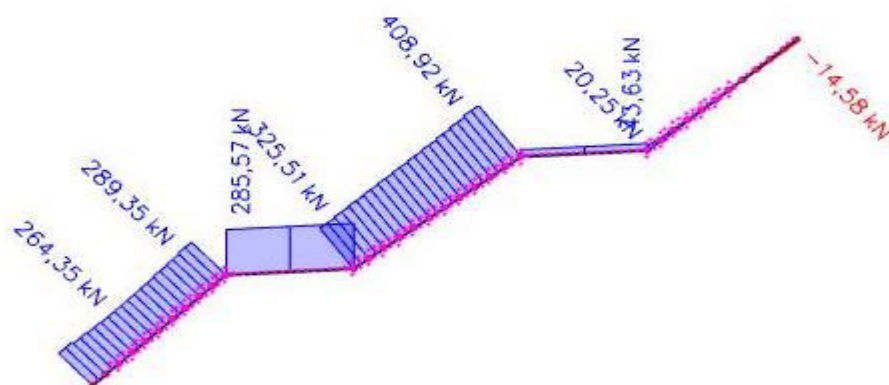

4.11.2. DIMENZIONIRANJE – GLAVNI NOSAČ STUBIŠTE 1 POZ 300

EC-EN 1993 Steel check ULS

Linear calculation

Combination: GSN4

Coordinate system: Principal

Extreme 1D: Member

Selection: 81655

EN 1993-1-1 Code Check

National annex: Standard EN

Member B1655 1,710 / 1,710 m HEA200 S 355 GSN4 0,65 -

Combination key

GSN4 / 1.35*vlastita težina + 1.50*pokretno +
1.35*dodatno stalno + 1.50*vjetar smjer x +
0.90*temperatura pozitivna

Partial safety factors

γ_{M0} for resistance of cross-sections	1,00
γ_{M1} for resistance to instability	1,00
γ_{M2} for resistance of net sections	1,25

Material

Yield strength f_y	355,0	MPa
Ultimate strength f_u	490,0	MPa
Fabrication	Rolled	

....SECTION CHECK:....

The critical check is on position 1,710 m

Internal forces	Calculated	Unit
N_{Ed}	44,03	kN
$V_{y,Ed}$	21,33	kN
$V_{z,Ed}$	-27,61	kN
T_{Ed}	0,21	kNm
$M_{y,Ed}$	-21,97	kNm
$M_{z,Ed}$	45,48	kNm

Classification for cross-section design

Classification according to EN 1993-1-1 article 5.5.2

Classification of Internal and Outstand parts according to EN 1993 1-1 Table 5.2 Sheet 1 & 2

Id	Type	c [mm]	t [mm]	σ_1 [kN/m ²]	σ_2 [kN/m ²]	ψ [-]	k_o [-]	α [-]	c/t [-]	Class 1 Limit [-]	Class 2 Limit [-]	Class 3 Limit [-]	Class
1	SO	79	10	-2,701e+04	-2,952e+05								
3	SO	79	10	1,177e+05	3,859e+05	0,31	0,51	1,00	7,88	7,32	8,14	12,23	2
4	I	134	7	3,167e+04	-4,803e+04	-1,52		0,43	20,62	68,31	78,74	156,31	1
5	SO	79	10	1,066e+04	2,789e+05	0,04	0,56	1,00	7,88	7,32	8,14	12,81	2
7	SO	79	10	-1,341e+05	-4,023e+05								

Note: The Classification limits have been set according to Semi-Comp+.

The cross-section is classified as Class 2

Tension check

According to EN 1993-1-1 article 6.2.3 and formula (6.5)

A	5,3800e-03	m ²
$N_{p,Rd}$	1909,90	kN
$N_{u,Rd}$	1898,06	kN
$N_{t,Rd}$	1898,06	kN
Unity check	0,02	-

Bending moment check for M_y

According to EN 1993-1-1 article 6.2.5 and formula (6.12),(6.13)

W_{ply}	4,2917e-04	m ³
$M_{ply,Rd}$	152,35	kNm
Unity check	0,14	-

Bending moment check for M_z

According to EN 1993-1-1 article 6.2.5 and formula (6.12),(6.13)

$W_{pl,z}$	2,0375e-04	m ³
$M_{pl,z,Rd}$	72,33	kNm
Unity check	0,63	-

Shear check for V_y

According to EN 1993-1-1 article 6.2.6 and formula (6.17)

η	1,20	
A_v	4,1592e-03	m ²
$V_{pl,y,Rd}$	852,48	kN
Unity check	0,03	-

Shear check for V_z

According to EN 1993-1-1 article 6.2.6 and formula (6.17)

η	1,20	
A_v	1,8050e-03	m ²
$V_{pl,z,Rd}$	369,95	kN
Unity check	0,07	-

Torsion check

According to EN 1993-1-1 article 6.2.7 and formula (6.23)

Fibre	2	
T_{Ed}	9,9	MPa
T_{Rd}	205,0	MPa
Unity check	0,05	-

Note: The unity check for torsion is lower than the limit value of 0,05. Therefore torsion is considered as insignificant and is ignored in the combined checks.

Combined bending, axial force and shear force check

According to EN 1993-1-1 article 6.2.9.1 and formula (6.41)

$M_{pl,y,Rd}$	152,35	kNm
α	2,00	
$M_{pl,z,Rd}$	72,33	kNm
β	1,00	

Unity check (6.41) = 0,02 + 0,63 = 0,65 -

Note: Since the shear forces are less than half the plastic shear resistances their effect on the moment resistances is neglected.

Note: Since the axial force satisfies both criteria (6.33) and (6.34) of EN 1993-1-1 article 6.2.9.1(4) its effect on the moment resistance about the y-y axis is neglected.

Note: Since the axial force satisfies criteria (6.35) of EN 1993-1-1 article 6.2.9.1(4) its effect on the moment resistance about the z-z axis is neglected.

Decision tables for combined section check

Force presence	
Axial force N_{Ed}	Present
Shear force $V_{y,Ed}$	Not significant
Shear force $V_{z,Ed}$	Not significant
Torsional moment T_{Ed}	Not significant
Bending moment $M_{y,Ed}$	Present
Bending moment $M_{z,Ed}$	Present
Significant shear force without corresponding bending moment	No
Warping data	Not present or negligible

Check inputs	
Classification is supported	Yes
Section classification	Class 2
Elastic verification is set by the user	No
Plastic shear formula is available	Yes
Combined bending and axial force formula is available	Yes
Combined bending and axial force check can be calculated	Yes

Selected check	
According to EN 1993-1-1 article 6.2.9.1 and formula (6.41)	

The member satisfies the section check.

....STABILITY CHECK:....

Classification for member buckling design

Decisive position for stability classification: 1,710 m

Classification according to EN 1993-1-1 article 5.5.2

Classification of Internal and Outstand parts according to EN 1993-1-1 Table 5.2 Sheet 1 & 2

Id	Type	c [mm]	t [mm]	σ_1 [kN/m ²]	σ_2 [kN/m ²]	ψ [-]	k_σ [-]	α [-]	c/t [-]	Class 1 Limit [-]	Class 2 Limit [-]	Class 3 Limit [-]	Class
1	SO	79	10	-2,701e+04	-2,952e+05								
3	SO	79	10	1,177e+05	3,859e+05	0,31	0,51	1,00	7,88	7,32	8,14	12,23	2
4	I	134	7	3,167e+04	-4,803e+04	-1,52		0,43	20,62	68,31	78,74	156,31	1
5	SO	79	10	1,066e+04	2,789e+05	0,04	0,56	1,00	7,88	7,32	8,14	12,81	2
7	SO	79	10	-1,341e+05	-4,023e+05								

Note: The Classification limits have been set according to Semi-Comp+.

The cross-section is classified as Class 2

Lateral Torsional Buckling check

According to EN 1993-1-1 article 6.3.2.1 & 6.3.2.3 and formula (6.54)

LTB parameters		
Method for LTB curve	Alternative case	
Plastic section modulus $W_{pl,y}$	4,2917e-04	m ³
Elastic critical moment M_{cr}	2553,29	kNm
Relative slenderness $\lambda_{rel,LT}$	0,24	
Limit slenderness $\lambda_{rel,LT,0}$	0,40	

Note: The slenderness or bending moment is such that Lateral Torsional Buckling effects may be ignored according to EN 1993-1-1 article 6.3.2.2(4).

Mcr parameters		
LTB length L	1,710	m
Influence of load position	no influence	
Correction factor k	1,00	
Correction factor k_w	1,00	
LTB moment factor C_1	2,71	
LTB moment factor C_2	0,10	
LTB moment factor C_3	1,00	
Shear center distance d_s	0	mm
Distance of load application z_q	0	mm
Mono-symmetry constant β_y	0	mm
Mono-symmetry constant z_j	0	mm

Note: C parameters are determined according to ECCS 119 2006 / Galea 2002.

LTB additional parameters		
Minimal z coordinate z_{min}	-95	mm
Maximal z coordinate z_{max}	95	mm
End moment ratio ψ	-0,51	
Equivalent point load F	8,18	kN
Equivalent line load q	9,57	kN/m
Difference with M	3,50	kNm
Difference with F	0,00	kNm
Difference with q	0,00	kNm
Resulting load type	point load F	

Shear Buckling check

According to EN 1993-1-5 article 5 & 7.1 and formula (5.10) & (7.1)

Shear Buckling parameters		
Buckling field length a	1,710	m
Web	unstiffened	
Web height h_w	170	mm
Web thickness t	7	mm
Material coefficient ϵ	0,81	
Shear correction factor η	1,20	

Shear Buckling verification		
Web slenderness h_w/t	26,15	
Web slenderness limit	48,82	

Note: The web slenderness is such that Shear Buckling effects may be ignored according to EN 1993-1-5 article 5.1(2).

The member satisfies the stability check.

4.12. DIMENZIONIRANJE GLAVNOG NOSAČA-STUBIŠTE 1 POZ 400

4.12.1. REZNE SILE –GLAVNI NOSAČ STUBIŠTE 1 POZ 400

My

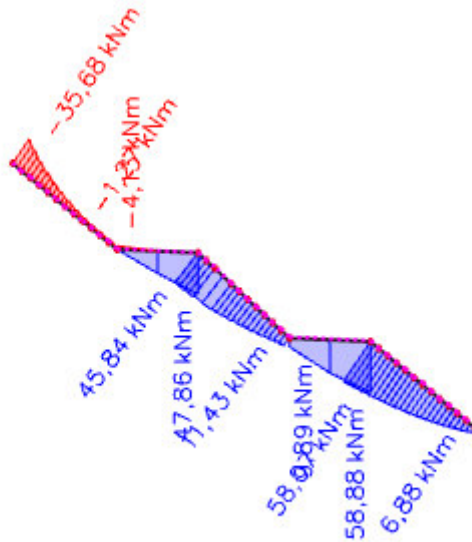

Vz

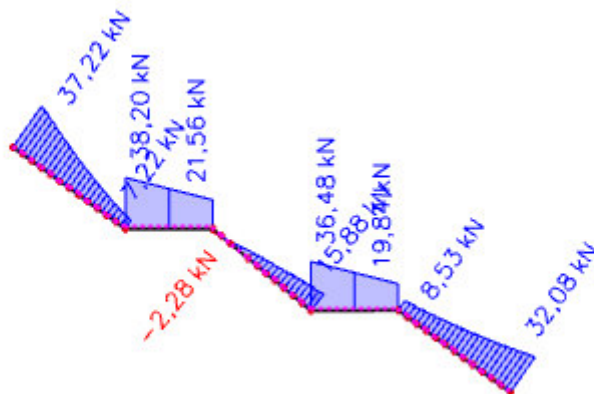

N

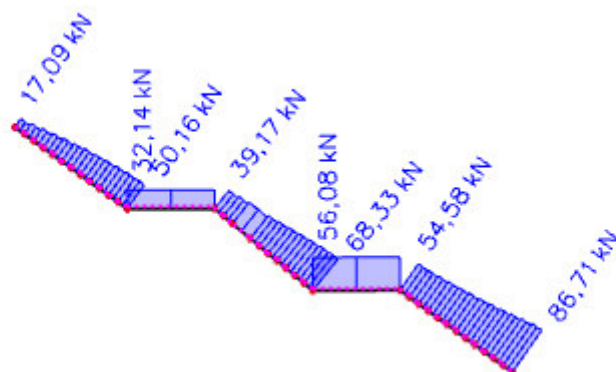

4.12.2. DIMENZIONIRANJE – GLAVNI NOSAČ STUBIŠTE 1 POZ 400

EC-EN 1993 Steel check ULS

Linear calculation

Combination: GSN4

Coordinate system: Principal

Extreme ID: Member

Selection: B1661

EN 1993-1-1 Code Check

National annex: Standard EN

Member B1661	0,000 / 2,530 m	IPE300	S 355	GSN4	0,45 -
--------------	-----------------	--------	-------	------	--------

Combination keyGSN4 / 1.35*vlastita težina + 1.50*pokretno +
1.35*dodatno stalno + 1.50*vjetar smjer x +
0.90*temperatura pozitivna**Partial safety factors**

γ_{M0} for resistance of cross-sections	1,00
γ_{M1} for resistance to instability	1,00
γ_{M2} for resistance of net sections	1,25

Material

Yield strength f_y	355,0	MPa
Ultimate strength f_u	490,0	MPa
Fabrication	Rolled	

....:SECTION CHECK:....

The critical check is on position 0,000 m

Internal forces	Calculated	Unit
N_{Ed}	68,38	kN
$V_{y,Ed}$	65,53	kN
$V_{z,Ed}$	15,94	kN
T_{Ed}	0,78	kNm
$M_{y,Ed}$	11,43	kNm
$M_{z,Ed}$	-20,02	kNm

Classification for cross-section design

Classification according to EN 1993-1-1 article 5.5.2

Classification of Internal and Outstand parts according to EN 1993 1-1 Table 5.2 Sheet 1 & 2

Id	Type	c [mm]	t [mm]	σ_1 [kN/m ²]	σ_2 [kN/m ²]	ψ [-]	k_{σ} [-]	α [-]	c/t [-]	Class 1 Limit [-]	Class 2 Limit [-]	Class 3 Limit [-]	Class
1	SO	56	11	2,903e+04	2,162e+05	0,13	0,54	1,00	5,28	7,32	8,14	12,59	1
3	SO	56	11	-9,401e+04	-2,812e+05								
4	I	249	7	-2,971e+04	4,296e+03	-6,91		0,45	35,01	65,76	75,80	1049,76	1
5	SO	56	11	-5,444e+04	-2,417e+05								
7	SO	56	11	6,860e+04	2,558e+05	0,27	0,52	1,00	5,28	7,32	8,14	12,31	1

Note: The Classification limits have been set according to Semi-Comp+.
The cross-section is classified as Class 1

Tension check

According to EN 1993-1-1 article 6.2.3 and formula (6.5)

A	5,3800e-03	m ²
$N_{p,Rd}$	1909,90	kN
$N_{u,Rd}$	1898,06	kN
$N_{t,Rd}$	1898,06	kN
Unity check	0,04	-

Bending moment check for M_y

According to EN 1993-1-1 article 6.2.5 and formula (6.12),(6.13)

W_{ply}	6,2800e-04	m ³
$M_{ply,Rd}$	222,94	kNm
Unity check	0,05	-

Bending moment check for M_z

According to EN 1993-1-1 article 6.2.5 and formula (6.12),(6.13)

$W_{pl,z}$	1,2500e-04	m ³
$M_{pl,z,Rd}$	44,38	kNm
Unity check	0,45	-

Shear check for V_y

According to EN 1993-1-1 article 6.2.6 and formula (6.17)

η	1,20	
A_w	3,3669e-03	m ²
$V_{ply,Rd}$	690,08	kN
Unity check	0,09	-

Shear check for V_z

According to EN 1993-1-1 article 6.2.6 and formula (6.17)

η	1,20	
A_y	2,5670e-03	m ²
$V_{pl,z,Rd}$	526,12	kN
Unity check	0,03	-

Torsion check

According to EN 1993-1-1 article 6.2.7 and formula (6.23)

Fibre	2	
T_{Ed}	41,5	MPa
T_{Rd}	205,0	MPa
Unity check	0,20	-

Combined Shear and Torsion check for V_y and $\tau_{t,Ed}$

According to EN 1993-1-1 article 6.2.6 & 6.2.7 and formula (6.25),(6.26)

$V_{pl,T,y,Rd}$	631,78	kN
Unity check	0,10	-

Combined Shear and Torsion check for V_z and $\tau_{t,Ed}$

According to EN 1993-1-1 article 6.2.6 & 6.2.7 and formula (6.25),(6.26)

$V_{pl,T,z,Rd}$	481,68	kN
Unity check	0,03	-

Combined bending, axial force and shear force check

According to EN 1993-1-1 article 6.2.9.1 and formula (6.41)

$M_{pl,y,Rd}$	222,94	kNm
α	2,00	
$M_{pl,z,Rd}$	44,38	kNm
β	1,00	

Unity check (6.41) = 0,00 + 0,45 = 0,45 -

Note: Since the shear forces are less than half the plastic shear resistances their effect on the moment resistances is neglected.

Note: Since the axial force satisfies both criteria (6.33) and (6.34) of EN 1993-1-1 article 6.2.9.1(4) its effect on the moment resistance about the y-y axis is neglected.

Note: Since the axial force satisfies criteria (6.35) of EN 1993-1-1 article 6.2.9.1(4) its effect on the moment resistance about the z-z axis is neglected.

Decision tables for combined section check

Force presence	
Axial force N_{Ed}	Present
Shear force $V_{y,Ed}$	Not significant
Shear force $V_{z,Ed}$	Not significant
Torsional moment T_{Ed}	Present
Bending moment $M_{y,Ed}$	Present
Bending moment $M_{z,Ed}$	Present
Significant shear force without corresponding bending moment	No
Torsional moment without shear force	No
Warping data	Not present or negligible

Check inputs	
Classification is supported	Yes
Section classification	Class 1
Elastic verification is set by the user	No
Plastic shear formula is available	Yes
Combined shear and torsion formula is available	Yes
Combined shear and torsion check can be calculated	Yes
Combined bending and axial force formula is available	Yes
Combined bending and axial force check can be calculated	Yes

Selected check
According to EN 1993-1-1 article 6.2.9.1 and formula (6.41)

The member satisfies the section check.

....:STABILITY CHECK:....

Classification for member buckling design

Decisive position for stability classification: 2,530 m

Classification according to EN 1993-1-1 article 5.5.2

Classification of Internal and Outstand parts according to EN 1993-1-1 Table 5.2 Sheet 1 & 2

Id	Type	c [mm]	t [mm]	σ_1 [kN/m ²]	σ_2 [kN/m ²]	ψ [-]	k_σ [-]	α [-]	c/t [-]	Class 1 Limit [-]	Class 2 Limit [-]	Class 3 Limit [-]	Class
1	SO	56	11	-1,404e+05	+3,045e+05								
3	SO	56	11	-3,250e+04	1,316e+05	-0,25	0,63	0,80	5,28	9,13	10,14	13,52	1

Id	Type	c [mm]	t [mm]	σ_1 [kN/m ²]	σ_2 [kN/m ²]	ψ [-]	k_{σ} [-]	α [-]	c/t [-]	Class 1 Limit [-]	Class 2 Limit [-]	Class 3 Limit [-]	Class
4	I	249	7	-7,531e+04	6,062e+04	-1,24		0,47	35,01	62,53	72,08	126,08	1
5	SO	56	11	1,257e+05	2,898e+05	0,43	0,49	1,00	5,28	7,32	8,14	11,99	1
7	SO	56	11	1,781e+04	-1,463e+05	-8,22	23,80	0,11	5,28	204,92	227,69	83,35	1

Note: The Classification limits have been set according to Semi-Comp+. The cross-section is classified as Class 1

Lateral Torsional Buckling check

According to EN 1993-1-1 article 6.3.2.1 & 6.3.2.3 and formula (6.54)

LTB parameters		
Method for LTB curve	Alternative case	
Plastic section modulus $W_{pl,y}$	6,2800e-04	m ³
Elastic critical moment M_{cr}	38659,09	kNm
Relative slenderness $\lambda_{rel,LT}$	0,08	
Limit slenderness $\lambda_{rel,LT,0}$	0,40	

Note: The slenderness or bending moment is such that Lateral Torsional Buckling effects may be ignored according to EN 1993-1-1 article 6.3.2.2(4).

Mcr parameters		
LTB length L	0,230	m
Influence of load position	no influence	
Correction factor k	1,00	
Correction factor k_w	1,00	
LTB moment factor C_1	1,13	
LTB moment factor C_2	0,00	
LTB moment factor C_3	1,00	
Shear center distance d_x	0	mm
Distance of load application z_q	0	mm
Mono-symmetry constant β_y	0	mm
Mono-symmetry constant z_j	0	mm

Note: C parameters are determined according to ECCS 119 2006 / Galea 2002.

LTB additional parameters		
Minimal z coordinate z_{min}	-150	mm
Maximal z coordinate z_{max}	150	mm
End moment ratio ψ	0,77	
Equivalent point load F	1,09	kN
Equivalent line load q	9,44	kN/m
Difference with M	0,06	kNm
Difference with F	0,00	kNm
Difference with q	0,00	kNm
Resulting load type	linear moment M	

Shear Buckling check

According to EN 1993-1-5 article 5 & 7.1 and formula (5.10) & (7.1)

Shear Buckling parameters		
Buckling field length a	2,530	m
Web	unstiffened	
Web height h_w	279	mm
Web thickness t	7	mm
Material coefficient ϵ	0,81	
Shear correction factor η	1,20	

Shear Buckling verification		
Web slenderness h_w/t	39,24	
Web slenderness limit	48,82	

Note: The web slenderness is such that Shear Buckling effects may be ignored according to EN 1993-1-5 article 5.1(2).

The member satisfies the stability check.

4.12.3. GRANIČNO STANJE UPORABLJIVOSTI- NOSAČ 1 POZ 400

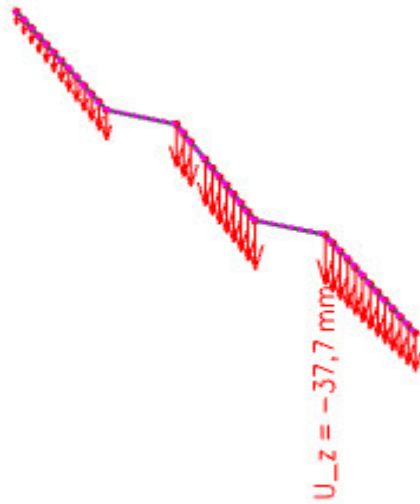

Dopušteni vertikalni pomak (progib):

$$L/300=11186/300= 38,39 \text{ mm} >37,7 \text{ mm}$$

Iskoristivost:98 %

4.13. DIMENZIONIRANJE STUPA POZ 100

4.13.1. REZNE SILE –STUP 1 POZ 100

N

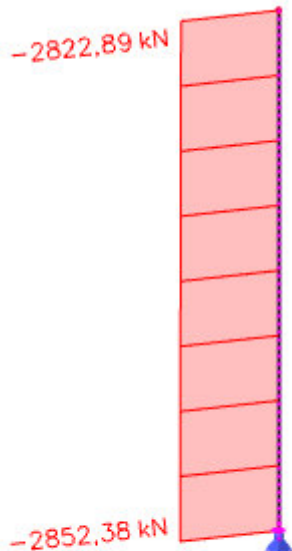

4.13.2. DIMENZIONIRANJE –STUP 1 POZ 100

EC-EN 1993 Steel check ULS

Linear calculation
Combination: GSN4
Coordinate system: Principal
Extreme ID: Member
Selection: 83339

EN 1993-1-1 Code Check
National annex: Standard EN

Member B3339	7,800 / 7,800 m	HEM600	S 355	GSN4	0,52 -
--------------	-----------------	--------	-------	------	--------

Combination key
GSN4 / 1.35*vlastita težina + 1.50*pokretno +
1.35*dodatno stalno + 1.50*vjetar smjer x +
0.90*temperatura pozitivna

Partial safety factors	
γ_{M0} for resistance of cross-sections	1,00
γ_{M1} for resistance to instability	1,00
γ_{M2} for resistance of net sections	1,25

Material		
Yield strength f_y	355,0	MPa
Ultimate strength f_u	490,0	MPa
Fabrication	Rolled	

....SECTION CHECK:....

The critical check is on position 7,800 m

Internal forces	Calculated	Unit
N_{Ed}	-2801,03	kN
$V_{y,Ed}$	0,53	kN
$V_{z,Ed}$	-4,26	kN
T_{Ed}	0,00	kNm
$M_{y,Ed}$	0,00	kNm
$M_{z,Ed}$	0,00	kNm

Classification for cross-section design

Classification according to EN 1993-1-1 article 5.5.2

Classification of Internal and Outstand parts according to EN 1993 1-1 Table 5.2 Sheet 1 & 2

Id	Type	c [mm]	t [mm]	σ_1 [kN/m ²]	σ_2 [kN/m ²]	ψ [-]	k_{σ} [-]	α [-]	c/t [-]	Class 1 Limit [-]	Class 2 Limit [-]	Class 3 Limit [-]	Class
1	SO	115	40	7,702e+04	7,702e+04	1,00	0,43	1,00	2,87	7,32	8,14	11,39	1
3	SO	115	40	7,702e+04	7,702e+04	1,00	0,43	1,00	2,87	7,32	8,14	11,39	1
4	I	486	21	7,702e+04	7,702e+04	1,00		1,00	23,14	22,78	27,66	30,92	2
5	SO	115	40	7,702e+04	7,702e+04	1,00	0,43	1,00	2,87	7,32	8,14	11,39	1
7	SO	115	40	7,702e+04	7,702e+04	1,00	0,43	1,00	2,87	7,32	8,14	11,39	1

Note: The Classification limits have been set according to Semi-Comp+.
The cross-section is classified as Class 2

Compression check

According to EN 1993-1-1 article 6.2.4 and formula (6.9)

A	3,6370e-02	m ²
$N_{c,Rd}$	12911,35	kN
Unity check	0,22	-

Shear check for V_y

According to EN 1993-1-1 article 6.2.6 and formula (6.17)

η	1,20	
A_v	2,5408e-02	m ²
$V_{pl,y,Rd}$	5207,61	kN
Unity check	0,00	-

Shear check for V_z

According to EN 1993-1-1 article 6.2.6 and formula (6.17)

η	1,20	
A_v	1,4970e-02	m ²
$V_{pl,z,Rd}$	3068,24	kN
Unity check	0,00	-

Decision tables for combined section check

Force presence	
Axial force N_{Ed}	Present
Shear force $V_{y,Ed}$	Not significant
Shear force $V_{z,Ed}$	Not significant
Torsional moment T_{Ed}	Not present
Bending moment $M_{y,Ed}$	Not present

Force presence	
Bending moment $M_{z,Ed}$	Not present
Significant shear force without corresponding bending moment	No
Warping data	Not present or negligible

Check inputs	
Classification is supported	Yes
Section classification	Class 2
Elastic verification is set by the user	No
Plastic shear formula is available	Yes

Selected check	
No combined section check needs to be verified.	

The member satisfies the section check.

....:STABILITY CHECK:....

Classification for member buckling design

Decisive position for stability classification: 0,000 m

Classification according to EN 1993-1-1 article 5.5.2

Classification of Internal and Outstand parts according to EN 1993-1-1 Table 5.2 Sheet 1 & 2

Id	Type	c [mm]	t [mm]	σ_1 [kN/m ²]	σ_2 [kN/m ²]	Ψ [-]	k_{σ} [-]	α [-]	c/t [-]	Class 1 Limit [-]	Class 2 Limit [-]	Class 3 Limit [-]	Class
1	SO	115	40	7,297e+04	7,549e+04	0,97	0,43	1,00	2,87	7,32	8,14	11,24	1
3	SO	115	40	7,132e+04	6,880e+04	0,96	0,44	1,00	2,87	7,32	8,14	11,37	1
4	I	486	21	7,280e+04	7,961e+04	0,91		1,00	23,14	22,78	27,66	31,86	2
5	SO	115	40	7,944e+04	7,692e+04	0,97	0,44	1,00	2,87	7,32	8,14	11,36	1
7	SO	115	40	8,109e+04	8,361e+04	0,97	0,43	1,00	2,87	7,32	8,14	11,23	1

Note: The Classification limits have been set according to Semi-Comp+.

The cross-section is classified as Class 2

Flexural Buckling check

According to EN 1993-1-1 article 6.3.1.1 and formula (6.46)

Buckling parameters	yy	zz	
Sway type	sway	non-sway	
System length L	7,800	7,800	m
Buckling factor k	2,04	0,92	
Buckling length L_{cr}	15,893	7,182	m
Critical Euler load N_{cr}	19529,99	7633,82	kN
Slenderness λ	62,13	99,37	
Relative slenderness λ_{rel}	0,81	1,30	
Limit slenderness $\lambda_{rel,0}$	0,20	0,20	
Buckling curve	a	b	
Imperfection α	0,21	0,34	
Reduction factor χ	0,79	0,43	
Buckling resistance $N_{b,Rd}$	10175,97	5508,42	kN

Flexural Buckling verification

Cross-section area A	3,6370e-02	m ²
Buckling resistance $N_{b,Rd}$	5508,42	kN
Unity check	0,51	-

Torsional(-Flexural) Buckling check

According to EN 1993-1-1 article 6.3.1.1 and formula (6.46)

Note: For this I-section the Torsional(-Flexural) buckling resistance is higher than the resistance for Flexural buckling. Therefore Torsional(-Flexural) buckling is not printed on the output.

Bending and axial compression check

According to EN 1993-1-1 article 6.3.3 and formula (6.61),(6.62)

Bending and axial compression check parameters		
Interaction method	alternative method 1	
Cross-section area A	3,6370e-02	m ²
Plastic section modulus $W_{pl,y}$	8,7720e-03	m ³
Plastic section modulus $W_{pl,z}$	1,9300e-03	m ³
Design compression force N_{Ed}	2801,03	kN
Design bending moment (maximum) $M_{y,Ed}$	33,25	kNm
Design bending moment (maximum) $M_{z,Ed}$	-4,16	kNm
Characteristic compression resistance N_{Rk}	12911,35	kN
Characteristic moment resistance $M_{y,Rk}$	3114,06	kNm
Characteristic moment resistance $M_{z,Rk}$	685,15	kNm
Reduction factor χ_y	0,79	
Reduction factor χ_z	0,43	
Modified reduction factor $\chi_{T,mod}$	1,00	
Interaction factor k_{yy}	0,94	
Interaction factor k_{yz}	0,77	
Interaction factor k_{zy}	0,46	
Interaction factor k_{zz}	0,86	

Maximum moment $M_{y,Ed}$ is derived from beam B3339 position 0,000 m.
 Maximum moment $M_{z,Ed}$ is derived from beam B3339 position 0,000 m.

Interaction method 1 parameters		
Critical Euler load $N_{cr,y}$	19529,99	kN
Critical Euler load $N_{cr,z}$	7633,82	kN
Elastic critical load $N_{cr,T}$	25546,02	kN
Plastic section modulus $W_{pl,y}$	8,7720e-03	m ³
Elastic section modulus $W_{el,y}$	7,6600e-03	m ³
Plastic section modulus $W_{pl,z}$	1,9300e-03	m ³
Elastic section modulus $W_{el,z}$	1,2440e-03	m ³
Second moment of area I_y	2,3800e-03	m ⁴
Second moment of area I_z	1,9000e-04	m ⁴
Torsional constant I_t	1,5640e-05	m ⁴
Method for equivalent moment factor $C_{my,0}$	Table A.2 Line 1 (Linear)	
Ratio of end moments ψ_y	0,00	
Equivalent moment factor $C_{my,0}$	0,77	
Method for equivalent moment factor $C_{mz,0}$	Table A.2 Line 1 (Linear)	
Ratio of end moments ψ_z	0,00	
Equivalent moment factor $C_{mz,0}$	0,75	
Factor μ_y	0,97	
Factor μ_z	0,75	
Factor ϵ_y	0,06	
Factor a_{LT}	0,99	
Critical moment for uniform bending $M_{cr,0}$	3418,21	kNm
Relative slenderness $\lambda_{rel,0}$	0,95	
Limit relative slenderness $\lambda_{rel,0,lim}$	0,23	
Equivalent moment factor C_{my}	0,82	
Equivalent moment factor C_{mz}	0,75	
Equivalent moment factor $C_{m,T}$	1,00	
Factor b_{LT}	0,00	
Factor c_{LT}	0,02	
Factor d_{LT}	0,00	
Factor e_{LT}	0,01	
Factor w_y	1,15	
Factor w_z	1,50	
Factor η_{pl}	0,22	
Maximum relative slenderness $\lambda_{rel,max}$	1,30	
Factor C_{0y}	0,98	
Factor C_{0z}	1,02	
Factor C_{0T}	0,81	
Factor C_{02}	1,02	

Unity check (6.61) = 0,28 + 0,01 + 0,00 = 0,29 -
 Unity check (6.62) = 0,51 + 0,00 + 0,01 = 0,52 -

Shear Buckling check

According to EN 1993-1-5 article 5 & 7.1 and formula (5.10) & (7.1)

Shear Buckling parameters		
Buckling field length a	7,800	m
Web	unstiffened	
Web height h_w	540	mm
Web thickness t	21	mm
Material coefficient ϵ	0,81	
Shear correction factor η	1,20	

Shear Buckling verification	
Web slenderness h_w/t	25,71
Web slenderness limit	48,82

Note: The web slenderness is such that Shear Buckling effects may be ignored according to EN 1993-1-5 article 5.1(2).

The member satisfies the stability check.

4.13.3. REZNE SILE –STUP 2-AMFITEATAR POZ 100

N

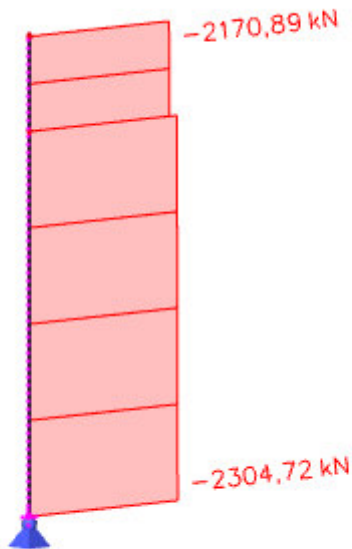

4.13.4. DIMENZIONIRANJE –STUP 2-AMFITEATAR POZ 100

EC-EN 1993 Steel check ULS

Linear calculation
Combination: GSN4
Coordinate system: Principal
Extreme ID: Member
Selection: B4409

EN 1993-1-1 Code Check
National annex: Standard EN

Member B4409	0,000 / 4,800 m	HEM300	S 355	GSN4	0,47 -
---------------------	------------------------	---------------	--------------	-------------	---------------

Combination key
GSN4 / 1.35*vlastita težina + 1.50*pokretno +
1.35*dodatno stalno + 1.50*vjetar smjer x +
0.90*temperatura pozitivna

Partial safety factors	
γ_{M0} for resistance of cross-sections	1,00
γ_{M1} for resistance to instability	1,00
γ_{M2} for resistance of net sections	1,25

Material		
Yield strength f_y	355,0	MPa
Ultimate strength f_u	490,0	MPa
Fabrication	Rolled	

...:SECTION CHECK:...

The critical check is on position 0,000 m

Internal forces	Calculated	Unit
N_{Ed}	-2286,03	kN
$V_{y,Ed}$	24,42	kN
$V_{z,Ed}$	5,67	kN
T_{Ed}	0,00	kNm
$M_{y,Ed}$	0,00	kNm
$M_{z,Ed}$	0,00	kNm

Classification for cross-section design

Classification according to EN 1993-1-1 article 5.5.2

Classification of Internal and Outstand parts according to EN 1993 1-1 Table 5.2 Sheet 1 & 2

Id	Type	c [mm]	t [mm]	σ_1 [kN/m ²]	σ_2 [kN/m ²]	Ψ [-]	k_{σ} [-]	α [-]	c/t [-]	Class 1 Limit [-]	Class 2 Limit [-]	Class 3 Limit [-]	Class
1	SO	117	39	7,542e+04	7,542e+04	1,00	0,43	1,00	3,01	7,32	8,14	11,39	1
3	SO	117	39	7,542e+04	7,542e+04	1,00	0,43	1,00	3,01	7,32	8,14	11,39	1
4	I	208	21	7,542e+04	7,542e+04	1,00		1,00	9,90	22,78	27,66	30,92	1
5	SO	117	39	7,542e+04	7,542e+04	1,00	0,43	1,00	3,01	7,32	8,14	11,39	1
7	SO	117	39	7,542e+04	7,542e+04	1,00	0,43	1,00	3,01	7,32	8,14	11,39	1

Note: The Classification limits have been set according to Semi-Comp+.

The cross-section is classified as Class 1

Compression check

According to EN 1993-1-1 article 6.2.4 and formula (6.9)

A	3,0310e-02	m ²
$N_{c,Rd}$	10760,05	kN
Unity check	0,21	-

Shear check for V_y

According to EN 1993-1-1 article 6.2.6 and formula (6.17)

η	1,20	
A_v	2,5188e-02	m ²
$V_{pl,y,Rd}$	5162,52	kN
Unity check	0,00	-

Shear check for V_z

According to EN 1993-1-1 article 6.2.6 and formula (6.17)

η	1,20	
A_v	9,0550e-03	m ²
$V_{pl,z,Rd}$	1855,91	kN
Unity check	0,00	-

Decision tables for combined section check

Force presence	
Axial force N_{Ed}	Present
Shear force $V_{y,Ed}$	Not significant
Shear force $V_{z,Ed}$	Not significant
Torsional moment T_{Ed}	Not present
Bending moment $M_{y,Ed}$	Not present

Force presence	
Bending moment $M_{z,Ed}$	Not present
Significant shear force without corresponding bending moment	No
Warping data	Not present or negligible

Check inputs	
Classification is supported	Yes
Section classification	Class 1
Elastic verification is set by the user	No
Plastic shear formula is available	Yes

Selected check

No combined section check needs to be verified.

The member satisfies the section check.

....:STABILITY CHECK:....

Classification for member buckling design

Decisive position for stability classification: 4,800 m

Classification according to EN 1993-1-1 article 5.5.2

Classification of Internal and Outstand parts according to EN 1993-1-1 Table 5.2 Sheet 1 & 2

Id	Type	c [mm]	t [mm]	σ_1 [kN/m ²]	σ_2 [kN/m ²]	ψ [-]	k_{σ} [-]	α [-]	c/t [-]	Class 1 Limit [-]	Class 2 Limit [-]	Class 3 Limit [-]	Class
1	SO	117	39	4,187e+04	-2,800e+04	-0,67	12,69	0,60	3,01	15,79	17,54	60,87	1
3	SO	117	39	8,646e+04	1,563e+05	0,55	0,48	1,00	3,01	7,32	8,14	11,78	1
4	I	208	21	6,629e+04	7,579e+04	0,87		1,00	9,90	22,78	27,66	32,32	1
5	SO	117	39	1,002e+05	1,701e+05	0,59	0,47	1,00	3,01	7,32	8,14	11,72	1
7	SO	117	39	5,561e+04	-1,425e+04	-0,26	4,10	0,80	3,01	10,31	11,46	34,62	1

Note: The Classification limits have been set according to Semi-Comp+.

The cross-section is classified as Class 1

Flexural Buckling check

According to EN 1993-1-1 article 6.3.1.1 and formula (6.46)

Buckling parameters	yy	zz	
Sway type	sway	non-sway	
System length l	4,800	4,800	m
Buckling factor k	2,17	0,77	
Buckling length L_{cr}	10,406	3,678	m
Critical Euler load N_{cr}	11350,39	29725,67	kN
Slenderness λ	74,40	45,97	
Relative slenderness λ_{rel}	0,97	0,60	
Limit slenderness $\lambda_{rel,0}$	0,20	0,20	
Buckling curve	b	c	
Imperfection α	0,34	0,49	
Reduction factor χ	0,61	0,78	
Buckling resistance $N_{b,Rd}$	6604,78	8440,27	kN

Flexural Buckling verification

Cross-section area A	3,0310e-02	m ²
Buckling resistance $N_{b,Rd}$	6604,78	kN
Unity check	0,35	-

Torsional(-Flexural) Buckling check

According to EN 1993-1-1 article 6.3.1.1 and formula (6.46)

Note: For this I-section the Torsional(-Flexural) buckling resistance is higher than the resistance for Flexural buckling. Therefore Torsional(-Flexural) buckling is not printed on the output.

Bending and axial compression check

According to EN 1993-1-1 article 6.3.3 and formula (6.61),(6.62)

Bending and axial compression check parameters		
Interaction method	alternative method 1	
Cross-section area A	3,0310e-02	m ²
Plastic section modulus $W_{pl,y}$	4,0780e-03	m ³
Plastic section modulus $W_{pl,z}$	1,9130e-03	m ³
Design compression force N_{Ed}	2286,03	kN
Design bending moment (maximum) $M_{y,Ed}$	27,04	kNm
Design bending moment (maximum) $M_{z,Ed}$	115,37	kNm
Characteristic compression resistance N_{Rk}	10760,05	kN
Characteristic moment resistance $M_{y,Rk}$	1447,69	kNm
Characteristic moment resistance $M_{z,Rk}$	679,12	kNm
Reduction factor χ_y	0,61	
Reduction factor χ_z	0,78	
Modified reduction factor $\chi_{T,mod}$	1,00	
Interaction factor k_{yy}	0,93	
Interaction factor k_{yz}	0,63	
Interaction factor k_{zy}	0,58	
Interaction factor k_{zz}	1,04	

Maximum moment $M_{y,Ed}$ is derived from beam B4409 position 4,800 m.
Maximum moment $M_{z,Ed}$ is derived from beam B4409 position 4,800 m.

Interaction method 1 parameters		
Critical Euler load $N_{cr,y}$	11350,39	kN
Critical Euler load $N_{cr,z}$	29725,67	kN
Elastic critical load $N_{cr,T}$	58994,20	kN
Plastic section modulus $W_{pl,y}$	4,0780e-03	m ³
Elastic section modulus $W_{el,y}$	3,4820e-03	m ³
Plastic section modulus $W_{pl,z}$	1,9130e-03	m ³
Elastic section modulus $W_{el,z}$	1,2520e-03	m ³
Second moment of area I_y	5,9300e-04	m ⁴
Second moment of area I_z	1,9400e-04	m ⁴
Torsional constant I_t	1,4080e-05	m ⁴
Method for equivalent moment factor $C_{my,0}$	Table A.2 Line 1 (Linear)	
Ratio of end moments ψ_y	0,00	
Equivalent moment factor $C_{my,0}$	0,77	
Method for equivalent moment factor $C_{mz,0}$	Table A.2 Line 2 (General)	
Design bending moment (maximum) $M_{z,Ed}$	115,37	kNm
Maximum relative deflection δ_y	-4,2	mm
Equivalent moment factor $C_{mz,0}$	0,97	
Factor μ_y	0,91	
Factor μ_z	0,98	
Factor ϵ_y	0,10	
Factor $a_{1,T}$	0,98	
Critical moment for uniform bending $M_{cr,0}$	5170,33	kNm
Relative slenderness $\lambda_{rel,0}$	0,53	
Limit relative slenderness $\lambda_{rel,0,lim}$	0,26	
Equivalent moment factor C_{my}	0,82	
Equivalent moment factor C_{mz}	0,97	
Equivalent moment factor $C_{m1,T}$	1,00	
Factor $b_{1,T}$	0,00	
Factor $c_{1,T}$	0,01	
Factor $d_{1,T}$	0,02	
Factor $e_{1,T}$	0,09	
Factor w_y	1,17	
Factor w_z	1,50	
Factor n_{pl}	0,21	
Maximum relative slenderness $\lambda_{rel,max}$	0,97	
Factor C_{yy}	1,01	
Factor C_{yz}	1,03	
Factor C_{zy}	0,92	
Factor C_{zz}	1,00	

Unity check (6.61) = $0,35 + 0,02 + 0,11 = 0,47$ -

Unity check (6.62) = $0,27 + 0,01 + 0,18 = 0,46$ -

Shear Buckling check

According to EN 1993-1-5 article 5 & 7.1 and formula (5.10) & (7.1)

Shear Buckling parameters		
Buckling field length a	4,800	m
Web	unstiffened	
Web height h_w	262	mm
Web thickness t	21	mm
Material coefficient ϵ	0,81	
Shear correction factor η	1,20	

Shear Buckling verification	
Web slenderness h_w/t	12,48
Web slenderness limit	48,82

Note: The web slenderness is such that Shear Buckling effects may be ignored according to EN 1993-1-5 article 5.1(2).

The member satisfies the stability check.

4.13.5. REZNE SILE –STUP 3 POZ 200

N

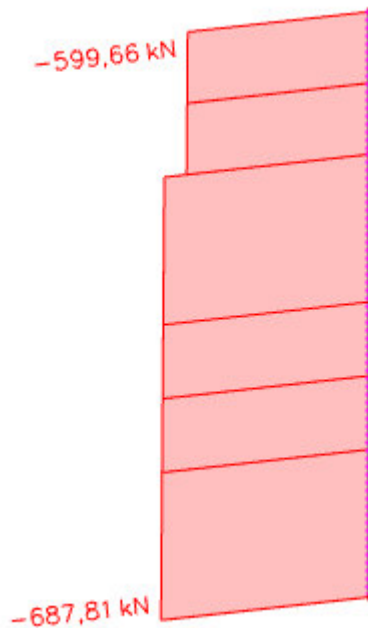

4.13.6. DIMENZIONIRANJE –STUP 3 POZ 200

EC-EN 1993 Steel check ULS

Linear calculation
Combination: GSN5
Coordinate system: Principal
Extreme ID: Member
Selection: B985

EN 1993-1-1 Code Check
National annex: Standard EN

Member B985	3,900 / 3,900 m	HEM600	S 355	GSN5	0,27 -
--------------------	------------------------	---------------	--------------	-------------	---------------

Combination key
GSN5 / 1.35*vlastita težina + 1.50*pokretno +
1.35*dodatno stalno + 1.50*vjetar smjer x +
0.90*temperatura negativna

Partial safety factors	
γ_{M0} for resistance of cross-sections	1,00
γ_{M1} for resistance to instability	1,00
γ_{M2} for resistance of net sections	1,25

Material		
Yield strength f_y	355,0	MPa
Ultimate strength f_u	490,0	MPa
Fabrication	Rolled	

....:SECTION CHECK:....

The critical check is on position 3,900 m

Internal forces	Calculated	Unit
N_{Ed}	-687,81	kN
$V_{y,Ed}$	39,13	kN
$V_{z,Ed}$	-109,69	kN
T_{Ed}	0,11	kNm
$M_{y,Ed}$	-369,23	kNm
$M_{z,Ed}$	95,39	kNm

Classification for cross-section design

Classification according to EN 1993-1-1 article 5.5.2

Classification of Internal and Outstand parts according to EN 1993-1-1 Table 5.2 Sheet 1 & 2

Id	Type	c [mm]	t [mm]	σ_1 [kN/m ²]	σ_2 [kN/m ²]	ψ [-]	k_{σ} [-]	α [-]	c/t [-]	Class 1 Limit [-]	Class 2 Limit [-]	Class 3 Limit [-]	Class
1	SO	115	40	4,515e+04	-1,266e+04	-0,28	4,45	0,78	2,87	10,61	11,79	36,03	1
3	SO	115	40	8,285e+04	1,407e+05	0,59	0,47	1,00	2,87	7,32	8,14	11,72	1
4	I	486	21	5,670e+04	-1,887e+04	-0,33		0,59	23,14	45,12	53,02	57,52	1
5	SO	115	40	-7,327e+03	5,048e+04	-0,15	0,60	0,87	2,87	8,39	9,32	13,26	1
7	SO	115	40	-4,503e+04	-1,028e+05								

Note: The Classification limits have been set according to Semi-Comp+.
The cross-section is classified as Class 1

Compression check

According to EN 1993-1-1 article 6.2.4 and formula (6.9)

A	3,6370e-02	m ²
$N_{c,Ed}$	12911,35	kN
Unity check	0,05	-

Bending moment check for M_y

According to EN 1993-1-1 article 6.2.5 and formula (6.12),(6.13)

W_{ply}	8,7720e-03	m ³
$M_{ply,Ed}$	3114,06	kNm
Unity check	0,12	-

Bending moment check for M_z

According to EN 1993-1-1 article 6.2.5 and formula (6.12),(6.13)

$W_{pl,z}$	1,9300e-03	m ³
$M_{pl,z,Ed}$	685,15	kNm
Unity check	0,14	-

Shear check for V_y

According to EN 1993-1-1 article 6.2.6 and formula (6.17)

η	1,20	
A_v	2,5408e-02	m ²
$V_{ply,Ed}$	5207,61	kN
Unity check	0,01	-

Shear check for V_z

According to EN 1993-1-1 article 6.2.6 and formula (6.17)

η	1,20	
A_v	1,4970e-02	m ²
$V_{pl,z,Rd}$	3068,24	kN
Unity check	0,04	-

Torsion check

According to EN 1993-1-1 article 6.2.7 and formula (6.23)

Fibre	2	
T_{Ed}	0,3	MPa
T_{Rd}	205,0	MPa
Unity check	0,00	-

Note: The unity check for torsion is lower than the limit value of 0,05. Therefore torsion is considered as insignificant and is ignored in the combined checks.

Combined bending, axial force and shear force check

According to EN 1993-1-1 article 6.2.9.1 and formula (6.41)

$M_{pl,y,Rd}$	3114,06	kNm
α	2,00	
$M_{pl,z,Rd}$	685,15	kNm
β	1,00	

Unity check (6.41) = 0,01 + 0,14 = 0,15 -

Note: Since the shear forces are less than half the plastic shear resistances their effect on the moment resistances is neglected.

Note: Since the axial force satisfies both criteria (6.33) and (6.34) of EN 1993-1-1 article 6.2.9.1(4) its effect on the moment resistance about the y-y axis is neglected.

Note: Since the axial force satisfies criteria (6.35) of EN 1993-1-1 article 6.2.9.1(4) its effect on the moment resistance about the z-z axis is neglected.

Decision tables for combined section check

Force presence	
Axial force N_{Ed}	Present
Shear force $V_{y,Ed}$	Not significant
Shear force $V_{z,Ed}$	Not significant
Torsional moment T_{Ed}	Not significant
Bending moment $M_{y,Ed}$	Present
Bending moment $M_{z,Ed}$	Present
Significant shear force without corresponding bending moment	No
Warping data	Not present or negligible

Check inputs	
Classification is supported	Yes
Section classification	Class 1
Elastic verification is set by the user	No
Plastic shear formula is available	Yes
Combined bending and axial force formula is available	Yes
Combined bending and axial force check can be calculated	Yes

Selected check

According to EN 1993-1-1 article 6.2.9.1 and formula (6.41)

The member satisfies the section check.

....:STABILITY CHECK:....

Classification for member buckling design

Decisive position for stability classification: 2,425 m

Classification according to EN 1993-1-1 article 5.5.2

Classification of Internal and Outstand parts according to EN 1993-1-1 Table 5.2 Sheet 1 & 2

Id	Type	c [mm]	t [mm]	σ_1 [kN/m ²]	σ_2 [kN/m ²]	Ψ [-]	k_{σ} [-]	α [-]	c/t [-]	Class 1 Limit [-]	Class 2 Limit [-]	Class 3 Limit [-]	Class
1	SO	115	40	2,816e+04	5,329e+03	0,19	1,09	1,00	2,87	7,32	8,14	17,86	1
3	SO	115	40	4,305e+04	6,589e+04	0,65	0,46	1,00	2,87	7,32	8,14	11,62	1
4	I	486	21	3,288e+04	4,640e+03	0,14		1,00	23,14	22,78	27,66	44,04	2
5	SO	115	40	9,355e+03	3,219e+04	0,29	0,51	1,00	2,87	7,32	8,14	12,26	1
7	SO	115	40	-5,537e+03	-2,837e+04								

Note: The Classification limits have been set according to Semi-Comp+.

The cross-section is classified as Class 2

Flexural Buckling check

According to EN 1993-1-1 article 6.3.1.1 and formula (6.46)

Buckling parameters	yy	zz	
Sway type	sway	non-sway	
System length L	2,950	3,900	m
Buckling factor k	2,55	0,61	
Buckling length L_{cr}	7,534	2,379	m

Buckling parameters	yy	zz	
Critical Euler load N_{cr}	86897,25	69573,56	kN
Slenderness λ	29,45	32,92	
Relative slenderness λ_{rel}	0,39	0,43	
Limit slenderness $\lambda_{rel,0}$	0,20	0,20	

Note: The slenderness or compression force is such that Flexural Buckling effects may be ignored according to EN 1993-1-1 article 6.3.1.2(4).

Torsional(-Flexural) Buckling check

According to EN 1993-1-1 article 6.3.1.1 and formula (6.46)

Note: For this I-section the Torsional(-Flexural) buckling resistance is higher than the resistance for Flexural buckling. Therefore Torsional(-Flexural) buckling is not printed on the output.

Lateral Torsional Buckling check

According to EN 1993-1-1 article 6.3.2.1 & 6.3.2.3 and formula (6.54)

LTB parameters		
Method for LTB curve	Alternative case	
Plastic section modulus $W_{pl,y}$	8,7720e-03	m ³
Elastic critical moment M_{cr}	28413,28	kNm
Relative slenderness $\lambda_{rel,LT}$	0,33	
Limit slenderness $\lambda_{rel,LT,0}$	0,40	

Note: The slenderness or bending moment is such that Lateral Torsional Buckling effects may be ignored according to EN 1993-1-1 article 6.3.2.2(4).

Mcr parameters		
LTB length L	3,900	m
Influence of load position	no influence	
Correction factor k	1,00	
Correction factor k_{σ}	1,00	
LTB moment factor C_1	3,01	
LTB moment factor C_2	0,43	
LTB moment factor C_3	1,00	
Shear center distance d_x	0	mm
Distance of load application z_g	0	mm
Mono-symmetry constant β_y	0	mm
Mono-symmetry constant z_1	0	mm

Note: C parameters are determined according to ECCS 119 2006 / Gafea 2002.

LTB-additional parameters		
Minimal z coordinate z_{min}	-310	mm
Maximal z coordinate z_{max}	310	mm
End moment ratio ψ	-0,58	
Equivalent point load F	156,60	kN
Equivalent line load q	80,31	kN/m
Difference with M	282,31	kNm
Difference with F	401,77	kNm
Difference with q	403,59	kNm
Resulting load type	point load F	

Bending and axial compression check

According to EN 1993-1-1 article 6.3.3 and formula (6.61),(6.62)

Bending and axial compression check parameters		
Interaction method	alternative method 1	
Cross-section area A	3,6370e-02	m ²
Plastic section modulus $W_{pl,y}$	8,7720e-03	m ³
Plastic section modulus $W_{pl,z}$	1,9300e-03	m ³
Design compression force N_{Ed}	687,81	kN
Design bending moment (maximum) $M_{y,Ed}$	-369,23	kNm
Design bending moment (maximum) $M_{z,Ed}$	95,39	kNm
Characteristic compression resistance N_{Rk}	12911,35	kN
Characteristic moment resistance $M_{y,Rk}$	3114,06	kNm
Characteristic moment resistance $M_{z,Rk}$	685,15	kNm
Reduction factor χ_y	1,00	
Reduction factor χ_z	1,00	
Modified reduction factor $\chi_{LT,mod}$	1,00	
Interaction factor k_{yy}	1,00	
Interaction factor k_{yz}	0,69	
Interaction factor k_{zy}	0,54	
Interaction factor k_{zz}	0,99	

 Maximum moment $M_{y,Ed}$ is derived from beam B985 position 3,900 m.

 Maximum moment $M_{z,Ed}$ is derived from beam B985 position 3,900 m.

Interaction method 1 parameters		
Critical Euler load $N_{cr,y}$	86897,25	kN
Critical Euler load $N_{cr,z}$	69573,56	kN
Elastic critical load $N_{cr,T}$	48553,32	kN
Plastic section modulus $W_{pl,y}$	8,7720e-03	m ³
Elastic section modulus $W_{el,y}$	7,6600e-03	m ³

Interaction method 1 parameters		
Plastic section modulus $W_{pl,z}$	1,9300e-03	m ³
Elastic section modulus $W_{el,z}$	1,2440e-03	m ³
Second moment of area I_y	2,3800e-03	m ⁴
Second moment of area I_z	1,9000e-04	m ⁴
Torsional constant I_t	1,5640e-05	m ⁴
Method for equivalent moment factor $C_{my,0}$	Table A.2 Line 2 (General)	
Design bending moment (maximum) $M_{y,Ed}$	-369,23	kNm
Maximum relative deflection δ_z	0,4	mm
Equivalent moment factor $C_{my,0}$	1,00	
Method for equivalent moment factor $C_{mz,0}$	Table A.2 Line 2 (General)	
Design bending moment (maximum) $M_{z,Ed}$	95,39	kNm
Maximum relative deflection δ_y	-1,2	mm
Equivalent moment factor $C_{mz,0}$	0,99	
Factor μ_y	1,00	
Factor μ_z	1,00	
Factor ϵ_y	2,55	
Factor $a_{1,T}$	0,99	
Critical moment for uniform bending $M_{cr,0}$	9424,89	kNm
Relative slenderness $\lambda_{rel,0}$	0,57	
Limit relative slenderness $\lambda_{rel,0,lim}$	0,35	
Equivalent moment factor C_{my}	1,00	
Equivalent moment factor C_{mz}	0,99	
Equivalent moment factor C_{mLT}	1,00	
Factor b_{LT}	0,00	
Factor c_{LT}	0,08	
Factor d_{LT}	0,14	
Factor $e_{1,T}$	0,86	
Factor w_y	1,15	
Factor w_z	1,50	
Factor n_{pl}	0,05	
Maximum relative slenderness $\lambda_{rel,max}$	0,43	
Factor C_{yy}	1,01	
Factor C_{yz}	1,01	
Factor C_{zy}	0,98	
Factor C_{zz}	1,01	

Unity check (6.61) = 0,05 + 0,12 + 0,10 = 0,27 -

Unity check (6.62) = 0,05 + 0,06 + 0,14 = 0,25 -

Shear Buckling check

According to EN 1993-1-5 article 5 & 7.1 and formula (5.10) & (7.1)

Shear buckling parameters		
Buckling field length a	3,900	m
Web	unstiffened	
Web height h_w	540	mm
Web thickness t	21	mm
Material coefficient ϵ	0,81	
Shear correction factor η	1,20	

Shear Buckling verification		
Web slenderness h_w/t	25,71	
Web slenderness limit	48,82	

Note: The web slenderness is such that Shear Buckling effects may be ignored according to EN 1993-1-5 article 5.1(2).

The member satisfies the stability check.

4.13.7. REZNE SILE –STUP 4 POZ 300

N

4.13.8. DIMENZIONIRANJE –STUP 4 POZ 300

EC-EN 1993 Steel check ULS

Linear calculation
Combination: GSN4
Coordinate system: Principal
Extreme ID: Member
Selection: B1519

EN 1993-1-1 Code Check
National annex: Standard EN

Member B1519 3,850 / 4,800 m HEM600 S 355 GSN4 0,41 -

Combination key
GSN4 / 1.35*vlastita težina + 1.50*pokretno +
1.35*dodatno stalno + 1.50*vjetar smjer x +
0.90*temperatura pozitivna

Partial safety factors	
γ_{M0} for resistance of cross-sections	1,00
γ_{M1} for resistance to instability	1,00
γ_{M2} for resistance of net sections	1,25

Material		
Yield strength f_y	355,0	MPa
Ultimate strength f_u	490,0	MPa
Fabrication	Rolled	

....SECTION CHECK:....

The critical check is on position 3,850 m

Internal forces	Calculated	Unit
N_{Ed}	-316,47	kN
$V_{y,Ed}$	-2,80	kN
$V_{z,Ed}$	-391,50	kN
T_{Ed}	-0,23	kNm
$M_{y,Ed}$	-758,88	kNm
$M_{z,Ed}$	-8,00	kNm

Classification for cross-section design

Classification according to EN 1993-1-1 article 5.5.2
Classification of Internal and Outstand parts according to EN 1993-1-1 Table 5.2 Sheet 1 & 2

Id	Type	c [mm]	t [mm]	σ_1 [kN/m ²]	σ_2 [kN/m ²]	ψ [-]	k_o [-]	α [-]	c/t [-]	Class 1 Limit [-]	Class 2 Limit [-]	Class 3 Limit [-]	Class [-]
1	SO	115	40	1,030e+05	1,078e+05	0,96	0,43	1,00	2,87	7,32	8,14	11,25	1
3	SO	115	40	9,980e+04	9,494e+04	0,95	0,45	1,00	2,87	7,32	8,14	11,43	1
4	I	486	21	8,636e+04	-6,895e+04	-0,80		0,54	23,14	51,51	59,98	82,24	1
5	SO	115	40	-8,556e+04	-9,041e+04								
7	SO	115	40	-8,239e+04	-7,754e+04								

Note: The Classification limits have been set according to Semi-Comp+.
The cross-section is classified as Class 1

Compression check

According to EN 1993-1-1 article 6.2.4 and formula (6.9)

A	3,6370e-02	m ²
$N_{c,Ed}$	12911,35	kN
Unity check	0,02	-

Bending moment check for M_y

According to EN 1993-1-1 article 6.2.5 and formula (6.12),(6.13)

W_{ply}	8,7720e-03	m ³
$M_{ply,Ed}$	3114,06	kNm
Unity check	0,24	-

Bending moment check for M_z

According to EN 1993-1-1 article 6.2.5 and formula (6.12),(6.13)

$W_{pl,z}$	1,9300e-03	m^3
$M_{pl,z,Rd}$	685,15	kNm
Unity check	0,01	-

Shear check for V_y

According to EN 1993-1-1 article 6.2.6 and formula (6.17)

η	1,20	
A_v	2,5408e-02	m^2
$V_{pl,y,Rd}$	5207,61	kN
Unity check	0,00	-

Shear check for V_z

According to EN 1993-1-1 article 6.2.6 and formula (6.17)

η	1,20	
A_v	1,4970e-02	m^2
$V_{pl,z,Rd}$	3068,24	kN
Unity check	0,13	-

Torsion check

According to EN 1993-1-1 article 6.2.7 and formula (6.23)

Fibre	2	
T_{Ed}	0,6	MPa
T_{Rd}	205,0	MPa
Unity check	0,00	-

Note: The unity check for torsion is lower than the limit value of 0,05. Therefore torsion is considered as insignificant and is ignored in the combined checks.

Combined bending, axial force and shear force check

According to EN 1993-1-1 article 6.2.9.1 and formula (6.41)

$M_{pl,y,Rd}$	3114,06	kNm
α	2,00	
$M_{pl,z,Rd}$	685,15	kNm
β	1,00	

Unity check (6.41) = 0,06 + 0,01 = 0,07 -

Note: Since the shear forces are less than half the plastic shear resistances their effect on the moment resistances is neglected.

Note: Since the axial force satisfies both criteria (6.33) and (6.34) of EN 1993-1-1 article 6.2.9.1(4) its effect on the moment resistance about the y-y axis is neglected.

Note: Since the axial force satisfies criteria (6.35) of EN 1993-1-1 article 6.2.9.1(4) its effect on the moment resistance about the z-z axis is neglected.

Decision tables for combined section check

Force presence	
Axial force N_{Ed}	Present
Shear force $V_{y,Ed}$	Not significant
Shear force $V_{z,Ed}$	Not significant
Torsional moment T_{Ed}	Not significant
Bending moment $M_{y,Ed}$	Present
Bending moment $M_{z,Ed}$	Present
Significant shear force without corresponding bending moment	No
Warping data	Not present or negligible

Check inputs	
Classification is supported	Yes
Section classification	Class 1
Elastic verification is set by the user	No
Plastic shear formula is available	Yes
Combined bending and axial force formula is available	Yes
Combined bending and axial force check can be calculated	Yes

Selected check
According to EN 1993-1-1 article 6.2.9.1 and formula (6.41)

The member satisfies the section check.

...::STABILITY CHECK::...

Classification for member buckling design

Decisive position for stability classification: 4,800 m

Classification according to EN 1993-1-1 article 5.5.2

Classification of Internal and Outstand parts according to EN 1993-1-1 Table 5.2 Sheet 1 & 2

Id	Type	c [mm]	t [mm]	σ_1 [kN/m ²]	σ_2 [kN/m ²]	Ψ [-]	k_σ [-]	α [-]	c/t [-]	Class 1 Limit [-]	Class 2 Limit [-]	Class 3 Limit [-]	Class
1	SO	115	40	1,533e+05	1,598e+05	0,96	0,43	1,00	2,87	7,32	8,14	11,24	1
3	SO	115	40	1,491e+05	1,427e+05	0,96	0,45	1,00	2,87	7,32	8,14	11,41	1
4	I	486	21	1,281e+05	-1,109e+05	-0,87		0,54	23,14	51,58	60,06	87,68	1
5	SO	115	40	-1,361e+05	-1,426e+05								
7	SO	115	40	-1,319e+05	-1,255e+05								

Note: The Classification limits have been set according to Semi-Comp+.

The cross-section is classified as Class 1

Flexural Buckling check

According to EN 1993-1-1 article 6.3.1.1 and formula (6.46)

Buckling parameters	yy	zz	
Sway type	sway	non-sway	
System length L	0,950	4,800	m
Buckling factor k	3,25	0,55	
Buckling length L_{cr}	3,083	2,661	m

4.13.9. REZNE SILE –STUP 5 POZ 400

N



4.13.10. DIMENZIONIRANJE –STUP 5 POZ 400

EC-EN 1993 Steel check ULS

Linear calculation
Combination: GSN4
Coordinate system: Principal
Extreme ID: Member
Selection: 82278

EN 1993-1-1 Code Check
National annex: Standard EN

Member B2278	0,000 / 6,800 m	HEM600	S 355	GSN4	0,47 -
--------------	-----------------	--------	-------	------	--------

Combination key	
GSN4 / 1.35*vlastita težina + 1.50*pokretno + 1.35*dodatno stalno + 1.50*vjetar smjer x + 0.90*temperatura pozitivna	

Partial safety factors	
γ_{M0} for resistance of cross-sections	1,00
γ_{M1} for resistance to instability	1,00
γ_{M2} for resistance of net sections	1,25

Material		
Yield strength f_y	355,0	MPa
Ultimate strength f_u	490,0	MPa
Fabrication	Rolled	

...:SECTION CHECK:...:
The critical check is on position 0,000 m

Internal forces	Calculated	Unit
N_{Ed}	-161,99	kN
$V_{y,Ed}$	-0,01	kN
$V_{z,Ed}$	197,32	kN
T_{Ed}	-0,78	kNm
$M_{y,Ed}$	-249,12	kNm
$M_{z,Ed}$	1,90	kNm

Classification for cross-section design

Classification according to EN 1993-1-1 article 5.5.2

Classification of Internal and Outstand parts according to EN 1993-1-1 Table 5.2 Sheet 1 & 2

Id	Type	c [mm]	t [mm]	σ_1 [kN/m ²]	σ_2 [kN/m ²]	ψ [-]	k_{σ} [-]	α [-]	c/t [-]	Class 1 Limit [-]	Class 2 Limit [-]	Class 3 Limit [-]	Class
1	SO	115	40	3,450e+04	3,335e+04	0,97	0,44	1,00	2,87	7,32	8,14	11,36	1
3	SO	115	40	3,525e+04	3,640e+04	0,97	0,43	1,00	2,87	7,32	8,14	11,23	1
4	I	486	21	2,995e+04	-2,104e+04	-0,70		0,52	23,14	54,73	63,44	75,55	1
5	SO	115	40	-2,559e+04	-2,445e+04								
7	SO	115	40	-2,634e+04	-2,749e+04								

Note: The Classification limits have been set according to Semi-Comp+.

The cross-section is classified as Class 1

Compression check

According to EN 1993-1-1 article 6.2.4 and formula (6.9)

A	3,6370e-02	m ²
$N_{c,Rd}$	12911,35	kN
Unity check	0,01	-

Bending moment check for M_y

According to EN 1993-1-1 article 6.2.5 and formula (6.12),(6.13)

$W_{pl,y}$	8,7720e-03	m ³
$M_{pl,y,Rd}$	3114,06	kNm
Unity check	0,08	-

Bending moment check for M_z

According to EN 1993-1-1 article 6.2.5 and formula (6.12),(6.13)

$W_{pl,z}$	1,9300e-03	m ³
$M_{pl,z,Rd}$	685,15	kNm
Unity check	0,00	-

Shear check for V_y

According to EN 1993-1-1 article 6.2.6 and formula (6.17)

η	1,20	
A_v	2,5408e-02	m ²
$V_{pl,y,Rd}$	5207,61	kN
Unity check	0,00	-

Shear check for V_z

According to EN 1993-1-1 article 6.2.6 and formula (6.17)

η	1,20	
A_v	1,4970e-02	m ²
$V_{pl,z,Rd}$	3068,24	kN
Unity check	0,06	-

Torsion check

According to EN 1993-1-1 article 6.2.7 and formula (6.23)

Fibre	2	
T_{Ed}	2,0	MPa
T_{Rd}	205,0	MPa
Unity check	0,01	-

Note: The unity check for torsion is lower than the limit value of 0,05. Therefore torsion is considered as insignificant and is ignored in the combined checks.

Combined bending, axial force and shear force check

According to EN 1993-1-1 article 6.2.9.1 and formula (6.41)

$M_{pl,y,Rd}$	3114,06	kNm
α	2,00	
$M_{pl,z,Rd}$	685,15	kNm
β	1,00	

Unity check (6.41) = 0,01 + 0,00 = 0,01 -

Note: Since the shear forces are less than half the plastic shear resistances their effect on the moment resistances is neglected.

Note: Since the axial force satisfies both criteria (6.33) and (6.34) of EN 1993-1-1 article 6.2.9.1(4) its effect on the moment resistance about the y-y axis is neglected.

Note: Since the axial force satisfies criteria (6.35) of EN 1993-1-1 article 6.2.9.1(4) its effect on the moment resistance about the z-z axis is neglected.

Decision tables for combined section check

Force presence	
Axial force N_{Ed}	Present
Shear force $V_{y,Ed}$	Not significant
Shear force $V_{z,Ed}$	Not significant
Torsional moment T_{Ed}	Not significant
Bending moment $M_{y,Ed}$	Present
Bending moment $M_{z,Ed}$	Present
Significant shear force without corresponding bending moment	No
Warping data	Not present or negligible

Check inputs	
Classification is supported	Yes
Section classification	Class 1
Elastic verification is set by the user	No
Plastic shear formula is available	Yes
Combined bending and axial force formula is available	Yes
Combined bending and axial force check can be calculated	Yes

Selected check	
According to EN 1993-1-1 article 6.2.9.1 and formula (6.41)	

The member satisfies the section check.

....:STABILITY CHECK:....
Classification for member buckling design

Decisive position for stability classification: 6,800 m

Classification according to EN 1993-1-1 article 5.5.2

Classification of Internal and Outstand parts according to EN 1993-1-1 Table 5.2 Sheet 1 & 2

Id	Type	c [mm]	t [mm]	σ_1 [kN/m ²]	σ_2 [kN/m ²]	ψ [-]	k_σ [-]	α [-]	c/t [-]	Class 1 Limit [-]	Class 2 Limit [-]	Class 3 Limit [-]	Class
1	SO	115	40	1,770e+05	1,759e+05	0,99	0,43	1,00	2,87	7,32	8,14	11,25	1
3	SO	115	40	1,777e+05	1,788e+05	0,99	0,43	1,00	2,87	7,32	8,14	11,21	1
4	I	486	21	1,492e+05	-1,417e+05	-0,95		0,52	23,14	55,31	64,06	95,59	1
5	SO	115	40	-1,695e+05	-1,684e+05								
7	SO	115	40	-1,702e+05	-1,713e+05								

Note: The Classification limits have been set according to Semi-Comp+.

The cross-section is classified as Class 1

Flexural Buckling check

According to EN 1993-1-1 article 6.3.1.1 and formula (6.46)

Buckling parameters	yy	zz	
Sway type	sway	non-sway	
System length L	6,800	6,800	m
Buckling factor k	2,08	0,58	
Buckling length L_{cr}	14,143	3,964	m

Buckling parameters	yy	zz	
Critical Euler load N_{cr}	24659,69	25062,40	kN
Slenderness λ	55,29	54,84	
Relative slenderness λ_{rel}	0,72	0,72	
Limit slenderness $\lambda_{rel,D}$	0,20	0,20	

Note: The slenderness or compression force is such that Flexural Buckling effects may be ignored according to EN 1993-1-1 article 6.3.1.2(4).

Torsional(-Flexural) Buckling check

According to EN 1993-1-1 article 6.3.1.1 and formula (6.46)

Note: For this I-section the Torsional(-Flexural) buckling resistance is higher than the resistance for Flexural buckling. Therefore Torsional(-Flexural) buckling is not printed on the output.

Lateral Torsional Buckling check

According to EN 1993-1-1 article 6.3.2.1 & 6.3.2.3 and formula (6.54)

LTB parameters		
Method for LTB curve	Alternative case	
Plastic section modulus $W_{pl,y}$	8,7720e-03	m ³
Elastic critical moment M_{cr}	12585,12	kNm
Relative slenderness $\lambda_{rel,LT}$	0,50	
Limit slenderness $\lambda_{rel,LT,D}$	0,40	

Note: The slenderness or bending moment is such that Lateral Torsional Buckling effects may be ignored according to EN 1993-1-1 article 6.3.2.2(4).

Mcr parameters		
LTB length L	6,800	m
Influence of load position	no influence	
Correction factor k	1,00	
Correction factor k_{eff}	1,00	
LTB moment factor C_1	3,07	
LTB moment factor C_2	0,42	
LTB moment factor C_3	1,00	
Shear center distance d_x	0	mm
Distance of load application z_g	0	mm
Mono-symmetry constant β_y	0	mm
Mono-symmetry constant z_j	0	mm

Note: C parameters are determined according to ECCS 119 2006 / Galea 2002.

LTB additional parameters		
Minimal z coordinate z_{min}	-310	mm
Maximal z coordinate z_{max}	310	mm
End moment ratio ψ	0,18	
Equivalent point load F	369,75	kN
Equivalent line load q	108,75	kN/m
Difference with M	3502,06	kNm
Difference with F	718,37	kNm
Difference with q	0,00	kNm
Resulting load type	line load q	

Bending and axial compression check

According to EN 1993-1-1 article 6.3.3 and formula (6.61),(6.62)

Bending and axial compression check parameters		
Interaction method	alternative method 1	
Cross-section area A	3,6370e-02	m ²
Plastic section modulus $W_{pl,y}$	8,7720e-03	m ³
Plastic section modulus $W_{pl,z}$	1,9300e-03	m ³
Design compression force N_{Ed}	161,99	kN
Design bending moment (maximum) $M_{y,Ed}$	-1421,66	kNm
Design bending moment (maximum) $M_{z,Ed}$	1,90	kNm
Characteristic compression resistance N_{Rk}	12911,35	kN
Characteristic moment resistance $M_{y,Rk}$	3114,06	kNm
Characteristic moment resistance $M_{z,Rk}$	685,15	kNm
Reduction factor χ_y	1,00	
Reduction factor χ_z	1,00	
Modified reduction factor $\chi_{T,mod}$	1,00	
Interaction factor k_{yy}	1,01	
Interaction factor k_{yz}	1,01	
Interaction factor k_{zy}	0,53	
Interaction factor k_{zz}	1,01	

Maximum moment $M_{y,Ed}$ is derived from beam B2278 position 6,800 m.

Maximum moment $M_{z,Ed}$ is derived from beam B2278 position 0,000 m.

Interaction method 1 parameters		
Critical Euler load $N_{cr,y}$	24659,69	kN
Critical Euler load $N_{cr,z}$	25062,40	kN
Elastic critical load $N_{cr,T}$	27967,50	kN
Plastic section modulus $W_{pl,y}$	8,7720e-03	m ³
Elastic section modulus $W_{el,y}$	7,6600e-03	m ³

Interaction method 1 parameters		
Plastic section modulus $W_{pl,z}$	1,9300e-03	m ³
Elastic section modulus $W_{el,z}$	1,2440e-03	m ³
Second moment of area I_y	2,3800e-03	m ⁴
Second moment of area I_z	1,9000e-04	m ⁴
Torsional constant I_t	1,5640e-05	m ⁴
Method for equivalent moment factor $C_{my,0}$	Table A.2 Line 2 (General)	
Design bending moment (maximum) $M_{y,Ed}$	-1421,66	kNm
Maximum relative deflection δ_z	3,4	mm
Equivalent moment factor $C_{my,0}$	1,00	
Method for equivalent moment factor $C_{mz,0}$	Table A.2 Line 1 (Linear)	
Ratio of end moments ψ_z	0,95	
Equivalent moment factor $C_{mz,0}$	0,99	
Factor μ_z	1,00	
Factor μ_z	1,00	
Factor e_y	41,67	
Factor a_{LT}	0,99	
Critical moment for uniform bending $M_{cr,0}$	4102,50	kNm
Relative slenderness $\lambda_{rel,0}$	0,87	
Limit relative slenderness $\lambda_{rel,0,lim}$	0,35	
Equivalent moment factor C_{my}	1,00	
Equivalent moment factor C_{mz}	0,99	
Equivalent moment factor $C_{m,LT}$	1,00	
Factor b_{LT}	0,00	
Factor c_{LT}	0,65	
Factor d_{LT}	0,01	
Factor e_{LT}	1,84	
Factor w_y	1,15	
Factor w_z	1,50	
Factor η_{pl}	0,01	
Maximum relative slenderness $\lambda_{rel,max}$	0,72	
Factor C_{yy}	1,00	
Factor C_{yz}	0,68	
Factor C_{zy}	1,00	
Factor C_{zz}	0,99	

Unity check (6.61) = $0,01 + 0,46 + 0,00 = 0,47$ -

Unity check (6.62) = $0,01 + 0,24 + 0,00 = 0,26$ -

Shear Buckling check

According to EN 1993-1-5 article 5 & 7.1 and formula (5.10) & (7.1)

Shear Buckling parameters		
Buckling field length a	6,800	m
Web	unstiffened	
Web height h_w	540	mm
Web thickness t	21	mm
Material coefficient ε	0,81	
Shear correction factor η	1,20	

Shear Buckling verification	
Web slenderness h_w/t	25,71
Web slenderness limit	48,82

Note: The web slenderness is such that Shear Buckling effects may be ignored according to EN 1993-1-5 article 5.1(2).

The member satisfies the stability check.

4.13.11. REZNE SILE –STUP 6 POZ 500

N

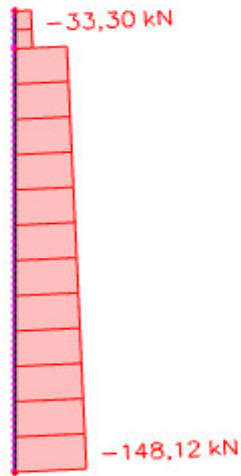

4.13.12. DIMENZIONIRANJE –STUP 6 POZ 500

EC-EN 1993 Steel check ULS

Linear calculation
Combination: GSN4
Coordinate system: Principal
Extreme ID: Member
Selection: 82580

EN 1993-1-1 Code Check

National annex: Standard EN

Member B2580 0,888 / 11,610 m HEM600 S 355 GSN4 0,87 -

Combination key
GSN4 / 1.35*vlastita težina + 1.50*pokretno +
1.35*dodatno stalno + 1.50*vjetar smjer x +
0.90*temperatura pozitivna

Partial safety factors

γ_{M0} for resistance of cross-sections	1,00
γ_{M1} for resistance to instability	1,00
γ_{M2} for resistance of net sections	1,25

Material

Yield strength f_y	355,0	MPa
Ultimate strength f_u	490,0	MPa
Fabrication	Rolled	

....:SECTION CHECK:....

The critical check is on position 0,888 m

Internal forces	Calculated	Unit
N_{Ed}	-144,76	kN
$V_{y,Ed}$	-1,78	kN
$V_{z,Ed}$	600,28	kN
T_{Ed}	0,40	kNm
$M_{y,Ed}$	485,76	kNm
$M_{z,Ed}$	9,67	kNm

Classification for cross-section design

Classification according to EN 1993-1-1 article 5.5.2

Classification of Internal and Outstand parts according to EN 1993-1-1 Table 5.2 Sheet 1 & 2

Id	Type	c [mm]	t [mm]	σ_1 [kN/m ²]	σ_2 [kN/m ²]	ψ [-]	k_{σ} [-]	α [-]	c/t [-]	Class 1 Limit [-]	Class 2 Limit [-]	Class 3 Limit [-]	Class
1	SO	115	40	-5,725e+04	-6,312e+04								
3	SO	115	40	-5,343e+04	-4,757e+04								
4	I	486	21	-4,573e+04	5,369e+04	-0,85		0,52	23,14	55,12	63,85	86,49	1
5	SO	115	40	6,521e+04	7,108e+04	0,92	0,44	1,00	2,87	7,32	8,14	11,29	1
7	SO	115	40	6,139e+04	5,553e+04	0,90	0,46	1,00	2,87	7,32	8,14	11,64	1

Note: The Classification limits have been set according to Semi-Comp+.
The cross-section is classified as Class 1

Compression check

According to EN 1993-1-1 article 6.2.4 and formula (6.9)

A	3,6370e-02	m ²
$N_{c,Rd}$	12911,35	kN
Unity check	0,01	-

Bending moment check for M_y

According to EN 1993-1-1 article 6.2.5 and formula (6.12),(6.13)

W_{ply}	8,7720e-03	m ³
$M_{ply,Rd}$	3114,06	kNm
Unity check	0,16	-

Bending moment check for M_z

According to EN 1993-1-1 article 6.2.5 and formula (6.12),(6.13)

W_{plz}	1,9300e-03	m ³
$M_{plz,Rd}$	685,15	kNm
Unity check	0,01	-

Shear check for V_y

According to EN 1993-1-1 article 6.2.6 and formula (6.17)

η	1,20	
A_v	2,5408e-02	m ²
$V_{ply,Rd}$	5207,61	kN
Unity check	0,00	-

Shear check for V_z

According to EN 1993-1-1 article 6.2.6 and formula (6.17)

η	1,20	
A_v	1,4970e-02	m ²
$V_{pl,z,Rd}$	3068,24	kN
Unity check	0,20	-

Torsion check

According to EN 1993-1-1 article 6.2.7 and formula (6.23)

Fibre	2	
T_{Ed}	1,0	MPa
T_{Rd}	205,0	MPa
Unity check	0,01	-

Note: The unity check for torsion is lower than the limit value of 0,05. Therefore torsion is considered as insignificant and is ignored in the combined checks.

Combined bending, axial force and shear force check

According to EN 1993-1-1 article 6.2.9.1 and formula (6.41)

$M_{pl,y,Rd}$	3114,06	kNm
α	2,00	
$M_{pl,z,Rd}$	685,15	kNm
β	1,00	

Unity check (6.41) = $0,02 + 0,01 = 0,04$ -

Note: Since the shear forces are less than half the plastic shear resistances their effect on the moment resistances is neglected.

Note: Since the axial force satisfies both criteria (6.33) and (6.34) of EN 1993-1-1 article 6.2.9.1(4) its effect on the moment resistance about the y-y axis is neglected.

Note: Since the axial force satisfies criteria (6.35) of EN 1993-1-1 article 6.2.9.1(4) its effect on the moment resistance about the z-z axis is neglected.

Decision tables for combined section check

Force presence	
Axial force N_{Ed}	Present
Shear force $V_{y,Ed}$	Not significant
Shear force $V_{z,Ed}$	Not significant
Torsional moment T_{Ed}	Not significant
Bending moment $M_{y,Ed}$	Present
Bending moment $M_{z,Ed}$	Present
Significant shear force without corresponding bending moment	No
Warping data	Not present or negligible

Check inputs	
Classification is supported	Yes
Section classification	Class 1
Elastic verification is set by the user	No
Plastic shear formula is available	Yes
Combined bending and axial force formula is available	Yes
Combined bending and axial force check can be calculated	Yes

Selected check

According to EN 1993-1-1 article 6.2.9.1 and formula (6.41)

The member satisfies the section check.

...:STABILITY CHECK:...:

Classification for member buckling design

Decisive position for stability classification: 4,442 m

Classification according to EN 1993-1-1 article 5.5.2

Classification of Internal and Outstand parts according to EN 1993-1-1 Table 5.2 Sheet 1 & 2

Id	Type	c [mm]	t [mm]	σ_1 [kN/m ²]	σ_2 [kN/m ²]	ψ [-]	k_σ [-]	α [-]	c/t [-]	Class 1 Limit [-]	Class 2 Limit [-]	Class 3 Limit [-]	Class [-]
1	SO	115	40	-1,984e+05	-2,004e+05								
3	SO	115	40	-1,971e+05	-1,950e+05								
4	I	486	21	-1,651e+05	1,723e+05	-0,96		0,52	23,14	55,42	64,18	96,45	1
5	SO	115	40	2,056e+05	2,076e+05	0,99	0,43	1,00	2,87	7,32	8,14	11,21	1
7	SO	115	40	2,043e+05	2,023e+05	0,99	0,43	1,00	2,87	7,32	8,14	11,26	1

Note: The Classification limits have been set according to Semi-Comp+.

The cross-section is classified as Class 1

Flexural Buckling check

According to EN 1993-1-1 article 6.3.1.1 and formula (6.46)

Buckling parameters	yy	zz	
Sway type	sway	non-sway	
System length L	10,660	11,610	m
Buckling factor k	1,49	0,57	
Buckling length L_{cr}	15,836	6,660	m

Buckling parameters	yy	zz	
Critical Euler load N_{cr}	19668,91	8877,24	kN
Slenderness λ	61,91	92,15	
Relative slenderness λ_{rel}	0,81	1,21	
Limit slenderness $\lambda_{rel,0}$	0,20	0,20	

Note: The slenderness or compression force is such that Flexural Buckling effects may be ignored according to EN 1993-1-1 article 6.3.1.2(4).

Torsional(-Flexural) Buckling check

According to EN 1993-1-1 article 6.3.1.1 and formula (6.46)

Note: For this I-section the Torsional(-Flexural) buckling resistance is higher than the resistance for Flexural buckling. Therefore Torsional(-Flexural) buckling is not printed on the output.

Lateral Torsional Buckling check

According to EN 1993-1-1 article 6.3.2.1 & 6.3.2.3 and formula (6.54)

LTB parameters		
Method for LTB curve	Alternative case	
Plastic section modulus $W_{pl,y}$	8,7720e-03	m ³
Elastic critical moment M_{cr}	2829,24	kNm
Relative slenderness $\lambda_{rel,LT}$	1,05	
Limit slenderness $\lambda_{rel,LT,0}$	0,40	
LTB curve	c	
Imperfection α_{LT}	0,49	
LTB factor β	0,75	
Reduction factor χ_{LT}	0,61	
Correction factor k_c	0,86	
Correction factor f	0,94	
Modified reduction factor $\chi_{LT,mod}$	0,65	
Design buckling resistance $M_{b,Rd}$	2021,22	kNm
Unity check	0,24	-

Mcr parameters		
LTB length L	11,610	m
Influence of load position	no influence	
Correction factor k	1,00	
Correction factor k_{sw}	1,00	
LTB moment factor C_1	1,35	
LTB moment factor C_2	0,63	
LTB moment factor C_3	0,41	
Shear center distance d_x	0	mm
Distance of load application z_0	0	mm
Mono-symmetry constant β_y	0	mm
Mono-symmetry constant z_j	0	mm

Note: C parameters are determined according to ECCS 119 2006 / Galea 2002.

Note: The correction factor k_c is determined from C_1 .

TABLE 110. ADDITIONAL DESIGN BEAM PARAMETERS (EN 1993-1-1)

LTB additional parameters		
Minimal z coordinate Z_{min}	-310	mm
Maximal z coordinate Z_{max}	310	mm
End moment ratio ψ	0,79	
Equivalent point load F	602,22	kN
Equivalent line load q	103,74	kN/m
Difference with M	13972,65	kNm
Difference with F	5492,57	kNm
Difference with q	5619,82	kNm
Resulting load type	point load F	

Bending and axial compression check

According to EN 1993-1-1 article 6.3.3 and formula (6.61),(6.62)

Bending and axial compression check parameters		
Interaction method	alternative method 1	
Cross-section area A	3,6370e-02	m ²
Plastic section modulus $W_{pl,y}$	8,7720e-03	m ³
Plastic section modulus $W_{pl,z}$	1,9300e-03	m ³
Design compression force N_{Ed}	144,76	kN
Design bending moment (maximum) $M_{y,Ed}$	1648,59	kNm
Design bending moment (maximum) $M_{z,Ed}$	11,26	kNm
Characteristic compression resistance N_{Rk}	12911,35	kN
Characteristic moment resistance $M_{y,Rk}$	3114,06	kNm
Characteristic moment resistance $M_{z,Rk}$	685,15	kNm
Reduction factor χ_y	1,00	
Reduction factor χ_z	1,00	
Modified reduction factor $\chi_{LT,mod}$	0,65	
Interaction factor k_{yy}	1,02	
Interaction factor k_{yz}	1,56	
Interaction factor k_{zy}	0,54	
Interaction factor k_{zz}	1,01	

Maximum moment $M_{y,Ed}$ is derived from beam B2580 position 4,442 m.

Maximum moment $M_{z,Ed}$ is derived from beam B2580 position 0,000 m.

Interaction method 1 parameters		
Critical Euler load $N_{cr,y}$	19668,91	kN
Critical Euler load $N_{cr,z}$	8877,24	kN
Elastic critical load $N_{cr,T}$	21338,46	kN
Plastic section modulus $W_{pl,y}$	8,7720e-03	m ³
Elastic section modulus $W_{el,y}$	7,6600e-03	m ³
Plastic section modulus $W_{pl,z}$	1,9300e-03	m ³
Elastic section modulus $W_{el,z}$	1,2440e-03	m ³
Second moment of area I_y	2,3800e-03	m ⁴
Second moment of area I_z	1,9000e-04	m ⁴
Torsional constant I_t	1,5640e-05	m ⁴
Method for equivalent moment factor $C_{my,0}$	Table A.2 Line 2 (General)	
Design bending moment (maximum) $M_{y,Ed}$	1648,59	kNm
Maximum relative deflection δ_z	-38,2	mm
Equivalent moment factor $C_{my,0}$	1,00	
Method for equivalent moment factor $C_{mz,0}$	Table A.2 Line 2 (General)	
Design bending moment (maximum) $M_{z,Ed}$	11,26	kNm
Maximum relative deflection δ_y	-0,8	mm
Equivalent moment factor $C_{mz,0}$	0,99	
Factor μ_y	1,00	
Factor μ_z	1,00	
Factor ϵ_y	54,07	
Factor a_{LT}	0,99	
Critical moment for uniform bending $M_{cr,0}$	2098,85	kNm
Relative slenderness $\lambda_{rel,0}$	1,22	
Limit relative slenderness $\lambda_{rel,0,lim}$	0,23	
Equivalent moment factor C_{my}	1,00	
Equivalent moment factor C_{mz}	0,99	
Equivalent moment factor C_{mLT}	1,01	
Factor b_{LT}	0,01	
Factor c_{LT}	1,69	
Factor d_{LT}	0,01	
Factor e_{LT}	0,76	
Factor w_y	1,15	
Factor w_z	1,50	
Factor η_{pl}	0,01	
Maximum relative slenderness $\lambda_{rel,max}$	1,21	
Factor C_{yy}	1,00	
Factor C_{yz}	0,44	
Factor C_{zy}	0,98	
Factor C_{zz}	0,99	

Unity check (6.61) = 0,01 + 0,83 + 0,03 = 0,87 -

Unity check (6.62) = 0,01 + 0,44 + 0,02 = 0,47 -

Shear Buckling check

According to EN 1993-1-5 article 5 & 7.1 and formula (5.10) & (7.1)

Shear Buckling parameters		
Buckling field length a	11,610	m
Web	unstiffened	
Web height h_w	540	mm
Web thickness t	21	mm
Material coefficient ε	0,81	
Shear correction factor η	1,20	

Shear Buckling verification	
Web slenderness h_w/t	25,71
Web slenderness limit	48,82

Note: The web slenderness is such that Shear Buckling effects may be ignored according to EN 1993-1-5 article 5.1(2).

The member satisfies the stability check.

5. NUMERIČKA ANALIZA

Računsko ubrzanje tla očitano je sa Seizmičke karte Republike Hrvatske i iznosi: $a_g = 0,22 g$. Klasificiranjem vrste temeljnog tla utvrđeno je da se građevina nalazi na tlu klasa A koja se odnosi na stijenu ili drugu geološku formaciju s najviše 5 m slabijeg tla pri površini i krute naslage pijeska, šljunka ili prekonsolidirane gline. Za proračun seizmičkog opterećenja korištena je višemodalna spektralna analiza. Konstrukcija je praručanata u dva međusobno okomita horizontalna pravca. Odgovor konstrukcije dobiven je metodom spektra odgovora.

- Seizmičko područje: IX zona
- Računsko ubrzanje tla: $a_g = 0,22g$, $g = 9,81 \text{ m/s}^2$
- Srednja kategorija duktilnosti DC“M“ (konstrukcije posebno otporne na potres, ne dolazi do krhkog loma pod cikličkim djelovanjem sila potresa u području plastičnih zglobova)
- Kategorija tla: A
- Faktor značaja: $\gamma = 1.0$ (obične zgrade, stambene)

5.1. MODALNA ANALIZA

Calculation protocol

Solution of Free vibration

Number of 2D elements	0
Number of 1D elements	4218
Number of mesh nodes	2463
Number of equations	14778
Combination of mass groups	MC1 CM1
Number of frequencies	10
Method	Lanczos
Bending theory	Mindlin
Type of analysis model	Standard
Start of calculation	17.09.2018 13:32
End of calculation	17.09.2018 13:33

Sum of masses

	X [kg]	Y [kg]	Z [kg]
1	282100,4	282100,4	282100,4

Relative modal masses

Mode	mega [rad/s]	Period [s]	Freq. [Hz]	W_{xi}/W_{xtot}	W_{yi}/W_{ytot}	W_{zi}/W_{ztot}	W_{xi_R}/W_{xtot_R}	W_{yi_R}/W_{ytot_R}	W_{zi_R}/W_{ztot_R}
1	11.6204	0,54	1,85	0.000128634	6.58022e-05	0.00452433	0.00022671	8.48131e-05	3.61454e-05
2	20.3211	0,31	3,23	0.00175236	0	0	0	0.000179356	0.00203385
3	21.432	0,29	3,41	5.10318e-05	9.79014e-06	0.00456088	0.00132795	0.00243716	5.89382e-05
4	21.8509	0,29	3,48	0	0.0105614	1.85825e-08	0.0124024	0	0.00354438
5	21.9878	0,29	3,50	5.11313e-06	0.0484006	3.14125e-06	0.0769113	7.20727e-06	0.000140632
6	22.5267	0,28	3,59	0.000281663	0.00784182	0.001213	0.00187024	9.61992e-05	0.00392322
7	23.8316	0,26	3,79	9.22229e-05	0.000764069	0.0056412	0.000175173	0.00119497	0.000157219
8	24.9996	0,25	3,98	1.33226e-06	0.00267501	0	0.00309562	1.222e-06	3.28837e-05
9	25.1418	0,25	4,00	9.68727e-07	0.00672817	4.05888e-08	1.2691e-06	2.134e-07	0.000593911
10	27.6247	0,23	4,40	0.000270492	0.0057651	0.00124288	0.00536139	8.20703e-05	0.00165768
				0.00258381	0.0828117	0.0171855	0.101372	0.00408321	0.0121788

Seismicity

Number of 2D elements	0
Number of 1D elements	4218
Number of mesh nodes	2463
Mass in analysis	Participating mass only
Signed results	X
Load case	potres
Combination of mass groups	CM1
Bending theory	Mindlin
Type of analysis model	Standard
Start of calculation	17.09.2018 13:32
End of calculation	17.09.2018 13:33

Potresno djelovanje u obzir treba uzeti kod konstrukcije koja je položena u seizmički aktivnom području i pri tome u obzir treba uzeti opterećenje čiji je uzrok seizmičko podrhtavanje tla.

Lokacija ove konstrukcije nalazi se u seizmički aktivnom području ($a = 0.22 \cdot g$), no specifičan odabira materijala, čelik, rezultira malom masom konstrukcije, stoga je i potresno opterećenje relativno malo s obzirom na opterećenje vjetrom koje je dominantno djelovanje. Iz navedenog se može zaključiti da potresno opterećenje u ovom slučaju nije potrebno detaljnije razmatrati te da ga je moguće zanemariti.

6. PRORAČUN PRIKLJUČAKA

6.1. PRIKLJUČAK STUP-GREDA

Greda: HEA 220

Stup: HEM 600

$N = 358,07 \text{ kN}$ (tlak)

$V = 187,01 \text{ kN}$

1) Osnovni materijal:

Čelik S355

$$f_y = 355 \text{ N/mm}^2$$

$$E = 210 \text{ GPa}$$

2) Kontrola vara-za DP

- dužina vara pojasnice:

$$l_p = 4 \cdot b = 4 \cdot 220 = 880 \text{ (mm)}$$

- max debljina vara s obzirom na debljinu stijenke nosača

$$a_{\max} = 0,7 \cdot t_{\min}$$

$$t_{\min} = 6,5 \text{ (mm)}$$

$$\Rightarrow a_{\max} = 0,7 \cdot t_{\min} = 0,7 \cdot 6,5 = 4,55 \text{ (mm)}$$

$$a_{\text{odabrano}} = 4 \text{ (mm)}$$

Za pretpostavljeni var $a=4$ (mm):

$$\text{- uzdužna sila: } F_{w,Rd} = \frac{F_{w,Rk}}{1,25} \cdot \frac{L}{100} = \frac{130,9}{1,25} \cdot \frac{880}{100} = 628,32 \text{ (kN)}$$

uvjet nosivosti:

$$N = F_{w,Sd} \leq F_{w,Rd}$$

$$358,07 \text{ (kN)} \leq 628,32 \text{ (kN)}$$

$$\text{- poprečna sila: } F_{w,Rd} = \frac{F_{w,Rk}}{1,25} \cdot \frac{L}{100} = \frac{130,9}{1,25} \cdot \frac{880}{100} = 628,32 \text{ (kN)}$$

uvjet nosivosti:

$$N_p = F_{w,Sd} \leq F_{w,Rd}$$

$$187,01 \text{ (kN)} \leq 628,32 \text{ (kN)}$$

-otpornost vara na rezultantu

$$F_{w,Rd} > \sqrt{358,07^2 + 187,01^2} = 403,96 \text{ kN}$$

Var $a=4$ mm zadovoljava

3) Kontrola vara-STUP

Kontrola vara na pojasnicama i hrptu stupa

- dužina vara pojasnice:

$$l_p = 4 \cdot b = 4 \cdot 305 = 1220 \text{ (mm)}$$

-duljina vara pojasnice

$$a_{\max} = 0,7 \cdot t_{\min}$$

$$t_{\min} = t_w = 21,0 \text{ [mm]}$$

$$\Rightarrow a_{\max} = 0,7 \cdot 21 = 14,7 \text{ [mm]}$$

$$a_{\text{odabrano}} = 4,0 \text{ [mm]}$$

- uzdužna sila: $F_{w,Rd} = \frac{F_{w,Rk}}{1,25} \cdot \frac{L}{100} = \frac{196,3}{1,25} \cdot \frac{1220}{100} = 1915,89 \text{ (kN)}$

uvjet nosivosti:

$$N = F_{w,Sd} \leq F_{w,Rd}$$

$$358,07 \text{ (kN)} \leq 1915,89 \text{ (kN)}$$

- poprečna sila:

uvjet nosivosti: $F_{w,Rd} = \frac{F_{w,Rk}}{1,25} \cdot \frac{L}{100} = \frac{196,3}{1,25} \cdot \frac{1220}{100} = 1915,89 \text{ (kN)}$

$$N_p = F_{w,Sd} \leq F_{w,Rd}$$

$$187,01 \text{ (kN)} \leq 1915,89 \text{ (kN)}$$

Var a=4mm zadovoljava

4) Proračun vijaka

Pretpostavljeni vijci: M 20, k.v.10.9, n=8 vijka

- udaljenost c_{\min} vijaka od ruba pojasnice:

$$c_{\min} = 2 \cdot d + a \cdot \sqrt{2} = 2 \cdot 20 + 4 \cdot \sqrt{2} = 49 \text{ (mm)}$$

Usvojeno $c=55$ mm.

- otpornost vijaka na vlak:

$$F_{t,Rd} = \frac{F_{t,Rk}}{\gamma_{M1}} = \frac{220,5}{1,25} = 176,40 \text{ (kN)}$$

uvjet nosivosti

$$F_{t,Rd} > F_{t,Sd} / 4$$

uvjet nosivosti

$$F_{t,Rd} > F_{t,Sd} / 8$$

$$176,40 \text{ kN} > 358,07 / 8 = 44,76 \text{ (kN)}$$

- otpornost vijaka na posmik:

$$F_{v,Rd} = \frac{F_{v,Rk}}{\gamma_{M1}} = \frac{122,5}{1,25} = 98,0 \text{ (kN)}$$

uvjet nosivosti

$$F_{v,Rd} > F_{v,Sd}$$

$$98,0 \text{ kN} > F_{v,Sd} = V_{Sd} / 4 = 187,01 / 4 = 46,75 \text{ (kN)}$$

- interakcija uzdužne i odrezne sile na vijak:

$$\frac{F_{V,Sd}}{F_{V,Rd}} + \frac{F_{t,Sd}}{1,4 \cdot F_{t,Rd}} \leq 1$$
$$\frac{46,75}{98,0} + \frac{89,52}{1,4 \cdot 176,40} = 0,84 \leq 1$$

→ Vijci zadovoljavaju.

5) Proračun ploče

- proračun dimenzija ploče:

$$a_{pl,min} = h + 2 \cdot (c + e_1) = 160 + 2 \cdot (55 + 55) = 380 \text{ mm}$$

$$b_{pl,min} = b + 2 \cdot a \cdot \sqrt{2} + 20 \text{ mm} = 160 + 2 \cdot 4 \cdot \sqrt{2} + 20 = 192 \text{ (mm)}$$

Odabrane dimenzije ploče: 400x300 mm

6.1.1. SAVIJANJE PLOČE OD VLAČNIH VIJAKA

$$M_{sd} = 2 \cdot F_{t,sd} \cdot e = 2 \cdot 308,07 \cdot 0,040 = 28,65 \text{ kNm}$$

$$M_{sd} \leq \frac{W_{min} \cdot f_y}{1.1} \Rightarrow W_{min} = \frac{1.1 \cdot M_{sd}}{f_y} = \frac{b_{pl} \cdot t_{pl}^2}{6} \Rightarrow t_{pl}^{min} = \sqrt{\frac{1.1 \cdot M_{sd} \cdot 6}{b_{pl} \cdot f_y}} = \sqrt{\frac{1.1 \cdot 2865 \cdot 6}{30 \cdot 35.5}} = 4,21 \text{ cm}$$

$$t_{pl} = 4,21 \text{ cm}$$

Usvojene dimenzije ploče su **450x300x42 cm**; vijci **M20**, k.v. **10.9.**, n=8

6.2. PRORAČUN SPOJA STUP-TEMELJ

$N_{Ed} = -401,68 \text{ (kN)}$ (tlak)

$M_{Ed} = 84,51 \text{ (kNm)}$

$V_{Ed} = 36,57 \text{ (kN)}$

Materijal:

-osnovni materijal Fe 510 (S355)

-vijci k.v.10.9

HEM600

h=620 (mm)

b=305 (mm)

t_f=40 (mm)

t_w=21 (mm)

A=363,7 (cm²)

r=27 (mm)

Pojasnice

A=363,7 (cm²)

Vlačna sila u pojasu uslijed momenta:

$$N_p^M = \frac{M_{sd}}{(h - t_f)} = \frac{84,51}{(0,62 - 0,040)} = 145,71 \text{ (kN)}$$

Tlačna sila u pojasu od uzdužne sile:

$$N_p^N = \frac{A_p}{A} \cdot N_{sd} = \frac{30,5 \cdot 4}{363,7} \cdot (-401,68) = -134,74 \text{ (kN)}$$

Ukupna sila u vlačnoj pojasnici:

$$N_p = N_p^M + N_p^N = 145,71 + 134,74 = 280,45 \text{ (kN)}$$

6.2.1. IZRAČUN VARA

Kontrola vara na pojasnicama i hrptu

- dužina vara pojasnice:

$$l_p = 2 \cdot b = 2 \cdot 305 = 610 \text{ (mm)}$$

- duljina vara hrpta

$$l_h = 2 \cdot d = 2 \cdot 486 = 972 \text{ (mm)}$$

- max debljina vara s obzirom na debljinu hrpta i pojaseva nosača

$$a_{\max} = 0.7 \cdot t_{\min}$$

$$t_{\min} = t_w = 21 \text{ (mm)}$$

$$\Rightarrow a_{\max} = 0.7 \cdot t_{\min} = 0.7 \cdot 21 = 14,7 \text{ (mm)}$$

$$a_{\text{odabrano}} = 8 \text{ (mm)}$$

$$\Rightarrow F_{w,Rk} = 207,8 \text{ (kN)}$$

Za pretpostavljeni var $a=8$ (mm):

- uzdužna sila:

$$F_{w,Rd} = \frac{F_{w,Rk}}{1.25} \cdot \frac{L}{100} = \frac{207,8}{1.25} \cdot \frac{610}{100} = 997,44 \text{ (kN)}$$

uvjet nosivosti:

$$N_p = F_{w,Sd} \leq F_{w,Rd}$$

$$280,45 \text{ (kN)} < 997,44 \text{ (kN)}$$

- poprečna sila:

$$F_{w,Rd} = \frac{F_{w,Rk}}{1.25} \cdot \frac{L}{100} = \frac{207,8}{1.25} \cdot \frac{972}{100} = 1456,26 \text{ (kN)}$$

uvjet nosivosti:

$$N_p = F_{w,Sd} \leq F_{w,Rd}$$

$$36,57 \text{ (kN)} < 1456,26 \text{ (kN)}$$

→ Varovi zadovoljavaju.

6.2.2. PRORAČUN VIJAKA

Pretpostavljeni vijci: **M 27, k.v.8.8**, broj vijaka **n=8**.

- udaljenost c_{\min} vijaka od ruba pojasnice:

$$c_{\min} = 2 \cdot d + a \cdot \sqrt{2} = 2 \cdot 27 + 8 \cdot \sqrt{2} = 65,3 \text{ (mm)}$$

Usvojeno $c=66$ mm.

- ekscentricitet uzdužne sile:

$$e = \frac{M_{Sd}}{N_{Sd}} = \frac{84,51}{401,68} = 0,21 \text{ (m)}$$

$$x_1 = h - t_f / 2 = 620 - 40 / 2 = 600 \text{ (mm)} = 0,6 \text{ (m)}$$

$$x_2 = e - h / 2 + t_f / 2 = 210 - 620 / 2 + 40 / 2 = 80 \text{ (mm)} = 0,08 \text{ (m)}$$

$$N_{Sd} \cdot x_2 = F_{t,Sd} \cdot x_1$$

$$\Rightarrow F_{t,Sd} = N_{Sd} \cdot \frac{x_2}{x_1} = 401,68 \cdot \frac{80}{600} = 53,56 \text{ (kN)}$$

- otpornost vijaka na vlak:

$$F_{t,Rd} = \frac{F_{t,Rk}}{\gamma_{M1}} = \frac{33,5}{1,25} = 264,4 \text{ (kN)}$$

uvjet nosivosti

$$F_{t,Rd} > F_{t,Sd} / 4$$

$$264,4 \text{ kN} > 53,56 / 4 = 13,39 \text{ (kN)}$$

- otpornost vijaka na posmik:

$$F_{v,Rd} = \frac{F_{v,Rk}}{\gamma_{M1}} = \frac{220,3}{1,25} = 176,24 \text{ (kN)}$$

uvjet nosivosti

$$F_{v,Rd} > F_{v,Sd}$$

$$176,24 \text{ kN} > F_{v,Sd} = V_{Sd} / 8 = 36,57 / 8 = 4,57 \text{ (kN)}$$

- interakcija uzdužne i odrezne sile na vijak:

$$\frac{F_{v,Sd}}{F_{v,Rd}} + \frac{F_{t,Sd}}{1,4 \cdot F_{t,Rd}} \leq 1$$

$$\frac{4,57}{176,24} + \frac{13,39}{1,4 \cdot 264,4} = 0,06 \leq 1$$

→ Vijci zadovoljavaju.

6.2.3. PRORAČUN PLOČE

- proračun dimenzija ploče:

$$a_{pl,min} = h + 2 \cdot (c + e_1)$$

$$e_1 = 70 \text{ (mm)}$$

$$\Rightarrow a_{pl,min} = 540 + 2 \cdot (66 + 70) = 812 \text{ (mm)}$$

$$b_{pl,min} = 3 \cdot p_2 + 2 \cdot e_2$$

$$p_1; p_2 = 90 \text{ (mm)}$$

$$e_2 = 55 \text{ (mm)}$$

$$\Rightarrow b_{pl,min} = 3 \cdot 90 + 2 \cdot 55 = 380 \text{ (mm)}$$

Odabrane dimenzije ploče: 820x440 mm

- pritisak po omotaču rupe osnovnog materijala:

$$F_{V,Sd} = \frac{V_{Sd}}{16} = \frac{36,57}{8} = 4,57 \text{ (kN)} \equiv F_{b,Sd}$$

$$F_{b,Rd} = \frac{F_{b,Rk}}{1,25} \cdot \frac{t_{pl}}{10} = \frac{136,4}{1,25} \cdot \frac{t_{pl}}{10} = F_{b,Sd} = 11,19 \text{ (kN)}$$

$$\Rightarrow t_{pl}^{\min} = \frac{4,57 \cdot 1,25 \cdot 10}{258,2} = 0,22 \text{ (mm)}$$

- savijanje ploče od odgovora betonske podloge:

$$s = (a_{pl} - h + t_f^{\min}) / 2 = (820 - 620 + 40) / 2 = 120 \text{ (mm)} = 12 \text{ (cm)}$$

$$R = F_{t,Sd} - N_{Sd} = 13,39 + 401,68 = 415,07 \text{ (kN)}$$

- naprezanje u betonu:

$$f_{B,Sd} = \frac{R}{\frac{3 \cdot s \cdot b_{pl}}{2}} = \frac{415,07}{\frac{3 \cdot 12 \cdot 44}{2}} = 0,52 \text{ (kN / cm}^2\text{)}$$

uvjet nosivosti

$$f_{B,Sd} < f_{ck} / 1,5$$

$$0,52 \text{ kN / cm}^2 < 1,4 / 1,5 = 0,93 \text{ (kN / cm}^2\text{)}$$

- savijanje ploče:

$$M_{Sd} = F_1 \cdot \frac{s}{2} + F_2 \cdot \frac{2}{3} \cdot s = \frac{2}{3} \cdot f_{B,Sd} \cdot s \cdot b_{pl} \cdot \frac{s}{2} + \frac{1}{3} \cdot f_{B,Sd} \cdot s \cdot b_{pl} \cdot \frac{2}{3} \cdot s$$

$$\Rightarrow M_{Sd} = \frac{2}{3} \cdot 5200 \cdot 0,12 \cdot 0,44 \cdot \frac{0,12}{2} + \frac{1}{3} \cdot 5200 \cdot 0,12 \cdot 0,44 \cdot \frac{2}{3} \cdot 0,12 = 21,96 \text{ (kNm)}$$

- savijanje ploče oko vlačnih vijaka:

$$M_{Sd} = F_{t,Sd} \cdot (c + t_f / 2)$$

$$\Rightarrow M_{Sd} = 53,56 \cdot (0,066 + 0,2m) = 14,25 \text{ [kNm]}$$

$$M_{Sd} \leq \frac{W_{\min} \cdot f_y}{1,1} \Rightarrow W_{\min} = \frac{1,1 \cdot M_{Sd}}{f_y} = \frac{b_{pl} \cdot t_{pl}^{\min 2}}{6}$$

$$t_{pl}^{\min} = \sqrt{\frac{1,1 \cdot M_{Sd} \cdot 6}{b_{pl} \cdot f_y}} = \sqrt{\frac{1,1 \cdot 14,25 \cdot 100 \cdot 6}{44 \cdot 35,5}} = 2,45 \text{ (cm)}$$

$$t_{pl} \geq 2,45 \text{ (cm)}$$

Usvojene dimenzije ploče: 820x440x40 mm

6.3. VLAČNI NASTAVAK REŠETKE – GORNJI POJAS

N=296,33kN(vlak)

h = 200 mm b = 200 mm t = 10mm

1) Osnovni materijal:

$$f_y = 355 \text{ N/mm}^2$$

$$E = 210 \text{ GPa}$$

2) Kontrola vara

- dužina vara pojasnice:

$$l_p = 4 \cdot b = 4 \cdot 200 = 800 \text{ (mm)}$$

- max debljina vara s obzirom na debljinu stijenke nosača

$$a_{\max} = 0,7 \cdot t_{\min}$$

$$t_{\min} = 10 \text{ (mm)}$$

$$\Rightarrow a_{\max} = 0,7 \cdot t_{\min} = 0,7 \cdot 10 = 7 \text{ (mm)}$$

$$a_{\text{odabrano}} = 5 \text{ (mm)}$$

Za pretpostavljeni var $a=5$ (mm):

$$\text{- uzdužna sila: } F_{w,Rd} = \frac{F_{w,Rk}}{1,25} \cdot \frac{L}{100} = \frac{163,6}{1,25} \cdot \frac{800}{100} = 1047,04 \text{ (kN)}$$

uvjet nosivosti:

$$N = F_{w,Sd} \leq F_{w,Rd}$$

$$296,33 \text{ (kN)} \leq 1047,04 \text{ (kN)}$$

Var $a=5$ mm zadovoljava

3) Proračun vijaka

Pretpostavljeni vijci: M 20, k.v.10.9, $n=4$ vijka

- udaljenost c_{\min} vijaka od ruba pojasnice:

$$c_{\min} = 2 \cdot d + a \cdot \sqrt{2} = 2 \cdot 20 + 3 \cdot \sqrt{2} = 45,66 \text{ (mm)}$$

Usvojeno $c=50$ mm.

- otpornost vijaka na vlak:

$$F_{t,Rd} = \frac{F_{t,Rk}}{\gamma_{M1}} = \frac{220,5}{1,25} = 176,4 \text{ (kN)}$$

uvjet nosivosti

$$F_{t,Rd} > F_{t,Sd} / 4$$

$$176,4 \text{ kN} > 296,33 / 4 = 74,08 \text{ (kN)}$$

→ Vijci zadovoljavaju.

4) Proračun ploče

- proračun dimenzija ploče:

$$a_{pl,\min} = h + 2 \cdot (c + e_1)$$

$$\Rightarrow a_{pl,\min} = 200 + 2 \cdot (50 + 50) = 400 \text{ (mm)}$$

$$b_{pl,\min} = b + 2 \cdot a \cdot \sqrt{2} + 20 \text{ mm} = 200 + 2 \cdot 3 \cdot \sqrt{2} + 20 = 208,48 \text{ (mm)}$$

Odabrane dimenzije ploče: 400x250 mm

Proračun debljine ploče:

- savijanje ploče od vlačnih vijaka:

$$M_{Sd} = F_{t,Sd} \cdot c = 74,08 \cdot 2 \cdot 50 = 7,41 \text{ (kNm)}$$

$$M_{Sd} \leq \frac{W_{min} \cdot f_y}{1,1} \Rightarrow W_{min} = \frac{1,1 \cdot M_{Sd}}{f_y} = \frac{b_{pl} \cdot t_{pl}^{\min}}{6}$$

$$t_{pl}^{\min} = \sqrt{\frac{1,1 \cdot M_{Sd} \cdot 6}{b_{pl} \cdot f_y}} = \sqrt{\frac{1,1 \cdot 7,41 \cdot 100 \cdot 6}{25 \cdot 35,5}} = 2,39 \text{ (cm)}$$

Usvojene dimenzije ploče: 400x250x25 mm

6.4. VLAČNI NASTAVAK REŠETKE – DONJI POJAS

$N=239,20\text{kN}$ (vlak)

$h = 200 \text{ mm}$ $b = 200 \text{ mm}$ $t = 8 \text{ mm}$

1) Osnovni materijal:

$$f_y = 355 \text{ N/mm}^2$$

$$E = 210 \text{ GPa}$$

2) Kontrola vara

- dužina vara pojasnice:

$$l_p = 4 \cdot b = 4 \cdot 200 = 800 \text{ (mm)}$$

- max debljina vara s obzirom na debljinu stijenke nosača

$$a_{\max} = 0,7 \cdot t_{\min}$$

$$t_{\min} = 8 \text{ (mm)}$$

$$\Rightarrow a_{\max} = 0,7 \cdot t_{\min} = 0,7 \cdot 8 = 5,6 \text{ (mm)}$$

$$a_{\text{odabrano}} = 5 \text{ (mm)}$$

Za pretpostavljeni var $a=5$ (mm):

$$\text{- uzdužna sila: } F_{w,Rd} = \frac{F_{w,Rk}}{1,25} \cdot \frac{L}{100} = \frac{163,6}{1,25} \cdot \frac{800}{100} = 1047,04 \text{ (kN)}$$

uvjet nosivosti:

$$N = F_{w,Sd} \leq F_{w,Rd}$$

$$239,20 \text{ (kN)} \leq 1047,04 \text{ (kN)}$$

Var $a=5$ mm zadovoljava

3) Proračun vijaka

Pretpostavljeni vijci: M 20, k.v.10.9, $n=4$ vijka

- udaljenost c_{\min} vijaka od ruba pojasnice:

$$c_{\min} = 2 \cdot d + a \cdot \sqrt{2} = 2 \cdot 20 + 3 \cdot \sqrt{2} = 45,66 \text{ (mm)}$$

Usvojeno $c=50$ mm.

- otpornost vijaka na vlak:

$$F_{t,Rd} = \frac{F_{t,Rk}}{\gamma_{M1}} = \frac{220,5}{1,25} = 176,4 \text{ (kN)}$$

uvjet nosivosti

$$F_{t,Rd} > F_{t,Sd} / 4$$

$$176,4 \text{ kN} > 239,20 / 4 = 59,8 \text{ (kN)}$$

→ Vijci zadovoljavaju.

4) Proračun ploče

- proračun dimenzija ploče:

$$a_{pl,\min} = h + 2 \cdot (c + e_1)$$

$$\Rightarrow a_{pl,\min} = 200 + 2 \cdot (50 + 50) = 400 \text{ (mm)}$$

$$b_{pl,\min} = b + 2 \cdot a \cdot \sqrt{2} + 20 \text{ mm} = 200 + 2 \cdot 3 \cdot \sqrt{2} + 20 = 208,48 \text{ (mm)}$$

Odabrane dimenzije ploče: 400x250 mm

Proračun debljine ploče:

- savijanje ploče od vlačnih vijaka:

$$M_{Sd} = F_{t,Sd} \cdot c = 59,8 \cdot 2 \cdot 50 = 5,98 \text{ (kNm)}$$

$$M_{Sd} \leq \frac{W_{\min} \cdot f_y}{1,1} \Rightarrow W_{\min} = \frac{1,1 \cdot M_{Sd}}{f_y} = \frac{b_{pl} \cdot t_{pl}^{\min}}{6}$$

$$t_{pl}^{\min} = \sqrt{\frac{1,1 \cdot M_{Sd} \cdot 6}{b_{pl} \cdot f_y}} = \sqrt{\frac{1,1 \cdot 5,98 \cdot 100 \cdot 6}{25 \cdot 35,5}} = 2,12 \text{ (cm)}$$

Usvojene dimenzije ploče: 400x250x25 mm

7.ISKAZ MATERIJALA

ISKAZ MATERIJALA		
Ukupna masa(kg)	Tlocrtna površina (m ²)	Broj etaža (n)
285853,83 kg	406,36 m ²	7
Ukupno:		4924,15 kg

8.LITERATURA

- [1] Androić, Dujmović, Džeba, Metalne konstrukcije 1, IGH Zagreb, 1994.
- [2] Androić, Dujmović, Džeba, Metalne konstrukcije 2; IA Projektiranje Zagreb, 1995.
- [3] Androić, Dujmović, Džeba, Metalne konstrukcije 3, IA Projektiranje, Zagreb, 1995.
- [4] Androić, Dujmović, Lukačević, Projektiranje spregnutih konstrukcija prema Eurocode 4, IA Projektiranje, Zagreb, 2012

9.NACRTI

GENERALNI PLAN POZICIJA 700 - KROVNA KONSTRUKCIJA M 1:100

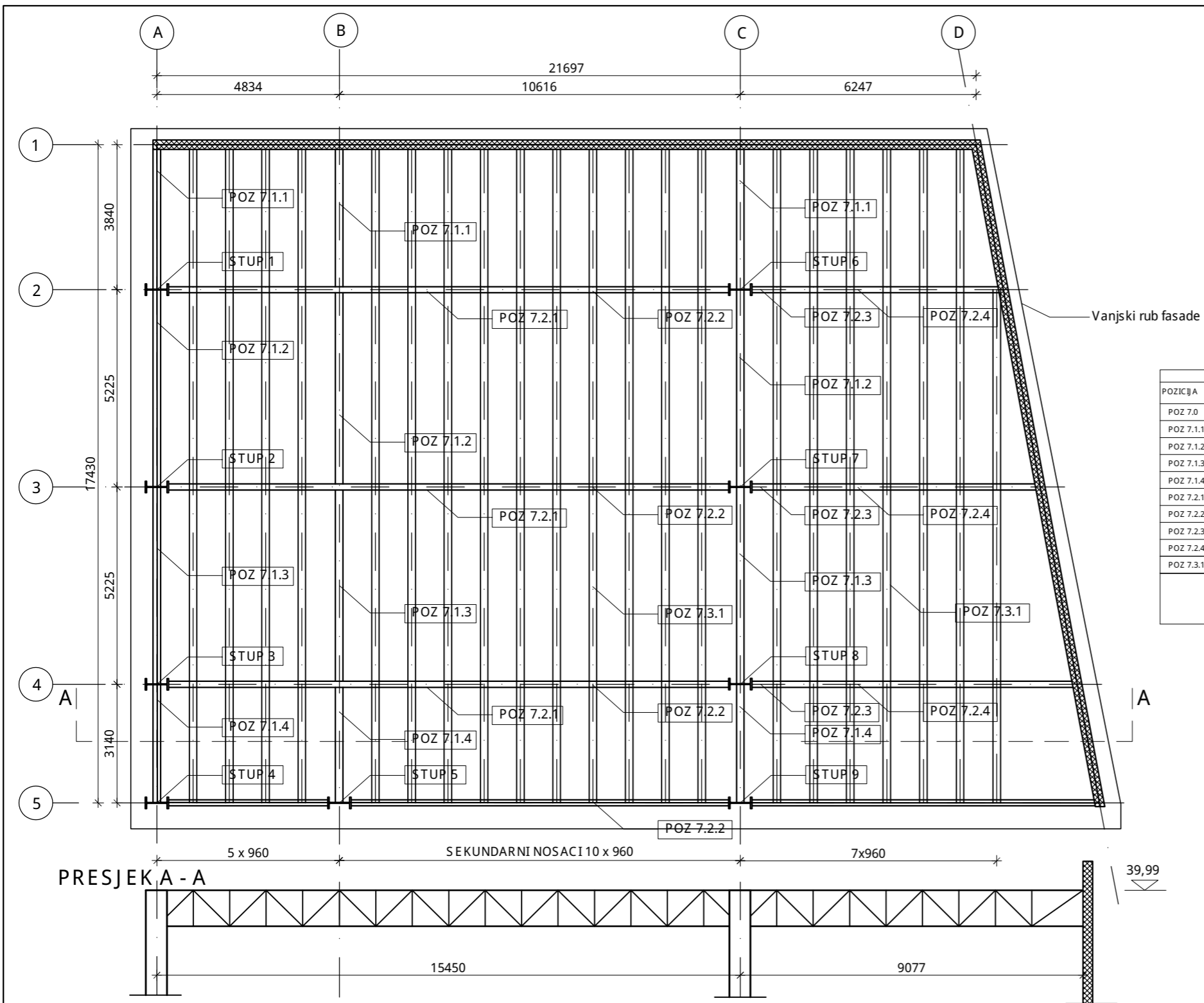

PRIKAZ I OPIS POZICIJA						
POZICIJA	NAZIV	PROFIL	G	l	n	masa
POZ 7.0	STUP-1,2,3,4,5,6,7,8,9	HEM 600				
POZ 7.1.1.	Gornja pojasnica glavnog repetkastog nosaTa	200x200x10	31,4	7,73	6	1456,33
POZ 7.1.2.	Donja pojasnica glavnog repetkastog nosaTa	200x200x10	31,4	7,73	6	1456,33
POZ 7.1.3.	Vertikalna ispuna glavnog repetkastog nosaTa	160x160x6	20,01	0,95	69	1311,66
POZ 7.1.4.	Kosa ispuna glavnog repetkastog nosaTa	160x160x6	20,01	1,34	69	1850,12
POZ 7.2.1.	Gornja pojasnica sekundarnog repetkastog nosaTa	200x200x8	31,4	8,81	9	2489,71
POZ 7.2.2.	Donja pojasnica sekundarnog repetkastog nosaTa	200x200x8	31,4	8,81	9	2489,71
POZ 7.2.3.	Vertikalna ispuna sekundarnog repetkastog nosaTa	160x160x6	20,01	0,95	90	1710,86
POZ 7.2.4.	Kosa ispuna sekundarnog repetkastog nosaTa	160x160x6	20,01	1,29	90	2323,16
POZ 7.3.1.	Gredni nosaT-krov	HEA 200	42,3	8,72	40	14754,24
UKUPNA MASA						29842,12
2% SPOJNA SREDSTVA						596,84
UKUPNO						30438,96



SVEUČILIŠTE U SPLITU
GRAĐEVINSKO-ARHITEKTONSKI FAKULTET
21000 SPLIT, MATICE HRVATSKE 15

DIPLOMSKI RAD			
PROGRAM: PRORACUN CELICNE KONSTRUKCIJE KULTURNOG OBJEKTA			
STUDENTICA:	MENTOR:	doc. dr. sc. V. DiviP	
Ana LatinTIP	KOMENTOR:	doc.dr.sc. I. Boko	
SADRGAJ:	GENERALNI PLAN POZICIJA	MJERILO:	1:100
rujan, 2018.		PRILOG:	1

DATUM

GENERALNI PLAN POZICIJA 600 M 1:100

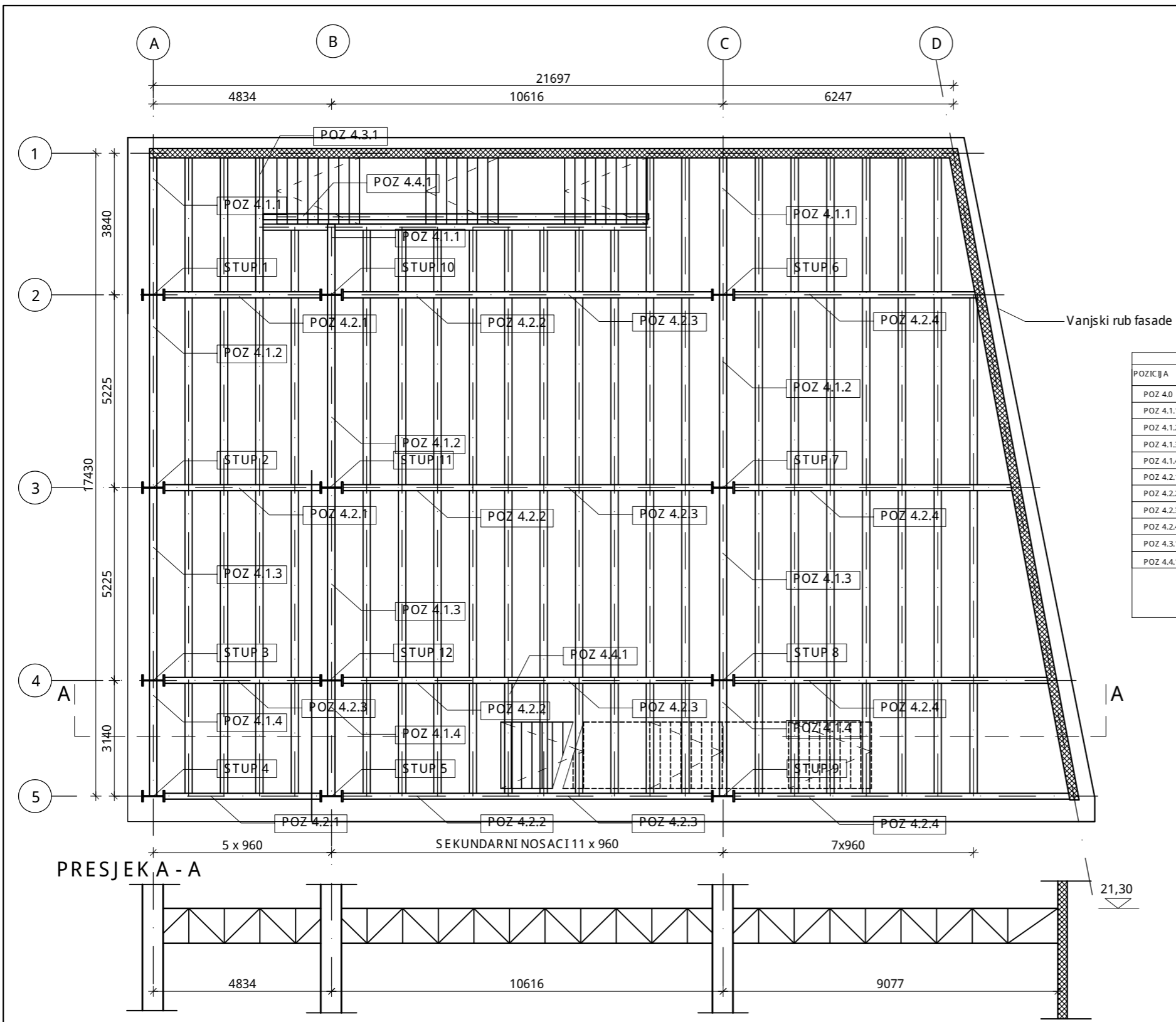

PRIKAZ I OPIS POZICIJA						
POZICIJA	NAZIV	PROFIL	G	l	n	masa
POZ 4.0	STUP-1,2,3,4,5,6,7,8,9	HEM 600	285	6,8x8,4,8x4		20976
POZ 4.1.1.	Gornja pojasnica glavnog repetkastog nosaTa	200x200x10	31,4	8,72	6	1642,85
POZ 4.1.2.	Donja pojasnica glavnog repetkastog nosaTa	200x200x10	31,4	8,72	6	1642,85
POZ 4.1.3.	Vertikalna ispuna glavnog repetkastog nosaTa	160x160x6	20,01	0,95	69	1311,66
POZ 4.1.4.	Kosa ispuna glavnog repetkastog nosaTa	160x160x6	20,01	1,35	69	1850,12
POZ 4.2.1.	Gornja pojasnica sekundarnog repetkastog nosaTa	200x200x8	31,4	4,64,5,67,8,85,9,48,7,73x6		2355,63
POZ 4.2.2.	Donja pojasnica sekundarnog repetkastog nosaTa	200x200x8	31,4	4,64,5,67,8,85,9,48,7,73x6		2355,63
POZ 4.2.3.	Vertikalna ispuna sekundarnog repetkastog nosaTa	160x160x6	20,01	0,95	30	570,28
POZ 4.2.4.	Kosa ispuna sekundarnog repetkastog nosaTa	160x160x6	20,01	1,33	30	798,39
POZ 4.3.1.	Gredni nosaT-stubipite	IPE 300	42,22	10,13	1	427,68
POZ 4.4.1.	Gredni nosaT-galerija	HEA 160	30,4	22x8,72;7,63x10;6,79x2		8564,29
UKUPNA MASA						42495,68
2% SPOJNA SREDSTVA						849,91
UKUPNO						43345,59

PRESJEK A - A

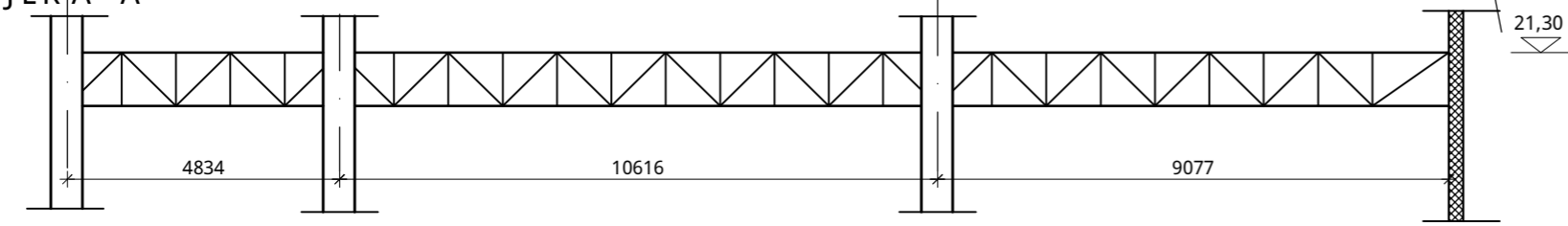



SVEUČILIŠTE U SPLITU
GRAĐEVINSKO-ARHITEKTONSKI FAKULTET
21000 SPLIT, MATICE HRVATSKE 15

DIPLOMSKI RAD

PROGRAM: PRORACUN CELICNE KONSTRUKCIJE
KULTURNOG OBJEKTA

STUDENTICA:	ANALIZATOR:	MENTOR:	doc. dr. sc. V. DiviP
	Ana LatinTIP	KOMENTOR:	doc.dr.sc. I. Boko dr.sc. N. ToriP
SADRGAJ:	GENERALNI PLAN POZICIJA	MJERILO:	1:100
	rujan, 2018.	PRILOG:	4

GENERALNI PLAN
POZICIJA 300
M 1:100

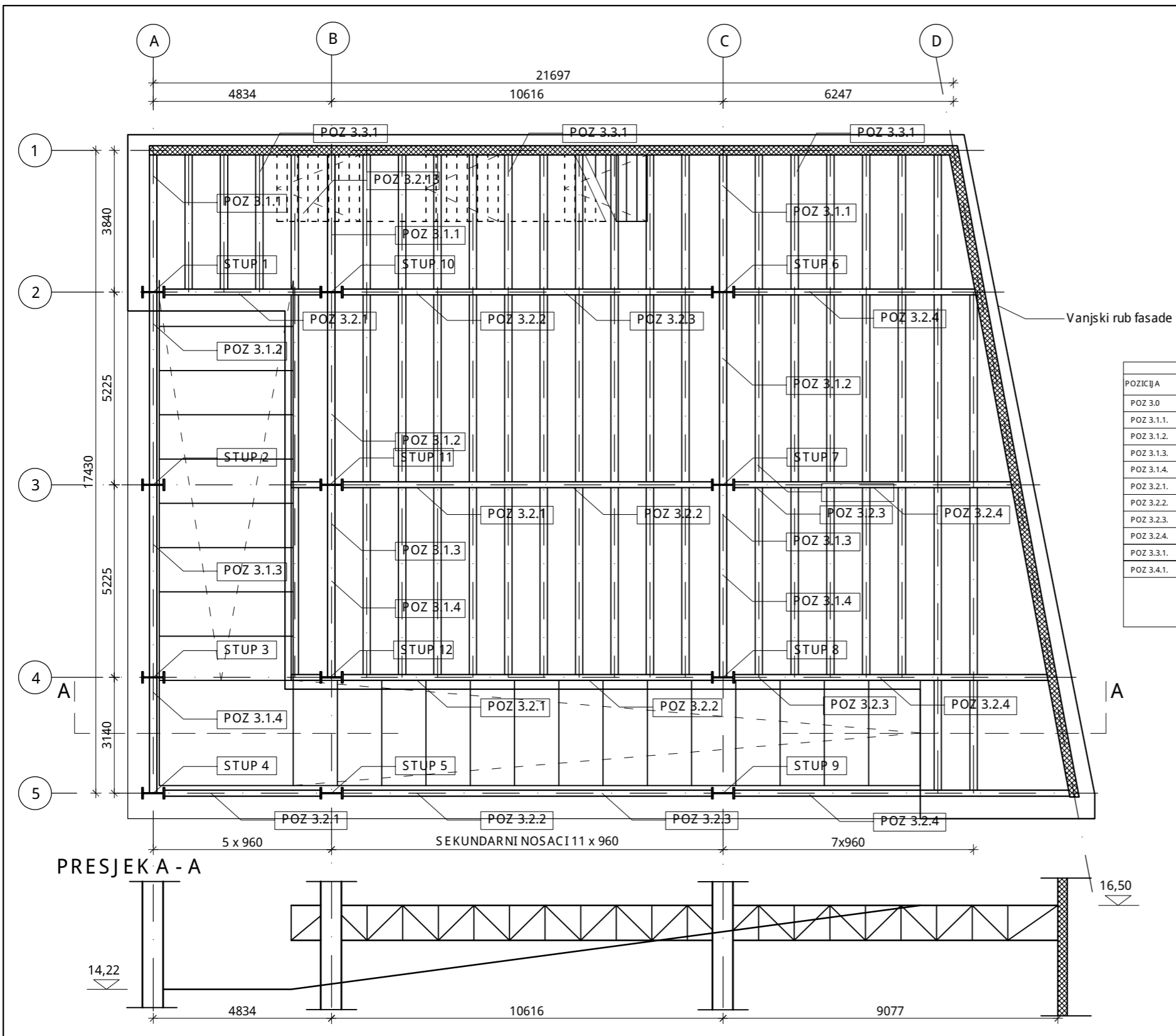

PRIKAZ I OPIS POZICIJA						
POZICIJA	NAZIV	PROFIL	G	l	n	masa
POZ 3.0	STUP-1,2,3,4,5,6,7,8,9,10,11,12	HEM 600	285	4,8	12	16416
POZ 3.1.1.	Gornja pojasnica glavnog repetkastog nosaTa	200x200x10	31,4	7,15x4,8,72x2		1445,66
POZ 3.1.2.	Donja pojasnica glavnog repetkastog nosaTa	200x200x10	31,4	7,15x4,8,72x2		1642,85
POZ 3.1.3.	Vertikalna ispuna glavnog repetkastog nosaTa	160x160x6	20,01	0,95	51	969,48
POZ 3.1.4.	Kosa ispuna glavnog repetkastog nosaTa	160x160x6	20,01	1,35	51	1377,69
POZ 3.2.1.	Gornja pojasnica sekundarnog repetkastog nosaTa	200x200x8	31,4	4,64;5,67;8,85;9,48;7,73x4;5,81x4		2599,92
POZ 3.2.2.	Donja pojasnica sekundarnog repetkastog nosaTa	200x200x8	31,4	4,64;5,67;8,85;9,48;7,73x4;5,81x4		2599,92
POZ 3.2.3.	Vertikalna ispuna sekundarnog repetkastog nosaTa	160x160x6	20,01	0,95	30	570,28
POZ 3.2.4.	Kosa ispuna sekundarnog repetkastog nosaTa	160x160x6	20,01	1,33	30	798,39
POZ 3.3.1.	Gredni nosaT-stubijte	IPE 300	42,22	10,13	1	427,68
POZ 3.4.1.	Gredni nosaT-galerija	HEA 160	30,4	38x7,15;2x7,73;6,79x2		9142,45
UKUPNA MASA						37990,32
2% SPOJNA SREDSTVA						759,81
UKUPNO						38750,13



SVEUČILIŠTE U SPLITU
GRAĐEVINSKO-ARHITEKTONSKI FAKULTET
21000 SPLIT, MATICE HRVATSKE 15

DIPLOMSKI RAD

PROGRAM: PRORACUN CELICNE KONSTRUKCIJE KULTURNOG OBJEKTA

STUDENTICA:	MENTOR:	doc. dr. sc. V. DiviP
Ana LatinTIP	KOMENTOR:	doc.dr.sc. I. Boko dr.sc. N. ToriP
SADRGAJ:	MJERILO:	1:100
GENERALNI PLAN POZICIJA	PRILOG:	5
rujan, 2018.		

GENERALNI PLAN POZICIJA 200 M 1:100

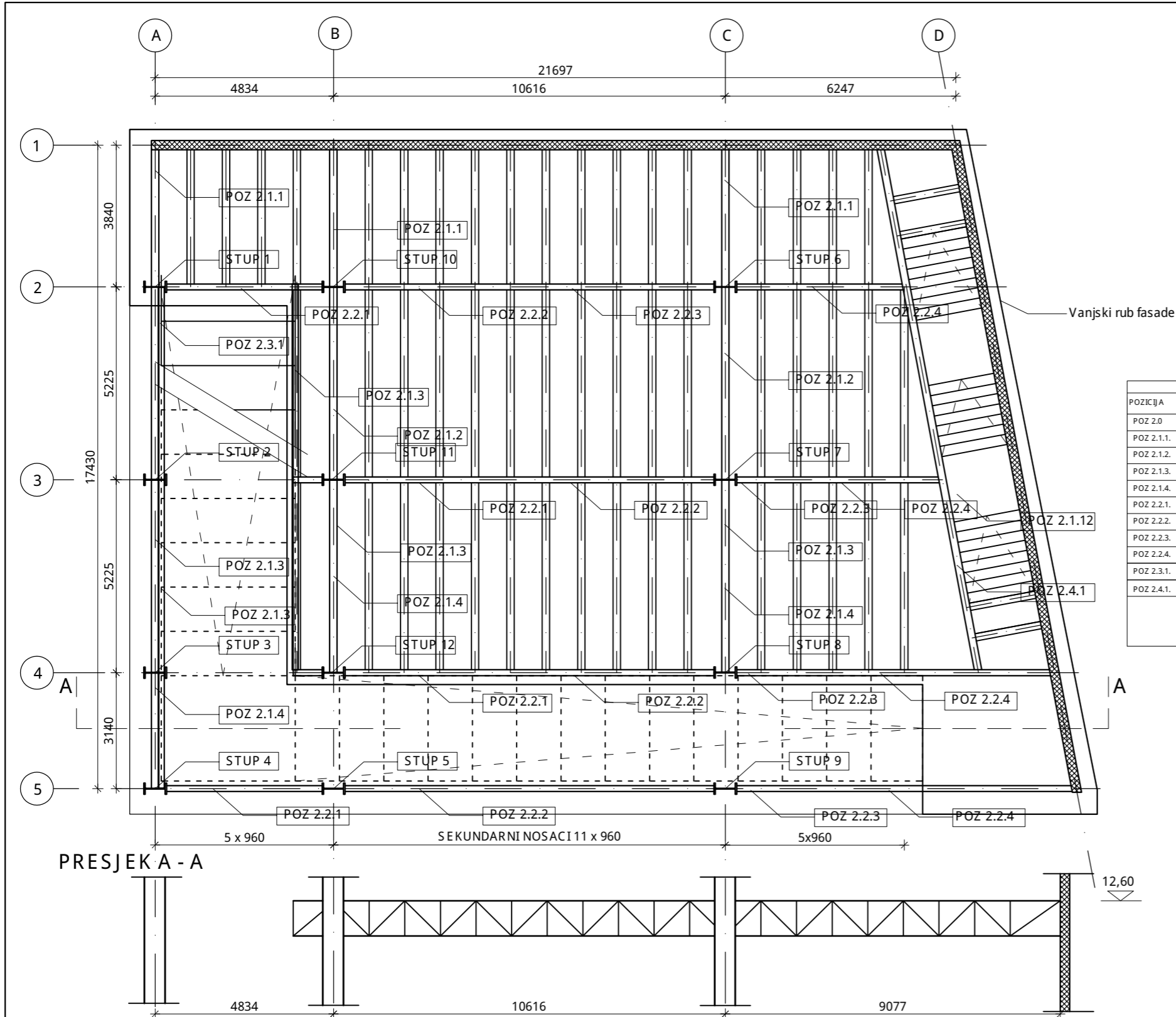

PRIKAZ I OPIS POZICIJA						
POZICIJA	NAZIV	PROFIL	G	l	n	masa
POZ 2.0	STUP-1,2,3,4,5,6,7,8,9,10,11,12	HEM 600	285	3,9	12	16416
POZ 2.1.1	Gornja pojasnica glavnog repetkastog nosaTa	200x200x10	31,4	7,73	6	1456,33
POZ 2.1.2	Donja pojasnica glavnog repetkastog nosaTa	200x200x10	31,4	7,73	6	1456,33
POZ 2.1.3	Vertikalna ispuna glavnog repetkastog nosaTa	160x160x6	20,01	0,95	69	1311,66
POZ 2.1.4	Kosa ispuna glavnog repetkastog nosaTa	160x160x6	20,01	1,35	69	1850,12
POZ 2.2.1	Gornja pojasnica sekundarnog repetkastog nosaTa	200x200x8	31,4	4,64,5,67,8,85,9,48,7,73x6		2355,63
POZ 2.2.2	Donja pojasnica sekundarnog repetkastog nosaTa	200x200x8	31,4	4,64,5,67,8,85,9,48,7,73x6		2355,63
POZ 2.2.3	Vertikalna ispuna sekundarnog repetkastog nosaTa	160x160x6	20,01	0,95	30	570,28
POZ 2.2.4	Kosa ispuna sekundarnog repetkastog nosaTa	160x160x6	20,01	1,33	30	798,39
POZ 2.3.1	Gredni nosaT-stubijte	IPE 300	42,22	10,13	1	427,68
POZ 2.4.1	Gredni sekundarni nosaT	HEA 160	30,4	38x7,15;2x7,73;6,79x2		9142,45
UKUPNA MASA						38410,5
2% SPOJNA SREDSTVA						762,81
UKUPNO						39173,31



SVEUČILIŠTE U SPLITU
GRAĐEVINSKO-ARHITEKTONSKI FAKULTET
21000 SPLIT, MATICE HRVATSKE 15

DIPLOMSKI RAD

PROGRAM: PRORACUN CELICNE KONSTRUKCIJE
KULTURNOG OBJEKTA

STUDENTICA: Ana LatinTIP MENTOR: doc. dr. sc. V. DiviP

KOMENTOR: doc.dr.sc. I. Boko
dr.sc. N. ToriP

SADRGAJ: GENERALNI PLAN POZICIJA MJERILO: 1:100

rujan, 2018. PRILOG: 6

GENERALNI PLAN POZICIJA 100 M 1:100

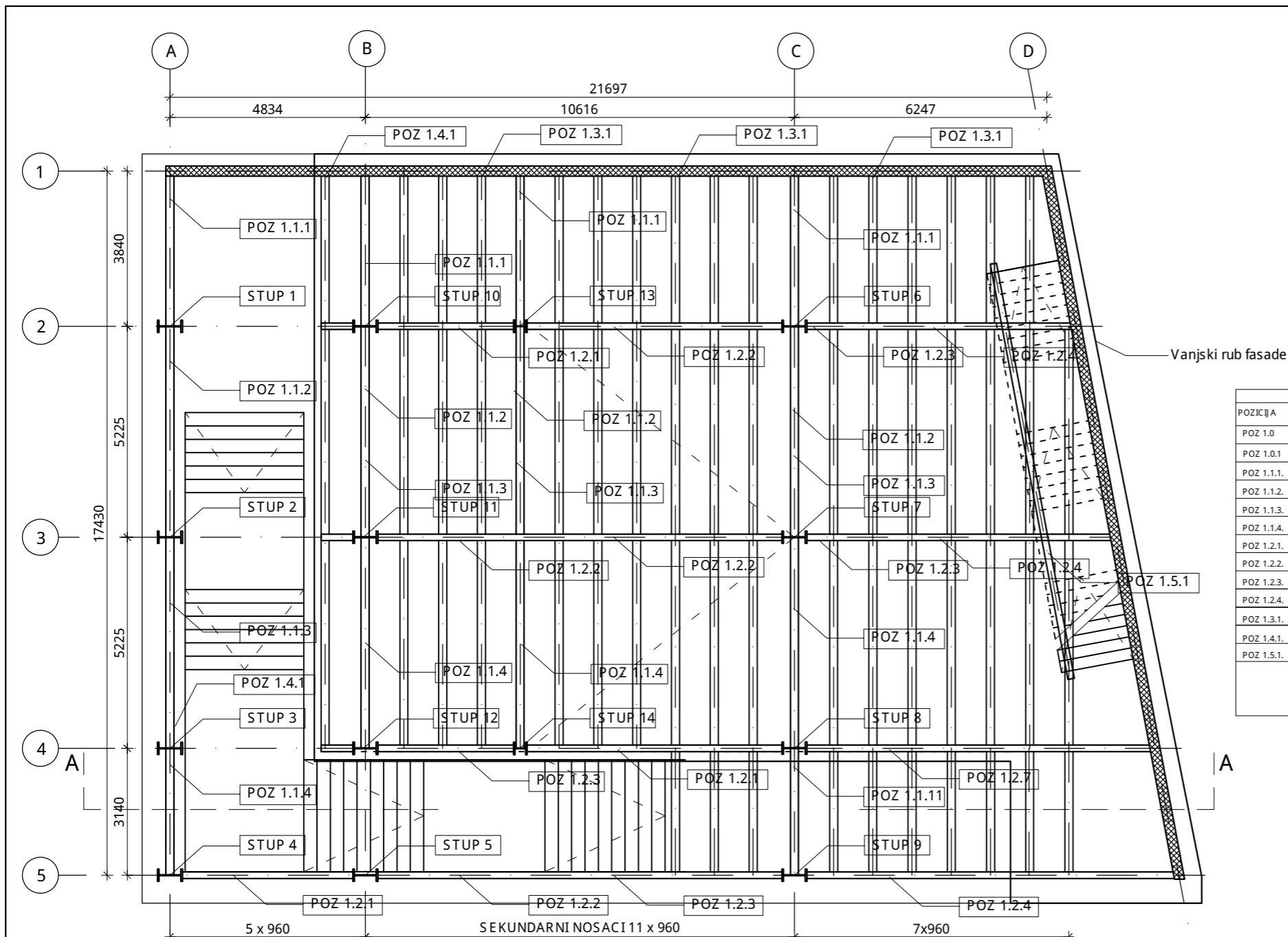

PRIKAZ I OPIS POZICIJA						
POZICIJA	NAZIV	PROFIL	G	l	n	masa
POZ 1.0	STUP-1,2,3,4,5,6,7,8,9,10,11,12	HEM 600	285	7,8	12	26676
POZ 1.0.1	STUP-13,14	HEM 300	238	4,8	2	2284,8
POZ 1.1.1.	Gornja pojasnica glavnog repetkastog nosaTa	200x200x10	31,4	7,15x4;8,72x4	8	1993,27
POZ 1.1.2.	Donja pojasnica glavnog repetkastog nosaTa	200x200x10	31,4	7,15x4;8,72x4	8	1456,33
POZ 1.1.3.	Vertikalna ispuna glavnog repetkastog nosaTa	160x160x6	20,01	0,95	69	1311,66
POZ 1.1.4.	Kosa ispuna glavnog repetkastog nosaTa	160x160x6	20,01	1,35	69	1850,12
POZ 1.2.1.	Gornja pojasnica sekundarnog repetkastog nosaTa	200x200x8	31,4	6,78;7,82;8,85;9,48;7,73x6	9	2490,33
POZ 1.2.2.	Donja pojasnica sekundarnog repetkastog nosaTa	200x200x8	31,4	6,78;7,82;8,85;9,48;7,73x6	9	2490,33
POZ 1.2.3.	Vertikalna ispuna sekundarnog repetkastog nosaTa	160x160x6	20,01	0,95	30	570,28
POZ 1.2.4.	Kosa ispuna sekundarnog repetkastog nosaTa	160x160x6	20,01	1,33	30	798,39
POZ 1.3.1.	Gredni nosaT-stubijete 1	IPE 300	42,22	10,13	1	427,68
POZ 1.4.1.	Gredni nosaT-stubijete 2	HEA 160	30,4	38x7,15;2x7,73;6,79x2	16	9142,45
POZ 1.5.1.	Gredni sekundarni nosaT	HEA 200	42,3	7,15x14;8,72x18;6,79x2	34	11448,07
UKUPNA MASA						62939,71
2% SPOJNA SREDSTVA						1258,79
UKUPNO						64198,50

PRESJEK A - A

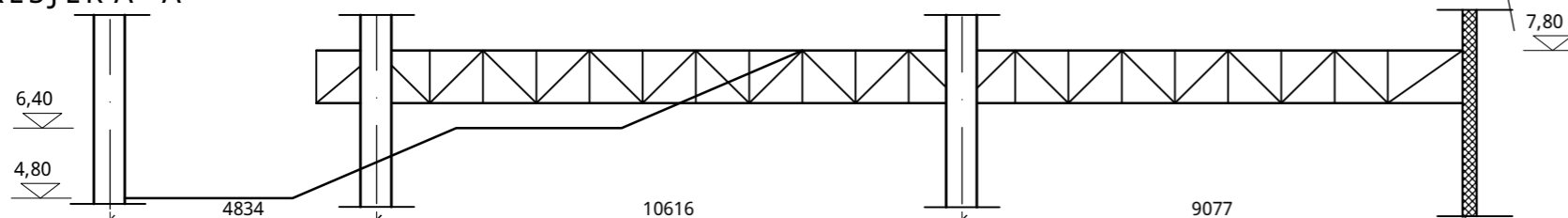



SVEUČILIŠTE U SPLITU
GRAĐEVINSKO-ARHITEKTONSKI FAKULTET
21000 SPLIT, MATICE HRVATSKE 15

DIPLOMSKI RAD			
PROGRAM: PRORACUN CELICNE KONSTRUKCIJE KULTURNOG OBJEKTA			
STUDENTICA:	MENTOR:	doc. dr. sc. V. DiviP	
Ana LatinTIP	KOMENTOR:	doc.dr.sc. I. Boko	
SADRGAJ:	MJERILO:	1:100	
GENERALNI PLAN POZICIJA	PRILOG:	7	
rujan, 2018.			

DETALJ 1 M1:10 SPOJ STUP-GREDA

PRESJEK A-A

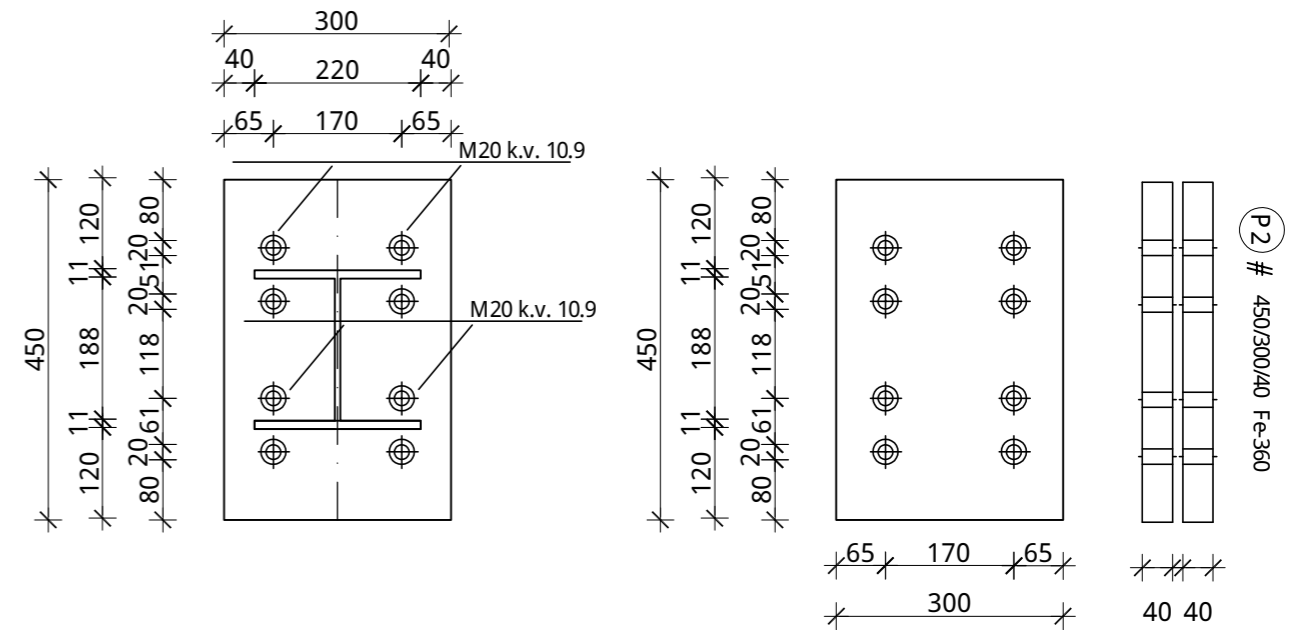
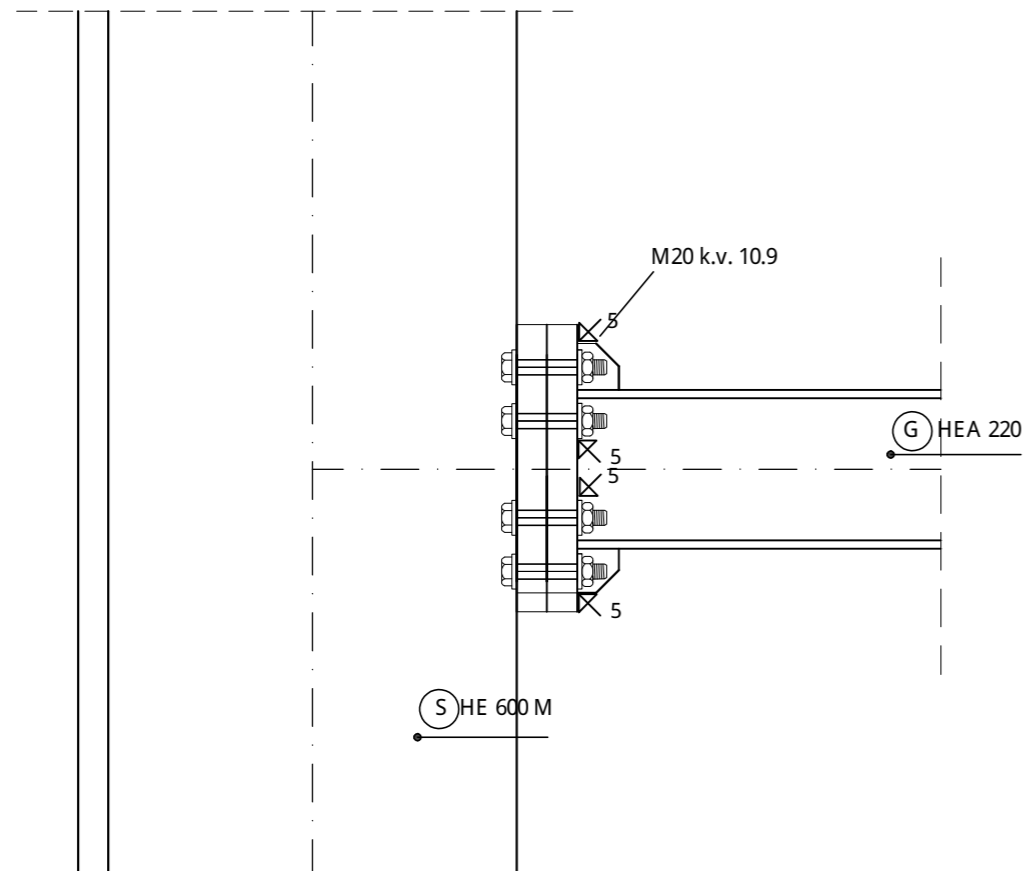

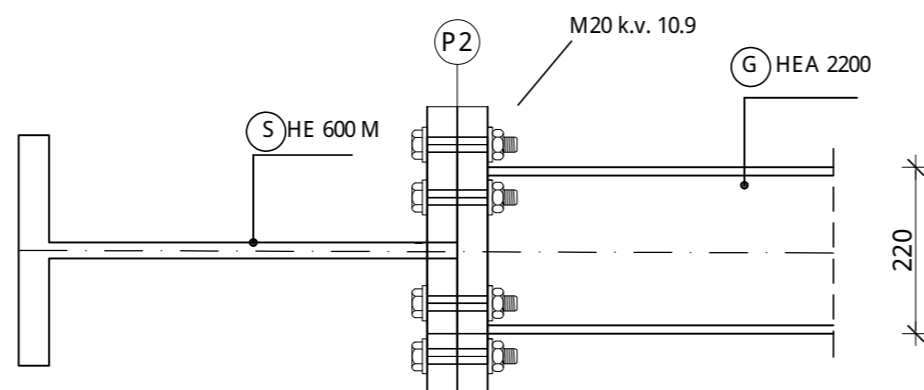

PRESJEK C-C

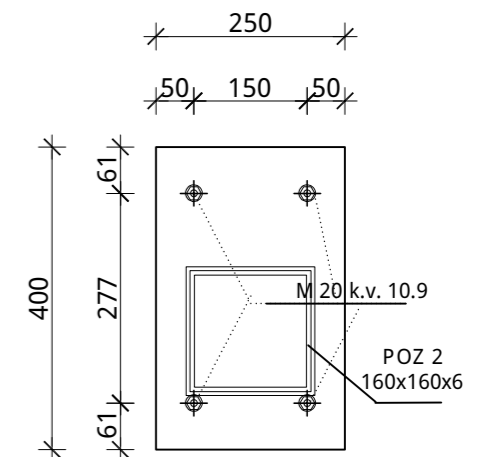
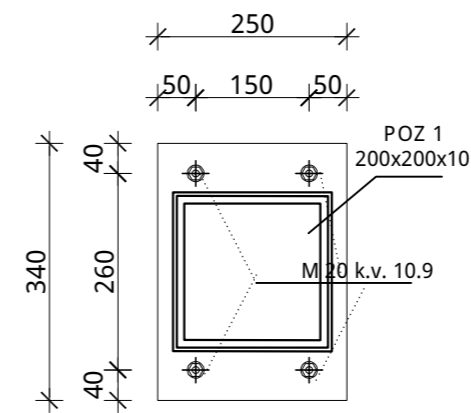
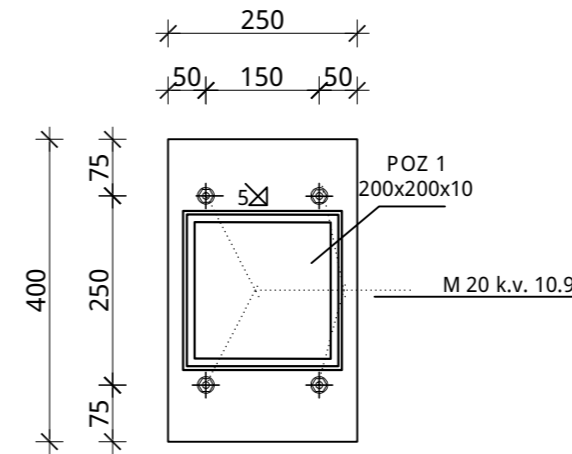
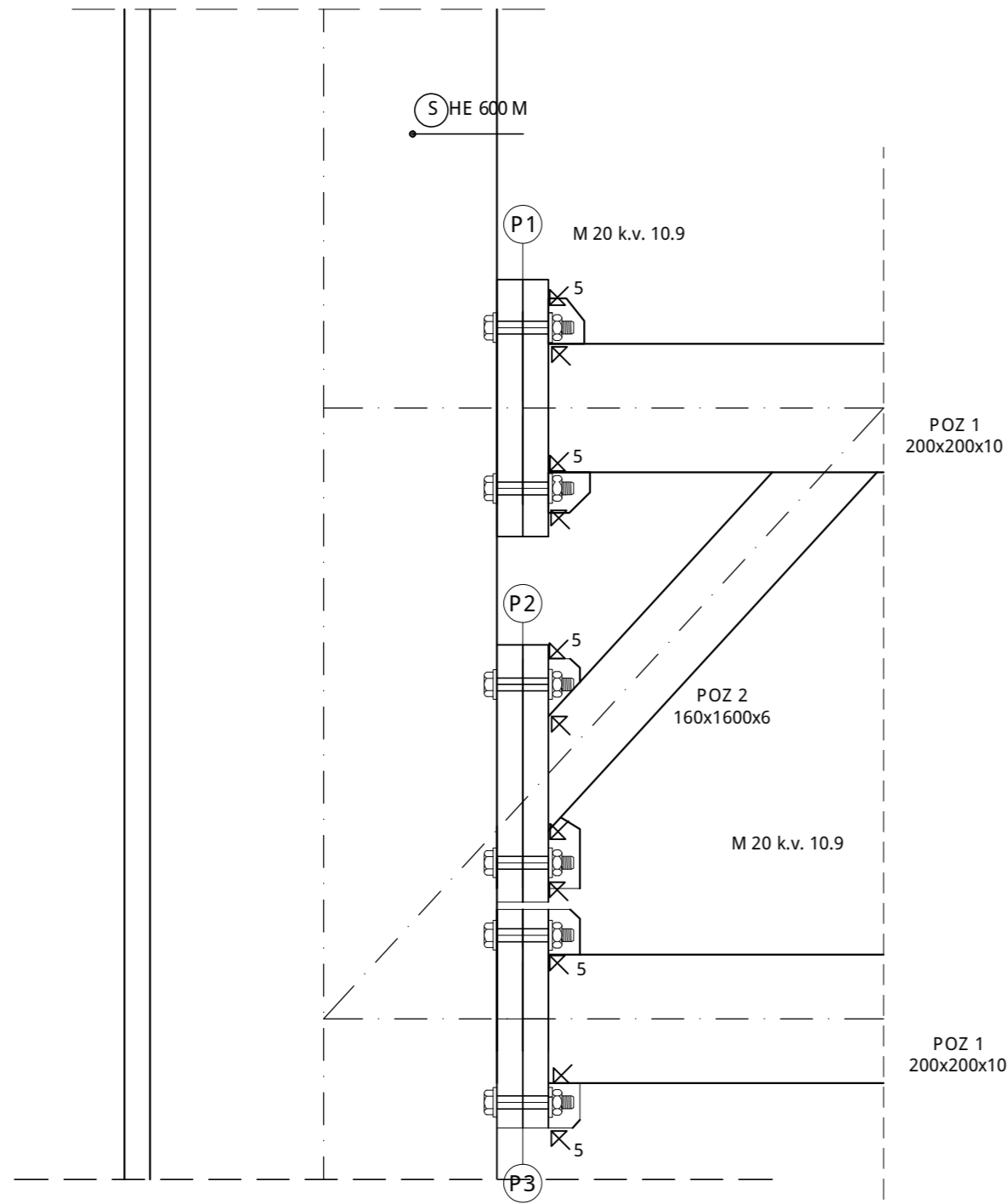

 SVEUČILIŠTE U SPLITU, GRAĐEVINSKO - ARHITEKTONSKI FAKULTET 21000 SPLIT, MATICE HRVATSKE 15	DIPLOMSKI RAD		
	PROGRAM: PRORACUN CELICNE KONSTRUKCIJE KULTURNOG OBJEKTA		
	STUDENTI: ANA LATINCIĆ	MENTOR	Doc. dr. sc. V. Divić
		KOMENTOR	Doc. dr. sc. I. Boko dr. sc. N. Torić
	SADRŽAJ	DETALJ 1 - SPOJ GREDE ISTUPA	MJERILO 1:10
DATUM	rujan, 2018.	PRIOLOG: 8	

DETALJ 2 M1:10 SPOJ STUP-GREDA



 <p>SVEUČILIŠTE U SPLITU, GRAĐEVINSKO - ARHITEKTONSKI FAKULTET 21000 SPLIT, MATICE HRVATSKE 15</p>	DIPLOMSKI RAD		
	PROGRAM: PRORACUN CELICNE KONSTRUKCIJE KULTURNOG OBJEKTA		
	STUDENTI: ANA LATINCIP	MENTOR	Doc. dr. sc. V. DiviP
		KOMENTOR	Doc.dr.sc. I.Boko dr.sc. N. ToriP
	SADRŽAJ	DETALJ 2 - SPOJ GREDE ISTUPA	MJERILO 1:10
DATUM	rujan, 2018.	PRILOG: 9	

DETALJ 3 M1:10 SPOJ STUPA I TEMELJA

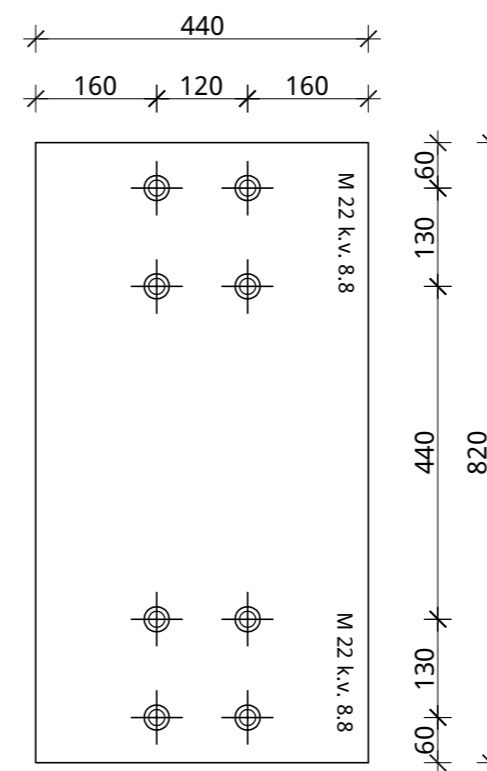
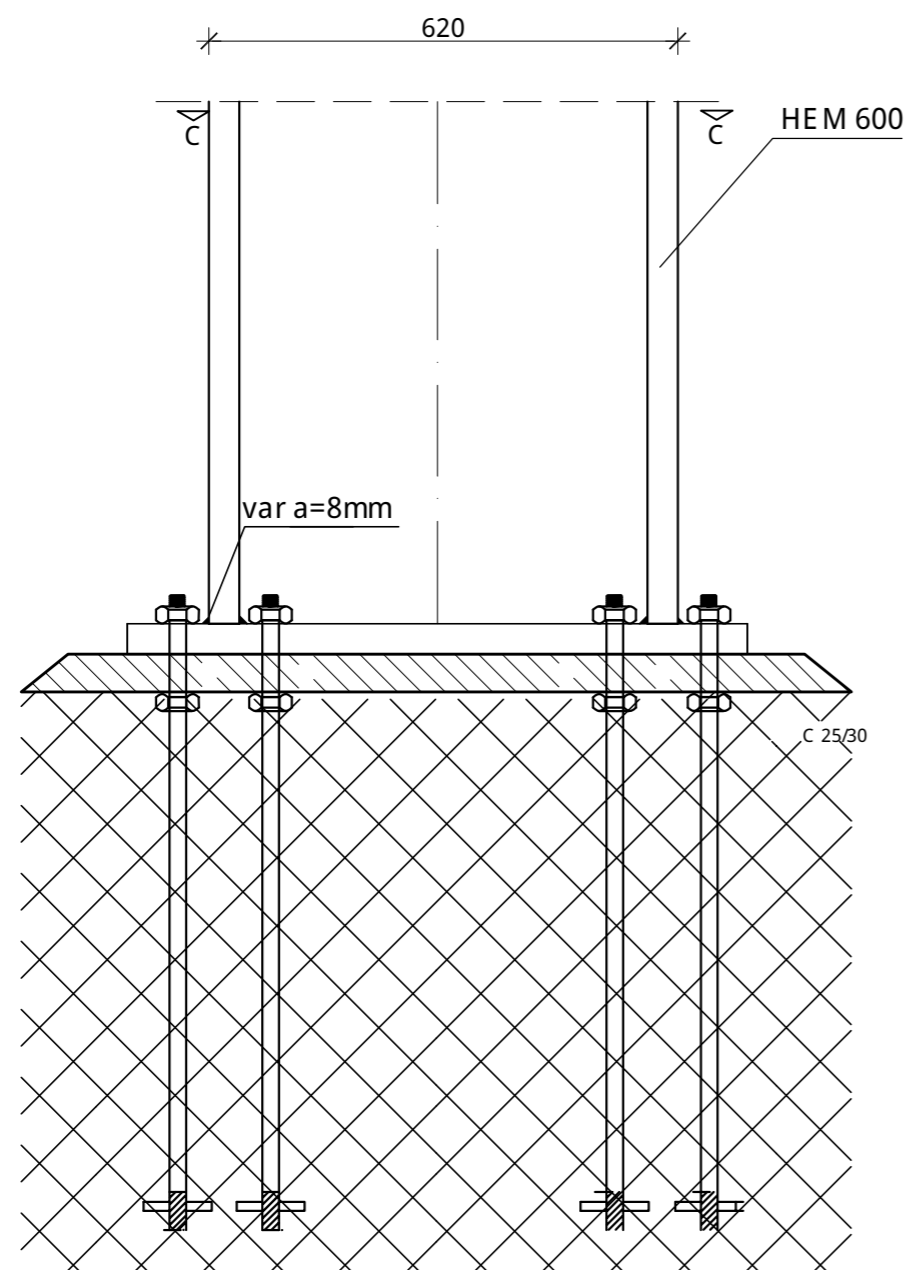

Ⓟ # 820/440/40 Fe-360

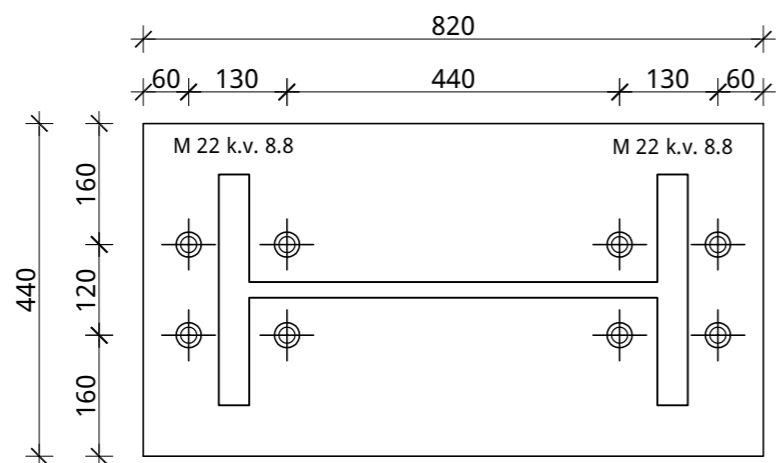
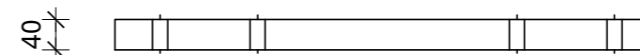

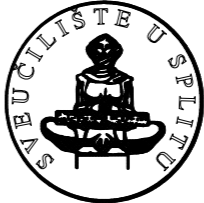
 SVEUČILIŠTE U SPLITU, GRAĐEVINSKO - ARHITEKTONSKI FAKULTET 21000 SPLIT, MATICE HRVATSKE 15	DIPLOMSKI RAD		
	PROGRAM: PRORACUN CELICNE KONSTRUKCIJE KULTURNOG OBJEKTA		
	STUDENTI: ANA LATINCIP	MENTOR	Doc. dr. sc. V. DiviP
		KOMENTOR	Doc.dr.sc. I.Boko dr.sc. N. ToriP
	SADRŽAJ	DETALJ 3 - SPOJ TEMELJA I STUPA	MJERILO 1:10
DATUM	rujan, 2018.	PRILOG: 10	

DETALJ 4 M1:10 MONTAŠNI NASTAVAK GORNJE POJASNICE REPIETKASTOG NOSACA

DETALJ 4
Montašni nastavak gornjeg pojasa
POZ 10

Presjek 1-1

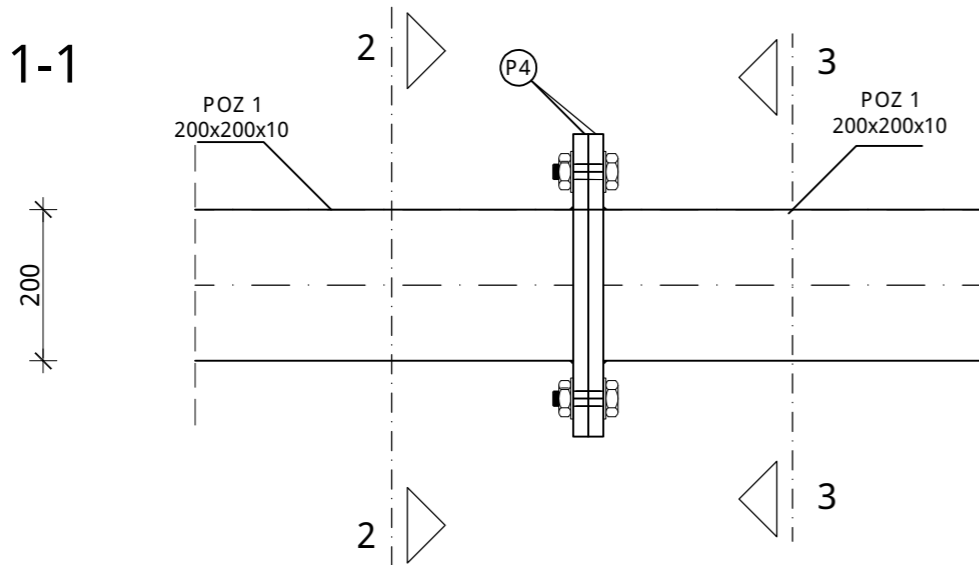

Tlocrt

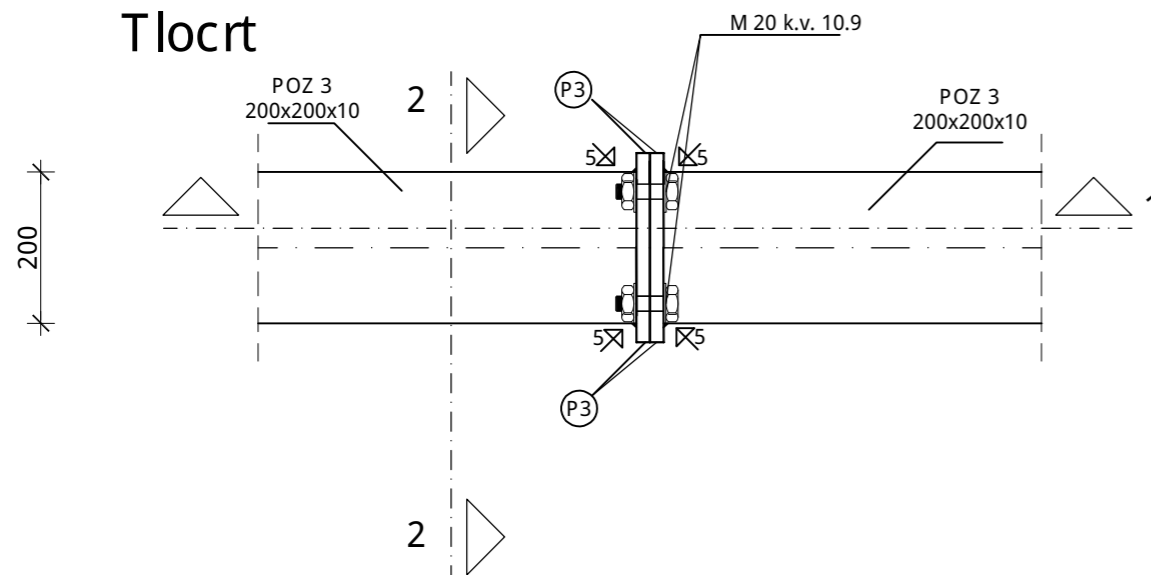

Presjek 2-2

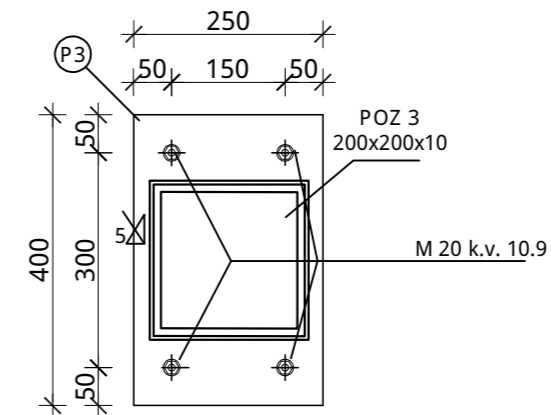

Presjek 3-3

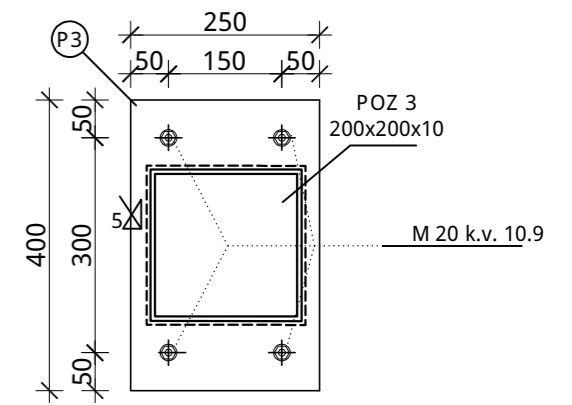

Ⓟ P3 p 250/360/30 S 355 kom. 2 po spoju

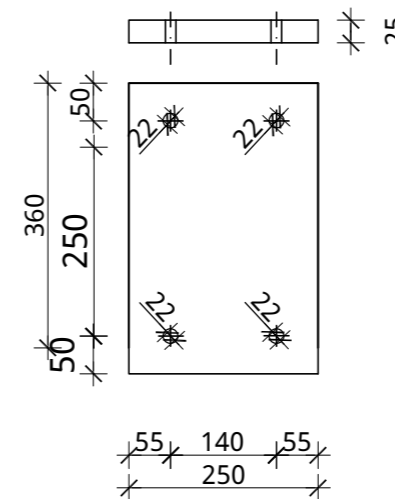

 SVEUČILIŠTE U SPLITU, GRAĐEVINSKO - ARHITEKTONSKI FAKULTET 21000 SPLIT, MATICE HRVATSKE 15	DIPLOMSKI RAD		
	PROGRAM: PRORACUN CELICNE KONSTRUKCIJE KULTURNOG OBJEKTA		
	STUDENTI: ANA LATINCIP	MENTOR	Doc. dr. sc. V. DiviP
		KOMENTOR	Doc.dr.sc. I.Boko dr.sc. N. ToriP
	SADRŽAJ	DETALJ 4 - MONTAŠNI NASTAVAK GORNJE POJASNICE REPIETKE	MJERILO 1:10
DATUM	rujan, 2018.	PRILOG: 11	

DETALJ 5 M1:10 MONTAŽNI NASTAVAK DONJE POJASNICE REŠETKASTOG NOSAČA

DETALJ 5

Montažni nastavak donjeg pojasa

Presjek 1-1

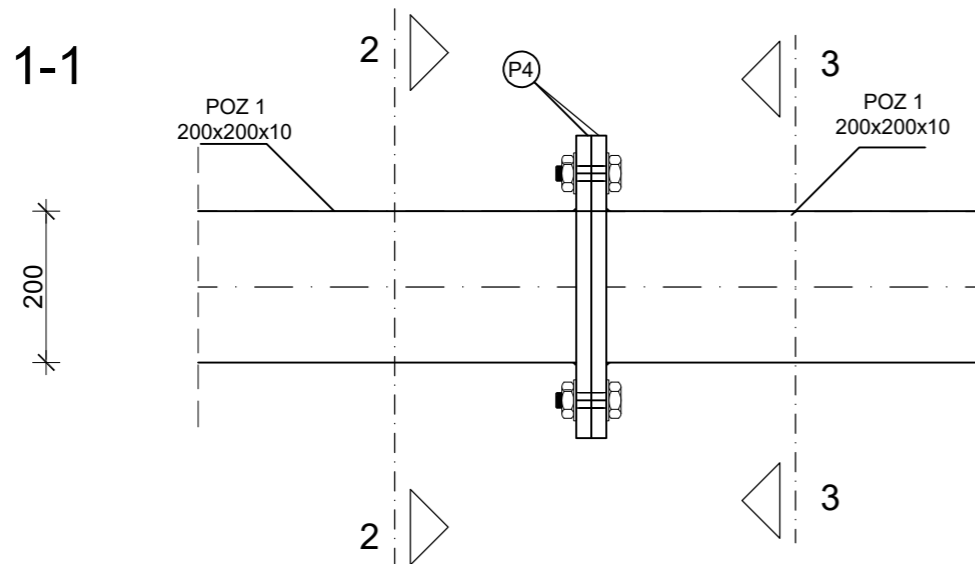

Tlocrt

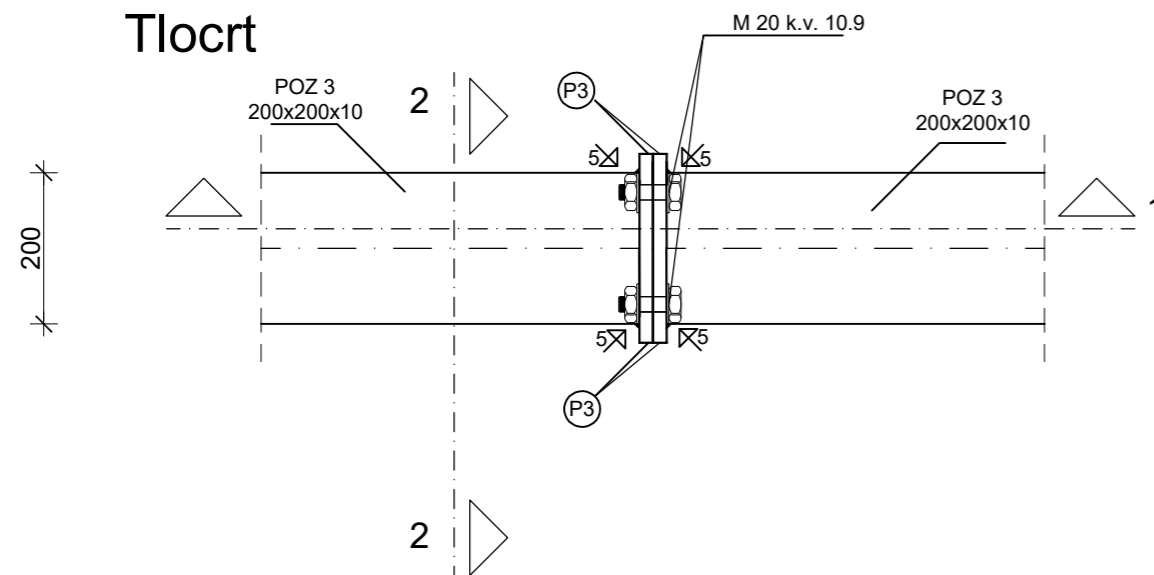

Presjek 2-2

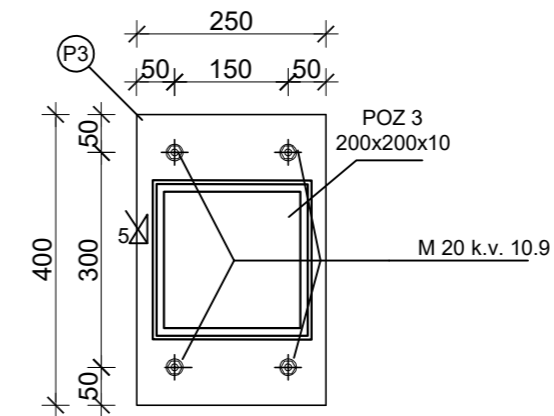

Presjek 3-3

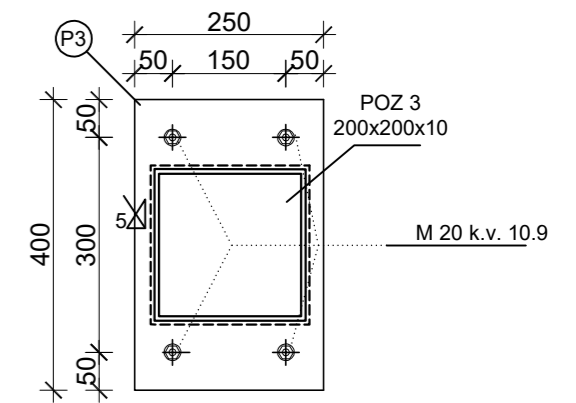

Ⓟ ≠ 250/360/30 S 355 kom. 2 po spoju

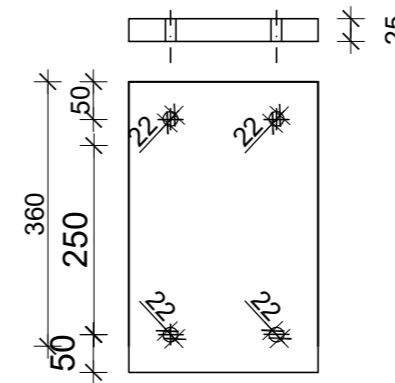

 SVEUČILIŠTE U SPLITU GRAĐEVINSKO - ARHITEKTONSKI FAKULTET 21000 SPLIT, MATICE HRVATSKE 15	DIPLOMSKI RAD		
	PROGRAM: PRORAČUN ČELIČNE KONSTRUKCIJE KULTURNOG OBJEKTA		
	STUDENTI: ANA LATINČIĆ	MENTOR Doc. dr. sc. V. Divić	KOMENTOR Doc. dr. sc. I. Boko dr. sc. N. Torić
	SADRŽAJ: DETALJ 5 - MONTAŽNI NASTAVAK DONJE POJASNICE REŠETKE		MJERILO: 1:10
	DATUM: rujnan, 2018.		PRILOG: 12