

Dimenzioniranje drvenog objekta

Crnković, Ivana

Undergraduate thesis / Završni rad

2019

Degree Grantor / Ustanova koja je dodijelila akademski / stručni stupanj:

University of Split, Faculty of Civil Engineering, Architecture and Geodesy / Sveučilište u Splitu, Fakultet građevinarstva, arhitekture i geodezije

Permanent link / Trajna poveznica: <https://um.nsk.hr/um:nbn:hr:123:392310>

Rights / Prava: [In copyright](#)/[Zaštićeno autorskim pravom.](#)

Download date / Datum preuzimanja: **2024-12-29**



Repository / Repozitorij:

[FCEAG Repository - Repository of the Faculty of Civil Engineering, Architecture and Geodesy, University of Split](#)



UNIVERSITY OF SPLIT



SVEUČILIŠTE U SPLITU
FAKULTET GRAĐEVINARSTVA, ARHITEKTURE I GEODEZIJE

ZAVRŠNI RAD

Ivana Crnković

Split, 2019.

SVEUČILIŠTE U SPLITU
FAKULTET GRAĐEVINARSTVA, ARHITEKTURE I GEODEZIJE

Ivana Crnković

Dimenzioniranje drvenog objekta

Završni rad

Split, 2019.

SVEUČILIŠTE U SPLITU

FAKULTET GRAĐEVINARSTVA, ARHITEKTURE I GEODEZIJE

Split, Matice hrvatske 15

**STUDIJ: PREDDIPLOMSKI SVEUČILIŠNI STUDIJ
GRAĐEVINARSTVA**

KANDIDAT: Ivana Crnković

BROJ INDEKSA: 4523

KATEDRA: Katedra za metalne i drvene konstrukcije

PREDMET: Osnove drevnih konstrukcija

ZADATAK ZA ZAVRŠNI RAD

Opis zadatka: Na temelju zadanih podataka drvenog objekta potrebno je konstruirati i dimenzionirati nosivi sustav.

Način izvedbe: montažno

Materijal konstrukcije: C24/ uporabna klasa 2

Objekt se nalazi na području Zagreba.

Stabilizacija: čelični spregovi

U Splitu, 19.09.2019.

Voditelj Završnog rada: prof.dr.sc. Neno Torić

Dimenzioniranje drvenog objekta

Sažetak:

Na temelju zadanih podataka drvenog objekta potrebno je dimenzionirati glavnu nosivu konstrukciju, spregove konstrukcije i temelje. Objekt se nalazi na području Zagreba. Proračun se provodi na temelju graničnog stanja nosivosti (GSN) i graničnog stanja uporabljivost (GSU).. Iznosi unutarnji sila dobiveni su u računalnom programu „SCIA Engineer 18.1“.

Ključne riječi:

Drvo, nosiva konstrukcija, spregovi, grede, stup, dimenzioniranje, spojevi

Design of a timber structure

Abstract:

Based on the information about the timber structure, the assignment is to design this structure: its main supporting structure, bracings and foundations. The object is located in Zagreb. Structure calculations are based on ultimate limit state (ULS) and serviceability limit state (SLS). The results of the internal forces were calculated in „SCIA Engineer 18.1“.

Keywords:

Timber, load-bearing structure, bracings, beams, column, design, joints.

Sadržaj:

1.0 Tehnički opis.....	1
1.1 Opis konstrukcije.....	1
1.2 Statička analiza konstrukcije.....	1
1.3 Konstruktivni elementi.....	2
1.4 Zaštita elemenata.....	2
1.5 Transport i montaža.....	2
2.0 Analiza opterećenja.....	3
2.1 Vlastita težina.....	3
2.2 Dodatno stalno opterećenje.....	3
2.3 Uporabno opterećenje.....	5
2.4 Snijeg.....	5
2.5 Vjetar.....	7
3.0 Proračun konstrukcije.....	8
3.1 Kombinacija.....	8
4.0 Dimenzioniranje.....	9
4.1 Pomaci.....	10
4.2 Dimenzioniranje glavnih krovnih greda.....	11
4.3 Dimenzioniranje sekundarnih krovnih greda.....	13
4.4 Dimenzioniranje glavnih međukatnih greda.....	15
4.5 Dimenzioniranje sekundarnih međukatnih greda.....	17
4.6 Dimenzioniranje stupova.....	19
4.7 Dimenzioniranje spregova.....	21
5.0 Spojevi.....	22
5.1 Spoj stup greda.....	22
5.2 Spoj stup-temelj.....	24
6.0 Proračun temelja.....	27
6.1 Proračun armature temelja.....	28
7.0 Literatura.....	29
8.0 Nacrti	

1.0 TEHNIČKI OPIS

1.1 OPIS KONSTRUKCIJE

Predmet ovoga završnog rada je konstrukcija i dimenzioniranje nosivog sustava drvenog objekta. Objekt se nalazi na području Zagreba. Na temelju arhitektonskih nacрта, doneseno je moguće rješenje dimenzioniranja objekta urađeno je u računalnom programu "Scia Engineer". Tlocrtne dimenzije objekta su 9x9 m te visina je 6 m. Vertikalno je razdijeljen na dva kata koja povezuje stubište. Konstrukcija je izrađena od drva klase C24 i uporabne klase 2. Konstrukcija je zamišljena kao sustav sačinjen od nosivih stupova i greda, te međukatnih greda. Stabilizacija objekta ostvarena je čeličnim spregovima. Međukatna konstrukcija je lijepljeni panelni sustav dok je fasada staklena, a kao pokrov koriste se sendvič paneli. Objekt je predviđen stanovanju. Vanjski stupovi konstrukcije su zglobno vezani s temeljem. Greda je upeto vezana za stupove.

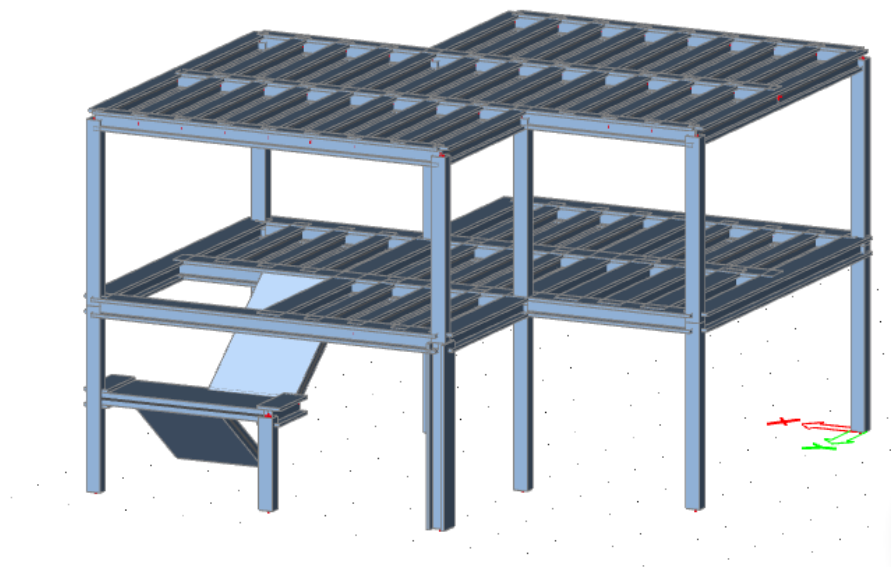

3D prikaz konstrukcije objekta

1.2 STATIČKA ANALIZA KONSTRUKCIJE

Proračun je izvršen prema EC1 i EC5. Konstrukcija je izložena djelovanju sljedećih opterećenja: vlastita težina, dodatno stalno opterećenje, korisno opterećenje, snijeg i vjetar. Odgovarajući koeficijenti za vjetar i snijeg uzeti su s obzirom na lokaciju objekta iz propisanih tablica.

Za statički proračun GSN uzete su kombinacije na temelju proračunskih djelovanja, a za GSU karakteristična i nazovistalna kombinacija koje generira software.

1.3 KONSTRUKTIVNI ELEMENTI

Krovne grede C24

Pozicija 1

Panelni sustav- grede 160/240 i OSB/3 debljine 40 mm

Pozicija 2

Panelni sustav- grede 120/200 i OSB/3 debljine 40 mm

Pozicija 3

Panelni sustav- grede 160/220 i OSB/2 debljine 40 mm

Pozicija 4

Panelni sustav- grede 140/200 i OSB/2 debljine 40 mm

Stupovi

Stupovi su također C24 dužine 600 cm, a poprečnog presjeka 220;260

Spregovi

Za stabilizaciju su odabrani čelični spregovi RD16.

1.4 ZAŠTITA ELEMENATA

Zaštita nosivih elemenata se vrši fungicidnim premazima za zaštitu od prodora vode i nametnika. Zaštita se provodi s tri premaza, s tim da je dva premaza potrebno nanijeti u tvornici prije transporta, a treći završni nakon potpunog „zatvaranja“ konstrukcije. Nosači se nakon toga pakiraju u PVC da se zaštite od vlage i vanjskih utjecaja. Zaštita metalnih dijelova i spajala izvodi se pocinčavanjem na uobičajen način, a u skladu s važećim propisima sve metalne dijelove prije pocinčavanja potrebno je obraditi. Tako pripremljeni nosači se transportiraju na odredište.

U svrhu odugovlačenja zagrijavanja konstruktivnih elemenata predmetne hale, svi takvi elementi (spregovi) moraju se zaštititi posebnim premazima otpornim na visoke temperature. Također je potrebno opremiti objekt za slučaj nastanka požara uređajima za najavu požara kao i opremom za njegovo gašenje.

1.5 TRANSPORT I MONTAŽA

Transportna trasa mora biti točno utvrđena pri čemu se mora voditi računa o radijusu krivina prema zahtjevima specijalnih vozila i slobodnim profilima. Montaža se obavezno mora

Dimenzioniranje drvenog objekta

provesti prema planu montaže. Svi elementi predgotovljeni stižu na gradilište. Nulta faza montaže, nakon izvedenih svih prethodno potrebnih radova, je montaža stupova. Kada se stup postavi na ankere koji su postavljeni u temelje, stup se pridržava dizalicom dok se ne postigne

vertikalnost. . Potom se postavljaju spregovi između stupova. Kad se prva dva stupa povežu oni postaju stabilni te se tim redoslijedom nastavlja i ostatak konstrukcije.

Transport i montažu je potrebno provesti tako da se izbjegnu eventualna oštećenja nosača.

2.0 ANALIZA OPTEREĆENJA

2.1 VLASTITA TEŽINA

Vlastita težina je opterećenje koje ovisi o geometriji i materijalu od kojega je konstrukcija izrađena i ono je automatski generirano u software-u.

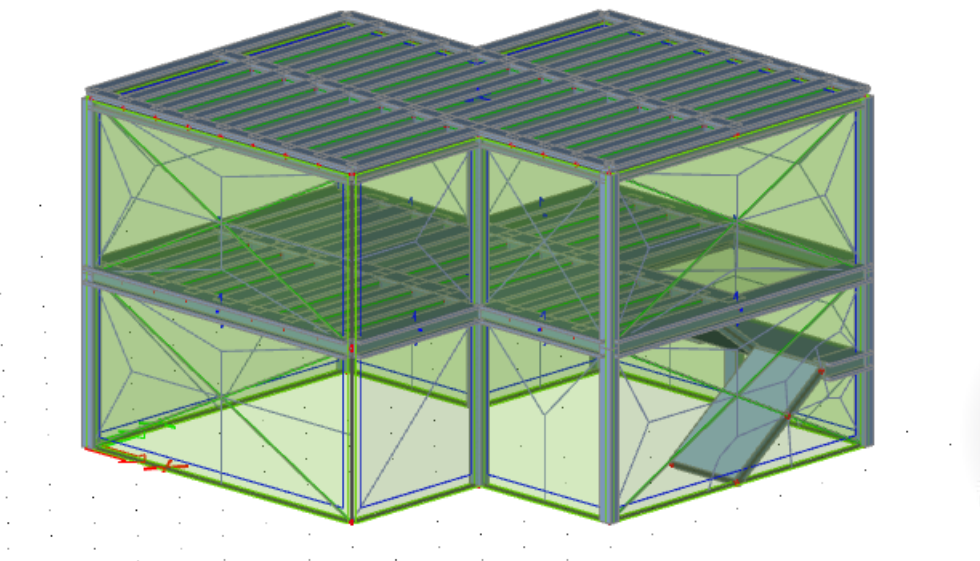

2.2 DODATNO STALNO DJELOVANJE

Opterećenje od ostalih elemenata (slojevi poda, krovni paneli itd.)

Opterećenje ravnog krova:

-sendvič panel	0.20 kN/m ²
-instalacije	0.10 kN/m ²
UKUPNO	0.30 kN /m²

Opterećenje međukatne konstrukcije:

-parket (2 cm)	0.12 kN/m ²
-cementni estrih (4 cm)	0.96 kN/m ²
-stiropor	0.02 kN/m ²
-vlagootporna ploča od iverice (18 mm)	0.11 kN/m ²
-mineralna vuna između greda (20 cm)	0.10 kN/m ²
-drvene grede	uključeno u vlastitu težinu
-vatrootporne gipsane ploče (12.5 mm)	0.09 kN/m ²

UKUPNO

1.4 kN/m²

Stubište: 3 kN/m²

Staklena fasada: 0.25 kN/m²

2.3 UPORABNO DJELOVANJE

Kategorija	Namjena	Primjer
A	Prostori za stanovanje i kućanske djelatnosti	Sobe u stambenim zgradama i kućama, sobe i odjeli u bolnicama; sobe u hotelima i prenoćištima, kuhinje i kupaonice
B	Uredski prostori	
C	Prostori gdje se mogu okupljati ljudi (osim prostora određenih u kategorijama A, B, i D1))	C1: Prostorije sa stolovima i sl., primjerice u školama, kavanama, restoranima, blagovaonicama, čitaonicama, recepcijama C2: Prostori s nepomičnim sjedalima, primjerice u crkvama, kazalištima ili kinima, sobe za sastanke, dvorane za predavanja, dvorane za skupove, željezničke čekaonice i sl. C3: Prostori bez zapreka za kretanje ljudi, primjerice u muzejima, izložbenim prostorima i slično, te pristupi u javnim i upravnim zgradama, hotelima, bolnicama i željezničkim stanicama C4: Prostori gdje su moguće fizičke aktivnosti, primjerice plesne dvorane, gimnastičke dvorane, pozornice C5: Prostori za velika okupljanja ljudi, primjerice u zgradama za javne priredbe kao što su koncertne dvorane, sportske dvorane uključujući gledališta, terase, prilaze i željezničke perone.
D	Prodajni prostori	D1: Prostori u trgovinama D2: Prostori u robnim kućama

Usvojeno opterećenje: $q_k=1.5 \text{ kN/m}^2$ - kategorija A, stambeni prostori

2.4 DJELOVANJE SNIJEGA

$$s=s_k*\mu_i*c_e*c_t \text{ [k N/m}^2\text{]}$$

s_k =karakteristična vrijednost opterećenja na tlu

$s_k=1.25 \text{ kN/m}^2$ za Zagreb, od 100-200 metara nadmorske visine

Opterećenje snijegom preko cijele krovne plohe prema "SCIA Engineer."

Dimenzioniranje drvenog objekta



Nadmorska visina do [m]	1. područje – priobalje i otoci [kN/m ²]	2. područje – zaleđe Dalmacije, Primorja i Istre [kN/m ²]	3. područje – kontinentalna Hrvatska [kN/m ²]	4. područje – gorska Hrvatska [kN/m ²]
100	0,50	0,75	1,00	1,25
200	0,50	0,75	1,25	1,50
300	0,50	0,75	1,50	1,75
400	0,50	1,00	1,75	2,00
500	0,50	1,25	2,00	2,50
600	0,50	1,50	2,25	3,00
700	0,50	2,00	2,50	3,50
800	0,50	2,50	2,75	4,00
900	1,00	3,00	3,00	4,50
1 000	2,00	4,00	3,50	5,00
1 100	3,00	5,00	4,00	5,50
1 200	4,00	6,00	4,50	6,00
1 300	5,00	7,00		7,00
1 400	6,00	8,00		8,00
1 500		9,00		9,00
1 600		10,00		10,00
1 700		11,00		11,00
1 800		12,00		

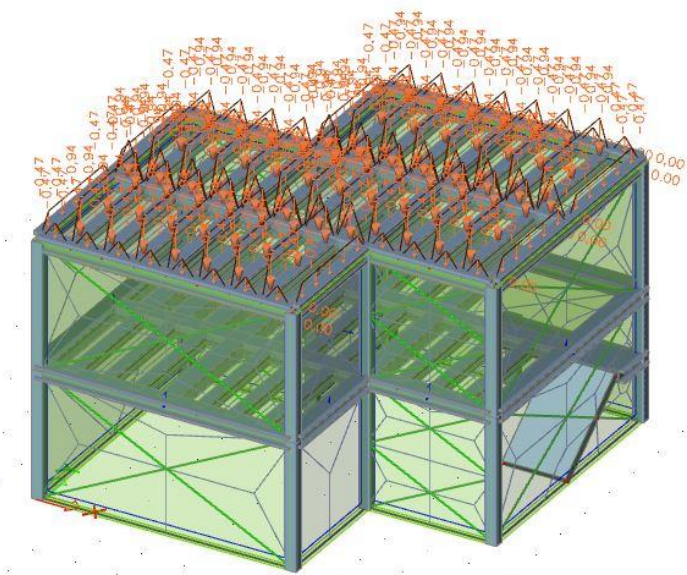

Dimenzioniranje drvenog objekta

2.5 DJELOVANJE VJETRA

Proračun djelovanja vjetra na konstrukciju je izveden u programu "SCIA Engineer" koristeći opciju 3D wind generator prema propisanim Eurocode normama za vjetar.

$w_e = q_{ref} * c_e(z_e) * c_{pe}$ (kN/m²) – pritisak vjetra na vanjske površine

$w_i = q_{ref} * c_i(z_i) * c_{pi}$ (kN/m²) – pritisak vjetra na unutarnje površine

q_{ref} => referentni pritisak srednje brzine vjetra

$c_e(z_e), c_i(z_i)$ => koeficijenti izloženosti koji uzimaju u obzir neravnine terena

z_e, z_i => referentne visine za lokalni ili unutarnji tlak

c_{pe}, c_{pi} => vanjski i unutarnji koeficijenti pritiska

Proračun referentnog pritiska vjetra q_{ref} :

v_{ref} => referentna brzina

$v_{ref,0} = 20$ m/s za područje III, Zagreb, do 100m nadmorske visine

$v_{ref} = C_{DIR} * C_{TEM} * C_{ALT} * v_{ref,0}$

$v_{ref,0}$ => osnovna poredbena brzina vjetra

C_{DIR} => koeficijent smjera vjetra

$C_{DIR} = 1,0$

C_{TEM} => koeficijent ovisan o godišnjem dobu

$C_{TEM} = 1,0$

ρ => gustoća zraka

$\rho = 1.25$ kg/m³

3.0 PRORAČUN KONSTRUKCIJE

3.1 KOMBINACIJA

Proračun konstrukcije izvršen je u programskom paketu Scia Enginner sa prostornim modelom konstrukcije prema najkritičnijoj kombinaciji.

Contents of combination	
vlastita tezina - Self weight ...	1.35
dodatno stalno [-]	1.35
snijeg [-]	1.50
Uporabno opterećenje [-]	1.05
3DWind1 - 0, + CPE, + CPI [-]	0.90
3DWind2 - 0, + CPE, - CPI [-]	0.90
3DWind3 - 0, - CPE, + CPI [-]	0.90
3DWind4 - 0, - CPE, - CPI [-]	0.90
3DWind5 - 90, + CPE, + CPI ...	0.90
3DWind6 - 90, + CPE, - CPI ...	0.90
3DWind7 - 90, - CPE, + CPI ...	0.90
3DWind8 - 90, - CPE, - CPI [-]	0.90
3DWind9 - 180, + CPE, + CP...	0.90
3DWind10 - 180, + CPE, - C...	0.90
3DWind11 - 180, - CPE, + C...	0.90
3DWind12 - 180, - CPE, - CP...	0.90
3DWind13 - 270, + CPE, + C...	0.90
3DWind14 - 270, + CPE, - C...	0.90

Contents of combination	
vlastita tezina - Self weight ...	1.35
dodatno stalno [-]	1.35
snijeg [-]	0.75
Uporabno opterećenje [-]	1.50
3DWind1 - 0, + CPE, + CPI [-]	0.90
3DWind2 - 0, + CPE, - CPI [-]	0.90
3DWind3 - 0, - CPE, + CPI [-]	0.90
3DWind4 - 0, - CPE, - CPI [-]	0.90
3DWind5 - 90, + CPE, + CPI ...	0.90
3DWind6 - 90, + CPE, - CPI ...	0.90
3DWind7 - 90, - CPE, + CPI ...	0.90
3DWind8 - 90, - CPE, - CPI [-]	0.90
3DWind9 - 180, + CPE, + CP...	0.90
3DWind10 - 180, + CPE, - C...	0.90
3DWind11 - 180, - CPE, + C...	0.90
3DWind12 - 180, - CPE, - CP...	0.90
3DWind13 - 270, + CPE, + C...	0.90
3DWind14 - 270, + CPE, - C...	0.90

Najkritičnija kombinacija prema SCII je:

$1,35 \cdot \text{vlastita težina} + 1,35 \cdot \text{dodatno stano opterećenje} + 1,50 \cdot \text{uporabno opterećenje} + 0,90 \cdot 3D$
 Wind

4. DIMENZIONIRANJE ELEMENATA KONSTRUKCIJE

4.1 POMACI KONSTRUKCIJE

VERTIKALNI POMAK

$$U_z = 20,2 \text{ mm}$$

$$\begin{aligned} U_{g,fin} &= U_{g,inst}(1+0,8) \\ &= 0,202*(1+0,8) \\ &= 0,36 \text{ cm} \end{aligned}$$

Dopušteni vertikalni pomak:

$$\begin{aligned} U_{dop} &= \frac{l}{200} = \frac{9*1000}{200} \\ &= 45 \text{ mm} \end{aligned}$$

$$U_z = 36 \text{ mm} < U_{z,dop} = 45 \text{ mm} \quad \text{Zadovoljava}$$

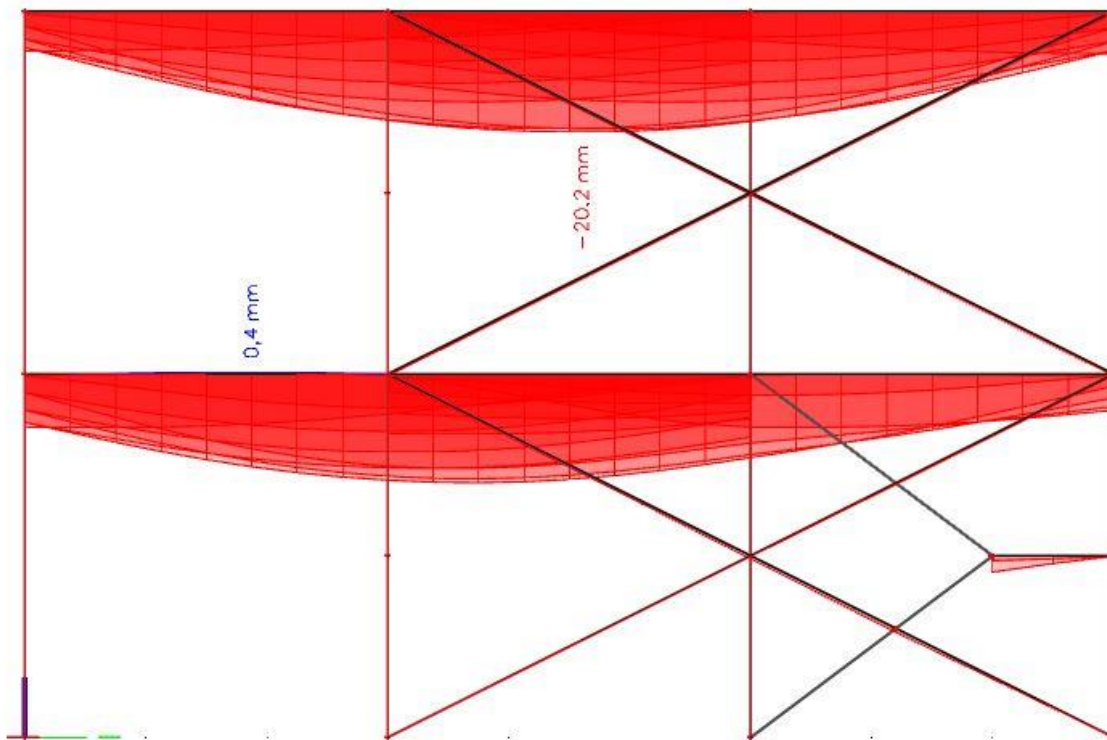

Prikaz vertikalnog pomaka

HORIZONTALNI POMAK

Dimenzioniranje drvenog objekta

Horizontalni pomak: $u_x = 6,8 \text{ mm}$

$$\begin{aligned} u_{G,fin} &= u_{G,inst} \cdot (1 + k_{def}) \\ &= 6,8 \cdot (1 + 0) \\ &= 6,8 \text{ mm} \end{aligned}$$

Dopušteni horizontalni pomak :

$$\begin{aligned} u_{dop} &= \frac{h}{200} = \frac{6 \cdot 1000}{200} = \\ &= 30 \text{ mm} \end{aligned}$$

$6,8 \text{ mm} < 30 \text{ mm}$

Zadovoljava

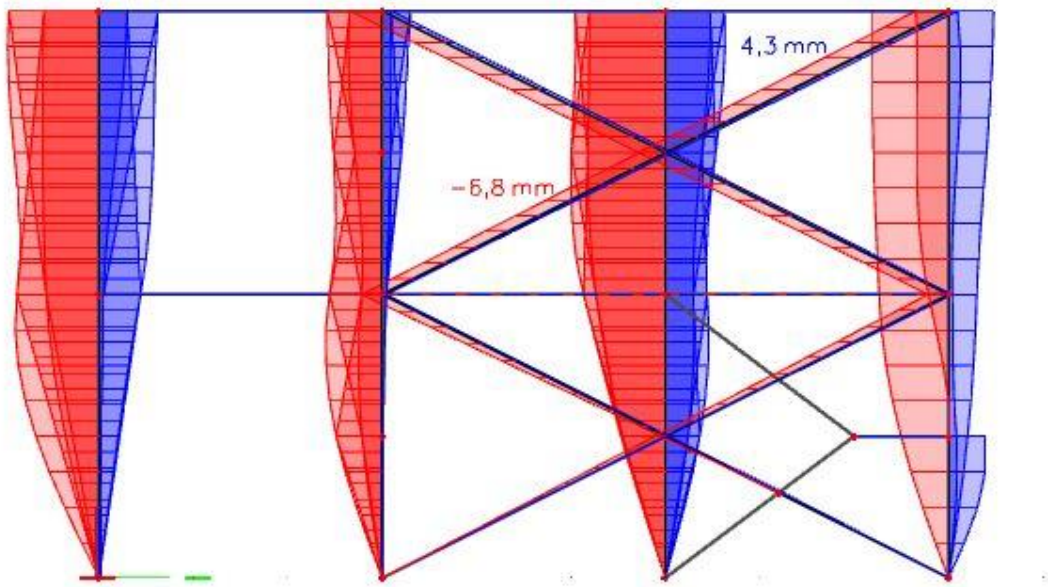

Prikaz horizontalnog pomaka

4.2 DIMENZIONIRANJE GLAVNIH KROVNIH GREDA- POZICIJA 1

Dimenzioniranje drvenog objekta

Dimenzioniranje konstrukcijskih elemenata je provedena softverom Scia Engineer pomoću modula Timber.

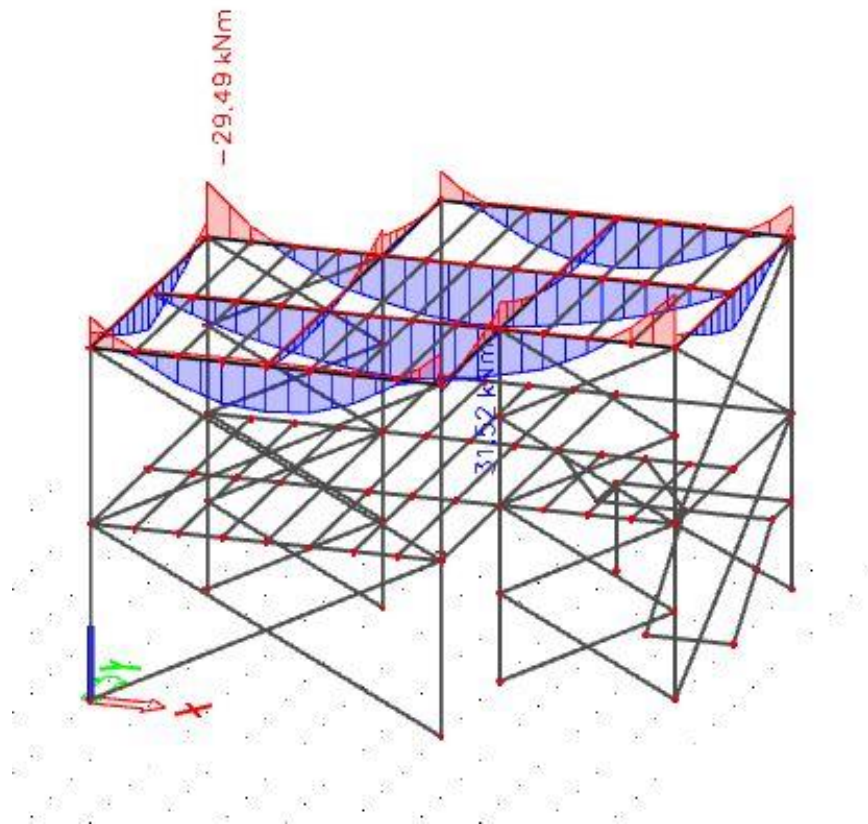

Dijagram momenata savijanja M_y

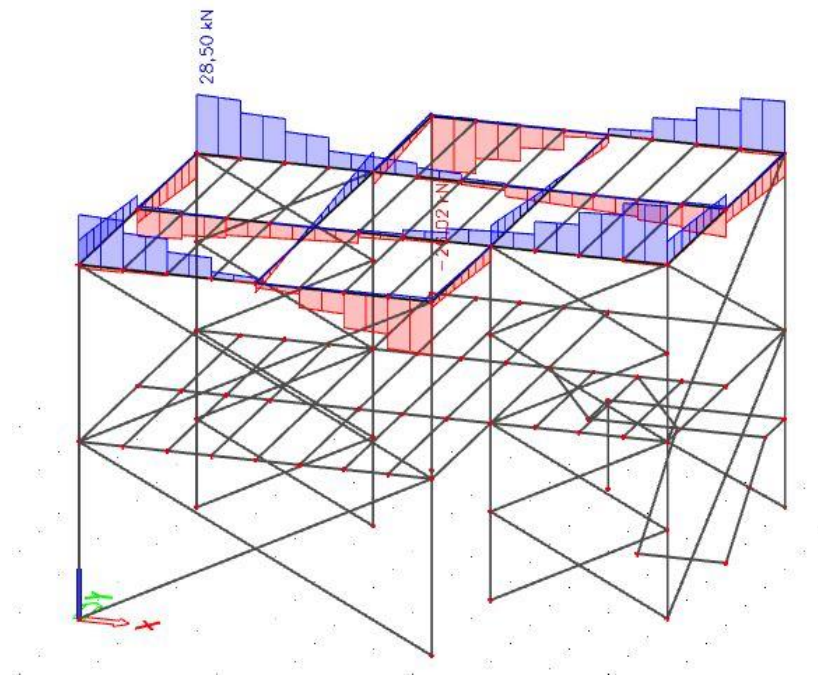

Dijagram poprečnih sila V_z

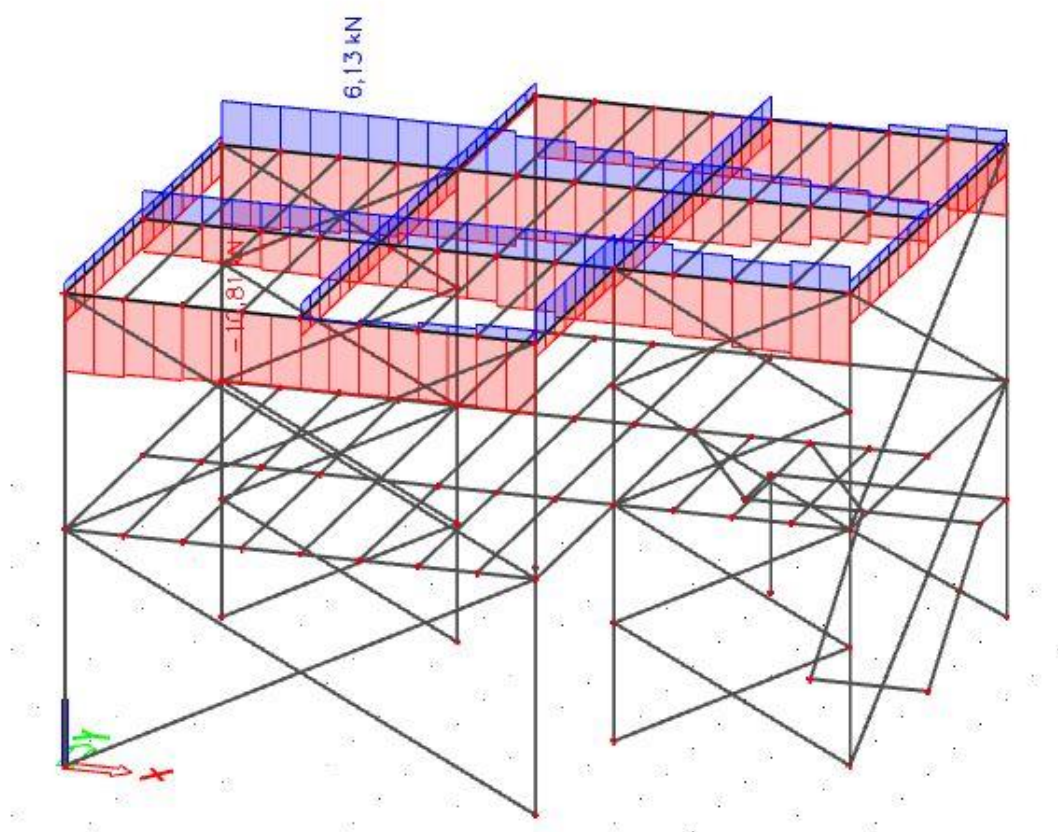

Dijagram uzdužnih sila

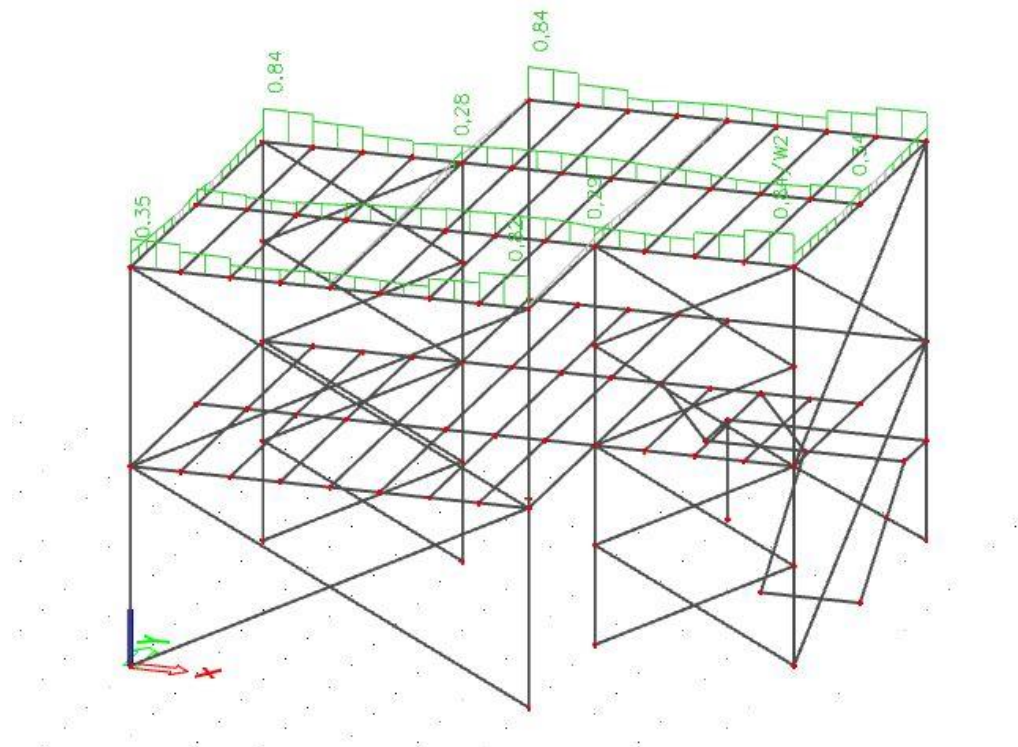

Prikaz iskoristivosti glavnih krovnih greda

4.3 DIMENZIONIRANJE SEKUNDARNIH KROVNIH GREDA- POZICIJA 2

Dimenzioniranje drvenog objekta

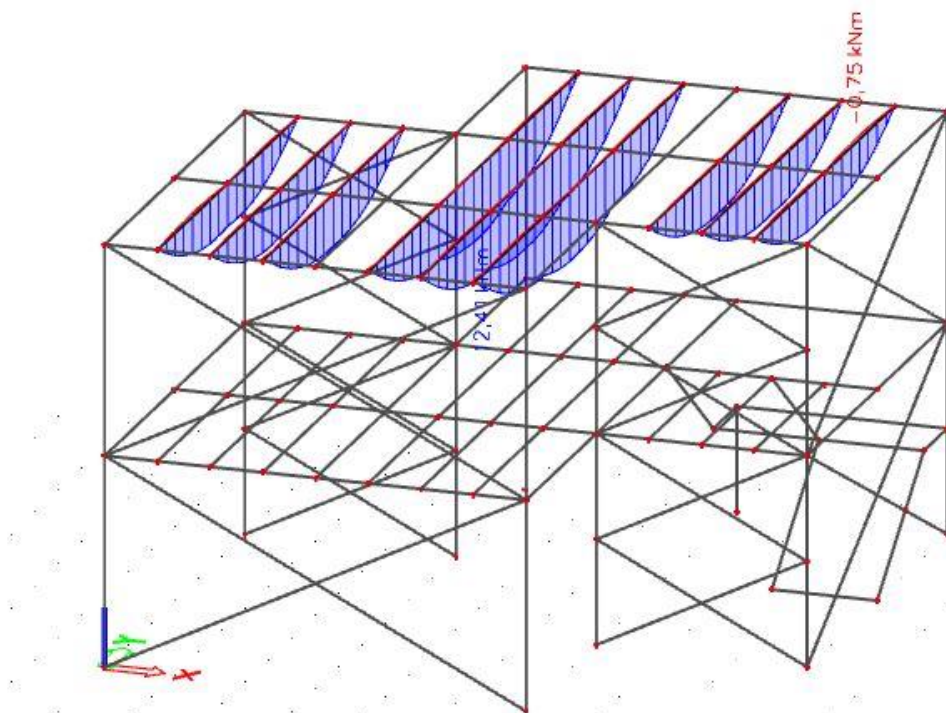

Dijagram momenata savijanja

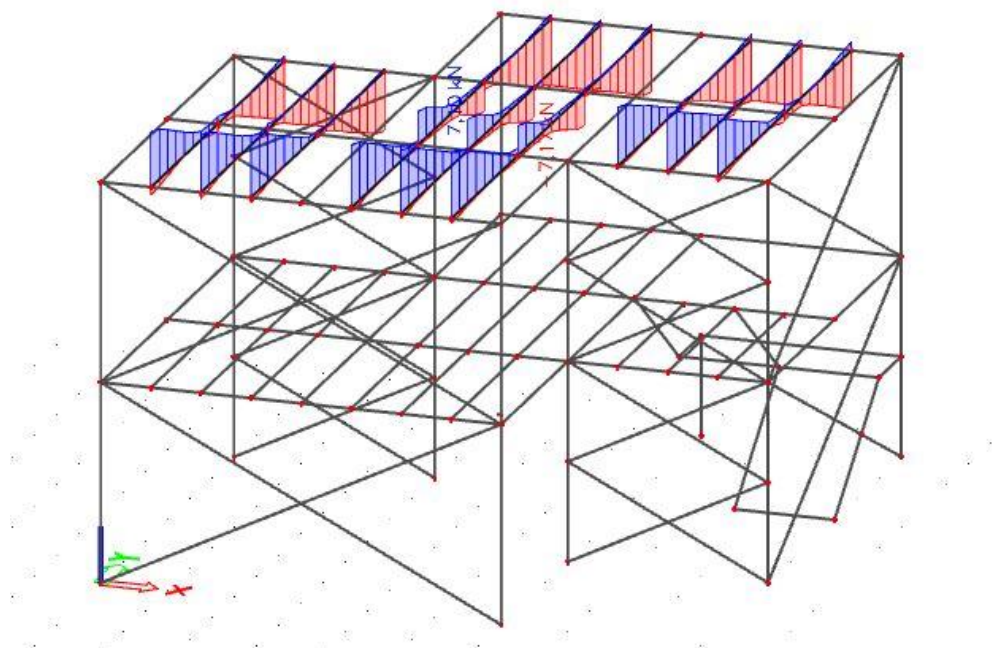

Dijagram poprečnih sila

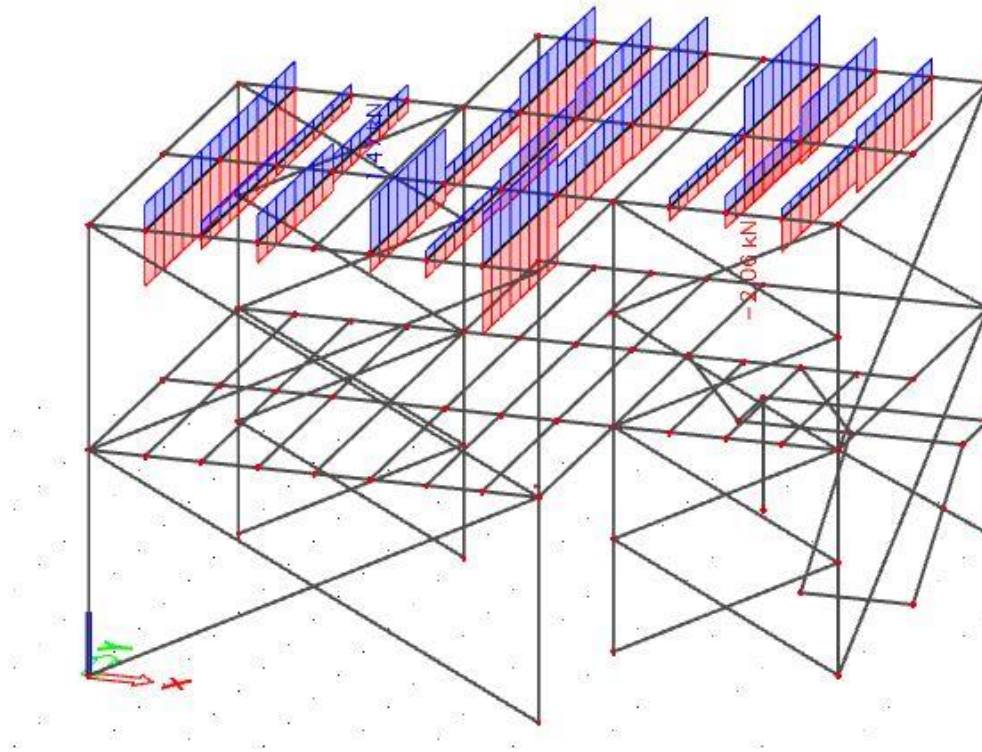

Dijagram uzdužnih sila

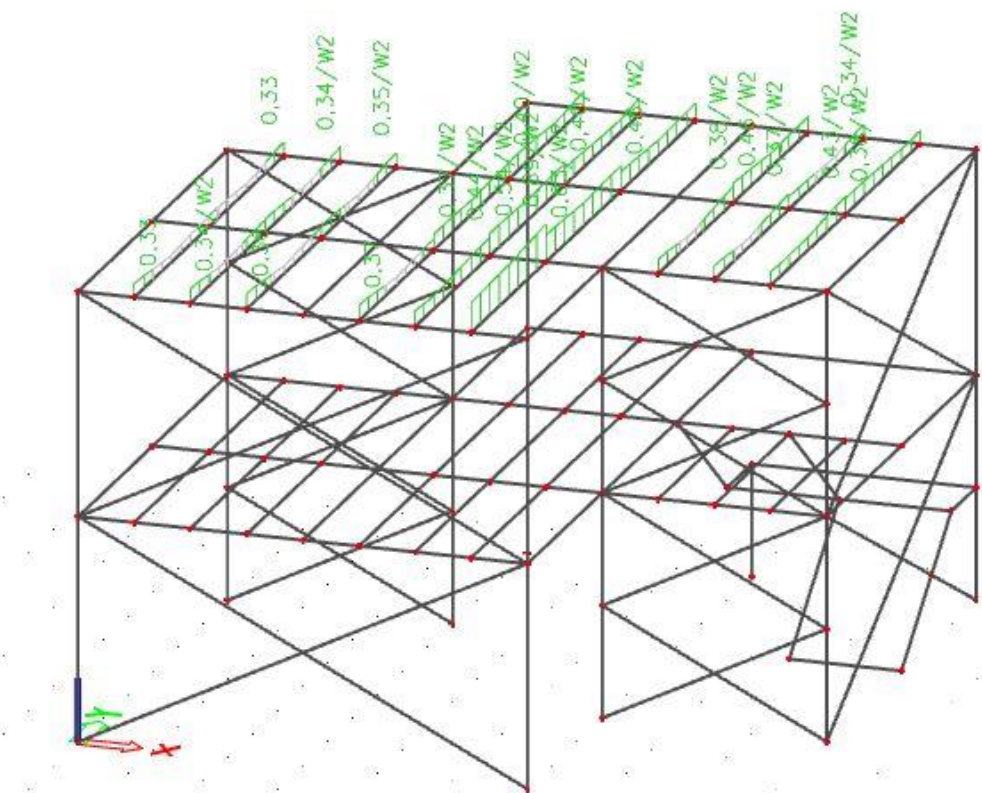

Prikaz iskoristivosti sporednih krovnih greda

4.4 DIMENZIONIRANJE GLAVNIH MEĐUKATNIH GREDA- POZICIJA 3

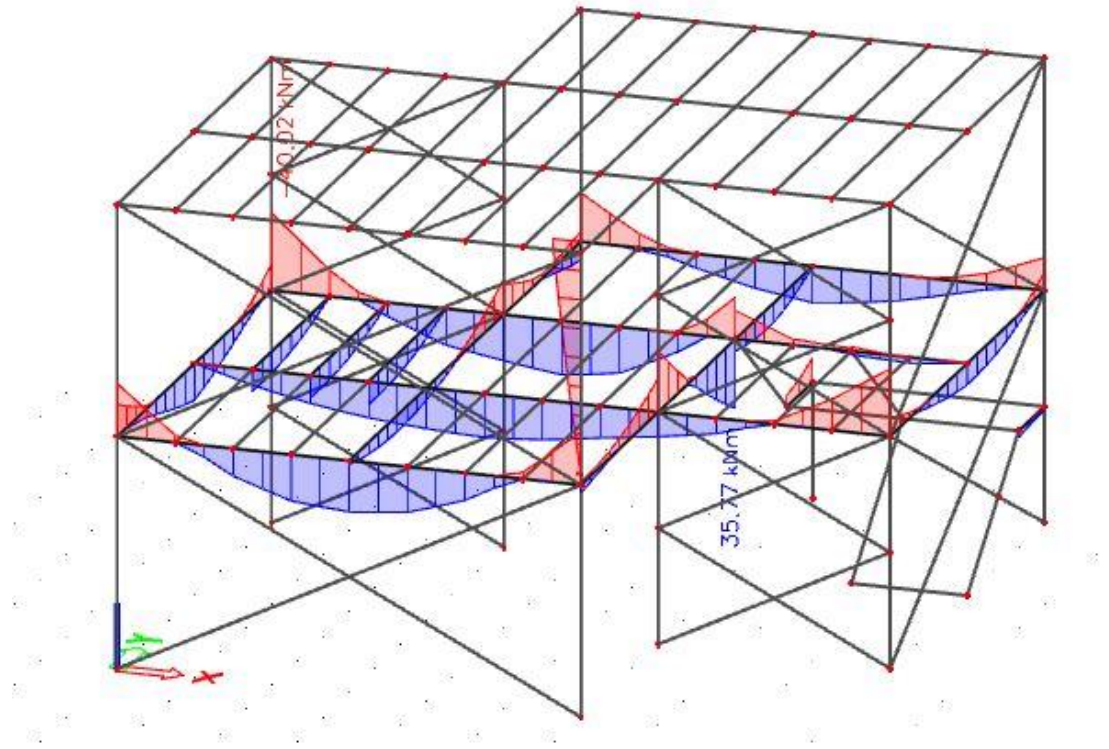

Dijagram momenata savijanja

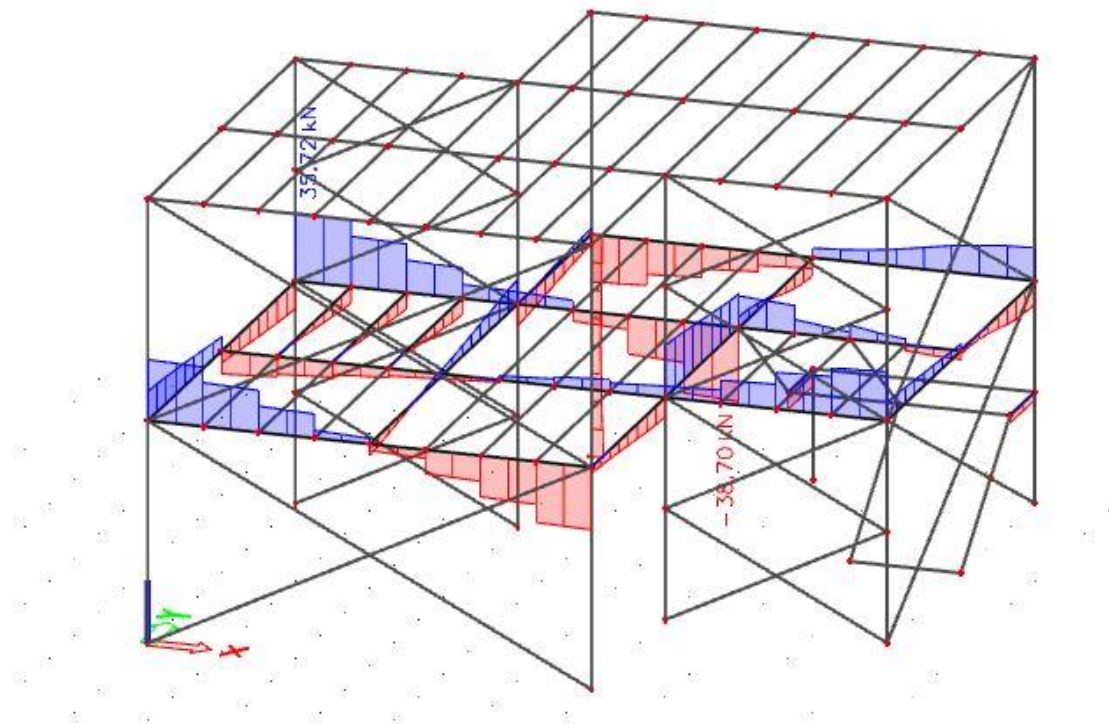

Dijagram poprečnih sila

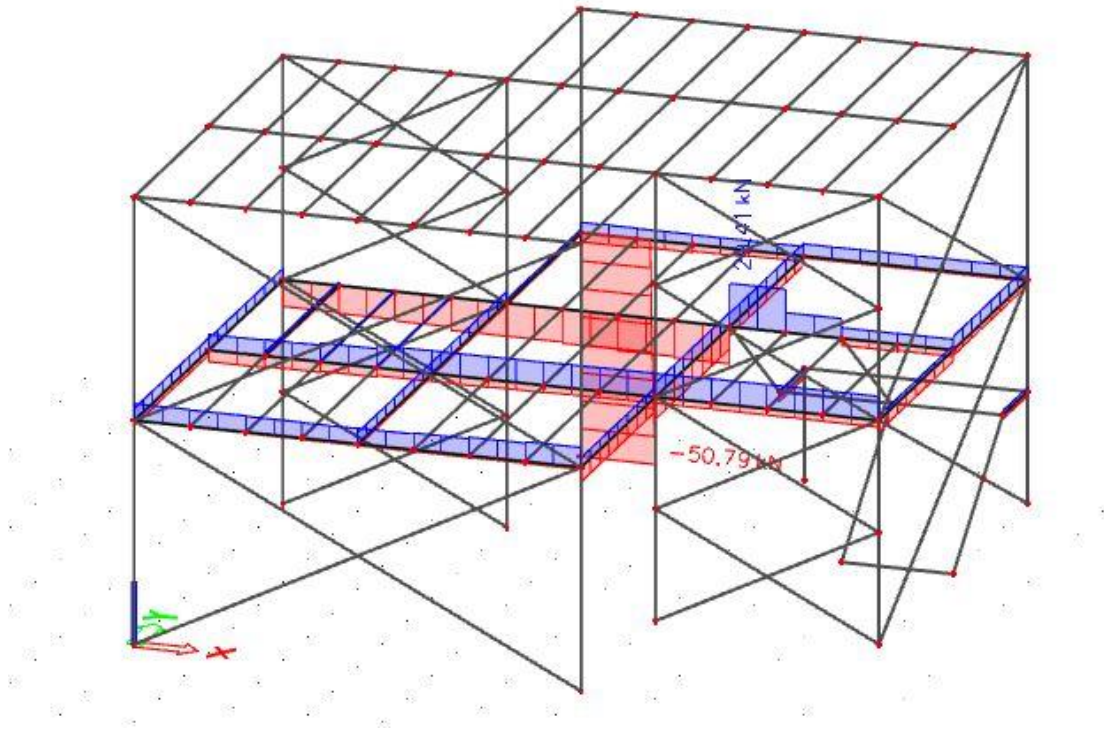

Dijagram uzdužnih sila

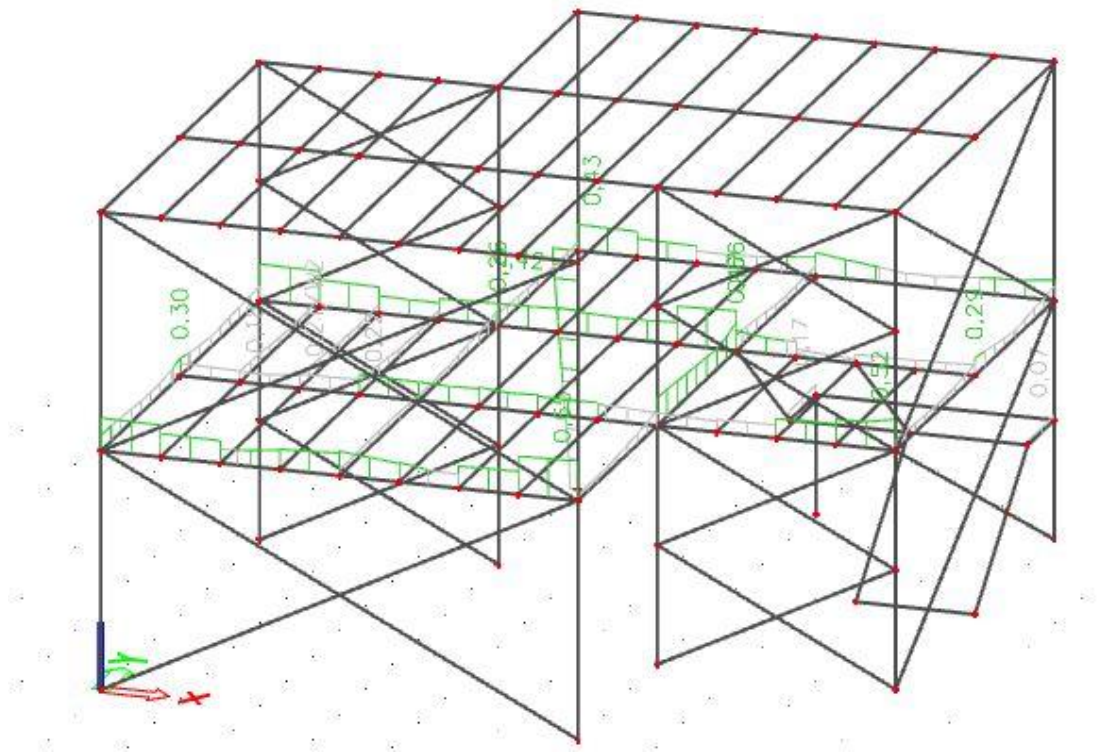

Prikaz iskoristivosti glavnih međukatnih greda

4.5 DIMENZIONIRANJE SEKUNDARNIH MEĐUKATNIH GREDA- POZICIJA 4

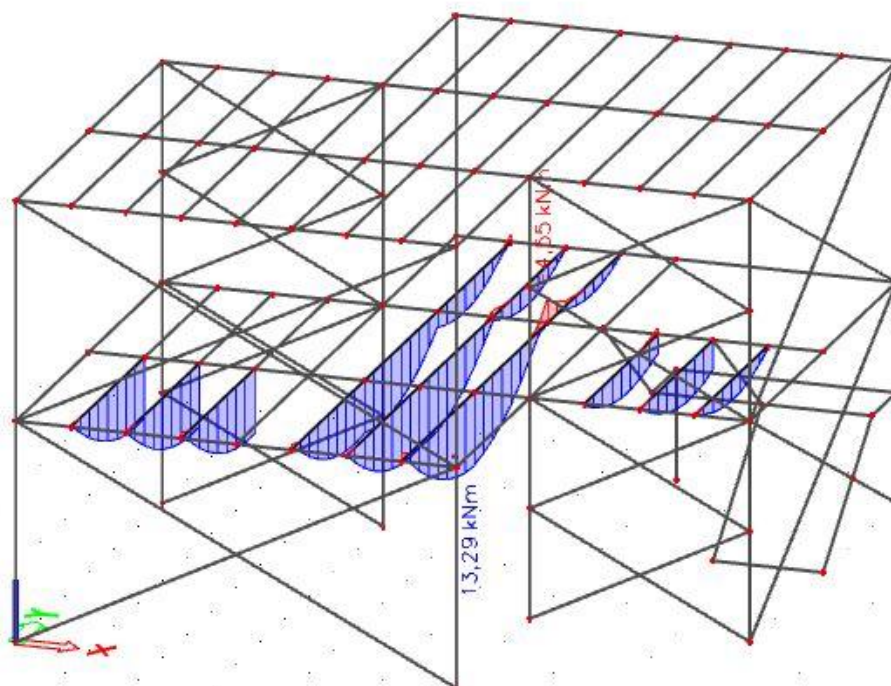

Dijagram momenata savijanja

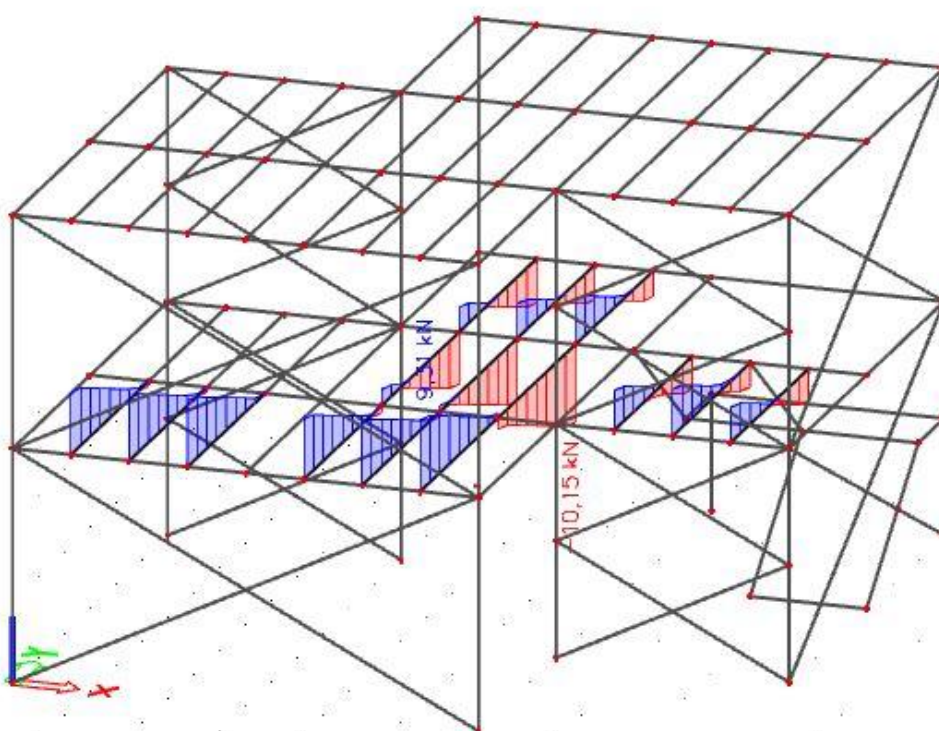

Dijagram poprečnih sila

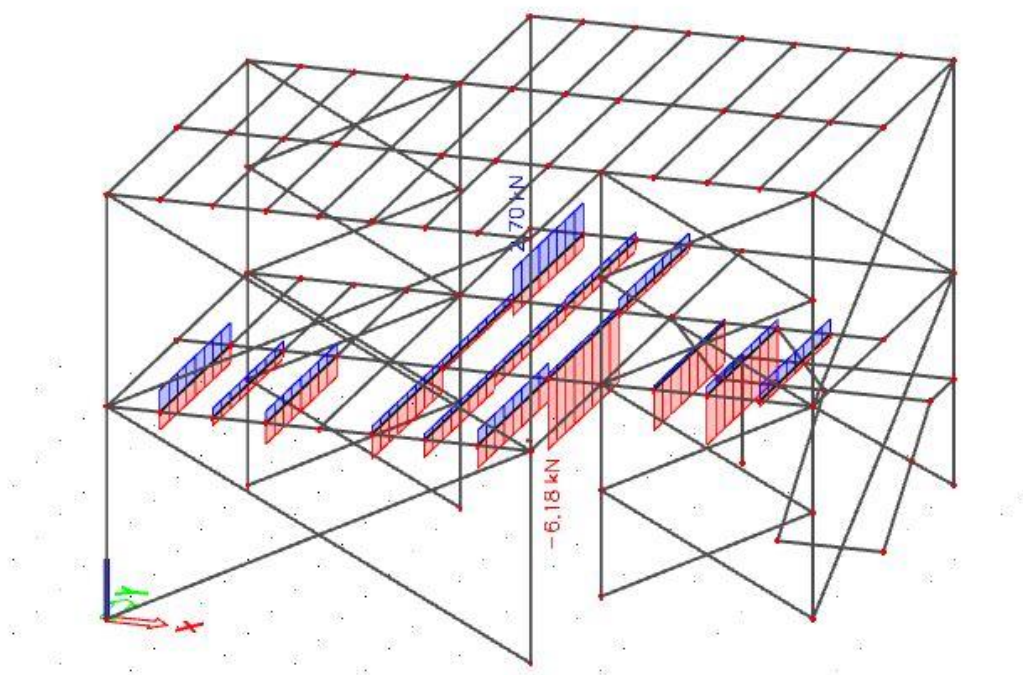

Dijagram uzdužnih sila

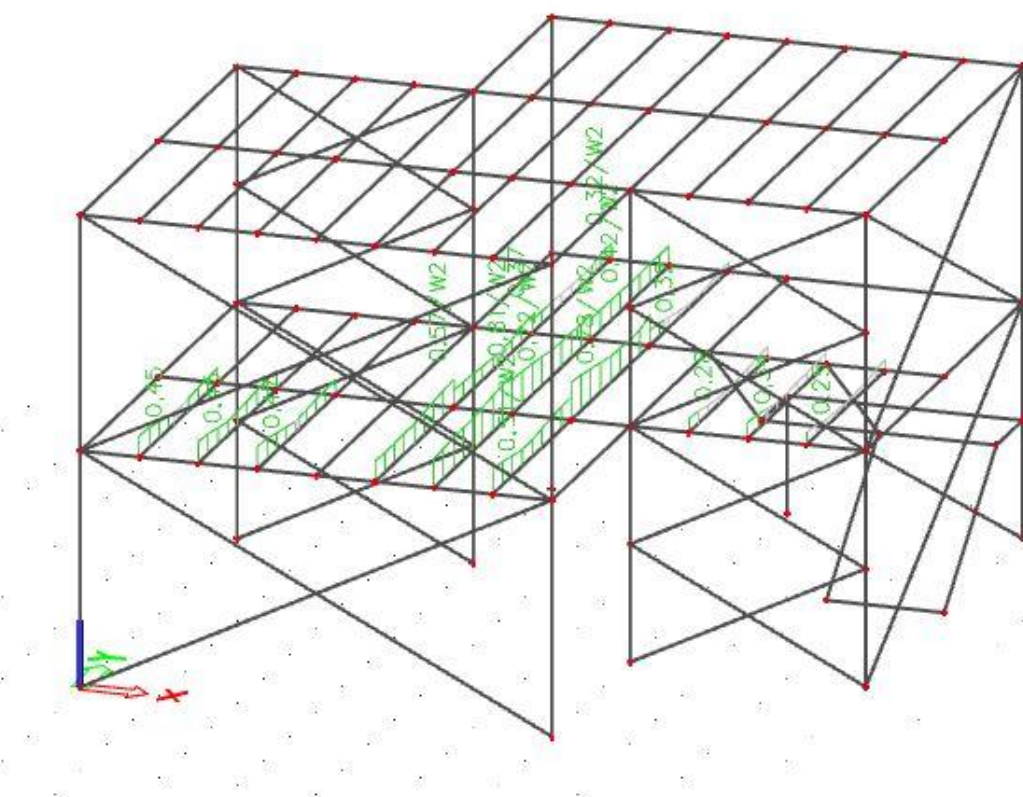

Prikaz iskoristivosti sporednih međukatnih greda

4.6 DIMENZIONIRANJE STUPOVA- POZICIJA 5

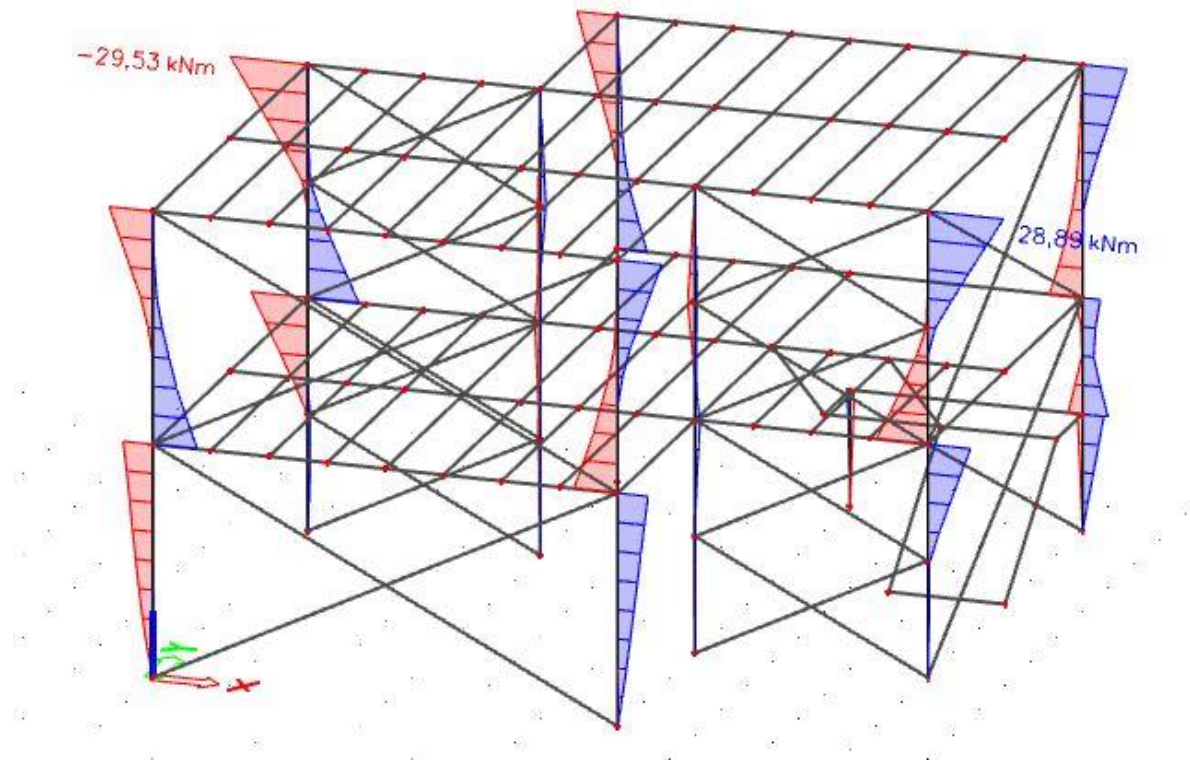

Dijagram momenata savijanja

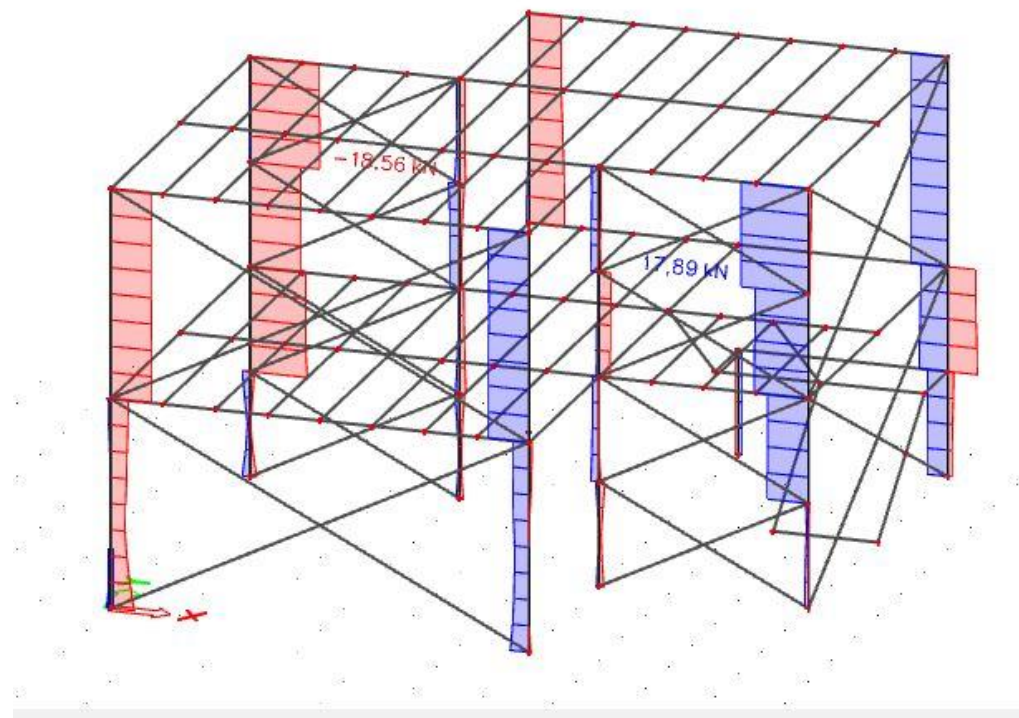

Dijagram poprečnih sila

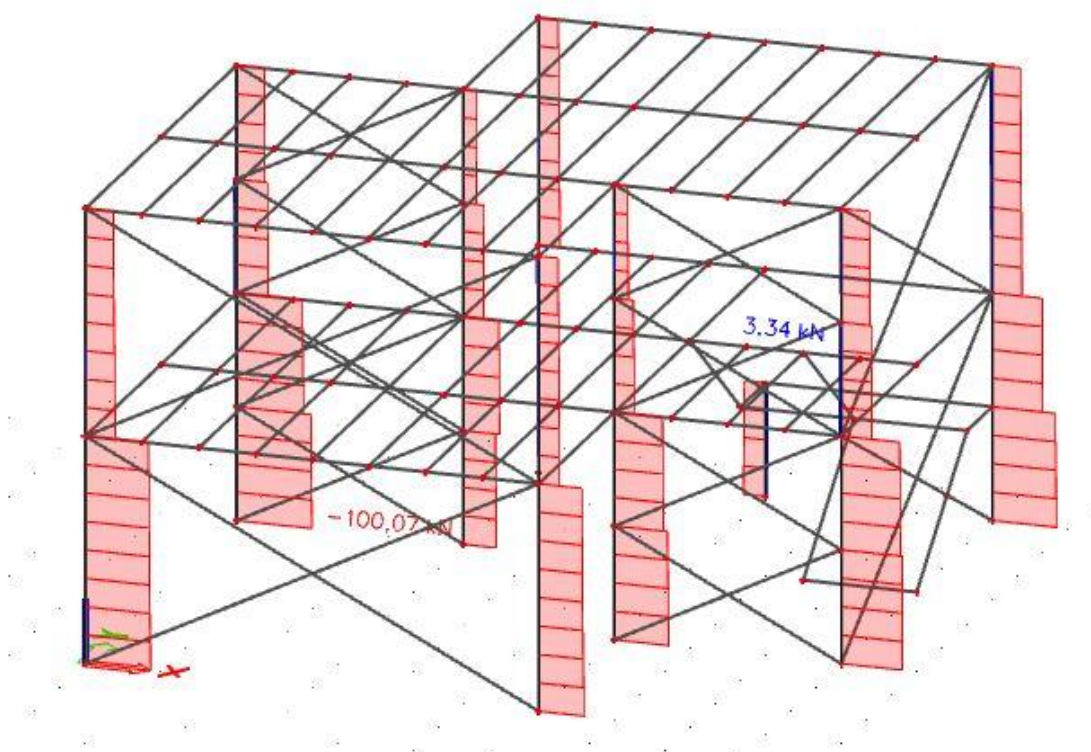

Dijagram uzdužnih sila

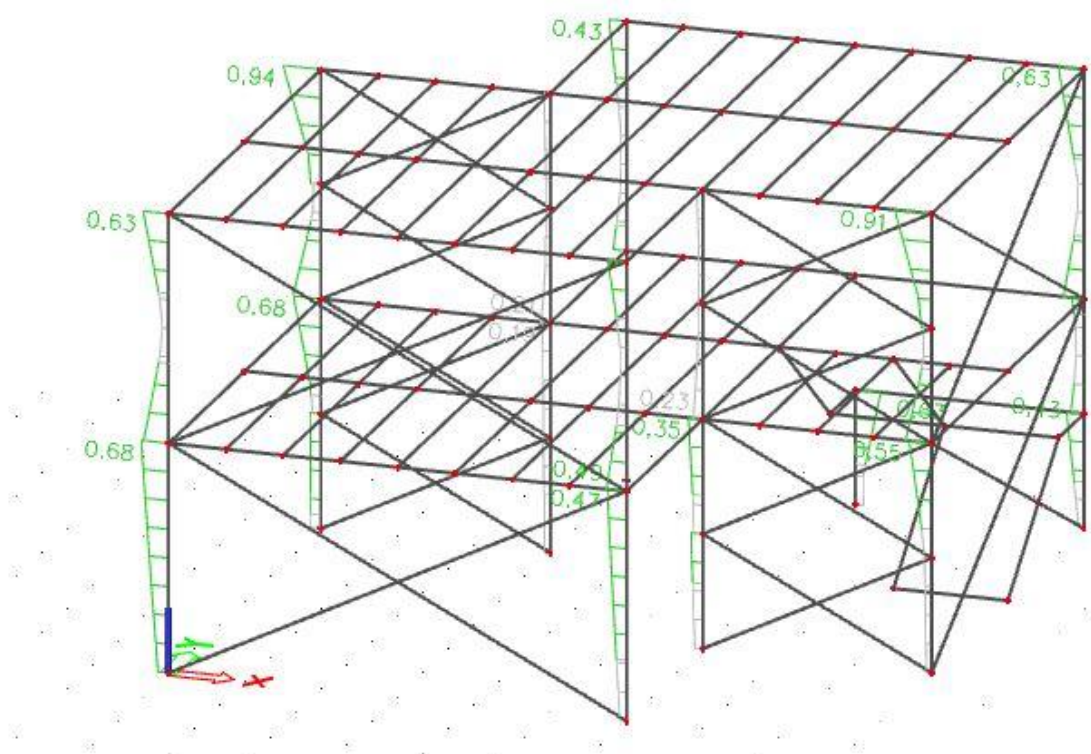

Prikaz iskoristivosti stupova

4.7 DIMENZIONIRANJE SPPREGOVA-POZICIJA 7

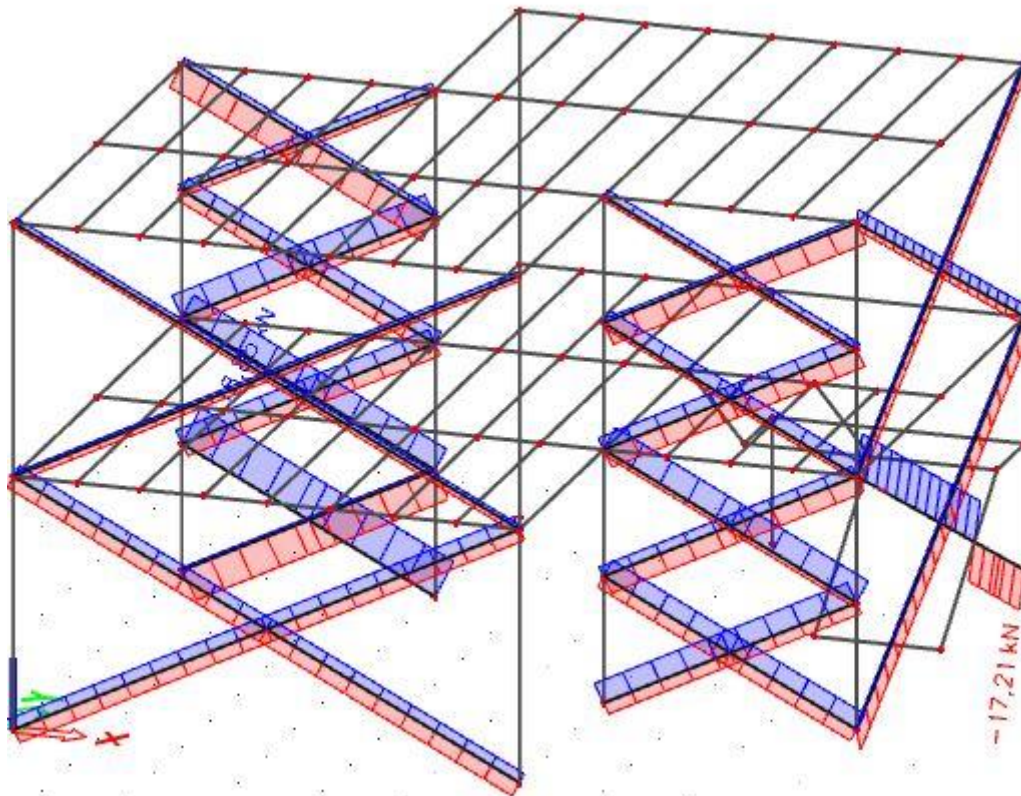

Dijagram uzdužnih sila u spregovima

Oabrano RD16, S235

$$A=2,0096 \cdot 10^{-4} \text{ m}^2$$

$$\frac{A \cdot f_y}{\gamma_{M0}} = \frac{2,0096 \cdot 23,5}{1,0} = 47,23 \text{ kN}$$

$$18,85 < 47,23 \quad \text{Zadovoljava}$$

5.0 SPOJEVI

5.1 SPOJ STUP GREDA

$$MEd = 29,04 \text{ kNm}$$

$$NEd = 15,08 \text{ kN}$$

$$VEd = 34,53 \text{ kN}$$

Spoj je izveden čeličnom papučom: GH04 140x160

-posebni čavli s utorima 14H 4x6 mm

-kmod=0,8 (srednje trajno djelovanje, za C24, uporabna klasa 2)

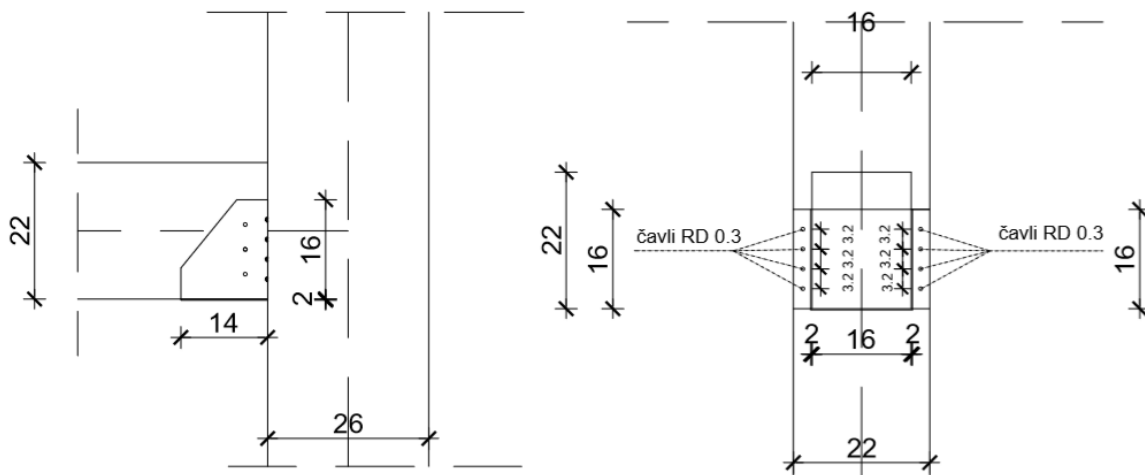

$$FM,V = \frac{MEd \cdot x_{max}}{n_c \cdot \sum (x_i^2 + y_i^2)} = \frac{29,04 \cdot 0}{1 \cdot \sum (0 + 6^2)} = 0$$

$$FM,H = \frac{29,04 \cdot 6}{n_c \cdot \sum (0 + 6^2)} = 4,84$$

$$FW = \sqrt{\left(F_{MV} + \frac{NEd}{n_c \cdot n}\right)^2 + \left(F_{MH} + \frac{VEd}{n_c \cdot n}\right)^2} = \sqrt{\left(0,0 + \frac{15,08}{1 \cdot 3}\right)^2 + \left(4,84 + \frac{34,53}{1 \cdot 3}\right)^2} = 17,11 \text{ kN}$$

Rd=1,17 za duljinu čavla 60mm.

R0,d=ns*Rd=14*1,17=16,4 kN, za ns=2*7=14 i GH 04 140x160 (prema tablicama)

Dimenzioniranje drvenog objekta

Geometrija papuče				Posebni čavli	Broj čavala			R _{o,d} u kN		
B x H mm x mm	A mm	B* mm	H* mm	d x l mm x mm	n _G	n _S	c	k _{mod}		
								0,6	0,8	0,9
GH 04										
60 x 100*	136	79	60	4,0 x 40	14	8	0,4	7,13	8,9	9,79
80 x 100		119	60		14	8	0,4	8,1	9,36	9,93
80 x 120	158	120	80	4,0 x 50	18	10	0,4	10,1	11,7	12,4
80 x 140		120	100		22	12	0,4	12,1	14,0	14,9
100 x 120		146	80		18	10	0,4	10,1	11,7	12,4
100 x 140	184	146	100	4,0 x 50	22	12	0,4	12,1	14,0	14,9
100 x 160		146	120		26	14	0,4	14,2	16,4	17,4
120 x 140		166	100		22	12	0,4	12,1	14,0	14,9
120 x 160	204	166	120	4,0 x 50 - 60	26	14	0,4	14,2	16,4	17,4
120 x 180		166	140		30	16	0,4	16,2	18,7	19,8
140 x 160		186	120		26	14	0,4	14,2	16,4	17,4
140 x 180	224	186	140	4,0 x 50 - 60	30	16	0,4	16,2	18,7	19,8

Dokaz nosivosti na poprečni vlak u glavnom nosaču na dijelu priključka čeličnom papučom:

$$f = \frac{1}{(1 - 0,93 \cdot \frac{be}{HG})} = \frac{1}{(1 - 0,93 \cdot \frac{160}{220})} = 3,1$$

-dubina zabijanja čavla u glavni nosač usvojene je vrijednosti $t_{ef,max}$

$$t_{ef} = l - t = 60 - 2 = 58mm > 48mm = t_{ef,max}$$

-prema tablici

$$B^* = 186 \text{ mm}$$

$$H^* = 120 \text{ mm}$$

$$f_{t,90,d} = k_{mod} \cdot \frac{f_{t,90,k}}{\gamma_M} = 0,8 \cdot \frac{0,4}{1,3} = 0,246 \text{ N/mm}^2$$

$$\begin{aligned} R_{t,90,d} &= 5,5 \cdot f \cdot t_{ef}^{0,8} \cdot (HG + 4 \cdot \sqrt{B^* \cdot H^*})^{0,8} \cdot f_{t,90,d} = \\ &= 5,5 \cdot 3,1 \cdot 48^{0,8} \cdot (220 + 4 \cdot \sqrt{186 \cdot 120})^{0,8} \cdot 0,246 \cdot 10^{-3} = \\ &= 19,85 \text{ kN} \end{aligned}$$

-Dokaz nosivosti treba provesti s najmanjom vrijednosti nosivosti (mjerodavna)

$$\frac{F_w}{R_{t,90,d}} = \frac{17,11}{19,85} = 0,86 < 1$$

5.2 SPOJ STUP TEMELJ

$$MEd = 0,00 \text{ kNm}$$

$$NEd = 100,07 \text{ kN}$$

$$VEd = 1,5 \text{ kN}$$

Proračun vijaka u spju

Spoj je dvorezan $n_c=2$. Pretpostavljen je broj vijaka $n = 8$ promjera $d = 20 \text{ mm}$ (klasa 5.8).

Proračun sila u najkritičnijem spoju

$$FM,V = \frac{MEd \cdot x_{max}}{n_c \cdot \sum (x_i^2 + y_i^2)} = 0 \text{ kN}$$

$$FM,H = \frac{MEd \cdot y_{max}}{n_c \cdot \sum (x_i^2 + y_i^2)} = 0 \text{ kN}$$

$$FW = \sqrt{\left(F_{MV} + \frac{NEd}{n_c \cdot n}\right)^2 + \left(F_{MH} + \frac{VEd}{n_c \cdot n}\right)^2} = \sqrt{\left(0,0 + \frac{100,07}{2 \cdot 8}\right)^2 + \left(0,0 + \frac{1,5}{2 \cdot 8}\right)^2} = 6,26 \text{ kN}$$

$$\alpha = \alpha \tan\left(\frac{F_{MH} + \frac{VEd}{n_c \cdot n}}{F_{MV} + \frac{NEd}{n_c \cdot n}}\right) = \alpha \tan\left(\frac{0,00 + \frac{1,5}{2 \cdot 8}}{0,00 + \frac{100,07}{2 \cdot 8}}\right) = \alpha \tan 0,01499 = 0,86^\circ$$

Vijci su klase 5.8:

$$f_{uk} = 500 \text{ MPa}$$

$$d = 20 \text{ mm}$$

$$M_{y,Rk} = 0,3 \cdot f_{uk} \cdot d \cdot 2,6 = 0,3 \cdot 500 \cdot 20 \cdot 2,6 = 362100 \text{ Nmm}$$

$$\rho_k = 350 \frac{\text{kg}}{\text{m}^3}$$

$$f_{h,0,k} = 0,082 \cdot (1 - 0,01d) \cdot \rho_k = 0,082 \cdot (1 - 0,01 \cdot 20) \cdot 350 = 23 \frac{\text{N}}{\text{mm}^2}$$

$$k_{90} = 1,35 + 0,015d = 1,35 + 0,015 \cdot 20 = 1,65$$

$$f_{h,\alpha,k} = \frac{f_{h,0,k}}{k_{90} \cdot \sin(\alpha)^2 + \cos(\alpha)^2} = \frac{23}{1,65 \cdot \sin(0,86)^2 + \cos(0,86)^2} = 23 \text{ MPa}$$

t- debljina lima

Dimenzioniranje drvenog objekta

$$t = 20 \text{ mm}$$

Vlačna čvrstoća vijaka u skladu s EK5 standardom treba uzeti kao manju vrijednost

a) vlačna čvrstoća vijka

$$f_{uk} \cdot A_s = 500 \cdot 245 = 122,5 \text{ kN}$$

b) nosivost ploče

$$d_w = \min(4d, 12t) = \min(4 \cdot 20; 12 \cdot 20) = 80 \text{ mm}$$

$$3 \cdot f_{c90k} \cdot \frac{\pi}{4} \cdot (d_w^2 - (d + 1 \text{ mm})^2) = 3 \cdot 2,7 \cdot \frac{\pi}{4} \cdot (80^2 - (20 + 1 \text{ mm})^2) = 37,91 \text{ kN}$$

$$f_{c90k} = 2,7 \text{ MPa}$$

c) Konačna vlačna čvrstoća:

$$f_{uk} \cdot A_s = 122,5 \text{ kN}$$

Čvrstoća na čupanje vijka

$$F_{ax,Rk} = 37,91 \text{ kN}$$

Karakteristična nosivost u ravni smicanja

$$F_{v,Rk} = \min \left\{ \begin{array}{l} 0,5 \cdot f_{h,2,k} \cdot t_2 \cdot d = 0,5 \cdot 23 \cdot 25 \cdot 2 = 57,5 \text{ kN} \\ 2,3 \cdot \sqrt{2 \cdot M_{y,Rk} \cdot f_{h,2,k} \cdot d} + \frac{F_{ax,Rk}}{4} = 2,3 \cdot \sqrt{2 \cdot 362100 \cdot 23 \cdot 20} + \frac{37,91}{4} \end{array} \right.$$

$$= 41,98 \text{ kN}$$

$$F_{v,Rk} = 41,98 \text{ kN}$$

$$b) \frac{\frac{F_{ax,Rk}}{4}}{2,3 \cdot \sqrt{2 \cdot M_{y,Rk} \cdot f_{h,2,k} \cdot d}} = \frac{\frac{37,91}{4}}{2,3 \cdot \sqrt{2 \cdot 362100 \cdot 23 \cdot 20}} = 0,23 < 0,25$$

$$F_{v,Rk} = 41,98 \text{ kN}$$

Proračunska čvrstoća vijka

$$k_{mod} = 0,8$$

$$\gamma_M = 1,3$$

$$F_{v,Rd} = k_{mod} \cdot \frac{F_{v,Rk}}{\gamma_M} = 0,8 \cdot \frac{41,98}{1,3} = 25,83 \text{ kN}$$

Proračun efektivnog broja vijaka u spoju

Dimenzioniranje drvenog objekta

Minimalna udaljenost vijaka:

$$a_{min} = 4 \cdot d = 4 \cdot 2 = 8 \text{ cm}$$

Broj vijaka postavljenih paralelno s vlakancima:

$$n_{ef} = n^{0,9} \cdot \sqrt{\frac{a_1}{13d}} = 8^{0,9} \cdot \sqrt{\frac{10}{132}} = 5,12$$

Broj vijaka postavljenih okomito na vlakanca:

$$n_{ef} = n = 8$$

Interpolacijom se dobije:

$$n_{ef,fin} = 6,56$$

Konačna nosivost vijka

$$F_{v,Rd,fin} = \frac{F_{v,Rd} \cdot n_{ef,fin}}{n} = \frac{25,83 \cdot 6,56}{8} = 21,2 \text{ kN}$$

Kontrola najopterećenijeg spoja:

$$\frac{F_w}{F_{v,Rd,fin}} = \frac{6,26}{21,2} = 0,30 < 1$$

6. PRORAČUN TEMELJA

Proračun dimenzija temelja samca.

$$L=0,6 \text{ m}$$

$$B=0,6 \text{ m}$$

$$H=0,6 \text{ m}$$

$$\text{Dopušteno naprezanje u tlu : } \sigma = 400 \frac{\text{kN}}{\text{m}^2}$$

Beton C25/30

$$f_{ck} = 2,5 \frac{\text{kN}}{\text{m}^2}$$

Čelik B500B

$$f_{yk} = 50,0 \frac{\text{kN}}{\text{cm}^2}$$

$$N_{sd} = 59,42 \text{ kN}$$

Površina temeljne stope::

$$A = 0,6 * 0,6 = 0,36 \text{ m}^2$$

Težina temeljne stope:

$$G = L * B * H * \gamma_b = 0,6 * 0,6 * 0,6 * 25 = 5,4 \text{ kN}$$

Naprezanje u tlu ispod temeljne stope na dubini temeljenja

$$\sigma_{1,2} = \frac{N_{sd} + G}{A} = \frac{59,42 + 5,4}{0,36} = 180,1 \frac{\text{kN}}{\text{m}^2}$$

$$L' = 3 * \left(\frac{L}{2} - e \right) = 3 * \left(\frac{0,6}{2} - 0 \right) = 0,9 \text{ m}$$

$$\sigma_{ekv} = \frac{2 * (N_{sd} + G)}{L' * B} = \frac{2 * (59,42 + 12,8)}{0,8 * 0,8} = 360,11 \frac{\text{kN}}{\text{m}^2} \leq \sigma_{dop, tla} = 400 \frac{\text{kN}}{\text{m}^2}$$

Proračun armature temelja

$$L_1 = \frac{L - h_{stup}}{2} = \frac{1 - 0,26}{2} = 0,37 \text{ m}$$

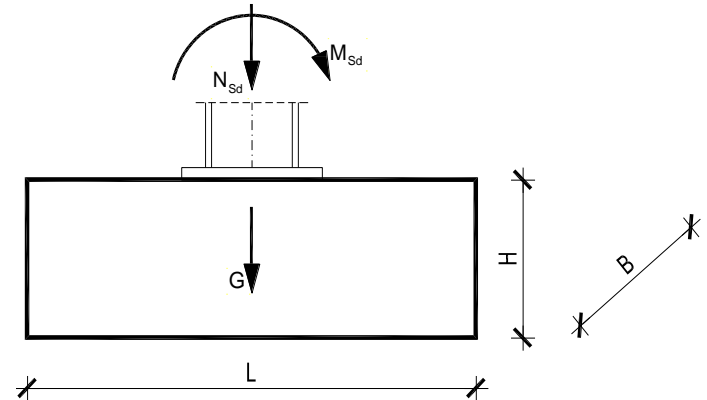

Dimenzioniranje drvenog objekta

$$\sigma_{1-1} = \frac{L'-L_1}{L'} * \sigma_{ekv} = \frac{0,9-0,37}{0,9} * 360,11 = 212,06 \frac{kN}{m^2}$$

$$M_{Sd}^{1-1} = \gamma * \left(\sigma_{1-1} * \frac{L_1^2}{2} * B + \frac{\sigma_{ekv} - \sigma_{1-1}}{2} * L_1 * B * \frac{2}{3} * L_1 \right)$$

$$M_{Sd}^{1-1} = 1,4 * \left(212,06 * \frac{0,37^2}{2} * 0,6 + \frac{360,11 - 212,06}{2} * 0,37 * 0,6 * \frac{2}{3} * 0,37 \right) \\ = 17,9 \text{ kNm}$$

Krak unutarnjih sila u betonu

$$z \approx 0,8 * H = 0,8 * 0,6 = 0,48 \text{ m} = 48 \text{ cm}$$

Potrebna površina armature

$$A_{S1} = \frac{M_{Sd}^{1-1}}{z * \frac{F_{yk}}{\gamma_s}} = \frac{1790}{48 * \frac{50}{1,15}} = 0,86 \text{ cm}^2 < A_{S1,min} = \frac{0,1}{100} * 0,6 * 0,6 = 3,6 \text{ cm}^2$$

Odabrana je minimalna armatura

$$4 \text{ } \emptyset 12 \quad A = 4,52 \text{ cm}^2$$

7. LITERATURA

- [1] A. Bjelanović; V. Rajčić: Drvene konstrukcije prema europskim normama, Građevinski fakultet sveučilišta u Zagrebu, Zagreb 2005.
- [2] E.Borgström; Design of timber structures-Examples, Volume 3, Swedish Wood, 2016.
- [3] E.Borgström; Design of timber structures-Examples, Volume 3, Swedish Wood, 2016.
- [4] Prof. dr.sc. Neno Torić: Predavanja
- [5] Prof.dr.sc. Ivica Boko : Predavanja
- [6] FGAG repozitorij: Repozitorij Fakulteta Građevinarstva, arhitekture i geodezije, Sveučilište u Splitu

Timber ULS check

Linear calculation, Extreme : Cross-section
Selection : AII
Combinations : ULS-Set B (auto)
Cross-section : stupovi - RECT (220; 260)

EN 1995-1-1 Code Check

Beam B33	3,000 m	stupovi - RECT (220; 260)	C24 (EN 338)	ULS-Set B (auto)	0,94 -
----------	---------	------------------------------	--------------	------------------	--------

Combination key
ULS-Set B (auto) / 1.35*vlastita tezina + 1.35*dodatno stalno + 1.50*snijeg + 1.05*Uporabno opterećenje + 0.90*3DWind10

Basic data	
Partial safety factor γ_M for Solid timber	1,30

Material data		
Bending (fm,k)	24,0	MPa
Tension (ft,0,k)	14,5	MPa
Tension (ft,90,k)	0,4	MPa
Compression (fc,0,k)	21,0	MPa
Compression (fc,90,k)	2,5	MPa
Shear (fv,k)	4,0	MPa
Type of timber	Solid	

The critical check is on position **3,000** m.

Internal forces		
NEd	-37,02	kN
Vy,Ed	-5,06	kN
Vz,Ed	-18,50	kN
TEd	0,02	kNm
My,Ed	-29,53	kNm
Mz,Ed	-7,99	kNm

Modification factor		
Service Class	1	
Load duration	Short term	
Modification factor kmod	0,90	

... SECTION CHECK ...

Compression parallel to the grain

According to EN 1995-1-1 article 6.1.4 and formula (6.2)

$\sigma_{c,0,d}$	0,6	MPa
$f_{c,0,d}$	14,5	MPa
Unity check	0,04	-

Compression perpendicular to the grain

According to EN 1995-1-1 article 6.1.5 and formula (6.3)

$F_{c,90,d}$	18,50	kN
l	100	mm
lef	130	mm
b	220	mm
Aef	28600	mm ²
$\sigma_{c,90,d}$	0,6	MPa
Support condition	Discrete	
h	260	mm
kc,90	1,50	-
$f_{c,90,d}$	1,7	MPa
Unity check	0,25	-

Bending

According to EN 1995-1-1 article 6.1.6 and formula (6.11),(6.12)

$\sigma_{m,y,d}$	11,9	MPa
kh,y	1,00	
$f_{m,y,d}$	16,6	MPa
$\sigma_{m,z,d}$	3,8	MPa
kh,z	1,00	
$f_{m,z,d}$	16,6	MPa
km	0,70	

Unity check (6.11) = $0,72 + 0,16 = 0,88$ -
Unity check (5.12) = $0,50 + 0,23 = 0,73$ -

Shear

According to EN 1995-1-1 article 6.1.7 and formula (6.13)

kcr	0,67	
$\tau_{y,d}$	0,2	MPa
$\tau_{z,d}$	0,7	MPa
\bar{v},d	2,8	MPa
Unity check τ_y	0,07	-
Unity check τ_z	0,25	-
Unity check Interaction	0,07	-

Note: The interaction equation has been added as a NCCI.

Torsion

According to EN 1995-1-1 article 6.1.8 and formula (6.14)

$\tau_{tor,d}$	0,0	MPa
kshape	1,06	
\bar{v},d	2,8	MPa
Unity check	0,00	-
Unity check Interaction Shear	0,08	-

Note: The interaction equation has been added as a NCCI.

Combined Bending and Axial Compression

According to EN 1995-1-1 article 6.2.4 and formula (6.19),(6.20)

$f_{c,0,d}$	14,5	MPa
$f_{m,y,d}$	16,6	MPa
$f_{m,z,d}$	16,6	MPa
km	0,70	

Unity check (6.19) = 0,00 + 0,72 + 0,16 = 0,88 -

Unity check (6.20) = 0,00 + 0,50 + 0,23 = 0,73 -

The member satisfies the section check.

...: **STABILITY CHECK** ...:

Columns subjected to compression or combined compression and bending

According to EN 1995-1-1 article 6.3.2 and formula (6.23),(6.24)

Buckling parameters	yy	zz	
Sway type	sway	non-sway	
System length L	1,500	3,000	m
Buckling factor k	2,74	0,60	
Buckling length Lcr	4,116	1,811	m
Slenderness λ	54,83	28,52	-
Relative slenderness λ	0,93	0,48	-
Limit slenderness	0,30	0,30	-
Imperfection β_c	0,20	0,20	-
Reduction factor kc	0,74	0,95	-

Unity check (6.23) = 0,06 + 0,72 + 0,16 = 0,94 -

Unity check (6.24) = 0,05 + 0,50 + 0,23 = 0,78 -

Beams subjected to bending or combined bending and compression

According to EN 1995-1-1 article 6.3.3 and formula (6.33),(6.35)

LTB Parameters		
Elastic critical moment $M_{y,crit}$	657,10	kNm
Critical bending stress $\sigma_{m,crit}$	265,1	MPa
Relative slenderness $\lambda_{rel,m}$	0,30	-
Reduction factor k_{crit}	1,00	-

Unity check (6.33) = 0,72 -

Unity check (6.35) = 0,51 + 0,05 = 0,56 -

$M_{y,crit}$ Parameters		
G0,05	462,5	MPa
LTB length L	3,000	m
Lef/L	0,80	
Effective length Lef	2,400	m
Influence of load position	no influence	

The member satisfies the stability check.

Student version

Timber ULS check

Linear calculation, Extreme : Cross-section

Selection : AII

Combinations : ULS-Set B (auto)

Cross-section : greda krov - glavne - I non-symm (240; 60; 280; 80; 180; 80)

EN 1995-1-1 Code Check

Beam B29	9,000 m	greda krov - glavne - I non-symm (240; 60; 280; 80; 180; 80)	C24 (EN 338)	ULS-Set B (auto)	0,84 -
----------	---------	--	--------------	------------------	--------

Combination key

ULS-Set B (auto) / 1.35*vlastita tezina + 1.35*dodatno stalno + 1.50*snijeg + 1.05*Uporabno opterećenje + 0.90*3DWind10

Basic data

Partial safety factor γ_M for Solid timber 1,30

Material data

Bending (fm,k)	24,0	MPa
Tension (ft,0,k)	14,5	MPa
Tension (ft,90,k)	0,4	MPa
Compression (fc,0,k)	21,0	MPa
Compression (fc,90,k)	2,5	MPa
Shear (fv,k)	4,0	MPa
Type of timber	Solid	

The critical check is on position **0,000** m.

Internal forces

NEd	-10,79	kN
Vy,Ed	-1,94	kN
Vz,Ed	28,50	kN
TEd	-0,10	kNm
My,Ed	-29,49	kNm
Mz,Ed	1,11	kNm

Modification factor

Service Class	1
Load duration	Short term
Modification factor k_{mod}	0,90

...: SECTION CHECK ...:

Compression parallel to the grain

According to EN 1995-1-1 article 6.1.4 and formula (6.2)

$\sigma_{c,0,d}$	0,2	MPa
$f_{c,0,d}$	14,5	MPa
Unity check	0,01	-

Compression perpendicular to the grain

According to EN 1995-1-1 article 6.1.5 and formula (6.3)

$F_{c,90,d}$	28,50	kN
l	100	mm
l_{ef}	130	mm
b	180	mm
A_{ef}	23400	mm ²
$\sigma_{c,90,d}$	1,2	MPa
Support condition	Discrete	
h	400	mm
$k_{c,90}$	1,00	-
$f_{c,90,d}$	1,7	MPa
Unity check	0,70	-

Bending

According to EN 1995-1-1 article 6.1.6 and formula (6.11),(6.12)

$\sigma_{m,y,d}$	6,6	MPa
$k_{h,y}$	1,00	
$f_{m,y,d}$	16,6	MPa
$\sigma_{m,z,d}$	0,8	MPa
$k_{h,z}$	1,00	
$f_{m,z,d}$	16,6	MPa
k_m	1,00	

Unity check (6.11) = $0,40 + 0,05 = 0,45$
Unity check (6.12) = $0,40 + 0,05 = 0,45$

Shear

According to EN 1995-1-1 article 6.1.7 and formula (6.13)

k_{cr}	0,67	
$\tau_{y,d}$	0,1	MPa
$\tau_{z,d}$	2,3	MPa
$f_{v,d}$	2,8	MPa
Unity check τ_y	0,04	-
Unity check τ_z	0,84	-
Unity check Interaction	0,71	-

Note: The interaction equation has been added as a NCCI.

Torsion

According to EN 1995-1-1 article 6.1.8 and formula (6.14)

$\tau_{tor,d}$	0,1	MPa
k_{shape}	1,00	
$f_{v,d}$	2,8	MPa
Unity check	0,04	-
Unity check Interaction Shear	0,75	-

Note: The interaction equation has been added as a NCCI.

Combined Bending and Axial Compression

According to EN 1995-1-1 article 6.2.4 and formula (6.19),(6.20)

$f_{c,0,d}$	14,5	MPa
$f_{m,y,d}$	16,6	MPa
$f_{m,z,d}$	16,6	MPa
k_m	1,00	

Unity check (6.19) = $0,00 + 0,40 + 0,05 = 0,45$ -

Unity check (6.20) = $0,00 + 0,40 + 0,05 = 0,45$ -

The member satisfies the section check.

...: **STABILITY CHECK** ...:

Columns subjected to compression or combined compression and bending

According to EN 1995-1-1 article 6.3.2 and formula (6.23),(6.24)

Buckling parameters	yy	zz	
Sway type	sway	non-sway	
System length L	9,000	0,750	m
Buckling factor k	2,27	0,98	
Buckling length L_{cr}	20,440	0,733	m
Slenderness λ	146,35	12,04	-
Relative slenderness λ	2,48	0,20	-
Limit slenderness	0,30	0,30	-
Imperfection β_c	0,20	0,20	-
Reduction factor k_c	0,15	1,00	-

Unity check (6.23) = $0,10 + 0,40 + 0,05 = 0,55$ -

Unity check (6.24) = $0,01 + 0,40 + 0,05 = 0,46$ -

Beams subjected to bending or combined bending and compression

According to EN 1995-1-1 article 6.3.3 and formula (6.33),(6.35)

LTB Parameters		
Elastic critical moment $M_{y,crit}$	987,40	kNm
Critical bending stress $\sigma_{m,crit}$	222,4	MPa
Relative slenderness $\lambda_{rel,m}$	0,33	-
Reduction factor k_{crit}	1,00	-

Unity check (6.33) = $0,40$ -

Unity check (6.35) = $0,16 + 0,01 = 0,17$ -

$M_{y,crit}$ Parameters		
$G_{0,05}$	462,5	MPa
LTB length L	0,750	m
L_{ef}/L	1,00	
Effective length L_{ef}	0,750	m
Influence of load position	no influence	

The member satisfies the stability check.

Student version

Timber ULS check

Linear calculation, Extreme : Cross-section

Selection : All

Combinations : ULS-Set B (auto)

Cross-section : greda krov - sekundarne - I non-symm (200; 40; 250; 50; 180; 60)

EN 1995-1-1 Code Check

Beam B70	3,000 m	greda krov - sekundarne - I non-symm (200; 40; 250; 50; 180; 60)	C24 (EN 338)	ULS-Set B (auto)	0,89 -
----------	---------	--	--------------	------------------	--------

Combination key

ULS-Set B (auto) / 1.35*vlastita tezina + 1.35*dodatno stalno + 0.75*snijeg + 1.05*Uporabno opterećenje + 1.50*3DWind14

Basic data

Partial safety factor γ_M for Solid timber | 1,30

Material data

Bending (fm,k)	24,0	MPa
Tension (ft,0,k)	14,5	MPa
Tension (ft,90,k)	0,4	MPa
Compression (fc,0,k)	21,0	MPa
Compression (fc,90,k)	2,5	MPa
Shear (fv,k)	4,0	MPa
Type of timber	Solid	

The critical check is on position **3,000 m**.

Internal forces

NEd	-1,88	kN
Vy,Ed	0,66	kN
Vz,Ed	0,24	kN
TEd	0,00	kNm
My,Ed	8,01	kNm
Mz,Ed	0,95	kNm

Modification factor

Service Class	1
Load duration	Short term
Modification factor kmod	0,90

...: SECTION CHECK ...:

Compression parallel to the grain

According to EN 1995-1-1 article 6.1.4 and formula (6.2)

$\sigma_{c,0,d}$	0,1	MPa
$f_{c,0,d}$	14,5	MPa
Unity check	0,00	-

Compression perpendicular to the grain

According to EN 1995-1-1 article 6.1.5 and formula (6.3)

$F_{c,90,d}$	1,51	kN
l	100	mm
lef	160	mm
b	180	mm
Aef	28800	mm ²
$\sigma_{c,90,d}$	0,1	MPa
Support condition	Discrete	
h	310	mm
kc,90	1,50	-
$f_{c,90,d}$	1,7	MPa
Unity check	0,02	-

Bending

According to EN 1995-1-1 article 6.1.6 and formula (6.11),(6.12)

$\sigma_{m,y,d}$	3,2	MPa
kh,y	1,00	
$f_{m,y,d}$	16,6	MPa
$\sigma_{m,z,d}$	1,2	MPa
kh,z	1,00	
$f_{m,z,d}$	15,6	MPa
kn	1,00	

Unity check (6.11) = 0,19 + 0,08 = 0,27 -
Unity check (6.12) = 0,19 + 0,08 = 0,27 -

Shear

According to EN 1995-1-1 article 6.1.7 and formula (6.13)

kcr	0,67	
$\tau_{y,d}$	0,1	MPa
$\tau_{z,d}$	0,0	MPa
$f_{v,d}$	2,8	MPa
Unity check τ_y	0,02	-
Unity check τ_z	0,01	-
Unity check Interaction	0,00	-

Note: The interaction equation has been added as a NCCI.

Torsion

According to EN 1995-1-1 article 6.1.8 and formula (6.14)

$\tau_{tor,d}$	0,0	MPa
kshape	1,00	
$f_{v,d}$	2,8	MPa
Unity check	0,00	-
Unity check Interaction Shear	0,00	-

Note: The interaction equation has been added as a NCCI.

Combined Bending and Axial Compression

According to EN 1995-1-1 article 6.2.4 and formula (6.19),(6.20)

$f_{c,0,d}$	14,5	MPa
$f_{m,y,d}$	16,6	MPa
$f_{m,z,d}$	16,6	MPa
km	1,00	

Unity check (6.19) = $0,00 + 0,19 + 0,08 = 0,27$ -

Unity check (6.20) = $0,00 + 0,19 + 0,08 = 0,27$ -

The member satisfies the section check.

...: **STABILITY CHECK** ...:

Columns subjected to compression or combined compression and bending

According to EN 1995-1-1 article 6.3.2 and formula (6.23),(6.24)

Buckling parameters	yy	zz	
Sway type	sway	non-sway	
System length L	9,000	3,000	m
Buckling factor k	9,11	0,68	
Buckling length Lcr	81,977	2,026	m
Slenderness λ	716,67	36,71	-
Relative slenderness λ	12,15	0,62	-
Limit slenderness	0,30	0,30	-
Imperfection β_c	0,20	0,20	-
Reduction factor kc	0,01	0,91	-

Unity check (6.23) = $0,62 + 0,19 + 0,08 = 0,89$ -

Unity check (6.24) = $0,00 + 0,19 + 0,08 = 0,27$ -

Warning: The slenderness 716,67 is larger than the limit value 200,00!

Beams subjected to bending or combined bending and compression

According to EN 1995-1-1 article 6.3.3 and formula (6.33),(6.35)

LTB Parameters		
Elastic critical moment $M_{y,crit}$	105,40	kNm
Critical bending stress $\sigma_{m,crit}$	42,5	MPa
Relative slenderness $\lambda_{rel,m}$	0,75	-
Reduction factor k_{crit}	1,00	-

Unity check (6.33) = $0,20$ -

Unity check (6.35) = $0,04 + 0,00 = 0,04$ -

My,crit Parameters		
G0,05	462,5	MPa
LTB length L	3,000	m
Lef/L	0,90	
Effective length Lef	2,700	m
Influence of load position	no influence	

The member satisfies the stability check.

Timber ULS check

Linear calculation, Extreme : Cross-section

Selection : AII

Combinations : ULS-Set B (auto)

Cross-section : greda medukatna - glavne - I non-symm (200; 140; 400; 50; 400; 50)

EN 1995-1-1 Code Check

Beam B18	9,000 m	greda medukatna - glavne - I non-symm (200; 140; 400; 50; 400; 50)	C24 (EN 338)	ULS-Set B (auto)	0,66 -
----------	---------	--	--------------	------------------	--------

Combination key

ULS-Set B (auto) / 1.35*vlastita tezina + 1.35*dodatno stalno + 1.50*Uporabno opterećenje + 0.90*3DWind7

Basic data

Partial safety factor γ_M for Solid timber 1,30

Material data

Bending (fm,k)	24,0	MPa
Tension (ft,0,k)	14,5	MPa
Tension (ft,90,k)	0,4	MPa
Compression (fc,0,k)	21,0	MPa
Compression (fc,90,k)	2,5	MPa
Shear (fv,k)	4,0	MPa
Type of timber	Solid	

The critical check is on position **6,000** m.

Internal forces

NEd	-25,21	kN
Vy,Ed	9,46	kN
Vz,Ed	-38,70	kN
TEd	0,63	kNm
My,Ed	-21,69	kNm
Mz,Ed	8,28	kNm

Modification factor

Service Class	1
Load duration	Short term
Modification factor kmod	0,90

...: SECTION CHECK ...:

Compression parallel to the grain

According to EN 1995-1-1 article 6.1.4 and formula (6.2)

$\sigma_{c,0,d}$	0,4	MPa
$fc_{0,d}$	14,5	MPa
Unity check	0,03	-

Compression perpendicular to the grain

According to EN 1995-1-1 article 6.1.5 and formula (6.3)

$F_{c,90,d}$	55,16	kN
l	100	mm
l _{ef}	160	mm
b	400	mm
A _{ef}	64000	mm ²
$\sigma_{c,90,d}$	0,9	MPa
Support condition	Discrete	
h	300	mm
kc,90	1,50	-
$fc_{90,d}$	1,7	MPa
Unity check	0,33	-

Bending

According to EN 1995-1-1 article 6.1.6 and formula (6.11),(6.12)

$\sigma_{m,y,d}$	4,5	MPa
kh,y	1,00	
$f_{m,y,d}$	16,6	MPa
$\sigma_{m,z,d}$	2,9	MPa
kh,z	1,00	
$f_{m,z,d}$	16,6	MPa
km	1,00	

Unity check (6.11) = 0,27 + 0,17 = 0,44 -
Unity check (6.12) = 0,27 + 0,17 = 0,44 -

Shear

According to EN 1995-1-1 article 6.1.7 and formula (6.13)

k_{cr}	0,67	
$\tau_{y,d}$	0,4	MPa
$\tau_{z,d}$	1,8	MPa
$f_{v,d}$	2,8	MPa
Unity check τ_y	0,15	-
Unity check τ_z	0,66	-
Unity check Interaction	0,45	-

Note: The interaction equation has been added as a NCCI.

Torsion

According to EN 1995-1-1 article 6.1.8 and formula (6.14)

$\tau_{tor,d}$	0,4	MPa
k_{shape}	1,00	
$f_{v,d}$	2,8	MPa
Unity check	0,14	-
Unity check Interaction Shear	0,59	-

Note: The interaction equation has been added as a NCCI.

Combined Bending and Axial Compression

According to EN 1995-1-1 article 6.2.4 and formula (6.19),(6.20)

$f_{c,0,d}$	14,5	MPa
$f_{m,y,d}$	16,6	MPa
$f_{m,z,d}$	16,6	MPa
k_m	1,00	

Unity check (6.19) = $0,00 + 0,27 + 0,17 = 0,44$ -

Unity check (6.20) = $0,00 + 0,27 + 0,17 = 0,44$ -

The member satisfies the section check.

...: **STABILITY CHECK** ...:

Columns subjected to compression or combined compression and bending

According to EN 1995-1-1 article 6.3.2 and formula (6.23),(6.24)

Buckling parameters	yy	zz	
Sway type	sway	non-sway	
System length L	6,000	0,750	m
Buckling factor k	1,14	0,92	
Buckling length L_{cr}	6,857	0,691	m
Slenderness λ	66,33	7,49	-
Relative slenderness λ	1,12	0,13	-
Limit slenderness	0,30	0,30	-
Imperfection β_c	0,20	0,20	-
Reduction factor k_c	0,60	1,00	-

Unity check (6.23) = $0,04 + 0,27 + 0,17 = 0,48$ -

Unity check (6.24) = $0,03 + 0,27 + 0,17 = 0,47$ -

Beams subjected to bending or combined bending and compression

According to EN 1995-1-1 article 6.3.3 and formula (6.33),(6.35)

LTB Parameters		
Elastic critical moment $M_{y,crit}$	3070,03	kNm
Critical bending stress $\sigma_{m,crit}$	633,7	MPa
Relative slenderness $\lambda_{rel,m}$	0,19	-
Reduction factor k_{crit}	1,00	-

Unity check (6.33) = $0,27$ -

Unity check (6.35) = $0,07 + 0,03 = 0,10$ -

$M_{y,crit}$ Parameters		
$G_{0,05}$	462,5	MPa
LTB length L	0,750	m
L_{ef}/L	0,90	
Effective length L_{ef}	0,675	m
Influence of load position	no influence	

The member satisfies the stability check.

Student version

Timber ULS check

Linear calculation, Extreme : Cross-section

Selection : All

Combinations : ULS-Set B (auto)

Cross-section : greda medukatna - sekundarne - I non-symm (200; 40; 250; 50; 180; 60)

EN 1995-1-1 Code Check

Beam B50	3,000 m	greda medukatna - sekundarne - I non-symm (200; 40; 250; 50; 180; 60)	C24 (EN 338)	ULS-Set B (auto)	0,81 -
----------	---------	---	--------------	------------------	--------

Combination key

ULS-Set B (auto) / 1.35*vlastita tezina + 1.35*dodatno stalno + 0.75*snijeg + 1.05*Uporabno opterećenje + 1.50*3DWind6

Basic data

Partial safety factor γ_M for Solid timber | 1,30

Material data

Bending (fm,k)	24,0	MPa
Tension (ft,0,k)	14,5	MPa
Tension (ft,90,k)	0,4	MPa
Compression (fc,0,k)	21,0	MPa
Compression (fc,90,k)	2,5	MPa
Shear (fv,k)	4,0	MPa
Type of timber	Solid	

The critical check is on position **3,000 m**.

Internal forces

NEd	-1,49	kN
Vy,Ed	-0,93	kN
Vz,Ed	-0,60	kN
TEd	-0,01	kNm
My,Ed	9,13	kNm
Mz,Ed	-1,37	kNm

Modification factor

Service Class	1
Load duration	Short term
Modification factor kmod	0,90

...: SECTION CHECK ...:

Compression parallel to the grain

According to EN 1995-1-1 article 6.1.4 and formula (6.2)

$\sigma_{c,0,d}$	0,0	MPa
$f_{c,0,d}$	14,5	MPa
Unity check	0,00	-

Compression perpendicular to the grain

According to EN 1995-1-1 article 6.1.5 and formula (6.3)

$F_{c,90,d}$	0,90	kN
l	100	mm
lef	160	mm
b	180	mm
Aef	28800	mm ²
$\sigma_{c,90,d}$	0,0	MPa
Support condition	Discrete	
h	310	mm
kc,90	1,50	-
$f_{c,90,d}$	1,7	MPa
Unity check	0,01	-

Bending

According to EN 1995-1-1 article 6.1.6 and formula (6.11),(6.12)

$\sigma_{m,y,d}$	3,7	MPa
kh,y	1,00	
$f_{m,y,d}$	16,6	MPa
$\sigma_{m,z,d}$	1,8	MPa
kh,z	1,00	
$f_{m,z,d}$	15,6	MPa
kn	1,00	

Unity check (6.11) = 0,22 + 0,11 = 0,33 -
Unity check (6.12) = 0,22 + 0,11 = 0,33 -

Shear

According to EN 1995-1-1 article 6.1.7 and formula (6.13)

k _{cr}	0,67	
τ _{y,d}	0,1	MPa
τ _{z,d}	0,1	MPa
f _{v,d}	2,8	MPa
Unity check τ _y	0,03	-
Unity check τ _z	0,03	-
Unity check Interaction	0,00	-

Note: The interaction equation has been added as a NCCI.

Torsion

According to EN 1995-1-1 article 6.1.8 and formula (6.14)

τ _{tor,d}	0,0	MPa
k _{shape}	1,00	
f _{v,d}	2,8	MPa
Unity check	0,01	-
Unity check Interaction Shear	0,01	-

Note: The interaction equation has been added as a NCCI.

Combined Bending and Axial Compression

According to EN 1995-1-1 article 6.2.4 and formula (6.19),(6.20)

f _{c,0,d}	14,5	MPa
f _{m,y,d}	16,6	MPa
f _{m,z,d}	16,6	MPa
k _m	1,00	

Unity check (6.19) = 0,00 + 0,22 + 0,11 = 0,33 -

Unity check (6.20) = 0,00 + 0,22 + 0,11 = 0,33 -

The member satisfies the section check.

...: STABILITY CHECK ...

Columns subjected to compression or combined compression and bending

According to EN 1995-1-1 article 6.3.2 and formula (6.23),(6.24)

Buckling parameters	yy	zz	
Sway type	sway	non-sway	
System length L	9,000	3,000	m
Buckling factor k	9,03	0,64	
Buckling length L _{cr}	81,237	1,931	m
Slenderness λ	710,19	35,00	-
Relative slenderness λ	12,04	0,59	-
Limit slenderness	0,30	0,30	-
Imperfection β _c	0,20	0,20	-
Reduction factor k _c	0,01	0,92	-

Unity check (6.23) = 0,48 + 0,22 + 0,11 = 0,81 -

Unity check (6.24) = 0,00 + 0,22 + 0,11 = 0,33 -

Warning: The slenderness 710,19 is larger than the limit value 200,00!

Beams subjected to bending or combined bending and compression

According to EN 1995-1-1 article 6.3.3 and formula (6.33),(6.35)

LTB Parameters		
Elastic critical moment M _{y,crit}	105,40	kNm
Critical bending stress σ _{m,crit}	42,5	MPa
Relative slenderness λ _{rel,m}	0,75	-
Reduction factor k _{crit}	1,00	-

Unity check (6.33) = 0,22 -

Unity check (6.35) = 0,05 + 0,00 = 0,05 -

M _{y,crit} Parameters		
G _{0,05}	462,5	MPa
LTB length L	3,000	m
L _{ef} /L	0,90	
Effective length L _{ef}	2,700	m
Influence of load position	no influence	

The member satisfies the stability check.

GENERALNI PLAN POZICIJA

TLOCRT

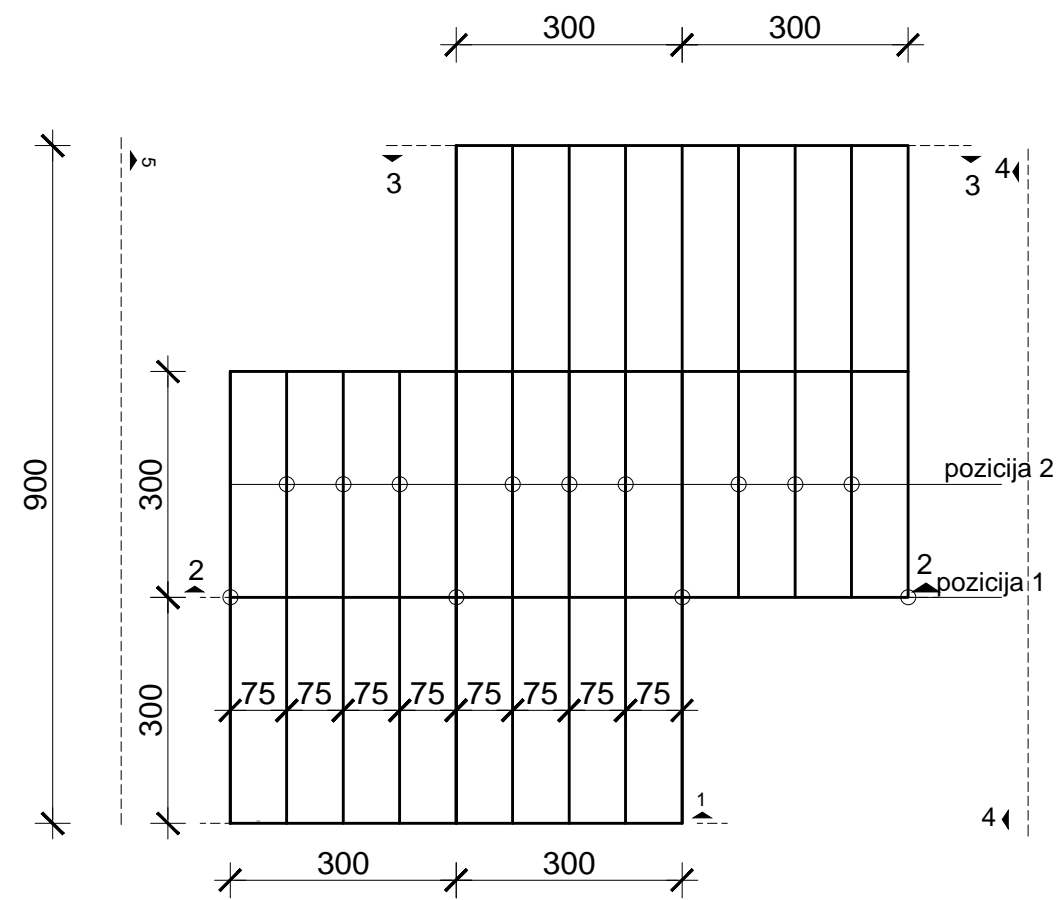

POGLED 1

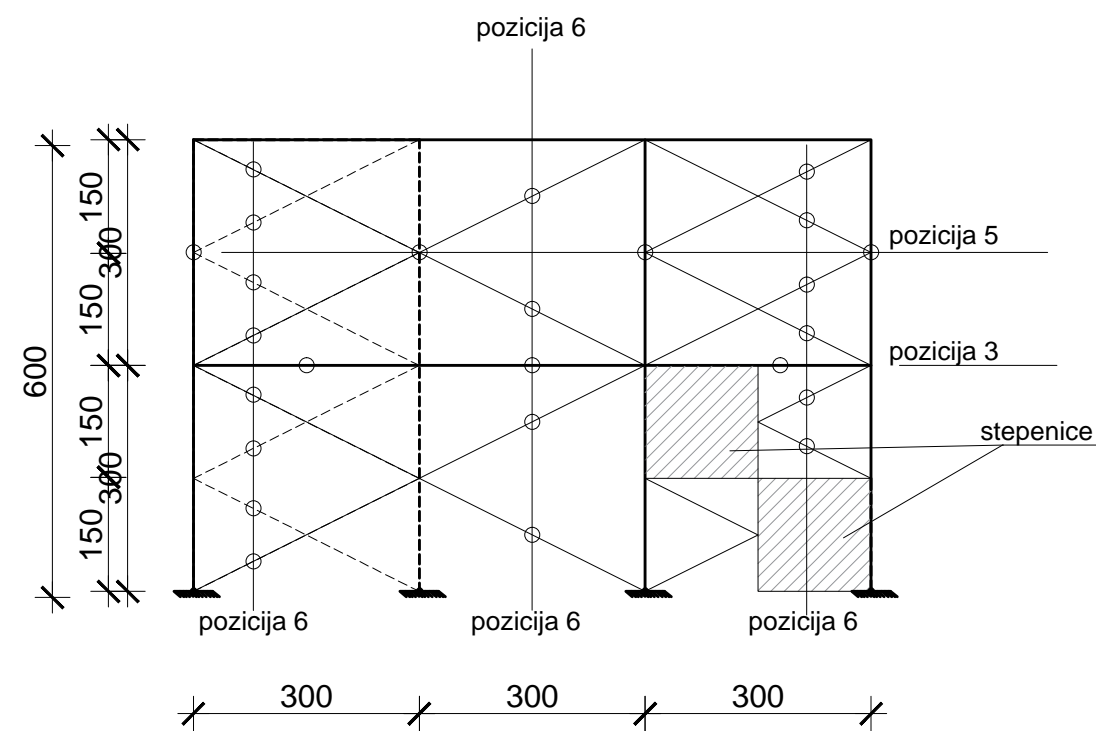

POGLED 3

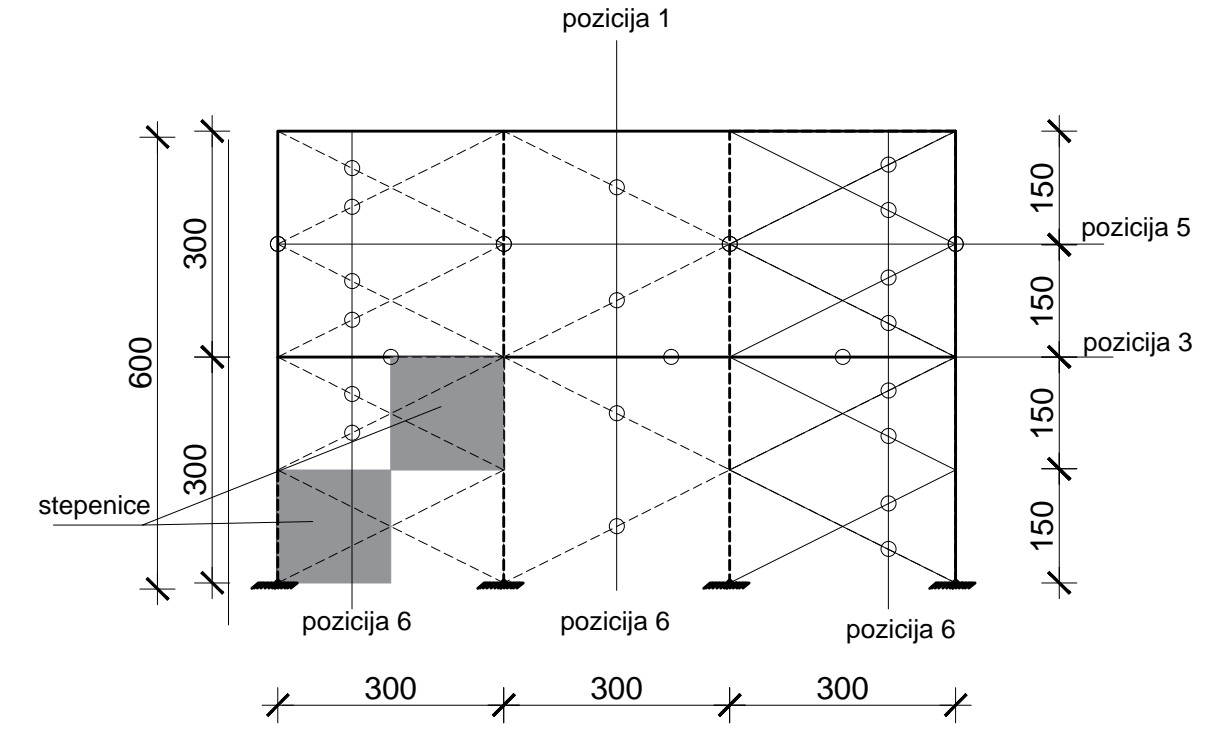

POGLED 4

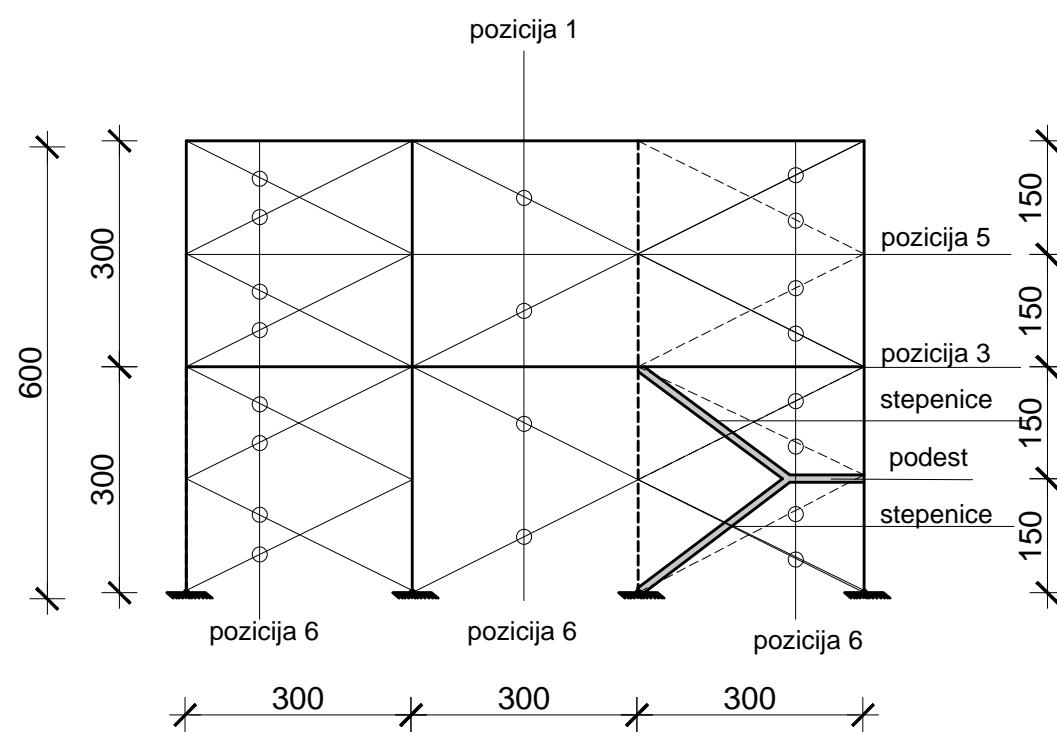

POGLED 5

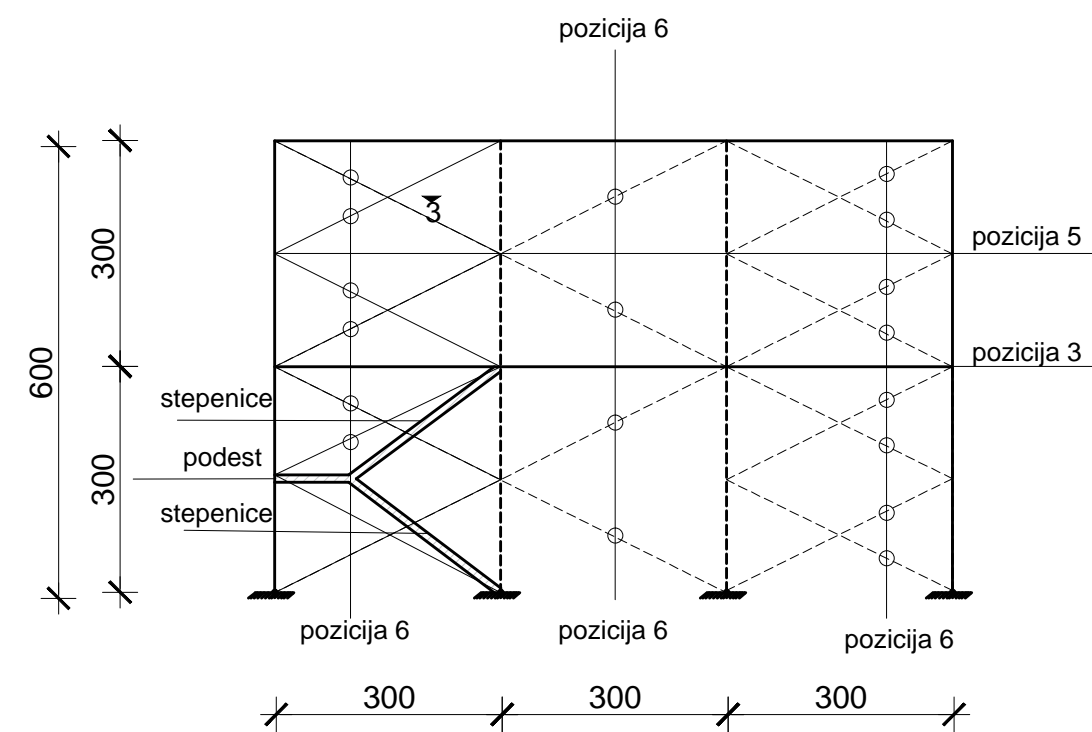

POZICIJA	NAZIV ELEMENTA	i PROFIL
1	glavne krovne grede	160 / 240
2	sekundarne krovne grede	120 / 200
3	glavne međukatne grede	160 / 220
4	sekundarne međukatne grede	140 / 200
5	stupovi	220 / 260
6	spreгови	RD16

Završni rad			
TEMA	KONSTRUIRANJE I DIMENZIONIRANJE DRVENOG OBJEKTA		
STUDENT	Crnković Ivana, 4523		
SADRŽAJ	Generalni plan pozicija	MJERILO	1:100
DATUM	rujan 2019.	BROJ PRILOGA	1



PRESJEK 2

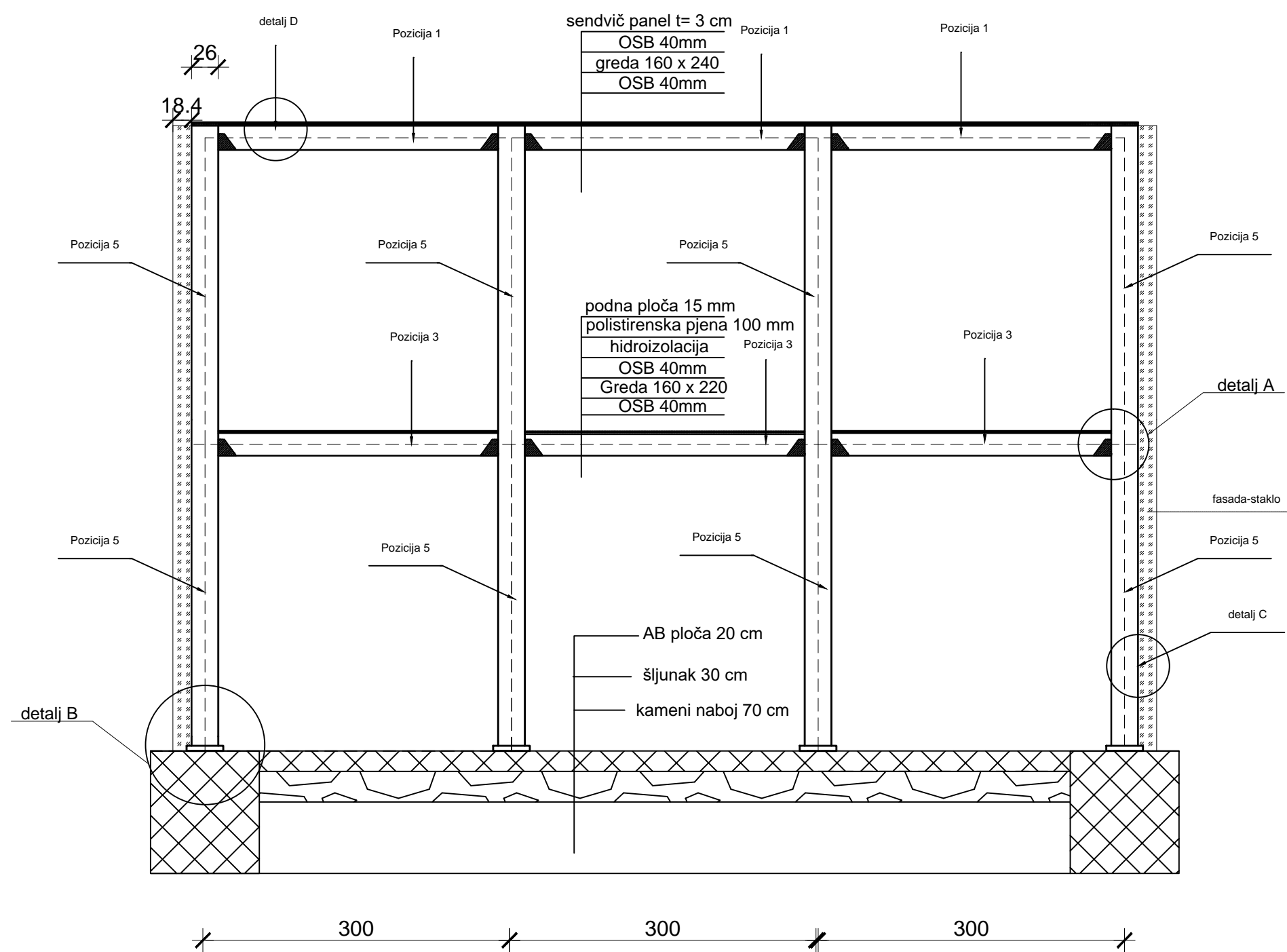

DETALJ D

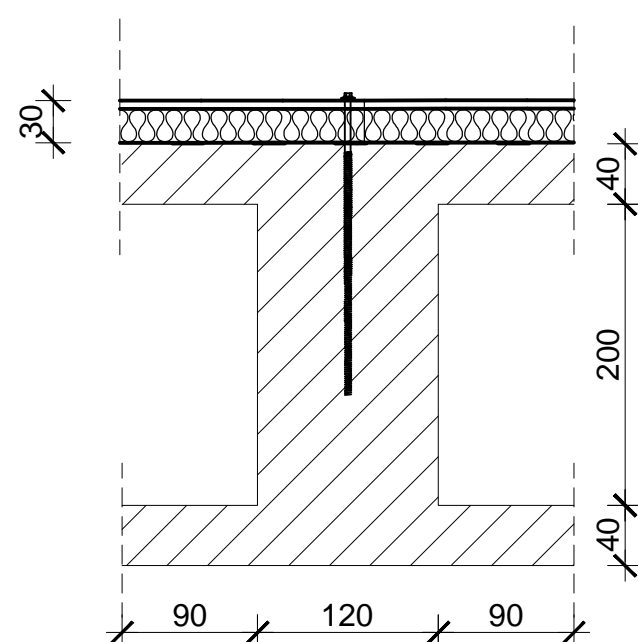

POZICIJA 1

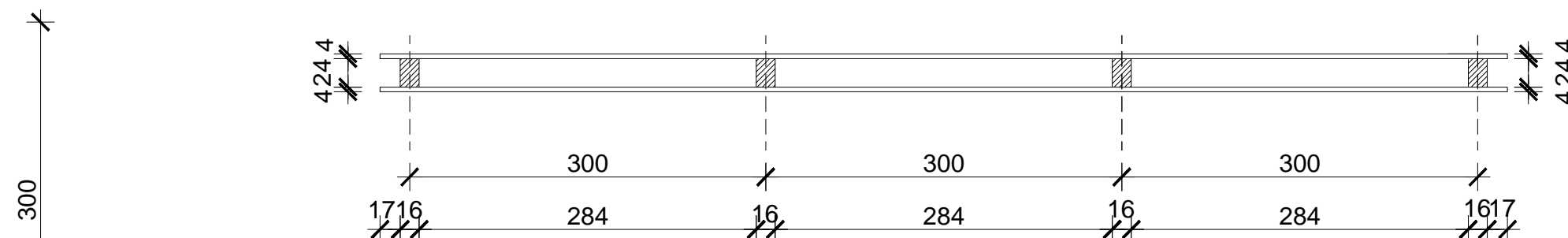

POZICIJA 2

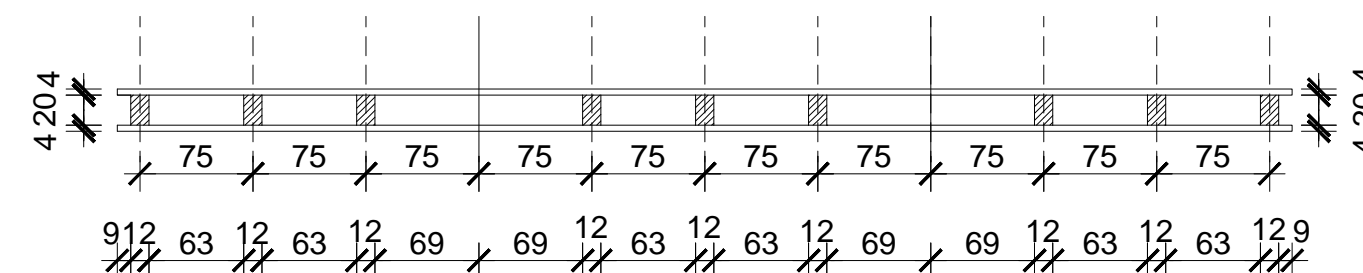

POZICIJA 3

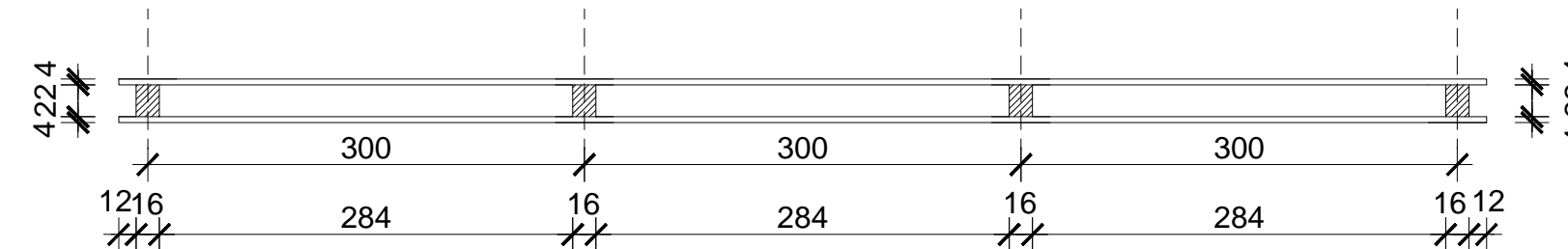

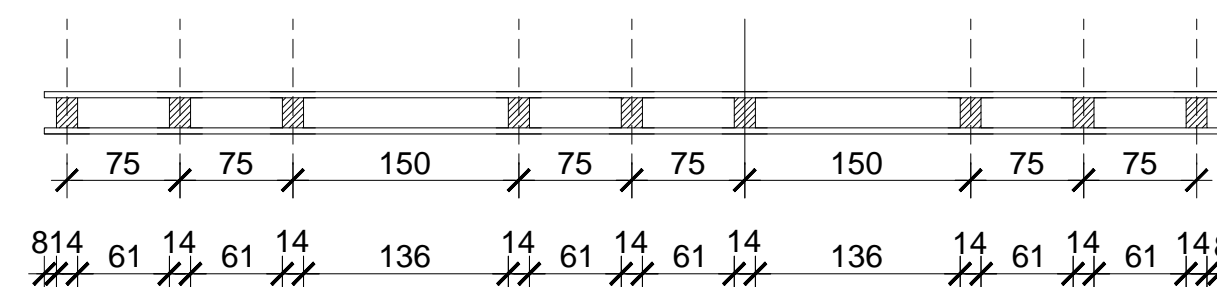

POZICIJA 4

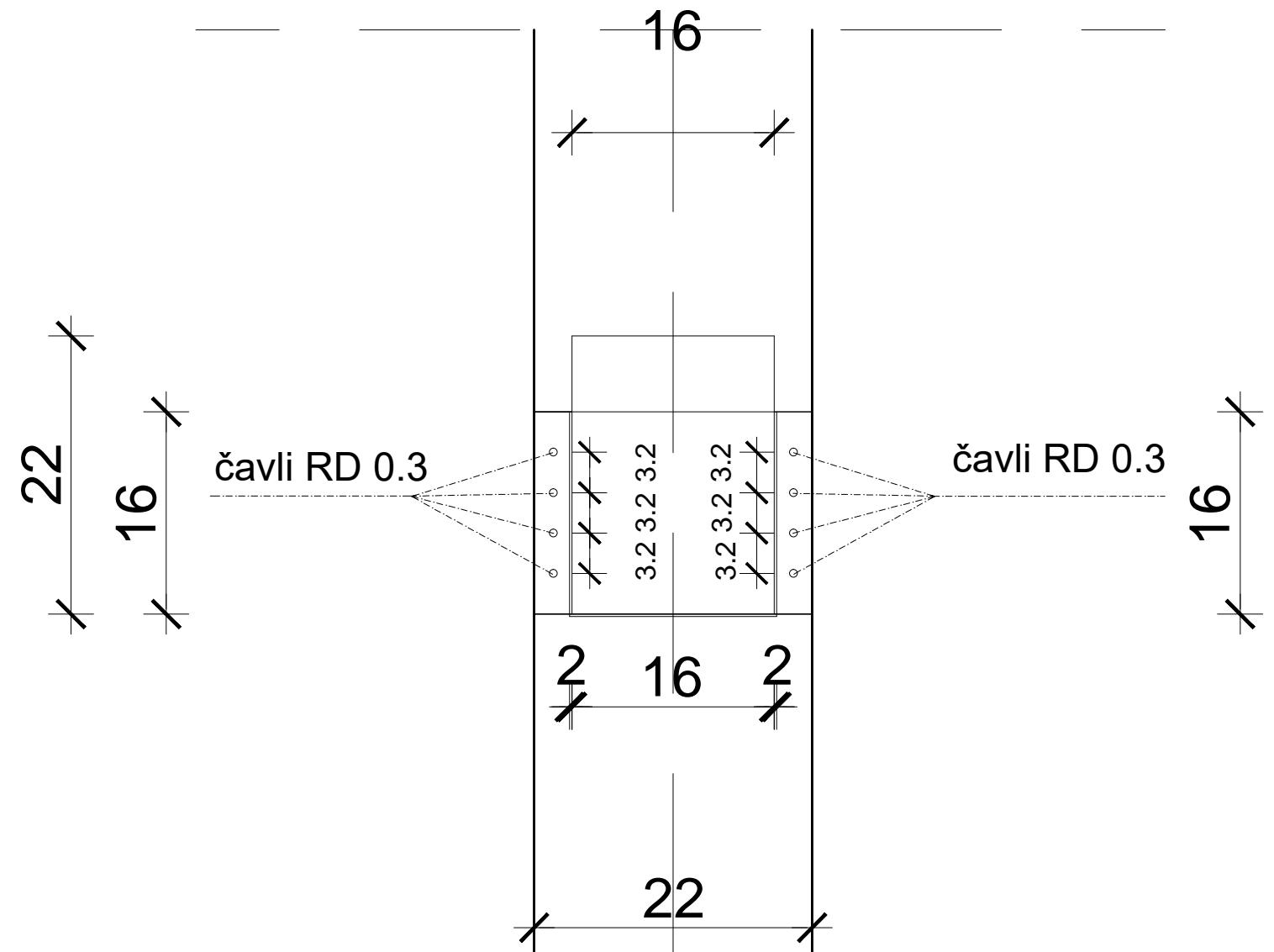
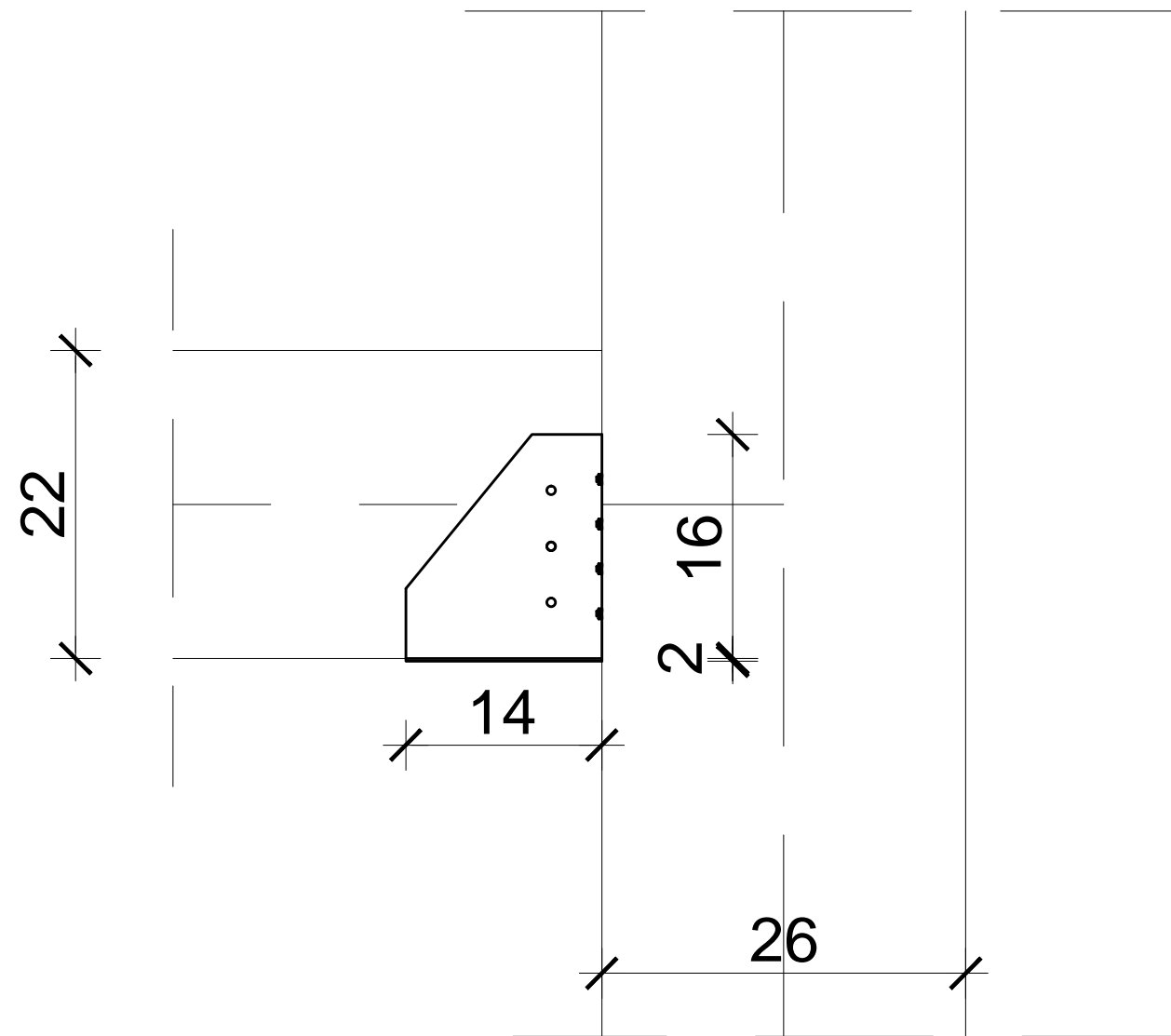

 SVEUČILIŠTE U SPLITU FAKULTET GRADEVINARSTVA, ARHITEKTURE I GEDEZIJE 21000 SPLIT, MATICE HRVATSKE 15	Završni rad		
	TEMA KONSTRUIRANJE I DIMENZIONIRANJE DRVENOG OBJEKTA		
	STUDENT Crnković Ivana, 4523		
	SADRŽAJ Presjek 2	MJERILO 1:50	BROJ PRILOGA 2
	DATUM rujan 2019.		

DETALJ A SPOJ STUP-GREDA



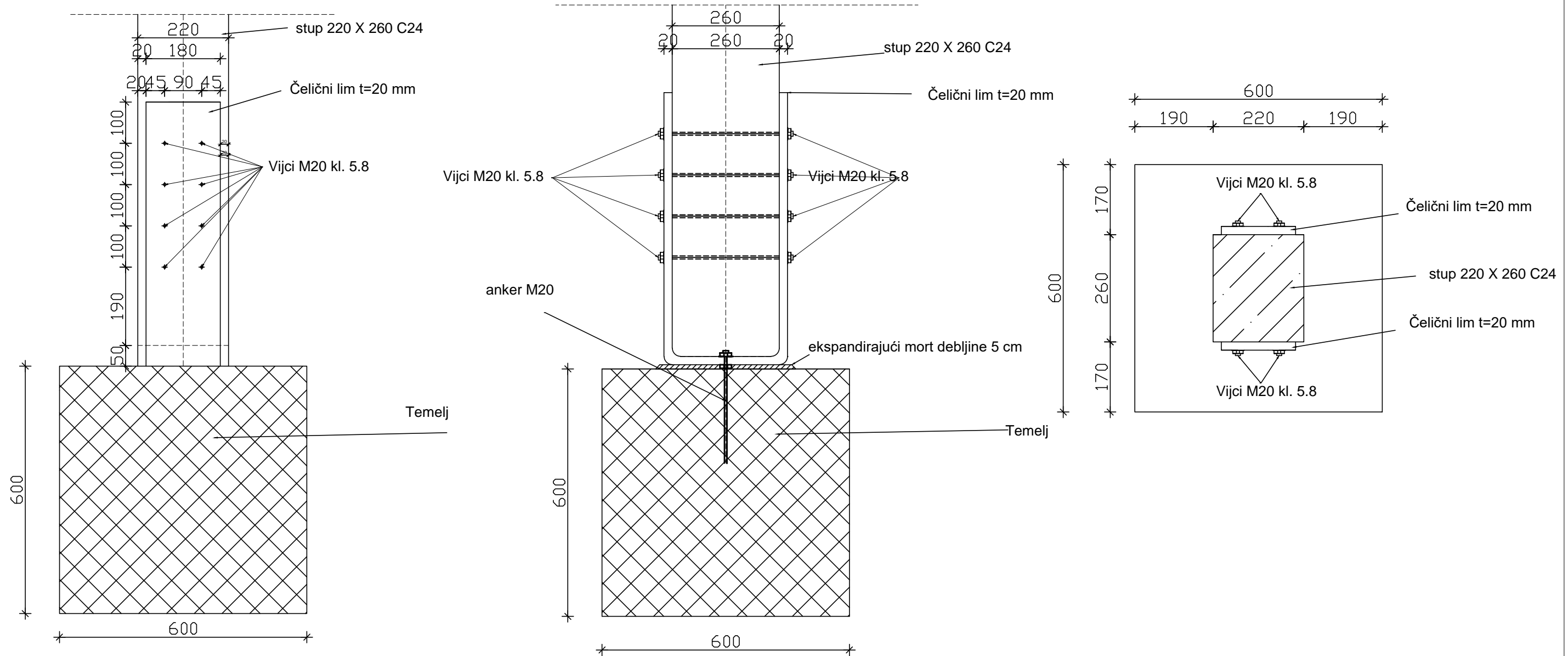

 <p>SVEUČILIŠTE U SPLITU FAKULTET GRAĐEVINARSTVA, ARHITEKTURE I GEODEZIJE 21000 SPLIT, MATICE HRVATSKE</p>	Završni rad	
	TEMA KONSTRUIRANJE I DIMENZIONIRANJE DRVENOG OBJEKTA	
	STUDENT Crnković Ivana, 4523	
	SADRŽAJ Detalj A-spoj stupa i grede	MJERILO 1:5
DATUM rujan 2019.	BROJ PRILOGA 3	

DETALJ B SPOJ STUP TEMELJ

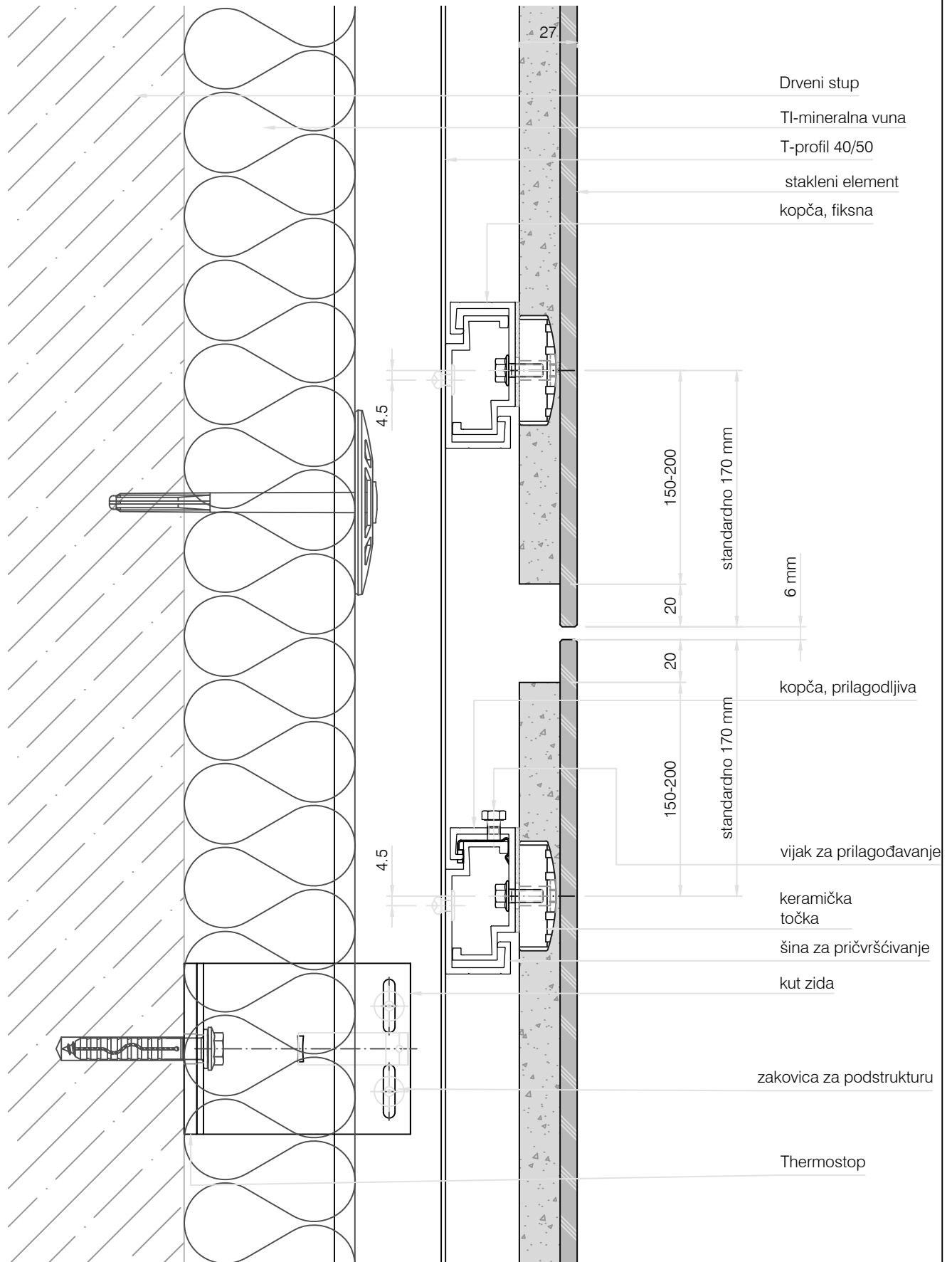

PRESJEK STAKLENE FASADE MJ 1:2.5



 <p>SVEUČILIŠTE U SPLITU FAKULTET GRADEVINARSTVA, ARHITEKTURE I GEDEZIJE 21000 SPLIT, MATICE HRVATSKE 15</p>	Završni rad	
	TEMA KONSTRUIRANJE I DIMENZIONIRANJE DRVENOG OBJEKTA	
	STUDENT Crnković Ivana, 4523	
	SADRŽAJ Detalj C	MJERILO 1:2.5
	DATUM rujan 2019.	BROJ PRILOGA 5