

Glazbena i plesna škola Zadar

Bodrožić, Magdalena

Supplement / Prilog

Publication year / Godina izdavanja: **2020**

Permanent link / Trajna poveznica: <https://urn.nsk.hr/urn:nbn:hr:123:782314>

Rights / Prava: [In copyright](#)/[Zaštićeno autorskim pravom.](#)

Download date / Datum preuzimanja: **2025-04-02**



Repository / Repozitorij:

[FCEAG Repository - Repository of the Faculty of Civil Engineering, Architecture and Geodesy, University of Split](#)



UNIVERSITY OF SPLIT

dabar

DIGITALNI AKADEMSKI ARHIVI I REPOZITORIJI



LOKACIJA I URBANIZAM

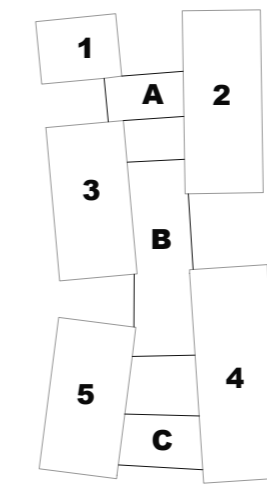
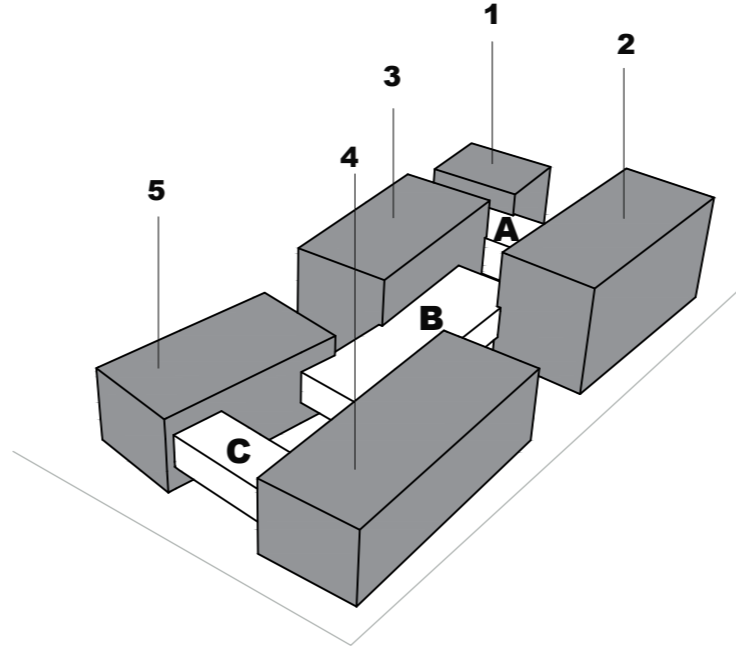

- 1 tehnički blok
spremačice, domar
uprava, domar
profesori
 - 2 glazbeni odjel
predškolski
osnovna škola
srednja škola
 - 3 plesni odjel
klasični balet
suvereni ples
 - 4 koncertna dvorana
 - 5 mediateka
kantina
- A DNEVNI BORAVAK
 - B PVN
 - C CAFFE BAR

PROSTORNA ORGANIZACIJA

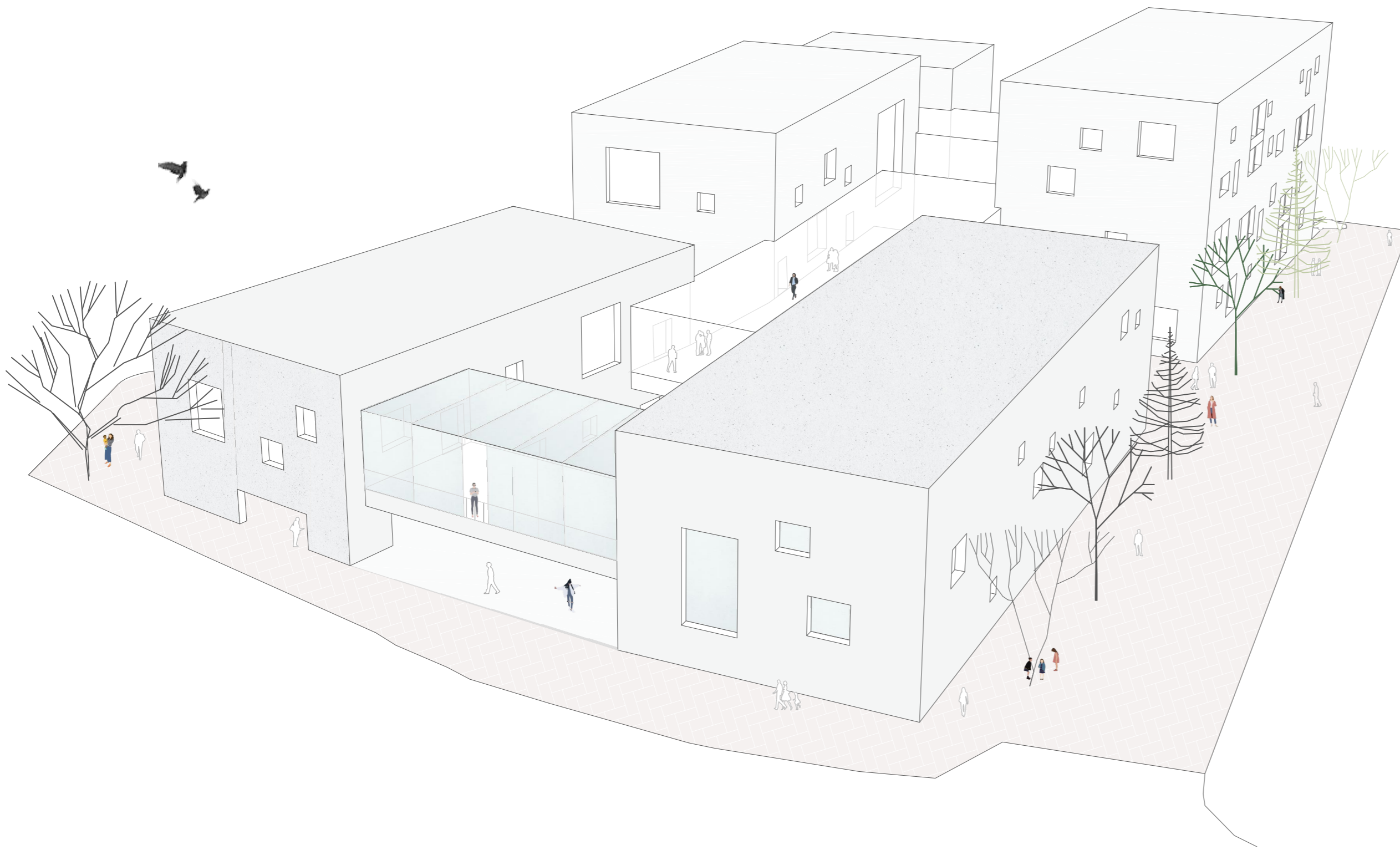

- organizacija škole u samostalnim jedinicama

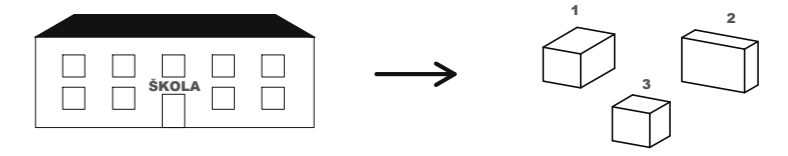

- stvaranje polujavnog prostora koji povezuje sve sadržaje škole
- ispreplitanje javnosti s učenicima/profesorima

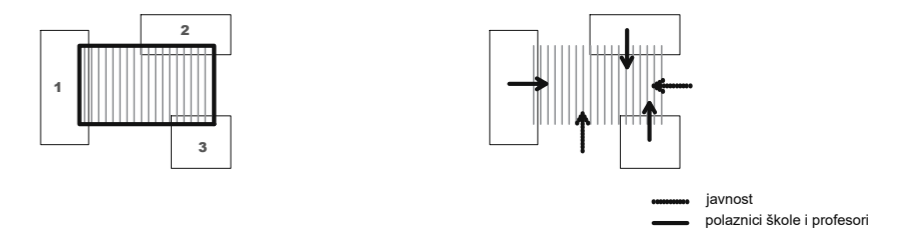

- privlačenje i usmjeravanje prolaznika
- uvlačenje prolaznika u prostore škole

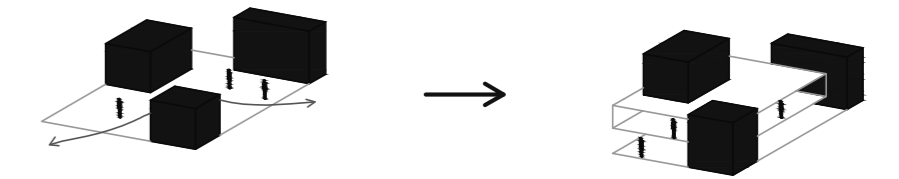

PROSTORNA ORGANIZACIJA

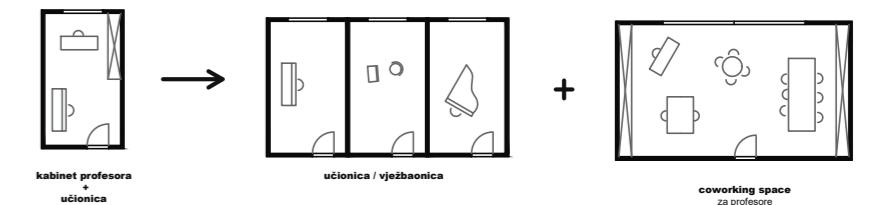

KONCEPT



TLOCRT 0



PRESJEK 3-3

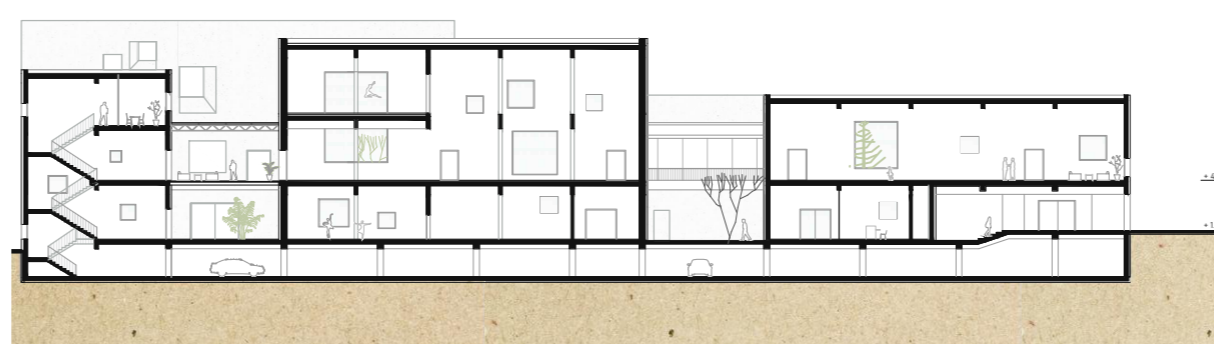

PRESJEK 2-2



AMBIJENT



IME I PREZIME

NASLOV DIPLOMSKOG RADA

AKADEMSKA GODINA

MENTOR

KOMENTOR

KONZULTANT

MAGDALENA BODROŽIĆ

GLAZBENA I PLESNA ŠKOLA_ZADAR

2019 / 2020

DINKO PERAČIĆ

SNJEŽANA DOBROTA

IVAN BALIĆ

Zbog nedovoljnih prostornih kapaciteta i neadekvatnih prostora postojeće glazbene i plesne škole u Zadru javila se potreba za novom školom koja će svojim kapacitetom i sadržajem omogućiti napredak svakog učenika i nastavnika. Odabrana je nova lokacija u neposrednoj blizini centra grada gdje bi škola mogla postati pokretač uređenja trenutno kaotične prostorne situacije. Budući da se događaju promjene u obrazovnom sustavu, prostorom je važno popratiti promjene i osigurati njegov razvoj. Cilj projekta je da škola preuzme ulogu afirmacije umjetnosti u društvu te da približi svoj rad javnosti. Posjetitelje se može privući dodatnim sadržajima škole kao što su caffe bar, medijateka i koncertna dvorana. Kao dodatni sadržaj postavlja se i polujavni polivaltni prostor koji može služiti za razna školska, ali i kulturna događanja u gradu.

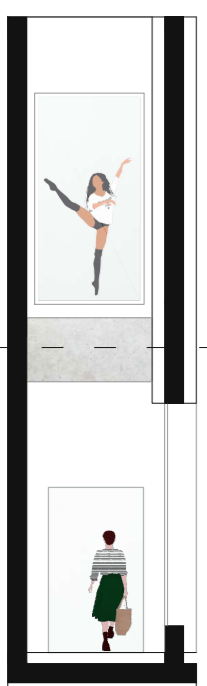

DNEVNI BORAVAK

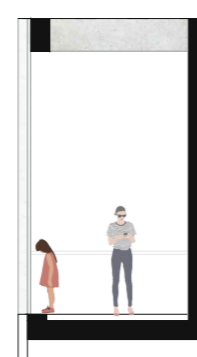

PVN

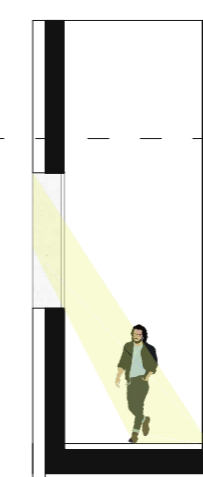

CAFFE BAR

