

Projekt čelične nadstrešnice shopping centra "King Cross"

Čoga, Filip

Master's thesis / Diplomski rad

2023

Degree Grantor / Ustanova koja je dodijelila akademski / stručni stupanj:

University of Split, Faculty of Civil Engineering, Architecture and Geodesy / Sveučilište u Splitu, Fakultet građevinarstva, arhitekture i geodezije

Permanent link / Trajna poveznica: <https://um.nsk.hr/um:nbn:hr:123:167564>

Rights / Prava: [In copyright](#)/[Zaštićeno autorskim pravom.](#)

Download date / Datum preuzimanja: **2024-07-23**



Repository / Repozitorij:

[FCEAG Repository - Repository of the Faculty of Civil Engineering, Architecture and Geodesy, University of Split](#)



UNIVERSITY OF SPLIT



**SVEUČILIŠTE U SPLITU
FAKULTET GRAĐEVINARSTVA ARHITEKTURE I GEODEZIJE**

DIPLOMSKI RAD

Filip Čoga

Split, 2023.

**SVEUČILIŠTE U SPLITU
FAKULTET GRAĐEVINARSTVA ARHITEKTURE I GEODEZIJE**

Filip Čoga

**Projekt čelične nadstrešnice shopping centra „King
Cross“**

Diplomski rad

Split, 2023.

Projekt čelične nadstrešnice shopping centra „King Cross“

Sažetak:

Projekt nadogradnje i rekonstrukcije shopping centra „King Cross“ sadržava u sebi čeličnu nadstrešnicu na sjeveroistočnom pročelju građevine. Shopping centar se nalazi na području Zagreba. Proračun se provodi na temelju graničnog stanja nosivosti (GSN) i graničnog stanja uporabljivosti (GSU). Opterećenja koja se javljaju na konstrukciju su stalno (vlastita težina i dodatno stalno opterećenje) i promjenjivo (snijeg, vjetar i temperatura). Također je provjerena konstrukcija na seizmičko djelovanje. Iznosi unutarnjih sila dobiveni su u računalnom programu „SCIA Engineer 22.0“ uz pomoć kojeg je i provedeno dimenzioniranje prema HRN EN 1993. Spojevi su proračunati uz pomoć „IDEA Statica 22.1“ te su nacrti izrađeni uz pomoć „AutoCAD 23.0“ i „Allplan Nemetschek 2022“.

Ključne riječi:

Računalni program, HRN EN 1993, čelik, nadstrešnica, spojevi, nacrti

Steel canopy project of the shopping center „King Cross“

Abstract:

The project of upgrade and reconstruction of the shopping center „King Cross“ includes steel canopy project on northeast facade. Shopping center is located in area of the Zagreb. Structure calculations are based on ultimate state (ULS) and serviceability limit state (SLS). Loads are permanent, variable (snow, wind and temperature) and seismic. The results of the internal forces were calculated and structural elements were designed using „Scia Engineer 22.0“. Structural joints were designed using „IDEA Statica 21.1“. Structural drawings were made using „AutoCAD 23“ and „Allplan Nemetschek 2022“.

Keywords:

Computer program, HRN EN 1993, steel, canopy, joints, drawings



**SVEUČILIŠTE U SPLITU
FAKULTET GRAĐEVINARSTVA, ARHITEKTURE I GEODEZIJE**

STUDIJ: **DIPLOMSKI SVEUČILIŠNI STUDIJ GRAĐEVINARSTVA**

KANDIDAT: **Filip Čoga**

MATIČNI BROJ (JMBAG): **940**

KATEDRA: **Katedra za metalne i drvene konstrukcije**

PREDMET: **Metalne konstrukcije 2**

ZADATAK ZA DIPLOMSKI RAD

Tema: Projekt čelične nadstrešnice shopping centra "King Cross"

Opis zadatka: Na temelju arhitektonskih podloga potrebno je projektirati nosivu čeličnu konstrukciju nadstrešnice. Za nosivu čeličnu konstrukciju koristit će se čelik S355J2. Za konstrukciju temelja koristiti će se beton C30/37. Građevina se nalazi na području Zagreba.

U Splitu, ožujak 2023.

Voditelj Diplomskog rada:

Prof.dr.sc.Ivica Boko

Predsjednik Povjerenstva
za završne i diplomske ispite:
Izv. prof. dr. sc. Ivan Balić



Sadržaj:

1.	Tehnički opis	1
2.	Opis i prikaz 3D modela nadstrešnice	5
2.1.	Karakteristike materijala	7
2.1.1.	Beton	7
2.1.2.	Čelik	7
2.2.	Konstruktivni elementi u modelu	8
2.2.1.	Poprečni presjeci konstruktivnih elemenata	9
3.	Analiza opterećenja	14
3.1.	Stalno opterećenje	15
3.1.1.	Vlastita težina konstrukcije	15
3.1.2.	Dodatno stalno opterećenje	15
3.2.	Opterećenje snijegom	18
3.3.	Opterećenje vjetrom	21
3.4.	Opterećenje temperaturom	35
3.5.	Modalna analiza	37
4.	Dimenzioniranje konstrukcijskih elemenata	52
4.1.	Pokrovni elementi –„PK“	52
4.1.1.	Rezne sile pokrovnih elemenata	53
4.1.2.	Dimenzioniranje pokrovnih nosača	63
4.1.3.	Granično stanje uporabljivosti	74
4.2.	Trostruki stup „S1“	75
4.2.1.	Rezne sile trostrukog stupa „S1“	75
4.2.2.	Dimenzioniranje trostrukog stupa „S1“	80
4.2.3.	Granično stanje uporabljivosti	89
4.3.	Kosi dio trostrukih stupova „SK“	90
4.3.1.	Rezne sile kosog dijela stupa „S1“	90
4.3.2.	Dimenzioniranje kosog dijela stupa „S1“	95
4.4.	Stupovi niskog dijela nadstrešnice „S2“	104
4.4.1.	Rezne sile niskog dijela nadstrešnice „S2“	104
4.4.2.	Dimenzioniranje rubnog stupa nadstrešnice „S1“	107
4.5.	Rubni stup nadstrešnice „S3“	116
4.5.1.	Rezne sile niskog dijela nadstrešnice „S3“	116
4.5.2.	Dimenzioniranje rubnog stupa nadstrešnice „S3“	119
4.5.3.	Granično stanje uporabljivosti	128
5.	Dimenzioniranje spojeva	129
5.1.	Spoj stupa „S1“ sa temeljem	129
5.2.	Spoj stupa „S2“ sa temeljem	136
5.3.	Spoj kosog dijela stupa „S1“	147
5.4.	Karakteristični spoj sjecišta više štapova	158
5.5.	Karakteristično spoj vrha stupa „S2“	170
5.6.	Spoj vrha stupa „S3“	182
5.7.	Karakteristični spoj pokrova	192
5.8.	Karakteristični spoj pokrova i kosog dijela stupa „S1“	219
5.9.	Vlačni spoj rubnog stupa „S2“	226



5.10.	Vlačni spoj trostrukog stupa „S1“	232
6.	AB MONOLITNI ELEMENTI KONSTRUKCIJE.....	238
6.1.	AB temeljne stope	238
6.1.1.	Temeljna stopa „TS1“	238
6.1.2.	Temeljna stopa „TS2“	244
6.1.1.	Temeljna stopa „TS3“	250

1. Tehnički opis

Općenito

Ovim diplomskim radom obrađen je projekt nadogradnje i rekonstrukcije shopping centra „King Cross“, specifično čelične nadstrešnice na sjeveroistočnom pročelju građevine. Zahvat obuhvaća izgradnju čelične nadstrešnice s pripadajućim temeljima samcima.

Lokacija

Gradnja predmetne građevine je predviđena u ulici Velimira Škoprika 34 na parceli postojećeg shopping centra. Nadstrešnica se pruža duž cijelog sjeveroistočnog pročelja.

Karakteristike i namjena građevine

Predmetna nadstrešnica će primarno imati estetsku funkciju. Duljina nadstrešnice u smjeru pročelja je cca 270 m dok se širina kreće od 3 do 16 m. Visina konstrukcije varira na najnižem dijelu oko 5 m dok na najvišem od 13 do 16 m. Svi konstruktivni elementi su čelični izuzev temeljnih stopa koje su betonske.

Opis konstrukcije

Nosivu konstrukciju čini sustav čeličnih stupova i greda u razini pokrova. Pokrov i cjelokupna konstrukcija je nepravilnog oblika.

Stupovi „S1“ (CFCHS 219 x 12,5), „S2“ (CFCHS 355,6 x 8,0) i „S3“ (CFCHS 355,6 x 8,0) su povezani upetom vezom za AB temelje samce te su raspoređeni po nepravilnom rasteru. Stupovi „S1“ se postavljaju jedan do drugoga te se pri vrhu povezuju kratkim elementima istog poprečnog presjeka kako bi se osigurala dostatna krutost sustava. Kosi dijelovi stupa „SK1“ (CFCHS 219 x 12,5) se nastavljaju iznad čvorova na kojima su stupovi ukrućeni te prihvaćaju barem u jednom čvoru krovne nosače „PK“ (CFCHS 273x8,0) koji na sebi pridržavaju pokrov. Pokrov je formiran od ravnih žica između strukturalnog trokuta kojeg formiraju pokrovni elementi „PK“. Pokrovni elementi su uglavnom nenatrikveni i međusobno su spojeni varom, čeonim varom ili spojnom pločicom. Ukrućni elementi stupa „S1“ su spojeni varom dok su sami stupovi čeonom pločicom uhvaćeni za kosi dio stupa

„SK1“. Na zapadnom rubu nadstrešnice se nalazi rubni stup „S3“ dok su na najnižem dijelu stupovi „S2“. „TS1“ je AB temelj samac stupova „S1“ i „S2“ dimenzija 220 x 220 x 100 cm, „TS2“ dimenzija 300 x 300 x 100 je temelj samac stupa „S3“ i stupova „S1“. Samci „TS3“ 250 x 250 x 100 nalaze se podno stupova „S1“ na sjeveroistočnom rubu nadstrešnice.

Materijal za izradu konstrukcije

Svi čelični elementi su klase S 355. Konstruktivni elementi će međusobno biti povezani s varovima te vlačnim nastavkom s pločicama i vijcima kvalitete M 20 8,8. Spoj stupa sa samcima je izveden pomoću podne pločice koja je povezana s ankerima kvalitete M30 10,9 za stupove „S1“ i „S3“ te M20 10,9 za stupove „S2“. Karakteristični spoj sjecišta više elemenata i spojeva gdje se elementi završavaju korištenu su ukrutne pločice kvalitete S 355. Pokrovna konstrukcija je mreža tankih žica. Za temelje samce je korišten beton kvalitete C 30/37.

Antikorozivna zaštita

Odabrana je zaštita pocinčavanjem koja se ostvaruje nanošenjem prevlake cinka i po toplom postupku. Mase i debljine prevlaka cinka za pojedine elemente određene su prema Pravilniku o tehničkim mjerama i uvjetima za zaštitu čeličnih konstrukcija od korozije i ne mogu biti manje od 500 mg/m² elementa debljine 5mm. Sve čelične konstrukcije prethodno treba odmastiti, očistiti razblaženom otopinom klorovodične kiseline te isprati hladnom vodom. Neposredno prije pocinčavanja čelična konstrukcija se stavlja u taljevinu ili otopinu za flusiranje.

Toplo pocinčavanje se izvodi stavljanjem tekućine u rastopljeni cink. Cink mora biti kvaliteta Zn 97,5 do Zn 99,5 prema HRN EN ISO 14713:2001. Prevlaka cinka dobivena toplim postupkom mora biti homogena i mora prekrivati osnovicu. Prevlaka cinka mora čvrsto prijanjati za čeličnu površinu i ne smije se ljuštiti niti pucati pri uporabi. Prije montaže potrebno je izvršiti kontrolu prevlake cinka prema HRN C.A1. 558, odnosno mase prevlake cinka prema HRN A6.021.

Montaža konstrukcije

Izvedba konstrukcije je na licu mjesta varenjem. Svi elementi konstrukcije predgotovljeni stižu na gradilište. Stupovi se međusobno vežu vijčanim spojem. Nulta faza montaže, nakon izvedenih svih prethodnih radova je montaža stupova. Stup se postavi na ankere koji su postavljeni u temelje te se pridržaje dizalicom dok se ne postigne vertikalnost pomoću dvostrukih vijaka. Nakon provjere vertikalnosti, vrši se ispunjenje prostora ispod spojne ploče i temelja ekspandirajućim mortom.

Zaštitni sloj betona do armature

Minimalna debljina zaštitnog sloja betona se utvrđuje u ovisnosti o razredu izloženosti (suhi okoliš), načinu armiranja te traženoj požarnoj otpornosti elemenata konstrukcije.

Za razred izloženosti XC2 (temelji samci) $c_{min.}=35$ mm.

U skladu sa navedenim, imajući u vidu traženu vatrootpornost usvaja se za:

- Temelji $c_{nom.}= 35$ mm

Temeljenje

Na predmetnoj lokaciji očekivana projektirana nosivost temeljnog tla iznosi:
 $q_{Rd}=300,0$ kN/m²

Lokacija i opterećenja

Sva opterećenja na konstrukciju uzeta su prema Europskoj normi EN-1991.

Opterećenje vjetrom

Opterećenje vjetrom odabrano je prema: EC1, Dio 2-4: Djelovanja vjetra i Europskoj normi EN 1991-2-4: Djelovanja na konstrukcije opterećene vjetrom te Nacionalnom dokumentu za primjenu u Republici Hrvatskoj .

Shopping centar „King Cross“ lociran je u gradu Zagrebu u ulici Velimira Škorpika 34 na k.č.br. 2761/1, 2766, 2767, 2703/1, 2703/2, 2704/2 sve k.o. Podsused. Prema Karti osnovne brzine vjetra RH kao osnovna brzina vjetra uzeta je $v_{b,0}=25,0$ m/s.

Opterećenje snijegom

Shopping centar „King Cross“ lociran je u gradu Zagrebu u ulici Velimira Škorpika 34 na k.č.br. 2761/1, 2766, 2767, 2703/1, 2703/2, 2704/2 sve k.o. Podsused te prema važećim propisima proračunsko opterećenje snijegom iznosi:

$$S_k = 1,25 \text{ kN/m}^2$$

Seizmičke značajke terena

Shopping centar „King Cross“ lociran je u gradu Zagrebu u ulici Velimira Škorpika 34 na k.č.br. 2761/1, 2766, 2767, 2703/1, 2703/2, 2704/2 sve k.o. Podsused . Ubrzanje tla za promatranu lokaciju iznosi $a_g=0.252$ g za povratni period od 475 godina te $a'_g=0.127$ g za povratni period od 95 godina. Temeljno tlo se prema Eurocodu može svrstati u razred “C” (po dokumentu HRN ENV, 1998-1-1:2004).

2. Opis i prikaz 3D modela nadstrešnice

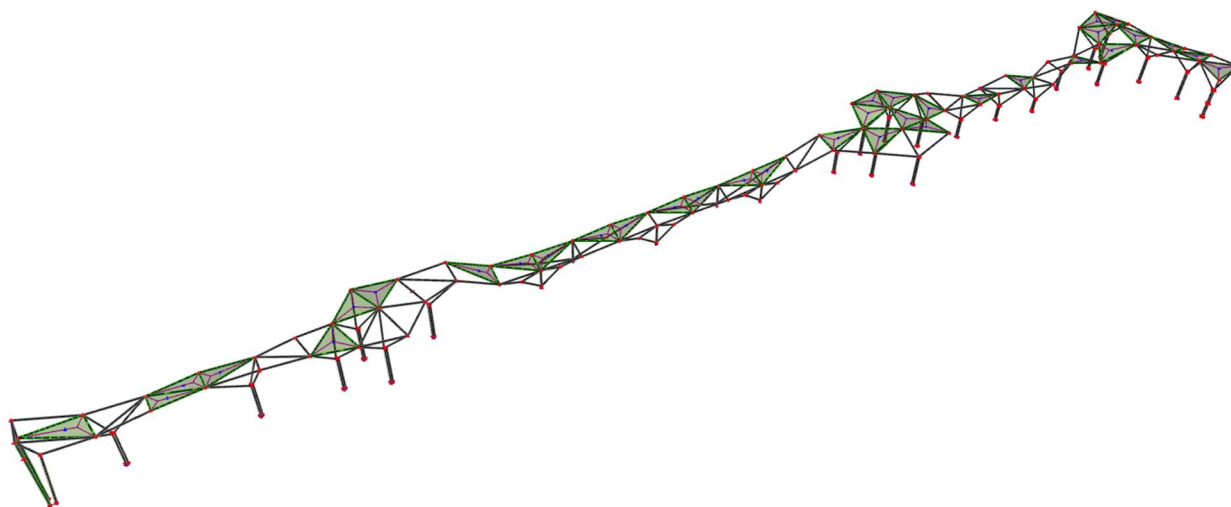

Slika 1: Aksonometrijski prikaz nadstrešnice

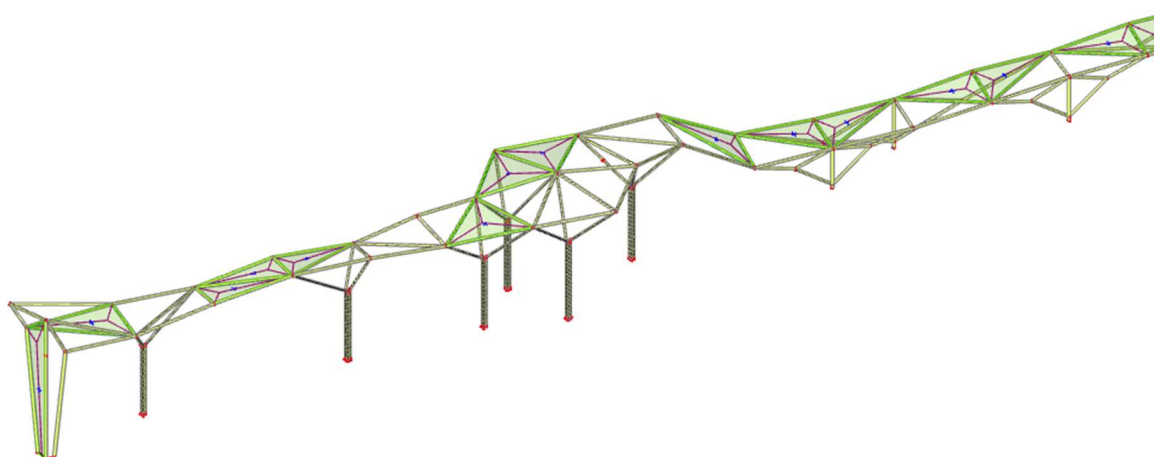

Slika 2: Aksonometrijski prikaz modela od osi N1 do osi N8

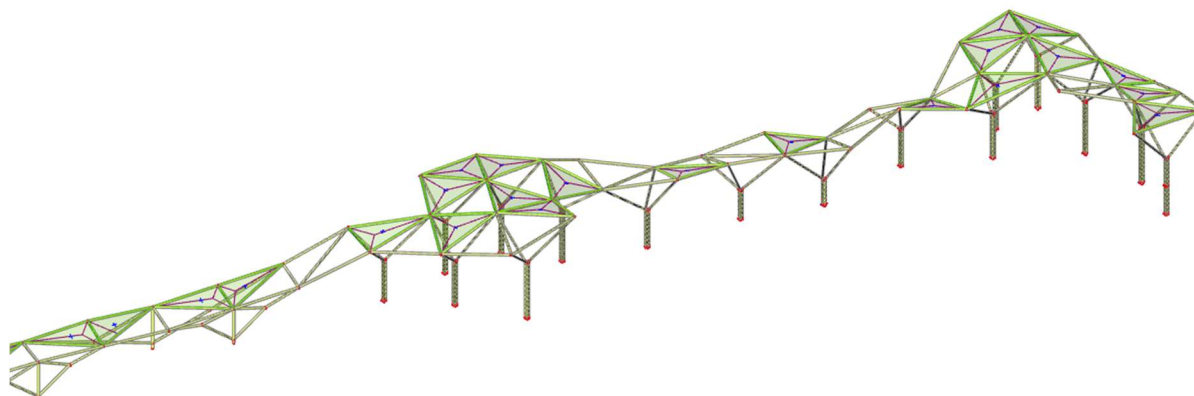

Slika 3: Aksonometrijski prikaz modela od osi N8 do osi N27

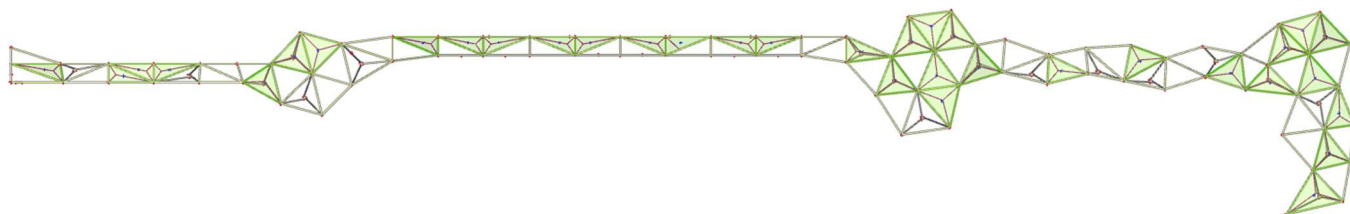

Slika 4: Tlocrtni prikaz nadstrešnice

:

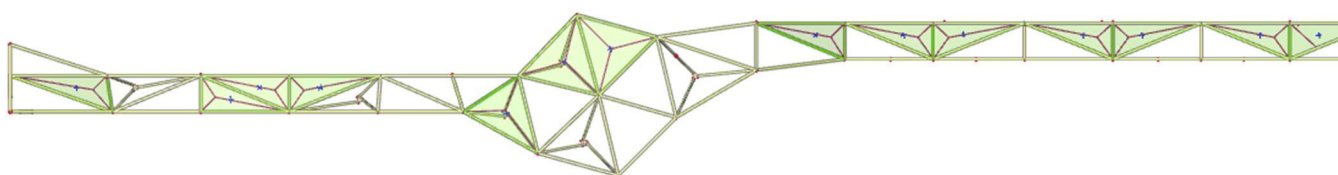

Slika 5: Tlocrtni prikaz nadstrešnice od osi N1 do osi N8

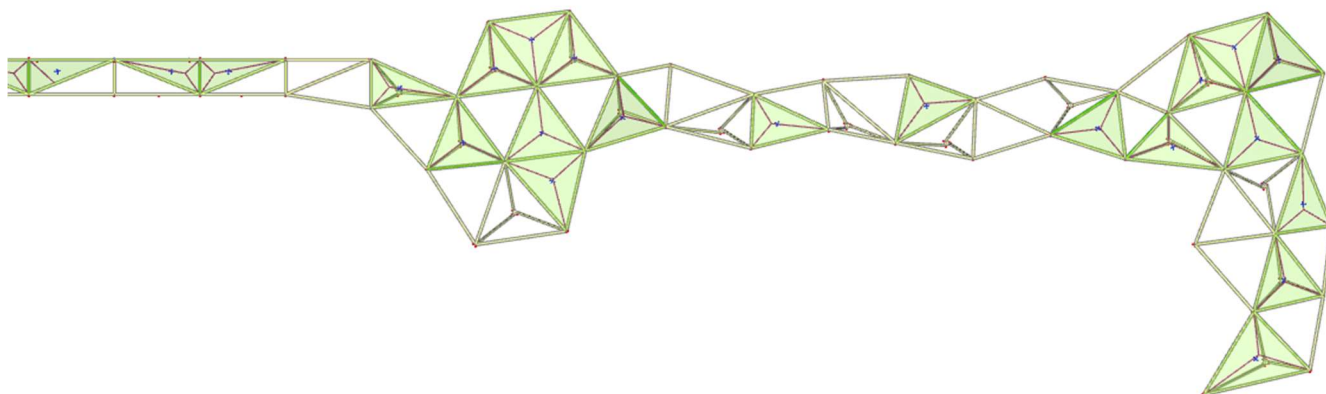

Slika 6: Tlocrtni prikaz nadstrešnice od osi N8 do osi N27

2.1. Karakteristike materijala

2.1.1. Beton

Materijal	Beton
Klasa betona	C30/37
Jedinična masa ρ [kg/m ³]	2500.0
Modul elastičnosti E_{mod} [MPa]	3.1500e+04
Modul posmika G [MPa]	1.3667e+04
Poissonov koeficijent μ	0.2
karakteristična tlačna čvrstoća betona nakon 28 dana $f_{c,k,28}$ [MPa]	30.00
srednja tlačna čvrstoća f_{cm} [MPa]	38.00
$f_{cm}(28) - f_{ck}(28)$ [MPa]	25.00
srednja osna vlačna čvrstoća f_{ctm} [MPa]	2.90
proračunska tlačna čvrstoća (osnovna komb.) f_{cd} [MPa]	20
proračunska tlačna čvrstoća (izvanredna komb.) f_{cd} [MPa]	25

2.1.2. Čelik

Klasa čelika	S 355
Jedinična masa ρ [kg/m ³]	7850.0
Modul elastičnosti E_{mod} [MPa]	2.1000e+05
Modul posmika G_{mod} [MPa]	8.0769e+04
Poissonov koeficijent μ	0.3
F_y [MPa]	355.0

2.2. Konstruktivni elementi u modelu

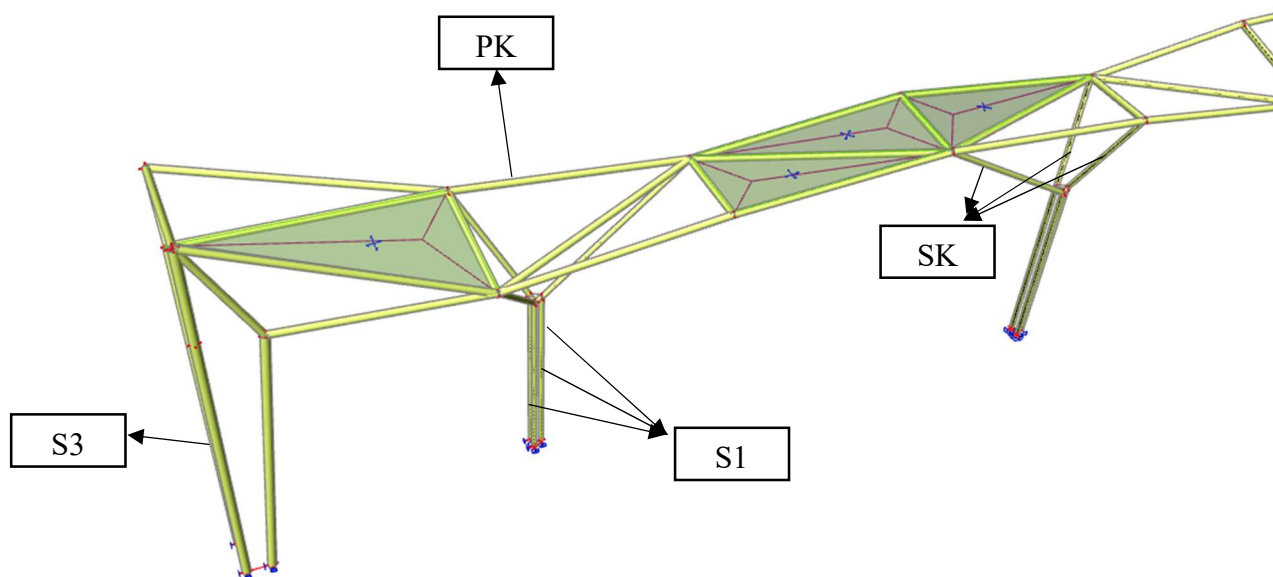

Slika 7: Prikaz konstruktivnih elemenata u modelu

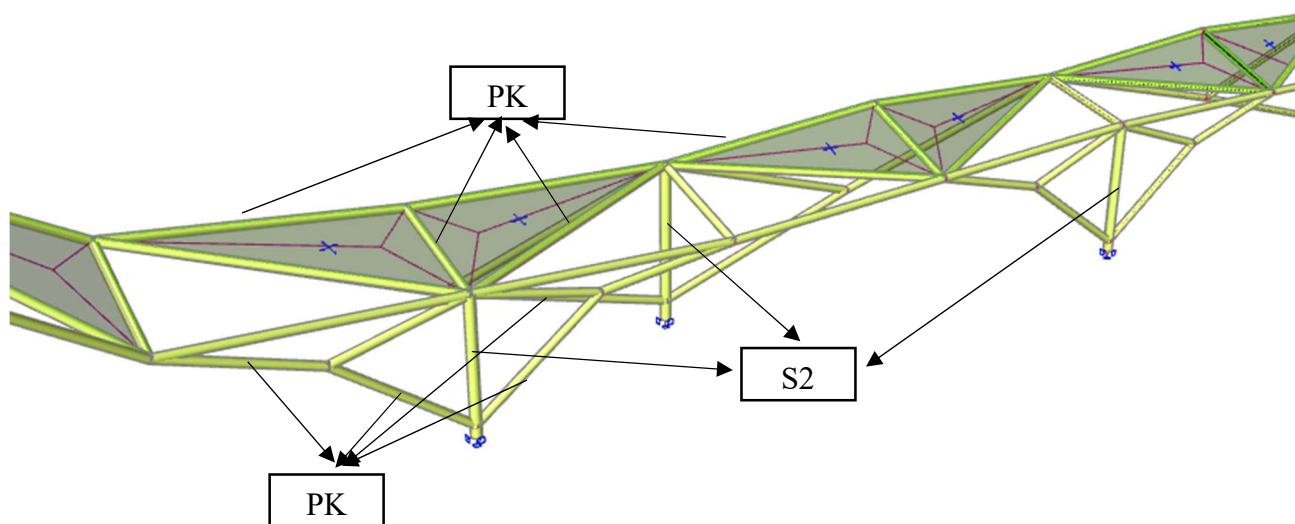

Slika 8: Prikaz konstruktivnih elemenata u modelu

2.2.1. Poprečni presjeci konstruktivnih elemenata

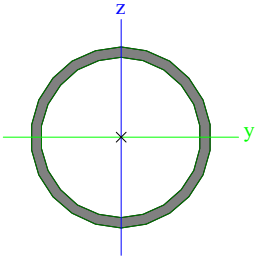
Trostruki stup – „S1“		
Type	CFCHS219.1X12.5	
Formcode	3 - Circular hollow section	
Shape type	Thin-walled	
Item material	S 355	
Fabrication	cold formed	
Colour		
Flexural buckling y-y, Flexural buckling z-z	c	c
A [m ²]	8,1130e-03	
A _y [m ²], A _z [m ²]	5,1650e-03	5,1650e-03
A _L [m ² /m], A _D [m ² /m]	6,8800e-01	1,2980e+00
C _{y,UCS} [mm], C _{z,UCS} [mm]	110	110
α [deg]	0,00	
I _y [m ⁴], I _z [m ⁴]	4,3446e-05	4,3446e-05
i _y [mm], i _z [mm]	73	73
W _{el,y} [m ³], W _{el,z} [m ³]	3,9658e-04	3,9658e-04
W _{pl,y} [m ³], W _{pl,z} [m ³]	5,3420e-04	5,3420e-04
M _{pl,y,+} [Nm], M _{pl,y,-} [Nm]	189581,66	189581,66
M _{pl,z,+} [Nm], M _{pl,z,-} [Nm]	189581,66	189581,66
d _y [mm], d _z [mm]	0	0
I _t [m ⁴], I _w [m ⁶]	8,6892e-05	8,8785e-40
β _y [mm], β _z [mm]	0	0
Picture		

Tablica 1: Geometrijske karakteristike karakterističnog stupa „S1“ – CFRHS 219.1x12.5

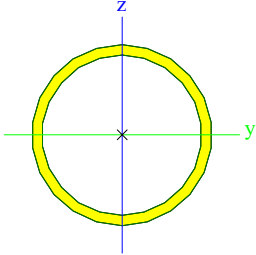
Kosi dio stupa S1-,, SK1"		
Type	CFCHS219.1X12.5	
Formcode	3 - Circular hollow section	
Shape type	Thin-walled	
Item material	S 355	
Fabrication	cold formed	
Colour		
Flexural buckling y-y, Flexural buckling z-z	c	c
A [m ²]	8,1130e-03	
A _y [m ²], A _z [m ²]	5,1650e-03	5,1650e-03
A _L [m ² /m], A ₀ [m ² /m]	6,8800e-01	1,2980e+00
C _{y,UCS} [mm], C _{z,UCS} [mm]	110	110
α [deg]	0,00	
I _y [m ⁴], I _z [m ⁴]	4,3446e-05	4,3446e-05
i _y [mm], i _z [mm]	73	73
W _{el,y} [m ³], W _{el,z} [m ³]	3,9658e-04	3,9658e-04
W _{pl,y} [m ³], W _{pl,z} [m ³]	5,3420e-04	5,3420e-04
M _{pl,y,+} [Nm], M _{pl,y,-} [Nm]	189581,66	189581,66
M _{pl,z,+} [Nm], M _{pl,z,-} [Nm]	189581,66	189581,66
d _y [mm], d _z [mm]	0	0
I _t [m ⁴], I _w [m ⁶]	8,6892e-05	8,8785e-40
β _y [mm], β _z [mm]	0	0
Picture		

Tablica 2: Geometrijske karakteristike kosog dijela karakterističnog stupa „S1“ - CFRHS 219.1x12.5

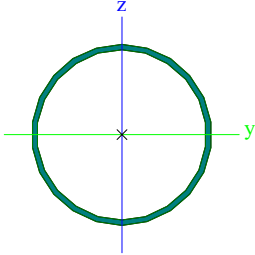
Krovni nosači – „PK“		
Type	CFCHS273X8	
Formcode	3 - Circular hollow section	
Shape type	Thin-walled	
Item material	S 355	
Fabrication	cold formed	
Colour		
Flexural buckling y-y, Flexural buckling z-z	c	c
A [m ²]	6,6600e-03	
A _y [m ²], A _z [m ²]	4,2400e-03	4,2400e-03
A _L [m ² /m], A _D [m ² /m]	8,5800e-01	1,6650e+00
C _{y,UCS} [mm], C _{z,UCS} [mm]	136	136
α [deg]	0,00	
I _y [m ⁴], I _z [m ⁴]	5,8517e-05	5,8517e-05
i _y [mm], i _z [mm]	94	94
W _{el,y} [m ³], W _{el,z} [m ³]	4,2870e-04	4,2870e-04
W _{pl,y} [m ³], W _{pl,z} [m ³]	5,6197e-04	5,6197e-04
M _{pl,y,+} [Nm], M _{pl,y,-} [Nm]	199438,82	199438,82
M _{pl,z,+} [Nm], M _{pl,z,-} [Nm]	199438,82	199438,82
d _y [mm], d _z [mm]	0	0
I _t [m ⁴], I _w [m ⁶]	1,1703e-04	8,0163e-40
β _y [mm], β _z [mm]	0	0
Picture		

Tablica 3: Geometrijske karakteristike karakterističnog krovnog nosača „PK“ – CFRHS 273x8

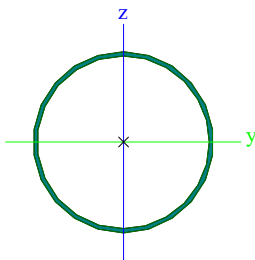
Stup niskog dijela nadstrešnice – „S2“		
Type	CFCHS355.6X8	
Formcode	3 - Circular hollow section	
Shape type	Thin-walled	
Item material	S 355	
Fabrication	cold formed	
Colour		
Flexural buckling y-y, Flexural buckling z-z	c	c
A [m ²]	8,7360e-03	
A _y [m ²], A _z [m ²]	5,5616e-03	5,5616e-03
A _L [m ² /m], A ₀ [m ² /m]	1,1170e+00	2,1839e+00
C _{y,UCS} [mm], C _{z,UCS} [mm]	178	178
α [deg]	0,00	
I _y [m ⁴], I _z [m ⁴]	1,3201e-04	1,3201e-04
i _y [mm], i _z [mm]	123	123
W _{el,y} [m ³], W _{el,z} [m ³]	7,4250e-04	7,4250e-04
W _{pl,y} [m ³], W _{pl,z} [m ³]	9,6680e-04	9,6680e-04
M _{pl,y,+} [Nm], M _{pl,y,-} [Nm]	343101,21	343101,21
M _{pl,z,+} [Nm], M _{pl,z,-} [Nm]	343101,21	343101,21
d _y [mm], d _z [mm]	0	0
I _t [m ⁴], I _w [m ⁶]	2,6403e-04	7,8644e-39
β _y [mm], β _z [mm]	0	0
Picture		

Tablica 4: Geometrijske karakteristike karakterističnog stupa „S2“ – CFRHS 355.6x12

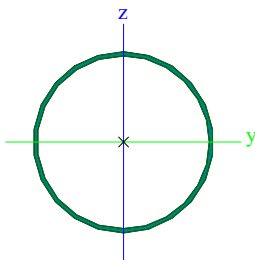
Rubni stup nadstrešnice -S3		
Type	CFCHS355.6X8	
Formcode	3 - Circular hollow section	
Shape type	Thin-walled	
Item material	S 355	
Fabrication	cold formed	
Colour		
Flexural buckling y-y, Flexural buckling z-z	c	c
A [m ²]	8,7360e-03	
A _y [m ²], A _z [m ²]	5,5616e-03	5,5616e-03
A _L [m ² /m], A ₀ [m ² /m]	1,1170e+00	2,1839e+00
C _{y,UCS} [mm], C _{z,UCS} [mm]	178	178
α [deg]	0,00	
I _y [m ⁴], I _z [m ⁴]	1,3201e-04	1,3201e-04
i _y [mm], i _z [mm]	123	123
W _{el,y} [m ³], W _{el,z} [m ³]	7,4250e-04	7,4250e-04
W _{pl,y} [m ³], W _{pl,z} [m ³]	9,6680e-04	9,6680e-04
M _{pl,y,+} [Nm], M _{pl,y,-} [Nm]	343101,21	343101,21
M _{pl,z,+} [Nm], M _{pl,z,-} [Nm]	343101,21	343101,21
d _y [mm], d _z [mm]	0	0
I _t [m ⁴], I _w [m ⁶]	2,6403e-04	7,8644e-39
β _y [mm], β _z [mm]	0	0
Picture		

Tablica 5: Geometrijske karakteristike rubnog stupa „S3“ – CFRHS 355.6x8

3. Analiza opterećenja

Opterećenje u modelu je zadano kao površinsko po panelima koji simuliraju pokrov napravljen od žica između trokutastog strukturalnog elementa sačinjenog od krovnih elemenata „PK“. Opterećenje se preko panela direktno prenosi na krovne nosače s kojih se prenosi do stupova sve do temelja. Promjenjiva djelovanja vjetra, temperature i snijega su nanesena i na profile.

Popis opterećenja primijenjenih u modelu

Opterećenje	Smjer opterećenja
dg - dodatno stalno	Z
Wp- pritisak	Z
Wo - odizanje	Z
Wx - pritisak	X
Wy - pritisak	Y
T^+ - zagrijavanje	u smjeru osi štapa
T^+ - hlađenje	u smjeru osi štapa
S - snijeg	Z
Sx- seizmičko djelovanje	X
Sy- seizmičko djelovanje	Y

Tablica 6: Prikaz opterećenja zadanih u modelu

3.1. Stalno opterećenje

3.1.1. Vlastita težina konstrukcije

Vlastita težina konstrukcija je automatski uzeta u obzir unutar software-a.

3.1.2. Dodatno stalno opterećenje

- 1) Opterećenje pokrova konstrukcije - 20 kg/m^2
- 2) Opterećenje rasvjete stupova nadstrešnice - $20 \text{ kg/m}'$

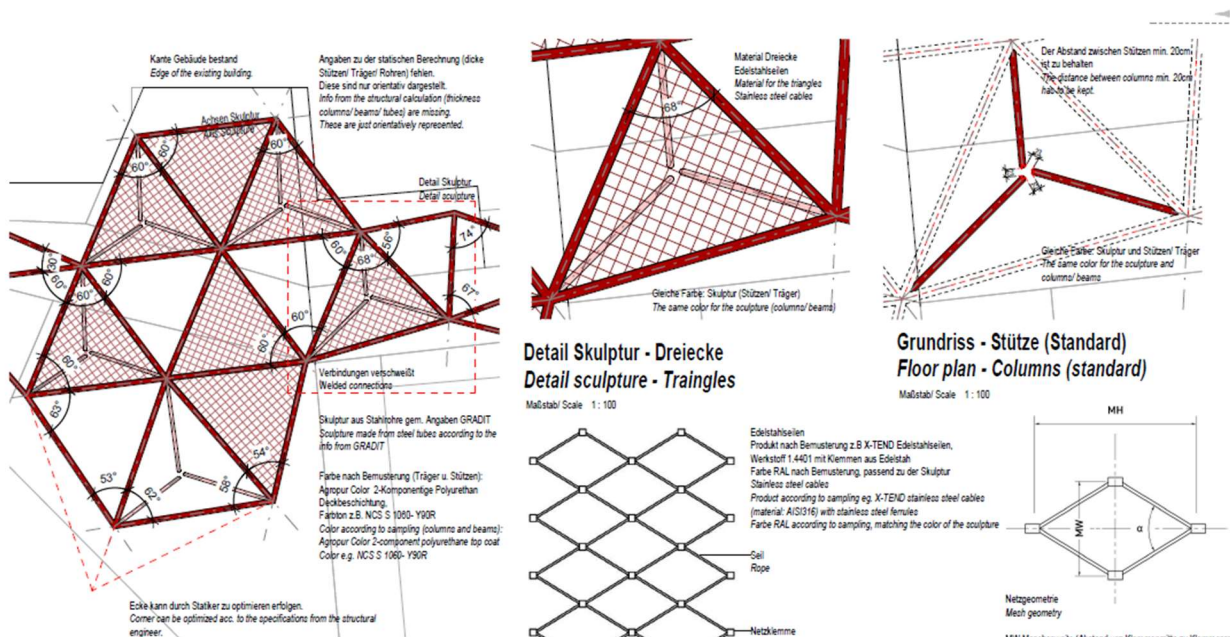

Slika 9: Prikaz pokrova nadstrešnice

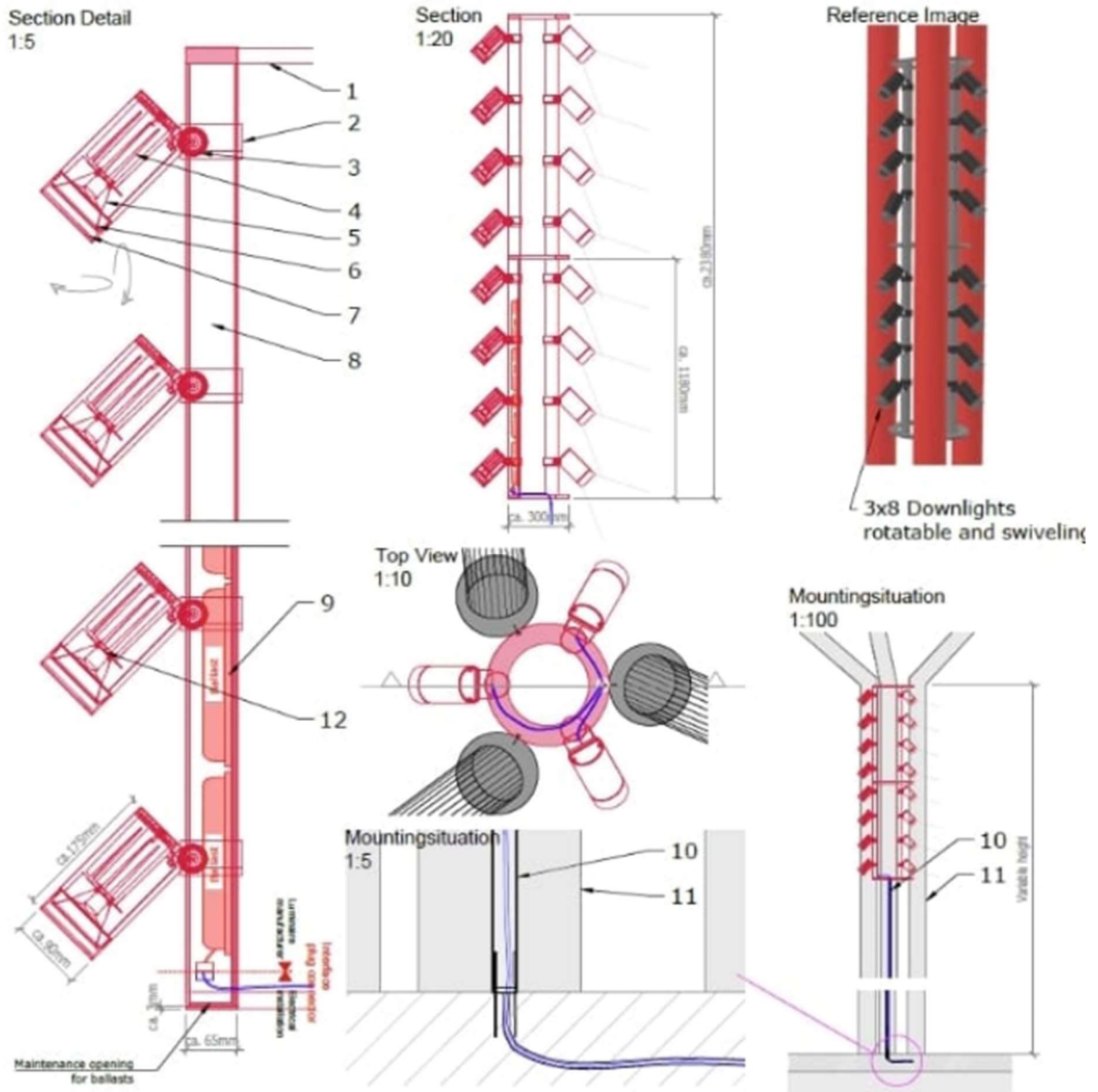

Slika 10: Prikaz rasvjete stupova

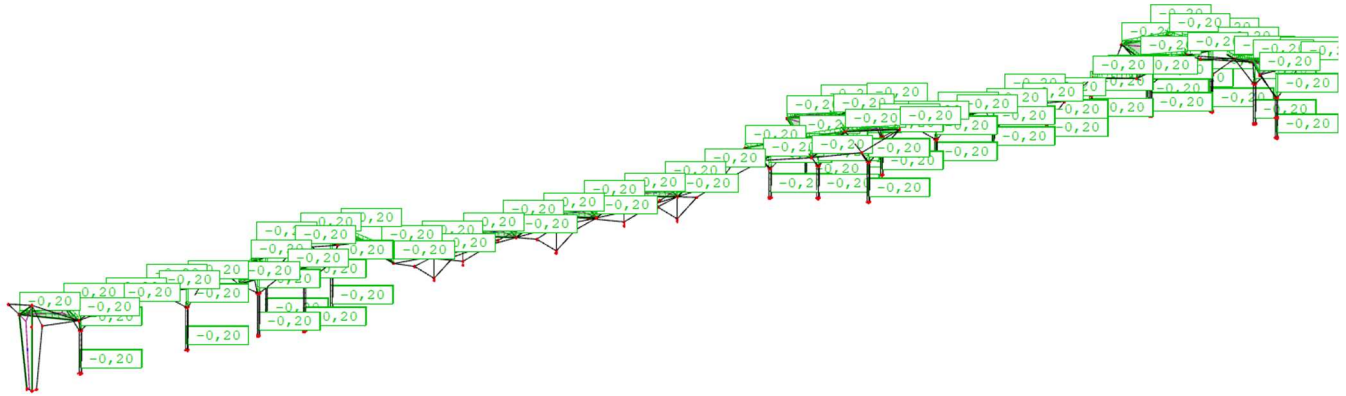

Slika 11: Prikaz dodatnog stalnog opterećenja „dg“
(kN/m^2 -pokrov; kN/m' -profili)

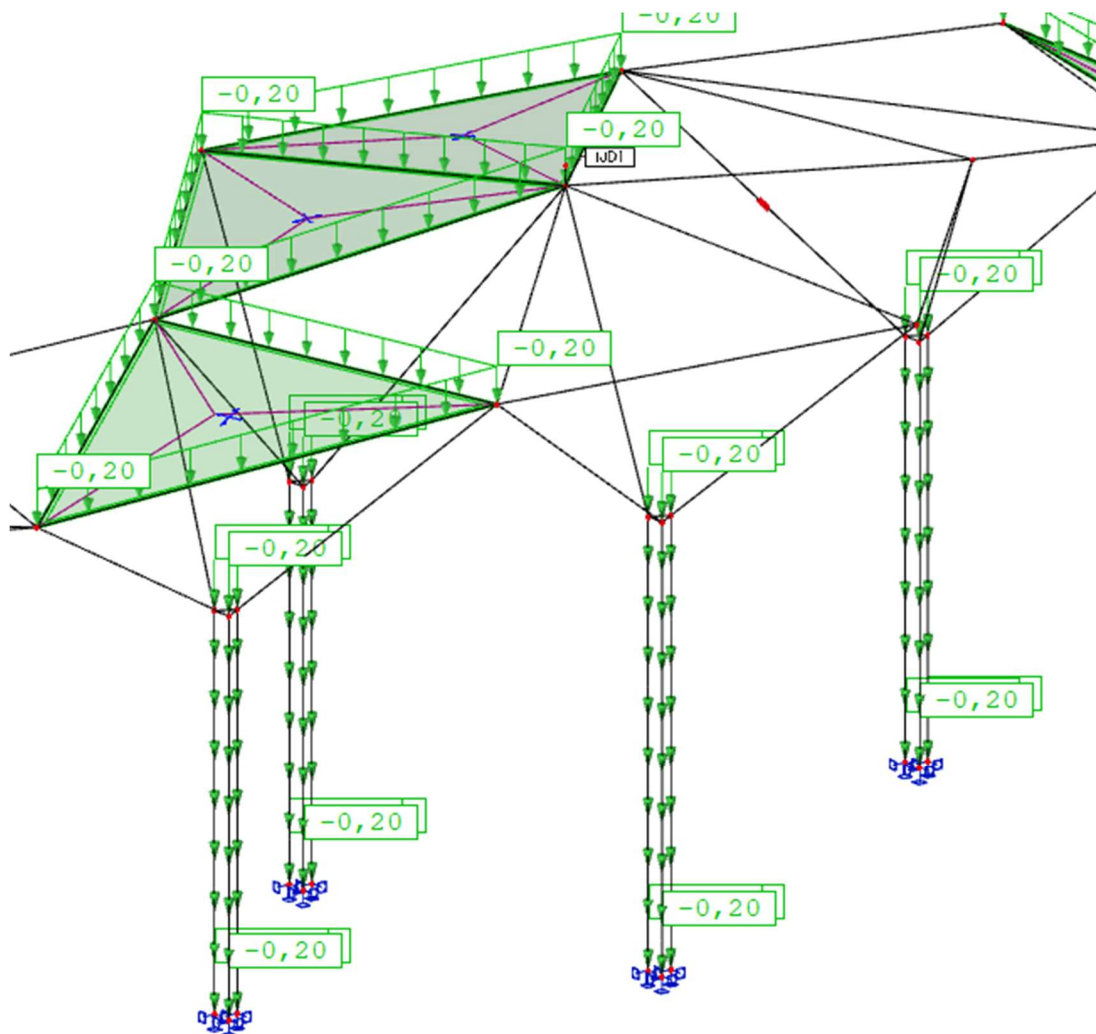

Slika 12: Prikaz dijela konstrukcije opterećenog dodatnim stalnim opterećenjem „dg“ (kN/m^2 -pokrov; kN/m' -profili)

3.2. Opterećenje snijegom

Opterećenje snijegom svrstava se u promjenjivo slobodno opterećenje. Opterećenja snijegom proračunavaju se na osnovi karakterističnog opterećenja s_k , koje odgovara jednolikom snijegu koji je napadao pri mirnim vremenskim uvjetima na ravno tlo. Ova se vrijednost prilagođava ovisno o obliku krova i utjecaju vjeta na raspodjelu snijega.

Opterećenje snijegom na krovu:

$$s = \mu_i \cdot c_e \cdot c_t \cdot s_k$$

μ_i – koef. oblika opterećenja snijegom

ravni krov $0^\circ \leq \alpha \leq 30^\circ$

krov nagiba $\alpha_1 = \alpha_2 = 0.6^\circ \rightarrow \mu_1 = 0.8$

s_k – karakteristična vrijednost opterećenja na tlu [kN/m^2]



Slika 13: Karta područja opterećenja snijegom

Slika 14: Opterećenja snijegom za snježna područja i pripadajuće nadmorske visine

Nadmorska visina do [m]	1. područje – priobalje i otoci [kN/m ²]	2. područje – zaleđe Dalmacije, Primorja i Istre [kN/m ²]	3. područje – kontinentalna Hrvatska [kN/m ²]	4. područje – gorska Hrvatska [kN/m ²]
100	0,50	0,75	1,00	1,25
200	0,50	0,75	1,25	1,50
300	0,50	0,75	1,50	1,75
400	0,50	1,00	1,75	2,00
500	0,50	1,25	2,00	2,50
600	0,50	1,50	2,25	3,00
700	0,50	2,00	2,50	3,50
800	0,50	2,50	2,75	4,00
900	1,00	3,00	3,00	4,50
1 000	2,00	4,00	3,50	5,00
1 100	3,00	5,00	4,00	5,50
1 200	4,00	6,00	4,50	6,00
1 300	5,00	7,00		7,00
1 400	6,00	8,00		8,00
1 500		9,00		9,00
1 600		10,00		10,00
1 700		11,00		11,00
1 800		12,00		

Zagreb se nalaze u 3. zoni (očitano sa slike iznad), nadmorska visina do 200 m →
 $s_k = 1.25 \text{ [kN/m}^2\text{]}$

PRORAČUN SNIJEGA NA JEDNOSTREŠNI KROV

Ulazni parametri:

Područje: 3. područje-kontinentalna Hrvatska

Nadmorska visina do: 200 m.n.m. $s_k = 1,25 \text{ kN/m}^2$

Nagib jednostrešnog krova: $\alpha = 0^\circ$

Na objektu postoje snjegobrani/parapeti: NE

$$c_e = 1,0 \quad \mu_1 = 0,80 \quad s = 1,00 \text{ kN/m}^2$$

$$c_t = 1,0 \quad \mu_2 = 0,80 \quad S = \mu_i \cdot c_e \cdot c_t \cdot s_k$$

Proračun snijega na pokrovne elemente:

$$S_{\text{pokrovni element}} = 1,00 \text{ kN/m}^2 \cdot 0,27 \text{ m} = 0,27 \text{ kN/m}'$$

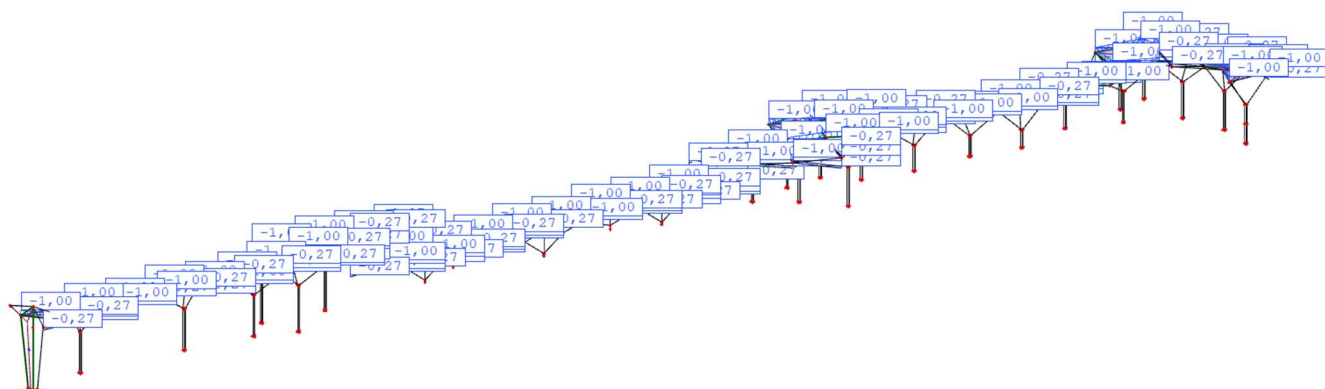

Slika 15: Prikaz opterećenja snijegom na konstrukciju „s“
(kN/m^2 -pokrov; Kn/m' -profili)

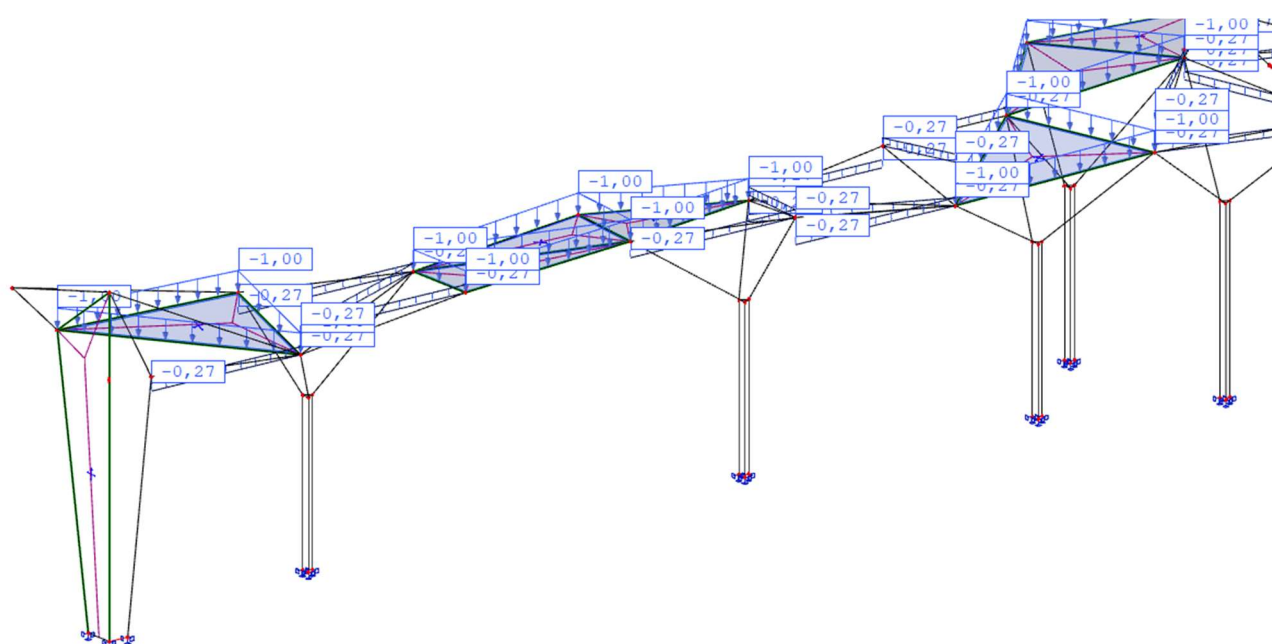

Slika 16: Prikaz opterećenja snijegom na konstrukciju „s“
(kN/m^2 -pokrov; Kn/m' -profili)

3.3. Opterećenje vjetrom

Temeljna vrijednost osnovne brzine vjetra $v_{b,0}$ određuje se iz karte osnovne brzine vjetra za svaku državu posebno, a koja je sastavni dio Nacionalnog dodatka (kod nas HRN EN 1991-1-4:2012/NA). Karta osnovne brzine vjetra prikazana je na slici ispod.

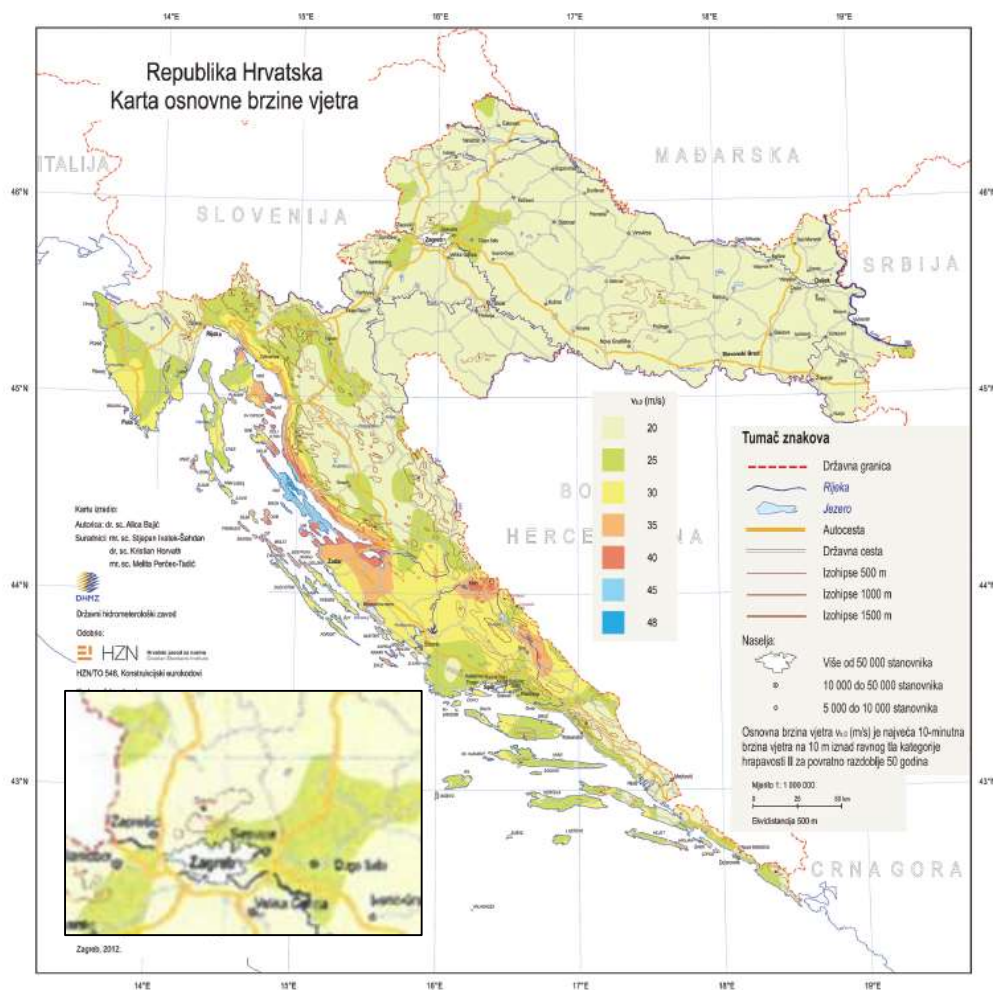

Slika 17: Osnovna brzina vjetra $v_{b,0}$

Očitano s karte:

$$v_{b,0} = \boxed{25.0 \text{ m/s}} - \text{temeljna vrijednost osnovne brzine vjetra}$$

v_b - osnovna brzina vjetra

$$\rightarrow v_b = c_{dir} \cdot c_{season} \cdot v_{b,0}$$

c_{dir} - faktor smjera vjetra

$$\rightarrow \boxed{1.0} \text{ (preporučena vrijednost)}$$

c_{season} - faktor godišnjeg doba

$$\rightarrow \boxed{1.0} \text{ (preporučena vrijednost)}$$

$$v_b = \boxed{25.0 \text{ m/s}}$$

Proračun tlaka pri vršnoj brzini

$q_p(z)$ - tlak pri vršnoj brzini na visini z	→	$q_p(z) = c_e(z) \cdot q_b$
$c_e(z)$ - faktor izloženosti	→	faktor u ovisnosti o kategoriji terena i visini objekta iznad tla
q_b - tlak pri osnovnoj brzini	→	$q_b = \frac{1}{2} \rho \cdot v_b^2 = 390,6 \text{ N/m}^2$ (0,391 kN/m ²)
ρ - gustoća zraka	→	1,25 kg/m ³
$c_0(z)$ - faktor vertikalne razvedenosti	→	1,0 (preporučena vrijednost)
k_1 - faktor turbulencije	→	1,0 (preporučena vrijednost)

Kategorija terena: Područja sa stalnim pokrovom od vegetacije ili zgrade ili područja s izoliranim preprekama s razmakom najviše 20 visina prepreke (npr. sela, predgrađa, stalna šuma)

Visina z iznad terena:

Za kategoriju terena III i visinu iznad terena 14 m za slučaj ravnog terena ($C_0=1,0$) faktor izloženosti terena očitava se sa slike.

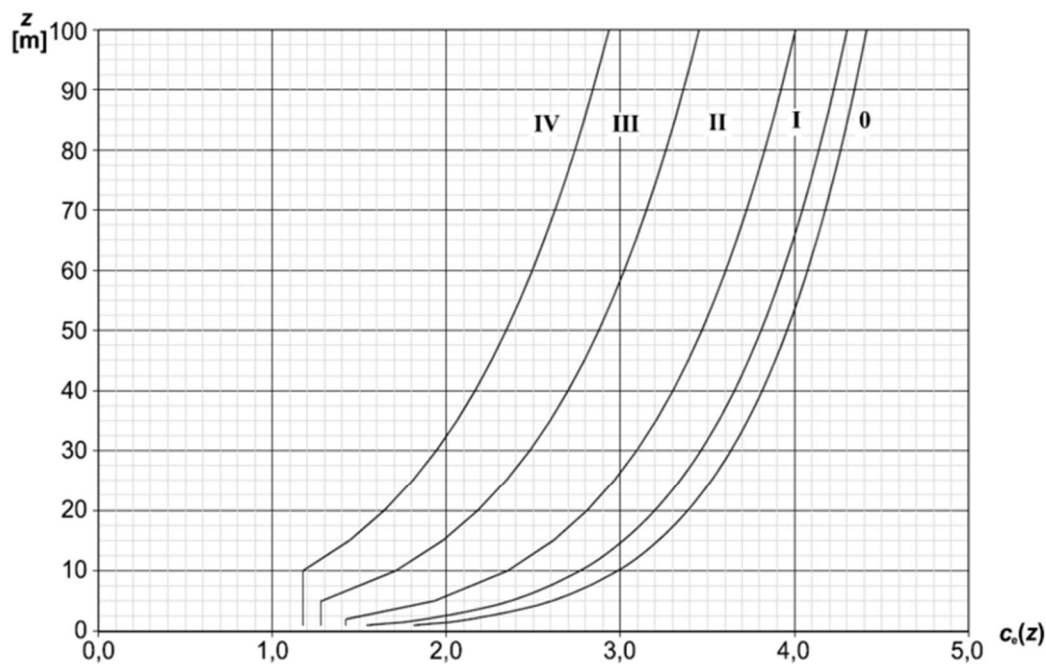

Očitano sa slike: $c_e(z) =$

$q_p(z)$ - tlak pri vršnoj brzini na visini z → $q_p(z) =$ kN/m²

3. Tlak vjetra na površine

$$w_e - \text{tlak vjetra na vanjske površine} \quad \rightarrow \quad w_e = q_p(z_e) \cdot c_{pe}$$

$$w_i - \text{tlak vjetra na unutarnje površine} \quad \rightarrow \quad w_i = q_p(z_i) \cdot c_{pi}$$

$q_p(z_e), q_p(z_i)$ - tlak pri vršnoj brzini na visini z

c_e - koeficijent tlaka za vanjski tlak

z_e - referentna visina za vanjski tlak

c_i - koeficijent tlaka za unutarnji tlak

z_i - referentna visina za unutarnji tlak

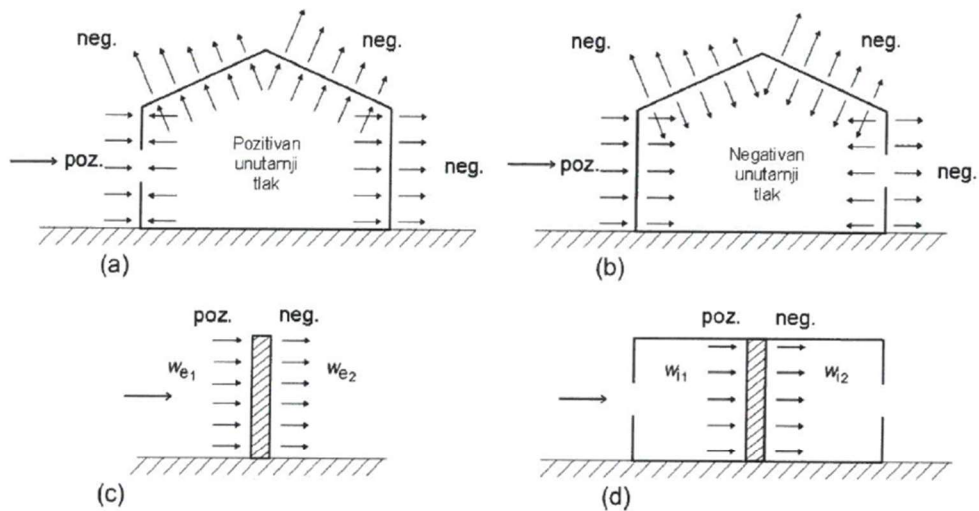

Neto tlak na zid, krov ili element razlika je tlakova na suprotnim površinama uzimajući u obzir njihove predznake. Tlak usmjeren prema površini uzima se kao pozitivan, a usisavanje, usmjereno od površine kao negativno.

Proračun vjetra za jednostrešnu nadstrešnicu

kut nagiba nadstrešnice- $\alpha=0^\circ$

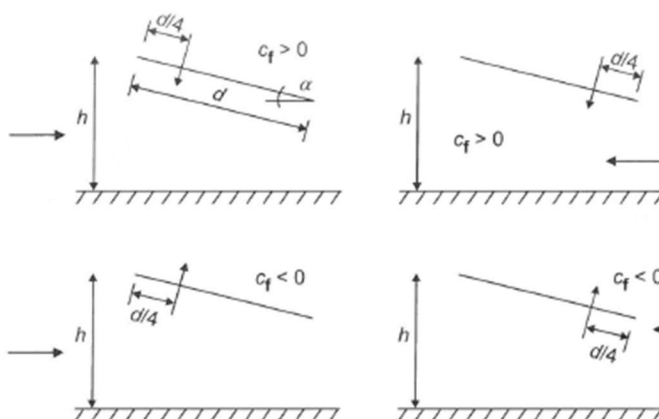

stupanj zapriječenosti (zatvorenosti) ispod krova- $\varphi=0,5$

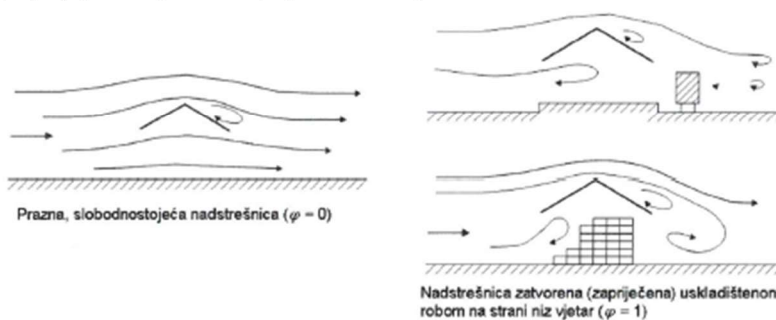

tlocrt

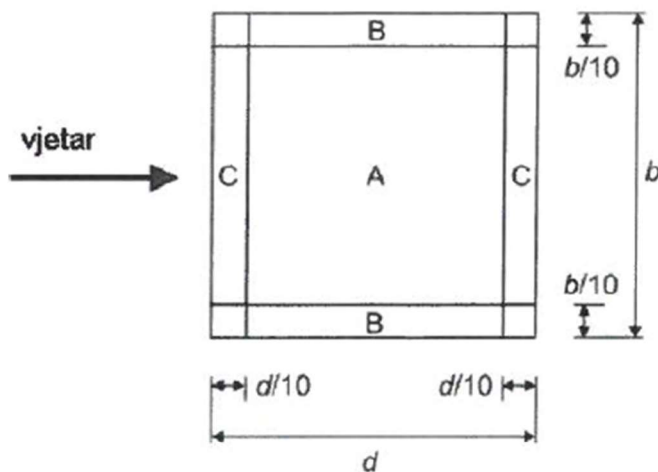

b (duljina u smjeru okomitom na smjer djelovanja vjetra)=	6,0 m
d (duljina u smjeru djelovanja vjetra)=	6,0 m
h (visina nadstrešnice prema slici)=	14,0 m

$l_{A,d}$ (duljina zone A)=	4,8 m
$l_{B,d}$ (duljina zone B)=	6,0 m
$l_{C,d}$ (duljina zone C)=	0,6 m

$l_{A,b}$ (duljina zone A)=	4,8 m
$l_{B,b}$ (duljina zone B)=	0,6 m
$l_{C,b}$ (duljina zone C)=	6,0 m

Oznaka: $l_{A,b}$ -duljina zone A u smjeru okomitom na smjer vjetra

$l_{A,d}$ -duljina zone A u smjeru vjetra

	C_f	A	B	C
najveća vrijednost (svi φ) $C_{p,net}$	0,20	0,50	1,80	1,10
0	-0,90	-1,05	-1,55	-1,80
5	-1,05	-1,35	-1,95	-2,15
10	-1,15	-1,55	-2,30	-2,40
15	-1,25	-1,70	-2,65	-2,75
20	-1,35	-1,90	-2,85	-2,95
25	-1,50	-2,05	-2,85	-3,00
30	-1,60	-2,25	-3,00	-3,15
najmanja vrijednost ($\varphi=0,5$) $C_{p,net}$	-0,90	-1,05	-1,55	-1,80

Tablica vrijednosti koeficijenata vanjskoga tlaka za jednostrešne nadstrešnice

	A	B	C
$C_{p,net}$	0,50	1,80	1,10
$q_p(z_e)$	0,76	0,76	0,76
$w_1(kN/m^2)$	0,38	1,36	0,83
Rezultirajuće djelovanje vjetra $W_1(kN/m^2)$ na jednostrešnu nadstrešnicu			

	A	B	C
$C_{p,net}$	-1,05	-1,55	-1,80
$q_p(z_e)$	0,76	0,76	0,76
$w_1(kN/m^2)$	-0,79	-1,17	-1,36
Rezultirajuće djelovanje vjetra $W_2(kN/m^2)$ na jednostrešnu nadstrešnicu			

Kako bi se pojednostavio proračun zona „B“ se usvojila kao mjerodavna za cijeli pokrovni element.

PRORAČUN VJETRA NA KRUŽNI ČELIČNI PROFIL-"TROSTRUKI STUPOVI "S1"

Ulazni parametri:

$$b = \boxed{0,219} \text{ m}$$

(promjer poprečnog presjeka)

$$l = \boxed{9} \text{ m}$$

$$z_e = \boxed{9} \text{ m}$$

$$A_{ref} = \boxed{1,971} \text{ m}^2$$

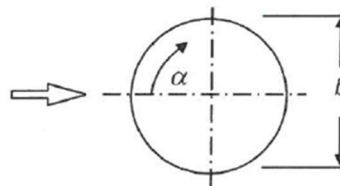

A_{ref} – referentna površina djelovanja vjetra

b – promjer kružnog profila

l – duljina elementa

z_e – visina elementa iznad tla

Kategorija terena:

III

(Područja sa stalnim pokrovom od vegetacije ili zgrade ili područja s izoliranim preprekama s razmakom najviše 20 visina prepreke (npr. sela, predgrađa, stalna šuma))

$$z_{min} = \boxed{5,0} \text{ m}$$

$$z_{max} = \boxed{200} \text{ m}$$

$$z_0 = \boxed{0,300} \text{ m}$$

$$z_{0,II} = \boxed{0,05} \text{ m}$$

$$v_{b,0} = \boxed{25} \text{ m/s}$$

$$C_{dir} = \boxed{1,0}$$

$$C_{season} = \boxed{1,0}$$

$$v_b = \boxed{25} \text{ m/s}$$

$v_{b,0}$ – osnovna vrijednost brzine vjetra
(očitano s karte u normi HRN EN 1991 – 4. NA)

$$v_b = C_{dir} \cdot C_{season} \cdot v_{b,0}$$

Proračun tlaka vjetra

$$\rho = \boxed{1,25} \text{ kg/m}^3$$

$$q_b = \boxed{390,6} \text{ N/m}^2$$

$$q_b = \frac{1}{2} \cdot \rho \cdot v_b^2$$

ρ – gustoća zraka

q_b – tlak pri osnovnoj brzini

$q_p(z)$ – tlak pri vršnoj brzini na visini z

$$C_e(z_e) = \boxed{1,641}$$

$$q_p(z) = \boxed{0,641} \text{ kN/m}^2$$

$$q_p(z) = C_e(z) \cdot q_b$$

$$k_r = 0,19 \cdot \left(\frac{z_0}{z_{0,II}} \right)^{0,07}$$

$$v_m(z) = C_r(z) \cdot C_0(z) \cdot v_b$$

$$k_r = \boxed{0,2154}$$

$$C_r(z_e) = \boxed{0,733}$$

$$v_m(z) = \boxed{18,31} \text{ m/s}$$

$$I_v(z) = \frac{\sigma_v}{v_m(z)} = \frac{k_1}{c_0(z) \cdot \ln\left(\frac{z}{z_0}\right)}$$

$$C_0(z_e) = \boxed{1}$$

$$k_1 = \boxed{1}$$

$$I_v(z) = \boxed{0,2940}$$

$$q_p(z_e) = [1 + 7I_v(z)] \cdot \frac{1}{2} \cdot \rho \cdot v_m^2$$

$$q_p(z_e) = \boxed{641,1} \text{ N/m}^2$$

Reynoldsov broj: $Re = \frac{b \cdot v_{(ze)}}{\nu}$

b – promjer kružnog profila

ν – kinematska viskoznost zraka ($\nu=15 \times 10^{-6}$ m²/s prema HRN EN1991-1-4; 7.9.1(1))

$v_{(ze)}$ – vršna brzina vjetra

$$v_{(ze)} = \left(\frac{2 \cdot q_{p(z_e)}}{\rho} \right)^{0.5}$$

$$v_{(ze)} = \boxed{32,03} \text{ m/s}$$

$$Re = \boxed{4,676E+05}$$

Proračunska vitkost:

$$l = \boxed{9,00} \text{ m}$$

Faktor učinka kraja:

$$\psi_{\lambda} = \boxed{0,940}$$

Za kružne cilindre gdje je $l < 15.0$ m:

$$\lambda = \min\left(\frac{l}{b}; 70\right)$$

$$\lambda = \boxed{41,096}$$

Koeficijent sile:

$$c_f = c_{f,0} \cdot \psi_{\lambda}$$

$c_{f,0}$ – koeficijent sile za valjke bez toka preko slobodnog kraja

ψ_{λ} – faktor učinka kraja

$$c_{f,0} = c_{f,0} \cdot \psi_r \cdot \psi_{\lambda}$$

$$C_{f,0} = \boxed{0,760}$$

$$C_f = \boxed{0,714}$$

Ukupna sila vjetra:

$$F_w = c_s c_d \cdot c_f \cdot q_p(z_e) \cdot A_{ref}$$

A_{ref} – referentna površina konstrukcije

F_w – ukupna sila vjetra na konstrukciju

$c_s c_d$ – konstrukcijski faktor

$$A_{ref} = \boxed{1,971} \text{ m}^2 \quad A_{ref} = b \cdot l$$

$$C_s C_d = \boxed{1}$$

$$F_w = \boxed{0,903} \text{ kN}$$

$$w_{eff} = \frac{F_w}{A_{ref}}$$

$$w_{eff} = \boxed{0,458} \text{ kN/m}^2$$

$$w_e = w_{eff} \cdot b$$

$$w_e = \boxed{0,100} \text{ kN/m}$$

PRORAČUN VJETRA NA KRUŽNI ČELIČNI PROFIL-STUPOVI "S3" I POKROV NISKO G DIJELA NADSTREŠNICE

Ulazni parametri:

$$b = \boxed{0,3556} \text{ m}$$

(promjer poprečnog presjeka)

$$l = \boxed{5,5} \text{ m}$$

$$z_e = \boxed{5,5} \text{ m}$$

$$A_{ref} = \boxed{1,9558} \text{ m}^2$$

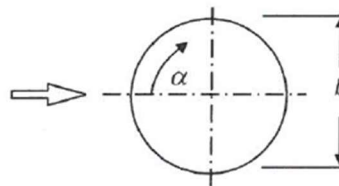

A_{ref} – referentna površina djelovanja vjetra

b – promjer kružnog profila

l – duljina elementa

z_e – visina elementa iznad tla

Kategorija terena:

(Područja sa stalnim pokrovom od vegetacije ili zgrade ili područja s izoliranim preprekama s razmakom najviše 20 visina prepreke (npr. sela, predgrađa, stalna šuma))

$$z_{min} = \boxed{5,0} \text{ m}$$

$$z_{max} = \boxed{200} \text{ m}$$

$$z_0 = \boxed{0,300} \text{ m}$$

$$z_{0,II} = \boxed{0,05} \text{ m}$$

$$v_{b,0} = \boxed{25} \text{ m/s}$$

$$C_{dir} = \boxed{1,0}$$

$$C_{season} = \boxed{1,0}$$

$$v_b = \boxed{25} \text{ m/s}$$

$v_{b,0}$ – osnovna vrijednost brzine vjetra
(očitano s karte u normi HRN EN 1991 – 4. NA)

$$v_b = C_{dir} \cdot C_{season} \cdot v_{b,0}$$

Proračun tlaka vjetra

$$\rho = \boxed{1,25} \text{ kg/m}^3$$

$$q_b = \boxed{390,6} \text{ N/m}^2$$

$$q_b = \frac{1}{2} \cdot \rho \cdot v_b^2$$

ρ – gustoća zraka

q_b – tlak pri osnovnoj brzini

$q_p(z)$ – tlak pri vršnoj brzini na visini z

$$C_e(z_e) = \boxed{1,337}$$

$$q_p(z) = \boxed{0,522} \text{ kN/m}^2$$

$$q_p(z) = C_e(z) \cdot q_b$$

$$k_r = 0,19 \cdot \left(\frac{z_0}{z_{0,II}} \right)^{0,07}$$

$$v_m(z) = C_r(z) \cdot C_0(z) \cdot v_b$$

$$k_r = \boxed{0,2154}$$

$$C_r(z_e) = \boxed{0,627}$$

$$v_m(z) = \boxed{15,66} \text{ m/s}$$

$$I_v(z) = \frac{\sigma_v}{v_m(z)} = \frac{k_1}{c_0(z) \cdot \ln\left(\frac{z}{z_0}\right)}$$

$$C_0(z_e) = \boxed{1}$$

$$k_1 = \boxed{1}$$

$$I_v(z) = \boxed{0,3438}$$

$$q_p(z_e) = [1 + 7I_v(z)] \cdot \frac{1}{2} \cdot \rho \cdot v_m^2$$

$$q_p(z_e) = \boxed{522,3} \text{ N/m}^2$$

Reynoldsov broj: $Re = \frac{b \cdot v_{(ze)}}{\nu}$

b – promjer kružnog profila

ν – kinematska viskoznost zraka ($\nu=15 \times 10^{-6}$ m²/s prema HRN EN1991-1-4; 7.9.1(1))

$v_{(ze)}$ – vršna brzina vjetra

$$v_{(ze)} = \left(\frac{2 \cdot q_{p(z_e)}}{\rho} \right)^{0.5}$$

$$v_{(ze)} = \boxed{28,91} \text{ m/s}$$

$$Re = \boxed{6,853E+05}$$

Proračunska vitkost:

$$l = \boxed{5,50} \text{ m}$$

Faktor učinka kraja:

$$\psi_{\lambda} = \boxed{0,920}$$

Za kružne cilindre gdje je $l < 15.0$ m:

$$\lambda = \min\left(\frac{l}{b}; 70\right)$$

$$\lambda = \boxed{15,467}$$

Koeficijent sile:

$$c_f = c_{f,0} \cdot \psi_{\lambda}$$

$c_{f,0}$ – koeficijent sile za valjke bez toka preko slobodnog kraja

ψ_{λ} – faktor učinka kraja

$$c_{f,0} = c_{f,0} \cdot \psi_r \cdot \psi_{\lambda}$$

$$C_{f,0} = \boxed{0,480}$$

$$C_f = \boxed{0,442}$$

Ukupna sila vjetra:

$$F_w = c_s c_d \cdot c_f \cdot q_p(z_e) \cdot A_{ref}$$

A_{ref} – referentna površina konstrukcije

F_w – ukupna sila vjetra na konstrukciju

$c_s c_d$ – konstrukcijski faktor

$$A_{ref} = \boxed{1,9558} \text{ m}^2 \quad A_{ref} = b \cdot l$$

$$C_s C_d = \boxed{1}$$

$$F_w = \boxed{0,451} \text{ kN}$$

$$w_{eff} = \frac{F_w}{A_{ref}}$$

$$w_{eff} = \boxed{0,231} \text{ kN/m}^2$$

$$w_e = w_{eff} \cdot b$$

$$w_e = \boxed{0,082} \text{ kN/m}$$

PRORAČUN VJETRA NA KRUŽNI ČELIČNI PROFIL- POKROV VIŠEG DIJELA NADSTREŠNICE

Ulazni parametri:

$$b = \boxed{0,273} \text{ m}$$

(promjer poprečnog presjeka)

$$l = \boxed{5} \text{ m}$$

$$z_e = \boxed{14} \text{ m}$$

$$A_{ref} = \boxed{1,365} \text{ m}^2$$

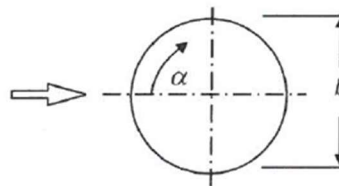

A_{ref} – referentna površina djelovanja vjetra

b – promjer kružnog profila

l – duljina elementa

z_e – visina elementa iznad tla

Kategorija terena:

III

(Područja sa stalnim pokrovom od vegetacije ili zgrade ili područja s izoliranim preprekama s razmakom najviše 20 visina prepreke (npr. sela, predgrađa, stalna šuma))

$$z_{min} = \boxed{5,0} \text{ m}$$

$$z_{max} = \boxed{200} \text{ m}$$

$$z_0 = \boxed{0,300} \text{ m}$$

$$z_{0,II} = \boxed{0,05} \text{ m}$$

$$v_{b,0} = \boxed{25} \text{ m/s}$$

$$C_{dir} = \boxed{1,0}$$

$$C_{season} = \boxed{1,0}$$

$$v_b = \boxed{25} \text{ m/s}$$

$v_{b,0}$ – osnovna vrijednost brzine vjetra
(očitano s karte u normi HRN EN 1991 – 4. NA)

$$v_b = C_{dir} \cdot C_{season} \cdot v_{b,0}$$

Proračun tlaka vjetra

$$\rho = \boxed{1,25} \text{ kg/m}^3$$

$$q_b = \boxed{390,6} \text{ N/m}^2$$

$$q_b = \frac{1}{2} \cdot \rho \cdot v_b^2$$

ρ – gustoća zraka

q_b – tlak pri osnovnoj brzini

$q_p(z)$ – tlak pri vršnoj brzini na visini z

$$C_e(z_e) = \boxed{1,933}$$

$$q_p(z) = \boxed{0,755} \text{ kN/m}^2$$

$$q_p(z) = C_e(z) \cdot q_b$$

$$k_r = 0,19 \cdot \left(\frac{z_0}{z_{0,II}} \right)^{0,07}$$

$$v_m(z) = C_r(z) \cdot C_0(z) \cdot v_b$$

$$k_r = \boxed{0,2154}$$

$$C_r(z_e) = \boxed{0,828}$$

$$v_m(z) = \boxed{20,69} \text{ m/s}$$

$$Iv(z) = \frac{\sigma_v}{v_m(z)} = \frac{k_1}{c_0(z) \cdot \ln\left(\frac{z}{z_0}\right)}$$

$$C_0(z_e) = \boxed{1}$$

$$k_1 = \boxed{1}$$

$$I_v(z) = \boxed{0,2602}$$

$$q_p(z_e) = [1 + 7Iv(z)] \cdot \frac{1}{2} \cdot \rho \cdot v_m^2$$

$$q_p(z_e) = \boxed{755,1} \text{ N/m}^2$$

Reynoldsov broj: $Re = \frac{b \cdot v_{(ze)}}{\nu}$

b – promjer kružnog profila

ν – kinematska viskoznost zraka ($\nu=15 \times 10^{-6}$ m²/s prema HRN EN1991-1-4; 7.9.1(1))

$v_{(ze)}$ – vršna brzina vjetra

$$v_{(ze)} = \left(\frac{2 \cdot q_{p(z_e)}}{\rho} \right)^{0.5}$$

$$v_{(ze)} = \boxed{34,76} \text{ m/s}$$

$$Re = \boxed{6,326E+05}$$

Proračunska vitkost:

$$l = \boxed{5,00} \text{ m}$$

Faktor učinka kraja:

$$\psi_{\lambda} = \boxed{0,930}$$

Za kružne cilindre gdje je $l < 15.0$ m:

$$\lambda = \min\left(\frac{l}{b}; 70\right)$$

$$\lambda = \boxed{18,315}$$

Koeficijent sile:

$$c_f = c_{f,0} \cdot \psi_{\lambda}$$

$c_{f,0}$ – koeficijent sile za valjke bez toka preko slobodnog kraja

ψ_{λ} – faktor učinka kraja

$$c_{f,0} = c_{f,0} \cdot \psi_r \cdot \psi_{\lambda}$$

$$C_{f,0} = \boxed{0,630}$$

$$C_f = \boxed{0,586}$$

Ukupna sila vjetra:

$$F_w = c_s c_d \cdot c_f \cdot q_p(z_e) \cdot A_{ref}$$

A_{ref} – referentna površina konstrukcije

F_w – ukupna sila vjetra na konstrukciju

$c_s c_d$ – konstrukcijski faktor

$$A_{ref} = \boxed{1,365} \text{ m}^2 \quad A_{ref} = b \cdot l$$

$$C_s C_d = \boxed{1}$$

$$F_w = \boxed{0,604} \text{ kN}$$

$$w_{eff} = \frac{F_w}{A_{ref}}$$

$$w_{eff} = \boxed{0,442} \text{ kN/m}^2$$

$$w_e = w_{eff} \cdot b$$

$$w_e = \boxed{0,121} \text{ kN/m'}$$

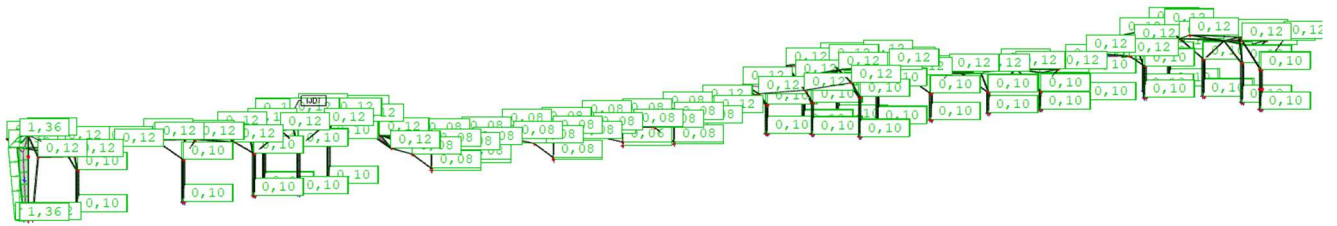

Slika 18: Opterećenje vjetra na profile „w“ smjer x (kN/m')

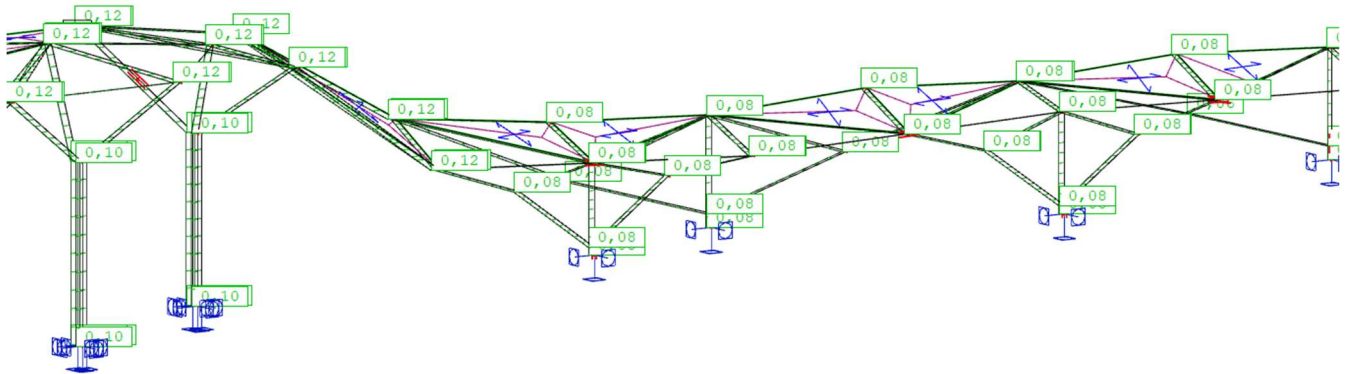

Slika 19: Prikaz dijela konstrukcije opterećenog vjetrom „w“ u smjeru x (kN/m')

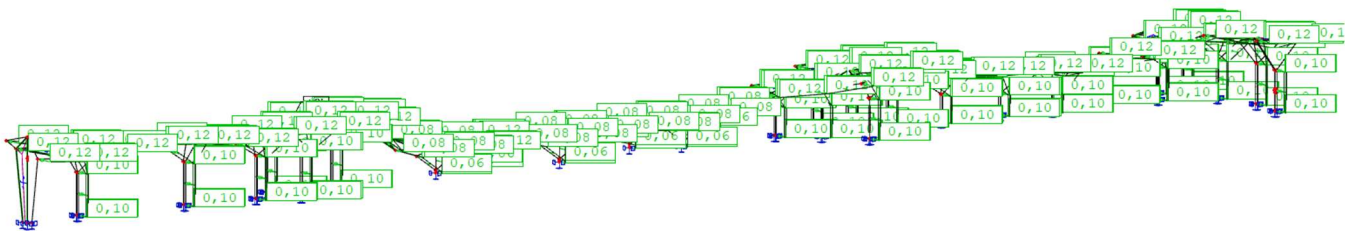

Slika 20: Opterećenje vjetra na profile „w“ smjer y (kN/m')

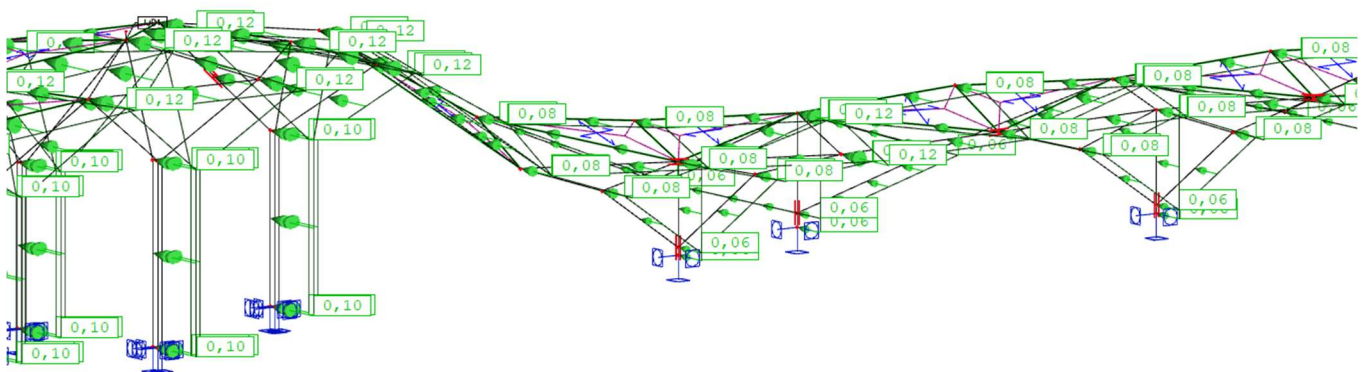

Slika 21: Prikaz dijela konstrukcije opterećenog vjetrom „w“ u smjeru y (kN/m')

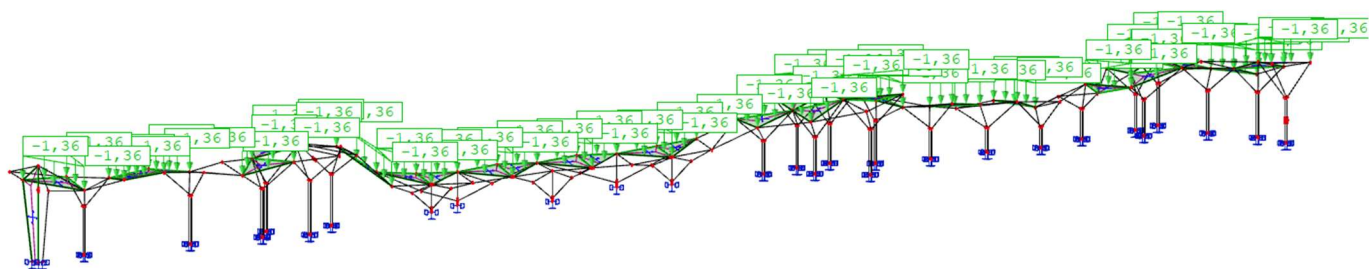

Slika 22: Opterećenje vjetra „w“ na pokrov -pritisak (kN/m²)

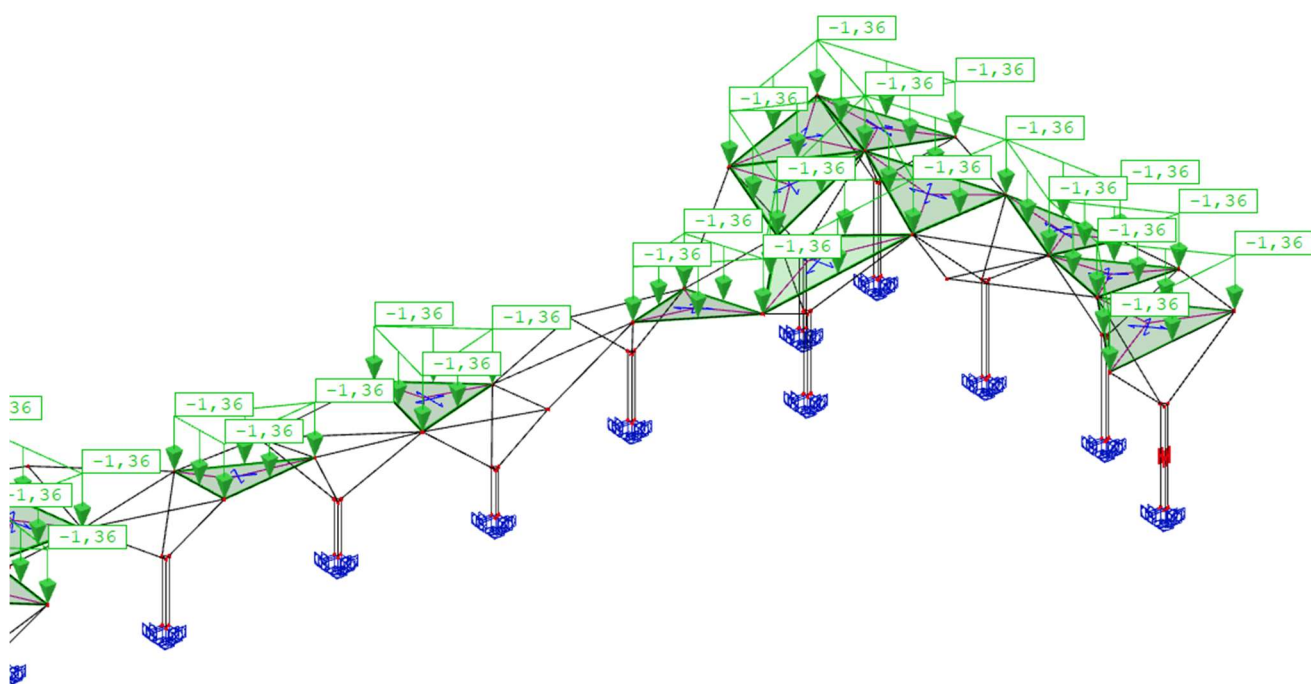

Slika 23: Prikaz dijela konstrukcije opterećenog pritiskajućim vjetrom „w“ (kN/m')

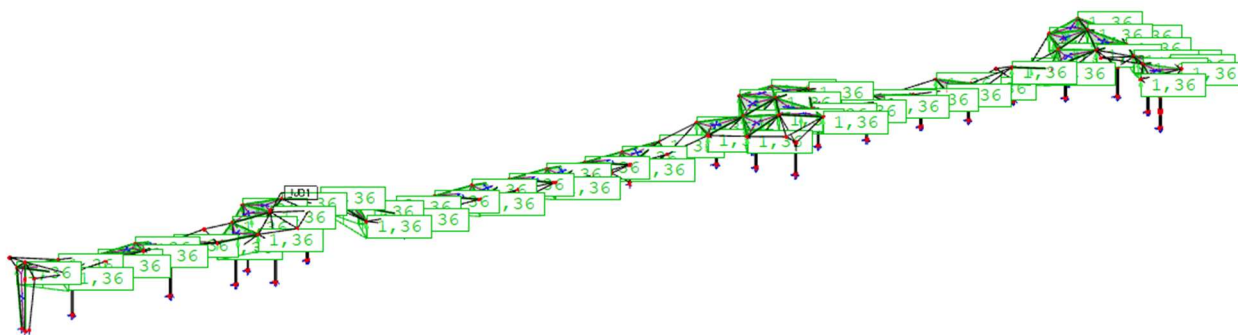

Slika 24: Opterećenje vjetra "w" na pokrov -odizanje (kN/m²)

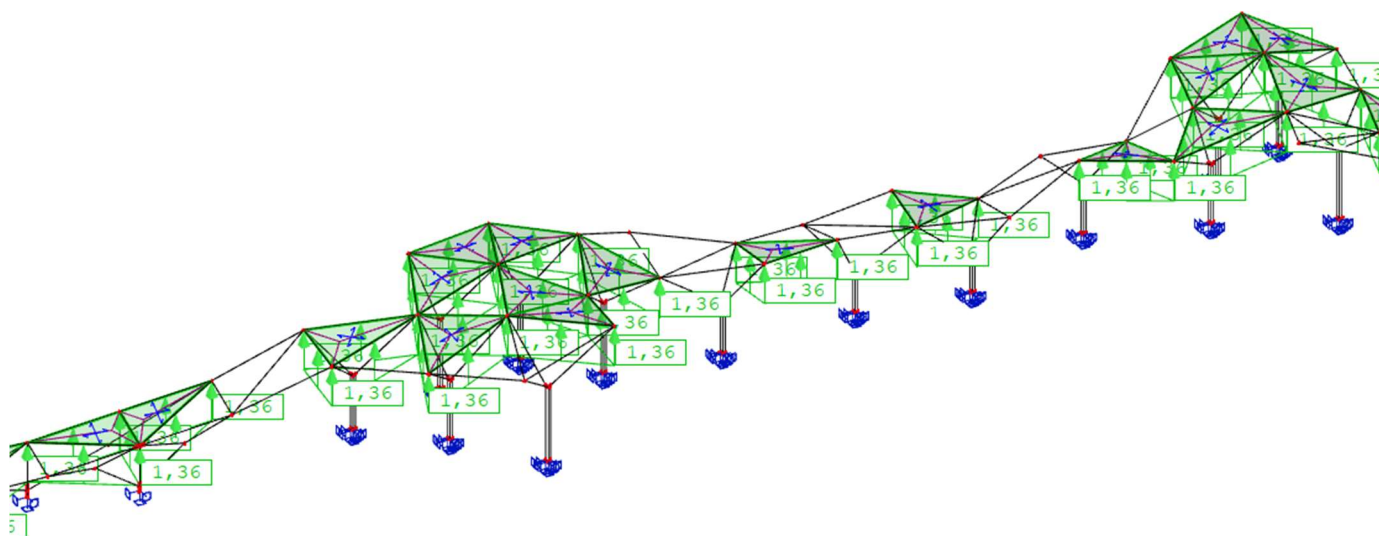

Slika 25: Prikaz dijela konstrukcije opterećenog odizućim vjetrom „w“ (kN/m')

3.4. Opterećenje temperaturom

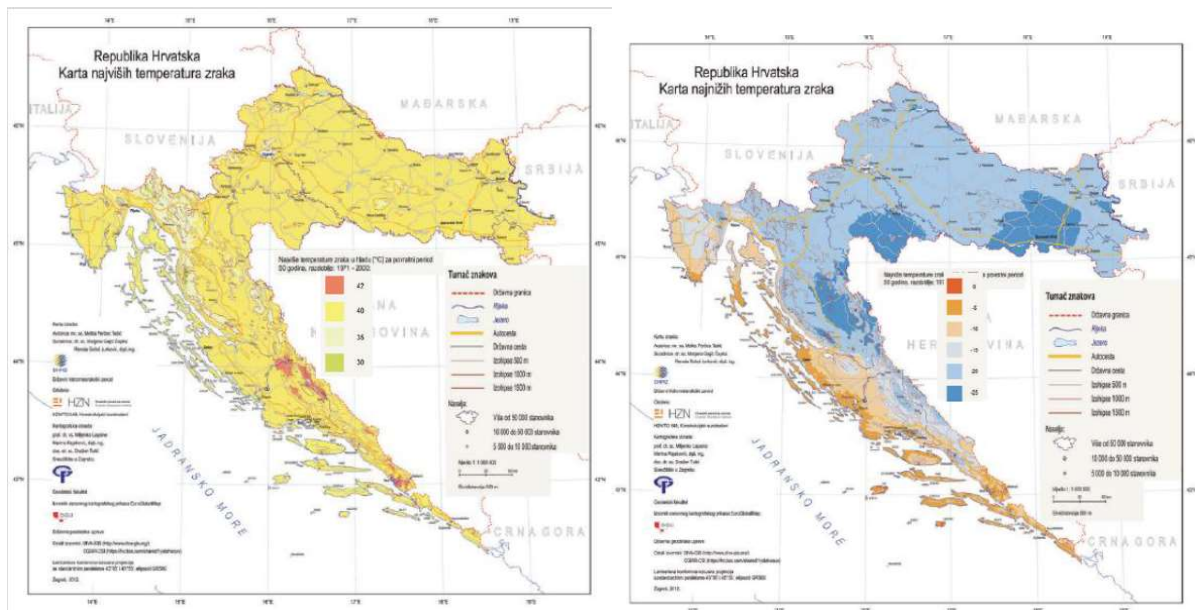

Slika 26: Karta područja opterećenja temperaturom T_{max} i T_{min}

Promatrani objekt nalazi se na području Zagreba do 200 m nadmorske visine:

Najviša temperatura u hladu: $T_{max} = 40\text{ }^{\circ}\text{C}$

Najniža temperatura u hladu: $T_{min} = -20\text{ }^{\circ}\text{C}$

Pretpostavlja se djelovanje jednolike temperature promjene u svim presjecima.

Pretpostavljena temperatura pri montaži konstrukcije $T = 10\text{ }^{\circ}\text{C}$

- 1) Maksimalna pozitivna temperaturna promjena: $T_{max} = 40\text{ }^{\circ}\text{C} - 10\text{ }^{\circ}\text{C} = 30\text{ }^{\circ}\text{C}$
- 2) Maksimalna negativna temperaturna promjena: $T_{min} = -20\text{ }^{\circ}\text{C} - 10\text{ }^{\circ}\text{C} = -30\text{ }^{\circ}\text{C}$

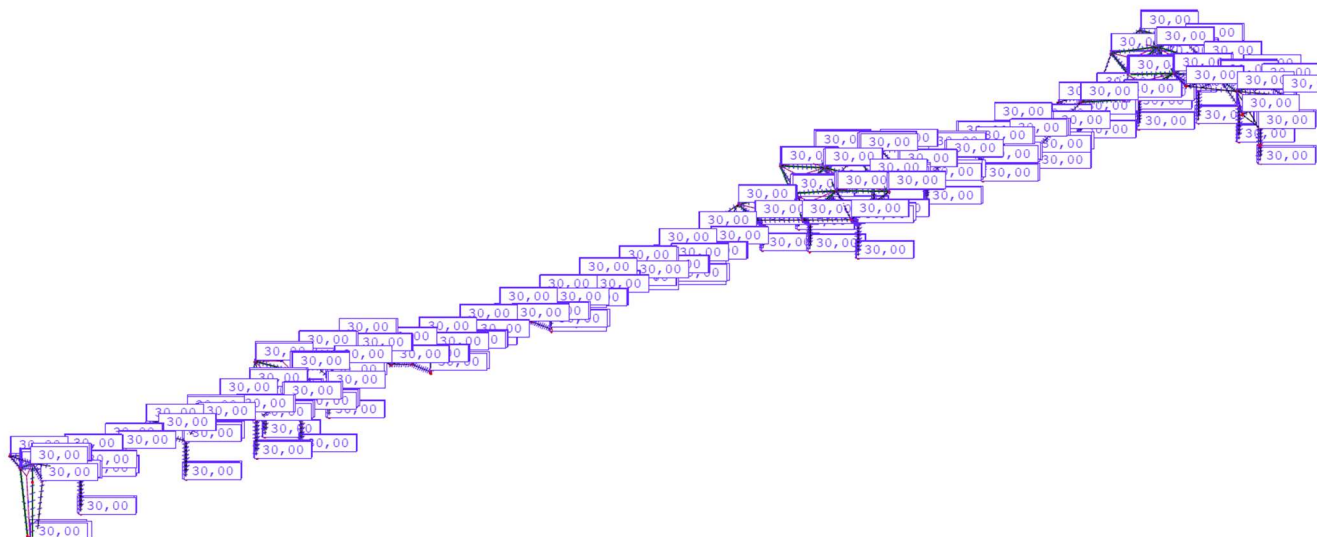

Slika 27: Prikaz temperaturnog opterećenja „T+“ zagrijavanja konstrukcije

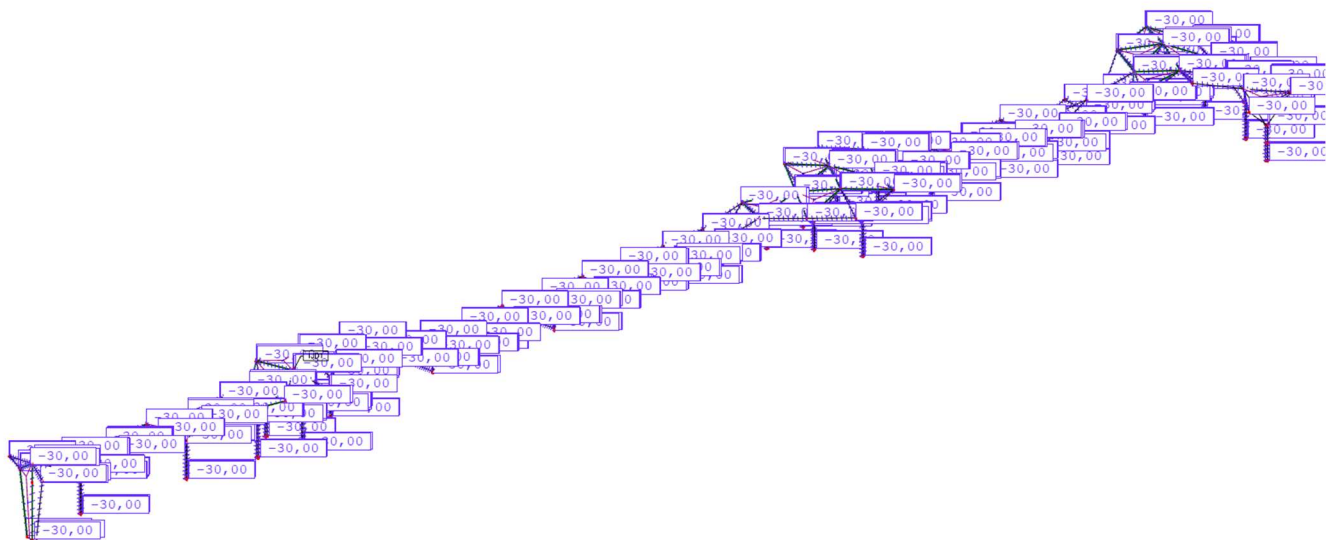

Slika 28: Prikaz temperaturnog opterećenja „T-“, hlađenja konstrukcije

3.5. Modalna analiza

Potresne sile proračunate su metodom višemodalne (spektralne) analize prema EC-8 pomoću računalnog programa Scia Engineer 22.0.

Predmetna lokacija (Zagreb) se nalazi u potresnoj zoni za koju je definirano poredbeno vršno ubrzanje temeljnog tla $a_{gR}=0,252$ g za povratni period $T=475$ god, odnosno $a_{gR}=0,13$ g za povratni period $T=95$ god.

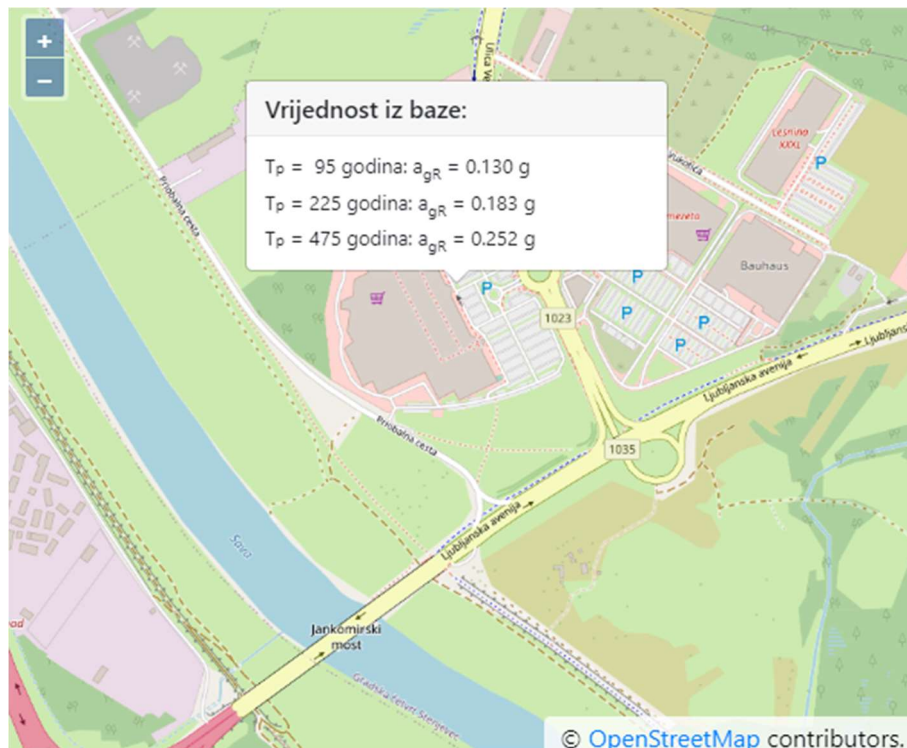

Slika 29: Prikaz vršnog ubrzanja temeljnog tla za povratni period $T=475$ god i $T=95$ god

Građevina je temeljena na temeljnom tlu klase C. Pretpostavlja se srednja klasa (DCM) duktilnog ponašanja građevine.

Faktor ponašanja

Razina duktilnosti: DCM (srednja razina)

PRORAČUN FAKTORA PONAŠANJA

Kriterij tlocrtno pravilnosti:	Nije zadovoljen
Kriterij pravilnosti po visini:	Nije zadovoljen
Klasa duktilnosti:	DCM

$$q = q_0 \cdot k_w \geq 1.5$$

q – gornja granična vrijednost faktora ponašanja

q_0 – osnovna vrijednost faktora ponašanja

k_w – faktor kojim se uzima u obzir prevladavajući oblik sloma

Tip konstrukcije:	Sustav obrnutog njuhala
-------------------	-------------------------

$q_0 =$	1,2	(vrijednost smanjena za 20%)
$k_w =$	1	
$q =$	1,2	

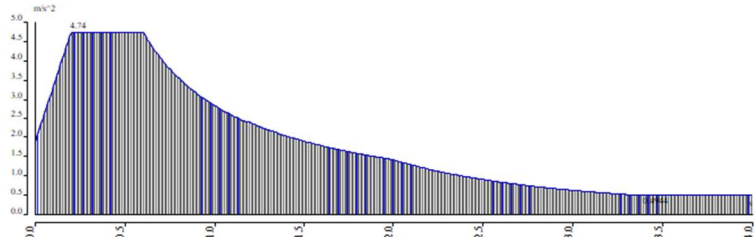
Naziv spektra	S
Tip prikaza	Period
Informacije	Tip koda - Eurocode Tip tla - A Smjer- Horizontalni Tip spektra - Tip 1 Koeficijent ubrzanja – 0,252 a_g – proračunsko ubrzanje – 2,472 beta – 0,2 q – faktor ponašanja – 1,2
Elastični spektar:	

Slika 30: Prikaz elastičnog spektra za seizmički proračun

Proračun

Općenito

Number of 2D elements	0
Number of 1D elements	3678
Number of mesh nodes	3509
Number of equations	21054
Combination of mass groups	MC1 CM1
Modification group	None
Number of frequencies	400
Method	Lanczos
Bending theory	Mindlin
Type of analysis model	Standard
Start of calculation	9.6.2023. 13:18
End of calculation	9.6.2023. 13:20

Suma masa

	Mass type	X [kg]	Y [kg]	Z [kg]
1	Moving mass	169034,68	169034,68	169034,68
1	Total mass	170995,17	170995,17	170995,17

Relativna modalna masa

Mode	Omega [rad/s]	Period [s]	Freq. [Hz]	W_{xi}/W_{xtot}	W_{yi}/W_{ytot}	W_{zi}/W_{ztot}	W_{xi_R}/W_{xtot_R}	W_{yi_R}/W_{ytot_R}	W_{zi_R}/W_{ztot_R}
1	6.68364	0,94	1,06	0,0005	0,0966	0,0000	0,0227	0,0001	0,2667
2	9.35285	0,67	1,49	0,0535	0,0005	0,0008	0,0026	0,0002	0,0278
3	9.43292	0,67	1,50	0,0052	0,1387	0,0003	0,0156	0,0004	0,1641
4	11.6098	0,54	1,85	0,0001	0,0025	0,0006	0,0007	0,0008	0,0086
5	12.366	0,51	1,97	0,0061	0,3043	0,0007	0,0115	0,0003	0,3400
6	13.598	0,46	2,16	0,0022	0,2091	0,0014	0,0042	0,0001	0,0027
7	15.1232	0,42	2,41	0,1288	0,0327	0,0016	0,0025	0,0055	0,0116
8	15.9281	0,39	2,54	0,0265	0,0401	0,0001	0,0055	0,0026	0,0079
9	17.206	0,37	2,74	0,0160	0,0020	0,0135	0,0006	0,0000	0,0037
10	18.0089	0,35	2,87	0,0052	0,0038	0,0023	0,0016	0,0119	0,0022
11	18.2387	0,34	2,90	0,0308	0,0000	0,0019	0,0066	0,0022	0,0004
12	19.4036	0,32	3,09	0,0301	0,0000	0,0002	0,0000	0,0030	0,0047
13	20.3888	0,31	3,24	0,0836	0,0026	0,0010	0,0002	0,0008	0,0019
14	21.3371	0,29	3,40	0,0055	0,0063	0,0030	0,0009	0,0065	0,0030
15	22.1231	0,28	3,52	0,0102	0,0006	0,0003	0,0011	0,0002	0,0004
16	23.0875	0,27	3,67	0,0351	0,0024	0,0001	0,0043	0,0001	0,0038
17	23.6275	0,27	3,76	0,0155	0,0041	0,0010	0,0091	0,0011	0,0019
18	24.6642	0,25	3,93	0,0105	0,0039	0,0114	0,0109	0,0013	0,0000
19	25.496	0,25	4,06	0,0067	0,0002	0,0003	0,0001	0,0000	0,0005
20	25.9243	0,24	4,13	0,0097	0,0005	0,0028	0,0019	0,0001	0,0000
21	26.9464	0,23	4,29	0,0000	0,0034	0,0088	0,0121	0,0033	0,0008
22	27.3545	0,23	4,35	0,0005	0,0001	0,0003	0,0001	0,0001	0,0040
23	27.522	0,23	4,38	0,0001	0,0026	0,0000	0,0027	0,0013	0,0011
24	28.038	0,22	4,46	0,0358	0,0002	0,0049	0,0009	0,0016	0,0000
25	28.9074	0,22	4,60	0,0272	0,0002	0,0001	0,0007	0,0016	0,0003
26	29.3866	0,21	4,68	0,0038	0,0006	0,0016	0,0028	0,0019	0,0002
27	30.1515	0,21	4,80	0,0014	0,0005	0,0003	0,0013	0,0017	0,0005
28	30.5025	0,21	4,85	0,0332	0,0008	0,0003	0,0007	0,0002	0,0011
29	30.9422	0,20	4,92	0,0099	0,0000	0,0002	0,0004	0,0000	0,0002
30	31.4485	0,20	5,01	0,0048	0,0000	0,0001	0,0001	0,0001	0,0000
31	32.0437	0,20	5,10	0,0002	0,0000	0,0013	0,0000	0,0035	0,0001
32	33.2866	0,19	5,30	0,0025	0,0019	0,0031	0,0067	0,0001	0,0001
33	33.4582	0,19	5,33	0,0011	0,0011	0,0007	0,0020	0,0006	0,0054
34	33.8261	0,19	5,38	0,0036	0,0005	0,0006	0,0001	0,0001	0,0000
35	35.9374	0,17	5,72	0,0346	0,0012	0,0002	0,0000	0,0001	0,0011
36	36.0537	0,17	5,74	0,0001	0,0012	0,0013	0,0004	0,0040	0,0022
37	36.6564	0,17	5,83	0,0001	0,0001	0,0025	0,0013	0,0034	0,0001
38	38.582	0,16	6,14	0,0008	0,0082	0,0042	0,0006	0,0016	0,0050
39	39.3483	0,16	6,26	0,0028	0,0003	0,0012	0,0002	0,0018	0,0006

Mode	Omega [rad/s]	Period [s]	Freq. [Hz]	W_{xi}/W_{xtot}	W_{yi}/W_{ytot}	W_{zi}/W_{ztot}	W_{xi_R}/W_{xtot_R}	W_{yi_R}/W_{ytot_R}	W_{zi_R}/W_{ztot_R}
40	39.8358	0,16	6,34	0,0043	0,0059	0,0167	0,0190	0,0042	0,0011
41	40.7808	0,15	6,49	0,0001	0,0001	0,0066	0,0722	0,0104	0,0001
42	41.842	0,15	6,66	0,0146	0,0006	0,0003	0,0011	0,0007	0,0002
43	42.4607	0,15	6,76	0,0018	0,0007	0,0000	0,0043	0,0000	0,0002
44	42.825	0,15	6,82	0,0008	0,0021	0,0001	0,0018	0,0006	0,0001
45	43.1437	0,15	6,87	0,0007	0,0004	0,0009	0,0044	0,0010	0,0008
46	43.7203	0,14	6,96	0,0011	0,0010	0,0003	0,0005	0,0018	0,0051
47	44.1167	0,14	7,02	0,0017	0,0024	0,0016	0,0015	0,0004	0,0002
48	44.7707	0,14	7,13	0,0081	0,0003	0,0002	0,0003	0,0012	0,0001
49	45.1962	0,14	7,19	0,0100	0,0007	0,0004	0,0022	0,0003	0,0003
50	45.8222	0,14	7,29	0,0308	0,0008	0,0016	0,0012	0,0006	0,0000
51	47.0874	0,13	7,49	0,0034	0,0042	0,0021	0,0052	0,0044	0,0029
52	47.4275	0,13	7,55	0,0065	0,0001	0,0019	0,0002	0,0007	0,0007
53	48.193	0,13	7,67	0,0493	0,0041	0,0011	0,0045	0,0000	0,0040
54	48.6192	0,13	7,74	0,0080	0,0003	0,0004	0,0007	0,0016	0,0002
55	49.2749	0,13	7,84	0,0000	0,0000	0,0000	0,0000	0,0001	0,0001
56	50.8022	0,12	8,09	0,0000	0,0004	0,0001	0,0001	0,0004	0,0014
57	51.5306	0,12	8,20	0,0013	0,0015	0,0013	0,0057	0,0024	0,0011
58	51.8649	0,12	8,25	0,0006	0,0001	0,0001	0,0007	0,0000	0,0000
59	52.9001	0,12	8,42	0,0001	0,0000	0,0054	0,0028	0,0075	0,0000
60	53.2626	0,12	8,48	0,0011	0,0001	0,0006	0,0000	0,0000	0,0000
61	53.7152	0,12	8,55	0,0000	0,0000	0,0036	0,0000	0,0130	0,0000
62	54.5111	0,12	8,68	0,0001	0,0002	0,0000	0,0016	0,0001	0,0000
63	55.2418	0,11	8,79	0,0011	0,0002	0,0034	0,0096	0,0001	0,0000
64	55.6794	0,11	8,86	0,0001	0,0001	0,0001	0,0003	0,0003	0,0002
65	56.3912	0,11	8,97	0,0007	0,0001	0,0011	0,0057	0,0001	0,0002
66	56.9185	0,11	9,06	0,0001	0,0002	0,0000	0,0001	0,0012	0,0000
67	57.3788	0,11	9,13	0,0015	0,0015	0,0011	0,0021	0,0016	0,0007
68	57.5226	0,11	9,16	0,0000	0,0003	0,0028	0,0000	0,0023	0,0000
69	58.2203	0,11	9,27	0,0007	0,0000	0,0025	0,0006	0,0004	0,0001
70	58.4081	0,11	9,30	0,0000	0,0000	0,0003	0,0158	0,0007	0,0000
71	59.1375	0,11	9,41	0,0001	0,0000	0,0001	0,0009	0,0001	0,0000
72	59.5793	0,11	9,48	0,0001	0,0000	0,0000	0,0019	0,0001	0,0000
73	59.751	0,11	9,51	0,0018	0,0000	0,0019	0,0016	0,0014	0,0000
74	60.4741	0,10	9,62	0,0005	0,0000	0,0003	0,0019	0,0000	0,0000
75	60.7404	0,10	9,67	0,0001	0,0000	0,0003	0,0015	0,0000	0,0000
76	61.2085	0,10	9,74	0,0013	0,0001	0,0006	0,0001	0,0011	0,0002
77	61.4364	0,10	9,78	0,0001	0,0000	0,0000	0,0000	0,0000	0,0000
78	61.6515	0,10	9,81	0,0002	0,0000	0,0000	0,0001	0,0000	0,0001
79	62.3791	0,10	9,93	0,0007	0,0001	0,0003	0,0007	0,0000	0,0000
80	62.9365	0,10	10,02	0,0008	0,0000	0,0001	0,0013	0,0010	0,0001
81	63.0402	0,10	10,03	0,0001	0,0000	0,0008	0,0011	0,0010	0,0000
82	63.3234	0,10	10,08	0,0033	0,0000	0,0123	0,0085	0,0057	0,0000
83	63.6438	0,10	10,13	0,0000	0,0000	0,0014	0,0036	0,0015	0,0000
84	63.7809	0,10	10,15	0,0000	0,0002	0,0080	0,0023	0,0013	0,0000
85	64.2374	0,10	10,22	0,0000	0,0000	0,0030	0,0013	0,0059	0,0000
86	64.4398	0,10	10,26	0,0000	0,0001	0,0000	0,0043	0,0000	0,0000
87	64.5311	0,10	10,27	0,0000	0,0000	0,0026	0,0050	0,0007	0,0000
88	64.6445	0,10	10,29	0,0002	0,0000	0,0000	0,0002	0,0002	0,0000
89	64.9217	0,10	10,33	0,0001	0,0001	0,0001	0,0038	0,0002	0,0000
90	65.4621	0,10	10,42	0,0006	0,0000	0,0001	0,0000	0,0003	0,0000
91	65.5032	0,10	10,43	0,0005	0,0000	0,0000	0,0007	0,0004	0,0000
92	65.7274	0,10	10,46	0,0010	0,0000	0,0021	0,0005	0,0004	0,0000
93	66.0706	0,10	10,52	0,0018	0,0000	0,0004	0,0009	0,0005	0,0000
94	66.1877	0,09	10,53	0,0000	0,0000	0,0004	0,0001	0,0010	0,0000
95	66.2741	0,09	10,55	0,0001	0,0000	0,0004	0,0013	0,0001	0,0000
96	66.4211	0,09	10,57	0,0004	0,0001	0,0001	0,0001	0,0019	0,0000
97	66.7322	0,09	10,62	0,0000	0,0000	0,0002	0,0009	0,0000	0,0001
98	66.7946	0,09	10,63	0,0003	0,0000	0,0004	0,0003	0,0006	0,0000
99	67.124	0,09	10,68	0,0002	0,0000	0,0007	0,0002	0,0002	0,0000
100	67.397	0,09	10,73	0,0000	0,0000	0,0062	0,0011	0,0000	0,0000
101	67.494	0,09	10,74	0,0000	0,0003	0,0004	0,0004	0,0012	0,0009
102	68.2656	0,09	10,86	0,0002	0,0001	0,0000	0,0001	0,0006	0,0000
103	68.5522	0,09	10,91	0,0001	0,0000	0,0001	0,0000	0,0002	0,0000
104	69.1968	0,09	11,01	0,0005	0,0000	0,0014	0,0003	0,0011	0,0000
105	69.3148	0,09	11,03	0,0001	0,0001	0,0001	0,0015	0,0002	0,0003
106	69.4888	0,09	11,06	0,0000	0,0004	0,0001	0,0004	0,0000	0,0011
107	69.7658	0,09	11,10	0,0001	0,0004	0,0008	0,0003	0,0002	0,0023

Mode	Omega [rad/s]	Period [s]	Freq. [Hz]	W_{xi}/W_{xtot}	W_{yi}/W_{ytot}	W_{zi}/W_{ztot}	W_{xi_R}/W_{xtot_R}	W_{yi_R}/W_{ytot_R}	W_{zi_R}/W_{ztot_R}
108	69.9213	0,09	11,13	0,0002	0,0003	0,0025	0,0008	0,0001	0,0005
109	70.288	0,09	11,19	0,0000	0,0000	0,0031	0,0004	0,0039	0,0000
110	70.4273	0,09	11,21	0,0000	0,0000	0,0014	0,0001	0,0003	0,0000
111	70.4871	0,09	11,22	0,0000	0,0000	0,0000	0,0010	0,0006	0,0000
112	70.6705	0,09	11,25	0,0008	0,0001	0,0031	0,0014	0,0010	0,0000
113	70.8229	0,09	11,27	0,0001	0,0001	0,0094	0,0060	0,0059	0,0001
114	70.9161	0,09	11,29	0,0002	0,0001	0,0001	0,0001	0,0027	0,0001
115	71.2453	0,09	11,34	0,0003	0,0000	0,0005	0,0001	0,0000	0,0000
116	71.9153	0,09	11,45	0,0008	0,0001	0,0005	0,0004	0,0000	0,0000
117	72.337	0,09	11,51	0,0003	0,0000	0,0027	0,0001	0,0008	0,0000
118	72.4841	0,09	11,54	0,0000	0,0001	0,0056	0,0020	0,0065	0,0001
119	72.7591	0,09	11,58	0,0002	0,0000	0,0004	0,0002	0,0006	0,0000
120	73.262	0,09	11,66	0,0002	0,0000	0,0000	0,0005	0,0001	0,0000
121	73.3949	0,09	11,68	0,0002	0,0000	0,0000	0,0023	0,0000	0,0000
122	73.4538	0,09	11,69	0,0006	0,0000	0,0006	0,0008	0,0001	0,0000
123	73.502	0,09	11,70	0,0001	0,0000	0,0001	0,0011	0,0004	0,0000
124	73.5996	0,09	11,71	0,0000	0,0000	0,0004	0,0001	0,0004	0,0000
125	74.0748	0,08	11,79	0,0000	0,0000	0,0010	0,0000	0,0000	0,0000
126	74.318	0,08	11,83	0,0000	0,0000	0,0016	0,0004	0,0006	0,0000
127	74.4657	0,08	11,85	0,0018	0,0000	0,0001	0,0001	0,0020	0,0001
128	74.6954	0,08	11,89	0,0000	0,0001	0,0005	0,0000	0,0008	0,0002
129	74.7524	0,08	11,90	0,0005	0,0001	0,0035	0,0000	0,0098	0,0003
130	75.043	0,08	11,94	0,0000	0,0000	0,0006	0,0001	0,0011	0,0000
131	75.1312	0,08	11,96	0,0002	0,0000	0,0008	0,0001	0,0001	0,0000
132	75.4435	0,08	12,01	0,0001	0,0000	0,0005	0,0002	0,0002	0,0000
133	75.559	0,08	12,03	0,0002	0,0001	0,0010	0,0101	0,0003	0,0001
134	75.677	0,08	12,04	0,0000	0,0000	0,0034	0,0000	0,0035	0,0001
135	75.7641	0,08	12,06	0,0002	0,0000	0,0000	0,0013	0,0004	0,0000
136	76.1435	0,08	12,12	0,0003	0,0003	0,0002	0,0006	0,0004	0,0003
137	76.5336	0,08	12,18	0,0003	0,0000	0,0001	0,0001	0,0000	0,0001
138	76.7933	0,08	12,22	0,0000	0,0000	0,0000	0,0002	0,0001	0,0000
139	76.8225	0,08	12,23	0,0004	0,0002	0,0001	0,0001	0,0000	0,0000
140	77.2993	0,08	12,30	0,0000	0,0001	0,0001	0,0004	0,0005	0,0001
141	77.641	0,08	12,36	0,0002	0,0000	0,0010	0,0042	0,0024	0,0000
142	77.7845	0,08	12,38	0,0000	0,0000	0,0133	0,0096	0,0163	0,0000
143	77.8064	0,08	12,38	0,0005	0,0001	0,0001	0,0002	0,0003	0,0000
144	78.2729	0,08	12,46	0,0000	0,0000	0,0026	0,0001	0,0051	0,0000
145	78.3964	0,08	12,48	0,0006	0,0000	0,0013	0,0021	0,0019	0,0000
146	78.7706	0,08	12,54	0,0001	0,0000	0,0003	0,0001	0,0003	0,0000
147	78.8277	0,08	12,55	0,0008	0,0005	0,0000	0,0010	0,0010	0,0005
148	78.8991	0,08	12,56	0,0000	0,0000	0,0238	0,0000	0,0191	0,0001
149	78.9677	0,08	12,57	0,0008	0,0000	0,0024	0,0017	0,0009	0,0000
150	79.4783	0,08	12,65	0,0003	0,0001	0,0003	0,0005	0,0009	0,0000
151	79.483	0,08	12,65	0,0002	0,0001	0,0001	0,0005	0,0003	0,0001
152	79.5464	0,08	12,66	0,0003	0,0002	0,0001	0,0000	0,0000	0,0001
153	79.8151	0,08	12,70	0,0000	0,0005	0,0021	0,0009	0,0003	0,0002
154	80.081	0,08	12,75	0,0000	0,0000	0,0004	0,0022	0,0013	0,0001
155	80.2892	0,08	12,78	0,0003	0,0007	0,0007	0,0005	0,0008	0,0007
156	80.5072	0,08	12,81	0,0000	0,0000	0,0014	0,0002	0,0000	0,0000
157	80.8037	0,08	12,86	0,0002	0,0002	0,0005	0,0025	0,0002	0,0005
158	81.1311	0,08	12,91	0,0002	0,0005	0,0000	0,0010	0,0000	0,0005
159	81.1696	0,08	12,92	0,0000	0,0001	0,0033	0,0016	0,0016	0,0000
160	81.3726	0,08	12,95	0,0000	0,0000	0,0006	0,0001	0,0001	0,0000
161	81.9234	0,08	13,04	0,0000	0,0000	0,0006	0,0008	0,0003	0,0001
162	82.2376	0,08	13,09	0,0000	0,0002	0,0002	0,0003	0,0011	0,0002
163	82.2725	0,08	13,09	0,0000	0,0000	0,0015	0,0145	0,0017	0,0000
164	82.4355	0,08	13,12	0,0000	0,0000	0,0001	0,0008	0,0004	0,0000
165	82.599	0,08	13,15	0,0004	0,0003	0,0010	0,0002	0,0034	0,0008
166	82.8014	0,08	13,18	0,0001	0,0000	0,0000	0,0002	0,0000	0,0000
167	82.9964	0,08	13,21	0,0000	0,0000	0,0017	0,0056	0,0024	0,0000
168	83.2966	0,08	13,26	0,0006	0,0001	0,0017	0,0006	0,0013	0,0001
169	83.3605	0,08	13,27	0,0006	0,0000	0,0000	0,0005	0,0002	0,0000
170	83.368	0,08	13,27	0,0001	0,0002	0,0002	0,0000	0,0000	0,0000
171	83.8176	0,07	13,34	0,0000	0,0000	0,0020	0,0143	0,0062	0,0000
172	83.8648	0,07	13,35	0,0000	0,0001	0,0066	0,0006	0,0058	0,0001
173	83.9559	0,07	13,36	0,0000	0,0000	0,0001	0,0001	0,0003	0,0001
174	84.2295	0,07	13,41	0,0000	0,0000	0,0007	0,0001	0,0015	0,0000
175	84.3236	0,07	13,42	0,0004	0,0000	0,0008	0,0002	0,0005	0,0002

Mode	Omega [rad/s]	Period [s]	Freq. [Hz]	W_{xi}/W_{xtot}	W_{yi}/W_{ytot}	W_{zi}/W_{ztot}	W_{xi_R}/W_{xtot_R}	W_{yi_R}/W_{ytot_R}	W_{zi_R}/W_{ztot_R}
176	84.4338	0,07	13,44	0,0000	0,0000	0,0003	0,0001	0,0000	0,0000
177	84.5846	0,07	13,46	0,0003	0,0000	0,0010	0,0001	0,0019	0,0000
178	84.7824	0,07	13,49	0,0006	0,0000	0,0031	0,0001	0,0000	0,0000
179	84.8521	0,07	13,50	0,0005	0,0000	0,0016	0,0029	0,0025	0,0000
180	84.9115	0,07	13,51	0,0001	0,0002	0,0002	0,0001	0,0007	0,0005
181	85.0067	0,07	13,53	0,0000	0,0000	0,0000	0,0000	0,0000	0,0000
182	85.2014	0,07	13,56	0,0003	0,0001	0,0000	0,0005	0,0010	0,0001
183	85.2844	0,07	13,57	0,0001	0,0000	0,0016	0,0089	0,0019	0,0000
184	85.4778	0,07	13,60	0,0001	0,0000	0,0002	0,0007	0,0003	0,0000
185	85.9133	0,07	13,67	0,0000	0,0000	0,0002	0,0017	0,0003	0,0000
186	86.066	0,07	13,70	0,0002	0,0000	0,0002	0,0024	0,0001	0,0000
187	86.22	0,07	13,72	0,0000	0,0005	0,0004	0,0005	0,0009	0,0007
188	86.4557	0,07	13,76	0,0001	0,0000	0,0001	0,0005	0,0006	0,0001
189	86.6527	0,07	13,79	0,0003	0,0000	0,0010	0,0000	0,0012	0,0001
190	86.7596	0,07	13,81	0,0000	0,0001	0,0000	0,0002	0,0019	0,0000
191	86.8677	0,07	13,83	0,0001	0,0000	0,0009	0,0005	0,0004	0,0000
192	86.9214	0,07	13,83	0,0002	0,0000	0,0002	0,0003	0,0003	0,0000
193	87.1596	0,07	13,87	0,0016	0,0000	0,0052	0,0007	0,0053	0,0000
194	87.2587	0,07	13,89	0,0001	0,0004	0,0011	0,0002	0,0026	0,0010
195	87.604	0,07	13,94	0,0000	0,0001	0,0014	0,0002	0,0011	0,0000
196	87.6322	0,07	13,95	0,0000	0,0001	0,0004	0,0008	0,0000	0,0000
197	87.6411	0,07	13,95	0,0000	0,0001	0,0004	0,0014	0,0019	0,0003
198	87.744	0,07	13,96	0,0000	0,0000	0,0021	0,0002	0,0028	0,0000
199	87.8576	0,07	13,98	0,0000	0,0000	0,0004	0,0000	0,0006	0,0000
200	87.9482	0,07	14,00	0,0000	0,0001	0,0065	0,0002	0,0015	0,0000
201	88.1158	0,07	14,02	0,0000	0,0000	0,0000	0,0003	0,0001	0,0000
202	88.5112	0,07	14,09	0,0000	0,0000	0,0007	0,0000	0,0001	0,0000
203	89.1341	0,07	14,19	0,0001	0,0000	0,0000	0,0027	0,0011	0,0000
204	89.3048	0,07	14,21	0,0014	0,0001	0,0009	0,0015	0,0009	0,0001
205	89.5003	0,07	14,24	0,0011	0,0002	0,0033	0,0003	0,0026	0,0000
206	89.7893	0,07	14,29	0,0001	0,0000	0,0005	0,0000	0,0002	0,0001
207	90.081	0,07	14,34	0,0011	0,0000	0,0004	0,0000	0,0007	0,0000
208	90.143	0,07	14,35	0,0002	0,0000	0,0004	0,0001	0,0009	0,0000
209	90.4025	0,07	14,39	0,0000	0,0001	0,0020	0,0018	0,0006	0,0001
210	90.6252	0,07	14,42	0,0000	0,0000	0,0054	0,0001	0,0068	0,0000
211	90.8089	0,07	14,45	0,0002	0,0000	0,0089	0,0002	0,0002	0,0000
212	90.8584	0,07	14,46	0,0000	0,0000	0,0025	0,0001	0,0070	0,0000
213	91.4714	0,07	14,56	0,0001	0,0000	0,0028	0,0001	0,0011	0,0000
214	91.6866	0,07	14,59	0,0002	0,0000	0,0103	0,0000	0,0146	0,0000
215	91.7619	0,07	14,60	0,0000	0,0000	0,0021	0,0001	0,0000	0,0000
216	92.1966	0,07	14,67	0,0000	0,0000	0,0046	0,0020	0,0015	0,0000
217	92.2887	0,07	14,69	0,0000	0,0000	0,0001	0,0000	0,0003	0,0000
218	92.5844	0,07	14,74	0,0000	0,0000	0,0001	0,0017	0,0000	0,0000
219	92.7982	0,07	14,77	0,0019	0,0008	0,0080	0,0016	0,0067	0,0009
220	93.1348	0,07	14,82	0,0000	0,0001	0,0049	0,0001	0,0025	0,0003
221	93.1603	0,07	14,83	0,0003	0,0001	0,0025	0,0000	0,0010	0,0003
222	93.3339	0,07	14,85	0,0000	0,0015	0,0003	0,0003	0,0000	0,0018
223	93.6329	0,07	14,90	0,0000	0,0000	0,0014	0,0007	0,0011	0,0000
224	94.2307	0,07	15,00	0,0011	0,0000	0,0002	0,0006	0,0001	0,0000
225	94.2785	0,07	15,00	0,0002	0,0000	0,0055	0,0005	0,0004	0,0000
226	94.5142	0,07	15,04	0,0000	0,0000	0,0002	0,0000	0,0001	0,0000
227	94.9002	0,07	15,10	0,0011	0,0000	0,0027	0,0001	0,0025	0,0002
228	95.0564	0,07	15,13	0,0000	0,0001	0,0000	0,0000	0,0011	0,0001
229	95.2329	0,07	15,16	0,0007	0,0001	0,0028	0,0008	0,0004	0,0001
230	95.3914	0,07	15,18	0,0001	0,0003	0,0002	0,0035	0,0006	0,0003
231	95.6457	0,07	15,22	0,0000	0,0000	0,0009	0,0031	0,0005	0,0001
232	95.7955	0,07	15,25	0,0006	0,0000	0,0001	0,0021	0,0001	0,0000
233	96.2596	0,07	15,32	0,0008	0,0002	0,0003	0,0007	0,0001	0,0003
234	96.2972	0,07	15,33	0,0001	0,0000	0,0024	0,0000	0,0039	0,0000
235	96.6987	0,06	15,39	0,0001	0,0000	0,0011	0,0001	0,0034	0,0000
236	96.8881	0,06	15,42	0,0000	0,0001	0,0003	0,0000	0,0002	0,0000
237	97.0736	0,06	15,45	0,0001	0,0000	0,0049	0,0000	0,0014	0,0000
238	97.2156	0,06	15,47	0,0000	0,0000	0,0008	0,0001	0,0002	0,0001
239	97.5164	0,06	15,52	0,0010	0,0001	0,0016	0,0009	0,0002	0,0000
240	97.6074	0,06	15,53	0,0005	0,0000	0,0000	0,0004	0,0000	0,0001
241	97.8028	0,06	15,57	0,0001	0,0000	0,0001	0,0002	0,0012	0,0000
242	97.9721	0,06	15,59	0,0001	0,0001	0,0012	0,0001	0,0006	0,0001
243	98.2715	0,06	15,64	0,0005	0,0000	0,0005	0,0002	0,0021	0,0000

Mode	Omega [rad/s]	Period [s]	Freq. [Hz]	W_{xi}/W_{xtot}	W_{yi}/W_{ytot}	W_{zi}/W_{ztot}	W_{xi_R}/W_{xtot_R}	W_{yi_R}/W_{ytot_R}	W_{zi_R}/W_{ztot_R}
244	98.3479	0,06	15,65	0,0000	0,0000	0,0026	0,0000	0,0005	0,0001
245	98.8444	0,06	15,73	0,0000	0,0000	0,0001	0,0002	0,0008	0,0000
246	98.9785	0,06	15,75	0,0009	0,0000	0,0018	0,0002	0,0013	0,0000
247	99.0924	0,06	15,77	0,0002	0,0004	0,0014	0,0000	0,0002	0,0003
248	99.1412	0,06	15,78	0,0000	0,0000	0,0000	0,0000	0,0000	0,0000
249	99.2348	0,06	15,79	0,0000	0,0001	0,0009	0,0002	0,0018	0,0002
250	99.3437	0,06	15,81	0,0000	0,0000	0,0000	0,0015	0,0003	0,0000
251	99.4477	0,06	15,83	0,0000	0,0000	0,0000	0,0000	0,0000	0,0000
252	99.7429	0,06	15,87	0,0000	0,0000	0,0015	0,0000	0,0006	0,0000
253	99.882	0,06	15,90	0,0001	0,0011	0,0014	0,0025	0,0035	0,0025
254	100.211	0,06	15,95	0,0001	0,0000	0,0016	0,0007	0,0000	0,0001
255	100.414	0,06	15,98	0,0000	0,0000	0,0004	0,0000	0,0002	0,0000
256	100.671	0,06	16,02	0,0005	0,0000	0,0002	0,0001	0,0000	0,0001
257	101.095	0,06	16,09	0,0000	0,0000	0,0002	0,0001	0,0002	0,0000
258	101.228	0,06	16,11	0,0011	0,0000	0,0009	0,0000	0,0000	0,0000
259	101.433	0,06	16,14	0,0000	0,0000	0,0001	0,0000	0,0000	0,0000
260	101.451	0,06	16,15	0,0000	0,0000	0,0006	0,0000	0,0007	0,0000
261	101.533	0,06	16,16	0,0003	0,0004	0,0005	0,0000	0,0001	0,0005
262	101.743	0,06	16,19	0,0000	0,0000	0,0002	0,0003	0,0004	0,0000
263	101.906	0,06	16,22	0,0006	0,0000	0,0006	0,0002	0,0005	0,0001
264	102.176	0,06	16,26	0,0000	0,0000	0,0002	0,0002	0,0008	0,0000
265	102.436	0,06	16,30	0,0000	0,0001	0,0016	0,0003	0,0020	0,0002
266	102.806	0,06	16,36	0,0014	0,0001	0,0011	0,0005	0,0038	0,0002
267	102.861	0,06	16,37	0,0000	0,0000	0,0003	0,0016	0,0009	0,0000
268	103.006	0,06	16,39	0,0001	0,0001	0,0003	0,0001	0,0000	0,0000
269	103.442	0,06	16,46	0,0016	0,0001	0,0016	0,0001	0,0028	0,0001
270	103.725	0,06	16,51	0,0000	0,0000	0,0006	0,0014	0,0000	0,0000
271	103.842	0,06	16,53	0,0000	0,0000	0,0009	0,0032	0,0002	0,0000
272	103.861	0,06	16,53	0,0000	0,0001	0,0032	0,0000	0,0001	0,0000
273	104.03	0,06	16,56	0,0006	0,0000	0,0000	0,0006	0,0005	0,0000
274	104.531	0,06	16,64	0,0001	0,0001	0,0002	0,0000	0,0003	0,0000
275	104.713	0,06	16,67	0,0000	0,0000	0,0000	0,0002	0,0000	0,0000
276	104.948	0,06	16,70	0,0000	0,0000	0,0006	0,0002	0,0000	0,0001
277	104.967	0,06	16,71	0,0000	0,0003	0,0006	0,0001	0,0003	0,0000
278	105.035	0,06	16,72	0,0000	0,0004	0,0001	0,0001	0,0007	0,0010
279	105.437	0,06	16,78	0,0000	0,0001	0,0000	0,0002	0,0000	0,0001
280	106.028	0,06	16,87	0,0009	0,0000	0,0009	0,0003	0,0003	0,0001
281	106.253	0,06	16,91	0,0000	0,0001	0,0000	0,0001	0,0000	0,0000
282	106.309	0,06	16,92	0,0000	0,0000	0,0012	0,0001	0,0013	0,0000
283	106.351	0,06	16,93	0,0001	0,0000	0,0016	0,0025	0,0028	0,0000
284	106.625	0,06	16,97	0,0000	0,0000	0,0014	0,0003	0,0017	0,0001
285	106.749	0,06	16,99	0,0005	0,0001	0,0002	0,0000	0,0000	0,0001
286	107.14	0,06	17,05	0,0001	0,0000	0,0000	0,0000	0,0002	0,0000
287	107.164	0,06	17,06	0,0008	0,0002	0,0002	0,0002	0,0011	0,0002
288	107.432	0,06	17,10	0,0002	0,0001	0,0001	0,0001	0,0001	0,0000
289	107.483	0,06	17,11	0,0000	0,0000	0,0012	0,0007	0,0018	0,0000
290	107.787	0,06	17,15	0,0002	0,0004	0,0025	0,0001	0,0044	0,0007
291	107.821	0,06	17,16	0,0003	0,0000	0,0001	0,0004	0,0001	0,0000
292	107.926	0,06	17,18	0,0000	0,0001	0,0004	0,0001	0,0007	0,0002
293	108.627	0,06	17,29	0,0022	0,0000	0,0000	0,0000	0,0003	0,0000
294	108.906	0,06	17,33	0,0000	0,0000	0,0001	0,0001	0,0000	0,0000
295	109.008	0,06	17,35	0,0000	0,0000	0,0003	0,0000	0,0006	0,0000
296	109.323	0,06	17,40	0,0010	0,0001	0,0000	0,0000	0,0001	0,0000
297	109.474	0,06	17,42	0,0001	0,0000	0,0000	0,0001	0,0000	0,0000
298	109.536	0,06	17,43	0,0002	0,0002	0,0000	0,0002	0,0000	0,0002
299	109.645	0,06	17,45	0,0000	0,0002	0,0006	0,0003	0,0012	0,0005
300	109.727	0,06	17,46	0,0004	0,0000	0,0000	0,0003	0,0001	0,0001
301	109.841	0,06	17,48	0,0005	0,0000	0,0000	0,0001	0,0000	0,0000
302	109.888	0,06	17,49	0,0004	0,0001	0,0000	0,0003	0,0001	0,0001
303	110.087	0,06	17,52	0,0000	0,0000	0,0001	0,0001	0,0001	0,0000
304	110.158	0,06	17,53	0,0000	0,0000	0,0001	0,0000	0,0001	0,0000
305	110.203	0,06	17,54	0,0000	0,0000	0,0000	0,0000	0,0000	0,0000
306	110.211	0,06	17,54	0,0000	0,0001	0,0001	0,0002	0,0001	0,0000
307	110.232	0,06	17,54	0,0002	0,0003	0,0000	0,0003	0,0000	0,0000
308	110.268	0,06	17,55	0,0000	0,0001	0,0000	0,0001	0,0000	0,0000
309	110.347	0,06	17,56	0,0000	0,0000	0,0000	0,0000	0,0000	0,0000
310	110.411	0,06	17,57	0,0000	0,0000	0,0000	0,0000	0,0001	0,0000
311	110.488	0,06	17,58	0,0000	0,0000	0,0000	0,0000	0,0000	0,0000

Mode	Omega [rad/s]	Period [s]	Freq. [Hz]	W_{xi}/W_{xtot}	W_{yi}/W_{ytot}	W_{zi}/W_{ztot}	W_{xi_R}/W_{xtot_R}	W_{yi_R}/W_{ytot_R}	W_{zi_R}/W_{ztot_R}
312	110.544	0,06	17,59	0,0000	0,0000	0,0000	0,0000	0,0000	0,0000
313	110.604	0,06	17,60	0,0002	0,0002	0,0001	0,0006	0,0000	0,0004
314	110.631	0,06	17,61	0,0000	0,0003	0,0000	0,0004	0,0000	0,0002
315	110.681	0,06	17,62	0,0000	0,0000	0,0000	0,0000	0,0000	0,0000
316	110.719	0,06	17,62	0,0000	0,0000	0,0000	0,0000	0,0000	0,0000
317	110.78	0,06	17,63	0,0000	0,0000	0,0000	0,0000	0,0000	0,0000
318	111.121	0,06	17,69	0,0000	0,0001	0,0000	0,0001	0,0001	0,0004
319	111.15	0,06	17,69	0,0000	0,0000	0,0005	0,0000	0,0000	0,0000
320	111.212	0,06	17,70	0,0000	0,0001	0,0000	0,0002	0,0000	0,0000
321	111.355	0,06	17,72	0,0002	0,0000	0,0007	0,0000	0,0005	0,0000
322	111.444	0,06	17,74	0,0000	0,0001	0,0001	0,0001	0,0000	0,0001
323	111.59	0,06	17,76	0,0000	0,0006	0,0001	0,0009	0,0002	0,0009
324	112.21	0,06	17,86	0,0002	0,0002	0,0014	0,0010	0,0004	0,0001
325	112.578	0,06	17,92	0,0005	0,0000	0,0011	0,0004	0,0011	0,0000
326	112.889	0,06	17,97	0,0003	0,0003	0,0009	0,0003	0,0003	0,0002
327	113.222	0,06	18,02	0,0000	0,0000	0,0002	0,0000	0,0003	0,0001
328	113.623	0,06	18,08	0,0002	0,0000	0,0000	0,0001	0,0003	0,0001
329	113.674	0,06	18,09	0,0007	0,0000	0,0005	0,0000	0,0002	0,0000
330	113.715	0,06	18,10	0,0000	0,0000	0,0013	0,0011	0,0003	0,0000
331	114.05	0,06	18,15	0,0000	0,0000	0,0005	0,0011	0,0009	0,0000
332	114.312	0,05	18,19	0,0002	0,0000	0,0000	0,0000	0,0003	0,0000
333	114.345	0,05	18,20	0,0002	0,0000	0,0016	0,0000	0,0023	0,0000
334	114.606	0,05	18,24	0,0001	0,0000	0,0003	0,0003	0,0003	0,0000
335	114.652	0,05	18,25	0,0010	0,0000	0,0002	0,0000	0,0001	0,0000
336	114.821	0,05	18,27	0,0029	0,0000	0,0004	0,0000	0,0001	0,0003
337	115.023	0,05	18,31	0,0000	0,0001	0,0001	0,0003	0,0001	0,0000
338	115.057	0,05	18,31	0,0001	0,0003	0,0001	0,0004	0,0002	0,0000
339	115.19	0,05	18,33	0,0008	0,0002	0,0011	0,0003	0,0000	0,0002
340	115.298	0,05	18,35	0,0002	0,0005	0,0000	0,0011	0,0001	0,0011
341	115.939	0,05	18,45	0,0003	0,0000	0,0002	0,0000	0,0000	0,0000
342	116.034	0,05	18,47	0,0001	0,0001	0,0000	0,0000	0,0003	0,0000
343	116.192	0,05	18,49	0,0001	0,0000	0,0031	0,0016	0,0006	0,0000
344	116.358	0,05	18,52	0,0019	0,0000	0,0001	0,0000	0,0003	0,0001
345	116.601	0,05	18,56	0,0000	0,0007	0,0006	0,0004	0,0006	0,0002
346	116.714	0,05	18,58	0,0002	0,0000	0,0001	0,0012	0,0009	0,0003
347	116.77	0,05	18,58	0,0011	0,0001	0,0030	0,0005	0,0001	0,0000
348	117.075	0,05	18,63	0,0005	0,0000	0,0000	0,0000	0,0001	0,0000
349	117.244	0,05	18,66	0,0005	0,0000	0,0042	0,0001	0,0035	0,0000
350	117.34	0,05	18,68	0,0003	0,0001	0,0001	0,0002	0,0009	0,0000
351	117.813	0,05	18,75	0,0000	0,0000	0,0017	0,0000	0,0003	0,0000
352	118.287	0,05	18,83	0,0001	0,0003	0,0003	0,0026	0,0004	0,0007
353	118.567	0,05	18,87	0,0012	0,0001	0,0007	0,0000	0,0000	0,0000
354	118.676	0,05	18,89	0,0007	0,0006	0,0001	0,0000	0,0001	0,0008
355	118.855	0,05	18,92	0,0013	0,0001	0,0004	0,0000	0,0003	0,0003
356	119.011	0,05	18,94	0,0000	0,0001	0,0001	0,0002	0,0000	0,0000
357	119.382	0,05	19,00	0,0007	0,0000	0,0013	0,0001	0,0006	0,0000
358	119.598	0,05	19,03	0,0004	0,0001	0,0004	0,0002	0,0011	0,0000
359	120.18	0,05	19,13	0,0002	0,0001	0,0000	0,0002	0,0000	0,0000
360	120.354	0,05	19,15	0,0004	0,0000	0,0000	0,0000	0,0000	0,0000
361	120.528	0,05	19,18	0,0008	0,0000	0,0000	0,0000	0,0001	0,0000
362	121.173	0,05	19,29	0,0061	0,0001	0,0000	0,0003	0,0004	0,0000
363	121.179	0,05	19,29	0,0018	0,0001	0,0001	0,0000	0,0000	0,0000
364	121.844	0,05	19,39	0,0012	0,0002	0,0000	0,0000	0,0000	0,0001
365	122.034	0,05	19,42	0,0002	0,0001	0,0002	0,0000	0,0003	0,0002
366	122.258	0,05	19,46	0,0004	0,0001	0,0002	0,0001	0,0003	0,0002
367	122.508	0,05	19,50	0,0001	0,0000	0,0000	0,0013	0,0002	0,0001
368	122.979	0,05	19,57	0,0007	0,0000	0,0000	0,0000	0,0022	0,0000
369	123.126	0,05	19,60	0,0010	0,0000	0,0024	0,0000	0,0003	0,0000
370	123.418	0,05	19,64	0,0001	0,0000	0,0004	0,0001	0,0002	0,0000
371	123.595	0,05	19,67	0,0000	0,0000	0,0000	0,0000	0,0003	0,0001
372	123.623	0,05	19,68	0,0000	0,0001	0,0002	0,0000	0,0001	0,0000
373	123.872	0,05	19,71	0,0002	0,0000	0,0001	0,0008	0,0004	0,0000
374	123.996	0,05	19,73	0,0002	0,0000	0,0001	0,0001	0,0002	0,0001
375	124.044	0,05	19,74	0,0000	0,0004	0,0000	0,0004	0,0001	0,0000
376	124.21	0,05	19,77	0,0002	0,0000	0,0000	0,0003	0,0000	0,0002
377	124.274	0,05	19,78	0,0005	0,0000	0,0000	0,0001	0,0001	0,0002
378	124.392	0,05	19,80	0,0003	0,0003	0,0005	0,0003	0,0011	0,0008
379	124.408	0,05	19,80	0,0001	0,0002	0,0002	0,0007	0,0002	0,0000

Mode	Omega [rad/s]	Period [s]	Freq. [Hz]	W_{xi}/W_{xtot}	W_{yi}/W_{ytot}	W_{zi}/W_{ztot}	W_{xi_R}/W_{xtot_R}	W_{yi_R}/W_{ytot_R}	W_{zi_R}/W_{ztot_R}
380	124.643	0,05	19,84	0,0002	0,0000	0,0003	0,0000	0,0002	0,0000
381	124.777	0,05	19,86	0,0001	0,0000	0,0000	0,0004	0,0001	0,0000
382	125.002	0,05	19,89	0,0000	0,0000	0,0000	0,0000	0,0000	0,0000
383	125.128	0,05	19,91	0,0000	0,0000	0,0000	0,0000	0,0000	0,0000
384	125.148	0,05	19,92	0,0002	0,0000	0,0001	0,0000	0,0001	0,0000
385	125.23	0,05	19,93	0,0002	0,0003	0,0002	0,0002	0,0002	0,0002
386	125.33	0,05	19,95	0,0002	0,0000	0,0005	0,0002	0,0002	0,0000
387	125.498	0,05	19,97	0,0000	0,0000	0,0000	0,0001	0,0000	0,0000
388	125.523	0,05	19,98	0,0001	0,0000	0,0004	0,0001	0,0002	0,0000
389	125.759	0,05	20,02	0,0004	0,0000	0,0001	0,0000	0,0000	0,0000
390	125.895	0,05	20,04	0,0001	0,0000	0,0000	0,0000	0,0000	0,0000
391	126.024	0,05	20,06	0,0004	0,0009	0,0004	0,0013	0,0001	0,0003
392	126.396	0,05	20,12	0,0020	0,0001	0,0001	0,0002	0,0020	0,0000
393	126.697	0,05	20,16	0,0000	0,0003	0,0005	0,0002	0,0002	0,0004
394	126.724	0,05	20,17	0,0000	0,0002	0,0000	0,0001	0,0001	0,0007
395	127.096	0,05	20,23	0,0001	0,0003	0,0000	0,0009	0,0000	0,0000
396	127.327	0,05	20,26	0,0004	0,0002	0,0000	0,0000	0,0000	0,0004
397	127.487	0,05	20,29	0,0001	0,0000	0,0002	0,0000	0,0008	0,0000
398	127.541	0,05	20,30	0,0004	0,0000	0,0000	0,0000	0,0001	0,0000
399	127.575	0,05	20,30	0,0003	0,0000	0,0003	0,0000	0,0004	0,0000
400	127.891	0,05	20,35	0,0002	0,0001	0,0000	0,0001	0,0000	0,0001
				0,8945	0,9334	0,4828	0,5447	0,4418	0,9349

Tablica 7: Prikaz perioda, frekvencija i aktiviranih masa za prvih 400 modova

U prvih 400 modova se aktiviralo preko 89% mase u smjeru x i preko 93% mase u smjeru y.

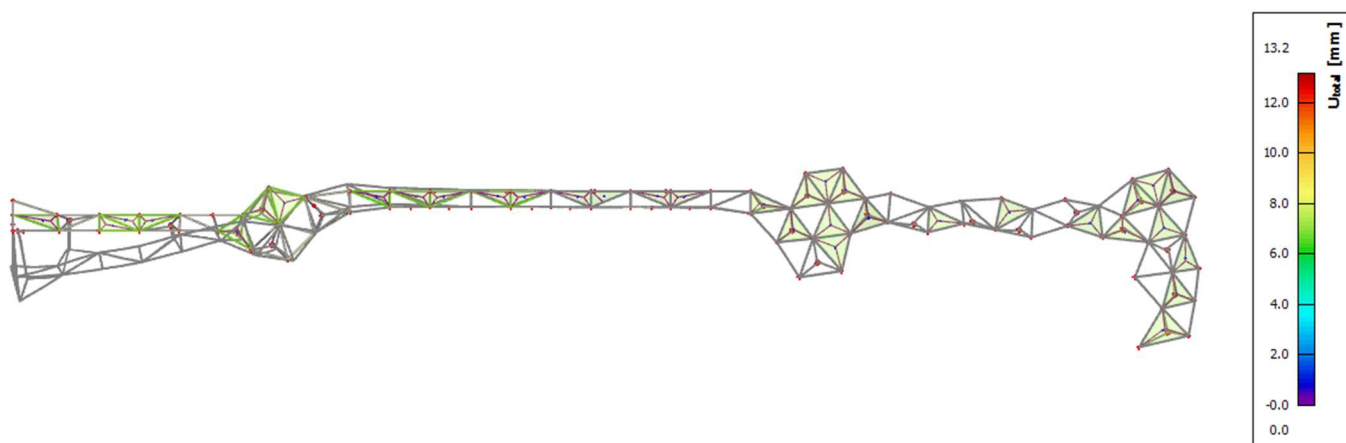

Slika 31: Prikaz 1. vlastitog vektora - torzija - smjeru (tlocrt)

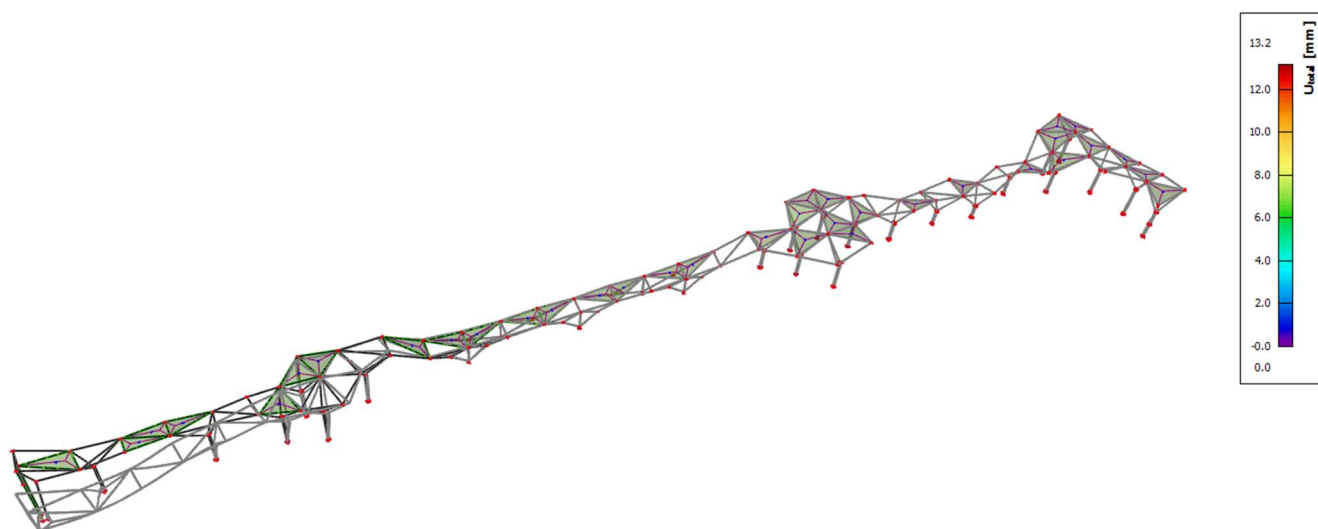

Slika 32: Prikaz 1. vlastitog vektora - torzija - smjeru (aksonometrija)

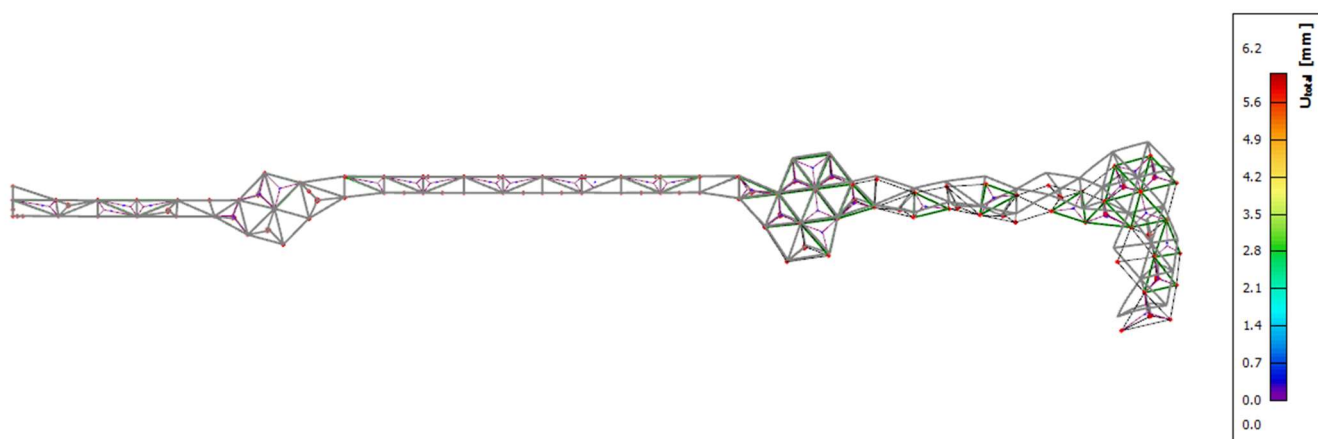

Slika 33: Prikaz 5. vlastitog vektora – translacija y (tlocrt)

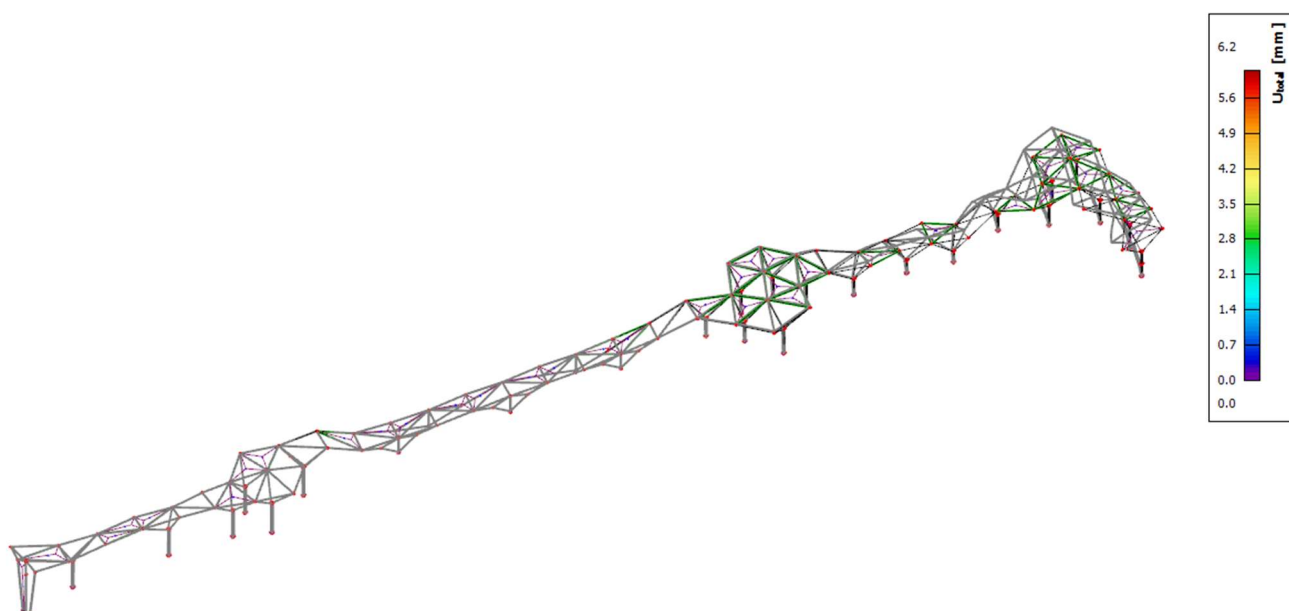

Slika 34: Prikaz 5. vlastitog vektora – translacija y (aksonometrija)

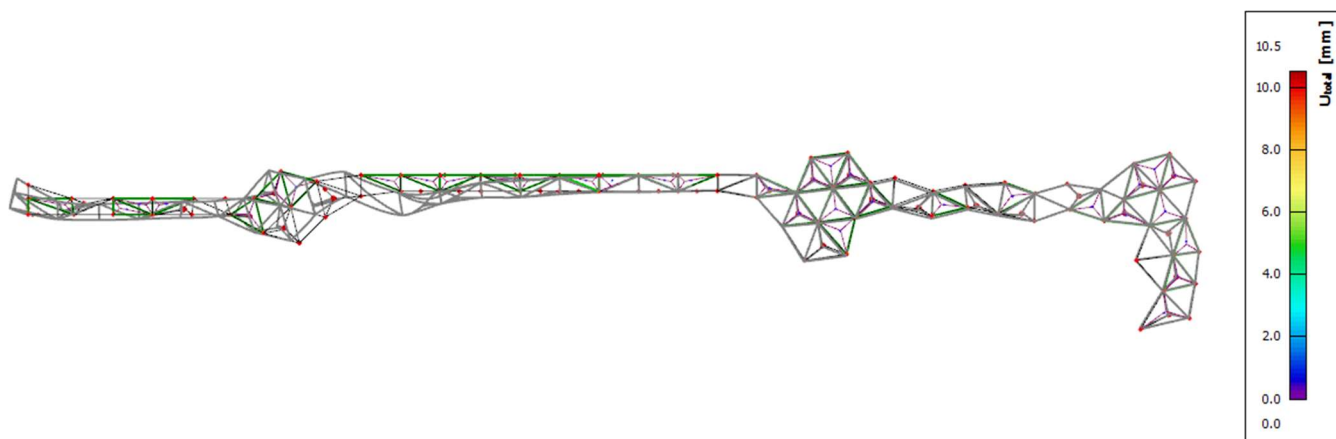

Slika 35: Prikaz 7. vlastitog vektora – translacija u x - smjeru (tlocrt)

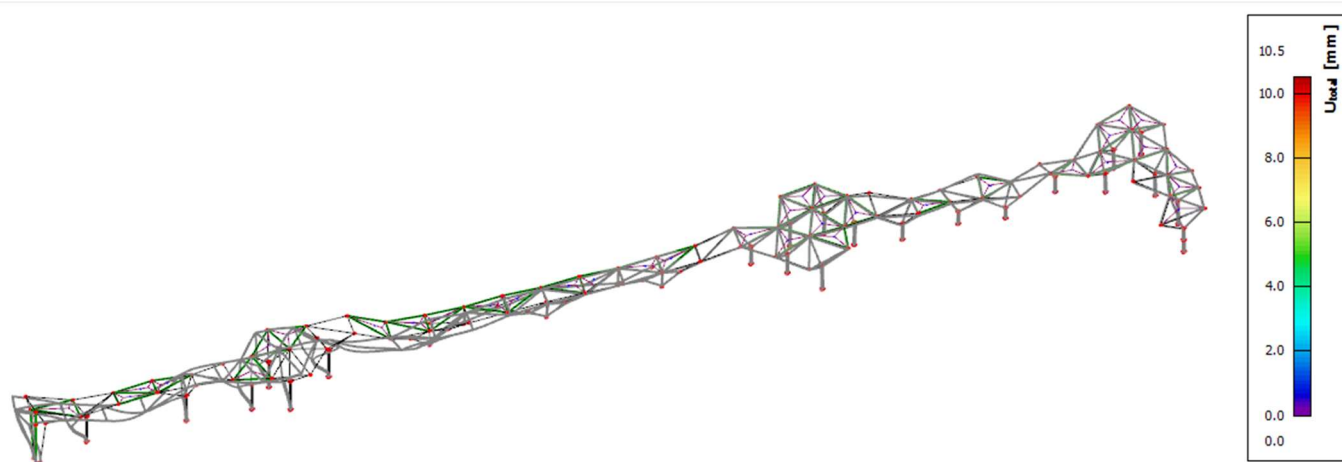

Slika 36: Prikaz 7. vlastitog vektora – translacija u x - smjeru (aksonometrija)

Za kontrolu pomaka konstrukcije uslijed seizmičkih sila (granično stanje uporabljivosti) koristi se ubrzanje tla a_g za povratni period $T=95$ god.

Zagreb – Shopping centar „King Cross“ se nalazi u potresnoj zoni za koju je definirano $a_g=0,13$ g za povratni period $T=95$ god.

Za proračun seizmičkog utjecaja za GSU uzima se faktor ponašanja konstrukcije $q=1.0$.

U sljedećoj tablici su prikazani parametri uzeti za seizmičku analizu objekta:

Tablica 8: Parametri za seizmički proračun za GSU

coeff accel. a_g	0,130
a_g - design acceleration [m/s ²]	1,275
q - behaviour factor	1,000
beta	0,200
S, T_b , T_c , T_d manually?	No
Subsoil type	C
Spectrum type	type 1
Direction	Horizontal
Direction factor	1
S - soil factor	1,150
T_b	0,200
T_c	0,600
T_d	2,000

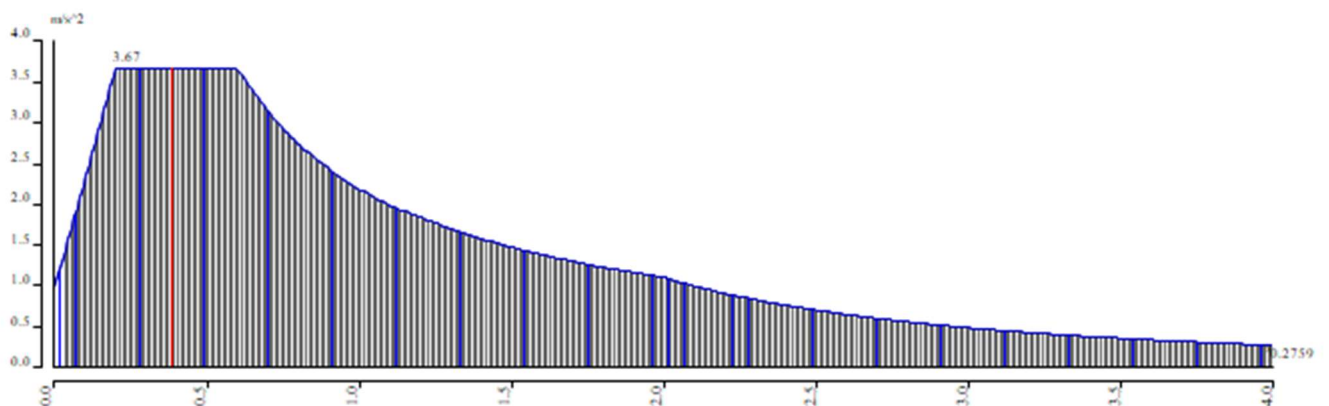

Slika 37: Prikaz elastičnog spektra odziva

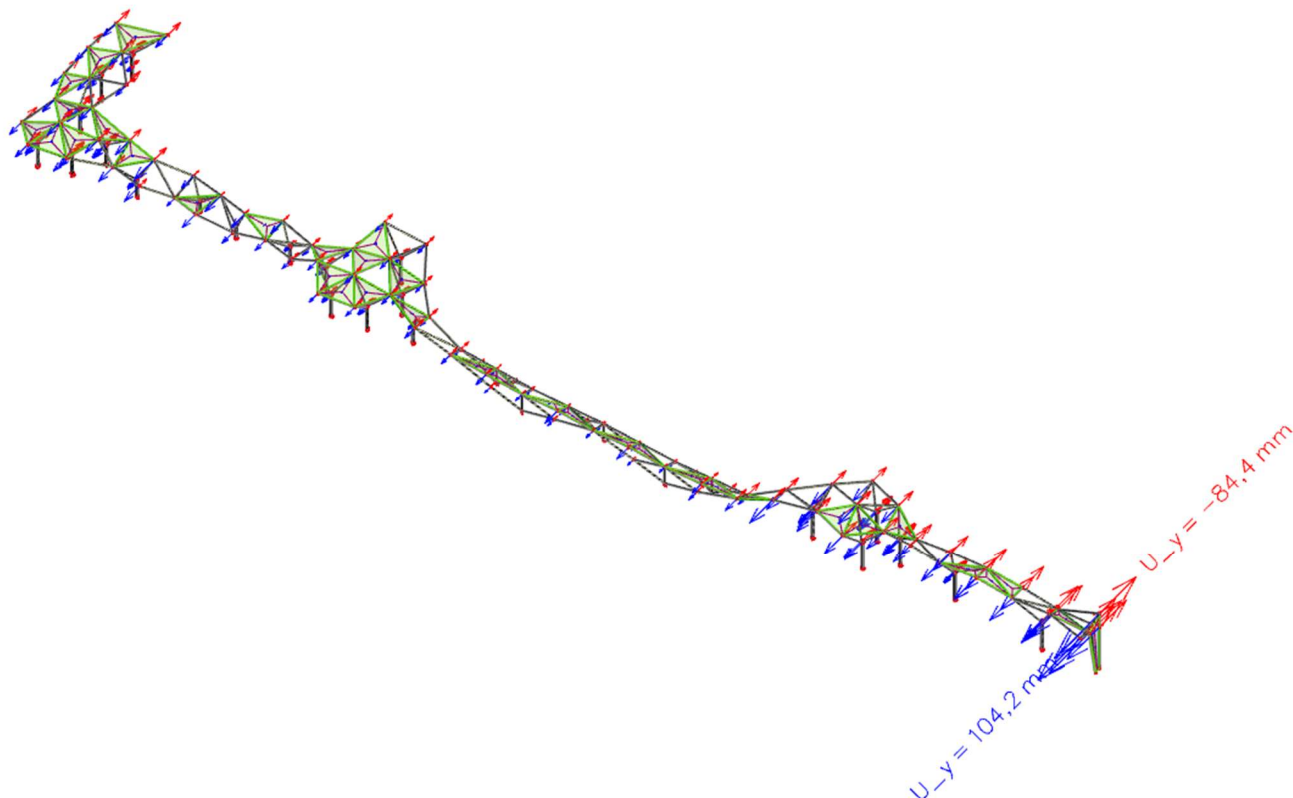

Slika 38: Pomaci u_y od kombinacije $GSU S_y$ - globalni maksimum

Maksimalni pomak: $u_x=104.2$ mm

Dopušteni pomak: $H/150=16000/150=106.67$ mm ≥ 104.2 mm

Zadovoljava!

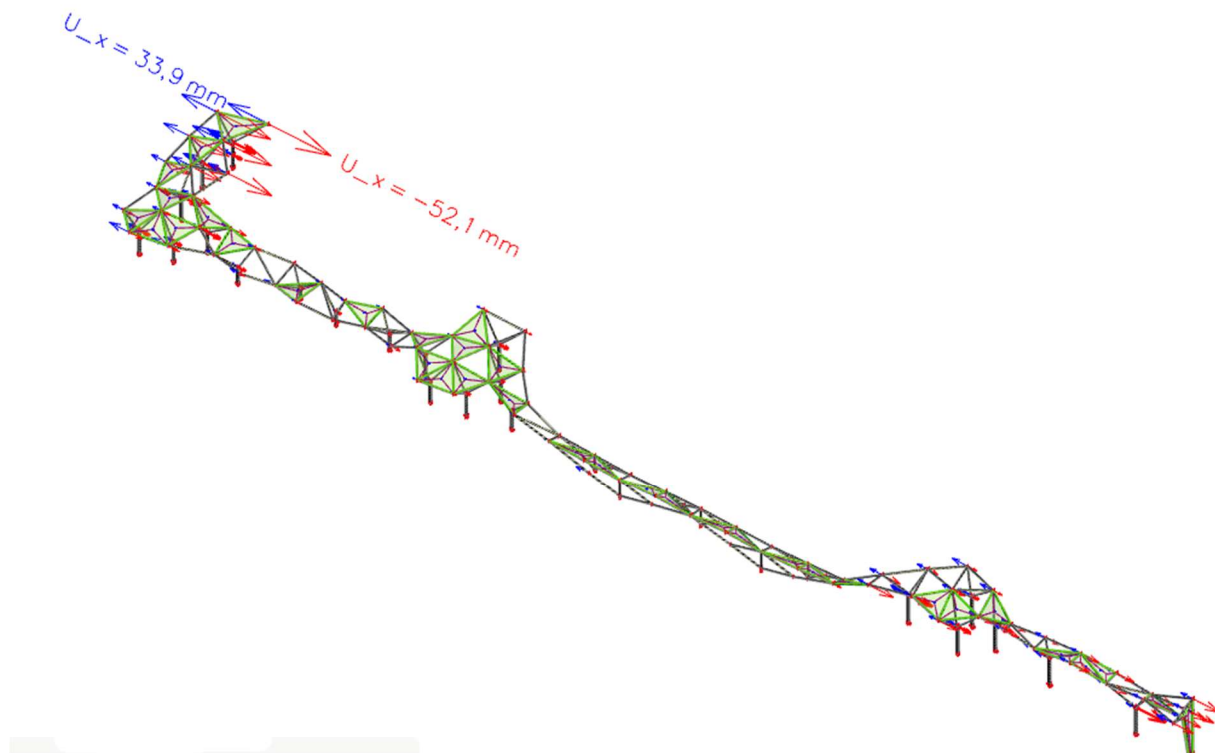

Slika 39: Pomaci u_x od kombinacije GSU Sx - globalni maksimum

Maksimalni pomak: $u_x=52.1$ mm

Dopušteni pomak: $H/150=14000/150=93.33$ mm ≥ 52.1 mm

Zadovoljava!

4. Dimenzioniranje konstrukcijskih elemenata

4.1. Pokrovni elementi – „PK“

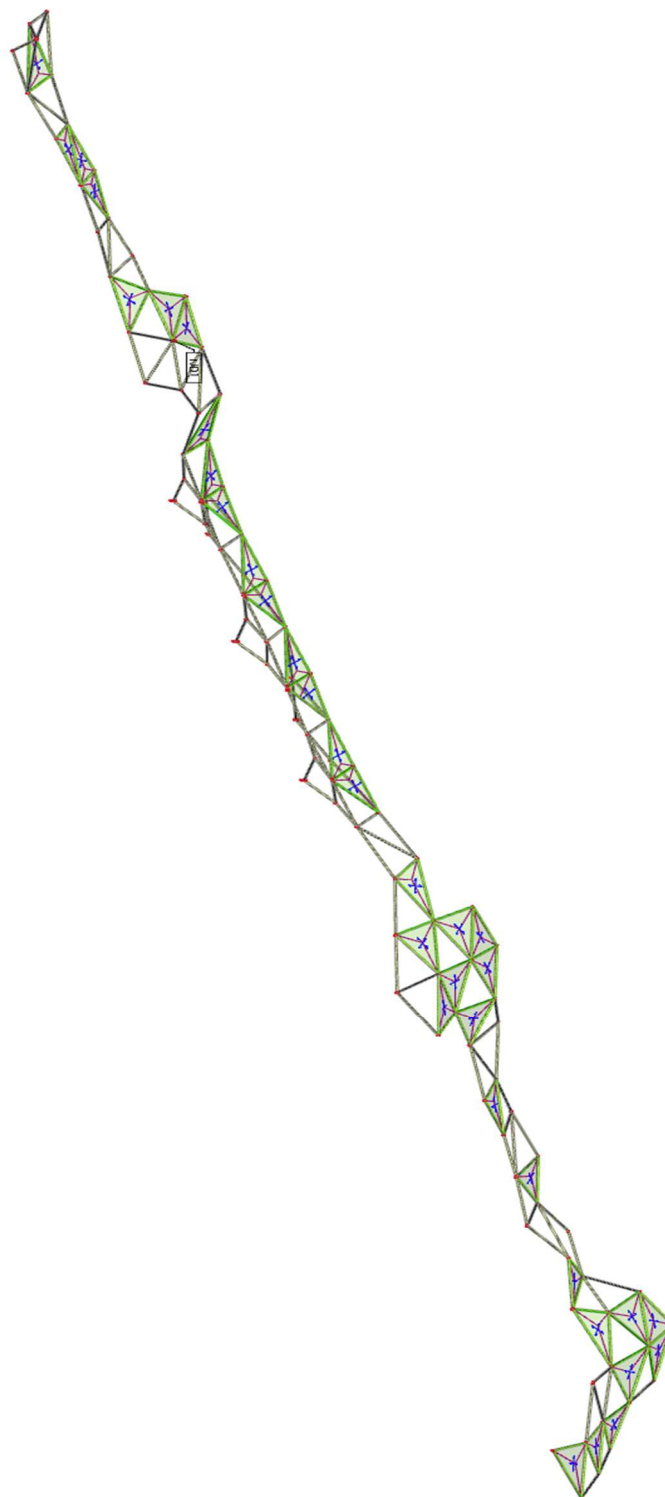

Slika 40: Prikaz pokrovnih elemenata konstrukcije „PK“

4.1.1. Rezne sile pokrovnih elemenata

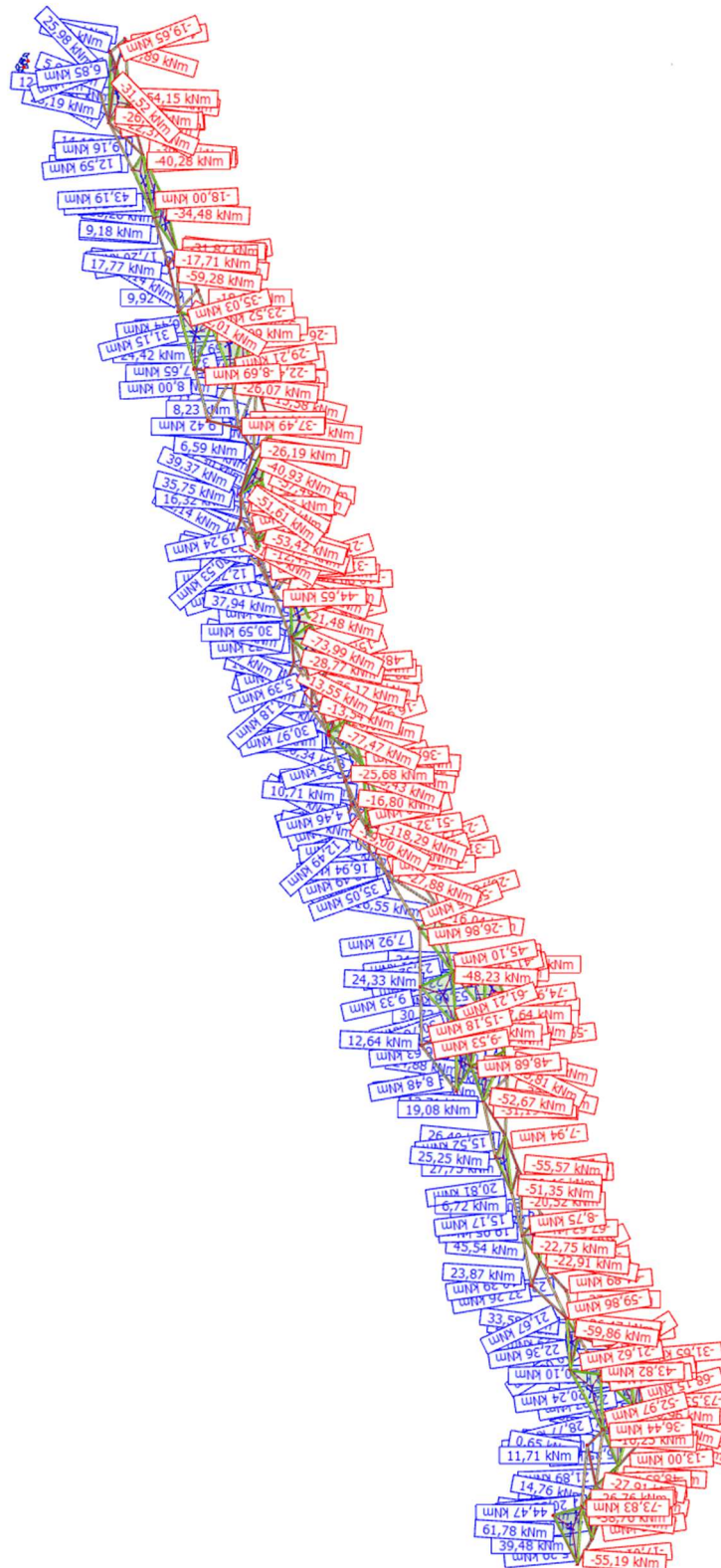
Slika 41: Moment savijanja M_y (kNm)- pokrovni nosači „PK“

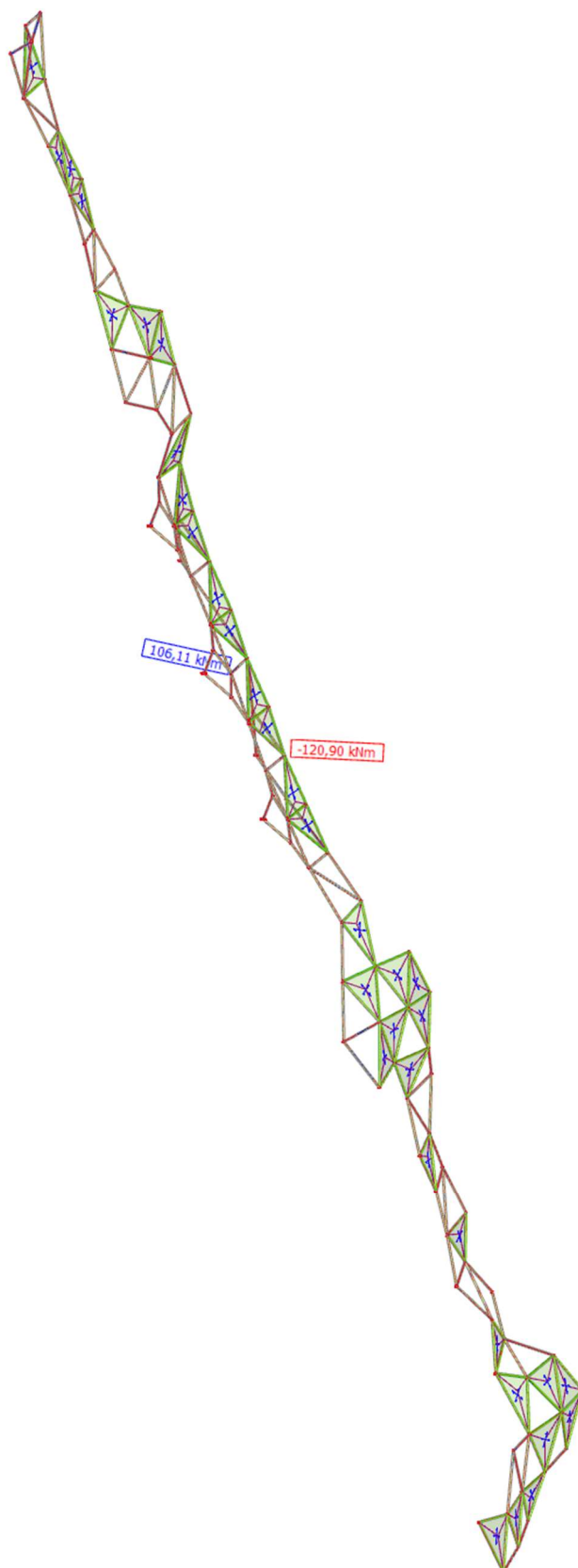

Slika 42: Moment savijanja M_y (kNm) - pokrovni nosači „PK“

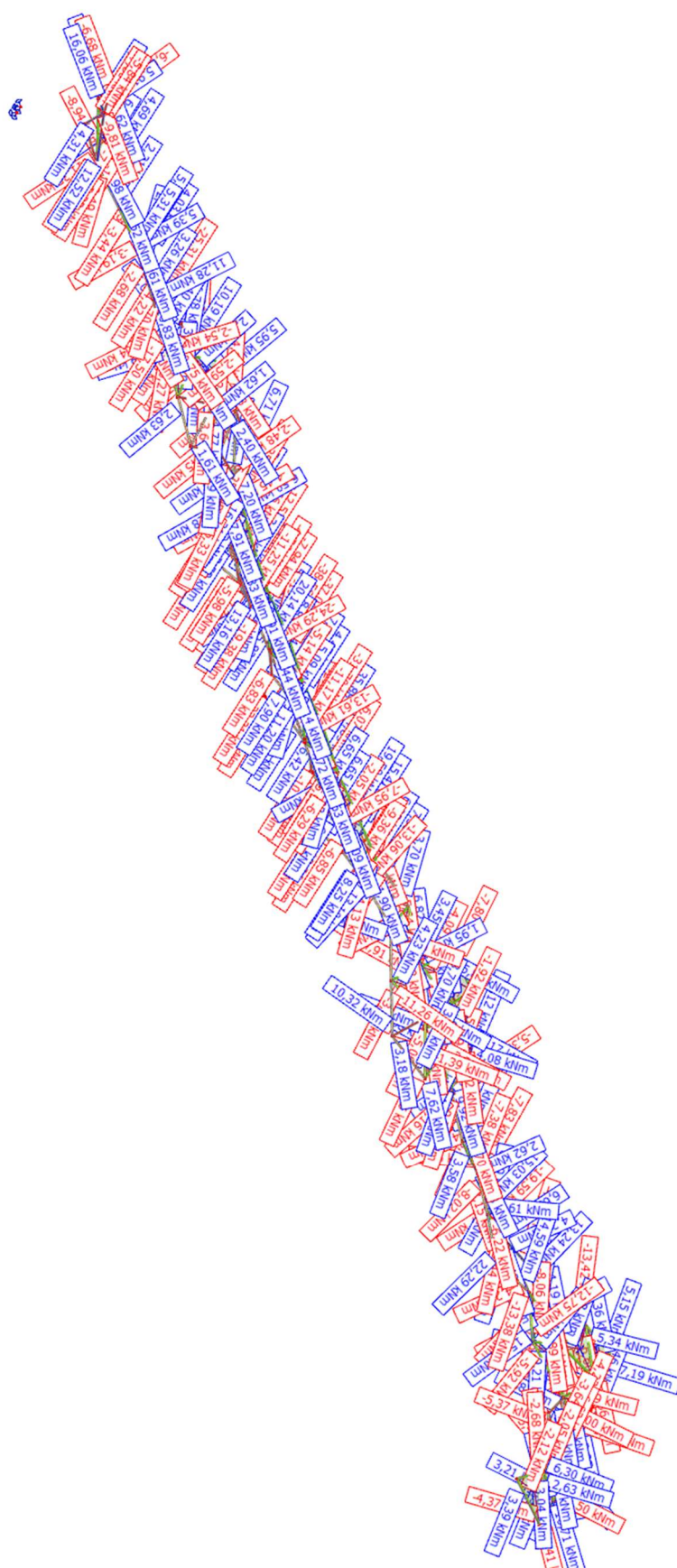

Slika 43: Moment savijanja M_z (kNm)- pokrovni nosači „PK“

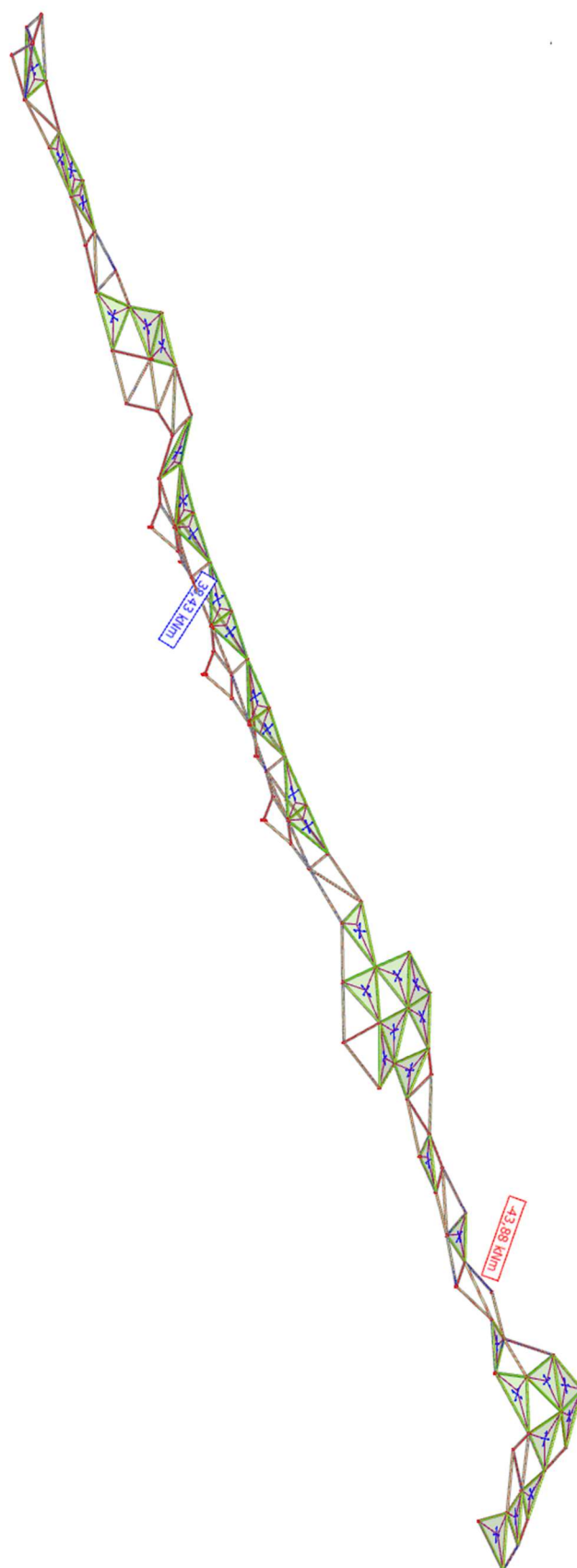

Slika 44: Moment savijanja M_z (kNm)- pokrovni nosači „PK“

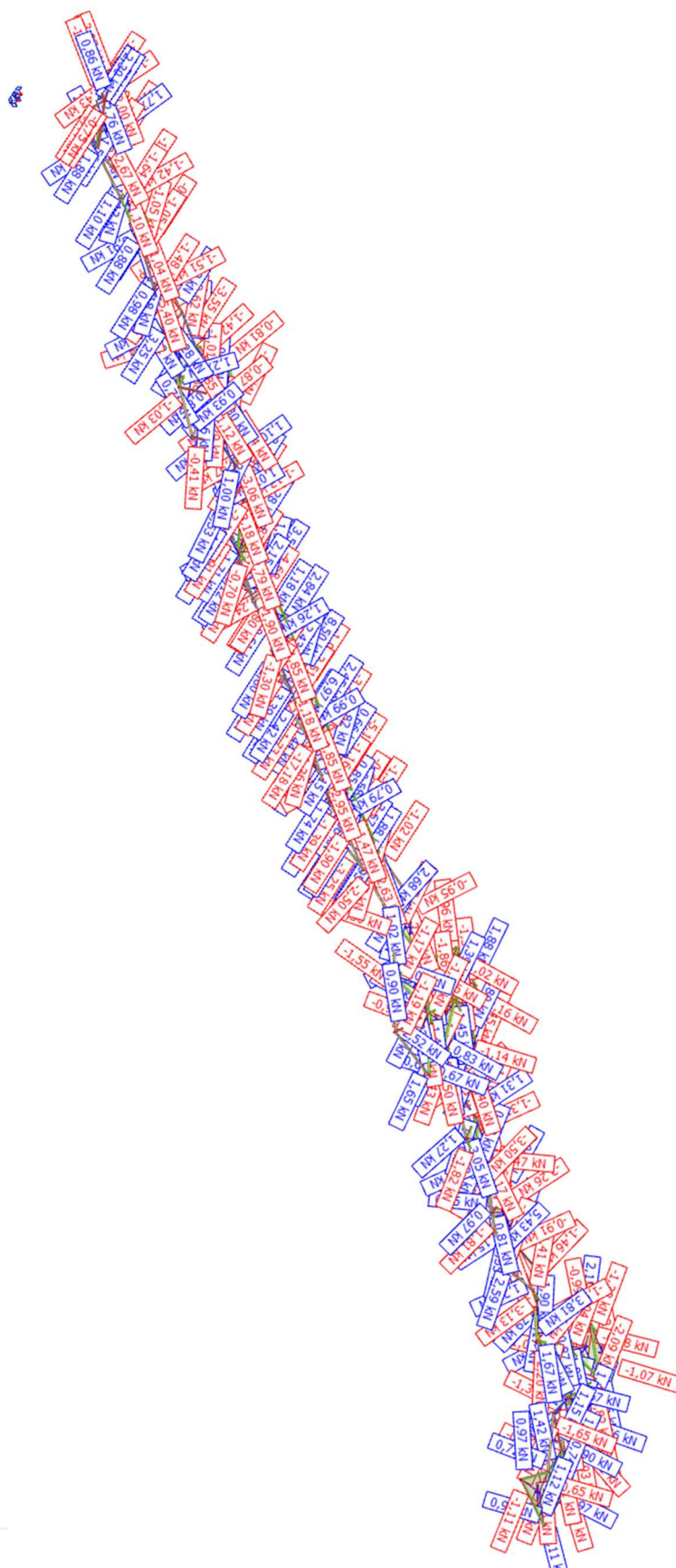

Slika 45: Poprečna sila V_y (kN)- pokrovni nosači „PK“

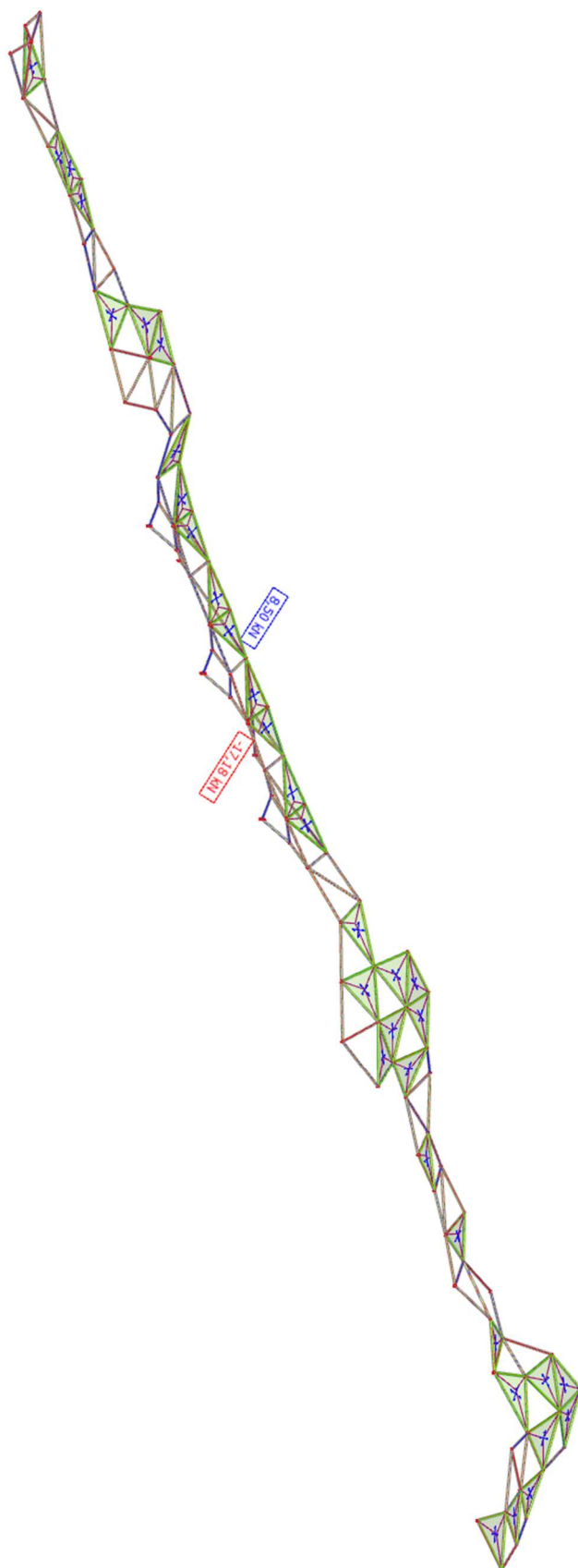

Slika 46: Poprečna sila V_Y (kN)- pokrovni nosači „PK“

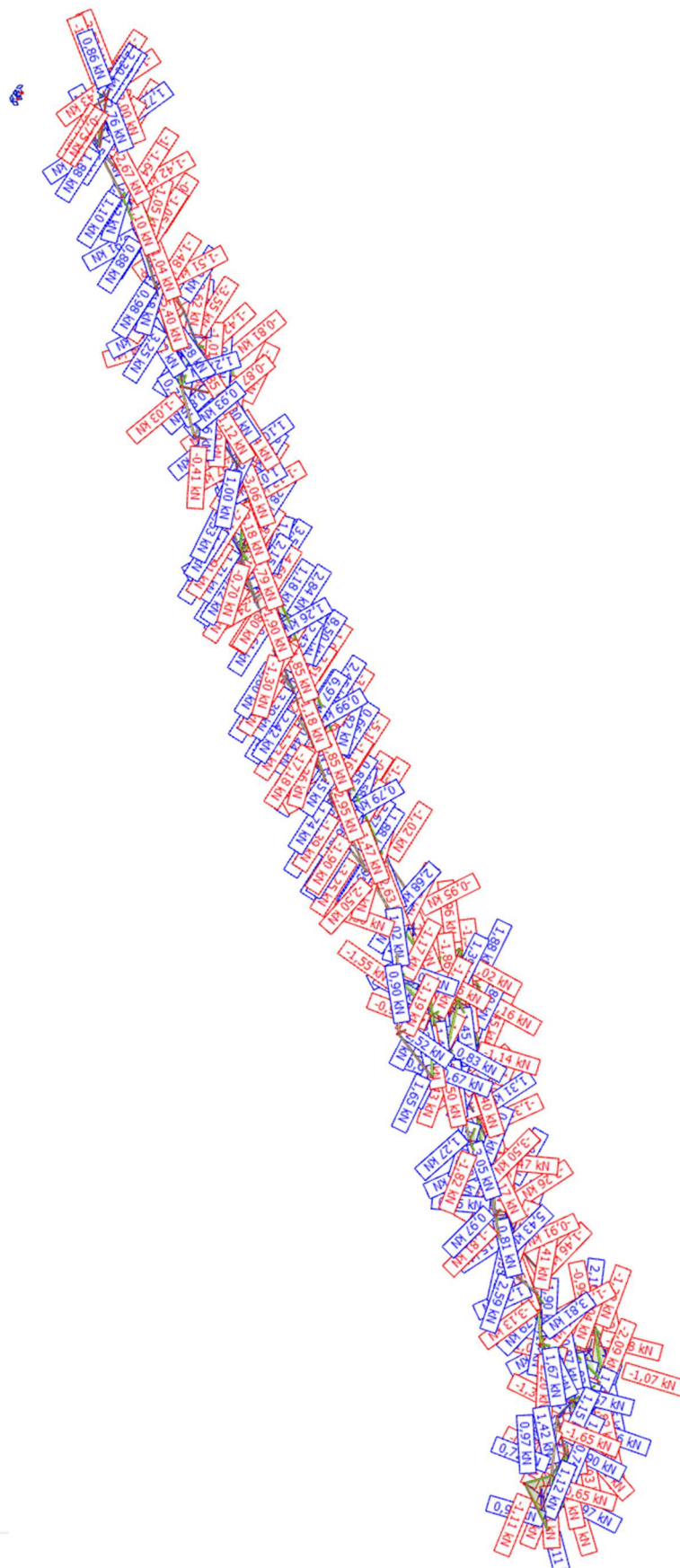

Slika 47: Poprečna sila V_z (kN)- pokrovni nosači „PK“

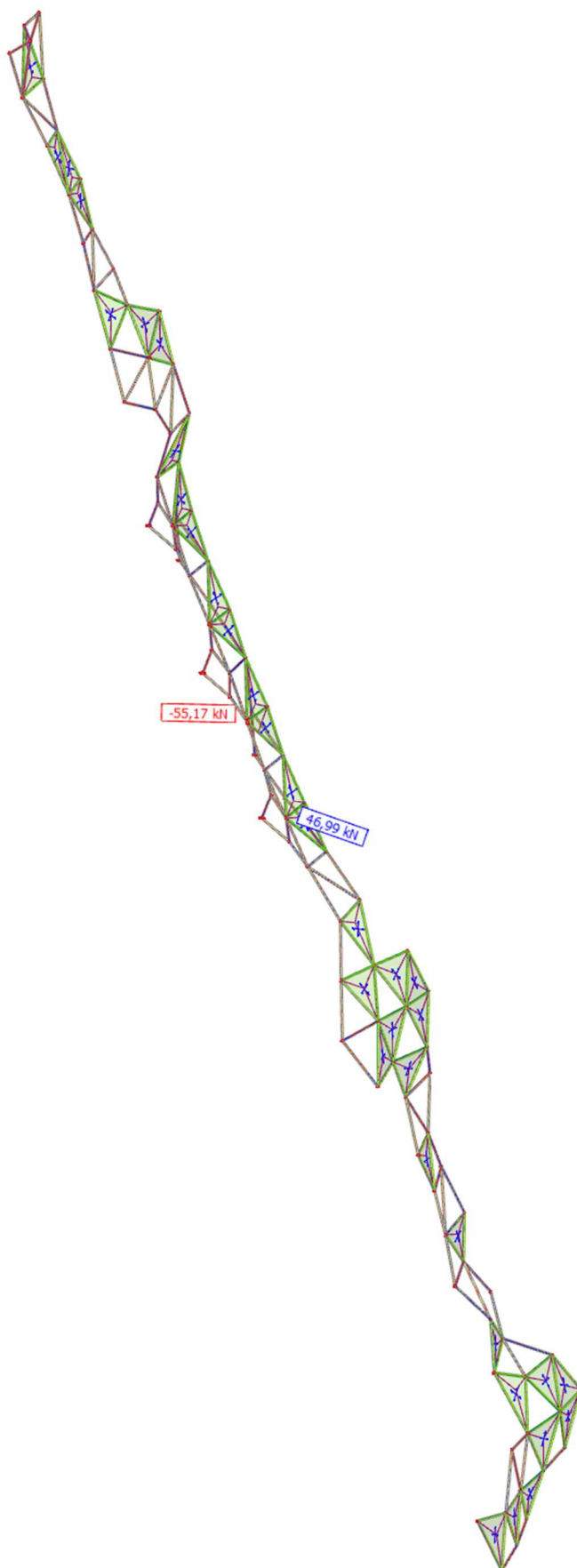

ž

Slika 48: Poprečna sila V_z (kN)- pokrovni nosači „PK“

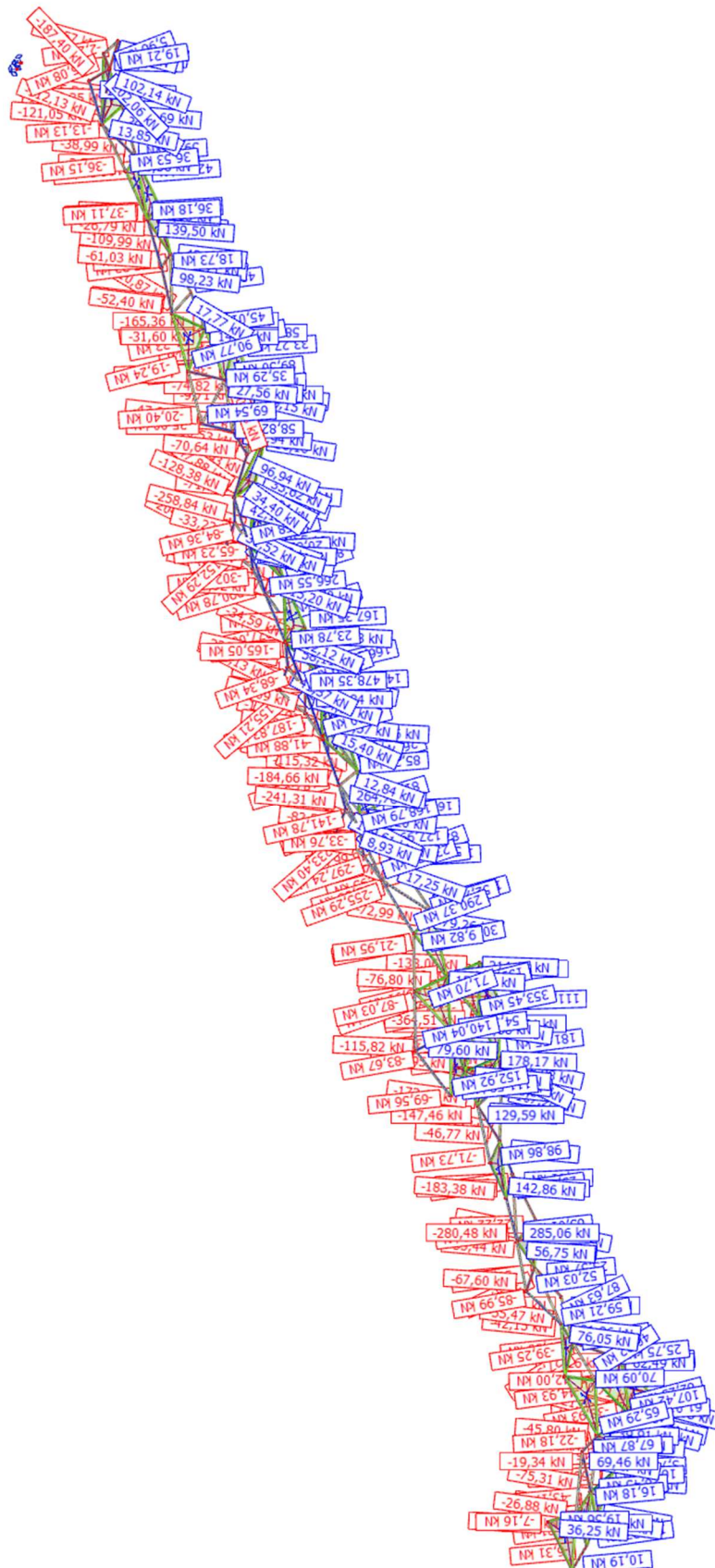

Slika 49: Uzdužna sila $N(kN)$ - pokrovni nosači „PK“

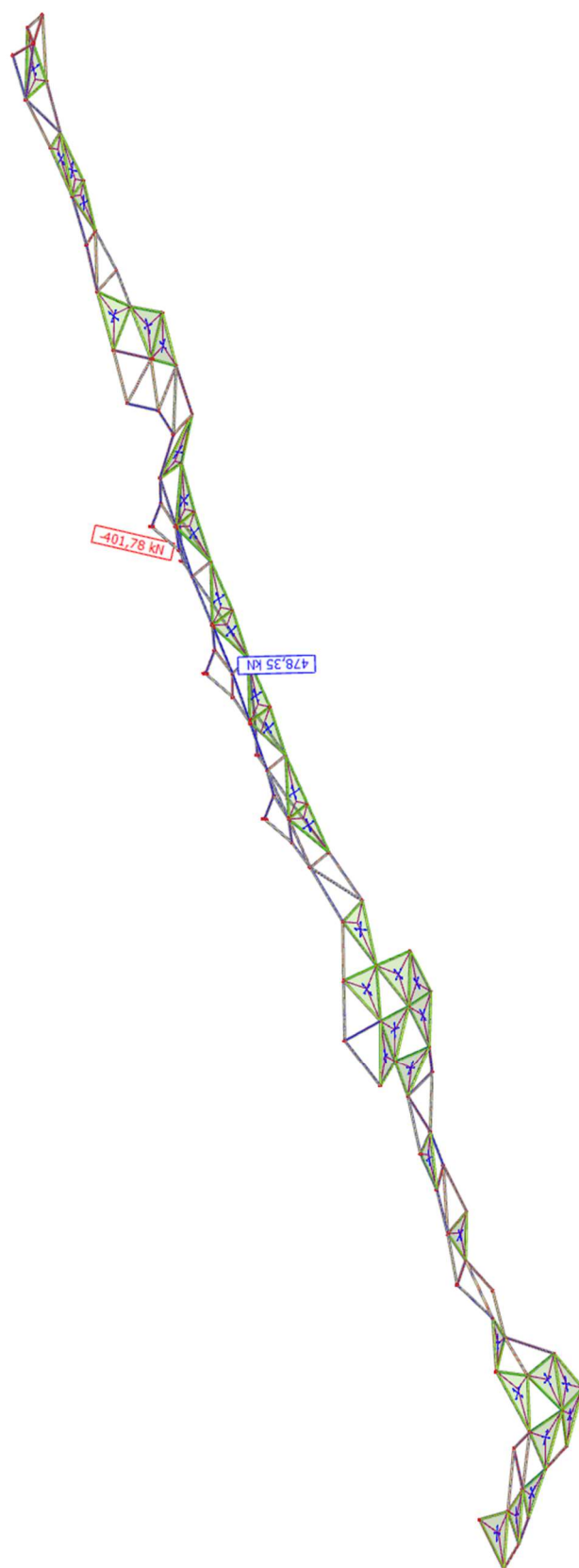

Slika 50: Uzdužna sila $N(kN)$ - pokrovni nosači „PK“

4.1.2. Dimenzioniranje pokrovnih nosača

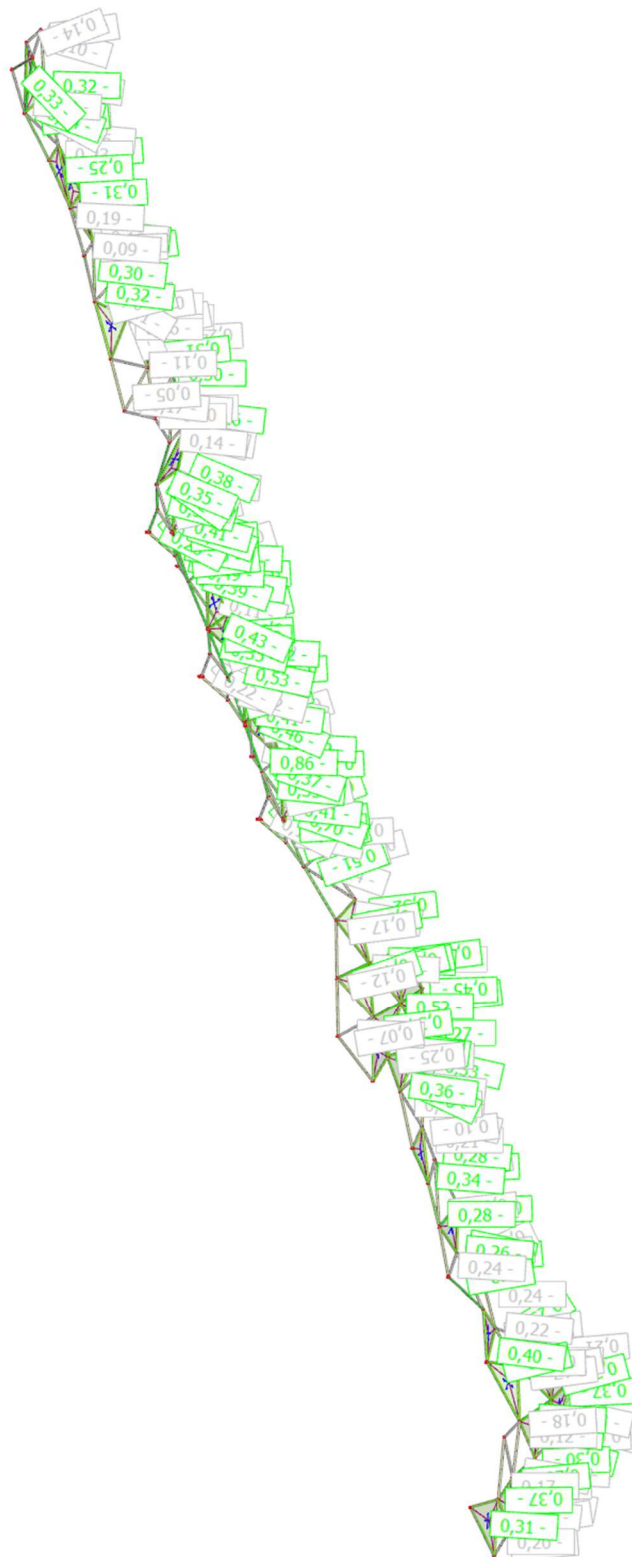

Slika 51: Prikaz iskoristivosti pokrovnih nosača „PK“

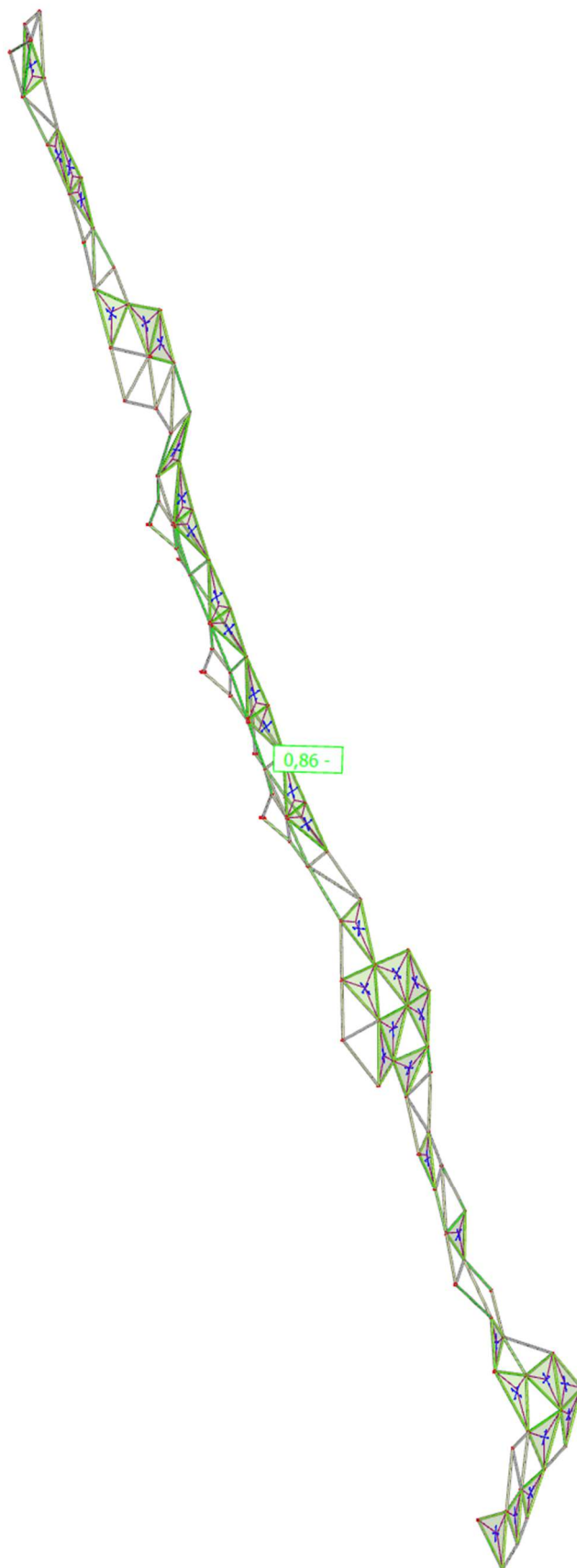

Slika 52: Prikaz iskoristivosti pokrovnih nosača „PK“

EC-EN 1993 Steel check ULS

Linear calculation
 Combination: ULS-Set B (auto)
 Coordinate system: Principal
 Extreme 1D: Global
 Selection: All

EN 1993-1-1 Code Check

National annex: Standard EN

Member B5563	18,188 / 18,188 m	CFCHS273X8	Cold formed	S 355	ULS-Set B (auto)	0,86 -
---------------------	--------------------------	-------------------	--------------------	--------------	-------------------------	---------------

Note: EN 1993-1-3 article 1.1(3) specifies that this part does not apply to cold formed CHS and RHS sections. The default EN 1993-1-1 code check is executed instead of the EN 1993-1-3 code check.

Combination key	
ULS-Set B (auto) / G + dg + 1.50*T+ + 0.90*w3(odizanje)	

Partial safety factors			
Resistance of cross-sections	γ_{M0}	1,00	
Resistance to instability	γ_{M1}	1,10	
Resistance of net sections	γ_{M2}	1,25	

Material			
Yield strength	f_y	355,0	MPa
Ultimate strength	f_u	490,0	MPa

....:SECTION CHECK:....

The critical check is on position 18,188 m

Internal forces		Calculated	Unit
Normal force	N_{Ed}	-184,66	kN
Shear force	$V_{y,Ed}$	0,61	kN
Shear force	$V_{z,Ed}$	-4,50	kN
Torsion	T_{Ed}	11,16	kNm
Bending moment	$M_{y,Ed}$	-14,03	kNm
Bending moment	$M_{z,Ed}$	3,42	kNm

Classification for cross-section design

Classification according to EN 1993-1-1 article 5.5.2

Classification of Tubular sections according to EN 1993-1-1 Table 5.2 Sheet 3

d [mm]	t [mm]	d/t [-]	Class 1 Limit [-]	Class 2 Limit [-]	Class 3 Limit [-]	Class
273	8	34,1	33,1	46,3	59,6	2

The cross-section is classified as Class 2

Compression check

According to EN 1993-1-1 article 6.2.4 and formula (6.9)

Cross-section area	A	6,6600e-03	m ²
Compression resistance	$N_{c,Rd}$	2364,30	kN
Unity check		0,08	-

$$N_{c,Rd} = \frac{A \times f_y}{\gamma_{M0}} = \frac{6,6600 \cdot 10^{-3} [m^2] \times 355,0 [MPa]}{1,00} = 2364,30 [kN]$$

$$\text{Unity check} = \frac{|N_{Ed}|}{N_{c,Rd}} = \frac{|-184,66 [kN]|}{2364,30 [kN]} = 0,08 \leq 1,00$$

Bending moment check for M_y

According to EN 1993-1-1 article 6.2.5 and formula (6.12),(6.13)

Plastic section modulus	$W_{pl,y}$	5,6197e-04	m ³
Plastic bending moment	$M_{pl,y,Rd}$	199,50	kNm
Unity check		0,07	-

$$M_{pl,y,Rd} = \frac{W_{pl,y} \times f_y}{\gamma_{M0}} = \frac{5,6197 \cdot 10^{-4} [m^3] \times 355,0 [MPa]}{1,00} = 199,50 [kNm]$$

$$\text{Unity check} = \frac{|M_{y,Ed}|}{M_{pl,y,Rd}} = \frac{|-14,03 [kNm]|}{199,50 [kNm]} = 0,07 \leq 1,00$$

Bending moment check for M_z

According to EN 1993-1-1 article 6.2.5 and formula (6.12),(6.13)

Plastic section modulus	$W_{pl,z}$	5,6197e-04	m ³
Plastic bending moment	$M_{pl,z,Rd}$	199,50	kNm
Unity check		0,02	-

$$M_{pl,z,Rd} = \frac{W_{pl,z} \times f_y}{\gamma_{M0}} = \frac{5,6197 \cdot 10^{-4} [m^3] \times 355,0 [MPa]}{1,00} = 199,50 [kNm]$$

$$\text{Unity check} = \frac{|M_{z,Ed}|}{M_{pl,z,Rd}} = \frac{|3,42 [kNm]|}{199,50 [kNm]} = 0,02 \leq 1,00$$

Shear check for V_y

According to EN 1993-1-1 article 6.2.6 and formula (6.17)

Shear correction factor	η	1,20	
Shear area	A_v	4,2399e-03	m ²
Plastic shear resistance for V_y	$V_{pl,y,Rd}$	869,00	kN
Unity check		0,00	-

$$V_{pl,y,Rd} = \frac{A_v \times \frac{f_y}{\sqrt{3}}}{\gamma_{M0}} = \frac{4,2399 \cdot 10^{-3} [m^2] \times \frac{355,0 [MPa]}{\sqrt{3}}}{1,00} = 869,00 [kN]$$

$$\text{Unity check} = \frac{|V_{y,Ed}|}{V_{c,y,Rd}} = \frac{|0,61 [kN]|}{869,00 [kN]} = 0,00 \leq 1,00$$

Shear check for V_z

According to EN 1993-1-1 article 6.2.6 and formula (6.17)

Shear correction factor	η	1,20	
Shear area	A_v	4,2399e-03	m ²
Plastic shear resistance for V_z	$V_{pl,z,Rd}$	869,00	kN
Unity check		0,01	-

$$V_{pl,z,Rd} = \frac{A_v \times \frac{f_y}{\sqrt{3}}}{\gamma_{M0}} = \frac{4,2399 \cdot 10^{-3} [m^2] \times \frac{355,0 [MPa]}{\sqrt{3}}}{1,00} = 869,00 [kN]$$

$$\text{Unity check} = \frac{|V_{z,Ed}|}{V_{c,z,Rd}} = \frac{|-4,50 [kN]|}{869,00 [kN]} = 0,01 \leq 1,00$$

Torsion check

According to EN 1993-1-1 article 6.2.7 and formula (6.23)

Index of fibre	Fibre	1	
Total torsional moment	T_{Ed}	12,6	MPa
Elastic shear resistance	T_{Rd}	205,0	MPa
Unity check		0,06	-

$$\tau_{Ed} = \left| \frac{T_{Ed}}{T_{Ed,unit}} \times \tau_{Ed,unit} \right| = \left| \frac{11,16[\text{kNm}]}{1,00[\text{kNm}]} \times 1133,179[\text{kN/m}^2] \right| = 12,6[\text{MPa}]$$

$$\tau_{Rd} = \frac{f_y}{\sqrt{3} \times \gamma_{M0}} = \frac{355,0[\text{MPa}]}{\sqrt{3} \times 1,00} = 205,0[\text{MPa}]$$

$$\text{Unity check} = \frac{\tau_{Ed}}{\tau_{Rd}} = \frac{12,6[\text{MPa}]}{205,0[\text{MPa}]} = \mathbf{0,06} \leq \mathbf{1,00}$$

Combined Shear and Torsion check for V_y and $\tau_{t,Ed}$

According to EN 1993-1-1 article 6.2.6 & 6.2.7 and formula (6.25),(6.28)

Plastic shear resistance for V_y and T_{Ed}	$V_{pl,T,y,Rd}$	815,38	kN
Unity check		0,00	-

$$V_{pl,T,y,Rd} = \left(1 - \frac{\tau_{t,Ed} \times \gamma_{M0} \times \sqrt{3}}{f_y} \right) \times V_{pl,y,Rd} = \left(1 - \frac{12,6[\text{MPa}] \times 1,00 \times \sqrt{3}}{355,0[\text{MPa}]} \right) \times 869,00[\text{kN}] = 815,38[\text{kN}]$$

$$\text{Unity check} = \frac{|V_{y,Ed}|}{V_{pl,T,y,Rd}} = \frac{|0,61[\text{kN}]|}{815,38[\text{kN}]} = \mathbf{0,00} \leq \mathbf{1,00}$$

Combined Shear and Torsion check for V_z and $\tau_{t,Ed}$

According to EN 1993-1-1 article 6.2.6 & 6.2.7 and formula (6.25),(6.28)

Plastic shear resistance for V_z and T_{Ed}	$V_{pl,T,z,Rd}$	815,38	kN
Unity check		0,01	-

$$V_{pl,T,z,Rd} = \left(1 - \frac{\tau_{t,Ed} \times \gamma_{M0} \times \sqrt{3}}{f_y} \right) \times V_{pl,z,Rd} = \left(1 - \frac{12,6[\text{MPa}] \times 1,00 \times \sqrt{3}}{355,0[\text{MPa}]} \right) \times 869,00[\text{kN}] = 815,38[\text{kN}]$$

$$\text{Unity check} = \frac{|V_{z,Ed}|}{V_{pl,T,z,Rd}} = \frac{|-4,50[\text{kN}]|}{815,38[\text{kN}]} = \mathbf{0,01} \leq \mathbf{1,00}$$

Combined bending, axial force and shear force check

According to EN 1993-1-1 article 6.2.9.1 and formula (6.31)

Resultant bending moment	$M_{resultant}$	14,44	kNm
Resultant shear force	$V_{resultant}$	4,55	kN
Design plastic moment resistance reduced due to N_{Ed}	$M_{N,Rd}$	196,88	kNm
Unity check		0,07	-

$$n = \frac{|N_{Ed}|}{N_{pl,Rd}} = \frac{|-184,66[\text{kN}]|}{2364,30[\text{kN}]} = 0,08$$

$$M_{N,Rd} = M_{pl,Rd} \times (1 - n^{1,7}) = 199,50[\text{kNm}] \times (1 - 0,08^{1,7}) = 196,88[\text{kNm}]$$

$$\text{Unity check} = \frac{|M_{resultant}|}{M_{N,Rd}} = \frac{|14,44[\text{kNm}]|}{196,88[\text{kNm}]} = \mathbf{0,07} \leq \mathbf{1,00}$$

Note: The resultant internal forces are used for CHS sections.**Note:** Since the shear forces are less than half the plastic shear resistances their effect on the moment resistances is neglected.

The member satisfies the section check.

...:STABILITY CHECK:...:

Classification for member buckling design

Decisive position for stability classification: 0,000 m

Decisive utilisation factor η : 0,07

Classification according to EN 1993-1-1 article 5.5.2

Classification of Tubular sections according to EN 1993-1-1 Table 5.2 Sheet 3

d [mm]	t [mm]	d/t [-]	Class 1 Limit [-]	Class 2 Limit [-]	Class 3 Limit [-]	Class
273	8	34,1	33,1	46,3	59,6	2

The cross-section is classified as Class 2

Note: The decisive position for the stability classification is based on the utilisation factor η according to Semi-Comp+.**Flexural Buckling check**

According to EN 1993-1-1 article 6.3.1.1 and formula (6.46)

Buckling parameters		yy	zz	
Sway type		sway	non-sway	
System length	L	18,188	18,188	m
Buckling factor	k	1,12	0,59	
Buckling length	l_{cr}	20,361	10,772	m
Critical Euler load	N_{cr}	292,55	1045,32	kN
Slenderness	λ	217,22	114,91	
Relative slenderness	λ_{rel}	2,84	1,50	
Limit slenderness	$\lambda_{rel,0}$	0,20	0,20	
Buckling curve		c	c	
Imperfection	α	0,49	0,49	
Reduction factor	χ	0,10	0,31	
Buckling resistance	$N_{b,Rd}$	225,57	673,32	kN

Flexural Buckling verification			
Cross-section area	A	6,6600e-03	m ²
Buckling resistance	$N_{b,Rd}$	225,57	kN
Unity check		0,82	-

$$N_{cr,y} = \frac{\pi^2 \times E \times I_y}{l_{cr,y}^2} = \frac{\pi^2 \times 210000,0[\text{MPa}] \times 5,8517 \cdot 10^{-5}[\text{m}^4]}{20,361[\text{m}]^2} = 292,55[\text{kN}]$$

$$N_{cr,z} = \frac{\pi^2 \times E \times I_z}{l_{cr,z}^2} = \frac{\pi^2 \times 210000,0[\text{MPa}] \times 5,8517 \cdot 10^{-5}[\text{m}^4]}{10,772[\text{m}]^2} = 1045,32[\text{kN}]$$

$$\lambda_y = \frac{l_{cr,y}}{i_y} = \frac{20,361[\text{m}]}{94[\text{mm}]} = 217,22$$

$$\lambda_z = \frac{l_{cr,z}}{i_z} = \frac{10,772[\text{m}]}{94[\text{mm}]} = 114,91$$

$$\lambda_{rel,y} = \frac{\lambda_y}{\pi \times \sqrt{\frac{E}{f_y}}} = \frac{217,22}{\pi \times \sqrt{\frac{210000,0[\text{MPa}]}{355,0[\text{MPa}]}}} = 2,84$$

$$\lambda_{rel,z} = \frac{\lambda_z}{\pi \times \sqrt{\frac{E}{f_y}}} = \frac{114,91}{\pi \times \sqrt{\frac{210000,0[\text{MPa}]}{355,0[\text{MPa}]}}} = 1,50$$

$$\varphi_y = 0,5 \times [1 + \alpha_y \times (\lambda_{rel,y} - \lambda_{rel,y,0}) + \lambda_{rel,y}^2] = 0,5 \times [1 + 0,49 \times (2,84 - 0,20) + 2,84^2] = 5,19$$

$$\varphi_z = 0,5 \times [1 + \alpha_z \times (\lambda_{rel,z} - \lambda_{rel,z,0}) + \lambda_{rel,z}^2] = 0,5 \times [1 + 0,49 \times (1,50 - 0,20) + 1,50^2] = 1,95$$

$$\chi_y = \min \left(\frac{1}{\varphi_y + \sqrt{\varphi_y^2 - \lambda_{rel,y}^2}}, 1 \right) = \min \left(\frac{1}{5,19 + \sqrt{5,19^2 - 2,84^2}}, 1 \right) = \min(0,10,1) = 0,10$$

$$\chi_z = \min \left(\frac{1}{\varphi_z + \sqrt{\varphi_z^2 - \lambda_{rel,z}^2}}, 1 \right) = \min \left(\frac{1}{1,95 + \sqrt{1,95^2 - 1,50^2}}, 1 \right) = \min(0,31,1) = 0,31$$

$$N_{b,y,Rd} = \frac{\chi_y \times A \times f_y}{\gamma_{M1}} = \frac{0,10 \times 6,6600 \cdot 10^{-3} [m^2] \times 355,0 [MPa]}{1,10} = 225,57 [kN]$$

$$N_{b,z,Rd} = \frac{\chi_z \times A \times f_y}{\gamma_{M1}} = \frac{0,31 \times 6,6600 \cdot 10^{-3} [m^2] \times 355,0 [MPa]}{1,10} = 673,32 [kN]$$

$$N_{b,Rd} = \min(N_{b,y,Rd}, N_{b,z,Rd}) = \min(225,57 [kN], 673,32 [kN]) = 225,57 [kN]$$

$$\text{Unity check} = \frac{|N_{Ed}|}{N_{b,Rd}} = \frac{|-184,66 [kN]|}{225,57 [kN]} = \mathbf{0,82} \leq \mathbf{1,00}$$

Torsional(-Flexural) Buckling check

According to EN 1993-1-1 article 6.3.1.1 and formula (6.46)

Note: The cross-section concerns a CHS section which is not susceptible to Torsional(-Flexural) Buckling.

Lateral Torsional Buckling check

According to EN 1993-1-1 article 6.3.2.1

Note: The cross-section concerns a CHS section which is not susceptible to Lateral Torsional Buckling.

Bending and axial compression check

According to EN 1993-1-1 article 6.3.3 and formula (6.61),(6.62)

Bending and axial compression check parameters			
Interaction method		alternative method 1	
Cross-section area	A	6,6600e-03	m ²
Plastic section modulus	W _{pl,y}	5,6197e-04	m ³
Plastic section modulus	W _{pl,z}	5,6197e-04	m ³
Design compression force	N _{Ed}	184,66	kN
Design bending moment (maximum)	M _{y,Ed}	-14,03	kNm
Design bending moment (maximum)	M _{z,Ed}	3,42	kNm
Characteristic compression resistance	N _{Rk}	2364,30	kN
Characteristic moment resistance	M _{y,Rk}	199,50	kNm
Characteristic moment resistance	M _{z,Rk}	199,50	kNm
Reduction factor	χ _y	0,10	
Reduction factor	χ _z	0,31	
Reduction factor	χ _{LT}	1,00	
Interaction factor	k _{yy}	0,45	
Interaction factor	k _{yz}	0,50	
Interaction factor	k _{zy}	0,65	
Interaction factor	k _{zz}	1,13	

Maximum moment M_{y,Ed} is derived from beam B5563 position 18,188 m.

Maximum moment M_{z,Ed} is derived from beam B5563 position 18,188 m.

Interaction method 1 parameters			
Critical Euler load	N _{cr,y}	292,55	kN
Critical Euler load	N _{cr,z}	1045,32	kN
Elastic critical load	N _{cr,T}	537922,16	kN
Plastic section modulus	W _{pl,y}	5,6197e-04	m ³
Elastic section modulus	W _{el,y}	4,2870e-04	m ³
Plastic section modulus	W _{pl,z}	5,6197e-04	m ³
Elastic section modulus	W _{el,z}	4,2870e-04	m ³
Second moment of area	I _y	5,8517e-05	m ⁴

Interaction method 1 parameters			
Second moment of area	I_z	5,8517e-05	m^4
Torsional constant	I_t	1,1703e-04	m^4
Method for equivalent moment factor $C_{my,0}$		Table A.2 Line 2 (General)	
Design bending moment (maximum)	$M_{y,Ed}$	-14,03	kNm
Maximum relative deflection	δ_z	-3,1	mm
Equivalent moment factor	$C_{my,0}$	0,42	
Method for equivalent moment factor $C_{mz,0}$		Table A.2 Line 2 (General)	
Design bending moment (maximum)	$M_{z,Ed}$	3,42	kNm
Maximum relative deflection	δ_y	-1,3	mm
Equivalent moment factor	$C_{mz,0}$	0,85	
Factor	μ_y	0,39	
Factor	μ_z	0,87	
Factor	ϵ_y	1,18	
Factor	a_{LT}	0,00	
Critical moment for uniform bending	$M_{cr,0}$	1861,59	kNm
Relative slenderness	$\lambda_{rel,0}$	0,33	
Limit relative slenderness	$\lambda_{rel,0,lim}$	0,30	
Equivalent moment factor	C_{my}	0,42	
Equivalent moment factor	C_{mz}	0,85	
Equivalent moment factor	C_{mLT}	1,00	
Factor	b_{LT}	0,00	
Factor	c_{LT}	0,00	
Factor	d_{LT}	0,00	
Factor	e_{LT}	0,00	
Factor	w_y	1,31	
Factor	w_z	1,31	
Factor	n_{pl}	0,09	
Maximum relative slenderness	$\lambda_{rel,max}$	2,84	
Factor	C_{yy}	0,99	
Factor	C_{yz}	0,49	
Factor	C_{zy}	0,92	
Factor	C_{zz}	0,80	

Unity check (6.61) = 0,82 + 0,04 + 0,01 = 0,86 -

Unity check (6.62) = 0,27 + 0,05 + 0,02 = 0,35 -

$$N_{cr,y} = \frac{\pi^2 \times E \times I_y}{l_{cr,y}^2} = \frac{\pi^2 \times 210000,0[\text{MPa}] \times 5,8517 \cdot 10^{-5}[\text{m}^4]}{20,361[\text{m}]^2} = 292,55[\text{kN}]$$

$$N_{cr,z} = \frac{\pi^2 \times E \times I_z}{l_{cr,z}^2} = \frac{\pi^2 \times 210000,0[\text{MPa}] \times 5,8517 \cdot 10^{-5}[\text{m}^4]}{10,772[\text{m}]^2} = 1045,32[\text{kN}]$$

$$N_{cr,T} = \frac{1}{i_0^2} \times \left(G \times I_t + \frac{\pi^2 \times E \times I_w}{l_{cr}^2} \right) = \frac{1}{133[\text{mm}]^2} \times \left(80769,2[\text{MPa}] \times 1,1703 \cdot 10^{-4}[\text{m}^4] + \frac{\pi^2 \times 210000,0[\text{MPa}] \times 8,0163 \cdot 10^{-40}[\text{m}^6]}{18,188[\text{m}]^2} \right) = 537922,16[\text{kN}]$$

$$C_{my,0} = 1 + \left(\frac{\pi^2 \times E \times I_y \times |\delta_z|}{L^2 \times |M_{y,Ed}|} - 1 \right) \times \frac{|N_{Ed}|}{N_{cr,y}} = 1 + \left(\frac{\pi^2 \times 210000,0[\text{MPa}] \times 5,8517 \cdot 10^{-5}[\text{m}^4] \times |-3,1[\text{mm}]|}{18,188[\text{m}]^2 \times |-14,03[\text{kNm}]|} - 1 \right) \times \frac{|184,66[\text{kN}]|}{292,55[\text{kN}]} = 0,42$$

$$C_{mz,0} = 1 + \left(\frac{\pi^2 \times E \times I_z \times |\delta_y|}{L^2 \times |M_{z,Ed}|} - 1 \right) \times \frac{|N_{Ed}|}{N_{cr,z}} = 1 + \left(\frac{\pi^2 \times 210000,0[\text{MPa}] \times 5,8517 \cdot 10^{-5}[\text{m}^4] \times |-1,3[\text{mm}]|}{18,188[\text{m}]^2 \times |3,42[\text{kNm}]|} - 1 \right) \times \frac{|184,66[\text{kN}]|}{1045,32[\text{kN}]} = 0,85$$

$$\mu_y = \frac{1 - \frac{|N_{Ed}|}{N_{cr,y}}}{1 - \frac{\chi_y \times |N_{Ed}|}{N_{cr,y}}} = \frac{1 - \frac{|184,66[\text{kN}]|}{292,55[\text{kN}]}}{1 - \frac{0,10 \times |184,66[\text{kN}]|}{292,55[\text{kN}]}} = 0,39$$

$$\mu_z = \frac{1 - \frac{|N_{Ed}|}{N_{cr,z}}}{1 - \frac{\chi_z \times |N_{Ed}|}{N_{cr,z}}} = \frac{1 - \frac{184,66[\text{kN}]}{1045,32[\text{kN}]}}{1 - \frac{0,31 \times 184,66[\text{kN}]}{1045,32[\text{kN}]}} = 0,87$$

$$\varepsilon_y = \left| \frac{M_{y,Ed}}{N_{Ed}} \right| \times \frac{A}{W_{el,y}} = \left| \frac{-14,03[\text{kNm}]}{184,66[\text{kN}]} \right| \times \frac{6,6600 \cdot 10^{-3}[\text{m}^2]}{4,2870 \cdot 10^{-4}[\text{m}^3]} = 1,18$$

$$a_{LT} = \max \left(1 - \frac{l_t}{l_y}, 0 \right) = \max \left(1 - \frac{1,1703 \cdot 10^{-4}[\text{m}^4]}{5,8517 \cdot 10^{-5}[\text{m}^4]}, 0 \right) = \max(-1,00, 0,00) = 0,00$$

$$M_{cr,0} = \frac{C_1 \times \pi^2 \times E \times I_z}{(k \times l_{LT})^2} \times \left[\sqrt{\frac{\left(\frac{k}{k_w}\right)^2 \times I_w}{I_z} + \frac{(k \times l_{LT})^2 \times G \times I_t}{\pi^2 \times E \times I_z} + (C_2 \times z_g - C_3 \times z_j)^2} - (C_2 \times z_g - C_3 \times z_j) \right]$$

$$= \frac{1,00 \times \pi^2 \times 210000,0[\text{MPa}] \times 5,8517 \cdot 10^{-5}[\text{m}^4]}{(1,00 \times 18,188[\text{m}])^2} \times \left[\sqrt{\frac{\left(\frac{1,00}{1,00}\right)^2 \times 8,0163 \cdot 10^{-40}[\text{m}^6]}{5,8517 \cdot 10^{-5}[\text{m}^4]} + \frac{(1,00 \times 18,188[\text{m}])^2 \times 80769,2[\text{MPa}] \times 1,1703 \cdot 10^{-4}[\text{m}^4]}{\pi^2 \times 210000,0[\text{MPa}] \times 5,8517 \cdot 10^{-5}[\text{m}^4]} + (0,93 \times 0[\text{mm}] - 0,41 \times 0[\text{mm}])^2} - (0,93 \times 0[\text{mm}] - 0,41 \times 0[\text{mm}]) \right]$$

$$= 1861,59[\text{kNm}]$$

$$\lambda_{rel,0} = \sqrt{\frac{W_{pl,y} \times f_y}{M_{cr,0}}} = \sqrt{\frac{5,6197 \cdot 10^{-4}[\text{m}^3] \times 355,0[\text{MPa}]}{1861,59[\text{kNm}]}} = 0,33$$

$$\lambda_{rel,0,lim} = 0,2 \times \sqrt{C_1} \times \sqrt{\left(1 - \frac{|N_{Ed}|}{N_{cr,z}}\right) \times \left(1 - \frac{|N_{Ed}|}{N_{cr,T}}\right)} = 0,2 \times \sqrt{2,40} \times \sqrt{\left(1 - \frac{184,66[\text{kN}]}{1045,32[\text{kN}]}\right) \times \left(1 - \frac{184,66[\text{kN}]}{537922,16[\text{kN}]}\right)} = 0,30$$

$$C_{my} = C_{my,0} + (1 - C_{my,0}) \times \frac{\sqrt{\varepsilon_y} \times a_{LT}}{1 + \sqrt{\varepsilon_y} \times a_{LT}} = 0,42 + (1 - 0,42) \times \frac{\sqrt{1,18} \times 0,00}{1 + \sqrt{1,18} \times 0,00} = 0,42$$

$$C_{mz} = C_{mz,0} = 0,85$$

$$C_{mLT} = \max \left[C_{my}^2 \times \frac{a_{LT}}{\sqrt{\left(1 - \frac{|N_{Ed}|}{N_{cr,z}}\right) \times \left(1 - \frac{|N_{Ed}|}{N_{cr,T}}\right)}}, 1 \right] = \max \left[0,42^2 \times \frac{0,00}{\sqrt{\left(1 - \frac{184,66[\text{kN}]}{1045,32[\text{kN}]}\right) \times \left(1 - \frac{184,66[\text{kN}]}{537922,16[\text{kN}]}\right)}}, 1 \right]$$

$$= \max[0,00, 1,00] = 1,00$$

$$b_{LT} = 0,5 \times a_{LT} \times \lambda_{rel,0}^2 \times \frac{|M_{y,Ed}|}{\chi_{LT} \times M_{pl,y,Rd}} \times \frac{|M_{z,Ed}|}{M_{pl,z,Rd}} = 0,5 \times 0,00 \times 0,33^2 \times \frac{|-14,03[\text{kNm}]|}{1,00 \times 199,50[\text{kNm}]} \times \frac{|3,42[\text{kNm}]|}{199,50[\text{kNm}]} = 0,00$$

$$c_{LT} = 10 \times a_{LT} \times \frac{\lambda_{rel,0}^2}{5 + \lambda_{rel,z}^4} \times \frac{|M_{y,Ed}|}{C_{my} \times \chi_{LT} \times M_{pl,y,Rd}} = 10 \times 0,00 \times \frac{0,33^2}{5 + 1,50^4} \times \frac{|-14,03[\text{kNm}]|}{0,42 \times 1,00 \times 199,50[\text{kNm}]} = 0,00$$

$$d_{LT} = 2 \times a_{LT} \times \frac{\lambda_{rel,0}}{0,1 + \lambda_{rel,z}^4} \times \frac{|M_{y,Ed}|}{C_{my} \times \chi_{LT} \times M_{pl,y,Rd}} \times \frac{|M_{z,Ed}|}{C_{mz} \times M_{pl,z,Rd}}$$

$$= 2 \times 0,00 \times \frac{0,33}{0,1 + 1,50^4} \times \frac{|-14,03[\text{kNm}]|}{0,42 \times 1,00 \times 199,50[\text{kNm}]} \times \frac{|3,42[\text{kNm}]|}{0,85 \times 199,50[\text{kNm}]} = 0,00$$

$$e_{LT} = 1,7 \times a_{LT} \times \frac{\lambda_{rel,0}}{0,1 + \lambda_{rel,z}^4} \times \frac{|M_{y,Ed}|}{C_{my} \times \chi_{LT} \times M_{pl,y,Rd}} = 1,7 \times 0,00 \times \frac{0,33}{0,1 + 1,50^4} \times \frac{|-14,03[\text{kNm}]|}{0,42 \times 1,00 \times 199,50[\text{kNm}]} = 0,00$$

$$w_y = \min \left(\frac{W_{pl,y}}{W_{el,y}}, 1,5 \right) = \min \left(\frac{5,6197 \cdot 10^{-4}[\text{m}^3]}{4,2870 \cdot 10^{-4}[\text{m}^3]}, 1,5 \right) = \min(1,31, 1,50) = 1,31$$

$$w_z = \min \left(\frac{W_{pl,z}}{W_{el,z}}, 1, 5 \right) = \min \left(\frac{5,6197 \cdot 10^{-4} [m^3]}{4,2870 \cdot 10^{-4} [m^3]}, 1, 5 \right) = \min (1, 31, 1, 50) = 1, 31$$

$$n_{pl} = \frac{|N_{Ed}|}{N_{Rk}} = \frac{|184,66[kN]|}{\frac{2364,30[kN]}{1,10}} = 0,09$$

$$\lambda_{rel,max} = \max(\lambda_{rel,y}, \lambda_{rel,z}) = \max(2,84, 1,50) = 2,84$$

$$\begin{aligned} C_{yy} &= \max \left\{ 1 + (w_y - 1) \times \left[\left(2 - \frac{1,6}{w_y} \times C_{my}^2 \times \lambda_{rel,max} - \frac{1,6}{w_y} \times C_{my}^2 \times \lambda_{rel,max}^2 \right) \times n_{pl} - b_{LT} \right], \frac{W_{el,y}}{W_{pl,y}} \right\} \\ &= \max \left\{ 1 + (1,31 - 1) \times \left[\left(2 - \frac{1,6}{1,31} \times 0,42^2 \times 2,84 - \frac{1,6}{1,31} \times 0,42^2 \times 2,84^2 \right) \times 0,09 - 0,00 \right], \frac{4,2870 \cdot 10^{-4} [m^3]}{5,6197 \cdot 10^{-4} [m^3]} \right\} = \max \{0,99, 0,76\} \\ &= 0,99 \end{aligned}$$

$$\begin{aligned} C_{yz} &= \max \left\{ 1 + (w_z - 1) \times \left[\left(2 - 14 \times \frac{C_{mz}^2 \times \lambda_{rel,max}^2}{w_z^5} \right) \times n_{pl} - c_{LT} \right], 0,6 \times \sqrt{\frac{w_z}{w_y}} \times \frac{W_{el,z}}{W_{pl,z}} \right\} \\ &= \max \left\{ 1 + (1,31 - 1) \times \left[\left(2 - 14 \times \frac{0,85^2 \times 2,84^2}{1,31^5} \right) \times 0,09 - 0,00 \right], 0,6 \times \sqrt{\frac{1,31}{1,31}} \times \frac{4,2870 \cdot 10^{-4} [m^3]}{5,6197 \cdot 10^{-4} [m^3]} \right\} = \max \{0,49, 0,46\} = 0,49 \end{aligned}$$

$$\begin{aligned} C_{zy} &= \max \left\{ 1 + (w_y - 1) \times \left[\left(2 - 14 \times \frac{C_{my}^2 \times \lambda_{rel,max}^2}{w_y^5} \right) \times n_{pl} - d_{LT} \right], 0,6 \times \sqrt{\frac{w_y}{w_z}} \times \frac{W_{el,y}}{W_{pl,y}} \right\} \\ &= \max \left\{ 1 + (1,31 - 1) \times \left[\left(2 - 14 \times \frac{0,42^2 \times 2,84^2}{1,31^5} \right) \times 0,09 - 0,00 \right], 0,6 \times \sqrt{\frac{1,31}{1,31}} \times \frac{4,2870 \cdot 10^{-4} [m^3]}{5,6197 \cdot 10^{-4} [m^3]} \right\} = \max \{0,92, 0,46\} = 0,92 \end{aligned}$$

$$\begin{aligned} C_{zz} &= \max \left[1 + (w_z - 1) \times \left(2 - \frac{1,6}{w_z} \times C_{mz}^2 \times \lambda_{rel,max} - \frac{1,6}{w_z} \times C_{mz}^2 \times \lambda_{rel,max}^2 - e_{LT} \right) \times n_{pl}, \frac{W_{el,z}}{W_{pl,z}} \right] \\ &= \max \left[1 + (1,31 - 1) \times \left(2 - \frac{1,6}{1,31} \times 0,85^2 \times 2,84 - \frac{1,6}{1,31} \times 0,85^2 \times 2,84^2 - 0,00 \right) \times 0,09, \frac{4,2870 \cdot 10^{-4} [m^3]}{5,6197 \cdot 10^{-4} [m^3]} \right] = \max [0,80, 0,76] = 0,80 \end{aligned}$$

$$N_{Rk} = A \times f_y = 6,6600 \cdot 10^{-3} [m^2] \times 355,0 [MPa] = 2364,30 [kN]$$

$$M_{y,Rk} = W_{pl,y} \times f_y = 5,6197 \cdot 10^{-4} [m^3] \times 355,0 [MPa] = 199,50 [kNm]$$

$$M_{z,Rk} = W_{pl,z} \times f_y = 5,6197 \cdot 10^{-4} [m^3] \times 355,0 [MPa] = 199,50 [kNm]$$

$$k_{yy} = C_{my} \times C_{mLT} \times \frac{\mu_y}{1 - \frac{|N_{Ed}|}{N_{cr,y}}} \times \frac{1}{C_{yy}} = 0,42 \times 1,00 \times \frac{0,39}{1 - \frac{|184,66[kN]|}{292,55[kN]}} \times \frac{1}{0,99} = 0,45$$

$$k_{yz} = C_{mz} \times \frac{\mu_y}{1 - \frac{|N_{Ed}|}{N_{cr,z}}} \times \frac{1}{C_{yz}} \times 0,6 \times \sqrt{\frac{w_z}{w_y}} = 0,85 \times \frac{0,39}{1 - \frac{|184,66[kN]|}{1045,32[kN]}} \times \frac{1}{0,49} \times 0,6 \times \sqrt{\frac{1,31}{1,31}} = 0,50$$

$$k_{zy} = C_{my} \times C_{mLT} \times \frac{\mu_z}{1 - \frac{|N_{Ed}|}{N_{cr,y}}} \times \frac{1}{C_{zy}} \times 0,6 \times \sqrt{\frac{w_y}{w_z}} = 0,42 \times 1,00 \times \frac{0,87}{1 - \frac{|184,66[kN]|}{292,55[kN]}} \times \frac{1}{0,92} \times 0,6 \times \sqrt{\frac{1,31}{1,31}} = 0,65$$

$$k_{zz} = C_{mz} \times \frac{\mu_z}{1 - \frac{|N_{Ed}|}{N_{cr,z}}} \times \frac{1}{C_{zz}} = 0,85 \times \frac{0,87}{1 - \frac{|184,66[kN]|}{1045,32[kN]}} \times \frac{1}{0,80} = 1,13$$

$$\begin{aligned}
 \text{Unity check (6.61)} &= \frac{|N_{Ed}|}{\chi_y \times \frac{N_{Rk}}{\gamma_{M1}}} + k_{yy} \times \frac{|M_{y,Ed}| + |\Delta M_{y,Ed}|}{\chi_{LT} \times \frac{M_{y,Rk}}{\gamma_{M1}}} + k_{yz} \times \frac{|M_{z,Ed}| + |\Delta M_{z,Ed}|}{\frac{M_{z,Rk}}{\gamma_{M1}}} \\
 &= \frac{|184,66[\text{kN}]|}{0,10 \times \frac{2364,30[\text{kN}]}{1,10}} + 0,45 \times \frac{|-14,03[\text{kNm}]| + |0,00[\text{kNm}]|}{1,00 \times \frac{199,50[\text{kNm}]}{1,10}} + 0,50 \times \frac{|3,42[\text{kNm}]| + |0,00[\text{kNm}]|}{\frac{199,50[\text{kNm}]}{1,10}} = \mathbf{0,86} \leq \mathbf{1,00}
 \end{aligned}$$

$$\begin{aligned}
 \text{Unity check (6.62)} &= \frac{|N_{Ed}|}{\chi_z \times \frac{N_{Rk}}{\gamma_{M1}}} + k_{zy} \times \frac{|M_{y,Ed}| + |\Delta M_{y,Ed}|}{\chi_{LT} \times \frac{M_{y,Rk}}{\gamma_{M1}}} + k_{zz} \times \frac{|M_{z,Ed}| + |\Delta M_{z,Ed}|}{\frac{M_{z,Rk}}{\gamma_{M1}}} \\
 &= \frac{|184,66[\text{kN}]|}{0,31 \times \frac{2364,30[\text{kN}]}{1,10}} + 0,65 \times \frac{|-14,03[\text{kNm}]| + |0,00[\text{kNm}]|}{1,00 \times \frac{199,50[\text{kNm}]}{1,10}} + 1,13 \times \frac{|3,42[\text{kNm}]| + |0,00[\text{kNm}]|}{\frac{199,50[\text{kNm}]}{1,10}} = \mathbf{0,35} \leq \mathbf{1,00}
 \end{aligned}$$

$$\text{Unity check} = \max(\text{Unity check (6.61)}, \text{Unity check (6.62)}) = \max(0,86, 0,35) = \mathbf{0,86} \leq \mathbf{1,00}$$

The member satisfies the stability check.

4.1.3. Granično stanje uporabljivosti

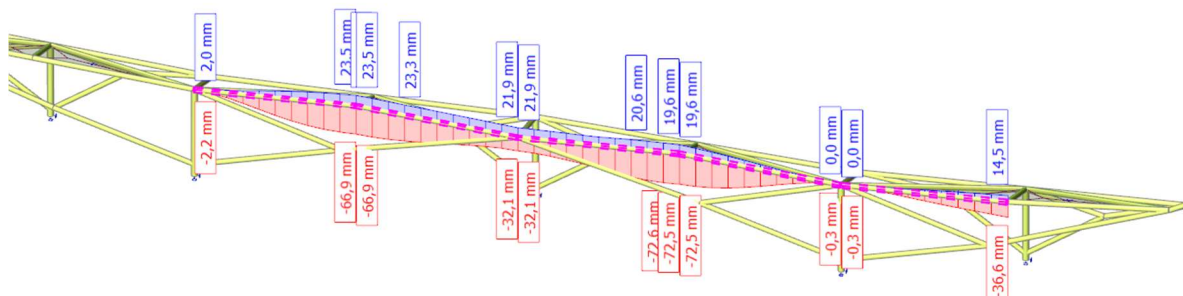

Slika 53: Prikaz pomaka pokrovnih nosača „PK“ (mm)

	u_z
Maksimalni pomak $u =$	40,4 mm
Duljina nosača $L =$	18,67 m
Dopušteni pomak $f_{p,dop.} =$	74,7 mm ($L/250$)

$$f_{max.} = 40,4 \text{ mm} < f_{p,dop.} = 74,7 \text{ mm}$$

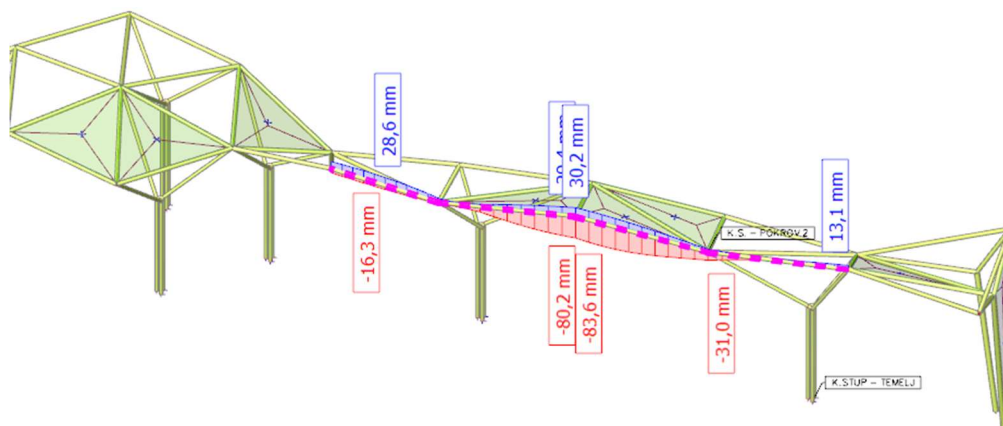

Slika 54: Prikaz pomaka pokrovnih nosača „PK“ (mm)

	u_z
Maksimalni pomak $u =$	60,0 mm
Duljina nosača $L =$	18,36 m
Dopušteni pomak $f_{p,dop.} =$	73,4 mm ($L/250$)

$$f_{max.} = 60,0 \text{ mm} < f_{p,dop.} = 73,4 \text{ mm}$$

4.2. Trostruki stup „S1“

4.2.1. Rezne sile trostrukog stupa „S1“

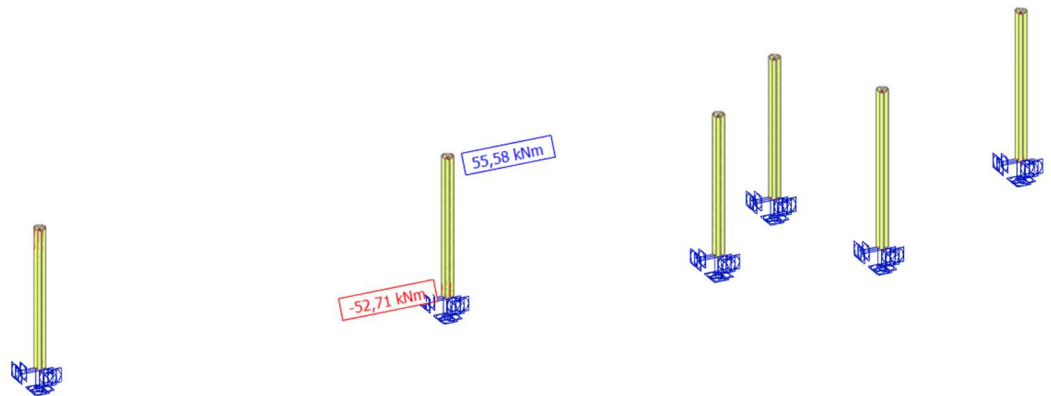

Slika 55: Moment savijanja M_y (kNm)- trostruki stup „S1“ od osi N1 do N7

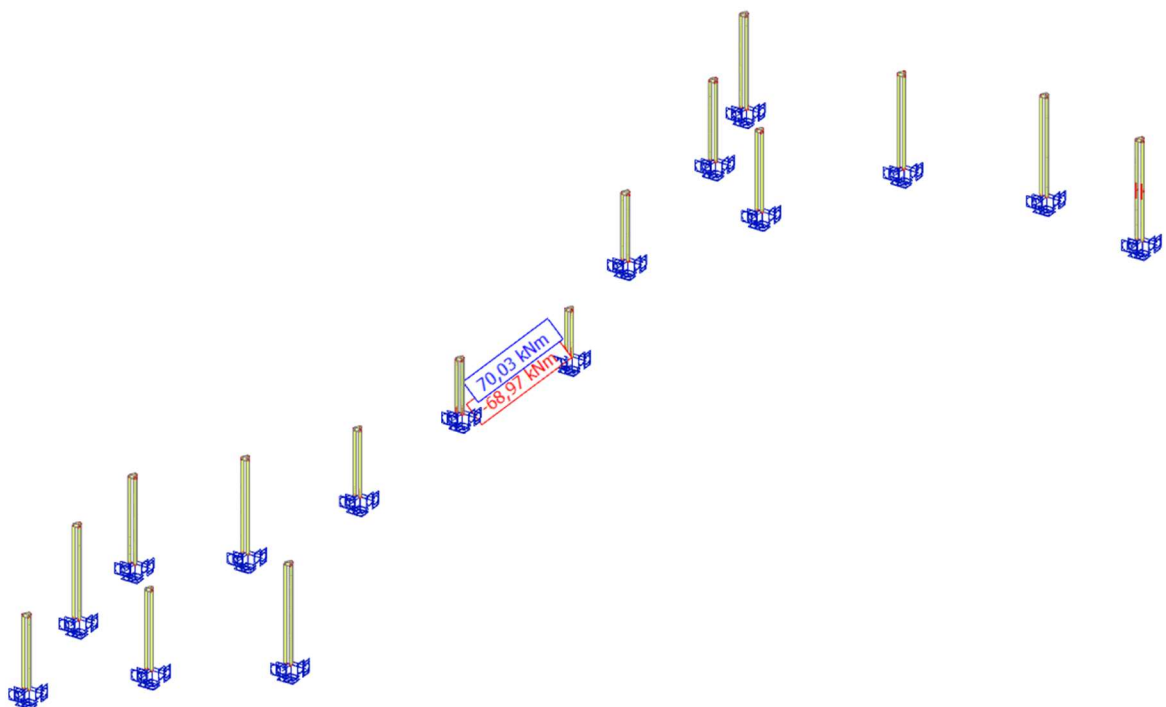

Slika 56: Moment savijanja M_y (kNm)- trostruki stup „S1“ od osi N13 do N27

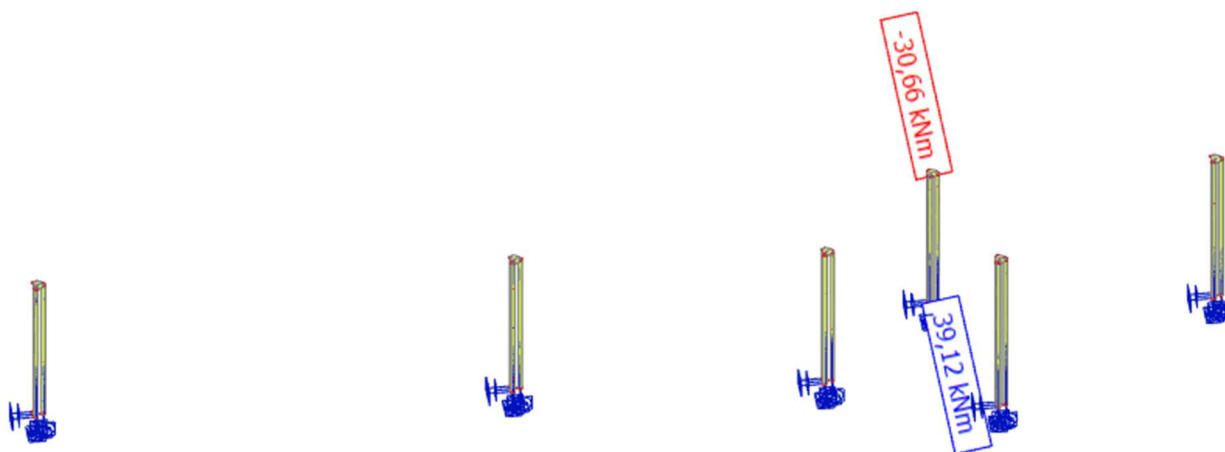

Slika 58: Moment savijanja M_z (kNm)- trostruki stup „S1“ od osi N1 do N7

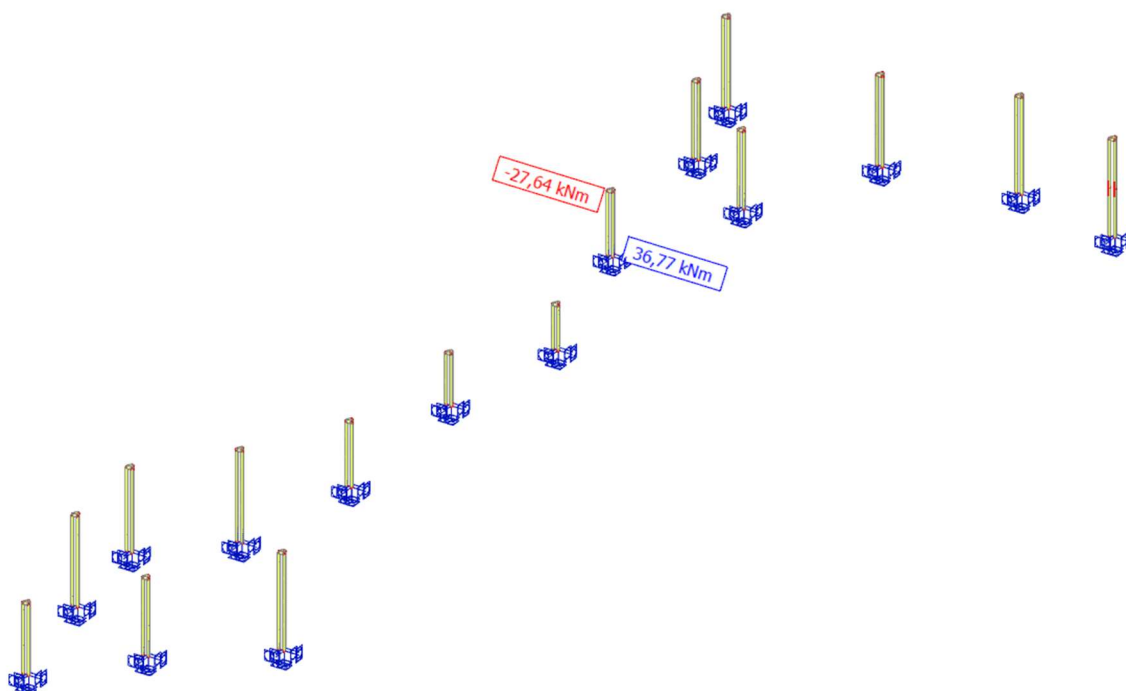

Slika 59: Moment savijanja M_z (kNm)- trostruki stup „S1“ od osi N13 do N27

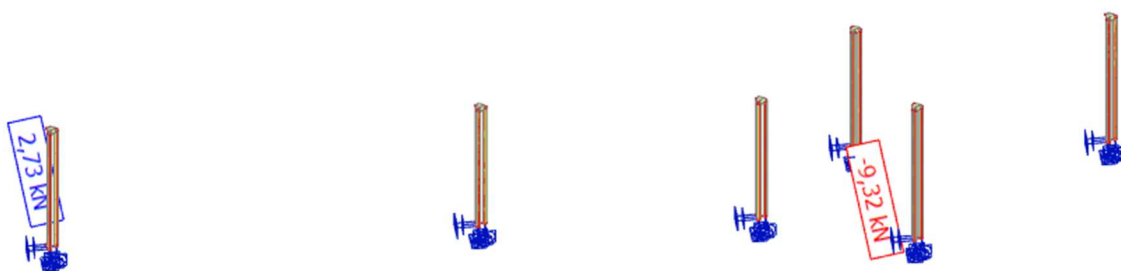

Slika 60: Poprečna sila V_Y (kN)- trostruki stup „S1“ od osi N1 do osi N7

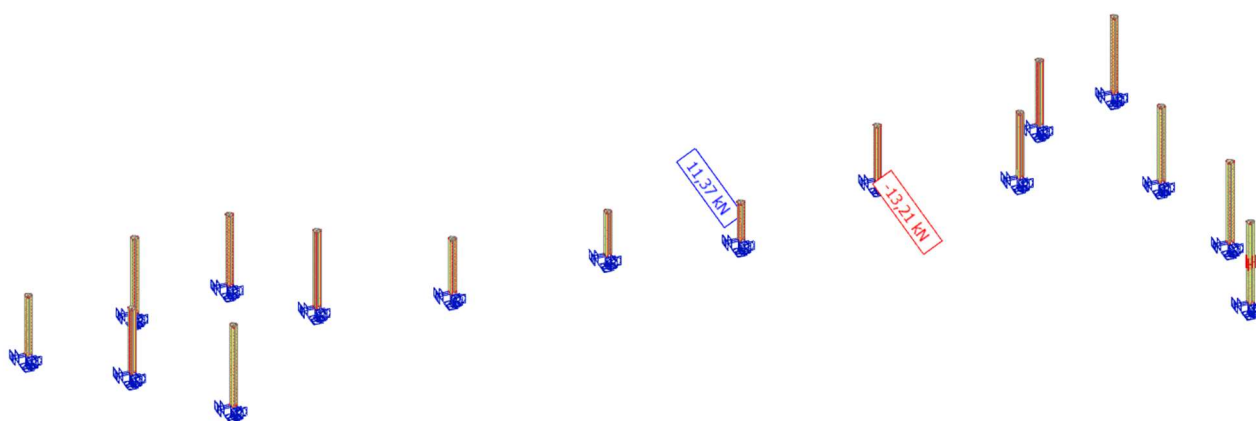

Slika 61: Poprečna sila V_Y (kN)- trostruki stup „S1“ od osi N13 do N27

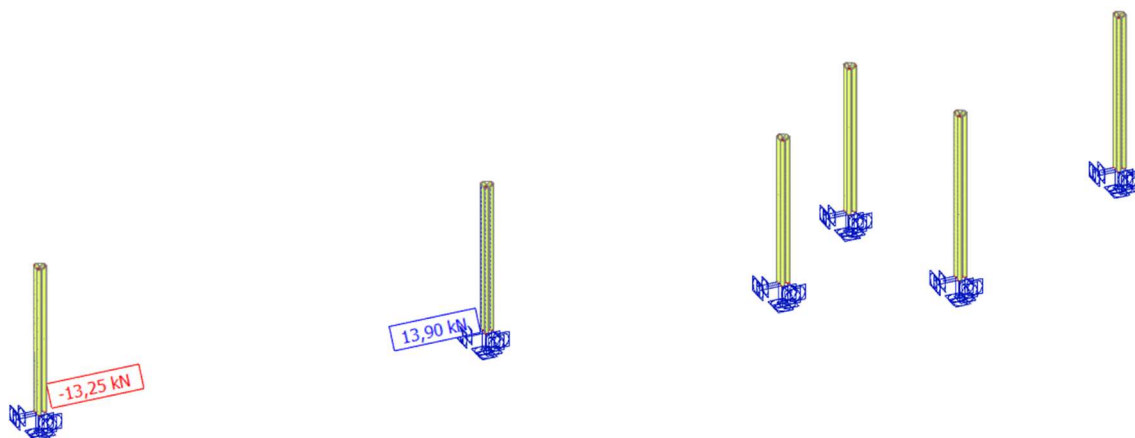

Slika 62: Poprečna sila V_z (kN)- trostruki stup „S1“ od osi N1 do osi N7

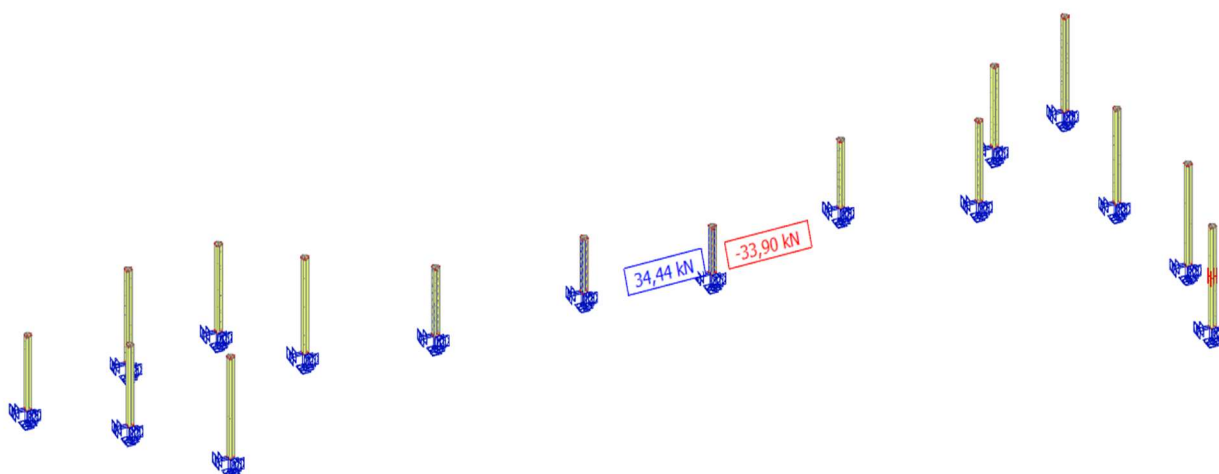

Slika 63: Poprečna sila V_z (kN)- trostruki stup „S1“ od osi N13 do N27

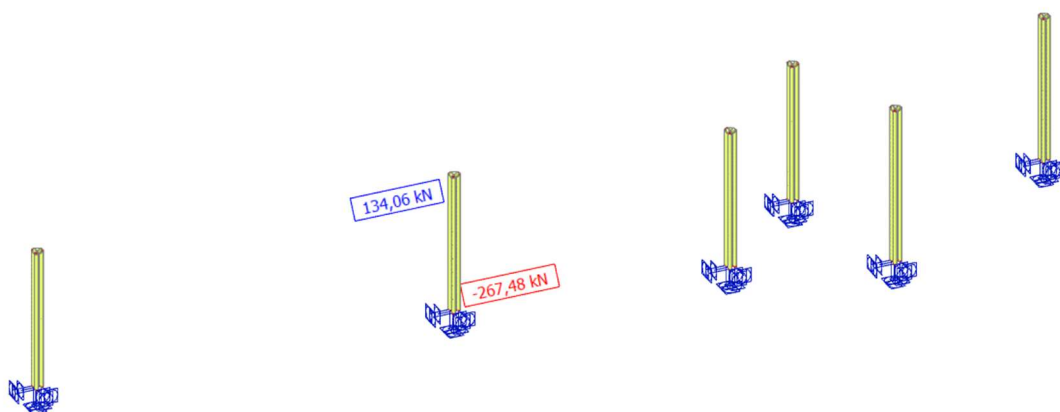

Slika 64: Uzdužna sila N (kN)- trostruki stup „SI“ od osi N1 do osi N7

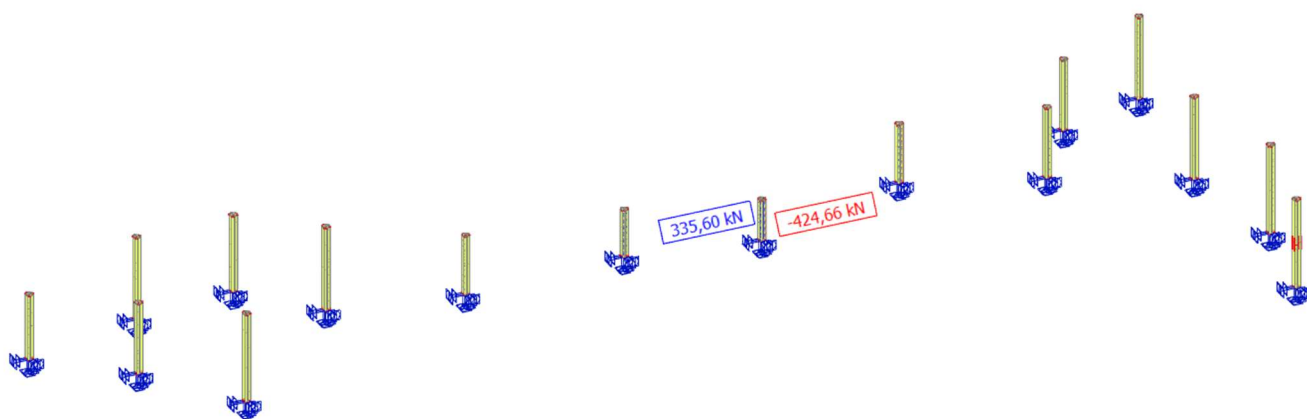

Slika 65: Uzdužna sila N (kN)- trostruki stup „SI“ od osi N13 do osi N27

4.2.2. Dimenzioniranje trostrukog stupa „S1“

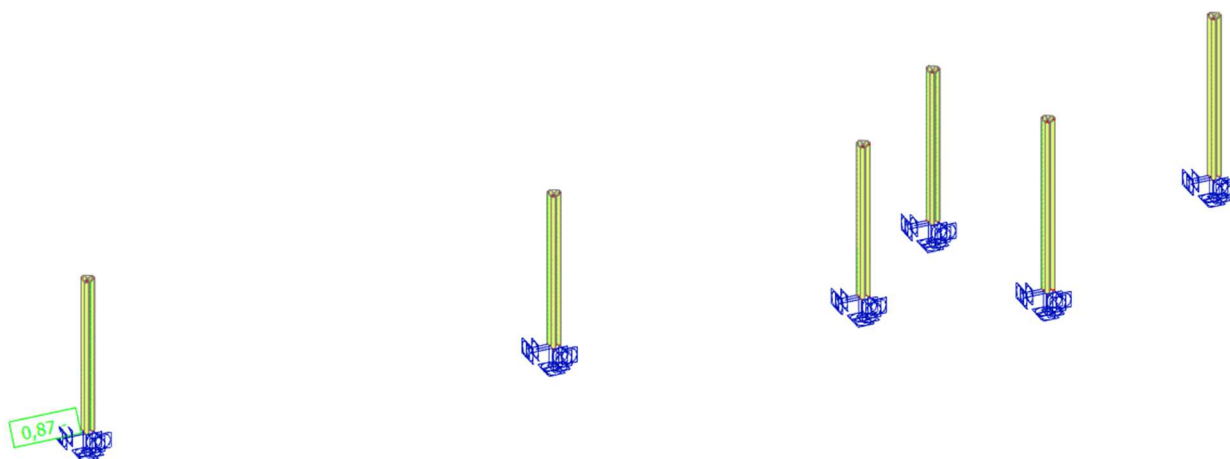

Slika 66: Prikaz iskoristivosti trostrukog stupa „S1“ od osi N1 do osi N7

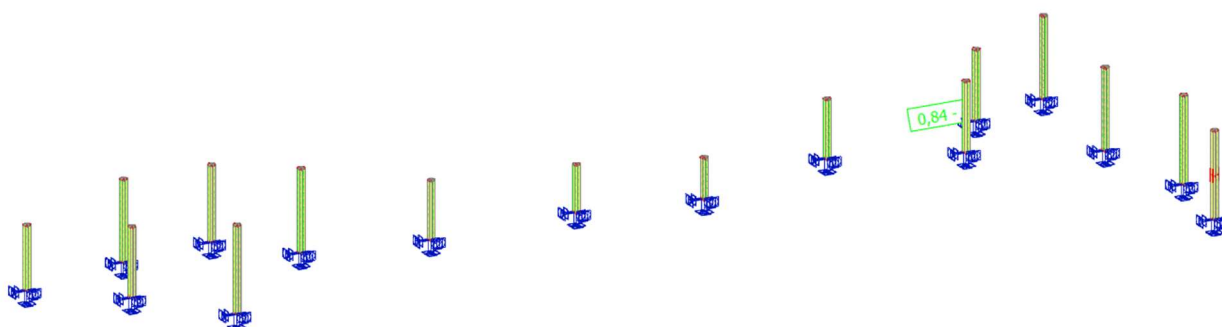

Slika 67: Prikaz iskoristivosti trostrukog stupa „S1“ od osi N13 do osi N27

EC-EN 1993 Steel check ULS

Linear calculation
 Combination: ULS-Set B (auto)
 Coordinate system: Principal
 Extreme 1D: Global
 Selection: All

EN 1993-1-1 Code Check

National annex: Standard EN

Member B5633	0,000 / 8,000 m	CFCHS219.1X12.5	Cold formed	S 355	ULS-Set B (auto)	0,87 -
---------------------	------------------------	------------------------	--------------------	--------------	-------------------------	---------------

Note: EN 1993-1-3 article 1.1(3) specifies that this part does not apply to cold formed CHS and RHS sections. The default EN 1993-1-1 code check is executed instead of the EN 1993-1-3 code check.

Combination key	
ULS-Set B (auto) / 1.35*G + 1.35*dg + 0.90*w1(x) + 1.50*T- + 0.90*w3(odizanje)	

Partial safety factors		
Resistance of cross-sections	γ_{M0}	1,00
Resistance to instability	γ_{M1}	1,10
Resistance of net sections	γ_{M2}	1,25

Material			
Yield strength	f_y	355,0	MPa
Ultimate strength	f_u	490,0	MPa

....:SECTION CHECK:....

The critical check is on position **0,000 m**

Internal forces		Calculated	Unit
Normal force	N_{Ed}	-133,06	kN
Shear force	$V_{y,Ed}$	-2,62	kN
Shear force	$V_{z,Ed}$	7,55	kN
Torsion	T_{Ed}	-0,27	kNm
Bending moment	$M_{y,Ed}$	-31,75	kNm
Bending moment	$M_{z,Ed}$	9,65	kNm

Classification for cross-section design

Classification according to EN 1993-1-1 article 5.5.2

Classification of Tubular sections according to EN 1993-1-1 Table 5.2 Sheet 3

d [mm]	t [mm]	d/t [-]	Class 1 Limit [-]	Class 2 Limit [-]	Class 3 Limit [-]	Class
219	13	17,5	33,1	46,3	59,6	1

The cross-section is classified as Class 1

Compression check

According to EN 1993-1-1 article 6.2.4 and formula (6.9)

Cross-section area	A	8,1130e-03	m ²
Compression resistance	$N_{c,Rd}$	2880,11	kN
Unity check		0,05	-

$$N_{c,Rd} = \frac{A \times f_y}{\gamma_{M0}} = \frac{8,1130 \cdot 10^{-3} [m^2] \times 355,0 [MPa]}{1,00} = 2880,11 [kN]$$

$$\text{Unity check} = \frac{|N_{Ed}|}{N_{c,Rd}} = \frac{|-133,06 [kN]|}{2880,11 [kN]} = 0,05 \leq 1,00$$

Bending moment check for M_y

According to EN 1993-1-1 article 6.2.5 and formula (6.12),(6.13)

Plastic section modulus	$W_{pl,y}$	5,3420e-04	m ³
Plastic bending moment	$M_{pl,y,Rd}$	189,64	kNm
Unity check		0,17	-

$$M_{pl,y,Rd} = \frac{W_{pl,y} \times f_y}{\gamma_{M0}} = \frac{5,3420 \cdot 10^{-4} [m^3] \times 355,0 [MPa]}{1,00} = 189,64 [kNm]$$

$$\text{Unity check} = \frac{|M_{y,Ed}|}{M_{pl,y,Rd}} = \frac{|-31,75 [kNm]|}{189,64 [kNm]} = 0,17 \leq 1,00$$

Bending moment check for M_z

According to EN 1993-1-1 article 6.2.5 and formula (6.12),(6.13)

Plastic section modulus	$W_{pl,z}$	5,3420e-04	m ³
Plastic bending moment	$M_{pl,z,Rd}$	189,64	kNm
Unity check		0,05	-

$$M_{pl,z,Rd} = \frac{W_{pl,z} \times f_y}{\gamma_{M0}} = \frac{5,3420 \cdot 10^{-4} [m^3] \times 355,0 [MPa]}{1,00} = 189,64 [kNm]$$

$$\text{Unity check} = \frac{|M_{z,Ed}|}{M_{pl,z,Rd}} = \frac{|9,65 [kNm]|}{189,64 [kNm]} = 0,05 \leq 1,00$$

Shear check for V_y

According to EN 1993-1-1 article 6.2.6 and formula (6.17)

Shear correction factor	η	1,20	
Shear area	A_v	5,1649e-03	m ²
Plastic shear resistance for V_y	$V_{pl,y,Rd}$	1058,59	kN
Unity check		0,00	-

$$V_{pl,y,Rd} = \frac{A_v \times \frac{f_y}{\sqrt{3}}}{\gamma_{M0}} = \frac{5,1649 \cdot 10^{-3} [m^2] \times \frac{355,0 [MPa]}{\sqrt{3}}}{1,00} = 1058,59 [kN]$$

$$\text{Unity check} = \frac{|V_{y,Ed}|}{V_{c,y,Rd}} = \frac{|-2,62 [kN]|}{1058,59 [kN]} = 0,00 \leq 1,00$$

Shear check for V_z

According to EN 1993-1-1 article 6.2.6 and formula (6.17)

Shear correction factor	η	1,20	
Shear area	A_v	5,1649e-03	m ²
Plastic shear resistance for V_z	$V_{pl,z,Rd}$	1058,59	kN
Unity check		0,01	-

$$V_{pl,z,Rd} = \frac{A_v \times \frac{f_y}{\sqrt{3}}}{\gamma_{M0}} = \frac{5,1649 \cdot 10^{-3} [m^2] \times \frac{355,0 [MPa]}{\sqrt{3}}}{1,00} = 1058,59 [kN]$$

$$\text{Unity check} = \frac{|V_{z,Ed}|}{V_{c,z,Rd}} = \frac{|7,55 [kN]|}{1058,59 [kN]} = 0,01 \leq 1,00$$

Torsion check

According to EN 1993-1-1 article 6.2.7 and formula (6.23)

Index of fibre	Fibre	1	
Total torsional moment	T_{Ed}	0,3	MPa
Elastic shear resistance	T_{Rd}	205,0	MPa
Unity check		0,00	-

$$\tau_{Ed} = \left| \frac{T_{Ed}}{T_{Ed,unit}} \times \tau_{Ed,unit} \right| = \left| \frac{-0,27[\text{kNm}]}{1,00[\text{kNm}]} \times 1193,190[\text{kN/m}^2] \right| = 0,3[\text{MPa}]$$

$$\tau_{Rd} = \frac{f_y}{\sqrt{3} \times \gamma_{M0}} = \frac{355,0[\text{MPa}]}{\sqrt{3} \times 1,00} = 205,0[\text{MPa}]$$

$$\text{Unity check} = \frac{\tau_{Ed}}{\tau_{Rd}} = \frac{0,3[\text{MPa}]}{205,0[\text{MPa}]} = \mathbf{0,00} \leq \mathbf{1,00}$$

Note: The unity check for torsion is lower than the limit value of 0,05. Therefore torsion is considered as insignificant and is ignored in the combined checks.

Combined bending, axial force and shear force check

According to EN 1993-1-1 article 6.2.9.1 and formula (6.31)

Resultant bending moment	$M_{resultant}$	33,18	kNm
Resultant shear force	$V_{resultant}$	7,99	kN
Design plastic moment resistance reduced due to N_{Ed}	$M_{N,Rd}$	188,62	kNm
Unity check		0,18	-

$$n = \frac{|N_{Ed}|}{N_{pl,Rd}} = \frac{|-133,06[\text{kN}]|}{2880,11[\text{kN}]} = 0,05$$

$$M_{N,Rd} = M_{pl,Rd} \times (1 - n^{1,7}) = 189,64[\text{kNm}] \times (1 - 0,05^{1,7}) = 188,62[\text{kNm}]$$

$$\text{Unity check} = \frac{|M_{resultant}|}{M_{N,Rd}} = \frac{|33,18[\text{kNm}]|}{188,62[\text{kNm}]} = \mathbf{0,18} \leq \mathbf{1,00}$$

Note: The resultant internal forces are used for CHS sections.

Note: Since the shear forces are less than half the plastic shear resistances their effect on the moment resistances is neglected.

The member satisfies the section check.

....:STABILITY CHECK:....

Classification for member buckling design

Decisive position for stability classification: 0,000 m

Decisive utilisation factor η : 0,19

Classification according to EN 1993-1-1 article 5.5.2

Classification of Tubular sections according to EN 1993-1-1 Table 5.2 Sheet 3

d [mm]	t [mm]	d/t [-]	Class 1 Limit [-]	Class 2 Limit [-]	Class 3 Limit [-]	Class
219	13	17,5	33,1	46,3	59,6	1

The cross-section is classified as Class 1

Note: The decisive position for the stability classification is based on the utilisation factor η according to Semi-Comp+.

Flexural Buckling check

According to EN 1993-1-1 article 6.3.1.1 and formula (6.46)

Buckling parameters		yy	zz	
Sway type		sway	sway	
System length	L	8,000	8,000	m
Buckling factor	k	2,00	2,00	
Buckling length	l_{cr}	16,000	16,000	m
Critical Euler load	N_{cr}	351,74	351,74	kN
Slenderness	λ	218,64	218,64	
Relative slenderness	λ_{rel}	2,86	2,86	
Limit slenderness	$\lambda_{rel,0}$	0,20	0,20	

Buckling parameters		yy	zz	
Buckling curve		c	c	
Imperfection	α	0,49	0,49	
Reduction factor	χ	0,10	0,10	
Buckling resistance	$N_{b,Rd}$	271,52	271,52	kN

Flexural Buckling verification			
Cross-section area	A	8,1130e-03	m ²
Buckling resistance	$N_{b,Rd}$	271,52	kN
Unity check		0,49	-

$$N_{cr,y} = \frac{\pi^2 \times E \times I_y}{l_{cr,y}^2} = \frac{\pi^2 \times 210000,0[\text{MPa}] \times 4,3446 \cdot 10^{-5}[\text{m}^4]}{16,000[\text{m}]^2} = 351,74[\text{kN}]$$

$$N_{cr,z} = \frac{\pi^2 \times E \times I_z}{l_{cr,z}^2} = \frac{\pi^2 \times 210000,0[\text{MPa}] \times 4,3446 \cdot 10^{-5}[\text{m}^4]}{16,000[\text{m}]^2} = 351,74[\text{kN}]$$

$$\lambda_y = \frac{l_{cr,y}}{i_y} = \frac{16,000[\text{m}]}{73[\text{mm}]} = 218,64$$

$$\lambda_z = \frac{l_{cr,z}}{i_z} = \frac{16,000[\text{m}]}{73[\text{mm}]} = 218,64$$

$$\lambda_{rel,y} = \frac{\lambda_y}{\pi \times \sqrt{\frac{E}{f_y}}} = \frac{218,64}{\pi \times \sqrt{\frac{210000,0[\text{MPa}]}{355,0[\text{MPa}]}}} = 2,86$$

$$\lambda_{rel,z} = \frac{\lambda_z}{\pi \times \sqrt{\frac{E}{f_y}}} = \frac{218,64}{\pi \times \sqrt{\frac{210000,0[\text{MPa}]}{355,0[\text{MPa}]}}} = 2,86$$

$$\varphi_y = 0,5 \times [1 + \alpha_y \times (\lambda_{rel,y} - \lambda_{rel,y,0}) + \lambda_{rel,y}^2] = 0,5 \times [1 + 0,49 \times (2,86 - 0,20) + 2,86^2] = 5,25$$

$$\varphi_z = 0,5 \times [1 + \alpha_z \times (\lambda_{rel,z} - \lambda_{rel,z,0}) + \lambda_{rel,z}^2] = 0,5 \times [1 + 0,49 \times (2,86 - 0,20) + 2,86^2] = 5,25$$

$$\chi_y = \min\left(\frac{1}{\varphi_y + \sqrt{\varphi_y^2 - \lambda_{rel,y}^2}}, 1\right) = \min\left(\frac{1}{5,25 + \sqrt{5,25^2 - 2,86^2}}, 1\right) = \min(0,10,1) = 0,10$$

$$\chi_z = \min\left(\frac{1}{\varphi_z + \sqrt{\varphi_z^2 - \lambda_{rel,z}^2}}, 1\right) = \min\left(\frac{1}{5,25 + \sqrt{5,25^2 - 2,86^2}}, 1\right) = \min(0,10,1) = 0,10$$

$$N_{b,y,Rd} = \frac{\chi_y \times A \times f_y}{\gamma_{M1}} = \frac{0,10 \times 8,1130 \cdot 10^{-3}[\text{m}^2] \times 355,0[\text{MPa}]}{1,10} = 271,52[\text{kN}]$$

$$N_{b,z,Rd} = \frac{\chi_z \times A \times f_y}{\gamma_{M1}} = \frac{0,10 \times 8,1130 \cdot 10^{-3}[\text{m}^2] \times 355,0[\text{MPa}]}{1,10} = 271,52[\text{kN}]$$

$$N_{b,Rd} = \min(N_{b,y,Rd}, N_{b,z,Rd}) = \min(271,52[\text{kN}], 271,52[\text{kN}]) = 271,52[\text{kN}]$$

$$\text{Unity check} = \frac{|N_{Ed}|}{N_{b,Rd}} = \frac{|-133,06[\text{kN}]|}{271,52[\text{kN}]} = 0,49 \leq 1,00$$

Torsional(-Flexural) Buckling check

According to EN 1993-1-1 article 6.3.1.1 and formula (6.46)

Note: The cross-section concerns a CHS section which is not susceptible to Torsional(-Flexural) Buckling.

Lateral Torsional Buckling check

According to EN 1993-1-1 article 6.3.2.1

Note: The cross-section concerns a CHS section which is not susceptible to Lateral Torsional Buckling.

Bending and axial compression check

According to EN 1993-1-1 article 6.3.3 and formula (6.61),(6.62)

Bending and axial compression check parameters			
Interaction method		alternative method 1	
Cross-section area	A	8,1130e-03	m ²
Plastic section modulus	W _{pl,y}	5,3420e-04	m ³
Plastic section modulus	W _{pl,z}	5,3420e-04	m ³
Design compression force	N _{Ed}	133,06	kN
Design bending moment (maximum)	M _{y,Ed}	-31,75	kNm
Design bending moment (maximum)	M _{z,Ed}	-11,31	kNm
Characteristic compression resistance	N _{Rk}	2880,11	kN
Characteristic moment resistance	M _{y,Rk}	189,64	kNm
Characteristic moment resistance	M _{z,Rk}	189,64	kNm
Reduction factor	χ _y	0,10	
Reduction factor	χ _z	0,10	
Reduction factor	χ _{LT}	1,00	
Interaction factor	k _{yy}	1,87	
Interaction factor	k _{yz}	0,30	
Interaction factor	k _{zy}	1,87	
Interaction factor	k _{zz}	0,47	

Maximum moment M_{y,Ed} is derived from beam B5633 position 0,000 m.

Maximum moment M_{z,Ed} is derived from beam B5633 position 8,000 m.

Interaction method 1 parameters			
Critical Euler load	N _{cr,y}	351,74	kN
Critical Euler load	N _{cr,z}	351,74	kN
Elastic critical load	N _{cr,T}	655280,77	kN
Plastic section modulus	W _{pl,y}	5,3420e-04	m ³
Elastic section modulus	W _{el,y}	3,9658e-04	m ³
Plastic section modulus	W _{pl,z}	5,3420e-04	m ³
Elastic section modulus	W _{el,z}	3,9658e-04	m ³
Second moment of area	I _y	4,3446e-05	m ⁴
Second moment of area	I _z	4,3446e-05	m ⁴
Torsional constant	I _t	8,6892e-05	m ⁴
Method for equivalent moment factor C _{my,0}		Table A.2 Line 2 (General)	
Design bending moment (maximum)	M _{y,Ed}	-31,75	kNm
Maximum relative deflection	δ _z	-42,6	mm
Equivalent moment factor	C _{my,0}	1,34	
Method for equivalent moment factor C _{mz,0}		Table A.2 Line 1 (Linear)	
Ratio of end moments	ψ _z	-0,85	
Equivalent moment factor	C _{mz,0}	0,45	
Factor	μ _y	0,65	
Factor	μ _z	0,65	
Factor	ε _y	4,88	
Factor	a _{LT}	0,00	
Critical moment for uniform bending	M _{cr,0}	3142,36	kNm
Relative slenderness	λ _{rel,0}	0,25	
Limit relative slenderness	λ _{rel,0,lim}	0,29	
Equivalent moment factor	C _{my}	1,34	
Equivalent moment factor	C _{mz}	0,45	
Equivalent moment factor	C _{mLT}	1,00	
Factor	b _{LT}	0,00	
Factor	c _{LT}	0,00	
Factor	d _{LT}	0,00	
Factor	e _{LT}	0,00	
Factor	w _y	1,35	
Factor	w _z	1,35	

Interaction method 1 parameters		
Factor	n_{pl}	0,05
Maximum relative slenderness	$\lambda_{rel,max}$	2,86
Factor	C_{yy}	0,74
Factor	C_{yz}	0,94
Factor	C_{zy}	0,45
Factor	C_{zz}	0,99

$$\text{Unity check (6.61)} = 0,49 + 0,34 + 0,02 = 0,85 -$$

$$\text{Unity check (6.62)} = 0,49 + 0,34 + 0,03 = 0,87 -$$

$$N_{cr,y} = \frac{\pi^2 \times E \times I_y}{l_{cr,y}^2} = \frac{\pi^2 \times 210000,0[\text{MPa}] \times 4,3446 \cdot 10^{-5}[\text{m}^4]}{16,000[\text{m}]^2} = 351,74[\text{kN}]$$

$$N_{cr,z} = \frac{\pi^2 \times E \times I_z}{l_{cr,z}^2} = \frac{\pi^2 \times 210000,0[\text{MPa}] \times 4,3446 \cdot 10^{-5}[\text{m}^4]}{16,000[\text{m}]^2} = 351,74[\text{kN}]$$

$$N_{cr,T} = \frac{1}{i_0^2} \times \left(G \times I_t + \frac{\pi^2 \times E \times I_w}{l_{cr}^2} \right) = \frac{1}{103[\text{mm}]^2} \times \left(80769,2[\text{MPa}] \times 8,6892 \cdot 10^{-5}[\text{m}^4] + \frac{\pi^2 \times 210000,0[\text{MPa}] \times 8,8785 \cdot 10^{-40}[\text{m}^6]}{8,000[\text{m}]^2} \right) = 655280,77[\text{kN}]$$

$$C_{m,y,0} = 1 + \left(\frac{\pi^2 \times E \times I_y \times |\delta_z|}{L^2 \times |M_{y,Ed}|} - 1 \right) \times \frac{|N_{Ed}|}{N_{cr,y}} = 1 + \left(\frac{\pi^2 \times 210000,0[\text{MPa}] \times 4,3446 \cdot 10^{-5}[\text{m}^4] \times |-42,6[\text{mm}]|}{8,000[\text{m}]^2 \times |-31,75[\text{kNm}]|} - 1 \right) \times \frac{|133,06[\text{kN}]|}{351,74[\text{kN}]} = 1,34$$

$$C_{m,z,0} = 0,79 + 0,21 \times \psi_z + \frac{0,36 \times (\psi_z - 0,33) \times |N_{Ed}|}{N_{cr,z}} = 0,79 + 0,21 \times -0,85 + \frac{0,36 \times (-0,85 - 0,33) \times |133,06[\text{kN}]|}{351,74[\text{kN}]} = 0,45$$

$$\mu_y = \frac{1 - \frac{|N_{Ed}|}{N_{cr,y}}}{1 - \frac{\chi_y \times |N_{Ed}|}{N_{cr,y}}} = \frac{1 - \frac{|133,06[\text{kN}]|}{351,74[\text{kN}]}}{1 - \frac{0,10 \times |133,06[\text{kN}]|}{351,74[\text{kN}]}} = 0,65$$

$$\mu_z = \frac{1 - \frac{|N_{Ed}|}{N_{cr,z}}}{1 - \frac{\chi_z \times |N_{Ed}|}{N_{cr,z}}} = \frac{1 - \frac{|133,06[\text{kN}]|}{351,74[\text{kN}]}}{1 - \frac{0,10 \times |133,06[\text{kN}]|}{351,74[\text{kN}]}} = 0,65$$

$$\varepsilon_y = \left| \frac{M_{y,Ed}}{N_{Ed}} \right| \times \frac{A}{W_{el,y}} = \left| \frac{-31,75[\text{kNm}]}{133,06[\text{kN}]} \right| \times \frac{8,1130 \cdot 10^{-3}[\text{m}^2]}{3,9658 \cdot 10^{-4}[\text{m}^3]} = 4,88$$

$$a_{LT} = \max \left(1 - \frac{I_t}{I_y}, 0 \right) = \max \left(1 - \frac{8,6892 \cdot 10^{-5}[\text{m}^4]}{4,3446 \cdot 10^{-5}[\text{m}^4]}, 0 \right) = \max(-1,00, 0,00) = 0,00$$

$$M_{cr,0} = \frac{C_1 \times \pi^2 \times E \times I_z}{(k \times l_{LT})^2} \times \left[\sqrt{\frac{\left(\frac{k}{k_w} \right)^2 \times I_w}{I_z} + \frac{(k \times l_{LT})^2 \times G \times I_t}{\pi^2 \times E \times I_z} + (C_2 \times z_g - C_3 \times z_y)^2} - (C_2 \times z_g - C_3 \times z_y) \right]$$

$$= \frac{1,00 \times \pi^2 \times 210000,0[\text{MPa}] \times 4,3446 \cdot 10^{-5}[\text{m}^4]}{(1,00 \times 8,000[\text{m}])^2} \times \left[\sqrt{\frac{\left(\frac{1,00}{1,00} \right)^2 \times 8,8785 \cdot 10^{-40}[\text{m}^6]}{4,3446 \cdot 10^{-5}[\text{m}^4]} + \frac{(1,00 \times 8,000[\text{m}])^2 \times 80769,2[\text{MPa}] \times 8,6892 \cdot 10^{-5}[\text{m}^4]}{\pi^2 \times 210000,0[\text{MPa}] \times 4,3446 \cdot 10^{-5}[\text{m}^4]} + (0,02 \times 0[\text{mm}] - 1,00 \times 0[\text{mm}])^2} - (0,02 \times 0[\text{mm}] - 1,00 \times 0[\text{mm}])} \right]$$

$$= 3142,36[\text{kNm}]$$

$$\lambda_{rel,0} = \sqrt{\frac{W_{pl,y} \times f_y}{M_{cr,0}}} = \sqrt{\frac{5,3420 \cdot 10^{-4}[\text{m}^3] \times 355,0[\text{MPa}]}{3142,36[\text{kNm}]} = 0,25$$

$$\lambda_{rel,0,lim} = 0,2 \times \sqrt{C_1} \times \sqrt[4]{\left(1 - \frac{|N_{Ed}|}{N_{cr,z}} \right) \times \left(1 - \frac{|N_{Ed}|}{N_{cr,T}} \right)} = 0,2 \times \sqrt{2,65} \times \sqrt[4]{\left(1 - \frac{|133,06[\text{kN}]|}{351,74[\text{kN}]} \right) \times \left(1 - \frac{|133,06[\text{kN}]|}{655280,77[\text{kN}]} \right)} = 0,29$$

$$C_{my} = C_{my,0} = 1,34$$

$$C_{mz} = C_{mz,0} = 0,45$$

$$C_{mLT} = 1,00$$

$$b_{LT} = 0,5 \times a_{LT} \times \lambda_{rel,0}^2 \times \frac{|M_{y,Ed}|}{\chi_{LT} \times M_{pl,y,Rd}} \times \frac{|M_{z,Ed}|}{M_{pl,z,Rd}} = 0,5 \times 0,00 \times 0,25^2 \times \frac{|-31,75[\text{kNm}]|}{1,00 \times 189,64[\text{kNm}]} \times \frac{|-11,31[\text{kNm}]|}{189,64[\text{kNm}]} = 0,00$$

$$c_{LT} = 10 \times a_{LT} \times \frac{\lambda_{rel,0}^2}{5 + \lambda_{rel,z}^4} \times \frac{|M_{y,Ed}|}{C_{my} \times \chi_{LT} \times M_{pl,y,Rd}} = 10 \times 0,00 \times \frac{0,25^2}{5 + 2,86^4} \times \frac{|-31,75[\text{kNm}]|}{1,34 \times 1,00 \times 189,64[\text{kNm}]} = 0,00$$

$$d_{LT} = 2 \times a_{LT} \times \frac{\lambda_{rel,0}}{0,1 + \lambda_{rel,z}^4} \times \frac{|M_{y,Ed}|}{C_{my} \times \chi_{LT} \times M_{pl,y,Rd}} \times \frac{|M_{z,Ed}|}{C_{mz} \times M_{pl,z,Rd}}$$

$$= 2 \times 0,00 \times \frac{0,25}{0,1 + 2,86^4} \times \frac{|-31,75[\text{kNm}]|}{1,34 \times 1,00 \times 189,64[\text{kNm}]} \times \frac{|-11,31[\text{kNm}]|}{0,45 \times 189,64[\text{kNm}]} = 0,00$$

$$e_{LT} = 1,7 \times a_{LT} \times \frac{\lambda_{rel,0}}{0,1 + \lambda_{rel,z}^4} \times \frac{|M_{y,Ed}|}{C_{my} \times \chi_{LT} \times M_{pl,y,Rd}} = 1,7 \times 0,00 \times \frac{0,25}{0,1 + 2,86^4} \times \frac{|-31,75[\text{kNm}]|}{1,34 \times 1,00 \times 189,64[\text{kNm}]} = 0,00$$

$$w_y = \min \left(\frac{W_{pl,y}}{W_{el,y}}, 1,5 \right) = \min \left(\frac{5,3420 \cdot 10^{-4}[\text{m}^3]}{3,9658 \cdot 10^{-4}[\text{m}^3]}, 1,5 \right) = \min(1,35, 1,50) = 1,35$$

$$w_z = \min \left(\frac{W_{pl,z}}{W_{el,z}}, 1,5 \right) = \min \left(\frac{5,3420 \cdot 10^{-4}[\text{m}^3]}{3,9658 \cdot 10^{-4}[\text{m}^3]}, 1,5 \right) = \min(1,35, 1,50) = 1,35$$

$$n_{pl} = \frac{|N_{Ed}|}{\gamma_{M1} N_{Rk}} = \frac{|133,06[\text{kN}]|}{1,10 \cdot 2880,11[\text{kN}]} = 0,05$$

$$\lambda_{rel,max} = \max(\lambda_{rel,y}, \lambda_{rel,z}) = \max(2,86, 2,86) = 2,86$$

$$C_{yy} = \max \left\{ 1 + (w_y - 1) \times \left[\left(2 - \frac{1,6}{w_y} \times C_{my}^2 \times \lambda_{rel,max} - \frac{1,6}{w_y} \times C_{my}^2 \times \lambda_{rel,max}^2 \right) \times n_{pl} - b_{LT} \right], \frac{W_{el,y}}{W_{pl,y}} \right\}$$

$$= \max \left\{ 1 + (1,35 - 1) \times \left[\left(2 - \frac{1,6}{1,35} \times 1,34^2 \times 2,86 - \frac{1,6}{1,35} \times 1,34^2 \times 2,86^2 \right) \times 0,05 - 0,00 \right], \frac{3,9658 \cdot 10^{-4}[\text{m}^3]}{5,3420 \cdot 10^{-4}[\text{m}^3]} \right\} = \max\{0,62, 0,74\}$$

$$= 0,74$$

$$C_{yz} = \max \left\{ 1 + (w_z - 1) \times \left[\left(2 - 14 \times \frac{C_{mz}^2 \times \lambda_{rel,max}^2}{w_z^5} \right) \times n_{pl} - c_{LT} \right], 0,6 \times \sqrt{\frac{w_z}{w_y}} \times \frac{W_{el,z}}{W_{pl,z}} \right\}$$

$$= \max \left\{ 1 + (1,35 - 1) \times \left[\left(2 - 14 \times \frac{0,45^2 \times 2,86^2}{1,35^5} \right) \times 0,05 - 0,00 \right], 0,6 \times \sqrt{\frac{1,35}{1,35}} \times \frac{3,9658 \cdot 10^{-4}[\text{m}^3]}{5,3420 \cdot 10^{-4}[\text{m}^3]} \right\} = \max\{0,94, 0,45\} = 0,94$$

$$C_{zy} = \max \left\{ 1 + (w_y - 1) \times \left[\left(2 - 14 \times \frac{C_{my}^2 \times \lambda_{rel,max}^2}{w_y^5} \right) \times n_{pl} - d_{LT} \right], 0,6 \times \sqrt{\frac{w_y}{w_z}} \times \frac{W_{el,y}}{W_{pl,y}} \right\}$$

$$= \max \left\{ 1 + (1,35 - 1) \times \left[\left(2 - 14 \times \frac{1,34^2 \times 2,86^2}{1,35^5} \right) \times 0,05 - 0,00 \right], 0,6 \times \sqrt{\frac{1,35}{1,35}} \times \frac{3,9658 \cdot 10^{-4}[\text{m}^3]}{5,3420 \cdot 10^{-4}[\text{m}^3]} \right\} = \max\{0,22, 0,45\} = 0,45$$

$$C_{zz} = \max \left[1 + (w_z - 1) \times \left(2 - \frac{1,6}{w_z} \times C_{mz}^2 \times \lambda_{rel,max} - \frac{1,6}{w_z} \times C_{mz}^2 \times \lambda_{rel,max}^2 - e_{LT} \right) \times n_{pl}, \frac{W_{el,z}}{W_{pl,z}} \right]$$

$$= \max \left[1 + (1,35 - 1) \times \left(2 - \frac{1,6}{1,35} \times 0,45^2 \times 2,86 - \frac{1,6}{1,35} \times 0,45^2 \times 2,86^2 - 0,00 \right) \times 0,05, \frac{3,9658 \cdot 10^{-4}[\text{m}^3]}{5,3420 \cdot 10^{-4}[\text{m}^3]} \right] = \max[0,99, 0,74] = 0,99$$

$$N_{Rk} = A \times f_y = 8,1130 \cdot 10^{-3}[\text{m}^2] \times 355,0[\text{MPa}] = 2880,11[\text{kN}]$$

$$M_{y,Rk} = W_{pl,y} \times f_y = 5,3420 \cdot 10^{-4}[\text{m}^3] \times 355,0[\text{MPa}] = 189,64[\text{kNm}]$$

$$M_{z,Rk} = W_{pl,z} \times f_y = 5,3420 \cdot 10^{-4}[\text{m}^3] \times 355,0[\text{MPa}] = 189,64[\text{kNm}]$$

$$k_{yy} = C_{my} \times C_{mLT} \times \frac{\mu_y}{1 - \frac{|N_{Ed}|}{N_{cr,y}}} \times \frac{1}{C_{yy}} = 1,34 \times 1,00 \times \frac{0,65}{1 - \frac{|133,06[\text{kN}]|}{351,74[\text{kN}]}} \times \frac{1}{0,74} = 1,87$$

$$k_{yz} = C_{mz} \times \frac{\mu_y}{1 - \frac{|N_{Ed}|}{N_{cr,z}}} \times \frac{1}{C_{yz}} \times 0,6 \times \sqrt{\frac{w_z}{w_y}} = 0,45 \times \frac{0,65}{1 - \frac{|133,06[\text{kN}]|}{351,74[\text{kN}]}} \times \frac{1}{0,94} \times 0,6 \times \sqrt{\frac{1,35}{1,35}} = 0,30$$

$$k_{zy} = C_{my} \times C_{mLT} \times \frac{\mu_z}{1 - \frac{|N_{Ed}|}{N_{cr,y}}} \times \frac{1}{C_{zy}} \times 0,6 \times \sqrt{\frac{w_y}{w_z}} = 1,34 \times 1,00 \times \frac{0,65}{1 - \frac{|133,06[\text{kN}]|}{351,74[\text{kN}]}} \times \frac{1}{0,45} \times 0,6 \times \sqrt{\frac{1,35}{1,35}} = 1,87$$

$$k_{zz} = C_{mz} \times \frac{\mu_z}{1 - \frac{|N_{Ed}|}{N_{cr,z}}} \times \frac{1}{C_{zz}} = 0,45 \times \frac{0,65}{1 - \frac{|133,06[\text{kN}]|}{351,74[\text{kN}]}} \times \frac{1}{0,99} = 0,47$$

$$\begin{aligned} \text{Unity check (6.61)} &= \frac{|N_{Ed}|}{\chi_y \times \frac{N_{Rk}}{\gamma_{M1}}} + k_{yy} \times \frac{|M_{y,Ed}| + |\Delta M_{y,Ed}|}{\chi_{LT} \times \frac{M_{y,Rk}}{\gamma_{M1}}} + k_{yz} \times \frac{|M_{z,Ed}| + |\Delta M_{z,Ed}|}{\frac{M_{z,Rk}}{\gamma_{M1}}} \\ &= \frac{|133,06[\text{kN}]|}{0,10 \times \frac{2880,11[\text{kN}]}{1,10}} + 1,87 \times \frac{|-31,75[\text{kNm}]| + |0,00[\text{kNm}]|}{1,00 \times \frac{189,64[\text{kNm}]}{1,10}} + 0,30 \times \frac{|-11,31[\text{kNm}]| + |0,00[\text{kNm}]|}{\frac{189,64[\text{kNm}]}{1,10}} = \mathbf{0,85} \leq \mathbf{1,00} \end{aligned}$$

$$\begin{aligned} \text{Unity check (6.62)} &= \frac{|N_{Ed}|}{\chi_z \times \frac{N_{Rk}}{\gamma_{M1}}} + k_{zy} \times \frac{|M_{y,Ed}| + |\Delta M_{y,Ed}|}{\chi_{LT} \times \frac{M_{y,Rk}}{\gamma_{M1}}} + k_{zz} \times \frac{|M_{z,Ed}| + |\Delta M_{z,Ed}|}{\frac{M_{z,Rk}}{\gamma_{M1}}} \\ &= \frac{|133,06[\text{kN}]|}{0,10 \times \frac{2880,11[\text{kN}]}{1,10}} + 1,87 \times \frac{|-31,75[\text{kNm}]| + |0,00[\text{kNm}]|}{1,00 \times \frac{189,64[\text{kNm}]}{1,10}} + 0,47 \times \frac{|-11,31[\text{kNm}]| + |0,00[\text{kNm}]|}{\frac{189,64[\text{kNm}]}{1,10}} = \mathbf{0,87} \leq \mathbf{1,00} \end{aligned}$$

$$\text{Unity check} = \max(\text{Unity check (6.61)}, \text{Unity check (6.62)}) = \max(0,85, 0,87) = \mathbf{0,87} \leq \mathbf{1,00}$$

The member satisfies the stability check.

4.2.3. Granično stanje uporabljivosti

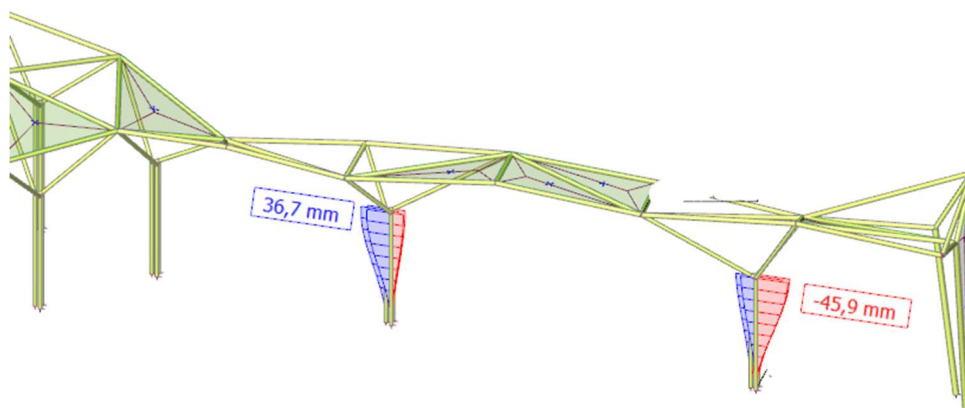

Slika 68: Prikaz pomaka trostrukih stupova „S1“ (mm)

	u_z
Maksimalni pomak $u =$	45,9 mm
Duljina nosača $L =$	8,00 m
Dopušteni pomak $f_{p,dop.} =$	53,3 mm ($L/200$)

$$f_{max.} = 45,9 \text{ mm} < f_{p,dop.} = 53,3 \text{ mm}$$

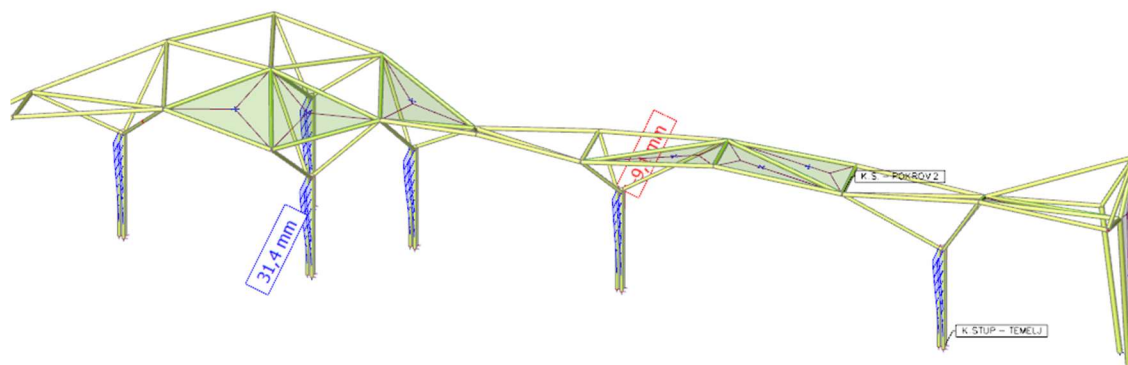

Slika 69: Prikaz pomaka trostrukih stupova „S1“ (mm)

	u_z
Maksimalni pomak $u =$	31,4 mm
Duljina nosača $L =$	8,00 m
Dopušteni pomak $f_{p,dop.} =$	53,3 mm ($L/200$)

$$f_{max.} = 31,4 \text{ mm} < f_{p,dop.} = 53,3 \text{ mm}$$

4.3. Kosi dio trostrukih stupova „SK“

4.3.1. Rezne sile kosog dijela stupa „S1“

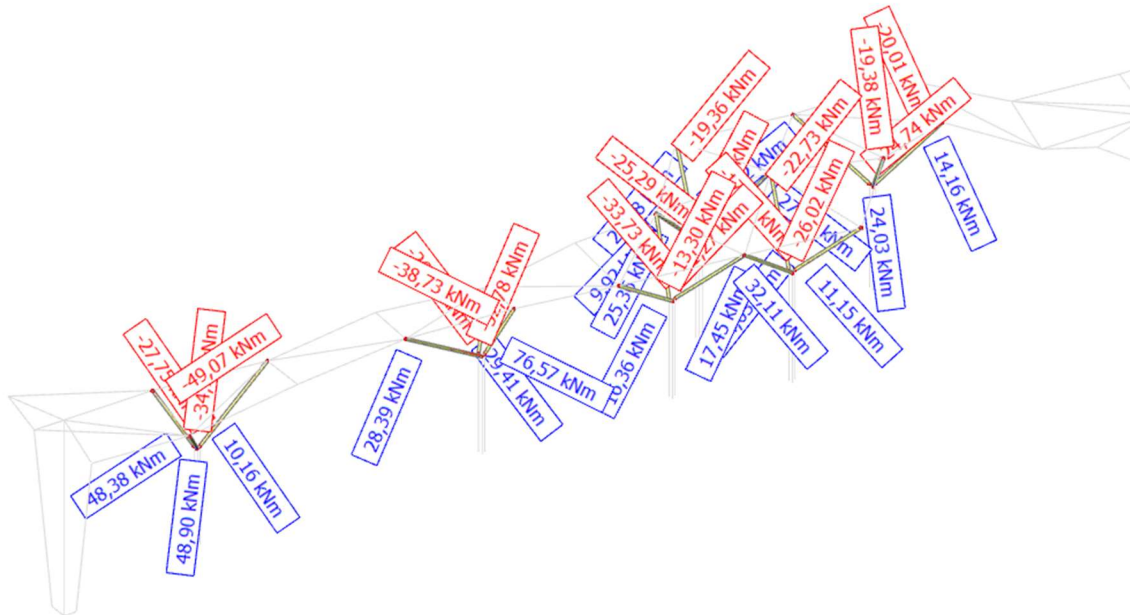

Slika 70: Moment savijanja M_y (kNm)- kosi dio trostrukog stupa „SK“ od osi N1 do N7

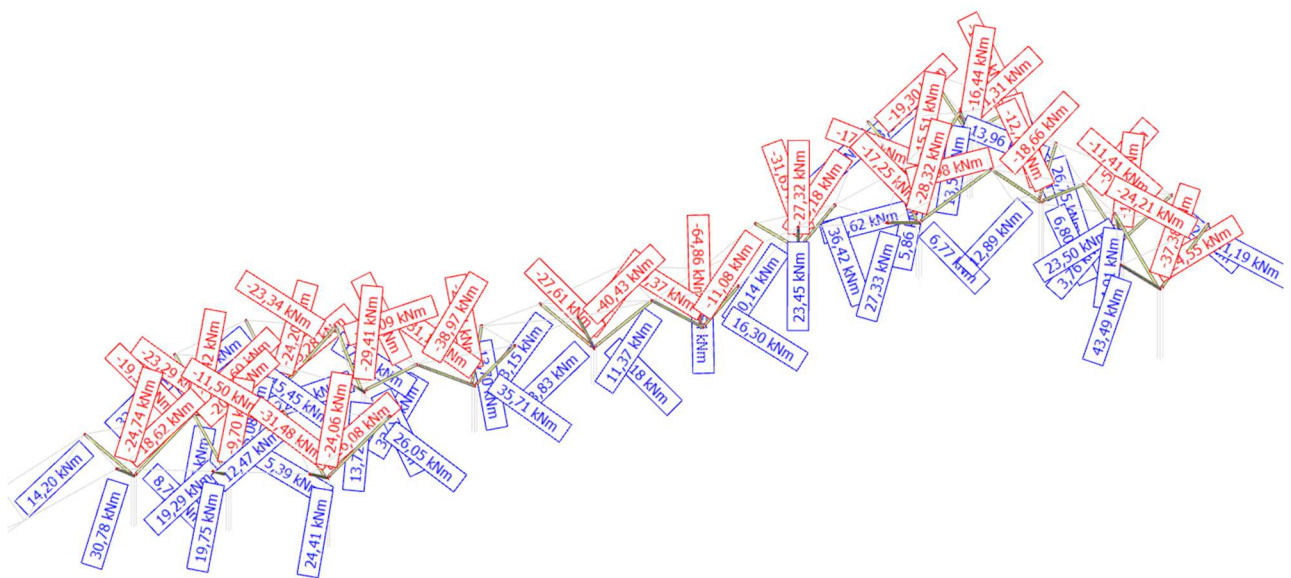

Slika 71: Moment savijanja M_y (kNm)- kosi dio trostrukog stupa „SK“ od osi N13 do N27

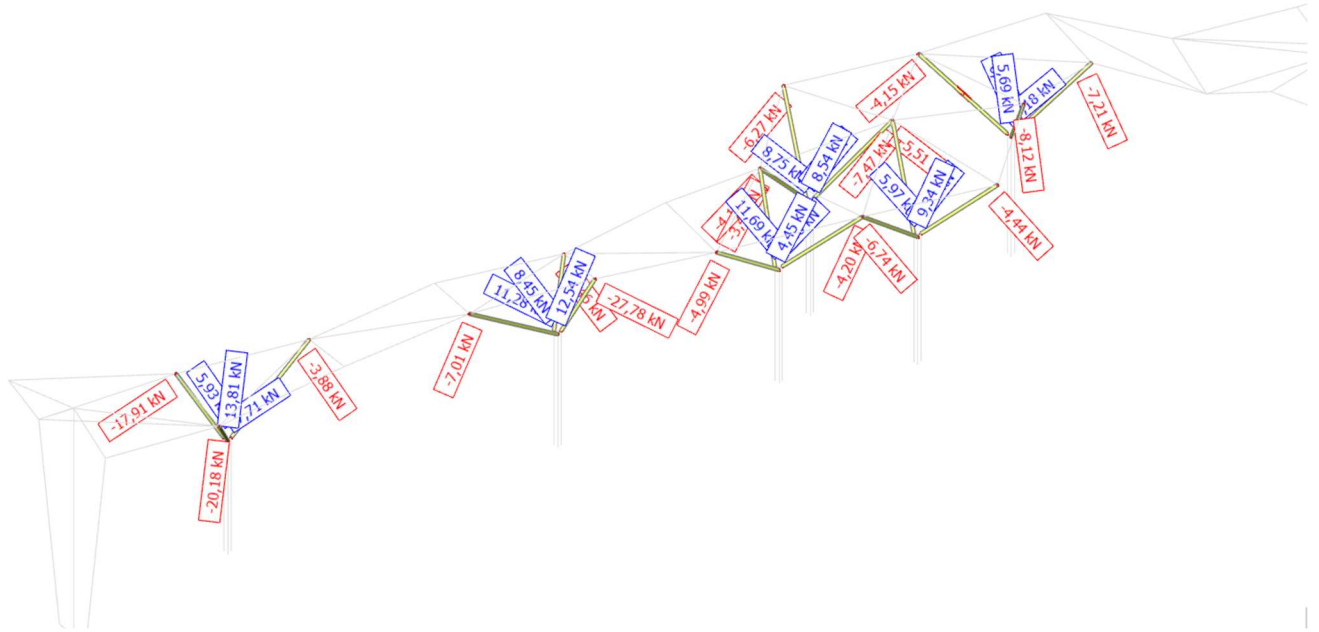

Slika 77: Poprečna sila V_z (kN)- kosi dio trostrukog stupa „SK“ od osi N1 do osi N7

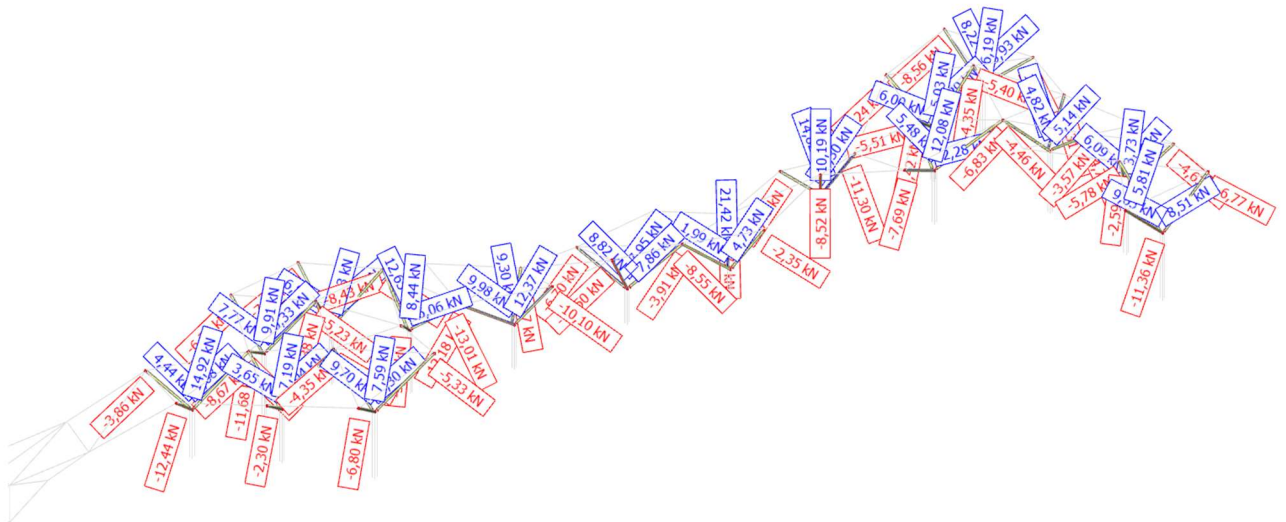

Slika 78: Poprečna sila V_z (kN)- kosi dio trostrukog stupa „SK“ od osi N13 do N27

4.3.2. Dimenzioniranje kosog dijela stupa „S1“

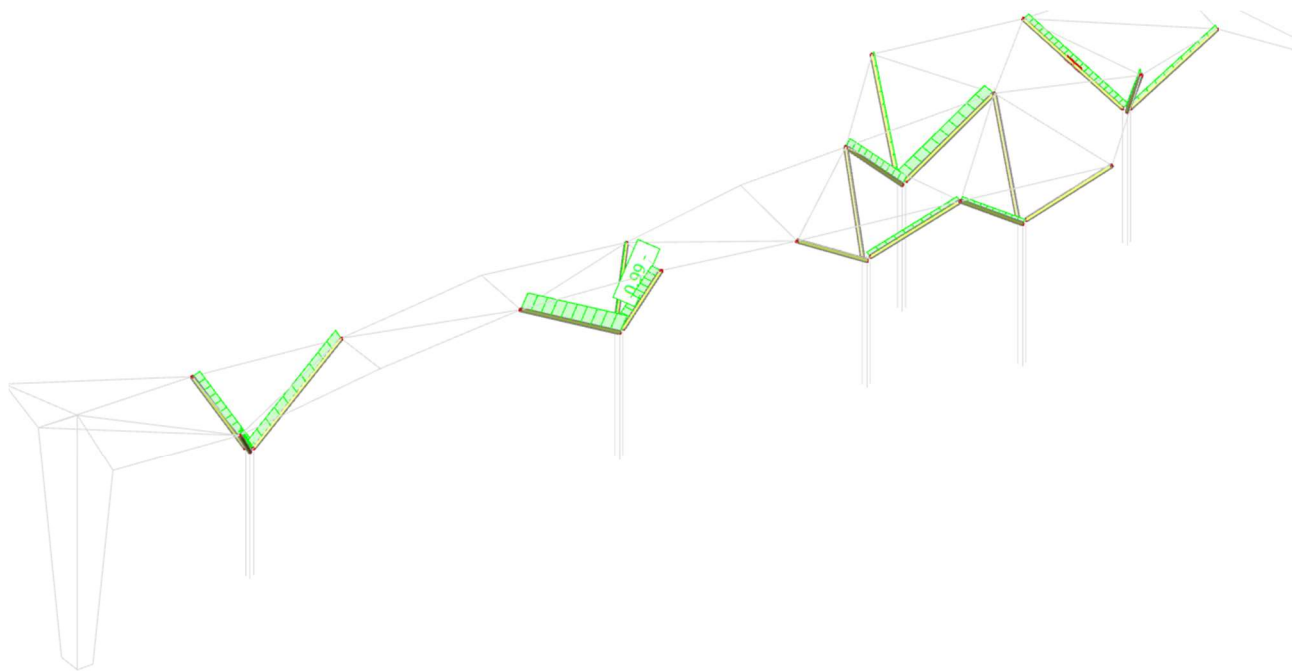

Slika 81: Prikaz iskoristivosti trostrukog stupa „S1“ od osi N1 do osi N7

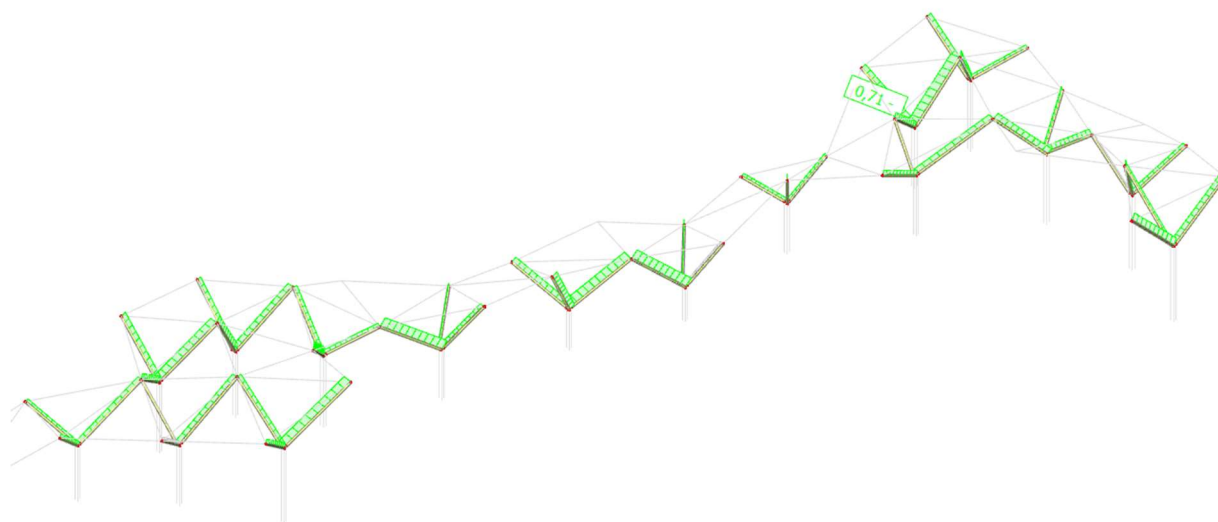

Slika 82: Prikaz iskoristivosti trostrukog stupa „S1“ od osi N13 do osi N27

EC-EN 1993 Steel check ULS

Linear calculation
 Combination: ULS-Set B (auto)
 Coordinate system: Principal
 Extreme 1D: Global
 Selection: All

EN 1993-1-1 Code Check

National annex: Standard EN

Member B5700	0,000 / 8,489 m	CFCHS219.1X12.5	Cold formed	S 355	ULS-Set B (auto)	0,99 -
---------------------	------------------------	------------------------	--------------------	--------------	-------------------------	---------------

Note: EN 1993-1-3 article 1.1(3) specifies that this part does not apply to cold formed CHS and RHS sections. The default EN 1993-1-1 code check is executed instead of the EN 1993-1-3 code check.

Combination key	
ULS-Set B (auto) / 1.35*G + 1.35*dg + 0.75*s + 0.90*w2(y) + 0.90*T- + 1.50*w3(pritisak)	

Partial safety factors		
Resistance of cross-sections	γ_{M0}	1,00
Resistance to instability	γ_{M1}	1,10
Resistance of net sections	γ_{M2}	1,25

Material			
Yield strength	f_y	355,0	MPa
Ultimate strength	f_u	490,0	MPa

....:SECTION CHECK:....

The critical check is on position **0,000 m**

Internal forces		Calculated	Unit
Normal force	N_{Ed}	-172,13	kN
Shear force	$V_{y,Ed}$	4,58	kN
Shear force	$V_{z,Ed}$	12,45	kN
Torsion	T_{Ed}	-3,94	kNm
Bending moment	$M_{y,Ed}$	-51,76	kNm
Bending moment	$M_{z,Ed}$	-26,69	kNm

Classification for cross-section design

Classification according to EN 1993-1-1 article 5.5.2
 Classification of Tubular sections according to EN 1993-1-1 Table 5.2 Sheet 3

d [mm]	t [mm]	d/t [-]	Class 1 Limit [-]	Class 2 Limit [-]	Class 3 Limit [-]	Class
219	13	17,5	33,1	46,3	59,6	1

The cross-section is classified as Class 1

Compression check

According to EN 1993-1-1 article 6.2.4 and formula (6.9)

Cross-section area	A	8,1130e-03	m ²
Compression resistance	$N_{c,Rd}$	2880,11	kN
Unity check		0,06	-

$$N_{c,Rd} = \frac{A \times f_y}{\gamma_{M0}} = \frac{8,1130 \cdot 10^{-3} [m^2] \times 355,0 [MPa]}{1,00} = 2880,11 [kN]$$

$$\text{Unity check} = \frac{|N_{Ed}|}{N_{c,Rd}} = \frac{|-172,13 [kN]|}{2880,11 [kN]} = 0,06 \leq 1,00$$

Bending moment check for M_y

According to EN 1993-1-1 article 6.2.5 and formula (6.12),(6.13)

Plastic section modulus	$W_{pl,y}$	5,3420e-04	m ³
Plastic bending moment	$M_{pl,y,Rd}$	189,64	kNm
Unity check		0,27	-

$$M_{pl,y,Rd} = \frac{W_{pl,y} \times f_y}{\gamma_{M0}} = \frac{5,3420 \cdot 10^{-4} [m^3] \times 355,0 [MPa]}{1,00} = 189,64 [kNm]$$

$$\text{Unity check} = \frac{|M_{y,Ed}|}{M_{pl,y,Rd}} = \frac{|-51,76 [kNm]|}{189,64 [kNm]} = 0,27 \leq 1,00$$

Bending moment check for M_z

According to EN 1993-1-1 article 6.2.5 and formula (6.12),(6.13)

Plastic section modulus	$W_{pl,z}$	5,3420e-04	m ³
Plastic bending moment	$M_{pl,z,Rd}$	189,64	kNm
Unity check		0,14	-

$$M_{pl,z,Rd} = \frac{W_{pl,z} \times f_y}{\gamma_{M0}} = \frac{5,3420 \cdot 10^{-4} [m^3] \times 355,0 [MPa]}{1,00} = 189,64 [kNm]$$

$$\text{Unity check} = \frac{|M_{z,Ed}|}{M_{pl,z,Rd}} = \frac{|-26,69 [kNm]|}{189,64 [kNm]} = 0,14 \leq 1,00$$

Shear check for V_y

According to EN 1993-1-1 article 6.2.6 and formula (6.17)

Shear correction factor	η	1,20	
Shear area	A_v	5,1649e-03	m ²
Plastic shear resistance for V_y	$V_{pl,y,Rd}$	1058,59	kN
Unity check		0,00	-

$$V_{pl,y,Rd} = \frac{A_v \times \frac{f_y}{\sqrt{3}}}{\gamma_{M0}} = \frac{5,1649 \cdot 10^{-3} [m^2] \times \frac{355,0 [MPa]}{\sqrt{3}}}{1,00} = 1058,59 [kN]$$

$$\text{Unity check} = \frac{|V_{y,Ed}|}{V_{c,y,Rd}} = \frac{|4,58 [kN]|}{1058,59 [kN]} = 0,00 \leq 1,00$$

Shear check for V_z

According to EN 1993-1-1 article 6.2.6 and formula (6.17)

Shear correction factor	η	1,20	
Shear area	A_v	5,1649e-03	m ²
Plastic shear resistance for V_z	$V_{pl,z,Rd}$	1058,59	kN
Unity check		0,01	-

$$V_{pl,z,Rd} = \frac{A_v \times \frac{f_y}{\sqrt{3}}}{\gamma_{M0}} = \frac{5,1649 \cdot 10^{-3} [m^2] \times \frac{355,0 [MPa]}{\sqrt{3}}}{1,00} = 1058,59 [kN]$$

$$\text{Unity check} = \frac{|V_{z,Ed}|}{V_{c,z,Rd}} = \frac{|12,45 [kN]|}{1058,59 [kN]} = 0,01 \leq 1,00$$

Torsion check

According to EN 1993-1-1 article 6.2.7 and formula (6.23)

Index of fibre	Fibre	1	
Total torsional moment	T_{Ed}	4,7	MPa
Elastic shear resistance	T_{Rd}	205,0	MPa
Unity check		0,02	-

$$\tau_{Ed} = \left| \frac{T_{Ed}}{T_{Ed,unit}} \times \tau_{Ed,unit} \right| = \left| \frac{-3,94[\text{kNm}]}{1,00[\text{kNm}]} \times 1193,190[\text{kN/m}^2] \right| = 4,7[\text{MPa}]$$

$$\tau_{Rd} = \frac{f_y}{\sqrt{3} \times \gamma_{M0}} = \frac{355,0[\text{MPa}]}{\sqrt{3} \times 1,00} = 205,0[\text{MPa}]$$

$$\text{Unity check} = \frac{\tau_{Ed}}{\tau_{Rd}} = \frac{4,7[\text{MPa}]}{205,0[\text{MPa}]} = \mathbf{0,02} \leq \mathbf{1,00}$$

Note: The unity check for torsion is lower than the limit value of 0,05. Therefore torsion is considered as insignificant and is ignored in the combined checks.

Combined bending, axial force and shear force check

According to EN 1993-1-1 article 6.2.9.1 and formula (6.31)

Resultant bending moment	$M_{resultant}$	58,23	kNm
Resultant shear force	$V_{resultant}$	13,26	kN
Design plastic moment resistance reduced due to N_{Ed}	$M_{N,Rd}$	188,06	kNm
Unity check		0,31	-

$$n = \frac{|N_{Ed}|}{N_{pl,Rd}} = \frac{|-172,13[\text{kN}]|}{2880,11[\text{kN}]} = 0,06$$

$$M_{N,Rd} = M_{pl,Rd} \times (1 - n^{1,7}) = 189,64[\text{kNm}] \times (1 - 0,06^{1,7}) = 188,06[\text{kNm}]$$

$$\text{Unity check} = \frac{|M_{resultant}|}{M_{N,Rd}} = \frac{|58,23[\text{kNm}]|}{188,06[\text{kNm}]} = \mathbf{0,31} \leq \mathbf{1,00}$$

Note: The resultant internal forces are used for CHS sections.

Note: Since the shear forces are less than half the plastic shear resistances their effect on the moment resistances is neglected.

The member satisfies the section check.

....:STABILITY CHECK:....

Classification for member buckling design

Decisive position for stability classification: 0,000 m

Decisive utilisation factor η : 0,33

Classification according to EN 1993-1-1 article 5.5.2

Classification of Tubular sections according to EN 1993-1-1 Table 5.2 Sheet 3

d [mm]	t [mm]	d/t [-]	Class 1 Limit [-]	Class 2 Limit [-]	Class 3 Limit [-]	Class
219	13	17,5	33,1	46,3	59,6	1

The cross-section is classified as Class 1

Note: The decisive position for the stability classification is based on the utilisation factor η according to Semi-Comp+.

Flexural Buckling check

According to EN 1993-1-1 article 6.3.1.1 and formula (6.46)

Buckling parameters		yy	zz	
Sway type		sway	non-sway	
System length	L	8,489	8,489	m
Buckling factor	k	2,00	2,00	
Buckling length	l_{cr}	16,979	16,979	m
Critical Euler load	N_{cr}	312,36	312,36	kN
Slenderness	λ	232,02	232,02	
Relative slenderness	λ_{rel}	3,04	3,04	
Limit slenderness	$\lambda_{rel,0}$	0,20	0,20	

Buckling parameters		yy	zz	
Buckling curve		c	c	
Imperfection	α	0,49	0,49	
Reduction factor	χ	0,09	0,09	
Buckling resistance	$N_{b,Rd}$	243,50	243,50	kN

Flexural Buckling verification			
Cross-section area	A	8,1130e-03	m ²
Buckling resistance	$N_{b,Rd}$	243,50	kN
Unity check		0,71	-

$$N_{cr,y} = \frac{\pi^2 \times E \times I_y}{l_{cr,y}^2} = \frac{\pi^2 \times 210000,0[\text{MPa}] \times 4,3446 \cdot 10^{-5}[\text{m}^4]}{16,979[\text{m}]^2} = 312,36[\text{kN}]$$

$$N_{cr,z} = \frac{\pi^2 \times E \times I_z}{l_{cr,z}^2} = \frac{\pi^2 \times 210000,0[\text{MPa}] \times 4,3446 \cdot 10^{-5}[\text{m}^4]}{16,979[\text{m}]^2} = 312,36[\text{kN}]$$

$$\lambda_y = \frac{l_{cr,y}}{i_y} = \frac{16,979[\text{m}]}{73[\text{mm}]} = 232,02$$

$$\lambda_z = \frac{l_{cr,z}}{i_z} = \frac{16,979[\text{m}]}{73[\text{mm}]} = 232,02$$

$$\lambda_{rel,y} = \frac{\lambda_y}{\pi \times \sqrt{\frac{E}{f_y}}} = \frac{232,02}{\pi \times \sqrt{\frac{210000,0[\text{MPa}]}{355,0[\text{MPa}]}}} = 3,04$$

$$\lambda_{rel,z} = \frac{\lambda_z}{\pi \times \sqrt{\frac{E}{f_y}}} = \frac{232,02}{\pi \times \sqrt{\frac{210000,0[\text{MPa}]}{355,0[\text{MPa}]}}} = 3,04$$

$$\varphi_y = 0,5 \times [1 + \alpha_y \times (\lambda_{rel,y} - \lambda_{rel,y,0}) + \lambda_{rel,y}^2] = 0,5 \times [1 + 0,49 \times (3,04 - 0,20) + 3,04^2] = 5,81$$

$$\varphi_z = 0,5 \times [1 + \alpha_z \times (\lambda_{rel,z} - \lambda_{rel,z,0}) + \lambda_{rel,z}^2] = 0,5 \times [1 + 0,49 \times (3,04 - 0,20) + 3,04^2] = 5,81$$

$$\chi_y = \min\left(\frac{1}{\varphi_y + \sqrt{\varphi_y^2 - \lambda_{rel,y}^2}}, 1\right) = \min\left(\frac{1}{5,81 + \sqrt{5,81^2 - 3,04^2}}, 1\right) = \min(0,09, 1) = 0,09$$

$$\chi_z = \min\left(\frac{1}{\varphi_z + \sqrt{\varphi_z^2 - \lambda_{rel,z}^2}}, 1\right) = \min\left(\frac{1}{5,81 + \sqrt{5,81^2 - 3,04^2}}, 1\right) = \min(0,09, 1) = 0,09$$

$$N_{b,y,Rd} = \frac{\chi_y \times A \times f_y}{\gamma_{M1}} = \frac{0,09 \times 8,1130 \cdot 10^{-3}[\text{m}^2] \times 355,0[\text{MPa}]}{1,10} = 243,50[\text{kN}]$$

$$N_{b,z,Rd} = \frac{\chi_z \times A \times f_y}{\gamma_{M1}} = \frac{0,09 \times 8,1130 \cdot 10^{-3}[\text{m}^2] \times 355,0[\text{MPa}]}{1,10} = 243,50[\text{kN}]$$

$$N_{b,Rd} = \min(N_{b,y,Rd}, N_{b,z,Rd}) = \min(243,50[\text{kN}], 243,50[\text{kN}]) = 243,50[\text{kN}]$$

$$\text{Unity check} = \frac{|N_{Ed}|}{N_{b,Rd}} = \frac{|-172,13[\text{kN}]|}{243,50[\text{kN}]} = 0,71 \leq 1,00$$

Torsional(-Flexural) Buckling check

According to EN 1993-1-1 article 6.3.1.1 and formula (6.46)

Note: The cross-section concerns a CHS section which is not susceptible to Torsional(-Flexural) Buckling.

Lateral Torsional Buckling check

According to EN 1993-1-1 article 6.3.2.1

Note: The cross-section concerns a CHS section which is not susceptible to Lateral Torsional Buckling.

Bending and axial compression check

According to EN 1993-1-1 article 6.3.3 and formula (6.61),(6.62)

Bending and axial compression check parameters			
Interaction method		alternative method 1	
Cross-section area	A	8,1130e-03	m ²
Plastic section modulus	W _{pl,y}	5,3420e-04	m ³
Plastic section modulus	W _{pl,z}	5,3420e-04	m ³
Design compression force	N _{Ed}	172,13	kN
Design bending moment (maximum)	M _{y,Ed}	-51,76	kNm
Design bending moment (maximum)	M _{z,Ed}	-26,69	kNm
Characteristic compression resistance	N _{Rk}	2880,11	kN
Characteristic moment resistance	M _{y,Rk}	189,64	kNm
Characteristic moment resistance	M _{z,Rk}	189,64	kNm
Reduction factor	χ _y	0,09	
Reduction factor	χ _z	0,09	
Reduction factor	χ _{LT}	1,00	
Interaction factor	k _{yy}	0,65	
Interaction factor	k _{yz}	0,58	
Interaction factor	k _{zy}	0,45	
Interaction factor	k _{zz}	0,80	

Maximum moment M_{y,Ed} is derived from beam B5700 position 0,000 m.

Maximum moment M_{z,Ed} is derived from beam B5700 position 0,000 m.

Interaction method 1 parameters			
Critical Euler load	N _{cr,y}	312,36	kN
Critical Euler load	N _{cr,z}	312,36	kN
Elastic critical load	N _{cr,T}	655280,77	kN
Plastic section modulus	W _{pl,y}	5,3420e-04	m ³
Elastic section modulus	W _{el,y}	3,9658e-04	m ³
Plastic section modulus	W _{pl,z}	5,3420e-04	m ³
Elastic section modulus	W _{el,z}	3,9658e-04	m ³
Second moment of area	I _y	4,3446e-05	m ⁴
Second moment of area	I _z	4,3446e-05	m ⁴
Torsional constant	I _t	8,6892e-05	m ⁴
Method for equivalent moment factor C _{my,0}		Table A.2 Line 2 (General)	
Design bending moment (maximum)	M _{y,Ed}	-51,76	kNm
Maximum relative deflection	δ _z	9,8	mm
Equivalent moment factor	C _{my,0}	0,58	
Method for equivalent moment factor C _{mz,0}		Table A.2 Line 2 (General)	
Design bending moment (maximum)	M _{z,Ed}	-26,69	kNm
Maximum relative deflection	δ _y	8,9	mm
Equivalent moment factor	C _{mz,0}	0,68	
Factor	μ _y	0,47	
Factor	μ _z	0,47	
Factor	ε _y	6,15	
Factor	a _{LT}	0,00	
Critical moment for uniform bending	M _{cr,0}	2961,22	kNm
Relative slenderness	λ _{rel,0}	0,25	
Limit relative slenderness	λ _{rel,0,lim}	0,27	
Equivalent moment factor	C _{my}	0,58	
Equivalent moment factor	C _{mz}	0,68	
Equivalent moment factor	C _{mLT}	1,00	
Factor	b _{LT}	0,00	
Factor	c _{LT}	0,00	
Factor	d _{LT}	0,00	
Factor	e _{LT}	0,00	

Interaction method 1 parameters			
Factor	W_y	1,35	
Factor	W_z	1,35	
Factor	n_{pl}	0,07	
Maximum relative slenderness	$\lambda_{rel,max}$	3,04	
Factor	C_{yy}	0,93	
Factor	C_{yz}	0,74	
Factor	C_{zy}	0,82	
Factor	C_{zz}	0,89	

Unity check (6.61) = 0,71 + 0,20 + 0,09 = 0,99 -

Unity check (6.62) = 0,71 + 0,13 + 0,12 = 0,96 -

$$N_{cr,y} = \frac{\pi^2 \times E \times I_y}{I_{cr,y}^2} = \frac{\pi^2 \times 210000,0[\text{MPa}] \times 4,3446 \cdot 10^{-5}[\text{m}^4]}{16,979[\text{m}]^2} = 312,36[\text{kN}]$$

$$N_{cr,z} = \frac{\pi^2 \times E \times I_z}{I_{cr,z}^2} = \frac{\pi^2 \times 210000,0[\text{MPa}] \times 4,3446 \cdot 10^{-5}[\text{m}^4]}{16,979[\text{m}]^2} = 312,36[\text{kN}]$$

$$N_{cr,T} = \frac{1}{i_0^2} \times \left(G \times I_t + \frac{\pi^2 \times E \times I_w}{I_{cr}^2} \right) = \frac{1}{103[\text{mm}]^2} \times \left(80769,2[\text{MPa}] \times 8,6892 \cdot 10^{-5}[\text{m}^4] + \frac{\pi^2 \times 210000,0[\text{MPa}] \times 8,8785 \cdot 10^{-40}[\text{m}^6]}{8,489[\text{m}]^2} \right) = 655280,77[\text{kN}]$$

$$C_{my,0} = 1 + \left(\frac{\pi^2 \times E \times I_y \times |\delta_z|}{L^2 \times |M_{y,Ed}|} - 1 \right) \times \frac{|N_{Ed}|}{N_{cr,y}} = 1 + \left(\frac{\pi^2 \times 210000,0[\text{MPa}] \times 4,3446 \cdot 10^{-5}[\text{m}^4] \times |9,8[\text{mm}]|}{8,489[\text{m}]^2 \times |-51,76[\text{kNm}]|} - 1 \right) \times \frac{|172,13[\text{kN}]|}{312,36[\text{kN}]} = 0,58$$

$$C_{mz,0} = 1 + \left(\frac{\pi^2 \times E \times I_z \times |\delta_y|}{L^2 \times |M_{z,Ed}|} - 1 \right) \times \frac{|N_{Ed}|}{N_{cr,z}} = 1 + \left(\frac{\pi^2 \times 210000,0[\text{MPa}] \times 4,3446 \cdot 10^{-5}[\text{m}^4] \times |8,9[\text{mm}]|}{8,489[\text{m}]^2 \times |-26,69[\text{kNm}]|} - 1 \right) \times \frac{|172,13[\text{kN}]|}{312,36[\text{kN}]} = 0,68$$

$$\mu_y = \frac{1 - \frac{|N_{Ed}|}{N_{cr,y}}}{1 - \frac{\chi_y \times |N_{Ed}|}{N_{cr,y}}} = \frac{1 - \frac{|172,13[\text{kN}]|}{312,36[\text{kN}]}}{1 - \frac{0,09 \times |172,13[\text{kN}]|}{312,36[\text{kN}]}} = 0,47$$

$$\mu_z = \frac{1 - \frac{|N_{Ed}|}{N_{cr,z}}}{1 - \frac{\chi_z \times |N_{Ed}|}{N_{cr,z}}} = \frac{1 - \frac{|172,13[\text{kN}]|}{312,36[\text{kN}]}}{1 - \frac{0,09 \times |172,13[\text{kN}]|}{312,36[\text{kN}]}} = 0,47$$

$$\epsilon_y = \left| \frac{M_{y,Ed}}{N_{Ed}} \right| \times \frac{A}{W_{el,y}} = \left| \frac{-51,76[\text{kNm}]}{172,13[\text{kN}]} \right| \times \frac{8,1130 \cdot 10^{-3}[\text{m}^2]}{3,9658 \cdot 10^{-4}[\text{m}^3]} = 6,15$$

$$a_{LT} = \max \left(1 - \frac{I_t}{I_y}, 0 \right) = \max \left(1 - \frac{8,6892 \cdot 10^{-5}[\text{m}^4]}{4,3446 \cdot 10^{-5}[\text{m}^4]}, 0 \right) = \max(-1,00, 0,00) = 0,00$$

$$M_{cr,0} = \frac{C_1 \times \pi^2 \times E \times I_z}{(k \times l_{LT})^2} \times \left[\sqrt{\frac{\left(\frac{k}{k_w} \right)^2 \times I_w}{I_z} + \frac{(k \times l_{LT})^2 \times G \times I_t}{\pi^2 \times E \times I_z} + (C_2 \times z_g - C_3 \times z_j)^2} - (C_2 \times z_g - C_3 \times z_j) \right]$$

$$= \frac{1,00 \times \pi^2 \times 210000,0[\text{MPa}] \times 4,3446 \cdot 10^{-5}[\text{m}^4]}{(1,00 \times 8,489[\text{m}])^2}$$

$$\times \left[\sqrt{\frac{\left(\frac{1,00}{1,00} \right)^2 \times 8,8785 \cdot 10^{-40}[\text{m}^6]}{4,3446 \cdot 10^{-5}[\text{m}^4]} + \frac{(1,00 \times 8,489[\text{m}])^2 \times 80769,2[\text{MPa}] \times 8,6892 \cdot 10^{-5}[\text{m}^4]}{\pi^2 \times 210000,0[\text{MPa}] \times 4,3446 \cdot 10^{-5}[\text{m}^4]} + (0,11 \times 0[\text{mm}] - 1,00 \times 0[\text{mm}])^2} - (0,11 \times 0[\text{mm}] - 1,00 \times 0[\text{mm}])} \right]$$

$$= 2961,22[\text{kNm}]$$

$$\lambda_{rel,0} = \sqrt{\frac{W_{pl,y} \times f_y}{M_{cr,0}}} = \sqrt{\frac{5,3420 \cdot 10^{-4}[\text{m}^3] \times 355,0[\text{MPa}]}{2961,22[\text{kNm}]} = 0,25$$

$$\lambda_{rel,0,lim} = 0,2 \times \sqrt{C_1} \times \sqrt{\left(1 - \frac{|N_{Ed}|}{N_{cr,z}} \right) \times \left(1 - \frac{|N_{Ed}|}{N_{cr,T}} \right)} = 0,2 \times \sqrt{2,77} \times \sqrt{\left(1 - \frac{|172,13[\text{kN}]|}{312,36[\text{kN}]} \right) \times \left(1 - \frac{|172,13[\text{kN}]|}{655280,77[\text{kN}]} \right)} = 0,27$$

$$C_{my} = C_{my,0} = 0,58$$

$$C_{mz} = C_{mz,0} = 0,68$$

$$C_{mLT} = 1,00$$

$$b_{LT} = 0,5 \times a_{LT} \times \lambda_{rel,0}^2 \times \frac{|M_{y,Ed}|}{\chi_{LT} \times M_{pl,y,Rd}} \times \frac{|M_{z,Ed}|}{M_{pl,z,Rd}} = 0,5 \times 0,00 \times 0,25^2 \times \frac{|-51,76[\text{kNm}]|}{1,00 \times 189,64[\text{kNm}]} \times \frac{|-26,69[\text{kNm}]|}{189,64[\text{kNm}]} = 0,00$$

$$c_{LT} = 10 \times a_{LT} \times \frac{\lambda_{rel,0}^2}{5 + \lambda_{rel,z}^4} \times \frac{|M_{y,Ed}|}{C_{my} \times \chi_{LT} \times M_{pl,y,Rd}} = 10 \times 0,00 \times \frac{0,25^2}{5 + 3,04^4} \times \frac{|-51,76[\text{kNm}]|}{0,58 \times 1,00 \times 189,64[\text{kNm}]} = 0,00$$

$$d_{LT} = 2 \times a_{LT} \times \frac{\lambda_{rel,0}}{0,1 + \lambda_{rel,z}^4} \times \frac{|M_{y,Ed}|}{C_{my} \times \chi_{LT} \times M_{pl,y,Rd}} \times \frac{|M_{z,Ed}|}{C_{mz} \times M_{pl,z,Rd}}$$

$$= 2 \times 0,00 \times \frac{0,25}{0,1 + 3,04^4} \times \frac{|-51,76[\text{kNm}]|}{0,58 \times 1,00 \times 189,64[\text{kNm}]} \times \frac{|-26,69[\text{kNm}]|}{0,68 \times 189,64[\text{kNm}]} = 0,00$$

$$e_{LT} = 1,7 \times a_{LT} \times \frac{\lambda_{rel,0}}{0,1 + \lambda_{rel,z}^4} \times \frac{|M_{y,Ed}|}{C_{my} \times \chi_{LT} \times M_{pl,y,Rd}} = 1,7 \times 0,00 \times \frac{0,25}{0,1 + 3,04^4} \times \frac{|-51,76[\text{kNm}]|}{0,58 \times 1,00 \times 189,64[\text{kNm}]} = 0,00$$

$$w_y = \min \left(\frac{W_{pl,y}}{W_{el,y}}, 1,5 \right) = \min \left(\frac{5,3420 \cdot 10^{-4}[\text{m}^3]}{3,9658 \cdot 10^{-4}[\text{m}^3]}, 1,5 \right) = \min(1,35, 1,50) = 1,35$$

$$w_z = \min \left(\frac{W_{pl,z}}{W_{el,z}}, 1,5 \right) = \min \left(\frac{5,3420 \cdot 10^{-4}[\text{m}^3]}{3,9658 \cdot 10^{-4}[\text{m}^3]}, 1,5 \right) = \min(1,35, 1,50) = 1,35$$

$$n_{pl} = \frac{|N_{Ed}|}{\frac{N_{Rk}}{\gamma_{M1}}} = \frac{172,13[\text{kN}]}{\frac{2880,11[\text{kN}]}{1,10}} = 0,07$$

$$\lambda_{rel,max} = \max(\lambda_{rel,y}, \lambda_{rel,z}) = \max(3,04, 3,04) = 3,04$$

$$C_{yy} = \max \left\{ 1 + (w_y - 1) \times \left[\left(2 - \frac{1,6}{w_y} \times C_{my}^2 \times \lambda_{rel,max} - \frac{1,6}{w_y} \times C_{my}^2 \times \lambda_{rel,max}^2 \right) \times n_{pl} - b_{LT} \right], \frac{W_{el,y}}{W_{pl,y}} \right\}$$

$$= \max \left\{ 1 + (1,35 - 1) \times \left[\left(2 - \frac{1,6}{1,35} \times 0,58^2 \times 3,04 - \frac{1,6}{1,35} \times 0,58^2 \times 3,04^2 \right) \times 0,07 - 0,00 \right], \frac{3,9658 \cdot 10^{-4}[\text{m}^3]}{5,3420 \cdot 10^{-4}[\text{m}^3]} \right\} = \max\{0,93, 0,74\}$$

$$= 0,93$$

$$C_{yz} = \max \left\{ 1 + (w_z - 1) \times \left[\left(2 - 14 \times \frac{C_{mz}^2 \times \lambda_{rel,max}^2}{w_z^5} \right) \times n_{pl} - c_{LT} \right], 0,6 \times \sqrt{\frac{w_z}{w_y}} \times \frac{W_{el,z}}{W_{pl,z}} \right\}$$

$$= \max \left\{ 1 + (1,35 - 1) \times \left[\left(2 - 14 \times \frac{0,68^2 \times 3,04^2}{1,35^5} \right) \times 0,07 - 0,00 \right], 0,6 \times \sqrt{\frac{1,35}{1,35}} \times \frac{3,9658 \cdot 10^{-4}[\text{m}^3]}{5,3420 \cdot 10^{-4}[\text{m}^3]} \right\} = \max\{0,74, 0,45\} = 0,74$$

$$C_{zy} = \max \left\{ 1 + (w_y - 1) \times \left[\left(2 - 14 \times \frac{C_{my}^2 \times \lambda_{rel,max}^2}{w_y^5} \right) \times n_{pl} - d_{LT} \right], 0,6 \times \sqrt{\frac{w_y}{w_z}} \times \frac{W_{el,y}}{W_{pl,y}} \right\}$$

$$= \max \left\{ 1 + (1,35 - 1) \times \left[\left(2 - 14 \times \frac{0,58^2 \times 3,04^2}{1,35^5} \right) \times 0,07 - 0,00 \right], 0,6 \times \sqrt{\frac{1,35}{1,35}} \times \frac{3,9658 \cdot 10^{-4}[\text{m}^3]}{5,3420 \cdot 10^{-4}[\text{m}^3]} \right\} = \max\{0,82, 0,45\} = 0,82$$

$$C_{zz} = \max \left[1 + (w_z - 1) \times \left(2 - \frac{1,6}{w_z} \times C_{mz}^2 \times \lambda_{rel,max} - \frac{1,6}{w_z} \times C_{mz}^2 \times \lambda_{rel,max}^2 - e_{LT} \right) \times n_{pl}, \frac{W_{el,z}}{W_{pl,z}} \right]$$

$$= \max \left[1 + (1,35 - 1) \times \left(2 - \frac{1,6}{1,35} \times 0,68^2 \times 3,04 - \frac{1,6}{1,35} \times 0,68^2 \times 3,04^2 - 0,00 \right) \times 0,07, \frac{3,9658 \cdot 10^{-4}[\text{m}^3]}{5,3420 \cdot 10^{-4}[\text{m}^3]} \right] = \max[0,89, 0,74] = 0,89$$

$$N_{Rk} = A \times f_y = 8,1130 \cdot 10^{-3}[\text{m}^2] \times 355,0[\text{MPa}] = 2880,11[\text{kN}]$$

$$M_{y,Rk} = W_{pl,y} \times f_y = 5,3420 \cdot 10^{-4} [\text{m}^3] \times 355,0 [\text{MPa}] = 189,64 [\text{kNm}]$$

$$M_{z,Rk} = W_{pl,z} \times f_y = 5,3420 \cdot 10^{-4} [\text{m}^3] \times 355,0 [\text{MPa}] = 189,64 [\text{kNm}]$$

$$k_{yy} = C_{my} \times C_{mLT} \times \frac{\mu_y}{1 - \frac{|N_{Ed}|}{N_{cr,y}}} \times \frac{1}{C_{yy}} = 0,58 \times 1,00 \times \frac{0,47}{1 - \frac{|172,13[\text{kN}]|}{312,36[\text{kN}]}} \times \frac{1}{0,93} = 0,65$$

$$k_{yz} = C_{mz} \times \frac{\mu_y}{1 - \frac{|N_{Ed}|}{N_{cr,z}}} \times \frac{1}{C_{yz}} \times 0,6 \times \sqrt{\frac{w_z}{w_y}} = 0,68 \times \frac{0,47}{1 - \frac{|172,13[\text{kN}]|}{312,36[\text{kN}]}} \times \frac{1}{0,74} \times 0,6 \times \sqrt{\frac{1,35}{1,35}} = 0,58$$

$$k_{zy} = C_{my} \times C_{mLT} \times \frac{\mu_z}{1 - \frac{|N_{Ed}|}{N_{cr,y}}} \times \frac{1}{C_{zy}} \times 0,6 \times \sqrt{\frac{w_y}{w_z}} = 0,58 \times 1,00 \times \frac{0,47}{1 - \frac{|172,13[\text{kN}]|}{312,36[\text{kN}]}} \times \frac{1}{0,82} \times 0,6 \times \sqrt{\frac{1,35}{1,35}} = 0,45$$

$$k_{zz} = C_{mz} \times \frac{\mu_z}{1 - \frac{|N_{Ed}|}{N_{cr,z}}} \times \frac{1}{C_{zz}} = 0,68 \times \frac{0,47}{1 - \frac{|172,13[\text{kN}]|}{312,36[\text{kN}]}} \times \frac{1}{0,89} = 0,80$$

$$\begin{aligned} \text{Unity check (6.61)} &= \frac{|N_{Ed}|}{\chi_y \times \frac{N_{Rk}}{\gamma_{M1}}} + k_{yy} \times \frac{|M_{y,Ed}| + |\Delta M_{y,Ed}|}{\chi_{LT} \times \frac{M_{y,Rk}}{\gamma_{M1}}} + k_{yz} \times \frac{|M_{z,Ed}| + |\Delta M_{z,Ed}|}{\frac{M_{z,Rk}}{\gamma_{M1}}} \\ &= \frac{|172,13[\text{kN}]|}{0,09 \times \frac{2880,11[\text{kN}]}{1,10}} + 0,65 \times \frac{|-51,76[\text{kNm}]| + |0,00[\text{kNm}]|}{1,00 \times \frac{189,64[\text{kNm}]}{1,10}} + 0,58 \times \frac{|-26,69[\text{kNm}]| + |0,00[\text{kNm}]|}{\frac{189,64[\text{kNm}]}{1,10}} = \mathbf{0,99 \leq 1,00} \end{aligned}$$

$$\begin{aligned} \text{Unity check (6.62)} &= \frac{|N_{Ed}|}{\chi_z \times \frac{N_{Rk}}{\gamma_{M1}}} + k_{zy} \times \frac{|M_{y,Ed}| + |\Delta M_{y,Ed}|}{\chi_{LT} \times \frac{M_{y,Rk}}{\gamma_{M1}}} + k_{zz} \times \frac{|M_{z,Ed}| + |\Delta M_{z,Ed}|}{\frac{M_{z,Rk}}{\gamma_{M1}}} \\ &= \frac{|172,13[\text{kN}]|}{0,09 \times \frac{2880,11[\text{kN}]}{1,10}} + 0,45 \times \frac{|-51,76[\text{kNm}]| + |0,00[\text{kNm}]|}{1,00 \times \frac{189,64[\text{kNm}]}{1,10}} + 0,80 \times \frac{|-26,69[\text{kNm}]| + |0,00[\text{kNm}]|}{\frac{189,64[\text{kNm}]}{1,10}} = \mathbf{0,96 \leq 1,00} \end{aligned}$$

$$\text{Unity check} = \max(\text{Unity check (6.61)}, \text{Unity check (6.62)}) = \max(0,99, 0,96) = \mathbf{0,99 \leq 1,00}$$

The member satisfies the stability check.

4.4. Stupovi niskog dijela nadstrešnice „S2“

4.4.1. Rezne sile niskog dijela nadstrešnice „S2“

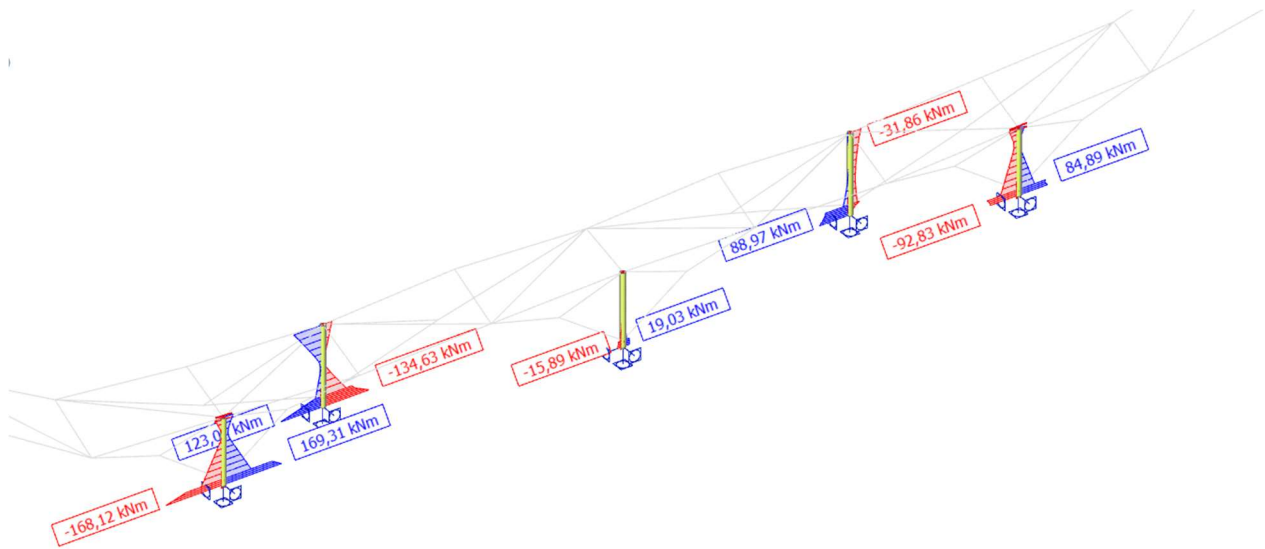

Slika 83: Moment savijanja M_y (kNm)- stupovi niskog dijela nadstrešnice „S2“ od osi N7 do N13

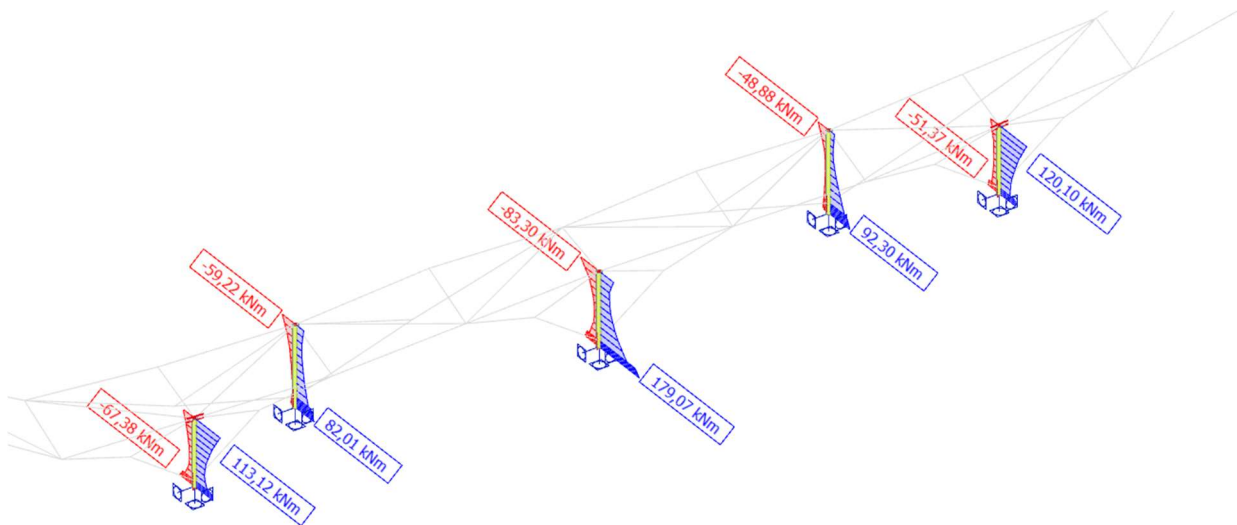

Slika 84: Moment savijanja M_z (kNm)- stupovi niskog dijela nadstrešnice „S2“ od osi N7 do N13

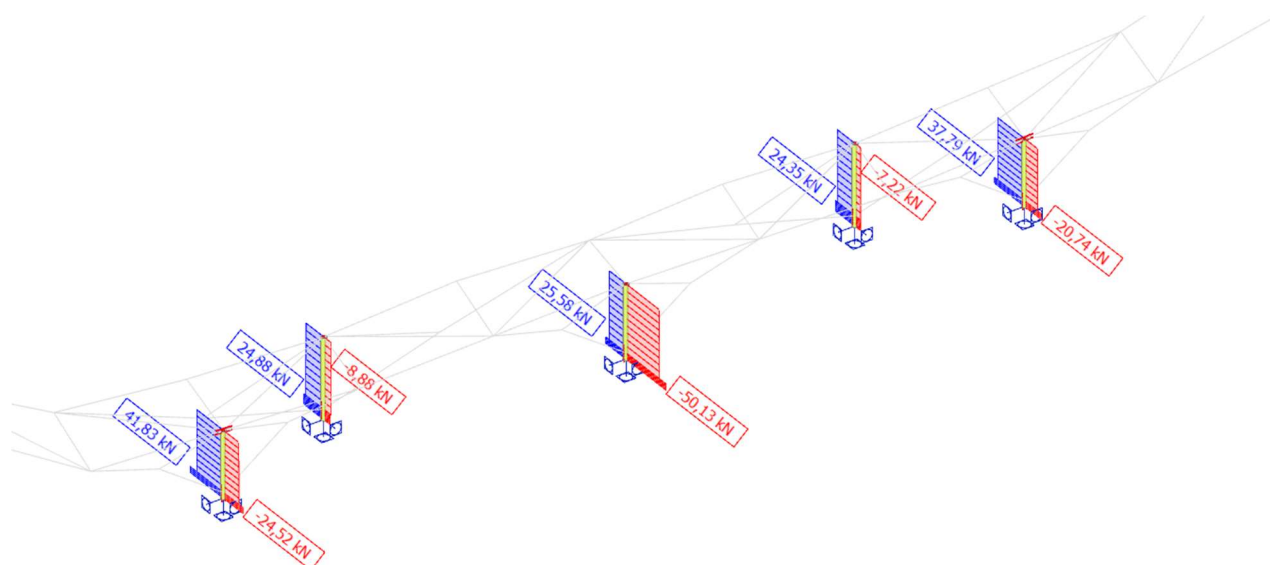

Slika 85: Poprečna sila V_y (kN)- stupovi niskog dijela nadstrešnice „S2“ od osi N7 do N13

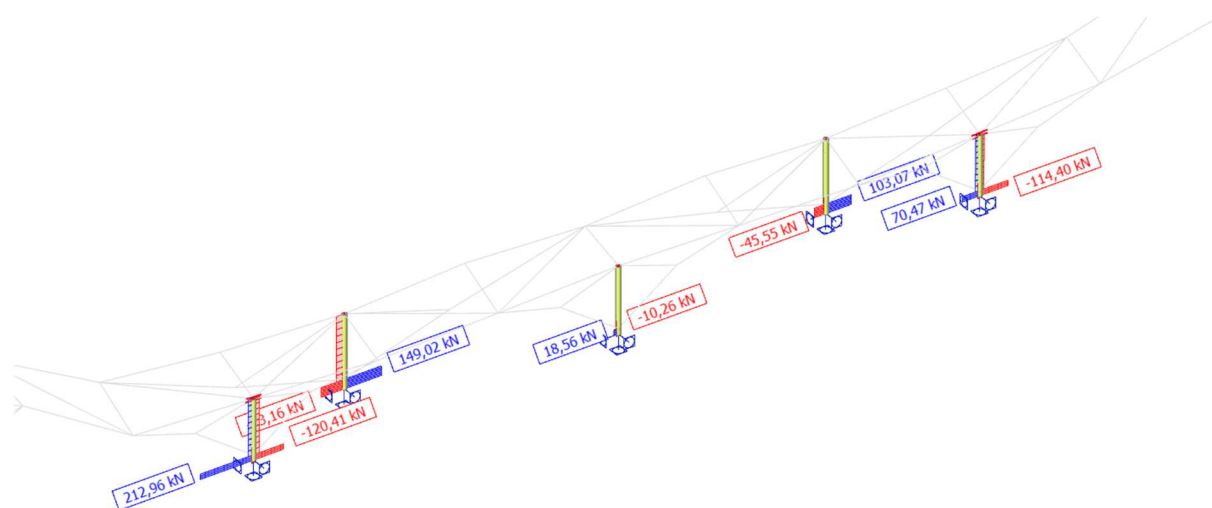

Slika 86: Poprečna sila V_z (kN)- stupovi niskog dijela nadstrešnice „S2“ od osi N7 do N13

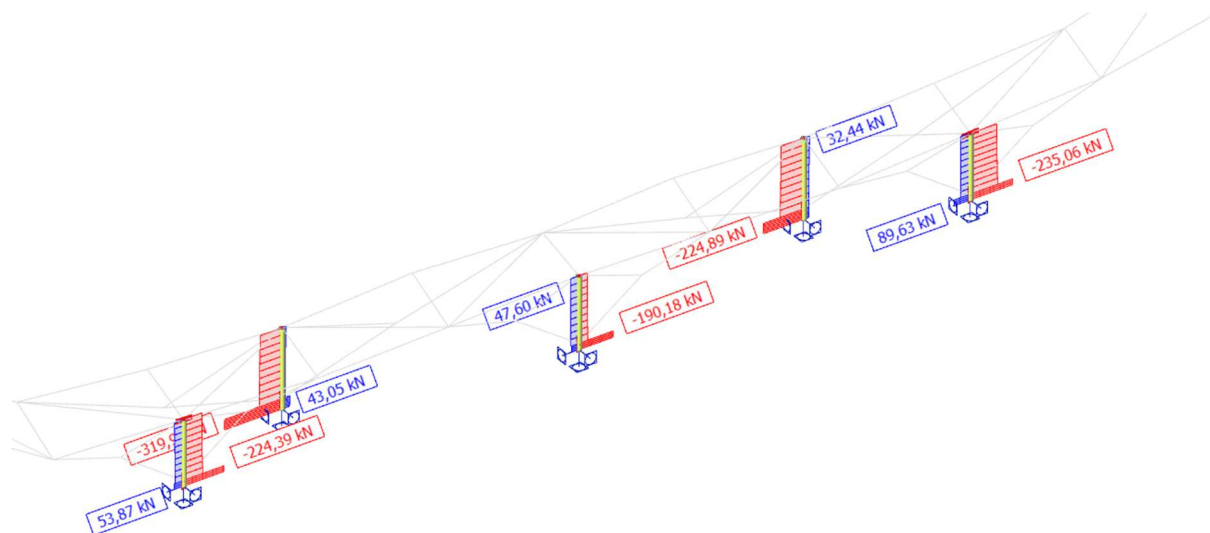

Slika 87: Uzdužna sila N (kN)- stupovi niskog dijela nadstrešnice „S2“ od osi N7 do N13

4.4.2. Dimenzioniranje rubnog stupa nadstrešnice „S1“

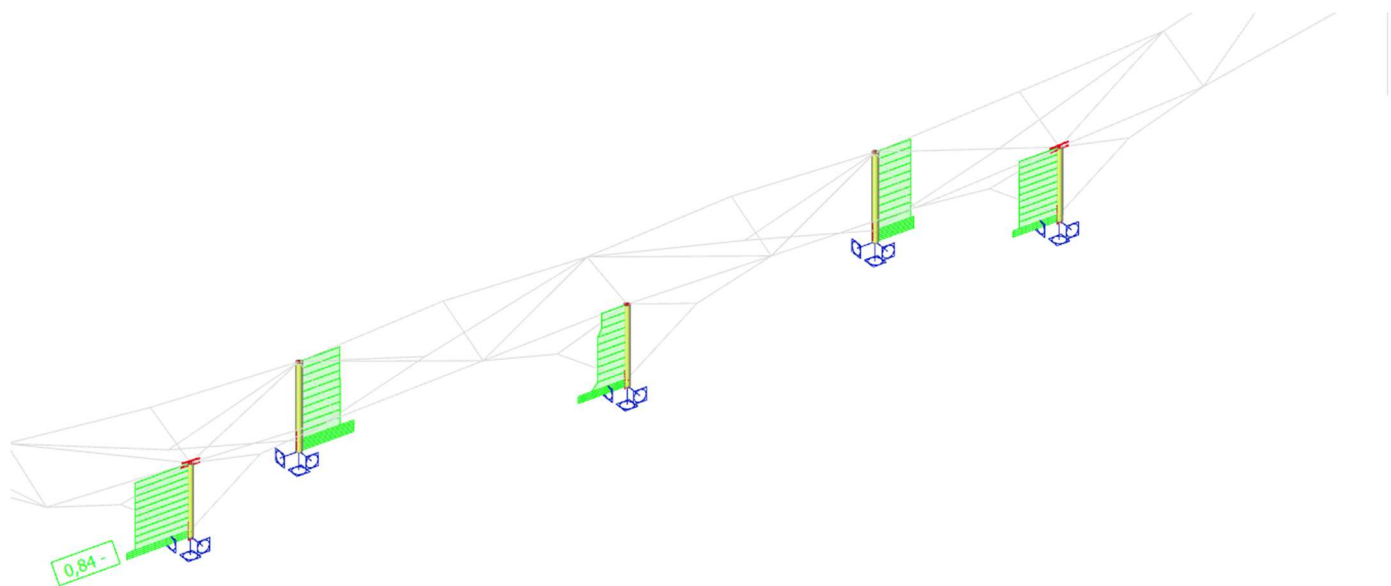

Slika 88: Prikaz iskoristivosti stupova niskog dijela nadstrešnice „S2“ od osi N7 do osi N13

EC-EN 1993 Steel check ULS

Linear calculation
 Combination: ULS-Set B (auto)
 Coordinate system: Principal
 Extreme 1D: Global
 Selection: All

EN 1993-1-1 Code Check

National annex: Standard EN

Member B6203	0,000 / 4,508 m	CFCHS355.6X8	Cold formed	S 355	ULS-Set B (auto)	0,84 -
---------------------	------------------------	---------------------	--------------------	--------------	-------------------------	---------------

Note: EN 1993-1-3 article 1.1(3) specifies that this part does not apply to cold formed CHS and RHS sections. The default EN 1993-1-1 code check is executed instead of the EN 1993-1-3 code check.

Combination key	
ULS-Set B (auto) / 1.35*G + 1.35*dg + 0.75*s + 1.50*T+ + 0.90*w3(pritisak)	

Partial safety factors			
Resistance of cross-sections	γ_{M0}	1,00	
Resistance to instability	γ_{M1}	1,10	
Resistance of net sections	γ_{M2}	1,25	

Material			
Yield strength	f_y	355,0	MPa
Ultimate strength	f_u	490,0	MPa

....:SECTION CHECK:....

The critical check is on position 0,000 m

Internal forces		Calculated	Unit
Normal force	N_{Ed}	-190,27	kN
Shear force	$V_{y,Ed}$	28,08	kN
Shear force	$V_{z,Ed}$	-61,39	kN
Torsion	T_{Ed}	13,23	kNm
Bending moment	$M_{y,Ed}$	162,63	kNm
Bending moment	$M_{z,Ed}$	1,50	kNm

Classification for cross-section design

Classification according to EN 1993-1-1 article 5.5.2

Classification of Tubular sections according to EN 1993-1-1 Table 5.2 Sheet 3

d [mm]	t [mm]	d/t [-]	Class 1 Limit [-]	Class 2 Limit [-]	Class 3 Limit [-]	Class
356	8	44,5	33,1	46,3	59,6	2

The cross-section is classified as Class 2

Compression check

According to EN 1993-1-1 article 6.2.4 and formula (6.9)

Cross-section area	A	8,7360e-03	m ²
Compression resistance	$N_{c,Rd}$	3101,28	kN
Unity check		0,06	-

$$N_{c,Rd} = \frac{A \times f_y}{\gamma_{M0}} = \frac{8,7360 \cdot 10^{-3} [m^2] \times 355,0 [MPa]}{1,00} = 3101,28 [kN]$$

$$\text{Unity check} = \frac{|N_{Ed}|}{N_{c,Rd}} = \frac{|-190,27 [kN]|}{3101,28 [kN]} = 0,06 \leq 1,00$$

Bending moment check for M_y

According to EN 1993-1-1 article 6.2.5 and formula (6.12),(6.13)

Plastic section modulus	$W_{pl,y}$	9,6680e-04	m ³
Plastic bending moment	$M_{pl,y,Rd}$	343,21	kNm
Unity check		0,47	-

$$M_{pl,y,Rd} = \frac{W_{pl,y} \times f_y}{\gamma_{M0}} = \frac{9,6680 \cdot 10^{-4} [m^3] \times 355,0 [MPa]}{1,00} = 343,21 [kNm]$$

$$\text{Unity check} = \frac{|M_{y,Ed}|}{M_{pl,y,Rd}} = \frac{|162,63 [kNm]|}{343,21 [kNm]} = 0,47 \leq 1,00$$

Bending moment check for M_z

According to EN 1993-1-1 article 6.2.5 and formula (6.12),(6.13)

Plastic section modulus	$W_{pl,z}$	9,6680e-04	m ³
Plastic bending moment	$M_{pl,z,Rd}$	343,21	kNm
Unity check		0,00	-

$$M_{pl,z,Rd} = \frac{W_{pl,z} \times f_y}{\gamma_{M0}} = \frac{9,6680 \cdot 10^{-4} [m^3] \times 355,0 [MPa]}{1,00} = 343,21 [kNm]$$

$$\text{Unity check} = \frac{|M_{z,Ed}|}{M_{pl,z,Rd}} = \frac{|1,50 [kNm]|}{343,21 [kNm]} = 0,00 \leq 1,00$$

Shear check for V_y

According to EN 1993-1-1 article 6.2.6 and formula (6.17)

Shear correction factor	η	1,20	
Shear area	A_v	5,5615e-03	m ²
Plastic shear resistance for V_y	$V_{pl,y,Rd}$	1139,88	kN
Unity check		0,02	-

$$V_{pl,y,Rd} = \frac{A_v \times \frac{f_y}{\sqrt{3}}}{\gamma_{M0}} = \frac{5,5615 \cdot 10^{-3} [m^2] \times \frac{355,0 [MPa]}{\sqrt{3}}}{1,00} = 1139,88 [kN]$$

$$\text{Unity check} = \frac{|V_{y,Ed}|}{V_{c,y,Rd}} = \frac{|28,08 [kN]|}{1139,88 [kN]} = 0,02 \leq 1,00$$

Shear check for V_z

According to EN 1993-1-1 article 6.2.6 and formula (6.17)

Shear correction factor	η	1,20	
Shear area	A_v	5,5615e-03	m ²
Plastic shear resistance for V_z	$V_{pl,z,Rd}$	1139,88	kN
Unity check		0,05	-

$$V_{pl,z,Rd} = \frac{A_v \times \frac{f_y}{\sqrt{3}}}{\gamma_{M0}} = \frac{5,5615 \cdot 10^{-3} [m^2] \times \frac{355,0 [MPa]}{\sqrt{3}}}{1,00} = 1139,88 [kN]$$

$$\text{Unity check} = \frac{|V_{z,Ed}|}{V_{c,z,Rd}} = \frac{|-61,39 [kN]|}{1139,88 [kN]} = 0,05 \leq 1,00$$

Torsion check

According to EN 1993-1-1 article 6.2.7 and formula (6.23)

Index of fibre	Fibre	1	
Total torsional moment	T_{Ed}	8,7	MPa
Elastic shear resistance	T_{Rd}	205,0	MPa
Unity check		0,04	-

$$\tau_{Ed} = \left| \frac{T_{Ed}}{T_{Ed,unit}} \times \tau_{Ed,unit} \right| = \left| \frac{13,23[\text{kNm}]}{1,00[\text{kNm}]} \times 658,613[\text{kN/m}^2] \right| = 8,7[\text{MPa}]$$

$$\tau_{Rd} = \frac{f_y}{\sqrt{3} \times \gamma_{M0}} = \frac{355,0[\text{MPa}]}{\sqrt{3} \times 1,00} = 205,0[\text{MPa}]$$

$$\text{Unity check} = \frac{\tau_{Ed}}{\tau_{Rd}} = \frac{8,7[\text{MPa}]}{205,0[\text{MPa}]} = \mathbf{0,04} \leq \mathbf{1,00}$$

Note: The unity check for torsion is lower than the limit value of 0,05. Therefore torsion is considered as insignificant and is ignored in the combined checks.

Combined bending, axial force and shear force check

According to EN 1993-1-1 article 6.2.9.1 and formula (6.31)

Resultant bending moment	$M_{\text{resultant}}$	162,64	kNm
Resultant shear force	$V_{\text{resultant}}$	67,51	kN
Design plastic moment resistance reduced due to N_{Ed}	$M_{N,Rd}$	340,23	kNm
Unity check		0,48	-

$$n = \frac{|N_{Ed}|}{N_{pl,Rd}} = \frac{|-190,27[\text{kN}]|}{3101,28[\text{kN}]} = 0,06$$

$$M_{N,Rd} = M_{pl,Rd} \times (1 - n^{1,7}) = 343,21[\text{kNm}] \times (1 - 0,06^{1,7}) = 340,23[\text{kNm}]$$

$$\text{Unity check} = \frac{|M_{\text{resultant}}|}{M_{N,Rd}} = \frac{162,64[\text{kNm}]}{340,23[\text{kNm}]} = \mathbf{0,48} \leq \mathbf{1,00}$$

Note: The resultant internal forces are used for CHS sections.

Note: Since the shear forces are less than half the plastic shear resistances their effect on the moment resistances is neglected.

The member satisfies the section check.

....:STABILITY CHECK:....

Classification for member buckling design

Decisive position for stability classification: 0,000 m

Decisive utilisation factor η : 0,49

Classification according to EN 1993-1-1 article 5.5.2

Classification of Tubular sections according to EN 1993-1-1 Table 5.2 Sheet 3

d [mm]	t [mm]	d/t [-]	Class 1 Limit [-]	Class 2 Limit [-]	Class 3 Limit [-]	Class
356	8	44,5	33,1	46,3	59,6	2

The cross-section is classified as Class 2

Note: The decisive position for the stability classification is based on the utilisation factor η according to Semi-Comp+.

Flexural Buckling check

According to EN 1993-1-1 article 6.3.1.1 and formula (6.46)

Buckling parameters		yy	zz	
Sway type		sway	non-sway	
System length	L	4,508	4,508	m
Buckling factor	k	1,72	0,66	
Buckling length	l_{cr}	7,747	2,994	m
Critical Euler load	N_{cr}	4559,12	30519,41	kN
Slenderness	λ	63,02	24,36	
Relative slenderness	λ_{rel}	0,82	0,32	
Limit slenderness	$\lambda_{rel,0}$	0,20	0,20	

Buckling parameters		yy	zz	
Buckling curve		c	c	
Imperfection	α	0,49	0,49	
Reduction factor	χ	0,65	0,94	
Buckling resistance	$N_{b,Rd}$	1823,02	2648,91	kN

Flexural Buckling verification			
Cross-section area	A	8,7360e-03	m ²
Buckling resistance	$N_{b,Rd}$	1823,02	kN
Unity check		0,10	-

$$N_{cr,y} = \frac{\pi^2 \times E \times I_y}{l_{cr,y}^2} = \frac{\pi^2 \times 210000,0[\text{MPa}] \times 1,3201 \cdot 10^{-4}[\text{m}^4]}{7,747[\text{m}]^2} = 4559,12[\text{kN}]$$

$$N_{cr,z} = \frac{\pi^2 \times E \times I_z}{l_{cr,z}^2} = \frac{\pi^2 \times 210000,0[\text{MPa}] \times 1,3201 \cdot 10^{-4}[\text{m}^4]}{2,994[\text{m}]^2} = 30519,41[\text{kN}]$$

$$\lambda_y = \frac{l_{cr,y}}{i_y} = \frac{7,747[\text{m}]}{123[\text{mm}]} = 63,02$$

$$\lambda_z = \frac{l_{cr,z}}{i_z} = \frac{2,994[\text{m}]}{123[\text{mm}]} = 24,36$$

$$\lambda_{rel,y} = \frac{\lambda_y}{\pi \times \sqrt{\frac{E}{f_y}}} = \frac{63,02}{\pi \times \sqrt{\frac{210000,0[\text{MPa}]}{355,0[\text{MPa}]}}} = 0,82$$

$$\lambda_{rel,z} = \frac{\lambda_z}{\pi \times \sqrt{\frac{E}{f_y}}} = \frac{24,36}{\pi \times \sqrt{\frac{210000,0[\text{MPa}]}{355,0[\text{MPa}]}}} = 0,32$$

$$\varphi_y = 0,5 \times [1 + \alpha_y \times (\lambda_{rel,y} - \lambda_{rel,y,0}) + \lambda_{rel,y}^2] = 0,5 \times [1 + 0,49 \times (0,82 - 0,20) + 0,82^2] = 0,99$$

$$\varphi_z = 0,5 \times [1 + \alpha_z \times (\lambda_{rel,z} - \lambda_{rel,z,0}) + \lambda_{rel,z}^2] = 0,5 \times [1 + 0,49 \times (0,32 - 0,20) + 0,32^2] = 0,58$$

$$\chi_y = \min \left(\frac{1}{\varphi_y + \sqrt{\varphi_y^2 - \lambda_{rel,y}^2}}, 1 \right) = \min \left(\frac{1}{0,99 + \sqrt{0,99^2 - 0,82^2}}, 1 \right) = \min(0,65, 1) = 0,65$$

$$\chi_z = \min \left(\frac{1}{\varphi_z + \sqrt{\varphi_z^2 - \lambda_{rel,z}^2}}, 1 \right) = \min \left(\frac{1}{0,58 + \sqrt{0,58^2 - 0,32^2}}, 1 \right) = \min(0,94, 1) = 0,94$$

$$N_{b,y,Rd} = \frac{\chi_y \times A \times f_y}{\gamma_{M1}} = \frac{0,65 \times 8,7360 \cdot 10^{-3}[\text{m}^2] \times 355,0[\text{MPa}]}{1,10} = 1823,02[\text{kN}]$$

$$N_{b,z,Rd} = \frac{\chi_z \times A \times f_y}{\gamma_{M1}} = \frac{0,94 \times 8,7360 \cdot 10^{-3}[\text{m}^2] \times 355,0[\text{MPa}]}{1,10} = 2648,91[\text{kN}]$$

$$N_{b,Rd} = \min(N_{b,y,Rd}, N_{b,z,Rd}) = \min(1823,02[\text{kN}], 2648,91[\text{kN}]) = 1823,02[\text{kN}]$$

$$\text{Unity check} = \frac{|N_{Ed}|}{N_{b,Rd}} = \frac{|-190,27[\text{kN}]|}{1823,02[\text{kN}]} = 0,10 \leq 1,00$$

Torsional(-Flexural) Buckling check

According to EN 1993-1-1 article 6.3.1.1 and formula (6.46)

Note: The cross-section concerns a CHS section which is not susceptible to Torsional(-Flexural) Buckling.

Lateral Torsional Buckling check

According to EN 1993-1-1 article 6.3.2.1

Note: The cross-section concerns a CHS section which is not susceptible to Lateral Torsional Buckling.

Bending and axial compression check

According to EN 1993-1-1 article 6.3.3 and formula (6.61),(6.62)

Bending and axial compression check parameters			
Interaction method		alternative method 1	
Cross-section area	A	8,7360e-03	m ²
Plastic section modulus	W _{pl,y}	9,6680e-04	m ³
Plastic section modulus	W _{pl,z}	9,6680e-04	m ³
Design compression force	N _{Ed}	190,27	kN
Design bending moment (maximum)	M _{y,Ed}	162,63	kNm
Design bending moment (maximum)	M _{z,Ed}	95,35	kNm
Characteristic compression resistance	N _{Rk}	3101,28	kN
Characteristic moment resistance	M _{y,Rk}	343,21	kNm
Characteristic moment resistance	M _{z,Rk}	343,21	kNm
Reduction factor	χ _y	0,65	
Reduction factor	χ _z	0,94	
Reduction factor	χ _{LT}	1,00	
Interaction factor	k _{yy}	1,07	
Interaction factor	k _{yz}	0,60	
Interaction factor	k _{zy}	0,66	
Interaction factor	k _{zz}	1,01	

Maximum moment M_{y,Ed} is derived from beam B6203 position 0,000 m.

Maximum moment M_{z,Ed} is derived from beam B6203 position 4,508 m.

Interaction method 1 parameters			
Critical Euler load	N _{cr,y}	4559,12	kN
Critical Euler load	N _{cr,z}	30519,41	kN
Elastic critical load	N _{cr,T}	705626,73	kN
Plastic section modulus	W _{pl,y}	9,6680e-04	m ³
Elastic section modulus	W _{el,y}	7,4250e-04	m ³
Plastic section modulus	W _{pl,z}	9,6680e-04	m ³
Elastic section modulus	W _{el,z}	7,4250e-04	m ³
Second moment of area	I _y	1,3201e-04	m ⁴
Second moment of area	I _z	1,3201e-04	m ⁴
Torsional constant	I _t	2,6403e-04	m ⁴
Method for equivalent moment factor C _{my,0}		Table A.2 Line 2 (General)	
Design bending moment (maximum)	M _{y,Ed}	162,63	kNm
Maximum relative deflection	δ _z	23,2	mm
Equivalent moment factor	C _{my,0}	1,04	
Method for equivalent moment factor C _{mz,0}		Table A.2 Line 2 (General)	
Design bending moment (maximum)	M _{z,Ed}	95,35	kNm
Maximum relative deflection	δ _y	10,2	mm
Equivalent moment factor	C _{mz,0}	1,00	
Factor	μ _y	0,98	
Factor	μ _z	1,00	
Factor	ε _y	10,06	
Factor	a _{LT}	0,00	
Critical moment for uniform bending	M _{cr,0}	16944,23	kNm
Relative slenderness	λ _{rel,0}	0,14	
Limit relative slenderness	λ _{rel,0,lim}	0,33	
Equivalent moment factor	C _{my}	1,04	
Equivalent moment factor	C _{mz}	1,00	
Equivalent moment factor	C _{mLT}	1,00	
Factor	b _{LT}	0,00	
Factor	c _{LT}	0,00	
Factor	d _{LT}	0,00	
Factor	e _{LT}	0,00	

Interaction method 1 parameters		
Factor	W_y	1,30
Factor	W_z	1,30
Factor	n_{pl}	0,07
Maximum relative slenderness	$\lambda_{rel,max}$	0,82
Factor	C_{yy}	1,00
Factor	C_{yz}	0,99
Factor	C_{zy}	0,98
Factor	C_{zz}	1,00

Unity check (6.61) = 0,10 + 0,56 + 0,18 = 0,84 -

Unity check (6.62) = 0,07 + 0,34 + 0,31 = 0,72 -

$$N_{cr,y} = \frac{\pi^2 \times E \times I_y}{I_{cr,y}^2} = \frac{\pi^2 \times 210000,0[\text{MPa}] \times 1,3201 \cdot 10^{-4}[\text{m}^4]}{7,747[\text{m}]^2} = 4559,12[\text{kN}]$$

$$N_{cr,z} = \frac{\pi^2 \times E \times I_z}{I_{cr,z}^2} = \frac{\pi^2 \times 210000,0[\text{MPa}] \times 1,3201 \cdot 10^{-4}[\text{m}^4]}{2,994[\text{m}]^2} = 30519,41[\text{kN}]$$

$$N_{cr,T} = \frac{1}{i_0^2} \times \left(G \times I_t + \frac{\pi^2 \times E \times I_w}{I_{cr}^2} \right) = \frac{1}{174[\text{mm}]^2} \times \left(80769,2[\text{MPa}] \times 2,6403 \cdot 10^{-4}[\text{m}^4] + \frac{\pi^2 \times 210000,0[\text{MPa}] \times 7,8644 \cdot 10^{-39}[\text{m}^6]}{4,508[\text{m}]^2} \right)$$

$$= 705626,73[\text{kN}]$$

$$C_{my,0} = 1 + \left(\frac{\pi^2 \times E \times I_y \times |\delta_z|}{L^2 \times |M_{y,Ed}|} - 1 \right) \times \frac{|N_{Ed}|}{N_{cr,y}} = 1 + \left(\frac{\pi^2 \times 210000,0[\text{MPa}] \times 1,3201 \cdot 10^{-4}[\text{m}^4] \times |23,2[\text{mm}]|}{4,508[\text{m}]^2 \times |162,63[\text{kNm}]|} - 1 \right) \times \frac{|190,27[\text{kN}]|}{4559,12[\text{kN}]} = 1,04$$

$$C_{mz,0} = 1 + \left(\frac{\pi^2 \times E \times I_z \times |\delta_y|}{L^2 \times |M_{z,Ed}|} - 1 \right) \times \frac{|N_{Ed}|}{N_{cr,z}} = 1 + \left(\frac{\pi^2 \times 210000,0[\text{MPa}] \times 1,3201 \cdot 10^{-4}[\text{m}^4] \times |10,2[\text{mm}]|}{4,508[\text{m}]^2 \times |95,35[\text{kNm}]|} - 1 \right) \times \frac{|190,27[\text{kN}]|}{30519,41[\text{kN}]} = 1,00$$

$$\mu_y = \frac{1 - \frac{|N_{Ed}|}{N_{cr,y}}}{1 - \frac{\chi_y \times |N_{Ed}|}{N_{cr,y}}} = \frac{1 - \frac{|190,27[\text{kN}]|}{4559,12[\text{kN}]}}{1 - \frac{0,65 \times |190,27[\text{kN}]|}{4559,12[\text{kN}]}} = 0,98$$

$$\mu_z = \frac{1 - \frac{|N_{Ed}|}{N_{cr,z}}}{1 - \frac{\chi_z \times |N_{Ed}|}{N_{cr,z}}} = \frac{1 - \frac{|190,27[\text{kN}]|}{30519,41[\text{kN}]}}{1 - \frac{0,94 \times |190,27[\text{kN}]|}{30519,41[\text{kN}]}} = 1,00$$

$$\varepsilon_y = \left| \frac{M_{y,Ed}}{N_{Ed}} \right| \times \frac{A}{W_{el,y}} = \left| \frac{162,63[\text{kNm}]}{190,27[\text{kN}]} \right| \times \frac{8,7360 \cdot 10^{-3}[\text{m}^2]}{7,4250 \cdot 10^{-4}[\text{m}^3]} = 10,06$$

$$a_{LT} = \max \left(1 - \frac{I_t}{I_y}, 0 \right) = \max \left(1 - \frac{2,6403 \cdot 10^{-4}[\text{m}^4]}{1,3201 \cdot 10^{-4}[\text{m}^4]}, 0 \right) = \max(-1,00, 0,00) = 0,00$$

$$M_{cr,0} = \frac{C_1 \times \pi^2 \times E \times I_z}{(k \times l_{LT})^2} \times \sqrt{\frac{\left(\frac{k}{k_w} \right)^2 \times I_w}{I_z} + \frac{(k \times l_{LT})^2 \times G \times I_t}{\pi^2 \times E \times I_z} + (C_2 \times z_g - C_3 \times z_y)^2 - (C_2 \times z_g - C_3 \times z_y)}$$

$$= \frac{1,00 \times \pi^2 \times 210000,0[\text{MPa}] \times 1,3201 \cdot 10^{-4}[\text{m}^4]}{(1,00 \times 4,508[\text{m}])^2}$$

$$\times \sqrt{\frac{\left(\frac{1,00}{1,00} \right)^2 \times 7,8644 \cdot 10^{-39}[\text{m}^6]}{1,3201 \cdot 10^{-4}[\text{m}^4]} + \frac{(1,00 \times 4,508[\text{m}])^2 \times 80769,2[\text{MPa}] \times 2,6403 \cdot 10^{-4}[\text{m}^4]}{\pi^2 \times 210000,0[\text{MPa}] \times 1,3201 \cdot 10^{-4}[\text{m}^4]} + (0,26 \times 0[\text{mm}] - 1,00 \times 0[\text{mm}])^2 - (0,26 \times 0[\text{mm}] - 1,00 \times 0[\text{mm}])}$$

$$= 16944,23[\text{kNm}]$$

$$\lambda_{rel,0} = \sqrt{\frac{W_{pl,y} \times f_y}{M_{cr,0}}} = \sqrt{\frac{9,6680 \cdot 10^{-4}[\text{m}^3] \times 355,0[\text{MPa}]}{16944,23[\text{kNm}]} = 0,14$$

$$\lambda_{rel,0,lim} = 0,2 \times \sqrt{C_1} \times \sqrt{\left(1 - \frac{|N_{Ed}|}{N_{cr,z}} \right) \times \left(1 - \frac{|N_{Ed}|}{N_{cr,T}} \right)} = 0,2 \times \sqrt{2,80} \times \sqrt{\left(1 - \frac{|190,27[\text{kN}]|}{30519,41[\text{kN}]} \right) \times \left(1 - \frac{|190,27[\text{kN}]|}{705626,73[\text{kN}]} \right)} = 0,33$$

$$C_{my} = C_{my,0} = 1,04$$

$$C_{mz} = C_{mz,0} = 1,00$$

$$C_{mLT} = 1,00$$

$$b_{LT} = 0,5 \times a_{LT} \times \lambda_{rel,0}^2 \times \frac{|M_{y,Ed}|}{\chi_{LT} \times M_{pl,y,Rd}} \times \frac{|M_{z,Ed}|}{M_{pl,z,Rd}} = 0,5 \times 0,00 \times 0,14^2 \times \frac{|162,63[\text{kNm}]|}{1,00 \times 343,21[\text{kNm}]} \times \frac{|95,35[\text{kNm}]|}{343,21[\text{kNm}]} = 0,00$$

$$c_{LT} = 10 \times a_{LT} \times \frac{\lambda_{rel,0}^2}{5 + \lambda_{rel,z}^4} \times \frac{|M_{y,Ed}|}{C_{my} \times \chi_{LT} \times M_{pl,y,Rd}} = 10 \times 0,00 \times \frac{0,14^2}{5 + 0,32^4} \times \frac{|162,63[\text{kNm}]|}{1,04 \times 1,00 \times 343,21[\text{kNm}]} = 0,00$$

$$d_{LT} = 2 \times a_{LT} \times \frac{\lambda_{rel,0}}{0,1 + \lambda_{rel,z}^4} \times \frac{|M_{y,Ed}|}{C_{my} \times \chi_{LT} \times M_{pl,y,Rd}} \times \frac{|M_{z,Ed}|}{C_{mz} \times M_{pl,z,Rd}}$$

$$= 2 \times 0,00 \times \frac{0,14}{0,1 + 0,32^4} \times \frac{|162,63[\text{kNm}]|}{1,04 \times 1,00 \times 343,21[\text{kNm}]} \times \frac{|95,35[\text{kNm}]|}{1,00 \times 343,21[\text{kNm}]} = 0,00$$

$$e_{LT} = 1,7 \times a_{LT} \times \frac{\lambda_{rel,0}}{0,1 + \lambda_{rel,z}^4} \times \frac{|M_{y,Ed}|}{C_{my} \times \chi_{LT} \times M_{pl,y,Rd}} = 1,7 \times 0,00 \times \frac{0,14}{0,1 + 0,32^4} \times \frac{|162,63[\text{kNm}]|}{1,04 \times 1,00 \times 343,21[\text{kNm}]} = 0,00$$

$$w_y = \min \left(\frac{W_{pl,y}}{W_{el,y}}, 1,5 \right) = \min \left(\frac{9,6680 \cdot 10^{-4}[\text{m}^3]}{7,4250 \cdot 10^{-4}[\text{m}^3]}, 1,5 \right) = \min(1,30, 1,50) = 1,30$$

$$w_z = \min \left(\frac{W_{pl,z}}{W_{el,z}}, 1,5 \right) = \min \left(\frac{9,6680 \cdot 10^{-4}[\text{m}^3]}{7,4250 \cdot 10^{-4}[\text{m}^3]}, 1,5 \right) = \min(1,30, 1,50) = 1,30$$

$$n_{pl} = \frac{|N_{Ed}|}{\frac{N_{Rk}}{\gamma_{M1}}} = \frac{|190,27[\text{kN}]|}{\frac{3101,28[\text{kN}]}{1,10}} = 0,07$$

$$\lambda_{rel,max} = \max(\lambda_{rel,y}, \lambda_{rel,z}) = \max(0,82, 0,32) = 0,82$$

$$C_{yy} = \max \left\{ 1 + (w_y - 1) \times \left[\left(2 - \frac{1,6}{w_y} \times C_{my}^2 \times \lambda_{rel,max} - \frac{1,6}{w_y} \times C_{my}^2 \times \lambda_{rel,max}^2 \right) \times n_{pl} - b_{LT} \right], \frac{W_{el,y}}{W_{pl,y}} \right\}$$

$$= \max \left\{ 1 + (1,30 - 1) \times \left[\left(2 - \frac{1,6}{1,30} \times 1,04^2 \times 0,82 - \frac{1,6}{1,30} \times 1,04^2 \times 0,82^2 \right) \times 0,07 - 0,00 \right], \frac{7,4250 \cdot 10^{-4}[\text{m}^3]}{9,6680 \cdot 10^{-4}[\text{m}^3]} \right\} = \max\{1,00, 0,77\}$$

$$= 1,00$$

$$C_{yz} = \max \left\{ 1 + (w_z - 1) \times \left[\left(2 - 14 \times \frac{C_{mz}^2 \times \lambda_{rel,max}^2}{w_z^5} \right) \times n_{pl} - c_{LT} \right], 0,6 \times \sqrt{\frac{w_z}{w_y}} \times \frac{W_{el,z}}{W_{pl,z}} \right\}$$

$$= \max \left\{ 1 + (1,30 - 1) \times \left[\left(2 - 14 \times \frac{1,00^2 \times 0,82^2}{1,30^5} \right) \times 0,07 - 0,00 \right], 0,6 \times \sqrt{\frac{1,30}{1,30}} \times \frac{7,4250 \cdot 10^{-4}[\text{m}^3]}{9,6680 \cdot 10^{-4}[\text{m}^3]} \right\} = \max\{0,99, 0,46\} = 0,99$$

$$C_{zy} = \max \left\{ 1 + (w_y - 1) \times \left[\left(2 - 14 \times \frac{C_{my}^2 \times \lambda_{rel,max}^2}{w_y^5} \right) \times n_{pl} - d_{LT} \right], 0,6 \times \sqrt{\frac{w_y}{w_z}} \times \frac{W_{el,y}}{W_{pl,y}} \right\}$$

$$= \max \left\{ 1 + (1,30 - 1) \times \left[\left(2 - 14 \times \frac{1,04^2 \times 0,82^2}{1,30^5} \right) \times 0,07 - 0,00 \right], 0,6 \times \sqrt{\frac{1,30}{1,30}} \times \frac{7,4250 \cdot 10^{-4}[\text{m}^3]}{9,6680 \cdot 10^{-4}[\text{m}^3]} \right\} = \max\{0,98, 0,46\} = 0,98$$

$$C_{zz} = \max \left[1 + (w_z - 1) \times \left(2 - \frac{1,6}{w_z} \times C_{mz}^2 \times \lambda_{rel,max} - \frac{1,6}{w_z} \times C_{mz}^2 \times \lambda_{rel,max}^2 - e_{LT} \right) \times n_{pl}, \frac{W_{el,z}}{W_{pl,z}} \right]$$

$$= \max \left[1 + (1,30 - 1) \times \left(2 - \frac{1,6}{1,30} \times 1,00^2 \times 0,82 - \frac{1,6}{1,30} \times 1,00^2 \times 0,82^2 - 0,00 \right) \times 0,07, \frac{7,4250 \cdot 10^{-4}[\text{m}^3]}{9,6680 \cdot 10^{-4}[\text{m}^3]} \right] = \max[1,00, 0,77] = 1,00$$

$$N_{Rk} = A \times f_y = 8,7360 \cdot 10^{-3}[\text{m}^2] \times 355,0[\text{MPa}] = 3101,28[\text{kN}]$$

$$M_{y,Rk} = W_{pl,y} \times f_y = 9,6680 \cdot 10^{-4} [\text{m}^3] \times 355,0 [\text{MPa}] = 343,21 [\text{kNm}]$$

$$M_{z,Rk} = W_{pl,z} \times f_y = 9,6680 \cdot 10^{-4} [\text{m}^3] \times 355,0 [\text{MPa}] = 343,21 [\text{kNm}]$$

$$k_{yy} = C_{my} \times C_{mLT} \times \frac{\mu_y}{1 - \frac{|N_{Ed}|}{N_{cr,y}}} \times \frac{1}{C_{yy}} = 1,04 \times 1,00 \times \frac{0,98}{1 - \frac{|190,27[\text{kN}]|}{4559,12[\text{kN}]}} \times \frac{1}{1,00} = 1,07$$

$$k_{yz} = C_{mz} \times \frac{\mu_y}{1 - \frac{|N_{Ed}|}{N_{cr,z}}} \times \frac{1}{C_{yz}} \times 0,6 \times \sqrt{\frac{w_z}{w_y}} = 1,00 \times \frac{0,98}{1 - \frac{|190,27[\text{kN}]|}{30519,41[\text{kN}]}} \times \frac{1}{0,99} \times 0,6 \times \sqrt{\frac{1,30}{1,30}} = 0,60$$

$$k_{zy} = C_{my} \times C_{mLT} \times \frac{\mu_z}{1 - \frac{|N_{Ed}|}{N_{cr,y}}} \times \frac{1}{C_{zy}} \times 0,6 \times \sqrt{\frac{w_y}{w_z}} = 1,04 \times 1,00 \times \frac{1,00}{1 - \frac{|190,27[\text{kN}]|}{4559,12[\text{kN}]}} \times \frac{1}{0,98} \times 0,6 \times \sqrt{\frac{1,30}{1,30}} = 0,66$$

$$k_{zz} = C_{mz} \times \frac{\mu_z}{1 - \frac{|N_{Ed}|}{N_{cr,z}}} \times \frac{1}{C_{zz}} = 1,00 \times \frac{1,00}{1 - \frac{|190,27[\text{kN}]|}{30519,41[\text{kN}]}} \times \frac{1}{1,00} = 1,01$$

$$\begin{aligned} \text{Unity check (6.61)} &= \frac{|N_{Ed}|}{\chi_y \times \frac{N_{Rk}}{\gamma_{M1}}} + k_{yy} \times \frac{|M_{y,Ed}| + |\Delta M_{y,Ed}|}{\chi_{LT} \times \frac{M_{y,Rk}}{\gamma_{M1}}} + k_{yz} \times \frac{|M_{z,Ed}| + |\Delta M_{z,Ed}|}{\frac{M_{z,Rk}}{\gamma_{M1}}} \\ &= \frac{|190,27[\text{kN}]|}{0,65 \times \frac{3101,28[\text{kN}]}{1,10}} + 1,07 \times \frac{|162,63[\text{kNm}]| + |0,00[\text{kNm}]|}{1,00 \times \frac{343,21[\text{kNm}]}{1,10}} + 0,60 \times \frac{|95,35[\text{kNm}]| + |0,00[\text{kNm}]|}{\frac{343,21[\text{kNm}]}{1,10}} = \mathbf{0,84 \leq 1,00} \end{aligned}$$

$$\begin{aligned} \text{Unity check (6.62)} &= \frac{|N_{Ed}|}{\chi_z \times \frac{N_{Rk}}{\gamma_{M1}}} + k_{zy} \times \frac{|M_{y,Ed}| + |\Delta M_{y,Ed}|}{\chi_{LT} \times \frac{M_{y,Rk}}{\gamma_{M1}}} + k_{zz} \times \frac{|M_{z,Ed}| + |\Delta M_{z,Ed}|}{\frac{M_{z,Rk}}{\gamma_{M1}}} \\ &= \frac{|190,27[\text{kN}]|}{0,94 \times \frac{3101,28[\text{kN}]}{1,10}} + 0,66 \times \frac{|162,63[\text{kNm}]| + |0,00[\text{kNm}]|}{1,00 \times \frac{343,21[\text{kNm}]}{1,10}} + 1,01 \times \frac{|95,35[\text{kNm}]| + |0,00[\text{kNm}]|}{\frac{343,21[\text{kNm}]}{1,10}} = \mathbf{0,72 \leq 1,00} \end{aligned}$$

$$\text{Unity check} = \max(\text{Unity check (6.61)}, \text{Unity check (6.62)}) = \max(0,84, 0,72) = \mathbf{0,84 \leq 1,00}$$

The member satisfies the stability check.

4.5. Rubni stup nadstrešnice „S3“

4.5.1. Rezne sile niskog dijela nadstrešnice „S3“

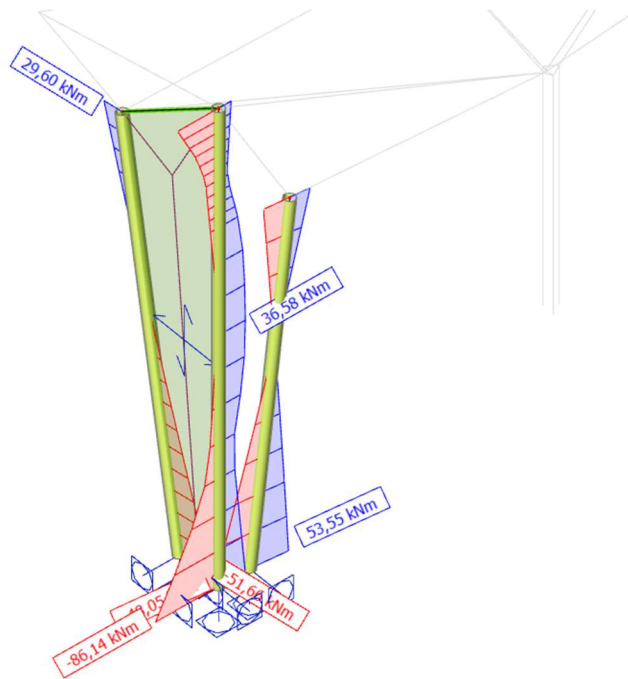

Slika 89: Moment savijanja M_y (kNm)- rubni stup nadstrešnice „S3“

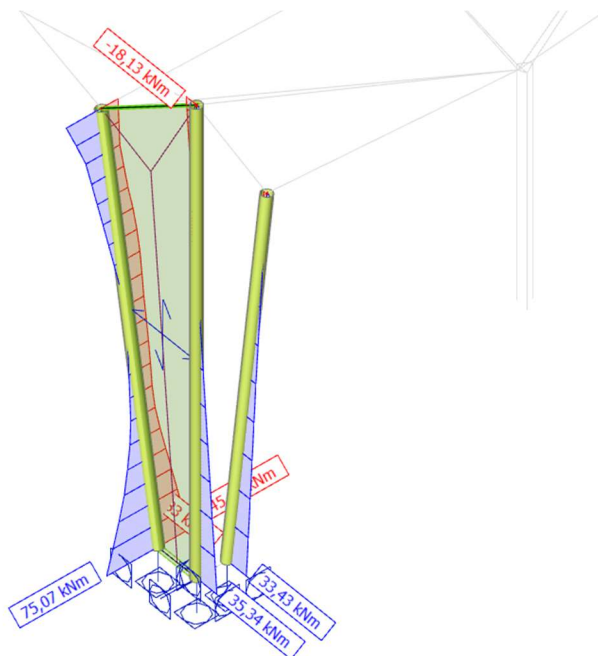

Slika 90: Moment savijanja M_z (kNm)- rubni stup nadstrešnice „S3“

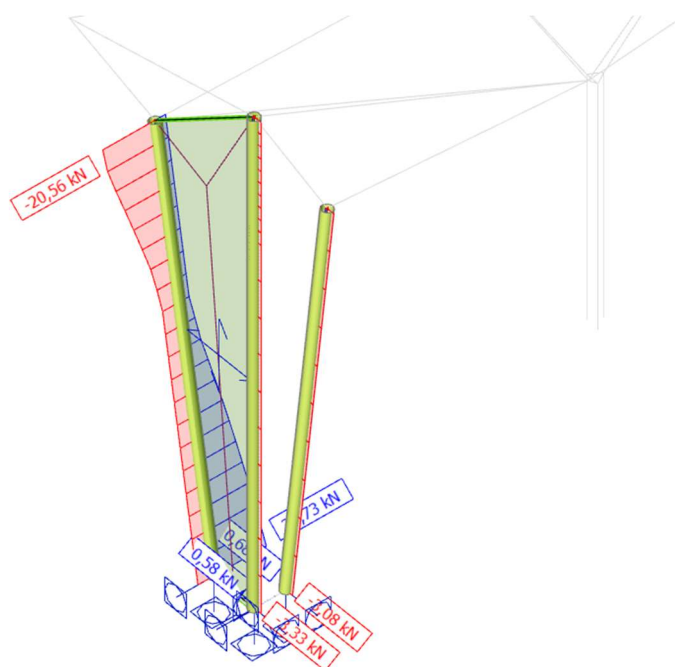

Slika 91: Poprečna sila V_y (kN)- rubni stup nadstrešnice,,S3“

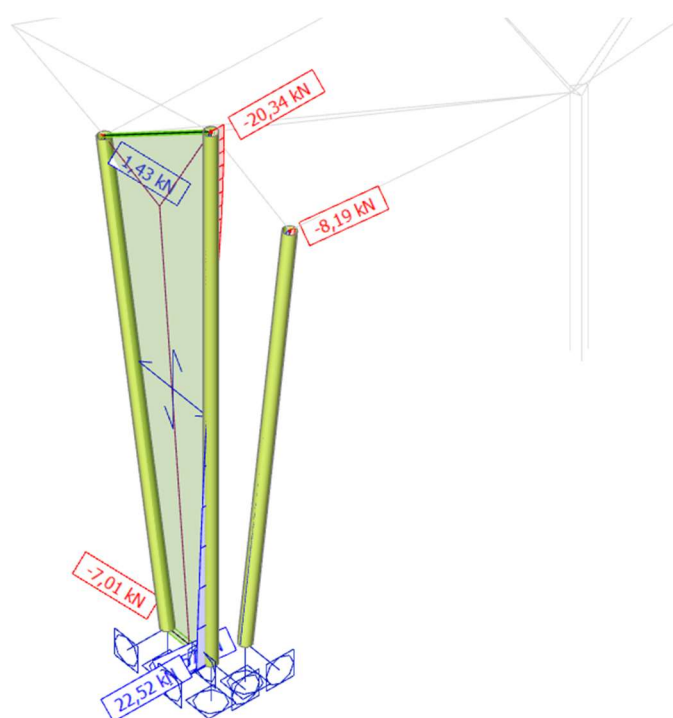

Slika 92: Poprečna sila V_z (kN)- rubni stup nadstrešnice,,S3“

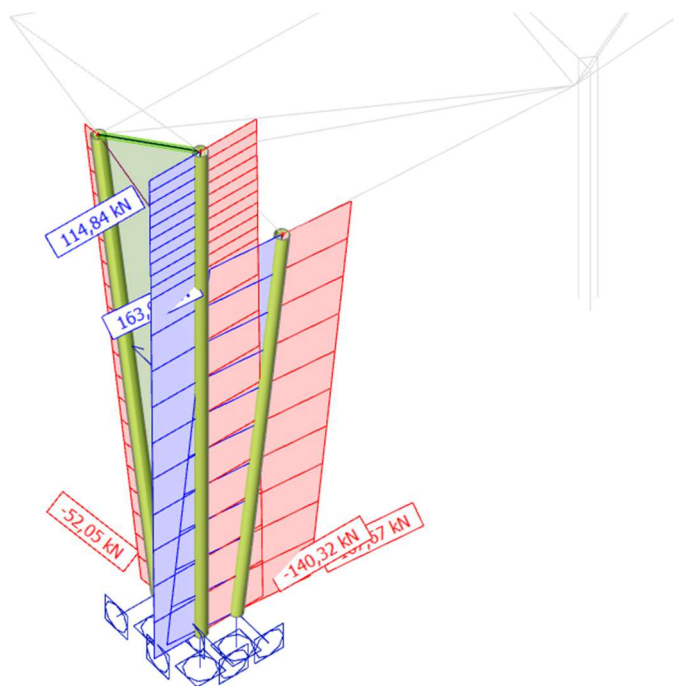

Slika 93: Uzdužna sila $N(kN)$ - rubni stup nadstrešnice, „S3“

4.5.2. Dimenzioniranje rubnog stupa nadstrešnice „S3“

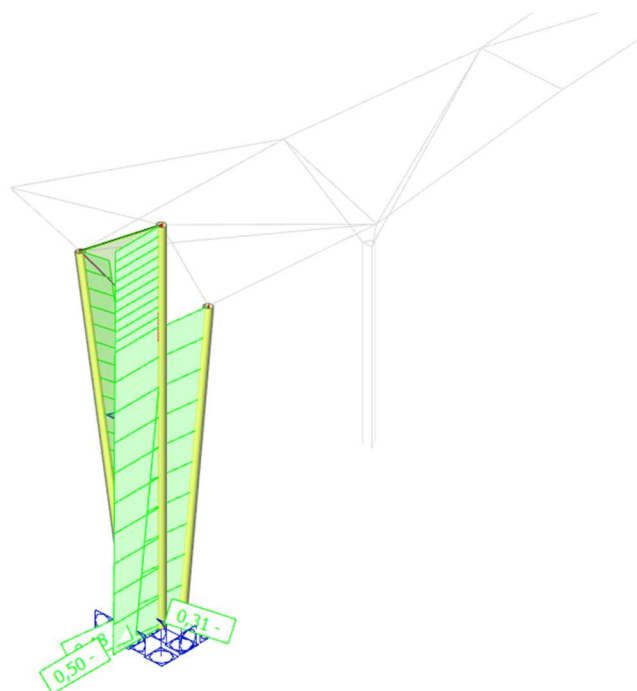

Slika 94: Prikaz iskoristivosti rubnog stupa nadstrešnice „S3“

EC-EN 1993 Steel check ULS

Linear calculation
 Combination: ULS-Set B (auto)
 Coordinate system: Principal
 Extreme 1D: Global
 Selection: All

EN 1993-1-1 Code Check

National annex: Standard EN

Member B6203	0,000 / 4,508 m	CFCHS355.6X8	Cold formed	S 355	ULS-Set B (auto)	0,84 -
---------------------	------------------------	---------------------	--------------------	--------------	-------------------------	---------------

Note: EN 1993-1-3 article 1.1(3) specifies that this part does not apply to cold formed CHS and RHS sections. The default EN 1993-1-1 code check is executed instead of the EN 1993-1-3 code check.

Combination key
ULS-Set B (auto) / 1.35*G + 1.35*dg + 0.75*s + 1.50*T+ + 0.90*w3(pritisak)

Partial safety factors			
Resistance of cross-sections	γ_{M0}	1,00	
Resistance to instability	γ_{M1}	1,10	
Resistance of net sections	γ_{M2}	1,25	

Material			
Yield strength	f_y	355,0	MPa
Ultimate strength	f_u	490,0	MPa

....:SECTION CHECK:....

The critical check is on position 0,000 m

Internal forces		Calculated	Unit
Normal force	N_{Ed}	-190,27	kN
Shear force	$V_{y,Ed}$	28,08	kN
Shear force	$V_{z,Ed}$	-61,39	kN
Torsion	T_{Ed}	13,23	kNm
Bending moment	$M_{y,Ed}$	162,63	kNm
Bending moment	$M_{z,Ed}$	1,50	kNm

Classification for cross-section design

Classification according to EN 1993-1-1 article 5.5.2
 Classification of Tubular sections according to EN 1993-1-1 Table 5.2 Sheet 3

d [mm]	t [mm]	d/t [-]	Class 1 Limit [-]	Class 2 Limit [-]	Class 3 Limit [-]	Class
356	8	44,5	33,1	46,3	59,6	2

The cross-section is classified as Class 2

Compression check

According to EN 1993-1-1 article 6.2.4 and formula (6.9)

Cross-section area	A	8,7360e-03	m ²
Compression resistance	$N_{c,Rd}$	3101,28	kN
Unity check		0,06	-

$$N_{c,Rd} = \frac{A \times f_y}{\gamma_{M0}} = \frac{8,7360 \cdot 10^{-3} [m^2] \times 355,0 [MPa]}{1,00} = 3101,28 [kN]$$

$$\text{Unity check} = \frac{|N_{Ed}|}{N_{c,Rd}} = \frac{|-190,27[\text{kN}]|}{3101,28[\text{kN}]} = \mathbf{0,06 \leq 1,00}$$

Bending moment check for M_y

According to EN 1993-1-1 article 6.2.5 and formula (6.12),(6.13)

Plastic section modulus	$W_{pl,y}$	9,6680e-04	m ³
Plastic bending moment	$M_{pl,y,Rd}$	343,21	kNm
Unity check		0,47	-

$$M_{pl,y,Rd} = \frac{W_{pl,y} \times f_y}{\gamma_{M0}} = \frac{9,6680 \cdot 10^{-4}[\text{m}^3] \times 355,0[\text{MPa}]}{1,00} = 343,21[\text{kNm}]$$

$$\text{Unity check} = \frac{|M_{y,Ed}|}{M_{pl,y,Rd}} = \frac{|162,63[\text{kNm}]|}{343,21[\text{kNm}]} = \mathbf{0,47 \leq 1,00}$$

Bending moment check for M_z

According to EN 1993-1-1 article 6.2.5 and formula (6.12),(6.13)

Plastic section modulus	$W_{pl,z}$	9,6680e-04	m ³
Plastic bending moment	$M_{pl,z,Rd}$	343,21	kNm
Unity check		0,00	-

$$M_{pl,z,Rd} = \frac{W_{pl,z} \times f_y}{\gamma_{M0}} = \frac{9,6680 \cdot 10^{-4}[\text{m}^3] \times 355,0[\text{MPa}]}{1,00} = 343,21[\text{kNm}]$$

$$\text{Unity check} = \frac{|M_{z,Ed}|}{M_{pl,z,Rd}} = \frac{|1,50[\text{kNm}]|}{343,21[\text{kNm}]} = \mathbf{0,00 \leq 1,00}$$

Shear check for V_y

According to EN 1993-1-1 article 6.2.6 and formula (6.17)

Shear correction factor	η	1,20	
Shear area	A_v	5,5615e-03	m ²
Plastic shear resistance for V_y	$V_{pl,y,Rd}$	1139,88	kN
Unity check		0,02	-

$$V_{pl,y,Rd} = \frac{A_v \times \frac{f_y}{\sqrt{3}}}{\gamma_{M0}} = \frac{5,5615 \cdot 10^{-3}[\text{m}^2] \times \frac{355,0[\text{MPa}]}{\sqrt{3}}}{1,00} = 1139,88[\text{kN}]$$

$$\text{Unity check} = \frac{|V_{y,Ed}|}{V_{c,y,Rd}} = \frac{|28,08[\text{kN}]|}{1139,88[\text{kN}]} = \mathbf{0,02 \leq 1,00}$$

Shear check for V_z

According to EN 1993-1-1 article 6.2.6 and formula (6.17)

Shear correction factor	η	1,20	
Shear area	A_v	5,5615e-03	m ²
Plastic shear resistance for V_z	$V_{pl,z,Rd}$	1139,88	kN
Unity check		0,05	-

$$V_{pl,z,Rd} = \frac{A_v \times \frac{f_y}{\sqrt{3}}}{\gamma_{M0}} = \frac{5,5615 \cdot 10^{-3}[\text{m}^2] \times \frac{355,0[\text{MPa}]}{\sqrt{3}}}{1,00} = 1139,88[\text{kN}]$$

$$\text{Unity check} = \frac{|V_{z,Ed}|}{V_{c,z,Rd}} = \frac{|-61,39[\text{kN}]|}{1139,88[\text{kN}]} = \mathbf{0,05 \leq 1,00}$$

Torsion check

According to EN 1993-1-1 article 6.2.7 and formula (6.23)

Index of fibre	Fibre	1	
Total torsional moment	T_{Ed}	8,7	MPa
Elastic shear resistance	T_{Rd}	205,0	MPa
Unity check		0,04	-

$$\tau_{Ed} = \left| \frac{T_{Ed}}{T_{Ed,unit}} \times \tau_{Ed,unit} \right| = \left| \frac{13,23[\text{kNm}]}{1,00[\text{kNm}]} \times 658,613[\text{kN/m}^2] \right| = 8,7[\text{MPa}]$$

$$\tau_{Rd} = \frac{f_y}{\sqrt{3} \times \gamma_{M0}} = \frac{355,0[\text{MPa}]}{\sqrt{3} \times 1,00} = 205,0[\text{MPa}]$$

$$\text{Unity check} = \frac{\tau_{Ed}}{\tau_{Rd}} = \frac{8,7[\text{MPa}]}{205,0[\text{MPa}]} = \mathbf{0,04 \leq 1,00}$$

Note: The unity check for torsion is lower than the limit value of 0,05. Therefore torsion is considered as insignificant and is ignored in the combined checks.

Combined bending, axial force and shear force check

According to EN 1993-1-1 article 6.2.9.1 and formula (6.31)

Resultant bending moment	$M_{resultant}$	162,64	kNm
Resultant shear force	$V_{resultant}$	67,51	kN
Design plastic moment resistance reduced due to N_{Ed}	$M_{N,Rd}$	340,23	kNm
Unity check		0,48	-

$$n = \frac{|N_{Ed}|}{N_{pl,Rd}} = \frac{|-190,27[\text{kN}]|}{3101,28[\text{kN}]} = 0,06$$

$$M_{N,Rd} = M_{pl,Rd} \times (1 - n^{1,7}) = 343,21[\text{kNm}] \times (1 - 0,06^{1,7}) = 340,23[\text{kNm}]$$

$$\text{Unity check} = \frac{|M_{resultant}|}{M_{N,Rd}} = \frac{162,64[\text{kNm}]}{340,23[\text{kNm}]} = \mathbf{0,48 \leq 1,00}$$

Note: The resultant internal forces are used for CHS sections.

Note: Since the shear forces are less than half the plastic shear resistances their effect on the moment resistances is neglected.

The member satisfies the section check.

...:STABILITY CHECK:...:

Classification for member buckling design

Decisive position for stability classification: 0,000 m

Decisive utilisation factor η : 0,49

Classification according to EN 1993-1-1 article 5.5.2

Classification of Tubular sections according to EN 1993-1-1 Table 5.2 Sheet 3

d [mm]	t [mm]	d/t [-]	Class 1 Limit [-]	Class 2 Limit [-]	Class 3 Limit [-]	Class
356	8	44,5	33,1	46,3	59,6	2

The cross-section is classified as Class 2

Note: The decisive position for the stability classification is based on the utilisation factor η according to Semi-Comp+.

Flexural Buckling check

According to EN 1993-1-1 article 6.3.1.1 and formula (6.46)

Buckling parameters		yy	zz	
Sway type		sway	non-sway	
System length	L	4,508	4,508	m
Buckling factor	k	1,72	0,66	
Buckling length	l_{cr}	7,747	2,994	m

Buckling parameters		yy	zz	
Critical Euler load	N_{cr}	4559,12	30519,41	kN
Slenderness	λ	63,02	24,36	
Relative slenderness	λ_{rel}	0,82	0,32	
Limit slenderness	$\lambda_{rel,0}$	0,20	0,20	
Buckling curve		c	c	
Imperfection	α	0,49	0,49	
Reduction factor	χ	0,65	0,94	
Buckling resistance	$N_{b,Rd}$	1823,02	2648,91	kN

Flexural Buckling verification			
Cross-section area	A	8,7360e-03	m ²
Buckling resistance	$N_{b,Rd}$	1823,02	kN
Unity check		0,10	-

$$N_{cr,y} = \frac{\pi^2 \times E \times I_y}{l_{cr,y}^2} = \frac{\pi^2 \times 210000,0[\text{MPa}] \times 1,3201 \cdot 10^{-4}[\text{m}^4]}{7,747[\text{m}]^2} = 4559,12[\text{kN}]$$

$$N_{cr,z} = \frac{\pi^2 \times E \times I_z}{l_{cr,z}^2} = \frac{\pi^2 \times 210000,0[\text{MPa}] \times 1,3201 \cdot 10^{-4}[\text{m}^4]}{2,994[\text{m}]^2} = 30519,41[\text{kN}]$$

$$\lambda_y = \frac{l_{cr,y}}{i_y} = \frac{7,747[\text{m}]}{123[\text{mm}]} = 63,02$$

$$\lambda_z = \frac{l_{cr,z}}{i_z} = \frac{2,994[\text{m}]}{123[\text{mm}]} = 24,36$$

$$\lambda_{rel,y} = \frac{\lambda_y}{\pi \times \sqrt{\frac{E}{f_y}}} = \frac{63,02}{\pi \times \sqrt{\frac{210000,0[\text{MPa}]}{355,0[\text{MPa}]}}} = 0,82$$

$$\lambda_{rel,z} = \frac{\lambda_z}{\pi \times \sqrt{\frac{E}{f_y}}} = \frac{24,36}{\pi \times \sqrt{\frac{210000,0[\text{MPa}]}{355,0[\text{MPa}]}}} = 0,32$$

$$\varphi_y = 0,5 \times [1 + \alpha_y \times (\lambda_{rel,y} - \lambda_{rel,y,0}) + \lambda_{rel,y}^2] = 0,5 \times [1 + 0,49 \times (0,82 - 0,20) + 0,82^2] = 0,99$$

$$\varphi_z = 0,5 \times [1 + \alpha_z \times (\lambda_{rel,z} - \lambda_{rel,z,0}) + \lambda_{rel,z}^2] = 0,5 \times [1 + 0,49 \times (0,32 - 0,20) + 0,32^2] = 0,58$$

$$\chi_y = \min \left(\frac{1}{\varphi_y + \sqrt{\varphi_y^2 - \lambda_{rel,y}^2}}, 1 \right) = \min \left(\frac{1}{0,99 + \sqrt{0,99^2 - 0,82^2}}, 1 \right) = \min(0,65, 1) = 0,65$$

$$\chi_z = \min \left(\frac{1}{\varphi_z + \sqrt{\varphi_z^2 - \lambda_{rel,z}^2}}, 1 \right) = \min \left(\frac{1}{0,58 + \sqrt{0,58^2 - 0,32^2}}, 1 \right) = \min(0,94, 1) = 0,94$$

$$N_{b,y,Rd} = \frac{\chi_y \times A \times f_y}{\gamma_{M1}} = \frac{0,65 \times 8,7360 \cdot 10^{-3}[\text{m}^2] \times 355,0[\text{MPa}]}{1,10} = 1823,02[\text{kN}]$$

$$N_{b,z,Rd} = \frac{\chi_z \times A \times f_y}{\gamma_{M1}} = \frac{0,94 \times 8,7360 \cdot 10^{-3}[\text{m}^2] \times 355,0[\text{MPa}]}{1,10} = 2648,91[\text{kN}]$$

$$N_{b,Rd} = \min(N_{b,y,Rd}, N_{b,z,Rd}) = \min(1823,02[\text{kN}], 2648,91[\text{kN}]) = 1823,02[\text{kN}]$$

$$\text{Unity check} = \frac{|N_{Ed}|}{N_{b,Rd}} = \frac{|-190,27[\text{kN}]|}{1823,02[\text{kN}]} = 0,10 \leq 1,00$$

Torsional(-Flexural) Buckling check

According to EN 1993-1-1 article 6.3.1.1 and formula (6.46)

Note: The cross-section concerns a CHS section which is not susceptible to Torsional(-Flexural) Buckling.

Lateral Torsional Buckling check

According to EN 1993-1-1 article 6.3.2.1

Note: The cross-section concerns a CHS section which is not susceptible to Lateral Torsional Buckling.

Bending and axial compression check

According to EN 1993-1-1 article 6.3.3 and formula (6.61),(6.62)

Bending and axial compression check parameters			
Interaction method		alternative method 1	
Cross-section area	A	8,7360e-03	m ²
Plastic section modulus	W _{pl,y}	9,6680e-04	m ³
Plastic section modulus	W _{pl,z}	9,6680e-04	m ³
Design compression force	N _{Ed}	190,27	kN
Design bending moment (maximum)	M _{y,Ed}	162,63	kNm
Design bending moment (maximum)	M _{z,Ed}	95,35	kNm
Characteristic compression resistance	N _{Rk}	3101,28	kN
Characteristic moment resistance	M _{y,Rk}	343,21	kNm
Characteristic moment resistance	M _{z,Rk}	343,21	kNm
Reduction factor	χ _y	0,65	
Reduction factor	χ _z	0,94	
Reduction factor	χ _{LT}	1,00	
Interaction factor	k _{yy}	1,07	
Interaction factor	k _{yz}	0,60	
Interaction factor	k _{zy}	0,66	
Interaction factor	k _{zz}	1,01	

Maximum moment M_{y,Ed} is derived from beam B6203 position 0,000 m.

Maximum moment M_{z,Ed} is derived from beam B6203 position 4,508 m.

Interaction method 1 parameters			
Critical Euler load	N _{cr,y}	4559,12	kN
Critical Euler load	N _{cr,z}	30519,41	kN
Elastic critical load	N _{cr,T}	705626,73	kN
Plastic section modulus	W _{pl,y}	9,6680e-04	m ³
Elastic section modulus	W _{el,y}	7,4250e-04	m ³
Plastic section modulus	W _{pl,z}	9,6680e-04	m ³
Elastic section modulus	W _{el,z}	7,4250e-04	m ³
Second moment of area	I _y	1,3201e-04	m ⁴
Second moment of area	I _z	1,3201e-04	m ⁴
Torsional constant	I _t	2,6403e-04	m ⁴
Method for equivalent moment factor C _{my,0}		Table A.2 Line 2 (General)	
Design bending moment (maximum)	M _{y,Ed}	162,63	kNm
Maximum relative deflection	δ _z	23,2	mm
Equivalent moment factor	C _{my,0}	1,04	
Method for equivalent moment factor C _{mz,0}		Table A.2 Line 2 (General)	
Design bending moment (maximum)	M _{z,Ed}	95,35	kNm
Maximum relative deflection	δ _y	10,2	mm
Equivalent moment factor	C _{mz,0}	1,00	
Factor	μ _y	0,98	
Factor	μ _z	1,00	
Factor	ε _y	10,06	
Factor	a _{LT}	0,00	
Critical moment for uniform bending	M _{cr,0}	16944,23	kNm
Relative slenderness	λ _{rel,0}	0,14	
Limit relative slenderness	λ _{rel,0,lim}	0,33	
Equivalent moment factor	C _{my}	1,04	
Equivalent moment factor	C _{mz}	1,00	
Equivalent moment factor	C _{mLT}	1,00	

Interaction method 1 parameters		
Factor	b_{LT}	0,00
Factor	c_{LT}	0,00
Factor	d_{LT}	0,00
Factor	e_{LT}	0,00
Factor	w_y	1,30
Factor	w_z	1,30
Factor	η_{pl}	0,07
Maximum relative slenderness	$\lambda_{rel,max}$	0,82
Factor	C_{yy}	1,00
Factor	C_{yz}	0,99
Factor	C_{zy}	0,98
Factor	C_{zz}	1,00

$$\text{Unity check (6.61)} = 0,10 + 0,56 + 0,18 = 0,84 -$$

$$\text{Unity check (6.62)} = 0,07 + 0,34 + 0,31 = 0,72 -$$

$$N_{cr,y} = \frac{\pi^2 \times E \times I_y}{l_{cr,y}^2} = \frac{\pi^2 \times 210000,0[\text{MPa}] \times 1,3201 \cdot 10^{-4}[\text{m}^4]}{7,747[\text{m}]^2} = 4559,12[\text{kN}]$$

$$N_{cr,z} = \frac{\pi^2 \times E \times I_z}{l_{cr,z}^2} = \frac{\pi^2 \times 210000,0[\text{MPa}] \times 1,3201 \cdot 10^{-4}[\text{m}^4]}{2,994[\text{m}]^2} = 30519,41[\text{kN}]$$

$$N_{cr,T} = \frac{1}{i_0^2} \times \left(G \times I_t + \frac{\pi^2 \times E \times I_w}{l_{cr}^2} \right) = \frac{1}{174[\text{mm}]^2} \times \left(80769,2[\text{MPa}] \times 2,6403 \cdot 10^{-4}[\text{m}^4] + \frac{\pi^2 \times 210000,0[\text{MPa}] \times 7,8644 \cdot 10^{-39}[\text{m}^6]}{4,508[\text{m}]^2} \right) = 705626,73[\text{kN}]$$

$$C_{m,y,0} = 1 + \left(\frac{\pi^2 \times E \times I_y \times |\delta_z|}{L^2 \times |M_{y,Ed}|} - 1 \right) \times \frac{|N_{Ed}|}{N_{cr,y}} = 1 + \left(\frac{\pi^2 \times 210000,0[\text{MPa}] \times 1,3201 \cdot 10^{-4}[\text{m}^4] \times |23,2[\text{mm}]|}{4,508[\text{m}]^2 \times |162,63[\text{kNm}]|} - 1 \right) \times \frac{|190,27[\text{kN}]|}{4559,12[\text{kN}]} = 1,04$$

$$C_{m,z,0} = 1 + \left(\frac{\pi^2 \times E \times I_z \times |\delta_y|}{L^2 \times |M_{z,Ed}|} - 1 \right) \times \frac{|N_{Ed}|}{N_{cr,z}} = 1 + \left(\frac{\pi^2 \times 210000,0[\text{MPa}] \times 1,3201 \cdot 10^{-4}[\text{m}^4] \times |10,2[\text{mm}]|}{4,508[\text{m}]^2 \times |95,35[\text{kNm}]|} - 1 \right) \times \frac{|190,27[\text{kN}]|}{30519,41[\text{kN}]} = 1,00$$

$$\mu_y = \frac{1 - \frac{|N_{Ed}|}{N_{cr,y}}}{1 - \frac{\chi_y \times |N_{Ed}|}{N_{cr,y}}} = \frac{1 - \frac{|190,27[\text{kN}]|}{4559,12[\text{kN}]}}{1 - \frac{0,65 \times |190,27[\text{kN}]|}{4559,12[\text{kN}]}} = 0,98$$

$$\mu_z = \frac{1 - \frac{|N_{Ed}|}{N_{cr,z}}}{1 - \frac{\chi_z \times |N_{Ed}|}{N_{cr,z}}} = \frac{1 - \frac{|190,27[\text{kN}]|}{30519,41[\text{kN}]}}{1 - \frac{0,94 \times |190,27[\text{kN}]|}{30519,41[\text{kN}]}} = 1,00$$

$$\varepsilon_y = \left| \frac{M_{y,Ed}}{N_{Ed}} \right| \times \frac{A}{W_{el,y}} = \left| \frac{162,63[\text{kNm}]}{190,27[\text{kN}]} \right| \times \frac{8,7360 \cdot 10^{-3}[\text{m}^2]}{7,4250 \cdot 10^{-4}[\text{m}^3]} = 10,06$$

$$a_{LT} = \max \left(1 - \frac{l_t}{l_y}, 0 \right) = \max \left(1 - \frac{2,6403 \cdot 10^{-4}[\text{m}^4]}{1,3201 \cdot 10^{-4}[\text{m}^4]}, 0 \right) = \max(-1,00, 0,00) = 0,00$$

$$M_{cr,0} = \frac{C_1 \times \pi^2 \times E \times I_z}{(k \times l_{LT})^2} \times \left[\sqrt{\frac{\left(\frac{k}{k_w} \right)^2 \times I_w}{I_z} + \frac{(k \times l_{LT})^2 \times G \times I_t}{\pi^2 \times E \times I_z} + (C_2 \times z_g - C_3 \times z_j)^2} - (C_2 \times z_g - C_3 \times z_j) \right]$$

$$= \frac{1,00 \times \pi^2 \times 210000,0[\text{MPa}] \times 1,3201 \cdot 10^{-4}[\text{m}^4]}{(1,00 \times 4,508[\text{m}])^2}$$

$$\times \left[\sqrt{\frac{\left(\frac{1,00}{1,00} \right)^2 \times 7,8644 \cdot 10^{-39}[\text{m}^6]}{1,3201 \cdot 10^{-4}[\text{m}^4]} + \frac{(1,00 \times 4,508[\text{m}])^2 \times 80769,2[\text{MPa}] \times 2,6403 \cdot 10^{-4}[\text{m}^4]}{\pi^2 \times 210000,0[\text{MPa}] \times 1,3201 \cdot 10^{-4}[\text{m}^4]} + (0,26 \times 0[\text{mm}] - 1,00 \times 0[\text{mm}])^2} - (0,26 \times 0[\text{mm}] - 1,00 \times 0[\text{mm}]) \right]$$

$$= 16944,23[\text{kNm}]$$

$$\lambda_{rel,0} = \sqrt{\frac{W_{pl,y} \times f_y}{M_{cr,0}}} = \sqrt{\frac{9,6680 \cdot 10^{-4}[\text{m}^3] \times 355,0[\text{MPa}]}{16944,23[\text{kNm}]} = 0,14$$

$$\lambda_{rel,0,lim} = 0,2 \times \sqrt{C_1} \times \sqrt[4]{\left(1 - \frac{|N_{Ed}|}{N_{cr,z}}\right) \times \left(1 - \frac{|N_{Ed}|}{N_{cr,T}}\right)} = 0,2 \times \sqrt{2,80} \times \sqrt[4]{\left(1 - \frac{|190,27[\text{kN}]|}{30519,41[\text{kN}]}\right) \times \left(1 - \frac{|190,27[\text{kN}]|}{705626,73[\text{kN}]}\right)} = 0,33$$

$$C_{my} = C_{my,0} = 1,04$$

$$C_{mz} = C_{mz,0} = 1,00$$

$$C_{mLT} = 1,00$$

$$b_{LT} = 0,5 \times a_{LT} \times \lambda_{rel,0}^2 \times \frac{|M_{y,Ed}|}{\chi_{LT} \times M_{pl,y,Rd}} \times \frac{|M_{z,Ed}|}{M_{pl,z,Rd}} = 0,5 \times 0,00 \times 0,14^2 \times \frac{|162,63[\text{kNm}]|}{1,00 \times 343,21[\text{kNm}]} \times \frac{|95,35[\text{kNm}]|}{343,21[\text{kNm}]} = 0,00$$

$$c_{LT} = 10 \times a_{LT} \times \frac{\lambda_{rel,0}^2}{5 + \lambda_{rel,z}^4} \times \frac{|M_{y,Ed}|}{C_{my} \times \chi_{LT} \times M_{pl,y,Rd}} = 10 \times 0,00 \times \frac{0,14^2}{5 + 0,32^4} \times \frac{|162,63[\text{kNm}]|}{1,04 \times 1,00 \times 343,21[\text{kNm}]} = 0,00$$

$$d_{LT} = 2 \times a_{LT} \times \frac{\lambda_{rel,0}}{0,1 + \lambda_{rel,z}^4} \times \frac{|M_{y,Ed}|}{C_{my} \times \chi_{LT} \times M_{pl,y,Rd}} \times \frac{|M_{z,Ed}|}{C_{mz} \times M_{pl,z,Rd}}$$

$$= 2 \times 0,00 \times \frac{0,14}{0,1 + 0,32^4} \times \frac{|162,63[\text{kNm}]|}{1,04 \times 1,00 \times 343,21[\text{kNm}]} \times \frac{|95,35[\text{kNm}]|}{1,00 \times 343,21[\text{kNm}]} = 0,00$$

$$e_{LT} = 1,7 \times a_{LT} \times \frac{\lambda_{rel,0}}{0,1 + \lambda_{rel,z}^4} \times \frac{|M_{y,Ed}|}{C_{my} \times \chi_{LT} \times M_{pl,y,Rd}} = 1,7 \times 0,00 \times \frac{0,14}{0,1 + 0,32^4} \times \frac{|162,63[\text{kNm}]|}{1,04 \times 1,00 \times 343,21[\text{kNm}]} = 0,00$$

$$w_y = \min\left(\frac{W_{pl,y}}{W_{el,y}}, 1,5\right) = \min\left(\frac{9,6680 \cdot 10^{-4}[\text{m}^3]}{7,4250 \cdot 10^{-4}[\text{m}^3]}, 1,5\right) = \min(1,30, 1,50) = 1,30$$

$$w_z = \min\left(\frac{W_{pl,z}}{W_{el,z}}, 1,5\right) = \min\left(\frac{9,6680 \cdot 10^{-4}[\text{m}^3]}{7,4250 \cdot 10^{-4}[\text{m}^3]}, 1,5\right) = \min(1,30, 1,50) = 1,30$$

$$n_{pl} = \frac{|N_{Ed}|}{\frac{N_{Rk}}{\gamma_{M1}}} = \frac{|190,27[\text{kN}]|}{\frac{3101,28[\text{kN}]}{1,10}} = 0,07$$

$$\lambda_{rel,max} = \max(\lambda_{rel,y}, \lambda_{rel,z}) = \max(0,82, 0,32) = 0,82$$

$$C_{yy} = \max\left\{1 + (w_y - 1) \times \left[\left(2 - \frac{1,6}{w_y} \times C_{my}^2 \times \lambda_{rel,max} - \frac{1,6}{w_y} \times C_{my}^2 \times \lambda_{rel,max}^2\right) \times n_{pl} - b_{LT}\right], \frac{W_{el,y}}{W_{pl,y}}\right\}$$

$$= \max\left\{1 + (1,30 - 1) \times \left[\left(2 - \frac{1,6}{1,30} \times 1,04^2 \times 0,82 - \frac{1,6}{1,30} \times 1,04^2 \times 0,82^2\right) \times 0,07 - 0,00\right], \frac{7,4250 \cdot 10^{-4}[\text{m}^3]}{9,6680 \cdot 10^{-4}[\text{m}^3]}\right\} = \max\{1,00, 0,77\}$$

$$= 1,00$$

$$C_{yz} = \max\left\{1 + (w_z - 1) \times \left[\left(2 - 14 \times \frac{C_{mz}^2 \times \lambda_{rel,max}^2}{w_z^5}\right) \times n_{pl} - c_{LT}\right], 0,6 \times \sqrt{\frac{w_z}{w_y}} \times \frac{W_{el,z}}{W_{pl,z}}\right\}$$

$$= \max\left\{1 + (1,30 - 1) \times \left[\left(2 - 14 \times \frac{1,00^2 \times 0,82^2}{1,30^5}\right) \times 0,07 - 0,00\right], 0,6 \times \sqrt{\frac{1,30}{1,30}} \times \frac{7,4250 \cdot 10^{-4}[\text{m}^3]}{9,6680 \cdot 10^{-4}[\text{m}^3]}\right\} = \max\{0,99, 0,46\} = 0,99$$

$$C_{zy} = \max\left\{1 + (w_y - 1) \times \left[\left(2 - 14 \times \frac{C_{my}^2 \times \lambda_{rel,max}^2}{w_y^5}\right) \times n_{pl} - d_{LT}\right], 0,6 \times \sqrt{\frac{w_y}{w_z}} \times \frac{W_{el,y}}{W_{pl,y}}\right\}$$

$$= \max\left\{1 + (1,30 - 1) \times \left[\left(2 - 14 \times \frac{1,04^2 \times 0,82^2}{1,30^5}\right) \times 0,07 - 0,00\right], 0,6 \times \sqrt{\frac{1,30}{1,30}} \times \frac{7,4250 \cdot 10^{-4}[\text{m}^3]}{9,6680 \cdot 10^{-4}[\text{m}^3]}\right\} = \max\{0,98, 0,46\} = 0,98$$

$$C_{zz} = \max \left[1 + (w_z - 1) \times \left(2 - \frac{1,6}{w_z} \times C_{mz}^2 \times \lambda_{rel,max} - \frac{1,6}{w_z} \times C_{mz}^2 \times \lambda_{rel,max}^2 - e_{LT} \right) \times n_{pl}, \frac{W_{el,z}}{W_{pl,z}} \right]$$

$$= \max \left[1 + (1,30 - 1) \times \left(2 - \frac{1,6}{1,30} \times 1,00^2 \times 0,82 - \frac{1,6}{1,30} \times 1,00^2 \times 0,82^2 - 0,00 \right) \times 0,07, \frac{7,4250 \cdot 10^{-4} [m^3]}{9,6680 \cdot 10^{-4} [m^3]} \right] = \max [1,00, 0,77] = 1,00$$

$$N_{Rk} = A \times f_y = 8,7360 \cdot 10^{-3} [m^2] \times 355,0 [MPa] = 3101,28 [kN]$$

$$M_{y,Rk} = W_{pl,y} \times f_y = 9,6680 \cdot 10^{-4} [m^3] \times 355,0 [MPa] = 343,21 [kNm]$$

$$M_{z,Rk} = W_{pl,z} \times f_y = 9,6680 \cdot 10^{-4} [m^3] \times 355,0 [MPa] = 343,21 [kNm]$$

$$k_{yy} = C_{my} \times C_{mLT} \times \frac{\mu_y}{1 - \frac{|N_{Ed}|}{N_{cr,y}}} \times \frac{1}{C_{yy}} = 1,04 \times 1,00 \times \frac{0,98}{1 - \frac{190,27 [kN]}{4559,12 [kN]}} \times \frac{1}{1,00} = 1,07$$

$$k_{yz} = C_{mz} \times \frac{\mu_y}{1 - \frac{|N_{Ed}|}{N_{cr,z}}} \times \frac{1}{C_{yz}} \times 0,6 \times \sqrt{\frac{w_z}{w_y}} = 1,00 \times \frac{0,98}{1 - \frac{190,27 [kN]}{30519,41 [kN]}} \times \frac{1}{0,99} \times 0,6 \times \sqrt{\frac{1,30}{1,30}} = 0,60$$

$$k_{zy} = C_{my} \times C_{mLT} \times \frac{\mu_z}{1 - \frac{|N_{Ed}|}{N_{cr,y}}} \times \frac{1}{C_{zy}} \times 0,6 \times \sqrt{\frac{w_y}{w_z}} = 1,04 \times 1,00 \times \frac{1,00}{1 - \frac{190,27 [kN]}{4559,12 [kN]}} \times \frac{1}{0,98} \times 0,6 \times \sqrt{\frac{1,30}{1,30}} = 0,66$$

$$k_{zz} = C_{mz} \times \frac{\mu_z}{1 - \frac{|N_{Ed}|}{N_{cr,z}}} \times \frac{1}{C_{zz}} = 1,00 \times \frac{1,00}{1 - \frac{190,27 [kN]}{30519,41 [kN]}} \times \frac{1}{1,00} = 1,01$$

$$\text{Unity check (6.61)} = \frac{|N_{Ed}|}{\chi_y \times \frac{N_{Rk}}{\gamma_{M1}}} + k_{yy} \times \frac{|M_{y,Ed}| + |\Delta M_{y,Ed}|}{\chi_{LT} \times \frac{M_{y,Rk}}{\gamma_{M1}}} + k_{yz} \times \frac{|M_{z,Ed}| + |\Delta M_{z,Ed}|}{\frac{M_{z,Rk}}{\gamma_{M1}}}$$

$$= \frac{190,27 [kN]}{0,65 \times \frac{3101,28 [kN]}{1,10}} + 1,07 \times \frac{162,63 [kNm] + |0,00 [kNm]|}{1,00 \times \frac{343,21 [kNm]}{1,10}} + 0,60 \times \frac{95,35 [kNm] + |0,00 [kNm]|}{\frac{343,21 [kNm]}{1,10}} = \mathbf{0,84} \leq \mathbf{1,00}$$

$$\text{Unity check (6.62)} = \frac{|N_{Ed}|}{\chi_z \times \frac{N_{Rk}}{\gamma_{M1}}} + k_{zy} \times \frac{|M_{y,Ed}| + |\Delta M_{y,Ed}|}{\chi_{LT} \times \frac{M_{y,Rk}}{\gamma_{M1}}} + k_{zz} \times \frac{|M_{z,Ed}| + |\Delta M_{z,Ed}|}{\frac{M_{z,Rk}}{\gamma_{M1}}}$$

$$= \frac{190,27 [kN]}{0,94 \times \frac{3101,28 [kN]}{1,10}} + 0,66 \times \frac{162,63 [kNm] + |0,00 [kNm]|}{1,00 \times \frac{343,21 [kNm]}{1,10}} + 1,01 \times \frac{95,35 [kNm] + |0,00 [kNm]|}{\frac{343,21 [kNm]}{1,10}} = \mathbf{0,72} \leq \mathbf{1,00}$$

$$\text{Unity check} = \max(\text{Unity check (6.61)}, \text{Unity check (6.62)}) = \max(0,84, 0,72) = \mathbf{0,84} \leq \mathbf{1,00}$$

The member satisfies the stability check.

4.5.3. Granično stanje uporabljivosti

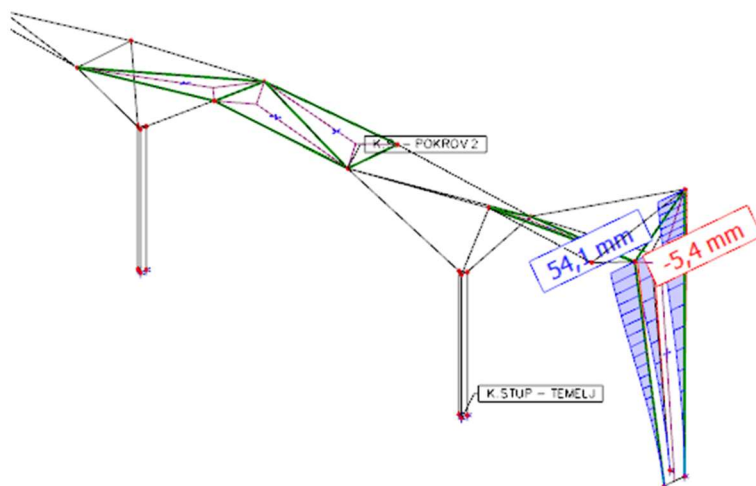

Slika 95: Prikaz pomaka trostrukih stupova „S1“ (mm)

	u_z
Maksimalni pomak $u =$	54,1 mm
Duljina nosača $L =$	16,00 m
Dopušteni pomak $f_{p,dop.} =$	106,7 mm ($L/200$)

$$f_{max.} = 54,1 \text{ mm} < f_{p,dop.} = 106,7 \text{ mm}$$

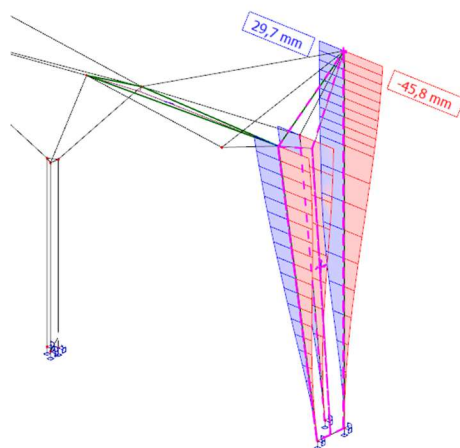

Slika 96: Prikaz pomaka trostrukih stupova „S1“ (mm)

	u_z
Maksimalni pomak $u =$	45,8 mm
Duljina nosača $L =$	16,00 m
Dopušteni pomak $f_{p,dop.} =$	106,7 mm ($L/200$)

$$f_{max.} = 45,8 \text{ mm} < f_{p,dop.} = 106,7 \text{ mm}$$

5. Dimenzioniranje spojeva

5.1. Spoj stupa „S1“ sa temeljem

Design

Name	Con N5781
Description	
Analysis	Stress, strain/ loads in equilibrium

Beams and columns

Name	Cross-section	β - Direction [°]	γ - Pitch [°]	α - Rotation [°]	Offset ex [mm]	Offset ey [mm]	Offset ez [mm]	Forces in
B5640	1 - CHS(cf)219.1/12.5	0.0	0.0	0.0	0	0	0	Position
M12480	1 - CHS(cf)219.1/12.5	90.0	-90.0	0.0	0	0	430	Position
M12481	1 - CHS(cf)219.1/12.5	0.0	-90.0	0.0	0	-215	-370	Position

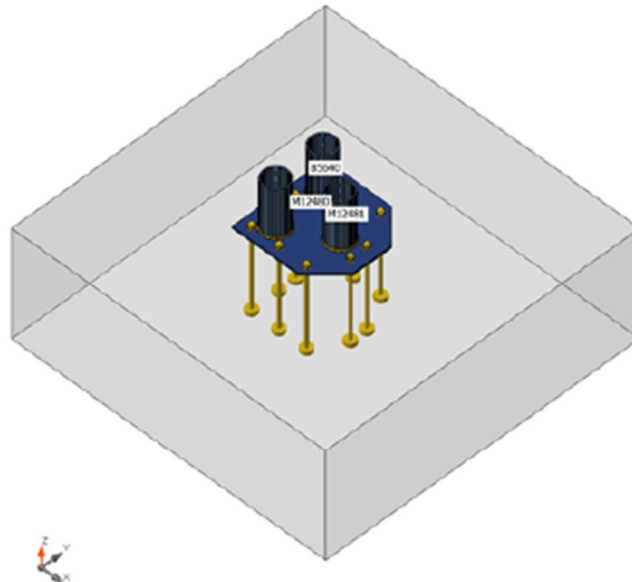

Cross-sections

Name	Material
1 - CHS(cf)219.1/12.5	S 355

Anchors

Name	Bolt assembly	Diameter [mm]	f_u [MPa]	Gross area [mm ²]
M30 10.9	M30 10.9	30	1000.0	707

Load effects (forces in equilibrium)

Name	Member	N [kN]	Vy [kN]	Vz [kN]	Mx [kNm]	My [kNm]	Mz [kNm]
ULS-Set(2)	B5640	-176.6	8.0	1.8	2.4	-8.0	33.4
	M12480	-176.6	8.0	1.8	2.4	-8.0	33.4
	M12481	-176.6	8.0	1.8	2.4	-8.0	33.4
ULS-Set(6)	B5640	-169.0	3.9	2.1	4.5	-9.2	17.2
	M12480	-169.0	3.9	2.1	4.5	-9.2	17.2
	M12481	-169.0	3.9	2.1	4.5	-9.2	17.2
ULS-Set(7)	B5640	-132.4	6.9	1.5	1.2	-6.7	28.6
	M12480	-132.4	6.9	1.5	1.2	-6.7	28.6
	M12481	-132.4	6.9	1.5	1.2	-6.7	28.6
ULS-Set(10)	B5640	-150.8	3.4	0.1	4.4	-0.1	15.3
	M12480	-150.8	3.4	0.1	4.4	-0.1	15.3
	M12481	-150.8	3.4	0.1	4.4	-0.1	15.3
ULS-Set(11)	B5640	-158.1	7.7	-0.2	2.4	1.0	32.0
	M12480	-158.1	7.7	-0.2	2.4	1.0	32.0
	M12481	-158.1	7.7	-0.2	2.4	1.0	32.0
ULS-Set(18)	B5640	-169.3	3.7	2.1	4.5	-9.2	16.7
	M12480	-169.3	3.7	2.1	4.5	-9.2	16.7
	M12481	-169.3	3.7	2.1	4.5	-9.2	16.7
S18-1.	B5640	-273.9	-8.1	29.9	-0.5	71.9	19.8
	M12480	-273.9	-8.1	29.9	-0.5	71.9	19.8
	M12481	-273.9	-8.1	29.9	-0.5	71.9	19.8
S18-2.	B5640	-273.9	-5.5	19.6	-0.5	71.9	15.8
	M12480	-273.9	-5.5	19.6	-0.5	71.9	15.8
	M12481	-273.9	-5.5	19.6	-0.5	71.9	15.8
S18-3.	B5640	54.0	7.0	-23.5	-0.5	71.9	-12.2
	M12480	54.0	7.0	-23.5	-0.5	71.9	-12.2
	M12481	54.0	7.0	-23.5	-0.5	71.9	-12.2
S18-4.	B5640	-272.2	-5.7	27.4	-0.5	71.9	14.6
	M12480	-272.2	-5.7	27.4	-0.5	71.9	14.6
	M12481	-272.2	-5.7	27.4	-0.5	71.9	14.6

Foundation block

Item	Value	Unit
CB 1		
Dimensions	2850 x 2850	mm
Depth	1000	mm
Anchor	M30 10.9	
Anchoring length	700	mm
Shear force transfer	Friction	

Check**Summary**

Name	Value	Status
Analysis	100.0%	OK
Plates	0.6 < 5.0%	OK
Anchors	69.3 < 100%	OK
Welds	98.4 < 100%	OK
Concrete block	63.7 < 100%	OK
Shear	25.7 < 100%	OK
Buckling	Not calculated	

Plates

Name	Thickness [mm]	Loads	σ_{Ed} [MPa]	ϵ_{pl} [%]	σ_{cEd} [MPa]	Status
B5640	12.5	S18-3.	306.3	0.0	0.0	OK
M12480	12.5	S18-3.	294.5	0.0	0.0	OK
M12481	12.5	S18-3.	355.5	0.3	0.0	OK
SP1	20.0	S18-3.	356.3	0.6	0.0	OK

Design data

Material	f_y [MPa]	ϵ_{lim} [%]
S 355	355.0	5.0

Symbol explanation

ϵ_{pl}	Strain
σ_{Ed}	Eq. stress
σ_{cEd}	Contact stress
f_y	Yield strength
ϵ_{lim}	Limit of plastic strain

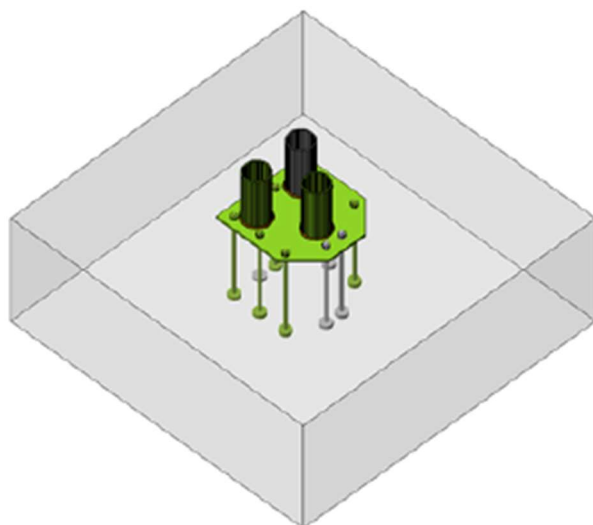

Overall check, S18-3.



Strain check, S18-3.

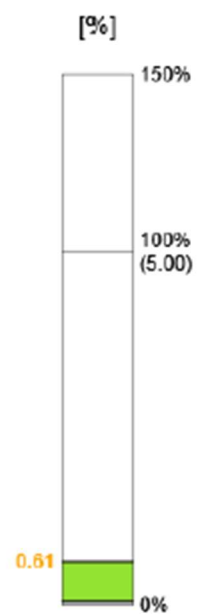

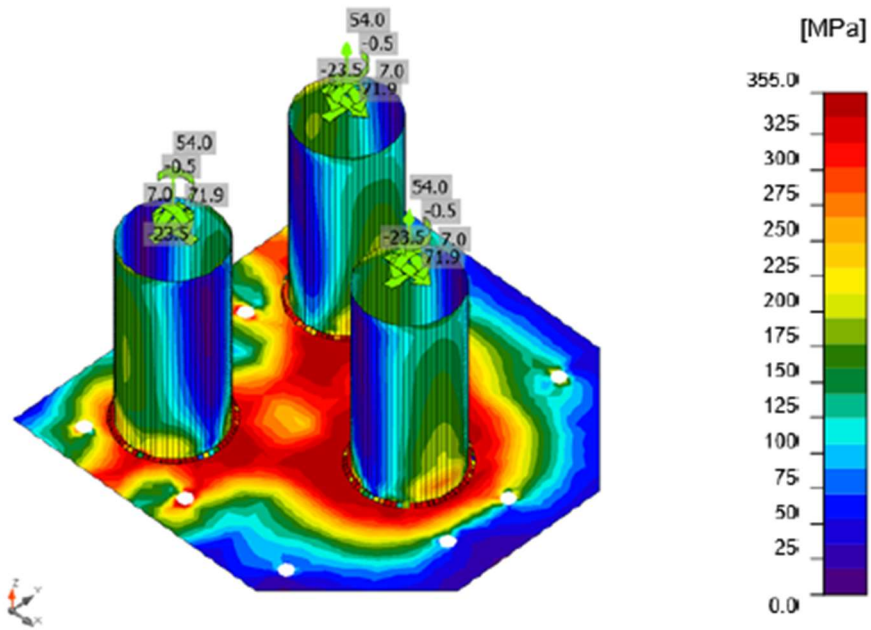

Equivalent stress, S18-3.

Anchors

Shape	Item	Loads	N_{Ed} [kN]	V_{Ed} [kN]	$N_{Rd,c}$ [kN]	$N_{Rd,p}$ [kN]	$N_{Rd,cb}$ [kN]	$V_{Rd,cp}$ [kN]	U_{t1} [%]	U_{t2} [%]	U_{t3} [%]	Status
	A9	S18-3.	234.9	0.0	1305.6	893.4	-	2060.6	69.0	0.0	53.6	OK
	A10	S18-3.	50.8	0.0	1305.6	893.4	-	2060.6	66.0	0.0	53.6	OK
	A11	S18-3.	158.4	0.0	1305.6	893.4	-	2060.6	66.0	0.0	53.6	OK
	A12	ULS-Set(2)	1.5	0.0	1296.3	893.4	-	2060.6	18.0	0.0	7.6	OK
	A13	ULS-Set(2)	12.5	0.0	1296.3	893.4	-	2060.6	18.0	0.0	7.6	OK
	A14	ULS-Set(2)	56.3	0.0	1296.3	893.4	-	2060.6	18.0	0.0	7.6	OK
	A15	S18-3.	236.1	0.0	1305.6	893.4	-	2060.6	69.3	0.0	53.6	OK
	A16	S18-3.	24.6	0.0	1305.6	893.4	-	2060.6	66.0	0.0	53.6	OK
	A17	S18-3.	156.4	0.0	1305.6	893.4	-	2060.6	66.0	0.0	53.6	OK
	A18	ULS-Set(2)	1.1	0.0	1296.3	893.4	-	2060.6	18.0	0.0	7.6	OK

Design data

Grade	$N_{Rd,s}$ [kN]	$V_{Rd,s}$ [kN]
M30 10.9 - 1	340.6	187.0

Symbol explanation

N_{Ed}	Tension force
V_{Ed}	Resultant of shear forces V_y, V_z in bolt
$N_{Rd,c}$	Design resistance in case of concrete cone failure under tension load - EN1992-4 - Cl. 7.2.1.4
$N_{Rd,p}$	Design resistance in case of pull-out failure - EN1992-4 - Cl. 7.2.1.5
$N_{Rd,cb}$	Design resistance in case of concrete blow-out failure - EN1992-4 - Cl. 7.2.1.8
$V_{Rd,cp}$	Design resistance in case of concrete pryout failure - EN1992-4 - Cl. 7.2.2.4
U_t	Utilization in tension
U_s	Utilization in shear
U_{ts}	Utilization in tension and shear
$N_{Rd,s}$	Design tensile resistance of a fastener in case of steel failure - EN1992-4 - Cl. 7.2.1.3
$V_{Rd,s}$	Design shear resistance in case of steel failure - EN1992-4 - Cl.7.2.2.3.1

Welds (Plastic redistribution)

Item	Edge	Throat th. [mm]	Length [mm]	Loads	$\sigma_{w,Ed}$ [MPa]	ϵ_{pl} [%]	σ_{\perp} [MPa]	τ_{\parallel} [MPa]	τ_{\perp} [MPa]	U_t [%]	U_{tc} [%]	Status
SP1	B5640	▲8.7	649	S18-3.	428.3	0.8	-280.3	-33.9	193.4	98.3	76.6	OK
SP1	M12480	▲8.7	649	S18-3.	427.9	0.6	256.0	16.8	-197.2	98.2	71.9	OK
SP1	M12481	▲8.7	649	S18-1.	428.6	1.0	-248.7	41.7	197.2	98.4	71.9	OK

Design data

	β_w [-]	$\sigma_{w,Rd}$ [MPa]	0.9σ [MPa]
S 355	0.90	435.6	352.8

Symbol explanation

ϵ_{pl}	Strain
$\sigma_{w,Ed}$	Equivalent stress
$\sigma_{w,Rd}$	Equivalent stress resistance
σ_{\perp}	Perpendicular stress
τ_{\parallel}	Shear stress parallel to weld axis
τ_{\perp}	Shear stress perpendicular to weld axis
0.9σ	Perpendicular stress resistance - $0.9 \cdot f_u / \gamma_{M2}$
β_w	Corelation factor EN 1993-1-8 tab. 4.1
U_t	Utilization
U_{tc}	Weld capacity utilization

Concrete block

Item	Loads	c [mm]	A_{eff} [mm ²]	σ [MPa]	k_j [-]	F_{jd} [MPa]	U_t [%]	Status
CB 1	S18-1.	34	59427	25.6	3.00	40.2	63.7	OK

Symbol explanation

c	Bearing width
A_{eff}	Effective area
σ	Average stress in concrete
k_j	Concentration factor
F_{jd}	The ultimate bearing strength of the concrete block
Ut	Utilization

Shear in contact plane

Name	Loads	V_y [kN]	V_z [kN]	$V_{Rd,y}$ [kN]	$V_{Rd,z}$ [kN]	$V_{c,Rd}$ [kN]	Ut [%]	Status
SP1	S18-3.	40.0	37.4	213.1	213.1	0.0	25.7	OK

Symbol explanation

V_y	Shear force in base plate V_y
V_z	Shear force in base plate V_z
$V_{Rd,y}$	Shear resistance
$V_{Rd,z}$	Shear resistance
$V_{c,Rd}$	Concrete bearing resistance
Ut	Utilization

Buckling

Buckling analysis was not calculated.

Code settings

Item	Value	Unit	Reference
YM0	1.00	-	EN 1993-1-1: 6.1
YM1	1.00	-	EN 1993-1-1: 6.1
YM2	1.25	-	EN 1993-1-1: 6.1
YM3	1.25	-	EN 1993-1-8: 2.2
YC	1.50	-	EN 1992-1-1: 2.4.2.4
Yinst	1.20	-	EN 1992-4: Table 4.1
Joint coefficient β_j	0.67	-	EN 1993-1-8: 6.2.5
Effective area - influence of mesh size	0.10	-	
Friction coefficient - concrete	0.25	-	EN 1993-1-8
Friction coefficient in slip-resistance	0.30	-	EN 1993-1-8 tab 3.7
Limit plastic strain	0.05	-	EN 1993-1-5
Weld stress evaluation	Plastic redistribution		
Detailing	No		
Distance between bolts [d]	2.20	-	EN 1993-1-8: tab 3.3
Distance between bolts and edge [d]	1.20	-	EN 1993-1-8: tab 3.3
Concrete breakout resistance check	Both		EN 1992-4: 7.2.1.4 and 7.2.2.5
Use calculated ab in bearing check.	Yes		EN 1993-1-8: tab 3.4
Cracked concrete	Yes		EN 1992-4

Item	Value	Unit	Reference
Local deformation check	No		CIDECT DG 1, 3 - 1.1
Local deformation limit	0.03	-	CIDECT DG 1, 3 - 1.1
Geometrical nonlinearity (GMNA)	Yes		Analysis with large deformations for hollow section joints
Braoed system	No		EN 1993-1-8: 5.2.2.5

5.2. Spoj stupa „S2“ sa temeljem

Design

Name	Con N5908
Description	
Analysis	Stress, strain/ loads in equilibrium

Beams and columns

Name	Cross-section	β - Direction [°]	γ - Pitch [°]	α - Rotation [°]	Offset ex [mm]	Offset ey [mm]	Offset ez [mm]	Forces in
B5570	1 - Massive O Hollow(CHS273,8)	0.0	0.0	0.0	-75	0	200	Position
B5581	1 - Massive O Hollow(CHS273,8)	0.0	0.0	0.0	75	0	200	Position
B6084	2 - CHS(cf)355,6/8,0	0.0	0.0	0.0	0	0	0	Position

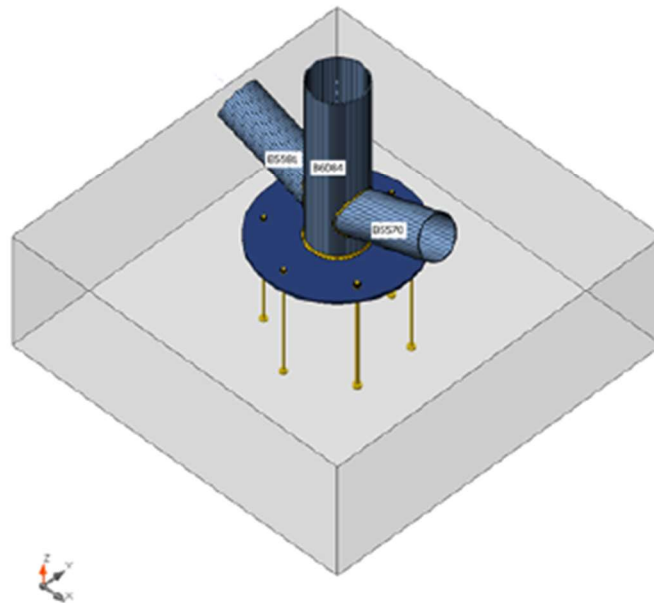

Cross-sections

Name	Material
1 - Massive O Hollow(CHS273,8)	S 355
2 - CHS(cf)355,6/8,0	S 355

Anchors

Name	Bolt assembly	Diameter [mm]	fu [MPa]	Gross area [mm ²]
M20 10.9	M20 10.9	20	1000.0	314

Load effects (forces in equilibrium)

Name	Member	N [kN]	Vy [kN]	Vz [kN]	Mx [kNm]	My [kNm]	Mz [kNm]
ULS-Set(2)	B5570	332.3	-1.8	2.1	2.7	20.6	11.5
	B5581	-355.5	0.8	-4.2	4.7	17.9	1.4
	B6084	68.3	7.4	-34.1	-8.7	-98.0	-48.7
ULS-Set(3)	B5570	262.0	-2.1	1.1	2.1	16.1	11.7
	B5581	-317.4	-0.2	-3.9	3.9	15.2	-3.1
	B6084	54.0	9.2	-27.3	-5.8	-79.1	-51.4
ULS-Set(5)	B5570	318.3	-1.5	2.3	1.6	22.7	9.7
	B5581	-298.1	0.6	-4.2	4.1	17.9	-1.0
	B6084	43.6	1.5	-31.9	-5.5	-96.5	-35.2
ULS-Set(6)	B5570	294.9	-1.4	2.8	1.3	22.7	9.0
	B5581	-267.9	0.5	-3.4	3.9	16.0	-1.3
	B6084	33.5	0.6	-30.2	-4.9	-91.9	-31.8
ULS-Set(16)	B5570	331.4	-1.7	2.0	2.7	20.2	11.2
	B5581	-336.4	0.8	-4.2	4.6	17.7	0.9
	B6084	66.4	7.1	-31.7	-8.1	-92.8	-48.3
ULS-Set(22)	B5570	308.9	-1.7	2.6	2.5	20.6	10.8
	B5581	-325.3	0.8	-3.3	4.4	16.0	1.1
	B6084	58.2	6.5	-32.5	-8.0	-93.4	-45.2

Foundation block

Item	Value	Unit
CB 1		
Dimensions	2400 x 2400	mm
Depth	800	mm
Anchor	M20 10.9	
Anchoring length	700	mm
Shear force transfer	Anchors	

Check

Summary

Name	Value	Status
Analysis	100.0%	OK
Plates	0.4 < 5.0%	OK
Anchors	93.4 < 100%	OK
Welds	98.1 < 100%	OK
Concrete block	98.6 < 100%	OK
Buckling	Not calculated	

Plates

Name	Thickness [mm]	Loads	σ_{Ed} [MPa]	ϵ_{pl} [%]	σ_{cEd} [MPa]	Status
B5570	8.0	ULS-Set(2)	342.3	0.0	0.0	OK
B5581	8.0	ULS-Set(2)	263.0	0.0	0.0	OK
B6084	8.0	ULS-Set(2)	355.7	0.4	0.0	OK
BP1	20.0	ULS-Set(5)	355.6	0.3	0.0	OK
STIFF1	12.0	ULS-Set(2)	215.0	0.0	0.0	OK

Design data

Material	f_y [MPa]	ϵ_{lim} [%]
S 355	355.0	5.0

Symbol explanation

ϵ_{pl}	Strain
σ_{Ed}	Eq. stress
σ_{cEd}	Contact stress
f_y	Yield strength
ϵ_{lim}	Limit of plastic strain

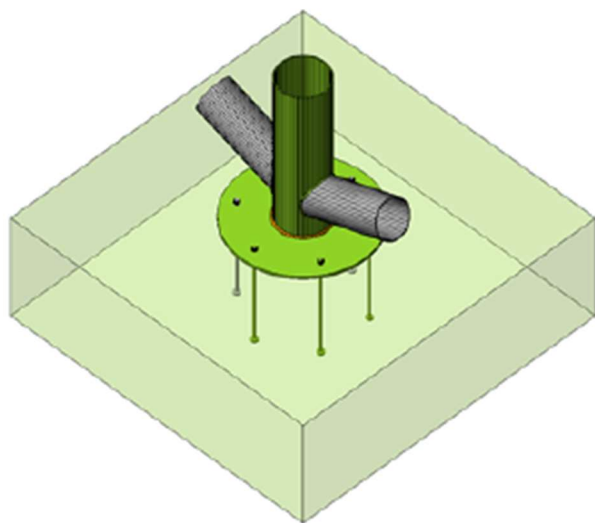

Overall check, ULS-Set(2)

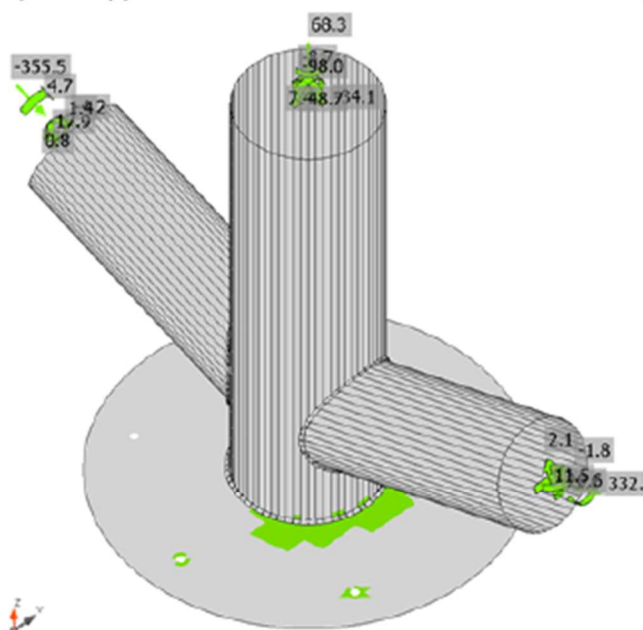

Strain check, ULS-Set(2)

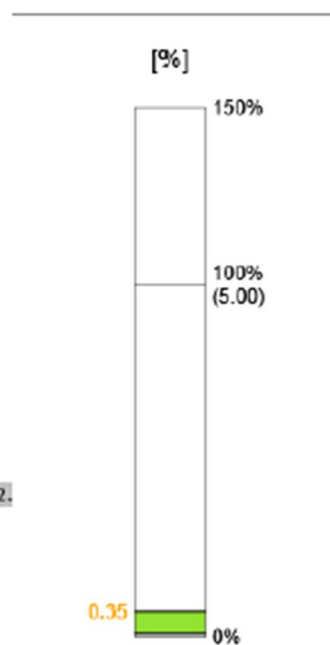

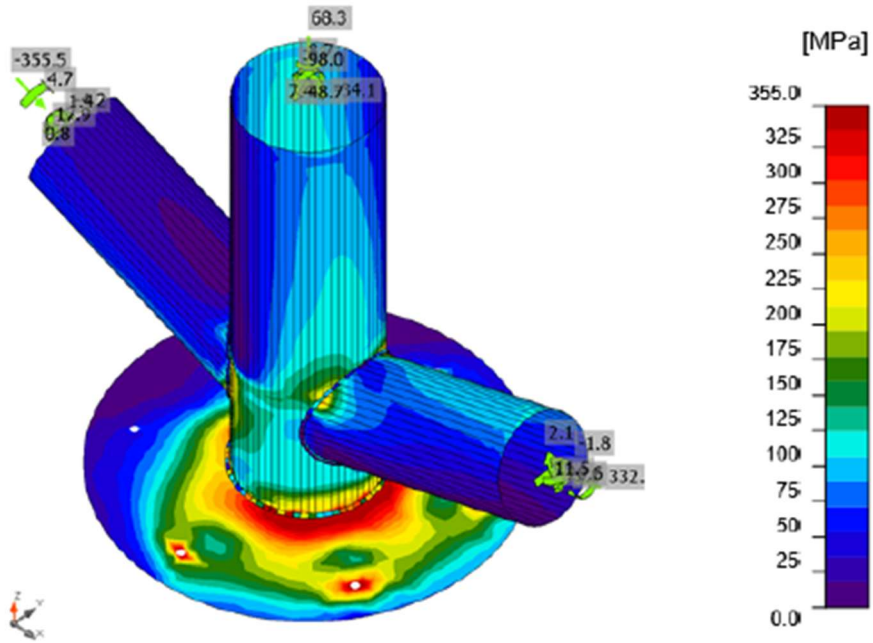

Equivalent stress, ULS-Set(2)

Anchors

Shape	Item	Loads	N_{Ed} [kN]	V_{Ed} [kN]	$N_{Rd,c}$ [kN]	$N_{Rd,p}$ [kN]	$N_{Rd,cb}$ [kN]	$V_{Rd,c}$ [kN]	$V_{Rd,cp}$ [kN]	U_{tt} [%]	U_{ts} [%]	U_{ts} [%]	Status
	A1	ULS-Set(5)	34.9	14.3	661.9	343.6	-	417.7	2130.8	64.3	17.5	55.9	OK
	A2	ULS-Set(5)	136.3	13.4	661.9	343.6	-	237.2	2130.8	91.6	21.9	86.6	OK
	A3	ULS-Set(5)	138.9	8.9	661.9	343.6	-	237.2	2130.8	93.4	21.9	88.4	OK
	A4	ULS-Set(5)	102.9	2.0	661.9	343.6	-	-	2130.8	69.2	2.5	52.0	OK
	A5	ULS-Set(5)	3.3	7.1	661.9	343.6	-	-	2130.8	64.3	8.7	52.0	OK
	A6	ULS-Set(5)	9.4	12.5	661.9	343.6	-	417.7	2130.8	64.3	15.4	55.9	OK

Design data

Grade	$N_{Rd,s}$ [kN]	$V_{Rd,s}$ [kN]
M20 10.9 - 1	148.8	81.7

Symbol explanation

N_{Ed}	Tension force
V_{Ed}	Resultant of shear forces V_y , V_z in bolt
$N_{Rd,c}$	Design resistance in case of concrete cone failure under tension load - EN1992-4 - Cl. 7.2.1.4
$N_{Rd,p}$	Design resistance in case of pull-out failure - EN1992-4 - Cl. 7.2.1.5
$N_{Rd,cb}$	Design resistance in case of concrete blow-out failure - EN1992-4 - Cl. 7.2.1.8
$V_{Rd,c}$	Design resistance in case of concrete cone failure under shear load - EN1992-4 - Cl. 7.2.2.5
$V_{Rd,cp}$	Design resistance in case of concrete pryout failure - EN1992-4 - Cl. 7.2.2.4
U_t	Utilization in tension
U_s	Utilization in shear
U_{ts}	Utilization in tension and shear
$N_{Rd,s}$	Design tensile resistance of a fastener in case of steel failure - EN1992-4 - Cl. 7.2.1.3
$V_{Rd,s}$	Design shear resistance in case of steel failure - EN1992-4 - Cl. 7.2.2.3.1

Welds (Plastic redistribution)

Item	Edge	Throat th. [mm]	Length [mm]	Loads	$\sigma_{w,Ed}$ [MPa]	ϵ_{pl} [%]	σ_{\perp} [MPa]	τ_{\parallel} [MPa]	τ_{\perp} [MPa]	Ut [%]	Ut _c [%]	Status
B6084-arc 9	B5570	▲7.0▲	891	ULS-Set(2)	334.4	0.0	-102.5	19.8	-182.7	76.8	14.9	OK
B6084-arc 56	B5581	▲7.0▲	889	ULS-Set(2)	190.0	0.0	43.8	10.0	-106.3	43.6	13.3	OK
BP1	B6084	▲10.0▲	1092	ULS-Set(5)	427.3	0.3	-225.4	-23.1	208.3	98.1	53.1	OK
		▲7.0▲	891	ULS-Set(2)	192.0	0.0	-118.3	-16.6	85.7	44.1	10.7	OK
		▲7.0▲	889	ULS-Set(2)	144.9	0.0	-70.6	0.0	73.1	33.3	13.3	OK
B6084-arc 1	STIFF1	▲4.0▲	17	ULS-Set(2)	88.7	0.0	45.9	-21.6	38.1	20.4	20.4	OK
		▲4.0▲	17	ULS-Set(5)	63.1	0.0	7.6	33.1	-14.6	14.5	14.5	OK
B6084-arc 2	STIFF1	▲4.0▲	17	ULS-Set(2)	77.0	0.0	41.2	-7.3	36.8	17.7	17.7	OK
		▲4.0▲	17	ULS-Set(5)	54.5	0.0	11.6	26.7	-15.3	12.5	12.5	OK
B6084-arc 3	STIFF1	▲4.0▲	17	ULS-Set(2)	67.9	0.0	37.3	7.1	32.0	15.6	15.6	OK
		▲4.0▲	17	ULS-Set(5)	47.7	0.0	12.4	20.6	-16.8	10.9	10.9	OK
B6084-arc 4	STIFF1	▲4.0▲	17	ULS-Set(2)	70.6	0.0	31.5	24.1	27.4	16.2	16.2	OK
		▲4.0▲	17	ULS-Set(2)	32.4	0.0	12.9	1.4	-17.1	7.4	7.4	OK
B6084-arc 5	STIFF1	▲4.0▲	17	ULS-Set(2)	72.1	0.0	12.7	39.1	12.3	16.6	16.6	OK
		▲4.0▲	17	ULS-Set(2)	61.2	0.0	30.1	-3.3	-30.6	14.0	14.0	OK
B6084-arc 6	STIFF1	▲4.0▲	17	ULS-Set(2)	92.1	0.0	7.1	52.5	7.0	21.1	21.1	OK
		▲4.0▲	17	ULS-Set(2)	58.1	0.0	23.8	-19.2	-23.8	13.3	13.3	OK
B6084-arc 7	STIFF1	▲4.0▲	17	ULS-Set(2)	118.6	0.0	-25.5	66.0	-11.1	27.2	27.2	OK
		▲4.0▲	17	ULS-Set(2)	92.1	0.0	42.4	-38.0	-28.0	21.2	21.2	OK
B6084-arc 8	STIFF1	▲4.0▲	17	ULS-Set(2)	175.6	0.0	-75.4	78.5	-47.0	40.3	40.3	OK
		▲4.0▲	17	ULS-Set(2)	144.4	0.0	32.9	-81.1	-4.5	33.2	33.2	OK
B6084-arc 9	STIFF1	▲4.0▲	17	ULS-Set(2)	426.9	0.0	-187.0	164.9	-147.9	98.0	98.0	OK
		▲4.0▲	17	ULS-Set(2)	426.4	0.0	-75.5	-210.7	119.6	97.9	97.9	OK
B6084-arc 10	STIFF1	▲4.0▲	17	ULS-Set(2)	417.5	0.0	-205.3	23.0	-208.6	95.9	95.9	OK
		▲4.0▲	17	ULS-Set(2)	411.7	0.0	-195.9	-81.5	192.5	94.5	94.5	OK
B6084-arc 11	STIFF1	▲4.0▲	17	ULS-Set(2)	199.3	0.0	-64.9	-46.9	-98.2	45.8	45.8	OK
		▲4.0▲	17	ULS-Set(2)	266.0	0.0	-157.2	1.4	123.9	61.1	61.1	OK
B6084-arc 12	STIFF1	▲4.0▲	17	ULS-Set(2)	28.1	0.0	-0.5	-4.0	-15.7	6.5	6.5	OK
		▲4.0▲	17	ULS-Set(5)	122.8	0.0	-70.9	-17.1	55.3	28.2	28.2	OK
B6084-arc 13	STIFF1	▲4.0▲	17	ULS-Set(2)	11.2	0.0	0.3	-3.3	-5.5	2.6	2.6	OK
		▲4.0▲	17	ULS-Set(5)	80.6	0.0	-44.6	1.4	38.7	18.5	18.5	OK
B6084-arc 14	STIFF1	▲4.0▲	17	ULS-Set(2)	24.4	0.0	-9.5	-5.8	-11.6	5.6	5.6	OK
		▲4.0▲	17	ULS-Set(5)	52.2	0.0	-27.7	3.4	25.3	12.0	12.0	OK
B6084-arc 15	STIFF1	▲4.0▲	17	ULS-Set(5)	5.7	0.0	-1.1	3.2	-0.6	1.3	1.3	OK
		▲4.0▲	17	ULS-Set(5)	55.2	0.0	-27.2	1.8	27.7	12.7	12.7	OK
B6084-arc 16	STIFF1	▲4.0▲	17	ULS-Set(2)	14.7	0.0	-6.0	-5.9	-5.1	3.4	3.4	OK
		▲4.0▲	17	ULS-Set(2)	42.1	0.0	-19.8	5.4	20.7	9.7	9.7	OK
B6084-arc 17	STIFF1	▲4.0▲	17	ULS-Set(2)	16.1	0.0	-6.2	-7.3	-4.5	3.7	3.7	OK
		▲4.0▲	17	ULS-Set(2)	47.6	0.0	-21.7	7.3	23.3	10.9	10.9	OK

Item	Edge	Throat th. [mm]	Length [mm]	Loads	$\sigma_{w,Ed}$ [MPa]	ϵ_{pl} [%]	σ_{\perp} [MPa]	τ_{\parallel} [MPa]	τ_{\perp} [MPa]	Ut [%]	Ut _c [%]	Status
B6084-arc 18	STIFF1	▲4.0▲	17	ULS-Set(2)	17.9	0.0	-5.6	-8.8	-4.3	4.1	4.1	OK
		▲4.0▲	17	ULS-Set(2)	48.9	0.0	-22.8	6.6	24.0	11.2	11.2	OK
B6084-arc 19	STIFF1	▲4.0▲	17	ULS-Set(2)	20.5	0.0	-4.6	-7.2	-9.0	4.7	4.7	OK
		▲4.0▲	17	ULS-Set(2)	50.8	0.0	-27.6	8.4	23.1	11.7	11.7	OK
B6084-arc 20	STIFF1	▲4.0▲	17	ULS-Set(2)	20.8	0.0	-2.4	-10.5	-5.8	4.8	4.8	OK
		▲4.0▲	17	ULS-Set(2)	70.6	0.0	-36.1	12.4	32.7	16.2	16.2	OK
B6084-arc 21	STIFF1	▲4.0▲	17	ULS-Set(2)	25.9	0.0	0.7	-5.0	-14.1	6.0	6.0	OK
		▲4.0▲	17	ULS-Set(2)	106.7	0.0	-58.9	26.3	44.1	24.5	24.5	OK
B6084-arc 22	STIFF1	▲4.0▲	17	ULS-Set(2)	152.8	0.0	-63.5	19.8	-77.8	35.1	35.1	OK
		▲4.0▲	17	ULS-Set(5)	203.6	0.0	-112.0	15.0	97.0	46.8	46.8	OK
B6084-arc 23	STIFF1	▲4.0▲	17	ULS-Set(2)	288.1	0.0	-140.3	-44.0	-138.5	66.2	66.2	OK
		▲4.0▲	17	ULS-Set(5)	296.9	0.0	-134.1	72.8	134.5	68.2	68.2	OK
B6084-arc 24	STIFF1	▲4.0▲	17	ULS-Set(2)	282.6	0.0	-111.0	-116.4	-94.7	64.9	64.9	OK
		▲4.0▲	17	ULS-Set(2)	270.4	0.0	-52.7	136.7	69.0	62.1	62.1	OK
B6084-arc 25	STIFF1	▲4.0▲	17	ULS-Set(2)	112.2	0.0	-41.4	-55.7	-22.8	25.7	25.7	OK
		▲4.0▲	17	ULS-Set(2)	104.1	0.0	17.0	59.3	1.6	23.9	23.9	OK
B6084-arc 26	STIFF1	▲4.0▲	17	ULS-Set(2)	77.6	0.0	-14.1	-43.6	-6.0	17.8	17.8	OK
		▲4.0▲	17	ULS-Set(2)	64.6	0.0	22.0	32.2	-13.9	14.8	14.8	OK
B6084-arc 27	STIFF1	▲4.0▲	17	ULS-Set(2)	54.5	0.0	-3.8	-31.4	-1.9	12.5	12.5	OK
		▲4.0▲	17	ULS-Set(2)	48.8	0.0	19.2	19.3	-17.2	11.2	11.2	OK
B6084-arc 28	STIFF1	▲4.0▲	17	ULS-Set(2)	47.0	0.0	5.5	-26.4	5.3	10.8	10.8	OK
		▲4.0▲	17	ULS-Set(2)	36.7	0.0	16.4	9.2	-16.6	8.4	8.4	OK
B6084-arc 29	STIFF1	▲4.0▲	17	ULS-Set(2)	36.9	0.0	9.2	-17.9	10.3	8.5	8.5	OK
		▲4.0▲	17	ULS-Set(5)	23.1	0.0	11.8	-4.2	-10.6	5.3	5.3	OK
B6084-arc 30	STIFF1	▲4.0▲	17	ULS-Set(2)	33.2	0.0	14.9	-8.9	14.6	7.6	7.6	OK
		▲4.0▲	17	ULS-Set(6)	29.3	0.0	9.0	-13.2	-9.3	6.7	6.7	OK
B6084-arc 31	STIFF1	▲4.0▲	17	ULS-Set(2)	35.9	0.0	20.3	0.8	17.1	8.2	8.2	OK
		▲4.0▲	17	ULS-Set(5)	38.7	0.0	6.2	-20.1	-9.2	8.9	8.9	OK
B6084-arc 32	STIFF1	▲4.0▲	17	ULS-Set(5)	48.5	0.0	21.8	16.4	18.8	11.1	11.1	OK
		▲4.0▲	17	ULS-Set(5)	50.8	0.0	4.5	-28.2	-7.5	11.7	11.7	OK
B6084-arc 33	STIFF1	▲4.0▲	17	ULS-Set(5)	68.9	0.0	28.2	27.8	23.4	15.8	15.8	OK
		▲4.0▲	17	ULS-Set(5)	61.9	0.0	-0.1	-35.5	-4.6	14.2	14.2	OK
B6084-arc 34	STIFF1	▲4.0▲	17	ULS-Set(5)	81.9	0.0	25.9	39.8	20.8	18.8	18.8	OK
		▲4.0▲	17	ULS-Set(5)	70.9	0.0	0.5	-40.6	-5.6	16.3	16.3	OK
B6084-arc 35	STIFF1	▲4.0▲	17	ULS-Set(2)	104.1	0.0	35.0	48.9	28.5	23.9	23.9	OK
		▲4.0▲	17	ULS-Set(5)	82.4	0.0	-5.3	-47.5	-0.3	18.9	18.9	OK
B6084-arc 36	STIFF1	▲4.0▲	17	ULS-Set(2)	116.2	0.0	28.3	61.3	21.9	26.7	26.7	OK
		▲4.0▲	17	ULS-Set(5)	85.9	0.0	-0.8	-49.3	-4.9	19.7	19.7	OK
B6084-arc 37	STIFF1	▲4.0▲	17	ULS-Set(2)	129.2	0.0	16.5	72.9	12.8	29.7	29.7	OK
		▲4.0▲	17	ULS-Set(5)	87.7	0.0	-0.7	-50.6	-2.6	20.1	20.1	OK
B6084-arc 38	STIFF1	▲4.0▲	17	ULS-Set(2)	139.8	0.0	13.1	79.7	10.1	32.1	32.1	OK

Item	Edge	Throat th. [mm]	Length [mm]	Loads	$\sigma_{w,Ed}$ [MPa]	ϵ_{pl} [%]	σ_{\perp} [MPa]	τ_{\parallel} [MPa]	τ_{\perp} [MPa]	Ut [%]	Ut _c [%]	Status
		44.0	17	ULS-Set(5)	91.4	0.0	-2.4	-52.8	-0.3	21.0	21.0	OK
B6084-arc 39	STIFF1	44.0	17	ULS-Set(2)	140.6	0.0	-10.4	80.6	-7.0	32.3	32.3	OK
		44.0	17	ULS-Set(2)	97.8	0.0	7.9	-56.1	-4.5	22.5	22.5	OK
B6084-arc 40	STIFF1	44.0	17	ULS-Set(2)	148.5	0.0	-26.8	82.1	-19.2	34.1	34.1	OK
		44.0	17	ULS-Set(2)	112.0	0.0	4.0	-64.5	3.7	25.7	25.7	OK
B6084-arc 41	STIFF1	44.0	17	ULS-Set(2)	214.3	0.0	-70.9	102.0	-56.9	49.2	49.2	OK
		44.0	17	ULS-Set(2)	179.9	0.0	-23.4	-95.9	37.6	41.3	41.3	OK
B6084-arc 42	STIFF1	44.0	17	ULS-Set(2)	184.5	0.0	-81.6	55.7	-77.6	42.4	42.4	OK
		44.0	17	ULS-Set(2)	153.3	0.0	-57.9	-53.7	62.0	35.2	35.2	OK
B6084-arc 43	STIFF1	44.0	17	ULS-Set(2)	96.1	0.0	-41.8	17.9	-46.6	22.1	22.1	OK
		44.0	17	ULS-Set(2)	89.7	0.0	-43.9	-22.7	39.0	20.6	20.6	OK
B6084-arc 44	STIFF1	44.0	17	ULS-Set(5)	67.4	0.0	-13.4	35.3	-14.4	15.5	15.5	OK
		44.0	17	ULS-Set(2)	60.7	0.0	-13.5	-32.6	10.1	13.9	13.9	OK
B6084-arc 45	STIFF1	44.0	17	ULS-Set(5)	57.1	0.0	-12.7	29.6	-12.6	13.1	13.1	OK
		44.0	17	ULS-Set(2)	43.4	0.0	-6.6	-24.1	5.8	10.0	10.0	OK
B6084-arc 46	STIFF1	44.0	17	ULS-Set(5)	52.9	0.0	-17.0	24.4	-15.6	12.2	12.2	OK
		44.0	17	ULS-Set(2)	34.5	0.0	-5.0	-18.9	5.6	7.9	7.9	OK
B6084-arc 47	STIFF1	44.0	17	ULS-Set(5)	47.4	0.0	-17.1	19.4	-16.6	10.9	10.9	OK
		44.0	17	ULS-Set(2)	30.2	0.0	-3.8	-16.8	4.0	6.9	6.9	OK
B6084-arc 48	STIFF1	44.0	17	ULS-Set(5)	39.0	0.0	-18.1	10.9	-16.6	8.9	8.9	OK
		44.0	17	ULS-Set(3)	18.9	0.0	-2.4	-10.4	3.1	4.3	4.3	OK
B6084-arc 49	STIFF1	44.0	17	ULS-Set(5)	37.3	0.0	-20.2	2.6	-17.9	8.6	8.6	OK
		44.0	17	ULS-Set(3)	13.0	0.0	-2.9	-5.8	4.5	3.0	3.0	OK
B6084-arc 50	STIFF1	44.0	17	ULS-Set(5)	37.0	0.0	-18.8	-5.7	-17.5	8.5	8.5	OK
		44.0	17	ULS-Set(5)	9.2	0.0	-0.6	4.9	1.9	2.1	2.1	OK
B6084-arc 51	STIFF1	44.0	17	ULS-Set(5)	41.6	0.0	-17.9	-14.5	-16.1	9.5	9.5	OK
		44.0	17	ULS-Set(5)	20.6	0.0	-1.8	11.2	3.7	4.7	4.7	OK
B6084-arc 52	STIFF1	44.0	17	ULS-Set(5)	50.8	0.0	-16.2	-22.9	-15.8	11.7	11.7	OK
		44.0	17	ULS-Set(5)	33.7	0.0	-3.2	19.1	3.5	7.7	7.7	OK
B6084-arc 53	STIFF1	44.0	17	ULS-Set(5)	60.8	0.0	-14.2	-30.0	-16.2	14.0	14.0	OK
		44.0	17	ULS-Set(2)	50.4	0.0	-8.5	28.1	5.8	11.6	11.6	OK
B6084-arc 54	STIFF1	44.0	17	ULS-Set(3)	93.5	0.0	-43.2	-4.1	-47.7	21.5	21.5	OK
		44.0	17	ULS-Set(3)	90.6	0.0	-48.1	8.9	43.4	20.8	20.8	OK
B6084-arc 55	STIFF1	44.0	17	ULS-Set(3)	190.3	0.0	-85.8	-48.6	-85.2	43.7	43.7	OK
		44.0	17	ULS-Set(3)	159.8	0.0	-67.0	49.4	67.6	36.7	36.7	OK
B6084-arc 56	STIFF1	44.0	17	ULS-Set(3)	196.1	0.0	-72.4	-86.3	-60.2	45.0	45.0	OK
		44.0	17	ULS-Set(3)	168.6	0.0	-23.5	89.5	35.8	38.7	38.7	OK
B6084-arc 57	STIFF1	44.0	17	ULS-Set(2)	149.9	0.0	-29.0	-82.9	-18.2	34.4	34.4	OK
		44.0	17	ULS-Set(2)	116.1	0.0	10.9	66.7	0.0	26.7	26.7	OK
B6084-arc 58	STIFF1	44.0	17	ULS-Set(2)	150.5	0.0	-7.3	-86.7	-2.5	34.5	34.5	OK
		44.0	17	ULS-Set(2)	103.5	0.0	11.1	59.1	-6.2	23.8	23.8	OK

Item	Edge	Throat th. [mm]	Length [mm]	Loads	$\sigma_{w,Ed}$ [MPa]	ϵ_{pl} [%]	σ_{\perp} [MPa]	τ_{\parallel} [MPa]	τ_{\perp} [MPa]	Ut [%]	Ut _c [%]	Status
B6084-arc 59	STIFF1	▲4.0▲	17	ULS-Set(2)	143.2	0.0	8.1	-82.1	8.3	32.9	32.9	OK
		▲4.0▲	17	ULS-Set(5)	101.1	0.0	7.8	57.7	-8.1	23.2	23.2	OK
B6084-arc 60	STIFF1	▲4.0▲	17	ULS-Set(2)	149.1	0.0	21.3	-83.5	16.9	34.2	34.2	OK
		▲4.0▲	17	ULS-Set(5)	99.9	0.0	7.8	56.2	-12.4	22.9	22.9	OK
B6084-arc 61	STIFF1	▲4.0▲	17	ULS-Set(2)	141.6	0.0	30.0	-75.6	25.8	32.5	32.5	OK
		▲4.0▲	17	ULS-Set(5)	96.7	0.0	4.1	55.1	-8.5	22.2	22.2	OK
B6084-arc 62	STIFF1	▲4.0▲	17	ULS-Set(2)	129.1	0.0	37.5	-63.4	32.7	29.6	29.6	OK
		▲4.0▲	17	ULS-Set(5)	89.6	0.0	2.9	51.1	-7.6	20.6	20.6	OK
B6084-arc 63	STIFF1	▲4.0▲	17	ULS-Set(2)	118.1	0.0	44.5	-51.3	36.8	27.1	27.1	OK
		▲4.0▲	17	ULS-Set(5)	82.9	0.0	3.5	46.6	-10.8	19.0	19.0	OK
B6084-arc 64	STIFF1	▲4.0▲	17	ULS-Set(2)	100.4	0.0	44.1	-36.9	36.7	23.1	23.1	OK
		▲4.0▲	17	ULS-Set(5)	73.3	0.0	5.8	40.2	-12.7	16.8	16.8	OK

Design data

	β_w [-]	$\sigma_{w,Rd}$ [MPa]	0.9 σ [MPa]
S 355	0.90	435.6	352.8

Symbol explanation

ϵ_{pl}	Strain
$\sigma_{w,Ed}$	Equivalent stress
$\sigma_{w,Rd}$	Equivalent stress resistance
σ_{\perp}	Perpendicular stress
τ_{\parallel}	Shear stress parallel to weld axis
τ_{\perp}	Shear stress perpendicular to weld axis
0.9 σ	Perpendicular stress resistance - 0.9*fu/γM2
β_w	Corelation factor EN 1993-1-8 tab. 4.1
Ut	Utilization
Ut _c	Weld capacity utilization

Concrete block

Item	Loads	c [mm]	A _{eff} [mm ²]	σ [MPa]	k _j [-]	F _{jd} [MPa]	Ut [%]	Status
CB 1	ULS-Set(5)	27	13963	66.0	3.00	67.0	98.6	OK

Symbol explanation

c	Bearing width
A _{eff}	Effective area
σ	Average stress in concrete
k _j	Concentration factor
F _{jd}	The ultimate bearing strength of the concrete block
Ut	Utilization

Buckling

Buckling analysis was not calculated.

Code settings

Item	Value	Unit	Reference
YM0	1.00	-	EN 1993-1-1: 6.1
YM1	1.00	-	EN 1993-1-1: 6.1
YM2	1.25	-	EN 1993-1-1: 6.1
YM3	1.25	-	EN 1993-1-8: 2.2
YC	1.50	-	EN 1992-1-1: 2.4.2.4
YInst	1.20	-	EN 1992-4: Table 4.1
Joint coefficient β_j	0.67	-	EN 1993-1-8: 6.2.5
Effective area - influence of mesh size	0.10	-	
Friction coefficient - concrete	0.25	-	EN 1993-1-8
Friction coefficient in slip-resistance	0.30	-	EN 1993-1-8 tab 3.7
Limit plastic strain	0.05	-	EN 1993-1-5
Weld stress evaluation	Plastic redistribution		
Detailing	No		
Distance between bolts [d]	2.20	-	EN 1993-1-8: tab 3.3
Distance between bolts and edge [d]	1.20	-	EN 1993-1-8: tab 3.3
Concrete breakout resistance check	Both		EN 1992-4: 7.2.1.4 and 7.2.2.5
Use calculated a_b in bearing check.	Yes		EN 1993-1-8: tab 3.4
Cracked concrete	Yes		EN 1992-4
Local deformation check	No		CIDECT DG 1, 3 - 1.1
Local deformation limit	0.03	-	CIDECT DG 1, 3 - 1.1
Geometrical nonlinearity (GMNA)	Yes		Analysis with large deformations for hollow section joints
Braced system	No		EN 1993-1-8: 5.2.2.5

5.3. Spoj kosog dijela stupa „S1“

Design

Name	Con N5748
Description	
Analysis	Stress, strain/ loads in equilibrium

Beams and columns

Name	Cross-section	β - Direction [°]	γ - Pitch [°]	α - Rotation [°]	Offset ex [mm]	Offset ey [mm]	Offset ez [mm]	Forces in
B5633	1 - CHS(cf)219.1/12.5	0.0	0.0	0.0	135	0	0	Position
B5699	2 - CHS(cf)219.1/12.5	0.0	0.0	0.0	100	0	125	Position
B6109	2 - CHS(cf)219.1/12.5	0.0	0.0	0.0	0	0	0	Position
B6110	2 - CHS(cf)219.1/12.5	0.0	0.0	0.0	0	0	0	Position

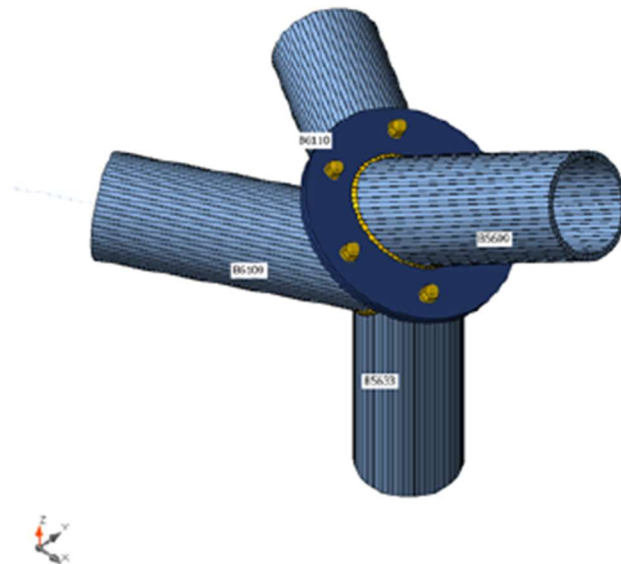

Cross-sections

Name	Material
1 - CHS(cf)219.1/12.5	S 355
2 - CHS(cf)219.1/12.5	S 355

Bolts

Name	Bolt assembly	Diameter [mm]	f_u [MPa]	Gross area [mm ²]
M20 8.8	M20 8.8	20	800.0	314

Load effects (forces in equilibrium)

Name	Member	N [kN]	Vy [kN]	Vz [kN]	Mx [kNm]	My [kNm]	Mz [kNm]
ULS-Set(2)	B5633	172.9	-1.1	-1.5	-2.2	-7.5	6.2
	B5699	-136.9	-0.5	-3.0	7.7	10.6	-8.1
	B6109	-92.2	-11.2	-27.9	-4.0	1.8	3.3
	B6110	48.8	-9.8	-71.5	-3.3	-8.1	1.8
ULS-Set(3)	B5633	-33.6	2.3	-12.2	-0.7	-47.0	-9.7
	B5699	-119.1	3.2	-4.8	6.5	24.0	8.2
	B6109	-52.1	-22.3	53.3	4.0	-17.5	-4.1
	B6110	61.2	-2.5	46.2	-0.1	11.4	-5.5
ULS-Set(6)	B5633	21.9	2.0	-13.0	-1.6	-50.7	-8.0
	B5699	-165.5	3.2	-5.3	9.3	27.1	6.1
	B6109	-83.0	-27.0	44.7	2.7	-17.8	-3.2
	B6110	78.9	-6.0	23.7	-1.5	9.5	-5.2
ULS-Set(8)	B5633	149.4	-0.1	-5.7	-2.4	-23.3	2.1
	B5699	-167.2	0.6	-3.7	9.4	17.1	-4.8
	B6109	-103.8	-18.4	-7.2	-2.5	-5.3	1.8
	B6110	66.3	-10.7	-52.5	-3.5	-3.4	-0.1
ULS-Set(9)	B5633	-25.3	2.3	-12.9	-0.8	-49.7	-9.5
	B5699	-134.0	3.4	-5.8	7.2	26.6	8.3
	B6109	-60.0	-23.9	53.6	4.0	-17.5	-4.2
	B6110	67.4	-2.6	46.1	0.0	11.6	-5.8
ULS-Set(10)	B5633	-31.8	-0.1	-12.8	-0.8	-49.2	-1.1
	B5699	-138.7	4.0	-5.3	7.1	25.0	10.2
	B6109	-63.2	-24.6	33.1	3.3	-10.8	-5.0
	B6110	68.9	-1.3	75.1	1.1	20.0	-6.6
ULS-Set(11)	B5633	-40.1	-0.1	-12.2	-0.7	-46.5	-1.3
	B5699	-123.8	3.9	-4.3	6.4	22.4	10.1
	B6109	-55.3	-22.9	32.8	3.2	-10.8	-4.8
	B6110	62.6	-1.2	75.2	1.0	19.8	-6.3
ULS-Set(12)	B5633	115.8	-2.6	7.5	-0.2	28.5	11.1
	B5699	2.4	-2.6	-1.4	-0.7	-6.6	-10.0
	B6109	-14.7	10.5	-52.5	-4.4	16.3	4.5
	B6110	-15.1	-1.3	-63.4	-0.3	-12.7	4.6
ULS-Set(13)	B5633	124.2	-2.6	6.8	-0.3	25.8	11.3
	B5699	-12.5	-2.4	-2.4	0.1	-4.0	-9.9
	B6109	-22.6	8.9	-52.2	-4.3	16.3	4.4
	B6110	-8.8	-1.4	-63.5	-0.2	-12.5	4.3
ULS-Set(15)	B5633	14.8	2.1	-12.2	-1.5	-47.7	-8.2
	B5699	-151.3	3.0	-4.6	8.5	25.2	5.6
	B6109	-75.6	-24.8	45.1	2.6	-17.5	-3.0
	B6110	72.3	-5.7	22.4	-1.4	8.7	-4.7
ULS-Set(16)	B5633	36.3	1.8	-11.1	-1.5	-42.7	-6.6

Name	Member	N [kN]	Vy [kN]	Vz [kN]	Mx [kNm]	My [kNm]	Mz [kNm]
	B5699	-151.1	2.2	-4.7	8.2	24.0	3.0
	B6109	-79.4	-22.6	37.6	1.8	-15.1	-1.8
	B6110	68.6	-6.6	8.4	-1.5	5.9	-3.5
ULS-Set(17)	B5633	164.6	-1.1	-0.9	-2.1	-4.8	6.0
	B5699	-122.0	-0.7	-2.0	7.0	8.1	-8.2
	B6109	-84.3	-9.5	-28.2	-4.1	1.8	3.5
	B6110	42.6	-9.7	-71.5	-3.3	-8.2	2.1
ULS-Set(18)	B5633	-0.8	-2.4	-10.7	-1.1	-41.5	7.4
	B5699	-142.4	3.8	-4.4	7.2	20.9	8.6
	B6109	-71.1	-22.9	4.6	1.3	-3.0	-4.2
	B6110	66.9	-1.7	73.7	1.3	22.2	-5.8
ULS-Set(20)	B5633	150.7	-0.1	-5.6	-2.4	-23.0	2.1
	B5699	-167.9	0.5	-4.0	9.4	17.7	-5.2
	B6109	-104.3	-17.9	-6.5	-2.5	-5.0	1.9
	B6110	65.9	-10.5	-53.8	-3.3	-4.1	0.1
ULS-Set(21)	B5633	122.7	-2.2	-6.7	-2.4	-27.5	9.0
	B5699	-172.7	1.9	-3.4	9.7	17.3	-0.8
	B6109	-103.7	-20.8	-19.5	-2.4	-0.7	0.0
	B6110	71.0	-8.3	-10.8	-2.0	7.1	-1.9
ULS-Set(22)	B5633	15.4	-0.4	-12.9	-1.6	-50.2	0.5
	B5699	-170.2	3.9	-4.8	9.2	25.5	7.9
	B6109	-86.2	-27.6	24.2	1.9	-11.1	-4.0
	B6110	80.4	-4.7	52.7	-0.3	17.9	-6.0
ULS-Set(25)	B5633	23.2	2.1	-12.9	-1.6	-50.4	-8.0
	B5699	-166.2	3.1	-5.6	9.3	27.8	5.7
	B6109	-83.5	-26.4	45.4	2.7	-17.5	-3.1
	B6110	78.5	-5.8	22.4	-1.3	8.9	-5.0
ULS-Set(29)	B5633	144.9	-3.2	-2.6	-2.2	-12.0	13.1
	B5699	-141.7	0.8	-2.4	8.0	10.2	-3.8
	B6109	-91.6	-14.1	-40.9	-3.9	6.1	1.4
	B6110	53.9	-7.6	-28.5	-1.9	3.1	-0.1
ULS-Set(30)	B5633	105.2	-4.2	-4.6	-1.9	-19.1	15.9
	B5699	-144.3	1.9	-2.6	7.8	12.1	0.2
	B6109	-88.1	-16.6	-39.8	-3.0	7.2	-0.3
	B6110	57.9	-5.5	11.5	-0.6	12.1	-2.0
ULS-Set(32)	B5633	-3.8	2.0	-11.8	-0.8	-44.8	-8.0
	B5699	-133.8	2.7	-5.9	6.8	25.4	5.8
	B6109	-63.9	-21.7	46.1	3.2	-15.1	-3.0
	B6110	63.8	-3.6	32.2	-0.2	8.8	-4.6
ULS-Set(33)	B5633	127.9	0.2	-6.8	-2.4	-28.3	0.5
	B5699	-167.4	1.3	-3.6	9.8	18.3	-2.2
	B6109	-100.0	-20.6	0.3	-1.6	-7.7	0.6
	B6110	69.9	-9.8	-38.5	-3.3	-0.6	-1.3

Name	Member	N [kN]	Vy [kN]	Vz [kN]	Mx [kNm]	My [kNm]	Mz [kNm]
ULS-Set(36)	B5633	7.1	-0.3	-12.2	-1.5	-47.5	0.3
	B5699	-155.3	3.7	-3.8	8.5	23.0	7.8
	B6109	-78.3	-26.0	23.9	1.8	-11.1	-3.9
	B6110	74.2	-4.6	52.8	-0.4	17.7	-5.7
ULS-Set(37)	B5633	113.1	-2.2	-6.1	-2.3	-25.1	8.7
	B5699	-157.2	1.8	-2.1	9.0	14.1	-0.5
	B6109	-95.3	-19.7	-20.5	-2.5	-1.0	0.0
	B6110	65.2	-8.3	-9.4	-2.2	7.6	-1.8
ULS-Set(38)	B5633	121.4	-2.2	-6.7	-2.4	-27.8	8.9
	B5699	-172.1	2.0	-3.1	9.7	16.7	-0.4
	B6109	-103.2	-21.3	-20.2	-2.4	-1.0	-0.2
	B6110	71.4	-8.5	-9.5	-2.1	7.8	-2.1
ULS-Set(46)	B5633	16.7	-0.4	-12.8	-1.6	-49.9	0.5
	B5699	-170.9	3.8	-5.1	9.2	26.1	7.5
	B6109	-86.7	-27.1	24.9	1.9	-10.8	-3.8
	B6110	80.0	-4.5	51.3	-0.1	17.2	-5.8
ULS-Set(47)	B5633	136.6	-3.2	-1.9	-2.1	-9.3	12.9
	B5699	-126.8	0.7	-1.4	7.2	7.7	-3.9
	B6109	-83.7	-12.4	-41.2	-4.0	6.1	1.5
	B6110	47.7	-7.4	-28.5	-2.0	3.0	0.1
ULS-Set(49)	B5633	13.6	2.1	-12.3	-1.5	-48.0	-8.2
	B5699	-150.6	3.1	-4.3	8.5	24.6	6.0
	B6109	-75.1	-25.3	44.4	2.6	-17.8	-3.1
	B6110	72.7	-5.9	23.8	-1.5	9.3	-4.9
ULS-Set(50)	B5633	141.1	-0.1	-5.0	-2.4	-20.6	1.9
	B5699	-152.3	0.4	-2.7	8.7	14.6	-4.9
	B6109	-95.9	-16.8	-7.5	-2.5	-5.3	1.9
	B6110	60.0	-10.5	-52.4	-3.5	-3.6	0.2
ULS-Set(52)	B5633	119.6	0.2	-6.1	-2.4	-25.6	0.3
	B5699	-152.5	1.1	-2.6	9.1	15.7	-2.4
	B6109	-92.1	-19.0	0.0	-1.7	-7.7	0.7
	B6110	63.7	-9.6	-38.4	-3.4	-0.8	-1.0

Check

Summary

Name	Value	Status
Analysis	100.0%	OK
Plates	0.0 < 5.0%	OK
Bolts	45.0 < 100%	OK
Welds	99.7 < 100%	OK
Buckling	Not calculated	
GMNA	Calculated	

Plates

Name	Thickness [mm]	Loads	σ_{Ed} [MPa]	ϵ_{pl} [%]	σ_{cEd} [MPa]	Status
B5633	12.5	ULS-Set(13)	161.4	0.0	0.0	OK
B5699	12.5	ULS-Set(25)	163.8	0.0	0.0	OK
B6109	12.5	ULS-Set(13)	110.3	0.0	0.0	OK
B6110	12.5	ULS-Set(2)	124.5	0.0	0.0	OK
PP1a	12.0	ULS-Set(9)	320.4	0.0	32.6	OK
PP1b	12.0	ULS-Set(9)	299.4	0.0	32.6	OK

Design data

Material	f_y [MPa]	ϵ_{lim} [%]
S 355	355.0	5.0

Symbol explanation

ϵ_{pl}	Strain
σ_{Ed}	Eq. stress
σ_{cEd}	Contact stress
f_y	Yield strength
ϵ_{lim}	Limit of plastic strain

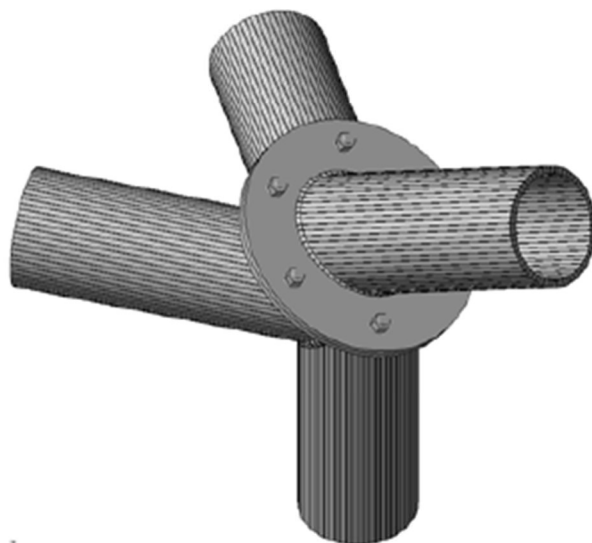

Overall check, ULS-Set(13)

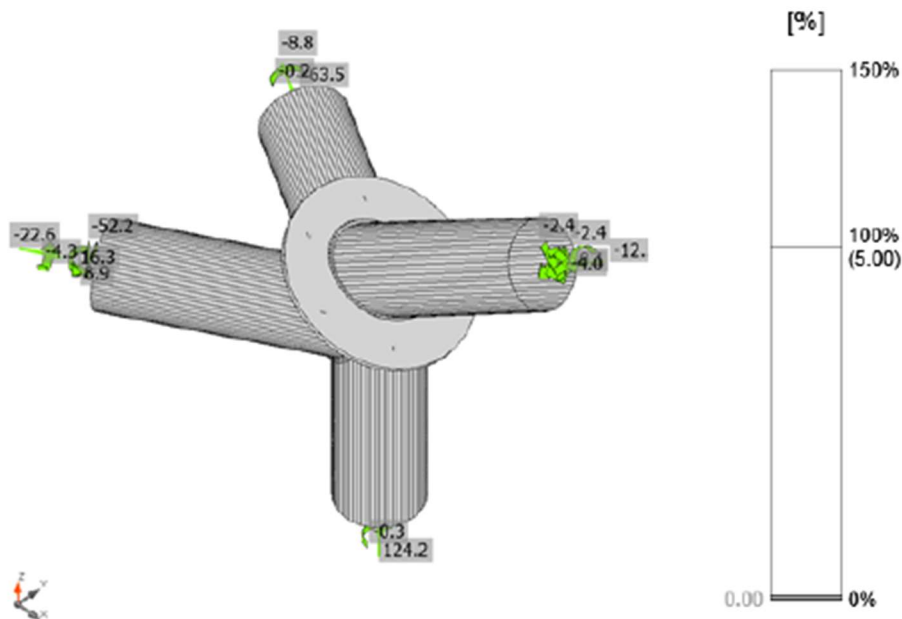

Strain check, ULS-Set(13)

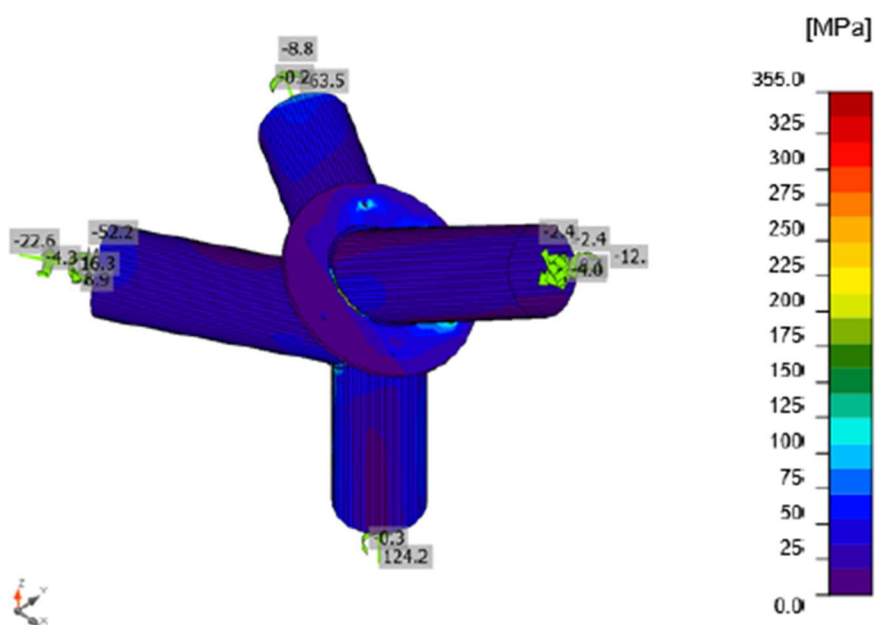

Equivalent stress, ULS-Set(13)

Bolts

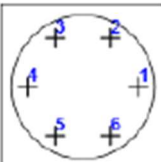
	Name	Loads	$F_{t,Ed}$ [kN]	V [kN]	U_{t_t} [%]	$F_{b,Rd}$ [kN]	U_{t_s} [%]	$U_{t_{ts}}$ [%]	Status
	B1	ULS-Set(25)	7.5	23.1	5.3	235.2	24.6	28.4	OK
	B2	ULS-Set(25)	41.2	21.8	29.2	235.2	23.2	44.0	OK
	B3	ULS-Set(9)	63.4	12.1	45.0	235.2	12.8	44.9	OK
	B4	ULS-Set(9)	27.0	2.6	19.1	235.2	2.8	16.4	OK
	B5	ULS-Set(12)	15.4	5.4	10.9	235.2	5.8	13.6	OK
	B6	ULS-Set(12)	47.2	5.8	33.5	235.2	6.2	30.1	OK

Design data

Name	$F_{t,Rd}$ [kN]	$B_{p,Rd}$ [kN]	$F_{v,Rd}$ [kN]
M20 8.8 - 1	141.1	279.3	94.1

Symbol explanation

$F_{t,Rd}$	Bolt tension resistance EN 1993-1-8 tab. 3.4
$F_{t,Ed}$	Tension force
$B_{p,Rd}$	Punching shear resistance
V	Resultant of shear forces V_y, V_z in bolt
$F_{v,Rd}$	Bolt shear resistance EN_1993-1-8 table 3.4
$F_{d,Rd}$	Plate bearing resistance EN 1993-1-8 tab. 3.4
U_{t_t}	Utilization in tension
U_{t_s}	Utilization in shear

Detailed result for B3**Tension resistance check (EN 1993-1-8 tab 3.4)**

$$F_{t,Rd} = \frac{k_2 f_{ub} A_s}{\gamma_{M2}} = 141.1 \text{ kN} \geq F_t = 63.4 \text{ kN}$$

where:

$$k_2 = 0.90 \quad - \text{Factor}$$

$$f_{ub} = 800.0 \text{ MPa} \quad - \text{Ultimate tensile strength of the bolt}$$

$$A_s = 245 \text{ mm}^2 \quad - \text{Tensile stress area of the bolt}$$

$$\gamma_{M2} = 1.25 \quad - \text{Safety factor}$$

Punching resistance check (EN 1993-1-8 tab 3.4)

$$B_{p,Rd} = \frac{0.6 \pi d_m t_p f_u}{\gamma_{M2}} = 279.3 \text{ kN} \geq F_t = 63.4 \text{ kN}$$

where:

$$d_m = 32 \text{ mm} \quad - \text{The mean of the across points and across flats dimensions of the bolt head or the nut, whichever is smaller}$$

$$t_p = 12 \text{ mm} \quad - \text{Thickness}$$

$$f_u = 490.0 \text{ MPa} \quad - \text{Ultimate strength}$$

$$\gamma_{M2} = 1.25 \quad - \text{Safety factor}$$

Shear resistance check (EN 1993-1-8 tab 3.4)

$$F_{v,Rd} = \frac{\beta_p \alpha_v f_{ub} A}{\gamma_{M2}} = 94.1 \text{ kN} \geq V = 12.1 \text{ kN}$$

where:

$$\beta_p = 1.00 \quad - \text{Reducing factor}$$

$$\alpha_v = 0.60 \quad - \text{Reducing factor}$$

$$f_{ub} = 800.0 \text{ MPa} \quad - \text{Ultimate tensile strength of the bolt}$$

$$A = 245 \text{ mm}^2 \quad - \text{Tensile stress area of the bolt}$$

$$\gamma_{M2} = 1.25 \quad - \text{Safety factor}$$

Bearing resistance check (EN 1993-1-8 tab 3.4)

$$F_{b,Rd} = \frac{k_1 \alpha_b f_u d t}{\gamma_{M2}} = 235.2 \text{ kN} \geq V = 12.1 \text{ kN}$$

where:

$k_1 = \min(2.8 \frac{e_2}{d_0} - 1.7, 1.4 \frac{p_2}{d_0} - 1.7, 2.5) = 2.50$	- Factor for edge distance and bolt spacing perpendicular to the direction of load transfer
$e_2 = \infty \text{ mm}$	- Distance to the plate edge perpendicular to the shear force
$p_2 = 180 \text{ mm}$	- Distance between bolts perpendicular to the shear force
$d_0 = 22 \text{ mm}$	- Bolt hole diameter
$\alpha_b = \min(\frac{e_1}{3d_0}, \frac{p_1}{3d_0} - \frac{1}{4}, \frac{f_{ub}}{f_u}, 1) = 1.00$	- Factor for end distance and bolt spacing in direction of load transfer
$e_1 = \infty \text{ mm}$	- Distance to the plate edge in the direction of the shear force
$p_1 = \infty \text{ mm}$	- Distance between bolts in the direction of the shear force
$f_{ub} = 800.0 \text{ MPa}$	- Ultimate tensile strength of the bolt
$f_u = 490.0 \text{ MPa}$	- Ultimate strength
$d = 20 \text{ mm}$	- Nominal diameter of the fastener
$t = 12 \text{ mm}$	- Thickness of the plate
$\gamma_{M2} = 1.25$	- Safety factor

Interaction of tension and shear (EN 1993-1-8 tab 3.4)

$$U_{tts} = \frac{F_{t,Rd}}{F_{t,Rd}} + \frac{F_{s,Rd}}{1.4F_{t,Rd}} = 44.9 \%$$

Utilization in tension

$$U_{tt} = \frac{F_{t,Rd}}{\min(F_{t,Rd}; B_{t,Rd})} = 45.0 \%$$

Utilization in shear

$$U_{ts} = \frac{V_{Ed}}{\min(F_{v,Rd}; F_{t,Rd})} = 12.8 \%$$

Welds (Plastic redistribution)

Item	Edge	Throat th. [mm]	Length [mm]	Loads	$\sigma_{w,Ed}$ [MPa]	ϵ_{pl} [%]	σ_{\perp} [MPa]	τ_{\parallel} [MPa]	τ_{\perp} [MPa]	Ut [%]	Ut _c [%]	Status
B5633-arc 34	B6109	▲6.3▲	652	ULS-Set(20)	132.6	0.0	6.2	-4.9	-76.3	30.4	5.6	OK
B6109-arc 42	B6110	▲6.3▲	263	ULS-Set(30)	90.5	0.0	19.5	-45.1	23.9	20.8	4.4	OK
B5633-arc 63	B6110	▲6.3▲	429	ULS-Set(10)	155.0	0.0	3.4	-4.8	-89.3	35.6	9.6	OK
PP1a	B5633	▲4.0	698	ULS-Set(25)	427.7	0.5	-132.2	22.5	233.8	98.2	41.1	OK
PP1b	B5699	▲4.0	698	ULS-Set(25)	434.2	4.2	-195.9	24.3	222.4	99.7	40.4	OK
		▲6.3▲	652	ULS-Set(18)	82.0	0.0	4.1	-45.0	-14.6	18.8	5.1	OK
		▲6.3▲	263	ULS-Set(18)	60.7	0.0	2.7	34.8	-3.3	13.9	6.9	OK
		▲6.3▲	429	ULS-Set(22)	84.4	0.0	-33.3	33.6	29.6	19.4	9.7	OK

Design data

	β_w [-]	$\sigma_{w,Rd}$ [MPa]	0.9σ [MPa]
S 355	0.90	435.6	352.8

Symbol explanation

ϵ_{pl}	Strain
$\sigma_{w,Ed}$	Equivalent stress
$\sigma_{w,Rd}$	Equivalent stress resistance
σ_{\perp}	Perpendicular stress
$\tau_{ }$	Shear stress parallel to weld axis
τ_{\perp}	Shear stress perpendicular to weld axis
0.9σ	Perpendicular stress resistance - $0.9 \cdot f_u / \gamma_{M2}$
β_w	Corelation factor EN 1993-1-8 tab. 4.1
U_t	Utilization
U_{tc}	Weld capacity utilization

Detailed result for PP1b B5699

Weld resistance check (EN 1993-1-8 4.5.3.2)

$$\sigma_{w,Rd} = f_u / (\beta_w \gamma_{M2}) = 435.6 \text{ MPa} \geq \sigma_{w,Ed} = [\sigma_{\perp}^2 + 3(\tau_{\perp}^2 + \tau_{||}^2)]^{0.5} = 434.2 \text{ MPa}$$

$$\sigma_{\perp,Rd} = 0.9 f_u / \gamma_{M2} = 352.8 \text{ MPa} \geq |\sigma_{\perp}| = 195.9 \text{ MPa}$$

where:

 $f_u = 490.0 \text{ MPa}$ – Ultimate strength $\beta_w = 0.90$ – appropriate correlation factor taken from Table 4.1 $\gamma_{M2} = 1.25$ – Safety factor

Stress utilization

$$U_t = \max\left(\frac{\sigma_{w,Ed}}{\sigma_{w,Rd}}, \frac{|\sigma_{\perp}|}{\sigma_{\perp,Rd}}\right) = 99.7 \%$$

Buckling

Buckling analysis was not calculated.

Code settings

Item	Value	Unit	Reference
YM0	1.00	-	EN 1993-1-1: 6.1
YM1	1.00	-	EN 1993-1-1: 6.1
YM2	1.25	-	EN 1993-1-1: 6.1
YM3	1.25	-	EN 1993-1-8: 2.2
YC	1.50	-	EN 1992-1-1: 2.4.2.4
Yinst	1.20	-	EN 1992-4: Table 4.1

Item	Value	Unit	Reference
Joint coefficient β_j	0.67	-	EN 1993-1-8: 6.2.5
Effective area - influence of mesh size	0.10	-	
Friction coefficient - concrete	0.25	-	EN 1993-1-8
Friction coefficient in slip-resistance	0.30	-	EN 1993-1-8 tab 3.7
Limit plastic strain	0.05	-	EN 1993-1-5
Weld stress evaluation	Plastic redistribution		
Detailing	No		
Distance between bolts [d]	2.20	-	EN 1993-1-8: tab 3.3
Distance between bolts and edge [d]	1.20	-	EN 1993-1-8: tab 3.3
Concrete breakout resistance check	Both		EN 1992-4: 7.2.1.4 and 7.2.2.5
Use calculated a_b in bearing check.	Yes		EN 1993-1-8: tab 3.4
Cracked concrete	Yes		EN 1992-4
Local deformation check	No		CIDECT DG 1, 3 - 1.1
Local deformation limit	0.03	-	CIDECT DG 1, 3 - 1.1
Geometrical nonlinearity (GMNA)	Yes		Analysis with large deformations for hollow section joints
Braced system	No		EN 1993-1-8: 5.2.2.5

5.4. Karakteristični spoj sjecišta više štapova

Design

Name	Con N5898
Description	
Analysis	Stress, strain/ loads in equilibrium

Beams and columns

Name	Cross-section	β - Direction [°]	γ - Pitch [°]	α - Rotation [°]	Offset ex [mm]	Offset ey [mm]	Offset ez [mm]	Forces in
B5537	1 - Massive O Hollow(CHS273,8)	0.0	0.0	0.0	0	0	-15	Position
B5538	1 - Massive O Hollow(CHS273,8)	0.0	0.0	0.0	0	0	0	Position
B5539	1 - Massive O Hollow(CHS273,8)	0.0	0.0	0.0	0	0	0	Position
B5540	1 - Massive O Hollow(CHS273,8)	0.0	0.0	0.0	0	0	0	Position
B5541	1 - Massive O Hollow(CHS273,8)	0.0	0.0	0.0	0	0	0	Position
B5542	1 - Massive O Hollow(CHS273,8)	0.0	0.0	0.0	0	0	0	Position
B5717	2 - CHS(cf)219.1/12.5	0.0	0.0	0.0	-200	0	-60	Position
B5721	2 - CHS(cf)219.1/12.5	0.0	0.0	0.0	-200	0	-100	Position
B6255	4 - CHS840,10	0.0	0.0	0.0	-700	0	0	Position

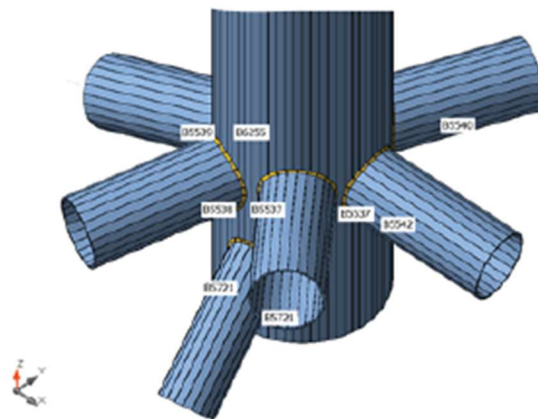

Cross-sections

Name	Material
1 - Massive O Hollow(CHS273,8)	S 355
2 - CHS(cf)219.1/12.5	S 355
4 - CHS840,10	S 355

Load effects (forces in equilibrium)

Name	Member	N [kN]	Vy [kN]	Vz [kN]	Mx [kNm]	My [kNm]	Mz [kNm]
ULS-Set(2)	B5537	-73.4	0.1	-26.2	-2.2	51.2	1.1
	B5538	110.5	-0.6	-6.0	-2.4	-8.5	2.5
	B5539	-92.8	-0.3	-23.7	1.2	61.2	1.0
	B5540	308.0	-1.0	-15.4	5.2	-14.2	5.2
	B5541	83.6	0.7	-17.9	-5.2	32.2	2.6
	B5542	-59.0	-0.8	-39.4	-1.4	-64.4	4.5
	B5717	76.6	3.2	-2.0	3.3	-9.0	-13.9
	B5721	87.9	5.0	1.7	-3.8	11.5	-10.9
	B6255	-0.8	0.0	0.0	0.0	0.0	0.0
ULS-Set(3)	B5537	-11.4	0.0	5.0	0.6	-15.2	-0.3
	B5538	8.2	-0.2	-2.5	-1.0	-3.2	0.7
	B5539	-19.6	-0.1	4.4	-1.3	-10.6	0.0
	B5540	162.9	0.7	0.3	-2.3	-6.2	-3.0
	B5541	138.8	0.7	4.9	0.6	-15.0	3.4
	B5542	-124.5	0.1	7.4	2.0	10.5	-1.6
	B5717	17.6	1.6	-0.2	0.2	3.1	-5.3
	B5721	12.0	-1.2	-0.5	0.3	3.1	4.3
	B6255	-0.6	0.0	0.0	0.0	0.0	0.0
ULS-Set(12)	B5537	-72.3	0.1	-24.6	-2.1	48.3	1.1
	B5538	108.5	-0.6	-5.0	-2.3	-7.1	2.4
	B5539	-91.0	-0.3	-22.4	1.1	58.5	0.8
	B5540	300.8	-1.0	-14.3	5.0	-12.7	5.0
	B5541	82.2	0.6	-16.8	-5.1	30.5	2.4
	B5542	-59.8	-0.8	-37.8	-1.5	-62.0	4.4
	B5717	71.4	3.1	-1.5	3.2	-8.2	-13.5
	B5721	82.2	4.8	2.0	-3.8	11.2	-10.2
	B6255	-0.6	0.0	0.0	0.0	0.0	0.0
ULS-Set(13)	B5537	-89.5	0.0	-18.5	-1.6	34.0	0.8
	B5538	99.8	-0.6	-4.7	-2.5	-6.5	2.4
	B5539	-89.4	-0.4	-17.0	0.3	45.5	0.6
	B5540	339.3	-0.5	-11.8	3.3	-12.9	2.9
	B5541	136.3	0.9	-11.9	-4.3	19.1	3.6
	B5542	-111.9	-0.7	-29.2	-0.5	-49.0	3.2
	B5717	67.4	3.4	-0.9	3.0	-5.2	-14.3
	B5721	74.4	3.5	2.0	-3.2	11.4	-6.6
	B6255	-0.6	0.0	0.0	0.0	0.0	0.0
ULS-Set(14)	B5537	-34.9	0.8	-9.7	-0.7	16.5	1.5
	B5538	56.8	-1.3	-4.2	-1.6	-5.7	2.9
	B5539	-52.8	-0.1	-8.9	-0.2	22.4	0.4
	B5540	215.9	0.7	-6.9	1.3	-9.8	-0.5
	B5541	101.6	0.0	-5.8	-1.9	7.0	1.7

Name	Member	N [kN]	Vy [kN]	Vz [kN]	Mx [kNm]	My [kNm]	Mz [kNm]
	B5542	-77.2	-0.1	-14.4	0.4	-24.4	0.6
	B5717	39.8	2.6	-1.3	1.4	-2.7	-9.4
	B5721	46.7	0.9	0.9	-1.2	7.5	-1.6
	B6255	-0.6	0.0	0.0	0.0	0.0	0.0
ULS-Set(17)	B5537	49.3	0.1	2.6	0.9	-3.7	-0.1
	B5538	-67.3	0.3	-3.4	1.8	-5.4	-1.4
	B5539	62.7	0.5	3.2	0.6	-14.8	0.9
	B5540	-251.7	0.0	1.6	-0.7	0.3	-0.4
	B5541	-127.5	-0.6	0.8	2.6	0.3	-2.2
	B5542	120.1	0.6	9.9	0.8	18.9	-2.2
	B5717	-19.5	-2.0	-2.6	-2.0	-1.7	9.5
	B5721	-20.6	-0.8	-3.7	2.4	-7.4	-0.2
	B6255	-0.8	0.0	0.0	0.0	0.0	0.0
ULS-Set(28)	B5537	-59.7	0.0	-19.1	-1.7	37.0	0.8
	B5538	89.3	-0.5	-3.7	-1.9	-4.9	2.0
	B5539	-76.4	-0.3	-17.5	0.8	45.6	0.6
	B5540	262.0	-0.7	-11.4	3.7	-10.4	3.7
	B5541	82.8	0.6	-12.9	-4.1	22.6	2.3
	B5542	-62.6	-0.7	-29.2	-1.1	-48.0	3.5
	B5717	58.8	2.6	-1.4	2.7	-6.4	-11.3
	B5721	66.3	3.8	1.4	-3.0	8.9	-8.1
	B6255	-0.6	0.0	0.0	0.0	0.0	0.0
ULS-Set(29)	B5537	50.4	0.1	4.1	0.9	-6.5	-0.1
	B5538	-69.2	0.3	-2.4	1.9	-3.9	-1.5
	B5539	64.5	0.5	4.5	0.5	-17.5	0.7
	B5540	-259.0	0.0	2.7	-0.9	1.8	-0.6
	B5541	-128.9	-0.6	1.9	2.7	-1.4	-2.4
	B5542	119.3	0.6	11.5	0.7	21.3	-2.2
	B5717	-24.8	-2.2	-2.1	-2.1	-1.0	9.9
	B5721	-26.2	-1.1	-3.4	2.4	-7.7	0.5
	B6255	-0.6	0.0	0.0	0.0	0.0	0.0
ULS-Set(30)	B5537	-70.6	0.0	-20.0	-1.7	36.8	0.8
	B5538	101.8	-0.6	-5.7	-2.6	-8.0	2.5
	B5539	-91.2	-0.4	-18.3	0.4	48.1	0.8
	B5540	346.6	-0.6	-12.8	3.5	-14.4	3.1
	B5541	137.8	0.9	-13.0	-4.4	20.8	3.7
	B5542	-111.1	-0.7	-30.8	-0.4	-51.4	3.3
	B5717	72.7	3.5	-1.4	3.0	-6.0	-14.6
	B5721	80.0	3.8	1.7	-3.3	11.6	-7.3
	B6255	-0.8	0.0	0.0	0.0	0.0	0.0
ULS-Set(40)	B5537	-56.9	0.0	-13.0	-1.2	22.6	0.5
	B5538	80.6	-0.5	-3.4	-2.1	-4.4	2.0
	B5539	-74.8	-0.4	-12.0	0.0	32.6	0.3

Name	Member	N [kN]	Vy [kN]	Vz [kN]	Mx [kNm]	My [kNm]	Mz [kNm]
	B5540	300.5	-0.2	-8.8	2.0	-10.5	1.7
	B5541	137.0	0.8	-8.0	-3.3	11.2	3.4
	B5542	-114.7	-0.6	-20.7	-0.1	-35.0	2.4
	B5717	54.8	2.9	-0.8	2.4	-3.4	-12.0
	B5721	58.5	2.5	1.4	-2.5	9.1	-4.4
	B6255	-0.6	0.0	0.0	0.0	0.0	0.0
ULS-Set(43)	B5537	-25.1	0.0	-2.1	0.1	-1.1	0.0
	B5538	29.3	-0.3	-4.8	-1.5	-6.8	1.2
	B5539	-36.0	-0.2	-1.9	-0.9	5.0	0.4
	B5540	209.0	0.4	-3.7	-0.8	-10.0	-1.6
	B5541	139.6	0.8	0.0	-0.5	-5.4	3.7
	B5542	-120.9	-0.1	-2.7	1.7	-5.9	-0.7
	B5717	35.5	2.2	-0.8	0.9	0.5	-7.9
	B5721	33.6	0.0	-0.2	-0.4	5.7	1.4
	B6255	-0.8	0.0	0.0	0.0	0.0	0.0
ULS-Set(44)	B5537	-34.5	0.4	-4.0	-0.3	3.5	0.8
	B5538	49.6	-0.9	-2.9	-1.7	-3.6	2.3
	B5539	-51.9	-0.2	-3.9	-0.8	10.9	0.0
	B5540	249.6	0.7	-4.4	-0.2	-8.8	-1.6
	B5541	148.6	0.4	-1.4	-1.3	-2.9	3.0
	B5542	-125.1	-0.2	-6.6	1.0	-12.4	0.1
	B5717	35.9	2.6	-0.6	1.3	-0.1	-9.6
	B5721	37.1	0.2	0.7	-1.0	6.9	0.8
	B6255	-0.6	0.0	0.0	0.0	0.0	0.0
ULS-Set(45)	B5537	-48.2	0.5	-11.1	-0.8	17.7	1.1
	B5538	70.8	-1.0	-5.3	-2.1	-7.1	2.8
	B5539	-68.3	-0.3	-10.2	-0.4	26.5	0.5
	B5540	295.7	0.4	-8.4	1.3	-12.7	-0.1
	B5541	149.4	0.5	-6.3	-2.4	6.7	3.3
	B5542	-121.5	-0.3	-16.8	0.7	-28.8	1.0
	B5717	53.7	3.2	-1.3	1.9	-2.7	-12.2
	B5721	58.7	1.4	1.0	-1.7	9.4	-2.1
	B6255	-0.8	0.0	0.0	0.0	0.0	0.0
ULS-Set(49)	B5537	-35.6	0.4	-5.6	-0.4	6.3	0.9
	B5538	51.6	-0.9	-3.9	-1.7	-5.0	2.3
	B5539	-53.7	-0.2	-5.2	-0.7	13.6	0.2
	B5540	256.9	0.7	-5.4	0.0	-10.3	-1.4
	B5541	150.0	0.4	-2.4	-1.4	-1.2	3.2
	B5542	-124.3	-0.2	-8.2	1.1	-14.8	0.1
	B5717	41.1	2.7	-1.1	1.3	-0.8	-10.0
	B5721	42.8	0.4	0.3	-1.0	7.1	0.1
	B6255	-0.8	0.0	0.0	0.0	0.0	0.0
ULS-Set(50)	B5537	-47.2	0.5	-10.9	-0.8	17.1	1.4

Name	Member	N [kN]	Vy [kN]	Vz [kN]	Mx [kNm]	My [kNm]	Mz [kNm]
	B5538	64.7	-0.2	-5.2	-2.1	-6.6	1.3
	B5539	-67.6	-0.8	-10.1	-0.2	26.3	0.0
	B5540	269.8	-0.3	-8.2	1.4	-11.9	1.2
	B5541	133.8	0.6	-6.4	-2.3	7.9	3.4
	B5542	-105.6	-0.8	-16.6	0.8	-28.0	1.9
	B5717	53.3	3.4	-0.8	1.5	-2.1	-11.9
	B5721	51.4	1.8	0.2	-1.7	7.9	-2.8
	B6255	-0.8	0.0	0.0	0.0	0.0	0.0
ULS-Set(54)	B5537	-69.7	0.1	-24.2	-2.0	47.1	1.0
	B5538	103.4	-0.6	-6.1	-2.4	-8.8	2.4
	B5539	-87.2	-0.3	-21.9	1.0	57.0	1.0
	B5540	293.7	-0.9	-14.3	4.8	-13.6	4.6
	B5541	82.2	0.7	-16.4	-4.8	29.6	2.5
	B5542	-60.3	-0.7	-37.0	-1.1	-60.8	4.0
	B5717	71.5	3.1	-1.5	3.1	-7.9	-13.4
	B5721	82.7	4.5	2.1	-3.5	11.5	-9.5
	B6255	-0.6	0.0	0.0	0.0	0.0	0.0
ULS-Set(55)	B5537	-48.4	0.5	-16.8	-1.1	30.8	1.4
	B5538	74.4	-1.0	-6.6	-2.0	-9.4	2.7
	B5539	-66.1	-0.2	-15.1	0.3	38.0	0.9
	B5540	250.1	0.0	-10.9	2.8	-13.4	1.6
	B5541	95.2	0.3	-10.9	-3.0	17.2	2.3
	B5542	-69.9	-0.3	-24.6	0.1	-40.7	1.7
	B5717	57.8	3.0	-1.9	2.0	-5.3	-11.4
	B5721	67.0	2.4	1.0	-2.0	9.6	-5.1
	B6255	-0.8	0.0	0.0	0.0	0.0	0.0

Check

Summary

Name	Value	Status
Analysis	100.0%	OK
Plates	0.2 < 5.0%	OK
Welds	98.0 < 100%	OK
Buckling	Not calculated	
GMNA	Calculated	

Plates

Name	Thickness [mm]	Loads	σ_{Ed} [MPa]	ϵ_{pl} [%]	σ_{cEd} [MPa]	Status
B5537	8.0	ULS-Set(2)	158.9	0.0	0.0	OK
B5538	8.0	ULS-Set(2)	81.6	0.0	0.0	OK
B5539	8.0	ULS-Set(2)	203.1	0.0	0.0	OK
B5540	8.0	ULS-Set(2)	247.8	0.0	0.0	OK
B5541	8.0	ULS-Set(30)	165.0	0.0	0.0	OK
B5542	8.0	ULS-Set(30)	206.9	0.0	0.0	OK
B5717	12.5	ULS-Set(2)	155.5	0.0	0.0	OK
B5721	12.5	ULS-Set(2)	98.9	0.0	0.0	OK
B6255	10.0	ULS-Set(30)	355.4	0.2	0.0	OK
STIFF1	20.0	ULS-Set(30)	178.8	0.0	0.0	OK

Design data

Material	f_y [MPa]	ϵ_{lim} [%]
S 355	355.0	5.0

Symbol explanation

ϵ_{pl}	Strain
σ_{Ed}	Eq. stress
σ_{cEd}	Contact stress
f_y	Yield strength
ϵ_{lim}	Limit of plastic strain

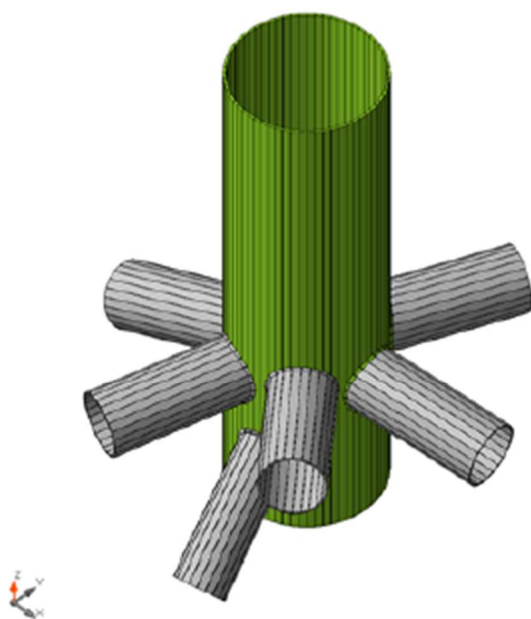

Overall check, ULS-Set(2)

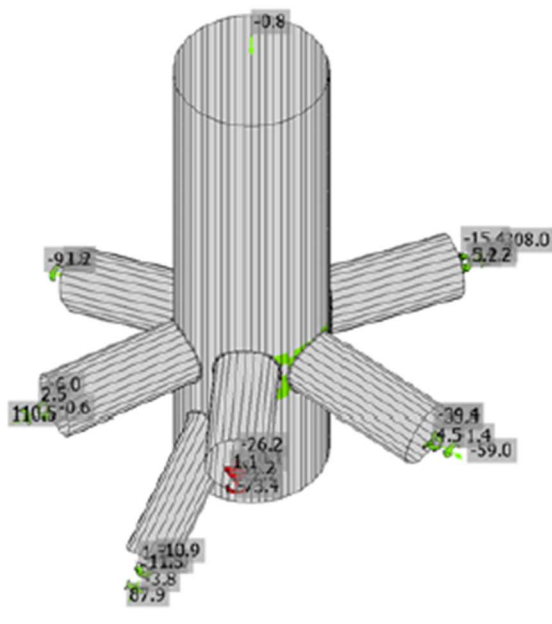

Strain check, ULS-Set(2)

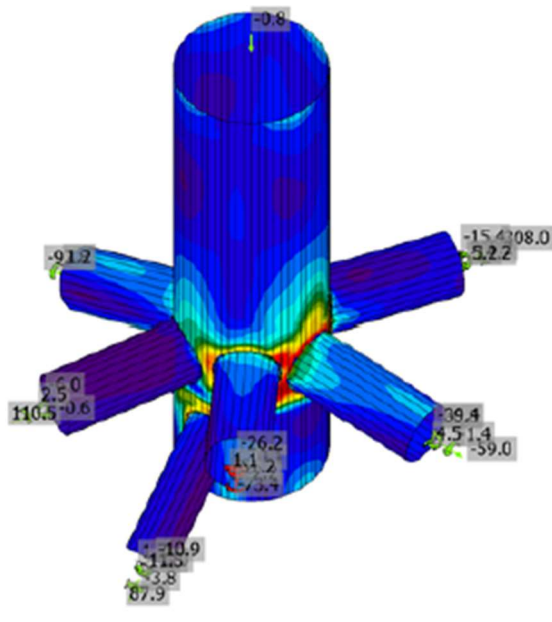

Equivalent stress, ULS-Set(2)

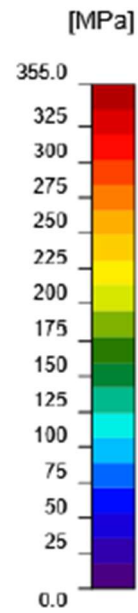

Welds (Plastic redistribution)

Item	Edge	Throat th. [mm]	Length [mm]	Loads	$\sigma_{w,Ed}$ [MPa]	ϵ_{pl} [%]	σ_{\perp} [MPa]	τ_{\parallel} [MPa]	τ_{\perp} [MPa]	Ut [%]	Ut _c [%]	Status
B6255-arc 10	B5717	▲6.0	855	ULS-Set(2)	275.8	0.0	25.6	-114.3	109.9	63.3	23.1	OK
B6255-arc 35	B5721	▲6.0	752	ULS-Set(2)	250.4	0.0	134.7	-35.2	116.6	57.5	20.8	OK
B6255-arc 20	B5539	▲6.0	858	ULS-Set(2)	428.9	0.1	-232.6	140.9	151.2	98.0	33.9	OK
B6255-arc 28	B5538	▲6.0	835	ULS-Set(2)	146.3	0.0	-20.5	-21.7	80.8	33.6	13.3	OK
B6255-arc 38	B5537	▲6.0	835	ULS-Set(2)	225.8	0.0	-147.1	-73.4	66.3	51.8	29.2	OK
B6255-arc 46	B5542	▲6.0	833	ULS-Set(30)	329.5	0.0	255.5	57.5	-105.4	75.6	35.0	OK
B6255-arc 1	B5540	▲6.0	799	ULS-Set(2)	368.6	0.0	35.0	-210.5	23.7	84.6	41.1	OK
B6255-arc 3	B5541	▲6.0	844	ULS-Set(2)	288.8	0.0	203.6	-41.6	-110.7	66.3	24.5	OK
B6255-arc 1	STIFF1	▲4.0▲	30	ULS-Set(30)	257.1	0.0	-32.6	-142.3	-38.0	59.0	59.0	OK
		▲4.0▲	30	ULS-Set(30)	117.0	0.0	26.2	60.0	-27.0	26.9	26.9	OK
B6255-arc 2	STIFF1	▲4.0▲	30	ULS-Set(30)	247.3	0.0	10.8	-142.6	5.3	56.8	56.8	OK
		▲4.0▲	30	ULS-Set(30)	98.7	0.0	3.8	56.7	-5.1	22.7	22.7	OK
B6255-arc 3	STIFF1	▲4.0▲	30	ULS-Set(30)	237.3	0.0	40.2	-131.2	32.0	54.5	54.5	OK
		▲4.0▲	30	ULS-Set(30)	93.1	0.0	-5.3	53.6	1.6	21.4	21.4	OK
B6255-arc 4	STIFF1	▲4.0▲	30	ULS-Set(30)	199.4	0.0	60.6	-103.2	37.2	45.8	45.8	OK
		▲4.0▲	30	ULS-Set(30)	70.1	0.0	-23.5	37.8	5.3	16.1	16.1	OK
B6255-arc 5	STIFF1	▲4.0▲	30	ULS-Set(3)	198.6	0.0	97.0	-46.3	88.7	45.6	45.6	OK
		▲4.0▲	30	ULS-Set(3)	120.7	0.0	39.4	45.8	-47.4	27.7	27.7	OK
B6255-arc 6	STIFF1	▲4.0▲	30	ULS-Set(3)	178.2	0.0	90.0	19.5	86.6	40.9	40.9	OK
		▲4.0▲	30	ULS-Set(2)	167.9	0.0	-85.0	37.6	74.7	38.5	38.5	OK
B6255-arc 7	STIFF1	▲4.0▲	30	ULS-Set(2)	109.4	0.0	3.4	-61.4	-14.5	25.1	25.1	OK
		▲4.0▲	30	ULS-Set(2)	172.2	0.0	-84.3	40.7	76.6	39.5	39.5	OK
B6255-arc 8	STIFF1	▲4.0▲	30	ULS-Set(2)	102.2	0.0	-17.8	-46.2	-35.2	23.5	23.5	OK
		▲4.0▲	30	ULS-Set(2)	198.2	0.0	-97.7	41.6	90.4	45.5	45.5	OK
B6255-arc 9	STIFF1	▲4.0▲	30	ULS-Set(2)	131.8	0.0	-27.6	-67.8	-30.8	30.3	30.3	OK
		▲4.0▲	30	ULS-Set(2)	188.2	0.0	-66.6	70.9	72.8	43.2	43.2	OK
B6255-arc 10	STIFF1	▲4.0▲	30	ULS-Set(2)	88.6	0.0	-2.2	-51.1	-0.6	20.3	20.3	OK
		▲4.0▲	30	ULS-Set(2)	99.3	0.0	-14.3	51.0	24.8	22.8	22.8	OK
B6255-arc 11	STIFF1	▲4.0▲	30	ULS-Set(2)	60.5	0.0	20.6	-28.7	15.9	13.9	13.9	OK
		▲4.0▲	30	ULS-Set(2)	56.4	0.0	5.5	32.4	-1.4	12.9	12.9	OK
B6255-arc 12	STIFF1	▲4.0▲	30	ULS-Set(2)	43.7	0.0	13.2	-11.8	21.0	10.0	10.0	OK
		▲4.0▲	30	ULS-Set(30)	28.4	0.0	10.0	15.3	1.6	6.5	6.5	OK
B6255-arc 13	STIFF1	▲4.0▲	30	ULS-Set(17)	41.6	0.0	9.9	-23.4	-0.5	9.6	9.6	OK
		▲4.0▲	30	ULS-Set(2)	44.6	0.0	19.7	-22.8	3.8	10.2	10.2	OK
B6255-arc 14	STIFF1	▲4.0▲	30	ULS-Set(2)	187.8	0.0	-62.2	83.1	-59.7	43.1	43.1	OK
		▲4.0▲	30	ULS-Set(2)	283.2	0.0	-94.9	-110.1	107.7	65.0	65.0	OK
B6255-arc 15	STIFF1	▲4.0▲	30	ULS-Set(2)	99.5	0.0	-27.9	-12.9	-53.6	22.8	22.8	OK
		▲4.0▲	30	ULS-Set(2)	335.8	0.0	-175.2	-28.2	162.9	77.1	77.1	OK
B6255-arc 16	STIFF1	▲4.0▲	30	ULS-Set(2)	64.4	0.0	47.0	19.9	15.9	14.8	14.8	OK

Item	Edge	Throat th. [mm]	Length [mm]	Loads	$\sigma_{w,Ed}$ [MPa]	ϵ_{pl} [%]	σ_{\perp} [MPa]	τ_{\parallel} [MPa]	τ_{\perp} [MPa]	Ut [%]	Ut _c [%]	Status
		▲4.0▲	30	ULS-Set(2)	201.6	0.0	-109.4	-30.5	92.9	46.3	46.3	OK
B6255-arc 17	STIFF1	▲4.0▲	30	ULS-Set(2)	86.6	0.0	48.3	27.9	30.7	19.9	19.9	OK
		▲4.0▲	30	ULS-Set(2)	173.9	0.0	-97.8	-19.2	84.5	39.9	39.9	OK
B6255-arc 18	STIFF1	▲4.0▲	30	ULS-Set(2)	108.2	0.0	57.1	33.7	41.0	24.9	24.9	OK
		▲4.0▲	30	ULS-Set(2)	181.4	0.0	-90.9	-17.5	88.9	41.7	41.7	OK
B6255-arc 19	STIFF1	▲4.0▲	30	ULS-Set(2)	95.1	0.0	56.5	36.9	24.3	21.8	21.8	OK
		▲4.0▲	30	ULS-Set(2)	199.3	0.0	-113.3	-0.3	94.7	45.8	45.8	OK
B6255-arc 20	STIFF1	▲4.0▲	30	ULS-Set(2)	204.4	0.0	-8.9	99.5	-63.2	46.9	46.9	OK
		▲4.0▲	30	ULS-Set(2)	407.2	0.0	-233.5	-18.9	191.7	93.5	93.5	OK
B6255-arc 21	STIFF1	▲4.0▲	30	ULS-Set(2)	160.6	0.0	-72.9	-20.2	-80.1	36.9	36.9	OK
		▲4.0▲	30	ULS-Set(2)	387.1	0.0	-161.3	120.5	163.6	88.9	88.9	OK
B6255-arc 22	STIFF1	▲4.0▲	30	ULS-Set(2)	98.8	0.0	-31.4	52.7	-12.2	22.7	22.7	OK
		▲4.0▲	30	ULS-Set(2)	65.9	0.0	18.9	35.8	7.1	15.1	15.1	OK
B6255-arc 23	STIFF1	▲4.0▲	30	ULS-Set(2)	142.6	0.0	-2.8	82.2	4.3	32.7	32.7	OK
		▲4.0▲	30	ULS-Set(2)	60.5	0.0	38.5	-9.3	-25.3	13.9	13.9	OK
B6255-arc 24	STIFF1	▲4.0▲	30	ULS-Set(2)	168.8	0.0	-28.6	94.1	-19.5	38.8	38.8	OK
		▲4.0▲	30	ULS-Set(2)	106.3	0.0	52.2	-38.4	-37.2	24.4	24.4	OK
B6255-arc 25	STIFF1	▲4.0▲	30	ULS-Set(2)	173.2	0.0	-35.7	94.0	-27.0	39.8	39.8	OK
		▲4.0▲	30	ULS-Set(2)	132.4	0.0	54.2	-57.4	-39.7	30.4	30.4	OK
B6255-arc 26	STIFF1	▲4.0▲	30	ULS-Set(2)	182.1	0.0	-53.3	92.1	-40.2	41.8	41.8	OK
		▲4.0▲	30	ULS-Set(2)	143.6	0.0	53.5	-68.7	-34.5	33.0	33.0	OK
B6255-arc 27	STIFF1	▲4.0▲	30	ULS-Set(2)	191.6	0.0	-70.9	84.5	-58.5	44.0	44.0	OK
		▲4.0▲	30	ULS-Set(2)	156.3	0.0	49.5	-79.8	-31.0	35.9	35.9	OK
B6255-arc 28	STIFF1	▲4.0▲	30	ULS-Set(2)	192.9	0.0	-86.3	71.0	-69.9	44.3	44.3	OK
		▲4.0▲	30	ULS-Set(2)	154.5	0.0	44.4	-82.6	-21.8	35.5	35.5	OK
B6255-arc 29	STIFF1	▲4.0▲	30	ULS-Set(2)	147.5	0.0	-73.1	45.8	-58.1	33.9	33.9	OK
		▲4.0▲	30	ULS-Set(2)	146.7	0.0	15.8	-84.1	4.7	33.7	33.7	OK
B6255-arc 30	STIFF1	▲4.0▲	30	ULS-Set(30)	125.4	0.0	-62.5	31.5	-54.3	28.8	28.8	OK
		▲4.0▲	30	ULS-Set(2)	120.4	0.0	-8.7	-67.4	16.3	27.7	27.7	OK
B6255-arc 31	STIFF1	▲4.0▲	30	ULS-Set(45)	67.7	0.0	-34.8	12.0	-31.3	15.5	15.5	OK
		▲4.0▲	30	ULS-Set(2)	111.6	0.0	-37.8	-52.1	30.9	25.6	25.6	OK
B6255-arc 32	STIFF1	▲4.0▲	30	ULS-Set(44)	29.9	0.0	-14.2	5.2	-14.3	6.9	6.9	OK
		▲4.0▲	30	ULS-Set(2)	138.1	0.0	-77.3	-24.7	61.3	31.7	31.7	OK
B6255-arc 33	STIFF1	▲4.0▲	30	ULS-Set(2)	36.6	0.0	34.0	-2.3	7.5	9.6	8.4	OK
		▲4.0▲	30	ULS-Set(2)	143.0	0.0	-88.2	2.5	65.0	32.8	32.8	OK
B6255-arc 34	STIFF1	▲4.0▲	30	ULS-Set(2)	39.9	0.0	33.8	-11.3	4.8	9.6	9.2	OK
		▲4.0▲	30	ULS-Set(2)	121.4	0.0	-69.2	37.5	43.7	27.9	27.9	OK
B6255-arc 35	STIFF1	▲4.0▲	30	ULS-Set(17)	37.1	0.0	7.4	17.8	11.1	8.5	8.5	OK
		▲4.0▲	30	ULS-Set(2)	121.0	0.0	-36.4	62.1	24.0	27.8	27.8	OK
B6255-arc 36	STIFF1	▲4.0▲	30	ULS-Set(17)	50.5	0.0	13.6	25.6	11.5	11.6	11.6	OK
		▲4.0▲	30	ULS-Set(2)	114.7	0.0	8.5	66.0	-0.4	26.3	26.3	OK

Item	Edge	Throat th. [mm]	Length [mm]	Loads	$\sigma_{w,Ed}$ [MPa]	ϵ_{pI} [%]	σ_{\perp} [MPa]	τ_{\parallel} [MPa]	τ_{\perp} [MPa]	Ut [%]	Ut _c [%]	Status
B6255-arc 37	STIFF1	▲4.0▲	30	ULS-Set(2)	97.6	0.0	-52.4	-21.9	-42.2	22.4	22.4	OK
		▲4.0▲	30	ULS-Set(2)	125.9	0.0	51.8	57.2	-33.4	28.9	28.9	OK
B6255-arc 38	STIFF1	▲4.0▲	30	ULS-Set(2)	136.3	0.0	-75.2	-36.8	-54.3	31.3	31.3	OK
		▲4.0▲	30	ULS-Set(2)	124.8	0.0	68.5	46.5	-38.3	28.7	28.7	OK
B6255-arc 39	STIFF1	▲4.0▲	30	ULS-Set(2)	157.9	0.0	-75.3	-58.7	-54.5	36.3	36.3	OK
		▲4.0▲	30	ULS-Set(2)	110.3	0.0	62.6	41.4	-32.2	25.3	25.3	OK
B6255-arc 40	STIFF1	▲4.0▲	30	ULS-Set(2)	183.5	0.0	-71.1	-81.7	-53.4	42.1	42.1	OK
		▲4.0▲	30	ULS-Set(30)	101.8	0.0	45.1	45.8	-26.1	23.4	23.4	OK
B6255-arc 41	STIFF1	▲4.0▲	30	ULS-Set(2)	189.6	0.0	-43.6	-100.0	-36.8	43.5	43.5	OK
		▲4.0▲	30	ULS-Set(30)	86.9	0.0	28.2	43.5	-19.0	20.0	20.0	OK
B6255-arc 42	STIFF1	▲4.0▲	30	ULS-Set(2)	186.5	0.0	-4.2	-107.5	-5.3	42.8	42.8	OK
		▲4.0▲	30	ULS-Set(30)	66.3	0.0	5.5	38.0	-3.3	15.2	15.2	OK
B6255-arc 43	STIFF1	▲4.0▲	30	ULS-Set(2)	178.4	0.0	32.2	-99.4	19.7	41.0	41.0	OK
		▲4.0▲	30	ULS-Set(2)	59.9	0.0	-17.9	31.9	8.6	13.8	13.8	OK
B6255-arc 44	STIFF1	▲4.0▲	30	ULS-Set(2)	154.7	0.0	59.6	-73.4	37.5	35.5	35.5	OK
		▲4.0▲	30	ULS-Set(2)	64.1	0.0	-34.8	27.3	14.8	14.7	14.7	OK
B6255-arc 45	STIFF1	▲4.0▲	30	ULS-Set(2)	140.6	0.0	77.5	-42.5	52.7	32.3	32.3	OK
		▲4.0▲	30	ULS-Set(2)	70.7	0.0	-47.2	18.8	23.9	16.2	16.2	OK
B6255-arc 46	STIFF1	▲4.0▲	30	ULS-Set(2)	88.5	0.0	61.6	-5.6	36.2	20.3	20.3	OK
		▲4.0▲	30	ULS-Set(2)	54.4	0.0	-40.1	13.8	16.2	12.5	12.5	OK
B6255-arc 47	STIFF1	▲4.0▲	30	ULS-Set(2)	80.6	0.0	45.0	28.9	25.6	18.5	18.5	OK
		▲4.0▲	30	ULS-Set(2)	52.2	0.0	-38.1	-2.4	20.5	12.0	12.0	OK
B6255-arc 48	STIFF1	▲4.0▲	30	ULS-Set(2)	123.1	0.0	-22.6	65.2	-25.0	28.3	28.3	OK
		▲4.0▲	30	ULS-Set(2)	63.2	0.0	-27.2	-18.1	27.5	14.5	14.5	OK
B6255-arc 49	STIFF1	▲4.0▲	30	ULS-Set(2)	222.7	0.0	-105.8	67.6	-90.7	51.1	51.1	OK
		▲4.0▲	30	ULS-Set(30)	68.6	0.0	-11.2	-32.6	21.5	15.8	15.8	OK
B6255-arc 50	STIFF1	▲4.0▲	30	ULS-Set(2)	253.1	0.0	-136.0	51.8	-111.9	58.1	58.1	OK
		▲4.0▲	30	ULS-Set(30)	78.4	0.0	-12.2	-34.6	28.3	18.0	18.0	OK
B6255-arc 51	STIFF1	▲4.0▲	30	ULS-Set(2)	222.5	0.0	-128.3	31.9	-100.0	51.1	51.1	OK
		▲4.0▲	30	ULS-Set(30)	83.8	0.0	-8.9	-39.2	28.0	19.2	19.2	OK
B6255-arc 52	STIFF1	▲4.0▲	30	ULS-Set(3)	145.7	0.0	55.6	62.8	45.8	33.5	33.5	OK
		▲4.0▲	30	ULS-Set(30)	78.9	0.0	-12.6	-41.5	17.3	18.1	18.1	OK
B6255-arc 53	STIFF1	▲4.0▲	30	ULS-Set(3)	134.9	0.0	31.0	70.5	28.0	31.0	31.0	OK
		▲4.0▲	30	ULS-Set(30)	95.8	0.0	-24.9	-52.7	8.8	22.0	22.0	OK
B6255-arc 54	STIFF1	▲4.0▲	30	ULS-Set(45)	161.3	0.0	30.0	89.7	17.9	37.0	37.0	OK
		▲4.0▲	30	ULS-Set(30)	107.2	0.0	-28.9	-58.3	12.4	24.6	24.6	OK
B6255-arc 55	STIFF1	▲4.0▲	30	ULS-Set(30)	195.9	0.0	36.5	109.5	18.7	45.0	45.0	OK
		▲4.0▲	30	ULS-Set(30)	109.8	0.0	-29.3	-59.9	12.1	25.2	25.2	OK
B6255-arc 56	STIFF1	▲4.0▲	30	ULS-Set(30)	221.2	0.0	12.2	127.5	-4.1	50.8	50.8	OK
		▲4.0▲	30	ULS-Set(30)	103.9	0.0	-13.4	-59.5	-1.5	23.9	23.9	OK
B6255-arc 57	STIFF1	▲4.0▲	30	ULS-Set(30)	227.1	0.0	-10.8	130.1	-15.5	52.1	52.1	OK

Item	Edge	Throat th. [mm]	Length [mm]	Loads	$\sigma_{w,Ed}$ [MPa]	ϵ_{pl} [%]	σ_{\perp} [MPa]	τ_{\parallel} [MPa]	τ_{\perp} [MPa]	Ut [%]	Ut _c [%]	Status
		▲4.0▲	30	ULS-Set(30)	99.5	0.0	-2.7	-57.4	0.4	22.8	22.8	OK
B6255-arc 58	STIFF1	▲4.0▲	30	ULS-Set(30)	235.8	0.0	-55.2	121.0	-53.7	54.1	54.1	OK
		▲4.0▲	30	ULS-Set(30)	92.4	0.0	18.3	-50.7	-12.8	21.2	21.2	OK
B6255-arc 59	STIFF1	▲4.0▲	30	ULS-Set(30)	254.2	0.0	-103.7	95.4	-94.1	58.4	58.4	OK
		▲4.0▲	30	ULS-Set(30)	93.7	0.0	42.0	-40.7	-26.1	21.5	21.5	OK
B6255-arc 60	STIFF1	▲4.0▲	30	ULS-Set(30)	243.3	0.0	-129.1	53.0	-106.6	55.9	55.9	OK
		▲4.0▲	30	ULS-Set(30)	84.3	0.0	60.1	-17.0	-29.6	19.4	19.4	OK
B6255-arc 61	STIFF1	▲4.0▲	30	ULS-Set(30)	247.1	0.0	-143.1	-8.9	-115.9	56.7	56.7	OK
		▲4.0▲	30	ULS-Set(30)	96.9	0.0	71.2	13.9	-35.3	22.2	22.2	OK
B6255-arc 62	STIFF1	▲4.0▲	30	ULS-Set(30)	267.3	0.0	-136.4	-60.8	-118.0	61.4	61.4	OK
		▲4.0▲	30	ULS-Set(30)	114.4	0.0	65.4	37.8	-38.8	26.3	26.3	OK
B6255-arc 63	STIFF1	▲4.0▲	30	ULS-Set(30)	259.9	0.0	-103.1	-106.7	-87.1	59.7	59.7	OK
		▲4.0▲	30	ULS-Set(30)	118.1	0.0	57.8	48.2	-34.9	27.1	27.1	OK
B6255-arc 64	STIFF1	▲4.0▲	30	ULS-Set(30)	252.4	0.0	-56.7	-133.7	-47.7	57.9	57.9	OK
		▲4.0▲	30	ULS-Set(30)	113.5	0.0	34.8	58.9	-20.4	26.1	26.1	OK

Design data

	β_w [-]	$\sigma_{w,Rd}$ [MPa]	0.9σ [MPa]
S 355	0.90	435.6	352.8

Symbol explanation

ϵ_{pl}	Strain
$\sigma_{w,Ed}$	Equivalent stress
$\sigma_{w,Rd}$	Equivalent stress resistance
σ_{\perp}	Perpendicular stress
τ_{\parallel}	Shear stress parallel to weld axis
τ_{\perp}	Shear stress perpendicular to weld axis
0.9σ	Perpendicular stress resistance - $0.9 \cdot f_u / \gamma_{M2}$
β_w	Correlation factor EN 1993-1-8 tab. 4.1
Ut	Utilization
Ut _c	Weld capacity utilization

Buckling

Buckling analysis was not calculated.

Code settings

Item	Value	Unit	Reference
YM0	1.00	-	EN 1993-1-1: 6.1
YM1	1.00	-	EN 1993-1-1: 6.1
YM2	1.25	-	EN 1993-1-1: 6.1
YM3	1.25	-	EN 1993-1-8: 2.2

Item	Value	Unit	Reference
Yc	1.50	-	EN 1992-1-1: 2.4.2.4
Y _{Inst}	1.20	-	EN 1992-4: Table 4.1
Joint coefficient β _j	0.67	-	EN 1993-1-8: 6.2.5
Effective area - influence of mesh size	0.10	-	
Friction coefficient - concrete	0.25	-	EN 1993-1-8
Friction coefficient in slip-resistance	0.30	-	EN 1993-1-8 tab 3.7
Limit plastic strain	0.05	-	EN 1993-1-5
Weld stress evaluation	Plastic redistribution		
Detailing	No		
Distance between bolts [d]	2.20	-	EN 1993-1-8: tab 3.3
Distance between bolts and edge [d]	1.20	-	EN 1993-1-8: tab 3.3
Concrete breakout resistance check	Both		EN 1992-4: 7.2.1.4 and 7.2.2.5
Use calculated a _b in bearing check.	Yes		EN 1993-1-8: tab 3.4
Cracked concrete	Yes		EN 1992-4
Local deformation check	No		CIDECT DG 1, 3 - 1.1
Local deformation limit	0.03	-	CIDECT DG 1, 3 - 1.1
Geometrical nonlinearity (GMNA)	Yes		Analysis with large deformations for hollow section joints
Braced system	No		EN 1993-1-8: 5.2.2.5

5.5. Karakteristično spoj vrha stupa „S2“

Design

Name	Con N5711
Description	
Analysis	Stress, strain/ loads in equilibrium

Beams and columns

Name	Cross-section	β - Direction [°]	γ - Pitch [°]	α - Rotation [°]	Offset ex [mm]	Offset ey [mm]	Offset ez [mm]	Forces in
B5563	1 - Massive O Hollow(CHS273,8)	0.0	0.0	0.0	100	0	0	Position
B5568	1 - Massive O Hollow(CHS273,8)	0.0	0.0	0.0	100	0	0	Position
B5574	1 - Massive O Hollow(CHS273,8)	0.0	0.0	0.0	100	0	0	Position
B6213	2 - CHS(cf)355.6/8.0	0.0	0.0	0.0	200	0	0	Position
B6216	1 - Massive O Hollow(CHS273,8)	0.0	0.0	0.0	-125	0	-250	Position
B6217	1 - Massive O Hollow(CHS273,8)	0.0	0.0	0.0	-100	0	-250	Position

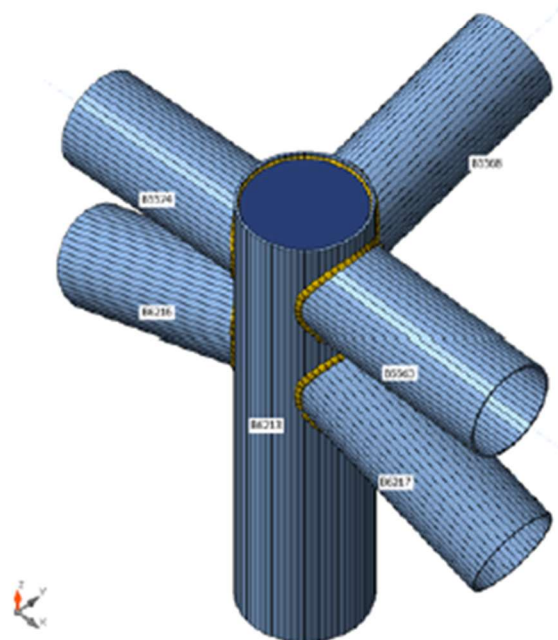

Cross-sections

Name	Material
1 - Massive O Hollow(CHS273,8)	S 355
2 - CHS(cf)355.6/8.0	S 355

Load effects (forces in equilibrium)

Name	Member	N [kN]	Vy [kN]	Vz [kN]	Mx [kNm]	My [kNm]	Mz [kNm]
ULS-Set(1)	B5563	445.7	2.3	-7.4	-8.5	19.3	10.2
	B5568	6.6	0.5	-0.8	-0.3	-1.0	0.8
	B5574	459.3	-2.7	-9.0	9.1	20.9	-11.4
	B6213	-2.8	-15.2	-0.8	0.8	0.0	-13.2
	B6216	67.3	1.9	2.7	-0.9	5.1	-6.3
	B6217	53.0	-1.7	1.9	0.4	2.9	6.0
ULS-Set(2)	B5563	419.4	1.9	-6.2	-7.0	16.5	8.6
	B5568	-10.6	0.1	-15.1	-0.5	36.6	0.4
	B5574	431.4	-2.0	-6.7	6.9	16.5	-8.8
	B6213	17.0	-2.5	0.1	0.1	0.4	-42.5
	B6216	57.6	2.4	2.0	1.4	3.7	-7.8
	B6217	44.7	-2.4	1.9	-1.4	3.4	7.7
ULS-Set(5)	B5563	280.3	1.9	-6.9	-7.2	16.7	8.7
	B5568	40.6	1.2	29.3	0.2	-81.5	1.5
	B5574	286.1	-2.9	-9.1	9.2	19.7	-11.4
	B6213	-40.3	-35.5	-2.3	2.0	-1.4	56.6
	B6216	50.3	-0.2	2.1	-5.4	4.7	0.1
	B6217	44.9	0.7	0.2	4.0	0.0	-0.4
ULS-Set(8)	B5563	398.4	2.1	-5.5	-7.8	15.6	9.1
	B5568	4.8	0.5	-2.0	-0.3	2.5	0.8
	B5574	408.9	-2.4	-6.2	8.2	16.1	-10.2
	B6213	-3.1	-13.1	-0.8	0.8	-0.5	-15.0
	B6216	56.9	1.8	2.6	-0.6	4.6	-5.8
	B6217	45.9	-1.6	2.1	0.1	3.2	5.5
ULS-Set(9)	B5563	316.9	1.6	-4.1	-6.0	11.9	7.0
	B5568	-1.1	0.3	-6.1	-0.3	13.2	0.5
	B5574	323.3	-1.8	-3.9	6.1	11.2	-7.6
	B6213	4.2	-7.1	-0.5	0.5	-0.6	-21.0
	B6216	41.5	1.6	1.7	0.2	3.0	-5.2
	B6217	34.9	-1.5	1.6	-0.5	2.7	5.0
ULS-Set(18)	B5563	426.2	2.2	-6.5	-8.3	17.6	9.8
	B5568	5.9	0.5	-1.7	-0.3	0.8	0.9
	B5574	436.7	-2.6	-7.2	8.8	18.1	-11.0
	B6213	-2.3	-14.5	-0.9	0.8	-0.5	-14.4
	B6216	60.7	1.9	2.5	-0.8	4.6	-6.1
	B6217	49.8	-1.7	1.9	0.2	3.0	5.9
ULS-Set(21)	B5563	260.0	1.1	-6.1	-3.6	13.3	5.1
	B5568	-8.9	0.0	-10.7	-0.3	25.8	0.1
	B5574	270.2	-1.1	-7.6	3.6	15.1	-4.9
	B6213	17.4	0.6	0.5	-0.1	1.3	-27.7
	B6216	40.8	1.5	0.5	1.0	1.8	-5.0

Name	Member	N [kN]	Vy [kN]	Vz [kN]	Mx [kNm]	My [kNm]	Mz [kNm]
	B6217	29.5	-1.5	0.3	-0.9	1.1	5.0
ULS-Set(23)	B5563	310.1	1.3	-3.9	-4.7	10.8	5.8
	B5568	-17.6	-0.1	-19.5	-0.5	49.0	0.1
	B5574	318.1	-1.2	-3.4	4.2	9.7	-5.5
	B6213	23.4	4.9	0.4	-0.3	0.4	-49.1
	B6216	38.3	2.2	1.2	2.3	2.1	-6.9
	B6217	29.7	-2.3	1.6	-2.1	3.0	6.8
ULS-Set(27)	B5563	277.1	1.8	-4.6	-2.8	11.3	6.4
	B5568	1.7	0.0	-5.6	-0.3	10.5	0.1
	B5574	283.2	-1.9	-5.3	2.8	12.1	-6.7
	B6213	11.7	-9.0	0.1	0.2	0.5	-11.3
	B6216	28.9	1.1	1.2	0.8	2.4	-4.5
	B6217	22.3	-1.2	1.0	-0.9	1.9	4.5
ULS-Set(28)	B5563	318.9	1.6	-4.7	-3.6	11.9	6.3
	B5568	-13.6	-0.2	-17.5	-0.5	43.1	-0.1
	B5574	328.2	-1.5	-5.1	3.1	12.1	-5.9
	B6213	25.0	1.4	0.7	-0.3	1.1	-40.9
	B6216	36.9	1.9	1.2	2.3	2.3	-6.7
	B6217	26.6	-2.1	1.5	-2.1	2.8	6.7
ULS-Set(29)	B5563	346.7	1.8	-5.6	-4.0	13.9	7.0
	B5568	-12.5	-0.1	-17.2	-0.5	41.4	0.0
	B5574	356.0	-1.7	-6.1	3.7	14.1	-6.7
	B6213	25.8	0.0	0.6	-0.2	1.0	-40.2
	B6216	40.8	2.0	1.1	2.2	2.4	-7.0
	B6217	30.5	-2.1	1.3	-2.0	2.7	7.1
ULS-Set(30)	B5563	237.4	1.2	-3.3	-1.7	8.2	4.1
	B5568	-19.5	-0.4	-21.7	-0.5	53.8	-0.4
	B5574	242.6	-0.9	-2.9	1.0	7.3	-3.4
	B6213	32.3	7.4	1.0	-0.6	1.0	-46.9
	B6216	21.5	1.7	0.3	3.1	0.8	-6.1
	B6217	15.6	-2.0	0.9	-2.7	2.3	6.2
ULS-Set(32)	B5563	373.0	2.1	-6.9	-5.5	16.7	8.6
	B5568	4.7	0.3	-3.0	-0.3	3.8	0.4
	B5574	383.8	-2.4	-8.4	5.8	18.5	-9.3
	B6213	6.1	-12.8	-0.2	0.5	0.6	-11.0
	B6216	50.5	1.5	1.8	-0.1	3.8	-5.5
	B6217	38.9	-1.4	1.3	-0.2	2.2	5.4
ULS-Set(33)	B5563	265.2	1.3	-4.2	-2.2	10.2	4.8
	B5568	-18.5	-0.3	-21.4	-0.5	52.2	-0.3
	B5574	270.4	-1.1	-3.8	1.5	9.3	-4.2
	B6213	33.1	6.0	0.9	-0.5	0.9	-46.2
	B6216	25.3	1.8	0.1	3.0	0.9	-6.4
	B6217	19.5	-2.0	0.7	-2.6	2.2	6.5

Name	Member	N [kN]	Vy [kN]	Vz [kN]	Mx [kNm]	My [kNm]	Mz [kNm]
ULS-Set(34)	B5563	391.6	1.8	-5.3	-6.6	14.5	7.9
	B5568	-11.7	0.1	-15.3	-0.5	38.2	0.3
	B5574	403.7	-1.8	-5.7	6.4	14.5	-8.0
	B6213	16.2	-1.1	0.1	0.0	0.5	-43.1
	B6216	53.7	2.3	2.1	1.5	3.6	-7.5
	B6217	40.8	-2.3	2.1	-1.5	3.5	7.3
ULS-Set(37)	B5563	181.7	0.8	-3.1	-2.1	7.3	3.2
	B5568	-14.8	-0.8	-14.6	-0.2	36.2	-0.9
	B5574	188.0	-0.4	-2.8	1.2	6.6	-2.3
	B6213	23.8	6.5	0.6	-0.5	0.7	-33.5
	B6216	18.2	1.3	-0.2	1.9	0.3	-4.3
	B6217	12.1	-1.5	0.6	-1.4	1.7	4.5
ULS-Set(38)	B5563	229.0	0.8	-3.2	-2.5	8.0	3.5
	B5568	-25.8	-0.8	-24.5	-0.4	62.8	-0.8
	B5574	236.9	-0.4	-2.7	1.3	6.9	-2.2
	B6213	35.2	13.1	1.1	-0.8	1.1	-56.6
	B6216	24.4	2.0	0.0	3.3	0.4	-6.3
	B6217	16.0	-2.3	1.0	-2.6	2.5	6.5
ULS-Set(40)	B5563	223.5	1.5	-4.1	-1.4	9.6	5.0
	B5568	-3.2	-0.1	-9.5	-0.4	19.7	-0.1
	B5574	225.4	-1.4	-4.0	1.3	9.2	-4.9
	B6213	19.7	-4.4	0.3	0.0	0.4	-16.6
	B6216	17.3	1.0	0.1	1.4	0.9	-4.2
	B6217	15.2	-1.1	0.2	-1.4	1.3	4.3
ULS-Set(42)	B5563	260.8	1.8	-6.0	-7.0	14.9	8.3
	B5568	39.8	1.1	28.5	0.1	-79.6	1.5
	B5574	263.5	-2.8	-7.3	8.9	16.8	-11.0
	B6213	-39.8	-34.8	-2.5	2.1	-1.9	55.4
	B6216	43.7	-0.2	1.9	-5.2	4.2	0.2
	B6217	41.7	0.7	0.2	3.8	0.1	-0.6
ULS-Set(48)	B5563	338.3	1.5	-5.6	-4.8	13.7	6.3
	B5568	-18.8	-0.5	-20.1	-0.4	50.4	-0.5
	B5574	350.2	-1.2	-6.0	4.0	13.7	-5.6
	B6213	28.8	5.7	0.7	-0.4	1.1	-49.9
	B6216	43.6	2.2	0.8	2.4	2.0	-7.2
	B6217	31.0	-2.4	1.3	-2.0	2.8	7.4
ULS-Set(50)	B5563	205.9	0.6	-3.9	-1.7	8.5	2.7
	B5568	-27.2	-0.4	-25.2	-0.5	65.1	-0.4
	B5574	214.6	-0.2	-4.3	0.9	8.7	-1.6
	B6213	36.4	14.8	1.4	-0.9	1.8	-57.6
	B6216	27.3	1.9	-0.1	3.4	0.4	-6.2
	B6217	17.2	-2.1	0.6	-2.8	1.7	6.3
ULS-Set(53)	B5563	256.9	1.0	-4.2	-2.9	10.0	4.2

Name	Member	N [kN]	Vy [kN]	Vz [kN]	Mx [kNm]	My [kNm]	Mz [kNm]
	B5568	-24.8	-0.7	-24.3	-0.5	61.1	-0.7
	B5574	264.6	-0.6	-3.7	1.9	8.9	-3.0
	B6213	36.0	11.7	1.0	-0.7	1.1	-55.9
	B6216	28.2	2.1	-0.1	3.2	0.5	-6.7
	B6217	19.9	-2.3	0.8	-2.6	2.3	6.9
ULS-Set(55)	B5563	338.0	1.5	-4.8	-5.2	12.7	6.4
	B5568	-16.6	0.0	-19.2	-0.5	47.4	0.1
	B5574	345.8	-1.4	-4.4	4.8	11.7	-6.3
	B6213	24.2	3.5	0.4	-0.2	0.3	-48.4
	B6216	42.1	2.3	1.0	2.2	2.1	-7.2
	B6217	33.6	-2.3	1.4	-2.0	2.9	7.1
ULS-Set(56)	B5563	417.9	2.1	-6.5	-8.1	17.3	9.6
	B5568	5.6	0.5	-1.1	-0.3	0.6	0.8
	B5574	431.5	-2.5	-8.0	8.5	18.9	-10.6
	B6213	-3.6	-13.8	-0.7	0.7	0.1	-13.9
	B6216	63.5	1.8	2.9	-0.8	5.0	-5.9
	B6217	49.1	-1.6	2.1	0.3	3.0	5.7
ULS-Set(58)	B5563	304.9	1.9	-5.5	-3.2	13.3	7.1
	B5568	2.7	0.1	-5.4	-0.4	8.9	0.1
	B5574	311.0	-2.1	-6.3	3.4	14.1	-7.5
	B6213	12.5	-10.4	0.0	0.3	0.5	-10.7
	B6216	32.7	1.2	1.0	0.6	2.5	-4.8
	B6217	26.2	-1.2	0.8	-0.8	1.8	4.9

Check

Summary

Name	Value	Status
Analysis	100.0%	OK
Plates	0.4 < 5.0%	OK
Welds	98.1 < 100%	OK
Buckling	Not calculated	
GMNA	Calculated	

Plates

Name	Thickness [mm]	Loads	σ_{Ed} [MPa]	ϵ_{pl} [%]	σ_{cEd} [MPa]	Status
B5563	8.0	ULS-Set(38)	340.2	0.0	0.0	OK
B5568	8.0	ULS-Set(5)	317.1	0.0	0.0	OK
B5574	8.0	ULS-Set(38)	308.1	0.0	0.0	OK
B6213	8.0	ULS-Set(2)	355.9	0.4	0.0	OK
B6216	8.0	ULS-Set(2)	129.2	0.0	0.0	OK
B6217	8.0	ULS-Set(2)	144.4	0.0	0.0	OK
STIFF1	12.0	ULS-Set(1)	241.7	0.0	0.0	OK

Design data

Material	f_y [MPa]	ϵ_{lim} [%]
S 355	355.0	5.0

Symbol explanation

ϵ_{pl}	Strain
σ_{Ed}	Eq. stress
σ_{cEd}	Contact stress
f_y	Yield strength
ϵ_{lim}	Limit of plastic strain

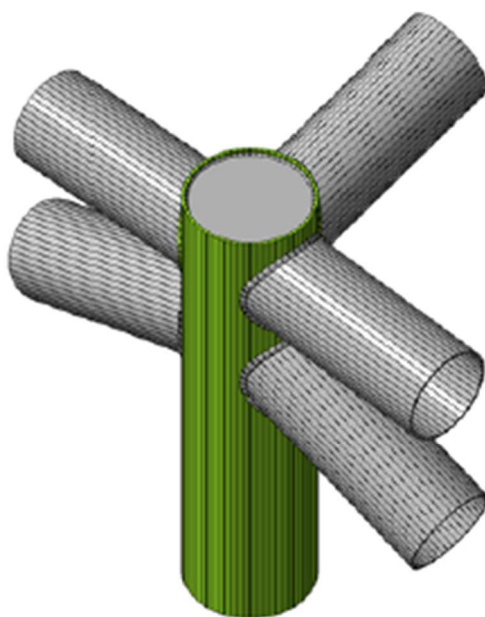

Overall check, ULS-Set(2)

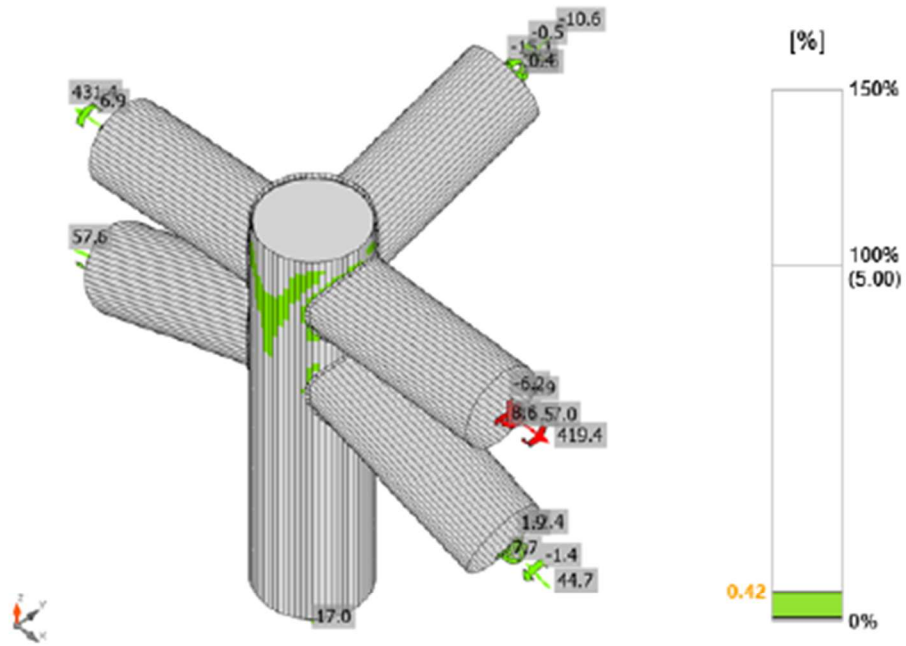

Strain check, ULS-Set(2)

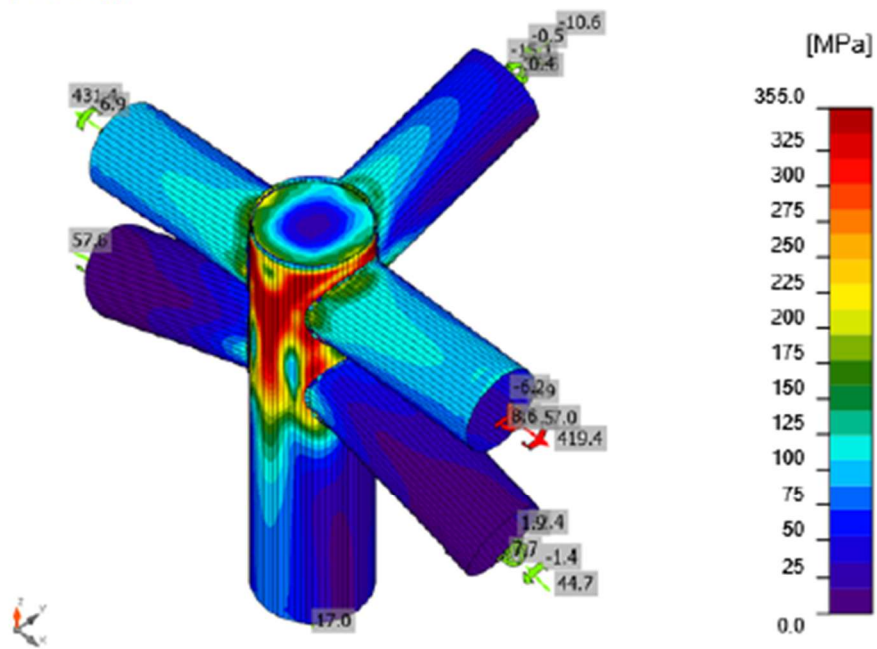

Equivalent stress, ULS-Set(2)

Welds (Plastic redistribution)

Item	Edge	Throat th. [mm]	Length [mm]	Loads	$\sigma_{w,Ed}$ [MPa]	ϵ_{pl} [%]	σ_{\perp} [MPa]	τ_{\parallel} [MPa]	τ_{\perp} [MPa]	Ut [%]	Ut _c [%]	Status
B5568-arc 27	B5563	▲8.0	68	ULS-Set(38)	426.9	0.0	65.4	185.1	-158.3	98.0	46.0	OK
B6213-arc 56	B5563	▲8.0	755	ULS-Set(38)	313.3	0.0	113.5	-153.5	-69.7	71.9	14.6	OK
B6213-arc 25	B5574	▲8.0	861	ULS-Set(1)	308.8	0.0	202.0	46.7	-126.5	70.9	24.0	OK
B6213-arc 25	B6216	▲8.0	886	ULS-Set(2)	196.4	0.0	118.4	-1.4	-90.4	45.1	11.9	OK
B6213-arc 40	B6217	▲8.0	886	ULS-Set(2)	126.2	0.0	122.9	8.7	-14.0	34.8	10.4	OK
B5574-arc 24	B5568	▲8.0	68	ULS-Set(38)	427.2	0.2	-164.8	-149.4	171.6	98.1	51.0	OK
B6213-arc 2	B5568	▲8.0	770	ULS-Set(5)	427.0	0.1	-200.8	-21.9	216.5	98.0	35.8	OK
B6213-arc 1	STIFF1	▲4.0▲	17	ULS-Set(5)	417.6	0.0	-242.9	-7.2	-196.0	95.9	95.9	OK
		▲4.0▲	17	ULS-Set(5)	270.9	0.0	-93.8	-27.7	144.1	62.2	62.2	OK
B6213-arc 2	STIFF1	▲4.0▲	17	ULS-Set(5)	426.9	0.0	-223.5	-28.8	-208.0	98.0	98.0	OK
		▲4.0▲	17	ULS-Set(5)	377.0	0.0	-168.2	-40.5	190.6	86.6	86.6	OK
B6213-arc 3	STIFF1	▲4.0▲	17	ULS-Set(5)	377.6	0.0	-141.0	-88.2	-182.0	86.7	86.7	OK
		▲4.0▲	17	ULS-Set(5)	426.9	0.0	-237.1	6.3	204.9	98.0	98.0	OK
B6213-arc 4	STIFF1	▲4.0▲	17	ULS-Set(5)	244.4	0.0	-62.8	-95.2	-97.6	56.1	56.1	OK
		▲4.0▲	17	ULS-Set(5)	349.6	0.0	-188.8	67.0	156.1	80.3	80.3	OK
B6213-arc 5	STIFF1	▲4.0▲	17	ULS-Set(5)	89.7	0.0	3.8	-49.2	-16.1	20.6	20.6	OK
		▲4.0▲	17	ULS-Set(5)	181.0	0.0	-86.0	61.7	68.2	41.6	41.6	OK
B6213-arc 6	STIFF1	▲4.0▲	17	ULS-Set(1)	76.5	0.0	1.6	-44.1	2.5	17.6	17.6	OK
		▲4.0▲	17	ULS-Set(5)	142.7	0.0	-63.9	53.8	50.3	32.8	32.8	OK
B6213-arc 7	STIFF1	▲4.0▲	17	ULS-Set(1)	94.8	0.0	3.2	-54.6	3.1	21.8	21.8	OK
		▲4.0▲	17	ULS-Set(1)	124.0	0.0	-12.1	70.2	12.0	28.5	28.5	OK
B6213-arc 8	STIFF1	▲4.0▲	17	ULS-Set(2)	118.1	0.0	-1.6	-68.1	-4.0	27.1	27.1	OK
		▲4.0▲	17	ULS-Set(1)	141.0	0.0	-18.1	79.2	15.6	32.4	32.4	OK
B6213-arc 9	STIFF1	▲4.0▲	17	ULS-Set(2)	122.1	0.0	6.1	-70.2	-4.5	28.0	28.0	OK
		▲4.0▲	17	ULS-Set(2)	163.0	0.0	-27.4	91.2	17.1	37.4	37.4	OK
B6213-arc 10	STIFF1	▲4.0▲	17	ULS-Set(2)	129.8	0.0	6.7	-74.8	-1.9	29.8	29.8	OK
		▲4.0▲	17	ULS-Set(2)	180.2	0.0	-20.7	102.6	12.4	41.4	41.4	OK
B6213-arc 11	STIFF1	▲4.0▲	17	ULS-Set(2)	133.3	0.0	6.9	-76.8	-1.2	30.6	30.6	OK
		▲4.0▲	17	ULS-Set(2)	202.5	0.0	-12.7	116.5	5.3	46.5	46.5	OK
B6213-arc 12	STIFF1	▲4.0▲	17	ULS-Set(2)	135.7	0.0	1.3	-78.2	-5.0	31.2	31.2	OK
		▲4.0▲	17	ULS-Set(2)	216.2	0.0	-0.4	124.7	-4.7	49.6	49.6	OK
B6213-arc 13	STIFF1	▲4.0▲	17	ULS-Set(2)	118.5	0.0	-0.8	-68.2	-5.6	27.2	27.2	OK
		▲4.0▲	17	ULS-Set(2)	212.8	0.0	14.2	121.4	-16.8	48.9	48.9	OK
B6213-arc 14	STIFF1	▲4.0▲	17	ULS-Set(48)	106.4	0.0	-13.2	-60.4	-8.1	24.4	24.4	OK
		▲4.0▲	17	ULS-Set(2)	218.3	0.0	54.4	113.6	-44.7	50.1	50.1	OK
B6213-arc 15	STIFF1	▲4.0▲	17	ULS-Set(53)	100.2	0.0	-11.3	-56.7	-9.8	23.0	23.0	OK
		▲4.0▲	17	ULS-Set(2)	212.5	0.0	68.1	99.1	-60.6	48.8	48.8	OK
B6213-arc 16	STIFF1	▲4.0▲	17	ULS-Set(5)	84.8	0.0	-14.0	48.2	-3.5	19.5	19.5	OK
		▲4.0▲	17	ULS-Set(2)	200.4	0.0	86.8	76.4	-71.0	46.0	46.0	OK

Item	Edge	Throat th. [mm]	Length [mm]	Loads	$\sigma_{w,Ed}$ [MPa]	ϵ_{pl} [%]	σ_{\perp} [MPa]	τ_{\parallel} [MPa]	τ_{\perp} [MPa]	Ut [%]	Ut _c [%]	Status
B6213-arc 17	STIFF1	▲4.0▲	17	ULS-Set(5)	105.6	0.0	-20.3	59.7	-3.8	24.2	24.2	OK
		▲4.0▲	17	ULS-Set(2)	185.3	0.0	102.2	45.8	-76.6	42.5	42.5	OK
B6213-arc 18	STIFF1	▲4.0▲	17	ULS-Set(5)	128.2	0.0	-22.7	71.4	-14.1	29.4	29.4	OK
		▲4.0▲	17	ULS-Set(1)	188.1	0.0	105.8	-13.8	-88.8	43.2	43.2	OK
B6213-arc 19	STIFF1	▲4.0▲	17	ULS-Set(5)	139.3	0.0	-18.3	79.5	-5.9	32.0	32.0	OK
		▲4.0▲	17	ULS-Set(5)	176.8	0.0	52.5	-88.9	-40.0	40.6	40.6	OK
B6213-arc 20	STIFF1	▲4.0▲	17	ULS-Set(5)	158.2	0.0	-17.5	89.8	-13.3	36.3	36.3	OK
		▲4.0▲	17	ULS-Set(1)	196.9	0.0	79.3	-78.3	-68.6	45.2	45.2	OK
B6213-arc 21	STIFF1	▲4.0▲	17	ULS-Set(5)	163.0	0.0	-22.4	91.4	-18.1	37.4	37.4	OK
		▲4.0▲	17	ULS-Set(1)	223.2	0.0	75.2	-103.0	-64.1	51.2	51.2	OK
B6213-arc 22	STIFF1	▲4.0▲	17	ULS-Set(5)	163.3	0.0	-13.6	93.6	-8.7	37.5	37.5	OK
		▲4.0▲	17	ULS-Set(1)	222.3	0.0	51.4	-118.6	-38.9	51.0	51.0	OK
B6213-arc 23	STIFF1	▲4.0▲	17	ULS-Set(5)	147.0	0.0	-11.1	84.2	-8.0	33.7	33.7	OK
		▲4.0▲	17	ULS-Set(1)	243.7	0.0	40.7	-135.1	-31.4	56.0	56.0	OK
B6213-arc 24	STIFF1	▲4.0▲	17	ULS-Set(5)	137.1	0.0	-7.4	78.8	-6.1	31.5	31.5	OK
		▲4.0▲	17	ULS-Set(1)	236.0	0.0	18.6	-135.4	-11.1	54.2	54.2	OK
B6213-arc 25	STIFF1	▲4.0▲	17	ULS-Set(5)	122.3	0.0	-6.9	69.6	-11.1	28.1	28.1	OK
		▲4.0▲	17	ULS-Set(1)	244.3	0.0	4.1	-141.0	-4.3	56.1	56.1	OK
B6213-arc 26	STIFF1	▲4.0▲	17	ULS-Set(5)	106.5	0.0	-0.6	61.3	-4.4	24.5	24.5	OK
		▲4.0▲	17	ULS-Set(1)	239.3	0.0	-14.1	-137.1	15.1	54.9	54.9	OK
B6213-arc 27	STIFF1	▲4.0▲	17	ULS-Set(5)	92.0	0.0	2.5	53.1	-1.0	21.1	21.1	OK
		▲4.0▲	17	ULS-Set(1)	220.2	0.0	-31.2	-122.0	30.9	50.6	50.6	OK
B6213-arc 28	STIFF1	▲4.0▲	17	ULS-Set(5)	77.0	0.0	0.4	43.7	-8.0	17.7	17.7	OK
		▲4.0▲	17	ULS-Set(1)	214.3	0.0	-46.8	-115.0	36.9	49.2	49.2	OK
B6213-arc 29	STIFF1	▲4.0▲	17	ULS-Set(5)	63.0	0.0	4.1	36.1	-3.9	14.5	14.5	OK
		▲4.0▲	17	ULS-Set(1)	195.0	0.0	-59.6	-94.4	50.9	44.8	44.8	OK
B6213-arc 30	STIFF1	▲4.0▲	17	ULS-Set(2)	51.3	0.0	33.2	6.6	21.6	11.8	11.8	OK
		▲4.0▲	17	ULS-Set(1)	181.7	0.0	-72.8	-68.4	67.5	41.7	41.7	OK
B6213-arc 31	STIFF1	▲4.0▲	17	ULS-Set(2)	50.0	0.0	39.0	4.2	17.6	11.5	11.5	OK
		▲4.0▲	17	ULS-Set(1)	169.7	0.0	-84.8	-46.3	71.2	39.0	39.0	OK
B6213-arc 32	STIFF1	▲4.0▲	17	ULS-Set(2)	49.7	0.0	39.3	1.1	17.6	11.4	11.4	OK
		▲4.0▲	17	ULS-Set(1)	151.9	0.0	-84.0	-18.4	70.7	34.9	34.9	OK
B6213-arc 33	STIFF1	▲4.0▲	17	ULS-Set(2)	55.0	0.0	43.1	-1.9	19.7	12.6	12.6	OK
		▲4.0▲	17	ULS-Set(1)	158.8	0.0	-89.6	10.9	74.9	36.5	36.5	OK
B6213-arc 34	STIFF1	▲4.0▲	17	ULS-Set(2)	44.7	0.0	33.8	-0.7	16.9	10.3	10.3	OK
		▲4.0▲	17	ULS-Set(1)	156.5	0.0	-77.5	38.6	68.3	35.9	35.9	OK
B6213-arc 35	STIFF1	▲4.0▲	17	ULS-Set(2)	57.2	0.0	37.6	-7.5	23.7	13.1	13.1	OK
		▲4.0▲	17	ULS-Set(1)	181.0	0.0	-79.0	60.8	71.8	41.6	41.6	OK
B6213-arc 36	STIFF1	▲4.0▲	17	ULS-Set(5)	53.6	0.0	0.7	-30.2	-6.9	12.3	12.3	OK
		▲4.0▲	17	ULS-Set(1)	182.3	0.0	-61.5	84.8	51.1	41.8	41.8	OK
B6213-arc 37	STIFF1	▲4.0▲	17	ULS-Set(5)	70.2	0.0	1.7	-40.5	-2.6	16.1	16.1	OK

Item	Edge	Throat th. [mm]	Length [mm]	Loads	$\sigma_{w,Ed}$ [MPa]	ϵ_{pl} [%]	σ_{\perp} [MPa]	τ_{\parallel} [MPa]	τ_{\perp} [MPa]	Ut [%]	Ut _c [%]	Status
		4.0	17	ULS-Set(1)	200.5	0.0	-44.0	105.2	41.0	46.0	46.0	OK
B6213-arc 38	STIFF1	4.0	17	ULS-Set(5)	85.3	0.0	0.4	-49.0	-4.4	19.6	19.6	OK
		4.0	17	ULS-Set(1)	219.8	0.0	-38.8	120.0	34.8	50.5	50.5	OK
B6213-arc 39	STIFF1	4.0	17	ULS-Set(5)	106.2	0.0	-2.8	-60.9	-6.8	24.4	24.4	OK
		4.0	17	ULS-Set(1)	217.6	0.0	-9.1	125.2	9.4	50.0	50.0	OK
B6213-arc 40	STIFF1	4.0	17	ULS-Set(5)	119.5	0.0	-2.1	-68.8	-5.4	27.4	27.4	OK
		4.0	17	ULS-Set(1)	239.9	0.0	-2.1	138.4	4.1	55.1	55.1	OK
B6213-arc 41	STIFF1	4.0	17	ULS-Set(5)	137.9	0.0	-7.0	-79.0	-9.4	31.7	31.7	OK
		4.0	17	ULS-Set(1)	233.5	0.0	14.1	134.2	-9.9	53.6	53.6	OK
B6213-arc 42	STIFF1	4.0	17	ULS-Set(5)	145.4	0.0	-8.0	-83.5	-7.7	33.4	33.4	OK
		4.0	17	ULS-Set(1)	240.4	0.0	33.9	135.1	-25.3	55.2	55.2	OK
B6213-arc 43	STIFF1	4.0	17	ULS-Set(5)	162.6	0.0	-10.6	-93.3	-7.9	37.3	37.3	OK
		4.0	17	ULS-Set(1)	223.4	0.0	46.9	121.2	-34.8	51.3	51.3	OK
B6213-arc 44	STIFF1	4.0	17	ULS-Set(5)	168.8	0.0	-17.6	-95.6	-16.0	38.8	38.8	OK
		4.0	17	ULS-Set(1)	228.2	0.0	69.0	111.0	-58.6	52.4	52.4	OK
B6213-arc 45	STIFF1	4.0	17	ULS-Set(5)	158.8	0.0	-12.5	-90.7	-11.5	36.5	36.5	OK
		4.0	17	ULS-Set(5)	194.5	0.0	27.2	108.7	-23.2	44.7	44.7	OK
B6213-arc 46	STIFF1	4.0	17	ULS-Set(5)	149.8	0.0	-16.2	-85.8	-6.1	34.4	34.4	OK
		4.0	17	ULS-Set(5)	188.8	0.0	53.2	96.8	-39.6	43.3	43.3	OK
B6213-arc 47	STIFF1	4.0	17	ULS-Set(5)	150.3	0.0	-20.7	-84.5	-15.6	34.5	34.5	OK
		4.0	17	ULS-Set(1)	203.1	0.0	112.1	22.3	-95.2	46.6	46.6	OK
B6213-arc 48	STIFF1	4.0	17	ULS-Set(5)	114.9	0.0	-15.3	-65.5	-5.4	26.4	26.4	OK
		4.0	17	ULS-Set(2)	173.7	0.0	97.9	-37.1	-74.1	39.9	39.9	OK
B6213-arc 49	STIFF1	4.0	17	ULS-Set(5)	97.3	0.0	-15.7	-55.3	-3.8	22.3	22.3	OK
		4.0	17	ULS-Set(2)	202.4	0.0	98.4	-69.4	-74.9	46.5	46.5	OK
B6213-arc 50	STIFF1	4.0	17	ULS-Set(53)	100.9	0.0	-15.5	55.8	-14.2	23.2	23.2	OK
		4.0	17	ULS-Set(2)	207.4	0.0	71.0	-92.4	-64.2	47.6	47.6	OK
B6213-arc 51	STIFF1	4.0	17	ULS-Set(48)	110.6	0.0	-11.1	63.1	-7.7	25.4	25.4	OK
		4.0	17	ULS-Set(2)	217.4	0.0	45.8	-116.6	-38.2	49.9	49.9	OK
B6213-arc 52	STIFF1	4.0	17	ULS-Set(2)	121.9	0.0	-1.1	70.2	-4.6	28.0	28.0	OK
		4.0	17	ULS-Set(2)	218.4	0.0	18.1	-124.1	-19.6	50.1	50.1	OK
B6213-arc 53	STIFF1	4.0	17	ULS-Set(2)	130.7	0.0	-1.7	74.8	-9.4	30.0	30.0	OK
		4.0	17	ULS-Set(2)	216.2	0.0	4.5	-124.3	-11.0	49.6	49.6	OK
B6213-arc 54	STIFF1	4.0	17	ULS-Set(2)	136.7	0.0	5.9	78.8	-0.8	31.4	31.4	OK
		4.0	17	ULS-Set(2)	204.2	0.0	-11.5	-117.6	5.3	46.9	46.9	OK
B6213-arc 55	STIFF1	4.0	17	ULS-Set(2)	132.0	0.0	8.3	76.0	-0.8	30.3	30.3	OK
		4.0	17	ULS-Set(2)	183.0	0.0	-18.8	-104.6	10.0	42.0	42.0	OK
B6213-arc 56	STIFF1	4.0	17	ULS-Set(2)	122.0	0.0	5.1	70.2	-4.0	28.0	28.0	OK
		4.0	17	ULS-Set(2)	161.8	0.0	-23.9	-91.2	14.9	37.1	37.1	OK
B6213-arc 57	STIFF1	4.0	17	ULS-Set(2)	113.1	0.0	0.9	65.3	-2.9	26.0	26.0	OK
		4.0	17	ULS-Set(1)	141.1	0.0	-14.0	-80.3	10.7	32.4	32.4	OK

.....

Item	Edge	Throat th. [mm]	Length [mm]	Loads	$\sigma_{w,Ed}$ [MPa]	ϵ_{pl} [%]	σ_{\perp} [MPa]	τ_{\parallel} [MPa]	τ_{\perp} [MPa]	Ut [%]	U _{tc} [%]	Status
B6213-arc 58	STIFF1	▲4.0▲	17	ULS-Set(2)	98.3	0.0	-4.2	56.4	-5.3	22.6	22.6	OK
		▲4.0▲	17	ULS-Set(1)	130.4	0.0	-8.9	-74.6	9.0	29.9	29.9	OK
B6213-arc 59	STIFF1	▲4.0▲	17	ULS-Set(1)	80.4	0.0	0.8	46.1	5.8	18.5	18.5	OK
		▲4.0▲	17	ULS-Set(1)	118.9	0.0	-8.5	-67.6	11.7	27.3	27.3	OK
B6213-arc 60	STIFF1	▲4.0▲	17	ULS-Set(5)	92.2	0.0	7.3	50.1	-17.4	21.2	21.2	OK
		▲4.0▲	17	ULS-Set(5)	166.9	0.0	-80.9	-62.6	56.4	38.3	38.3	OK
B6213-arc 61	STIFF1	▲4.0▲	17	ULS-Set(5)	226.5	0.0	-40.5	99.9	-81.1	52.0	52.0	OK
		▲4.0▲	17	ULS-Set(5)	295.7	0.0	-164.8	-67.6	124.6	67.9	67.9	OK
B6213-arc 62	STIFF1	▲4.0▲	17	ULS-Set(5)	382.3	0.0	-153.4	96.5	-177.6	87.8	87.8	OK
		▲4.0▲	17	ULS-Set(5)	383.7	0.0	-206.8	-33.1	183.6	88.1	88.1	OK
B6213-arc 63	STIFF1	▲4.0▲	17	ULS-Set(5)	426.8	0.0	-228.3	40.4	-204.3	98.0	98.0	OK
		▲4.0▲	17	ULS-Set(5)	360.5	0.0	-158.5	26.0	185.1	82.8	82.8	OK
B6213-arc 64	STIFF1	▲4.0▲	17	ULS-Set(5)	383.0	0.0	-221.0	19.6	-179.6	87.9	87.9	OK
		▲4.0▲	17	ULS-Set(5)	279.8	0.0	-105.0	6.6	149.6	64.2	64.2	OK

Design data

	β_w [-]	$\sigma_{w,Rd}$ [MPa]	0.9 σ [MPa]
S 355	0.90	435.6	352.8

Symbol explanation

ϵ_{pl}	Strain
$\sigma_{w,Ed}$	Equivalent stress
$\sigma_{w,Rd}$	Equivalent stress resistance
σ_{\perp}	Perpendicular stress
τ_{\parallel}	Shear stress parallel to weld axis
τ_{\perp}	Shear stress perpendicular to weld axis
0.9 σ	Perpendicular stress resistance - 0.9 \cdot f _u / γ_{M2}
β_w	Correlation factor EN 1993-1-8 tab. 4.1
Ut	Utilization
U _{tc}	Weld capacity utilization

Buckling

Buckling analysis was not calculated.

Code settings

Item	Value	Unit	Reference
Y _{M0}	1.00	-	EN 1993-1-1: 6.1
Y _{M1}	1.00	-	EN 1993-1-1: 6.1
Y _{M2}	1.25	-	EN 1993-1-1: 6.1
Y _{M3}	1.25	-	EN 1993-1-8: 2.2
Y _C	1.50	-	EN 1992-1-1: 2.4.2.4

Item	Value	Unit	Reference
Yinst	1.20	-	EN 1992-4: Table 4.1
Joint coefficient β_j	0.67	-	EN 1993-1-8: 6.2.5
Effective area - influence of mesh size	0.10	-	
Friction coefficient - concrete	0.25	-	EN 1993-1-8
Friction coefficient in slip-resistance	0.30	-	EN 1993-1-8 tab 3.7
Limit plastic strain	0.05	-	EN 1993-1-5
Weld stress evaluation	Plastic redistribution		
Detailing	No		
Distance between bolts [d]	2.20	-	EN 1993-1-8: tab 3.3
Distance between bolts and edge [d]	1.20	-	EN 1993-1-8: tab 3.3
Concrete breakout resistance check	Both		EN 1992-4: 7.2.1.4 and 7.2.2.5
Use calculated a_b in bearing check.	Yes		EN 1993-1-8: tab 3.4
Cracked concrete	Yes		EN 1992-4
Local deformation check	No		CIDECT DG 1, 3 - 1.1
Local deformation limit	0.03	-	CIDECT DG 1, 3 - 1.1
Geometrical nonlinearity (GMNA)	Yes		Analysis with large deformations for hollow section joints
Braced system	No		EN 1993-1-8: 5.2.2.5

5.6. Spoj vrha stupa „S3“

Design

Name	Con N5920
Description	
Analysis	Stress, strain/ loads in equilibrium

Beams and columns

Name	Cross-section	β - Direction [°]	γ - Pitch [°]	α - Rotation [°]	Offset ex [mm]	Offset ey [mm]	Offset ez [mm]	Forces in
B6227	1 - Massive O Hollow(CHS273,8)	0.0	0.0	0.0	0	0	0	Position
B6229	2 - CHS(cf)355.6/8.0	0.0	0.0	0.0	150	0	0	Position
B6230	1 - Massive O Hollow(CHS273,8)	0.0	0.0	0.0	-150	0	-200	Position
B6235	1 - Massive O Hollow(CHS273,8)	0.0	0.0	0.0	0	-25	0	Position
B6240	1 - Massive O Hollow(CHS273,8)	0.0	0.0 </td <td>0.0</td> <td>300</td> <td>-10</td> <td>-100</td> <td>Position</td>	0.0	300	-10	-100	Position

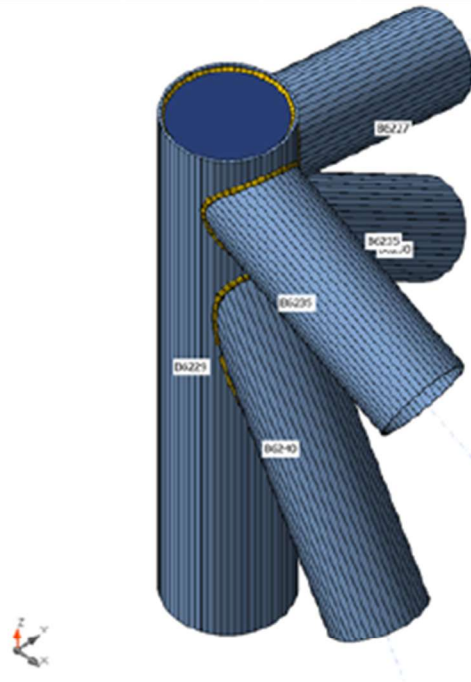

Cross-sections

Name	Material
1 - Massive O Hollow(CHS273,8)	S 355
2 - CHS(cf)355.6/8.0	S 355

Load effects (forces in equilibrium)

Name	Member	N [kN]	Vy [kN]	Vz [kN]	Mx [kNm]	My [kNm]	Mz [kNm]
ULS-Set(12)	B6227	6.4	0.2	-2.5	-1.3	2.9	1.2
	B6229	105.7	0.2	2.4	0.1	15.8	-0.9
	B6230	6.3	1.4	-1.4	0.4	-0.8	-3.3
	B6235	-86.3	-0.1	-3.3	1.6	3.0	0.5
	B6240	160.0	0.2	6.3	-0.4	-15.6	1.4
ULS-Set(13)	B6227	4.2	0.2	-2.0	-1.3	2.7	1.2
	B6229	106.4	0.3	2.6	-0.2	17.0	-1.4
	B6230	4.2	1.3	-1.5	0.5	-1.7	-3.0
	B6235	-87.8	-0.1	-2.5	1.6	1.9	0.6
	B6240	162.2	0.3	6.6	-0.3	-15.7	1.7
ULS-Set(14)	B6227	0.1	0.6	-1.8	-0.4	1.9	2.6
	B6229	115.7	0.6	-8.6	0.7	-9.1	-3.2
	B6230	-2.7	0.4	-2.1	-2.0	-2.2	2.9
	B6235	-99.3	-1.0	-2.5	1.8	5.3	-3.4
	B6240	171.9	-0.3	1.9	0.9	0.3	0.2
ULS-Set(16)	B6227	6.4	0.3	-1.6	0.7	-1.5	0.9
	B6229	-72.3	-0.8	-3.1	3.8	-21.1	2.7
	B6230	3.9	0.3	1.3	-2.2	7.0	1.4
	B6235	68.2	-1.0	-1.9	-1.2	2.3	-3.2
	B6240	-121.0	-1.7	-8.0	0.1	15.3	-4.0
ULS-Set(17)	B6227	1.8	0.8	-2.1	-1.8	1.1	3.2
	B6229	100.5	0.2	1.3	2.6	9.2	-1.7
	B6230	-1.6	1.8	-1.4	-1.9	0.4	-2.0
	B6235	-76.4	-1.1	-2.0	0.8	-1.0	-2.8
	B6240	145.0	-0.8	2.5	0.2	-7.4	-0.7
ULS-Set(19)	B6227	13.4	-0.2	-1.5	-0.3	-3.5	0.3
	B6229	95.3	-2.6	0.8	1.1	6.5	14.7
	B6230	15.0	2.6	5.3	-0.6	15.6	-4.3
	B6235	-84.2	0.0	-2.9	0.4	2.4	1.8
	B6240	156.9	-1.2	2.2	-3.3	-6.5	-4.5
ULS-Set(20)	B6227	11.2	-0.6	-1.5	1.9	0.0	-2.3
	B6229	-108.9	-0.9	-2.6	0.3	-18.7	4.1
	B6230	13.3	-0.8	1.8	0.9	6.0	1.0
	B6235	90.8	0.4	-2.9	-0.7	7.4	1.1
	B6240	-167.3	-0.4	-5.4	-0.6	10.1	-1.7
ULS-Set(21)	B6227	7.1	-0.2	-1.3	2.8	-0.8	-0.8
	B6229	-99.6	-0.6	-13.8	1.3	-44.8	2.2
	B6230	6.4	-1.6	1.2	-1.5	5.6	6.9
	B6235	79.3	-0.5	-2.8	-0.4	10.8	-2.9
	B6240	-157.5	-1.0	-10.1	0.6	26.2	-3.2
ULS-Set(23)	B6227	0.8	0.5	-1.7	1.0	1.5	2.1

Name	Member	N [kN]	Vy [kN]	Vz [kN]	Mx [kNm]	My [kNm]	Mz [kNm]
	B6229	81.7	0.5	-16.7	0.4	-30.9	-3.0
	B6230	-2.2	-0.6	-1.8	-2.5	-1.3	7.1
	B6235	-76.1	-1.1	-3.1	1.8	10.4	-4.6
	B6240	120.0	-0.5	-2.1	1.4	12.8	-0.6
ULS-Set(24)	B6227	9.9	0.0	-0.8	-0.6	-4.0	0.8
	B6229	92.5	-2.4	0.7	1.4	6.1	13.8
	B6230	10.6	2.3	5.1	-1.0	14.5	-3.5
	B6235	-81.1	-0.2	-1.8	0.3	0.2	0.9
	B6240	151.5	-1.3	1.6	-3.0	-4.7	-4.6
ULS-Set(25)	B6227	12.1	0.0	-1.4	-0.5	-3.8	0.8
	B6229	91.8	-2.5	0.6	1.7	4.9	14.2
	B6230	12.7	2.5	5.2	-1.1	15.5	-3.7
	B6235	-79.7	-0.3	-2.5	0.3	1.3	0.8
	B6240	149.3	-1.5	1.3	-3.1	-4.6	-4.9
ULS-Set(28)	B6227	2.3	0.6	-2.3	-0.4	2.1	2.7
	B6229	115.0	0.4	-8.8	1.1	-10.3	-2.8
	B6230	-0.7	0.6	-2.0	-2.0	-1.2	2.7
	B6235	-97.9	-1.0	-3.3	1.9	6.4	-3.5
	B6240	169.7	-0.5	1.6	0.8	0.4	-0.1
ULS-Set(30)	B6227	6.7	0.0	-1.1	1.4	-1.8	-0.3
	B6229	-114.1	-0.9	-3.7	2.9	-25.3	3.4
	B6230	5.5	-0.4	1.8	-1.4	7.2	2.2
	B6235	100.7	-0.6	-1.5	-1.4	3.3	-2.2
	B6240	-182.2	-1.4	-9.2	0.0	18.3	-3.8
ULS-Set(31)	B6227	8.8	0.0	-1.7	1.4	-1.6	-0.3
	B6229	-114.8	-1.0	-3.9	3.2	-26.5	3.8
	B6230	7.5	-0.2	1.9	-1.5	8.2	2.0
	B6235	102.1	-0.7	-2.3	-1.4	4.4	-2.3
	B6240	-184.4	-1.6	-9.5	-0.1	18.4	-4.1
ULS-Set(32)	B6227	7.0	0.1	-1.3	-1.2	-1.1	1.3
	B6229	125.7	-1.2	2.1	0.7	14.7	7.3
	B6230	7.2	2.3	2.2	-0.5	7.4	-4.0
	B6235	-106.9	-0.2	-2.1	1.0	0.3	0.9
	B6240	198.3	-0.6	5.0	-2.0	-12.1	-1.8
ULS-Set(33)	B6227	2.1	0.3	-1.8	1.2	1.8	1.6
	B6229	85.2	0.4	-16.4	-0.2	-29.3	-2.4
	B6230	0.1	-0.5	-1.6	-2.0	-1.2	6.5
	B6235	-80.7	-0.8	-3.5	2.0	11.4	-3.6
	B6240	127.6	-0.2	-1.2	1.2	10.9	-0.2
ULS-Set(34)	B6227	1.5	0.4	-1.9	-0.3	2.2	2.1
	B6229	119.2	0.5	-8.4	0.1	-7.5	-2.7
	B6230	-0.5	0.5	-2.0	-1.4	-2.1	2.4
	B6235	-103.9	-0.7	-2.9	2.0	6.4	-2.4

Name	Member	N [kN]	Vy [kN]	Vz [kN]	Mx [kNm]	My [kNm]	Mz [kNm]
	B6240	179.4	-0.1	2.8	0.7	-1.6	0.6
ULS-Set(35)	B6227	9.3	-0.2	-1.9	2.8	-0.6	-0.8
	B6229	-100.4	-0.8	-13.9	1.6	-46.0	2.7
	B6230	8.5	-1.4	1.3	-1.6	6.5	6.6
	B6235	80.7	-0.6	-3.6	-0.4	11.9	-3.1
	B6240	-159.7	-1.2	-10.4	0.5	26.3	-3.5
ULS-Set(36)	B6227	13.4	-0.6	-2.1	1.9	0.2	-2.2
	B6229	-109.7	-1.0	-2.7	0.7	-19.9	4.6
	B6230	15.4	-0.6	1.9	0.9	7.0	0.7
	B6235	92.2	0.3	-3.6	-0.6	8.5	1.0
	B6240	-169.4	-0.6	-5.7	-0.7	10.2	-2.0
ULS-Set(37)	B6227	6.1	0.4	-1.7	0.6	-1.4	0.9
	B6229	-75.3	-0.7	-3.1	3.7	-21.0	2.2
	B6230	3.5	0.1	1.1	-2.1	6.5	1.7
	B6235	71.0	-1.0	-1.9	-1.1	2.3	-3.4
	B6240	-126.0	-1.7	-7.9	0.2	15.2	-3.8
ULS-Set(38)	B6227	11.3	-0.2	-0.9	-0.4	-3.7	0.3
	B6229	96.0	-2.5	1.0	0.8	7.7	14.3
	B6230	12.9	2.4	5.3	-0.5	14.6	-4.0
	B6235	-85.7	0.1	-2.1	0.4	1.2	1.9
	B6240	159.0	-1.1	2.5	-3.2	-6.6	-4.2
ULS-Set(39)	B6227	14.8	-0.4	-1.3	1.9	-3.9	-1.6
	B6229	-93.9	-2.5	-3.5	2.2	-23.8	12.7
	B6230	16.1	0.3	5.5	-0.7	16.0	0.3
	B6235	77.7	-0.1	-2.8	-1.3	5.8	0.2
	B6240	-140.8	-1.7	-8.2	-2.1	15.8	-5.9
ULS-Set(40)	B6227	16.1	-0.6	-1.4	2.1	-3.6	-2.1
	B6229	-90.4	-2.5	-3.2	1.6	-22.2	13.3
	B6230	18.4	0.4	5.6	-0.1	16.1	-0.2
	B6235	73.1	0.2	-3.1	-1.2	6.9	1.2
	B6240	-133.3	-1.5	-7.3	-2.4	13.8	-5.4
ULS-Set(49)	B6227	8.5	-0.4	-1.4	3.0	-0.5	-1.3
	B6229	-96.1	-0.7	-13.5	0.7	-43.2	2.8
	B6230	8.6	-1.5	1.4	-1.0	5.6	6.4
	B6235	74.7	-0.3	-3.2	-0.3	11.9	-2.0
	B6240	-150.0	-0.8	-9.2	0.4	24.2	-2.8
ULS-Set(50)	B6227	5.6	0.3	-1.2	-1.4	-1.4	1.8
	B6229	122.2	-1.2	1.8	1.3	13.1	6.8
	B6230	4.9	2.2	2.0	-1.1	7.3	-3.4
	B6235	-102.3	-0.4	-1.7	0.9	-0.8	-0.1
	B6240	190.8	-0.8	4.1	-1.7	-10.2	-2.2
ULS-Set(52)	B6227	7.8	0.3	-1.8	-1.4	-1.2	1.9
	B6229	121.4	-1.3	1.6	1.6	11.9	7.2

Name	Member	N [kN]	Vy [kN]	Vz [kN]	Mx [kNm]	My [kNm]	Mz [kNm]
	B6230	7.0	2.4	2.1	-1.1	8.3	-3.7
	B6235	-100.9	-0.5	-2.5	0.9	0.3	-0.2
	B6240	188.6	-1.0	3.8	-1.8	-10.1	-2.5

Check

Summary

Name	Value	Status
Analysis	100.0%	OK
Plates	0.0 < 5.0%	OK
Welds	72.1 < 100%	OK
Buckling	Not calculated	
GMNA	Calculated	

Plates

Name	Thickness [mm]	Loads	σ_{Ed} [MPa]	ϵ_{pl} [%]	σ^{cEd} [MPa]	Status
B6227	8.0	ULS-Set(35)	69.4	0.0	0.0	OK
B6229	8.0	ULS-Set(35)	190.1	0.0	0.0	OK
B6230	8.0	ULS-Set(40)	91.9	0.0	0.0	OK
B6235	8.0	ULS-Set(35)	70.4	0.0	0.0	OK
B6240	8.0	ULS-Set(35)	163.3	0.0	0.0	OK
STIFF1	12.0	ULS-Set(35)	33.9	0.0	0.0	OK

Design data

Material	f_y [MPa]	ϵ_{lim} [%]
S 355	355.0	5.0

Symbol explanation

ϵ_{pl}	Strain
σ_{Ed}	Eq. stress
σ^{cEd}	Contact stress
f_y	Yield strength
ϵ_{lim}	Limit of plastic strain

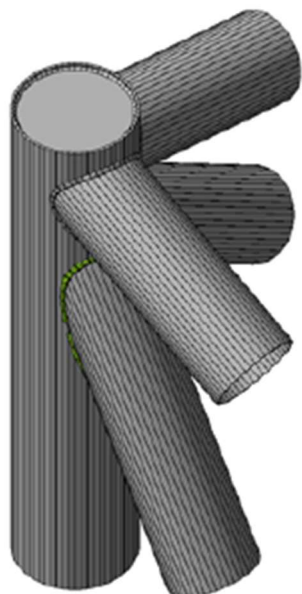

Overall check, ULS-Set(35)

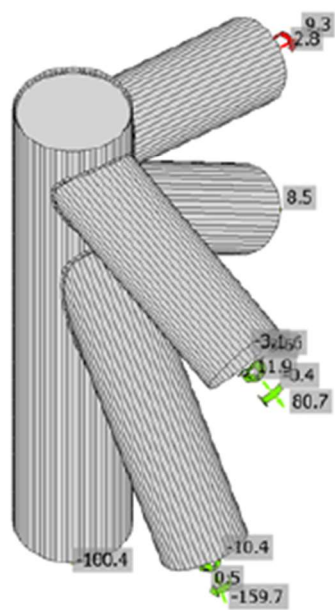

Strain check, ULS-Set(35)

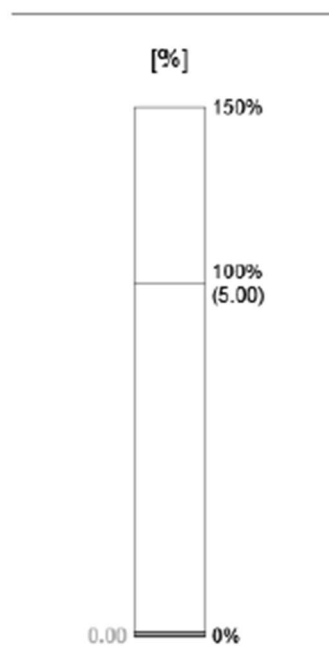

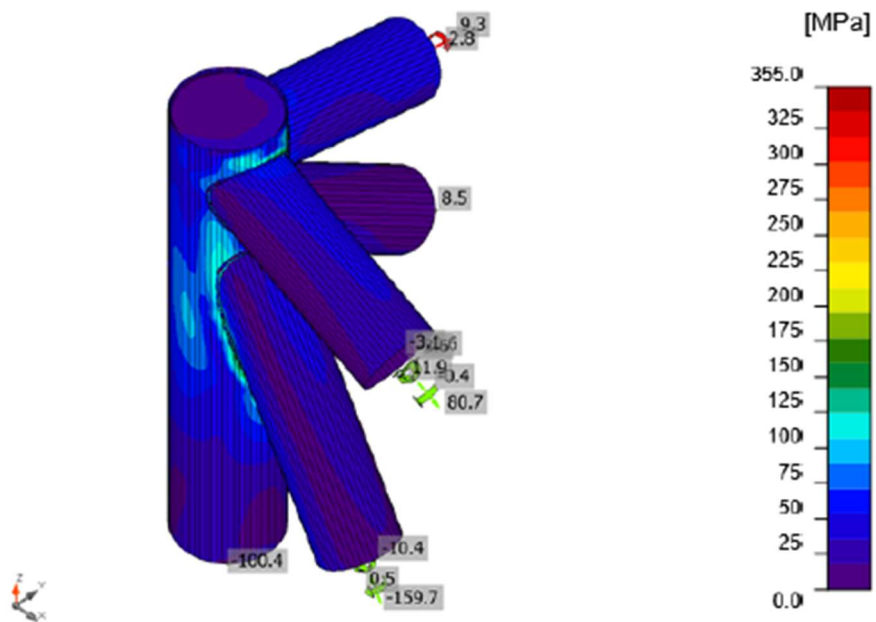

Equivalent stress, ULS-Set(35)

Welds (Plastic redistribution)

Item	Edge	Throat th. [mm]	Length [mm]	Loads	$\sigma_{w,Ed}$ [MPa]	ϵ_{pl} [%]	σ_{\perp} [MPa]	τ_{\parallel} [MPa]	τ_{\perp} [MPa]	Ut [%]	Ut _c [%]	Status
B6229-arc 4	B6227	▲6.0	873	ULS-Set(35)	106.7	0.0	8.8	-56.4	-24.2	24.5	13.3	OK
B6229-arc 6	B6230	▲6.0	967	ULS-Set(39)	143.0	0.0	-27.0	-73.6	-33.9	32.8	11.4	OK
B6229-arc 49	B6235	▲6.0	923	ULS-Set(33)	103.0	0.0	-48.4	52.5	0.5	23.6	8.2	OK
B6229-arc 54	B6240	▲6.0	1391	ULS-Set(35)	314.2	0.0	170.0	22.5	150.9	72.1	16.1	OK
B6229-arc 1	STIFF1	▲6.0	17	ULS-Set(14)	55.0	0.0	0.2	31.7	-0.1	12.6	12.6	OK
B6229-arc 2	STIFF1	▲6.0	17	ULS-Set(14)	52.9	0.0	-1.5	30.4	-3.1	12.1	12.1	OK
B6229-arc 3	STIFF1	▲6.0	17	ULS-Set(40)	49.7	0.0	-1.7	-28.7	-0.6	11.4	11.4	OK
B6229-arc 4	STIFF1	▲6.0	17	ULS-Set(40)	44.6	0.0	-0.3	-25.8	0.6	10.3	10.3	OK
B6229-arc 5	STIFF1	▲6.0	17	ULS-Set(40)	39.8	0.0	2.1	-22.8	2.9	9.1	9.1	OK
B6229-arc 6	STIFF1	▲6.0	17	ULS-Set(35)	36.9	0.0	-0.5	-21.3	-0.2	8.5	8.5	OK
B6229-arc 7	STIFF1	▲6.0	17	ULS-Set(35)	34.1	0.0	1.1	-19.6	1.7	7.8	7.8	OK
B6229-arc 8	STIFF1	▲6.0	17	ULS-Set(35)	31.7	0.0	1.7	-18.1	2.6	7.3	7.3	OK
B6229-arc 9	STIFF1	▲6.0	17	ULS-Set(35)	27.3	0.0	2.1	-15.4	3.1	6.3	6.3	OK
B6229-arc 10	STIFF1	▲6.0	17	ULS-Set(23)	26.3	0.0	-3.0	-14.9	-2.4	6.0	6.0	OK
B6229-arc 11	STIFF1	▲6.0	17	ULS-Set(23)	28.4	0.0	-1.9	-16.3	-1.2	6.5	6.5	OK
B6229-arc 12	STIFF1	▲6.0	17	ULS-Set(23)	29.6	0.0	-1.3	-17.1	-0.6	6.8	6.8	OK
B6229-arc 13	STIFF1	▲6.0	17	ULS-Set(23)	28.2	0.0	-0.8	-16.3	-0.3	6.5	6.5	OK
B6229-arc 14	STIFF1	▲6.0	17	ULS-Set(23)	27.1	0.0	0.3	-15.6	0.9	6.2	6.2	OK
B6229-arc 15	STIFF1	▲6.0	17	ULS-Set(23)	26.3	0.0	0.6	-15.2	1.2	6.0	6.0	OK
B6229-arc 16	STIFF1	▲6.0	17	ULS-Set(23)	24.0	0.0	0.8	-13.8	1.1	5.5	5.5	OK
B6229-arc 17	STIFF1	▲6.0	17	ULS-Set(14)	22.3	0.0	0.2	-12.8	0.6	5.1	5.1	OK
B6229-arc 18	STIFF1	▲6.0	17	ULS-Set(14)	20.7	0.0	0.7	-11.9	0.9	4.8	4.8	OK
B6229-arc 19	STIFF1	▲6.0	17	ULS-Set(40)	21.1	0.0	0.6	12.1	0.4	4.8	4.8	OK
B6229-arc 20	STIFF1	▲6.0	17	ULS-Set(40)	22.1	0.0	0.2	12.7	0.2	5.1	5.1	OK
B6229-arc 21	STIFF1	▲6.0	17	ULS-Set(40)	22.6	0.0	0.0	13.0	0.0	5.2	5.2	OK
B6229-arc 22	STIFF1	▲6.0	17	ULS-Set(39)	23.0	0.0	0.1	13.3	0.2	5.3	5.3	OK
B6229-arc 23	STIFF1	▲6.0	17	ULS-Set(39)	23.2	0.0	0.0	13.4	0.1	5.3	5.3	OK
B6229-arc 24	STIFF1	▲6.0	17	ULS-Set(35)	23.3	0.0	1.3	13.4	1.5	5.4	5.4	OK
B6229-arc 25	STIFF1	▲6.0	17	ULS-Set(35)	25.8	0.0	0.9	14.9	1.1	5.9	5.9	OK
B6229-arc 26	STIFF1	▲6.0	17	ULS-Set(35)	27.8	0.0	0.7	16.0	1.0	6.4	6.4	OK
B6229-arc 27	STIFF1	▲6.0	17	ULS-Set(35)	28.8	0.0	-0.1	16.6	0.5	6.6	6.6	OK
B6229-arc 28	STIFF1	▲6.0	17	ULS-Set(35)	30.0	0.0	-0.7	17.3	-0.3	6.9	6.9	OK
B6229-arc 29	STIFF1	▲6.0	17	ULS-Set(35)	29.8	0.0	-1.2	17.2	-0.7	6.8	6.8	OK
B6229-arc 30	STIFF1	▲6.0	17	ULS-Set(35)	28.0	0.0	-1.8	16.1	-1.2	6.4	6.4	OK
B6229-arc 31	STIFF1	▲6.0	17	ULS-Set(23)	29.6	0.0	1.8	16.8	2.8	6.8	6.8	OK
B6229-arc 32	STIFF1	▲6.0	17	ULS-Set(23)	32.1	0.0	1.1	18.4	2.0	7.4	7.4	OK
B6229-arc 33	STIFF1	▲6.0	17	ULS-Set(23)	34.0	0.0	0.1	19.6	1.0	7.8	7.8	OK
B6229-arc 34	STIFF1	▲6.0	17	ULS-Set(23)	34.4	0.0	-0.8	19.9	-0.3	7.9	7.9	OK
B6229-arc 35	STIFF1	▲6.0	17	ULS-Set(23)	33.6	0.0	-1.4	19.3	-1.5	7.7	7.7	OK

Item	Edge	Throat th. [mm]	Length [mm]	Loads	$\sigma_{w,Ed}$ [MPa]	ϵ_{pl} [%]	σ_{\perp} [MPa]	τ_{\parallel} [MPa]	τ_{\perp} [MPa]	Ut [%]	Ut _c [%]	Status
B6229-arc 36	STIFF1	▲6.0	17	ULS-Set(14)	30.5	0.0	0.2	17.6	0.2	7.0	7.0	OK
B6229-arc 37	STIFF1	▲6.0	17	ULS-Set(40)	34.2	0.0	-2.4	-19.4	-3.3	7.8	7.8	OK
B6229-arc 38	STIFF1	▲6.0	17	ULS-Set(40)	38.3	0.0	-2.3	-21.9	-3.0	8.8	8.8	OK
B6229-arc 39	STIFF1	▲6.0	17	ULS-Set(36)	41.8	0.0	-0.6	-24.1	-1.2	9.6	9.6	OK
B6229-arc 40	STIFF1	▲6.0	17	ULS-Set(35)	51.2	0.0	-3.2	-29.0	-5.3	11.7	11.7	OK
B6229-arc 41	STIFF1	▲6.0	17	ULS-Set(35)	56.9	0.0	-2.3	-32.7	-3.5	13.1	13.1	OK
B6229-arc 42	STIFF1	▲6.0	17	ULS-Set(35)	61.0	0.0	-0.7	-35.2	-1.0	14.0	14.0	OK
B6229-arc 43	STIFF1	▲6.0	17	ULS-Set(35)	62.1	0.0	0.9	-35.8	1.1	14.2	14.2	OK
B6229-arc 44	STIFF1	▲6.0	17	ULS-Set(35)	59.7	0.0	2.4	-34.3	2.5	13.7	13.7	OK
B6229-arc 45	STIFF1	▲6.0	17	ULS-Set(35)	49.8	0.0	3.6	-28.3	4.4	11.4	11.4	OK
B6229-arc 46	STIFF1	▲6.0	17	ULS-Set(35)	40.0	0.0	6.4	-21.6	7.3	9.2	9.2	OK
B6229-arc 47	STIFF1	▲6.0	17	ULS-Set(23)	38.8	0.0	-0.3	-22.4	0.0	8.9	8.9	OK
B6229-arc 48	STIFF1	▲6.0	17	ULS-Set(23)	36.9	0.0	0.1	-21.3	1.1	8.5	8.5	OK
B6229-arc 49	STIFF1	▲6.0	17	ULS-Set(14)	34.4	0.0	-2.2	-19.7	-1.9	7.9	7.9	OK
B6229-arc 50	STIFF1	▲6.0	17	ULS-Set(36)	40.1	0.0	4.0	22.5	4.9	9.2	9.2	OK
B6229-arc 51	STIFF1	▲6.0	17	ULS-Set(36)	48.5	0.0	2.8	27.8	3.1	11.1	11.1	OK
B6229-arc 52	STIFF1	▲6.0	17	ULS-Set(36)	54.0	0.0	1.5	31.1	1.2	12.4	12.4	OK
B6229-arc 53	STIFF1	▲6.0	17	ULS-Set(36)	56.0	0.0	-0.1	32.4	-0.2	12.9	12.9	OK
B6229-arc 54	STIFF1	▲6.0	17	ULS-Set(35)	57.3	0.0	1.0	33.1	0.7	13.1	13.1	OK
B6229-arc 55	STIFF1	▲6.0	17	ULS-Set(35)	56.5	0.0	0.1	32.6	-0.8	13.0	13.0	OK
B6229-arc 56	STIFF1	▲6.0	17	ULS-Set(35)	53.0	0.0	-1.4	30.5	-2.6	12.2	12.2	OK
B6229-arc 57	STIFF1	▲6.0	17	ULS-Set(35)	48.9	0.0	-2.5	28.0	-3.5	11.2	11.2	OK
B6229-arc 58	STIFF1	▲6.0	17	ULS-Set(35)	43.0	0.0	-3.4	24.5	-3.6	9.9	9.9	OK
B6229-arc 59	STIFF1	▲6.0	17	ULS-Set(35)	36.1	0.0	-4.1	20.3	-4.1	8.3	8.3	OK
B6229-arc 60	STIFF1	▲6.0	17	ULS-Set(35)	29.8	0.0	-5.2	16.2	-5.0	6.8	6.8	OK
B6229-arc 61	STIFF1	▲6.0	17	ULS-Set(23)	34.8	0.0	4.7	18.6	7.0	8.0	8.0	OK
B6229-arc 62	STIFF1	▲6.0	17	ULS-Set(23)	42.7	0.0	4.1	23.7	6.6	9.8	9.8	OK
B6229-arc 63	STIFF1	▲6.0	17	ULS-Set(23)	48.2	0.0	2.5	27.4	4.6	11.1	11.1	OK
B6229-arc 64	STIFF1	▲6.0	17	ULS-Set(14)	52.1	0.0	2.7	29.8	3.8	12.0	12.0	OK

Design data

	β_w [-]	$\sigma_{w,Rd}$ [MPa]	0.9σ [MPa]
S 355	0.90	435.6	352.8

Symbol explanation

ϵ_{pl}	Strain
$\sigma_{w,Ed}$	Equivalent stress
$\sigma_{w,Rd}$	Equivalent stress resistance
σ_{\perp}	Perpendicular stress
$\tau_{ }$	Shear stress parallel to weld axis
τ_{\perp}	Shear stress perpendicular to weld axis
0.9σ	Perpendicular stress resistance - $0.9 \cdot f_u / \gamma_{M2}$
β_w	Corelation factor EN 1993-1-8 tab. 4.1
Ut	Utilization
Utc	Weld capacity utilization

Buckling

Buckling analysis was not calculated.

Code settings

Item	Value	Unit	Reference
YM0	1.00	-	EN 1993-1-1: 6.1
YM1	1.00	-	EN 1993-1-1: 6.1
YM2	1.25	-	EN 1993-1-1: 6.1
YM3	1.25	-	EN 1993-1-8: 2.2
YC	1.50	-	EN 1992-1-1: 2.4.2.4
Yinst	1.20	-	EN 1992-4: Table 4.1
Joint coefficient β_j	0.67	-	EN 1993-1-8: 6.2.5
Effective area - influence of mesh size	0.10	-	
Friction coefficient - concrete	0.25	-	EN 1993-1-8
Friction coefficient in slip-resistance	0.30	-	EN 1993-1-8 tab 3.7
Limit plastic strain	0.05	-	EN 1993-1-5
Weld stress evaluation	Plastic redistribution		
Detailing	No		
Distance between bolts [d]	2.20	-	EN 1993-1-8: tab 3.3
Distance between bolts and edge [d]	1.20	-	EN 1993-1-8: tab 3.3
Concrete breakout resistance check	Both		EN 1992-4: 7.2.1.4 and 7.2.2.5
Use calculated ab in bearing check.	Yes		EN 1993-1-8: tab 3.4
Cracked concrete	Yes		EN 1992-4
Local deformation check	No		CIDECT DG 1, 3 - 1.1
Local deformation limit	0.03	-	CIDECT DG 1, 3 - 1.1
Geometrical nonlinearity (GMNA)	Yes		Analysis with large deformations for hollow section joints
Braced system	No		EN 1993-1-8: 5.2.2.5

5.7. Karakteristični spoj pokrova

Project item Con N5737

Design

Name	Con N5737
Description	
Analysis	Stiffness

Beams and columns

Name	Cross-section	β - Direction [°]	γ - Pitch [°]	α - Rotation [°]	Offset ex [mm]	Offset ey [mm]	Offset ez [mm]	Forces in
B5618	1 - Massive O Hollow(CHS273,8)	0.0	0.0	0.0	0	0	0	Position
B5622	1 - Massive O Hollow(CHS273,8)	0.0	0.0	0.0	0	-200	0	Position
B5626	1 - Massive O Hollow(CHS273,8)	0.0	0.0	0.0	0	0	0	Position

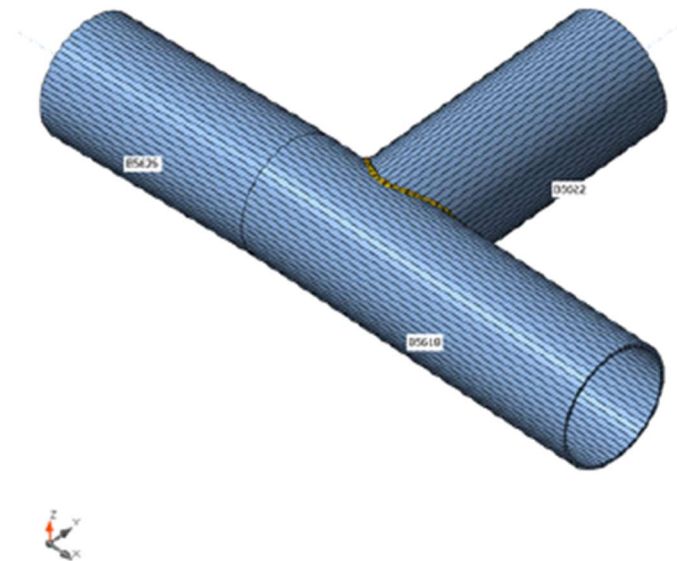

Cross-sections

Name	Material
1 - Massive O Hollow(CHS273,8)	S 355

Load effects

Name	Member	N [kN]	Vy [kN]	Vz [kN]	Mx [kNm]	My [kNm]	Mz [kNm]
ULS-Set(1)	B5618	-34.2	-0.7	-10.6	16.2	13.6	1.9
	B5622	-0.1	-1.0	10.9	3.0	-24.8	-1.4
	B5626	35.8	0.6	1.7	8.4	-10.6	1.3
ULS-Set(2)	B5618	35.6	0.1	-2.5	0.8	1.3	-0.3
	B5622	0.2	-0.4	1.6	-0.8	-4.0	-0.1
	B5626	-35.1	0.2	-1.0	3.1	-2.1	0.7
ULS-Set(13)	B5618	-21.5	0.2	5.5	-3.2	1.1	-0.4
	B5622	-0.1	0.8	-1.6	-0.7	5.5	0.7
	B5626	20.8	-0.2	-2.9	-2.3	-1.9	-0.7
ULS-Set(14)	B5618	24.9	-1.2	-6.2	7.0	1.1	2.3
	B5622	-1.9	-0.7	5.8	0.3	-12.9	-0.5
	B5626	-23.8	-0.7	-0.9	5.9	-0.8	-0.7
ULS-Set(15)	B5618	-32.5	0.0	2.4	1.4	4.4	0.2
	B5622	-0.1	0.5	1.1	0.4	-0.9	0.2
	B5626	32.2	-0.1	-1.7	-0.5	-4.1	-0.3
ULS-Set(17)	B5618	32.7	0.0	-2.8	2.7	4.3	-0.3
	B5622	0.3	-0.6	2.2	-0.1	-5.8	-0.3
	B5626	-32.0	0.3	-1.1	3.1	-4.3	1.1
ULS-Set(19)	B5618	30.3	-0.6	-3.3	2.0	-1.5	1.1
	B5622	-1.1	-0.4	2.9	-1.0	-6.0	-0.1
	B5626	-29.7	-0.5	-1.2	4.1	0.5	-0.5
ULS-Set(21)	B5618	34.4	0.1	-2.0	1.4	3.0	-0.4
	B5622	0.3	-0.5	1.1	-0.1	-3.5	-0.3
	B5626	-33.8	0.3	-1.0	2.0	-3.2	1.0
ULS-Set(25)	B5618	-30.8	0.0	3.2	0.2	3.2	0.0
	B5622	-0.1	0.5	0.0	0.3	1.4	0.2
	B5626	30.4	-0.1	-1.6	-1.6	-2.9	-0.4
ULS-Set(33)	B5618	32.1	-0.1	-5.6	6.3	7.0	0.1
	B5622	0.3	-0.9	4.8	0.6	-11.8	-0.6
	B5626	-30.9	0.4	-0.8	5.3	-6.4	1.4
ULS-Set(35)	B5618	-33.1	-0.2	-0.5	5.1	7.2	0.6
	B5622	-0.1	0.2	3.6	1.1	-6.8	-0.1
	B5626	33.2	0.1	-1.4	1.7	-6.1	0.0

Check

Rotational stiffness

Name	Comp.	Loads	Mj,Rd [kNm]	Sj,ini [MNm/rad]	Φ_c [mrad]	L [m]	Sj,R [MNm/rad]	Sj,P [MNm/rad]	Class.
B5618	Mx	ULS-Set(1)	19.6	1562.7	0.0	6.00			
	My	ULS-Set(1)	120.8	∞	5.8	6.00	51.1	1.0	Rigid
	Mx	ULS-Set(2)	0.7	413930.3	0.0	6.00			
	My	ULS-Set(2)	78.3	∞	4.1	6.00	51.1	1.0	Rigid
	Mx	ULS-Set(13)	-2.0	1.2	1.6	6.00			
	My	ULS-Set(13)	63.2	87.3	-5.3	6.00	51.1	1.0	Rigid
	Mx	ULS-Set(14)	13.8	∞	1.3	6.00			
	My	ULS-Set(14)	2.1	∞	4.2	6.00	51.1	1.0	Rigid
	Mx	ULS-Set(15)	3.5	6.1	1.8	6.00			
	My	ULS-Set(15)	242.6	∞	10.8	6.00	51.1	1.0	Rigid
	Mx	ULS-Set(17)	3.5	∞	0.0	6.00			
	My	ULS-Set(17)	129.6	∞	6.2	6.00	51.1	1.0	Rigid
	Mx	ULS-Set(19)	3.3	1.3	-1.7	6.00			
	My	ULS-Set(19)	-169.5	∞	0.0	6.00	51.1	1.0	Rigid
	Mx	ULS-Set(21)	1.9	∞	0.1	6.00			
	My	ULS-Set(21)	130.1	∞	7.1	6.00	51.1	1.0	Rigid
	Mx	ULS-Set(25)	0.5	0.3	2.6	6.00			
	My	ULS-Set(25)	241.1	∞	12.4	6.00	51.1	1.0	Rigid
	Mx	ULS-Set(33)	7.6	∞	0.0	6.00			
	My	ULS-Set(33)	119.8	∞	5.4	6.00	51.1	1.0	Rigid
	Mx	ULS-Set(35)	9.6	6020.1	-0.1	6.00			
	My	ULS-Set(35)	188.2	∞	16.8	6.00	51.1	1.0	Rigid
	Mz	ULS-Set(1)	17.1	75.1	0.7	6.00	51.1	1.0	Rigid
	Mz	ULS-Set(2)	16.5	∞	-0.3	6.00	51.1	1.0	Rigid
	Mz	ULS-Set(13)	23.1	∞	-0.6	6.00	51.1	1.0	Rigid
	Mz	ULS-Set(14)	196.5	∞	7.6	6.00	51.1	1.0	Rigid
	Mz	ULS-Set(15)	9.4	301.4	0.6	6.00	51.1	1.0	Rigid
	Mz	ULS-Set(17)	8.1	∞	-0.3	6.00	51.1	1.0	Rigid
	Mz	ULS-Set(19)	-124.1	∞	3.8	6.00	51.1	1.0	Rigid
	Mz	ULS-Set(21)	17.6	∞	-0.7	6.00	51.1	1.0	Rigid
	Mz	ULS-Set(25)	2.3	33.7	0.3	6.00	51.1	1.0	Semi-rigid
	Mz	ULS-Set(33)	2.1	∞	0.1	6.00	51.1	1.0	Rigid
	Mz	ULS-Set(35)	14.7	506.9	1.3	6.00	51.1	1.0	Rigid

Secant rotational stiffness

Name	Comp.	Loads	M [kNm]	S _{js} [MNm/rad]	Φ [mrad]
B5618	Mx	ULS-Set(1)	16.2	1510.8	0.0
	My	ULS-Set(1)	13.6	∞	0.0
	Mx	ULS-Set(2)	0.8	0.0	0.0
	My	ULS-Set(2)	1.3	∞	0.0
	Mx	ULS-Set(13)	-3.2	0.0	0.0
	My	ULS-Set(13)	1.1	87.9	0.0
	Mx	ULS-Set(14)	7.0	∞	0.0
	My	ULS-Set(14)	1.1	∞	0.0
	Mx	ULS-Set(15)	1.4	6.0	0.2
	My	ULS-Set(15)	4.4	∞	0.0
	Mx	ULS-Set(17)	2.7	∞	0.0
	My	ULS-Set(17)	4.3	∞	0.0
	Mx	ULS-Set(19)	2.0	1.3	-1.5
	My	ULS-Set(19)	-1.5	∞	0.0
	Mx	ULS-Set(21)	1.4	∞	0.0
	My	ULS-Set(21)	3.0	∞	0.0
	Mx	ULS-Set(25)	0.2	0.3	0.7
	My	ULS-Set(25)	3.2	∞	0.0
	Mx	ULS-Set(33)	6.3	∞	0.0
	My	ULS-Set(33)	7.0	∞	0.0
	Mx	ULS-Set(35)	5.1	6228.7	0.0
	My	ULS-Set(35)	7.2	∞	0.0
	Mz	ULS-Set(1)	1.9	77.6	0.0
	Mz	ULS-Set(2)	-0.3	0.0	0.0
	Mz	ULS-Set(13)	-0.4	0.0	0.0
	Mz	ULS-Set(14)	2.3	∞	0.0
	Mz	ULS-Set(15)	0.2	289.5	0.0
	Mz	ULS-Set(17)	-0.3	0.0	0.0
	Mz	ULS-Set(19)	1.1	0.0	0.0
	Mz	ULS-Set(21)	-0.4	0.0	0.0
	Mz	ULS-Set(25)	0.0	43.2	0.0
	Mz	ULS-Set(33)	0.1	∞	0.0
	Mz	ULS-Set(35)	0.6	∞	0.0

Symbol explanation

$M_{j,Rd}$	Bending resistance
$S_{j,ini}$	Initial rotational stiffness
$S_{j,s}$	Secant rotational stiffness
Φ	Rotational deformation
Φ _c	Rotational capacity
$S_{j,R}$	Limit value - rigid joint
$S_{j,P}$	Limit value - nominally pinned joint

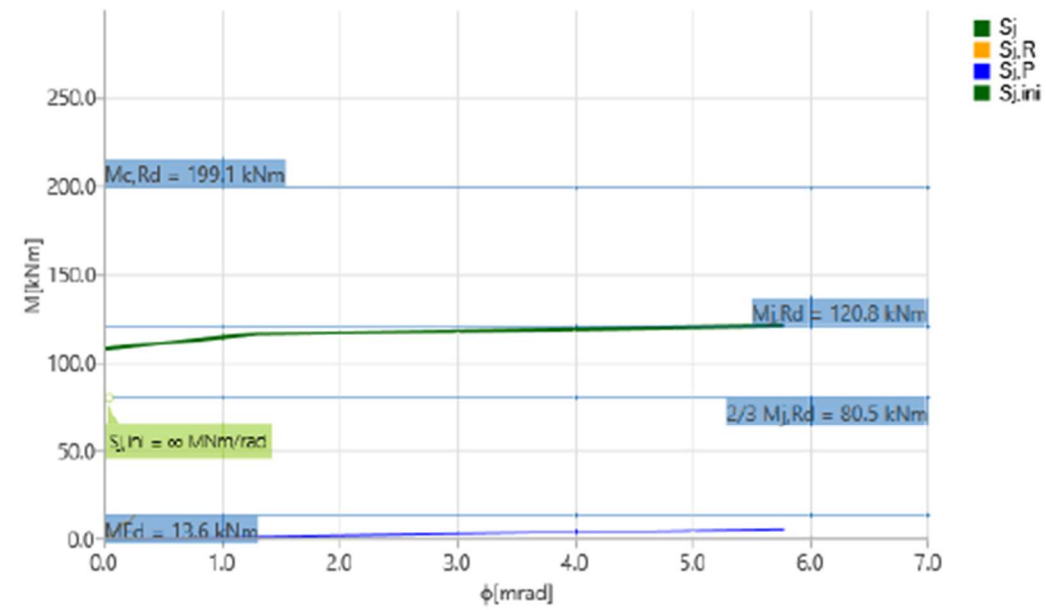
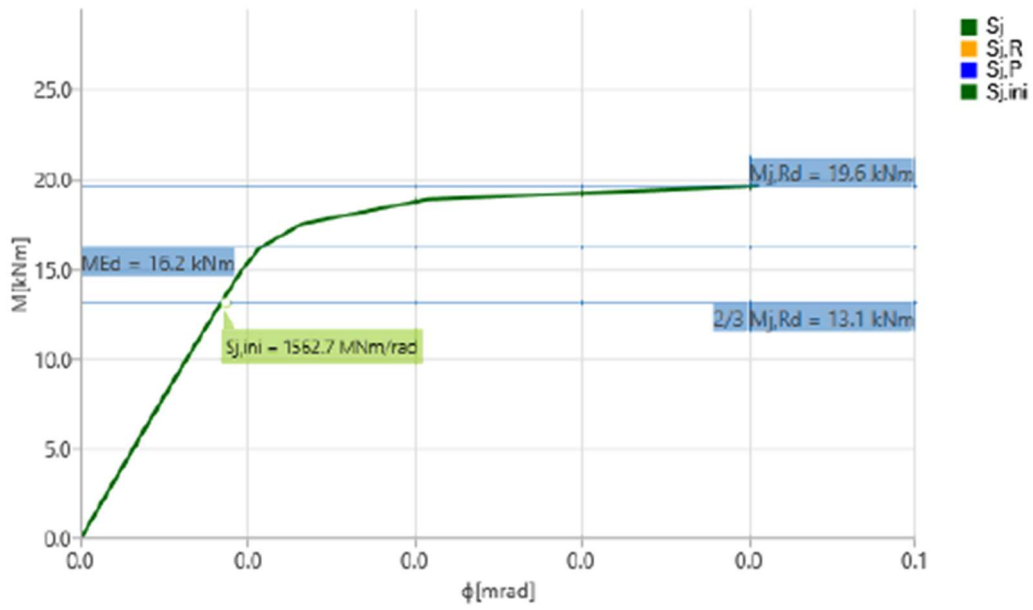

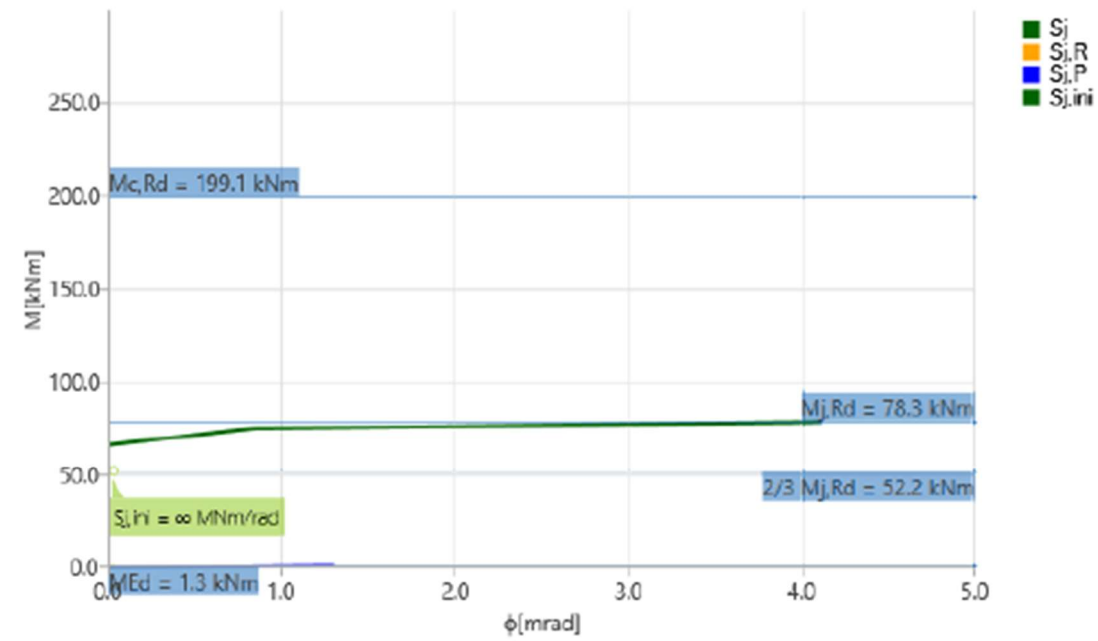
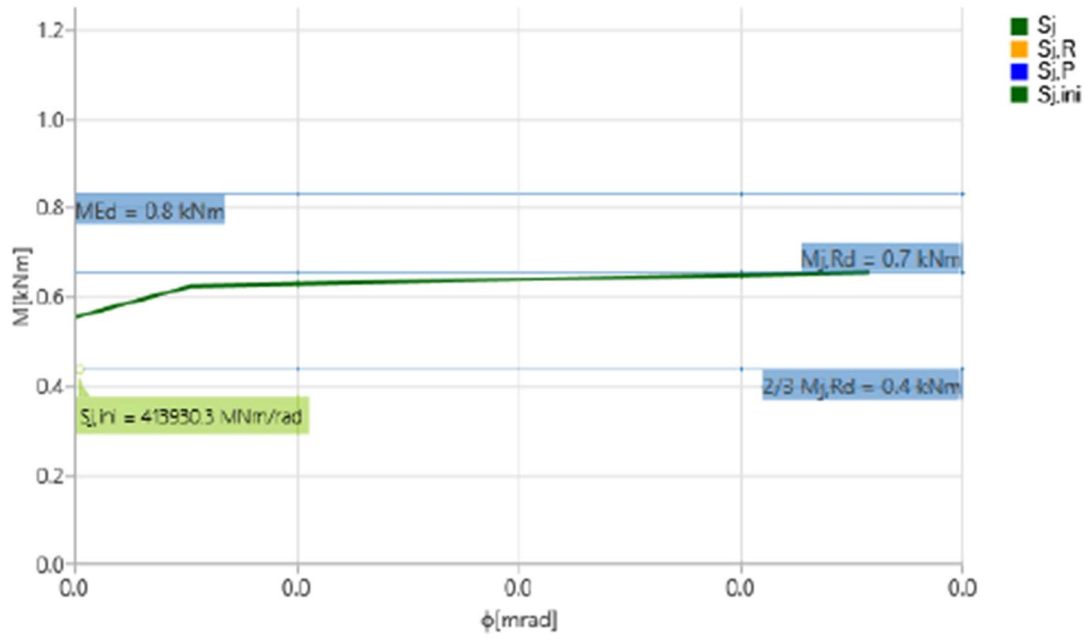

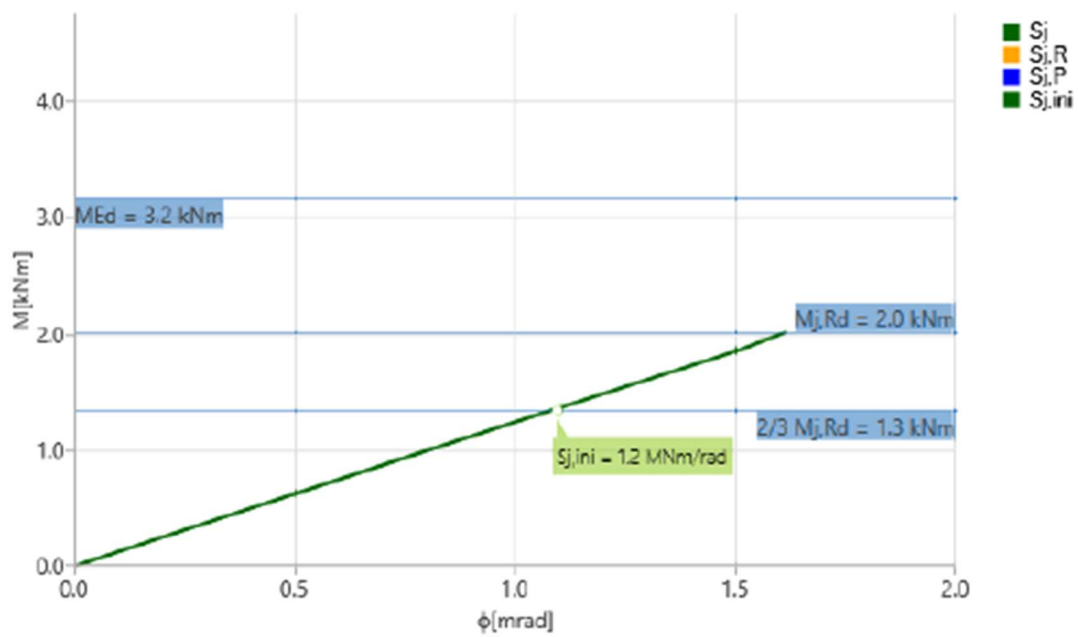

Stiffness diagram $M_x - \phi$, ULS-Set(13)

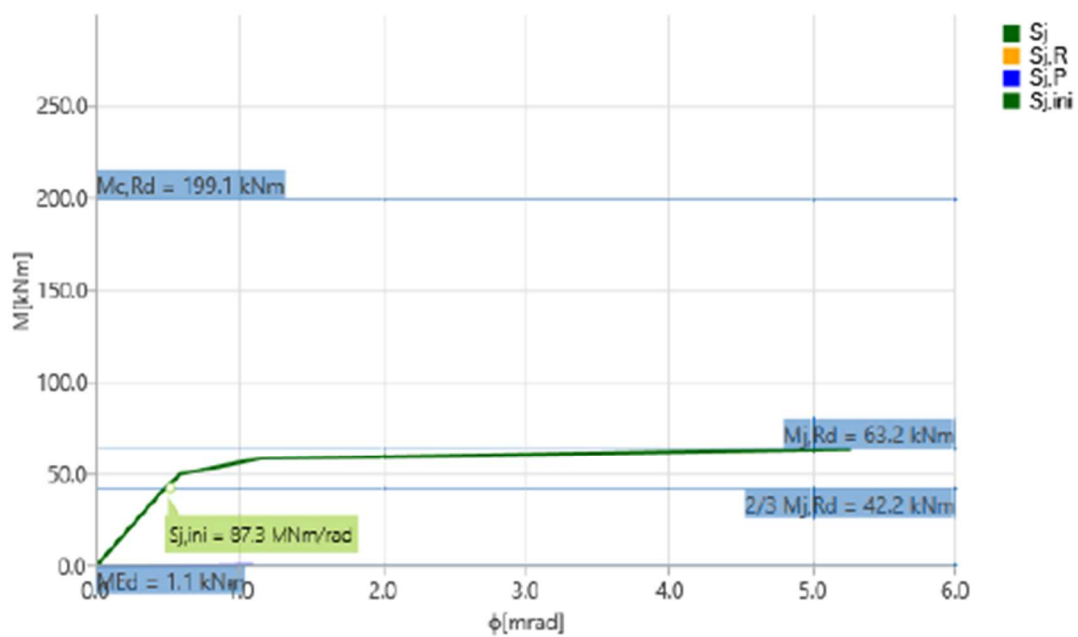

Stiffness diagram $M_y - \phi_y$, ULS-Set(13)

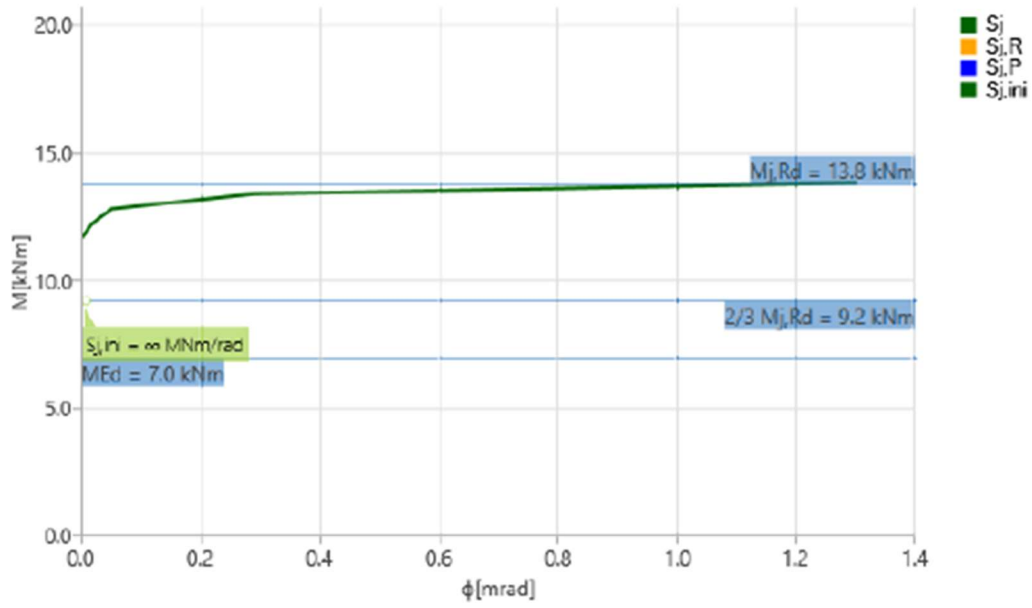

Stiffness diagram $M_x - \phi$. ULS-Set(14)

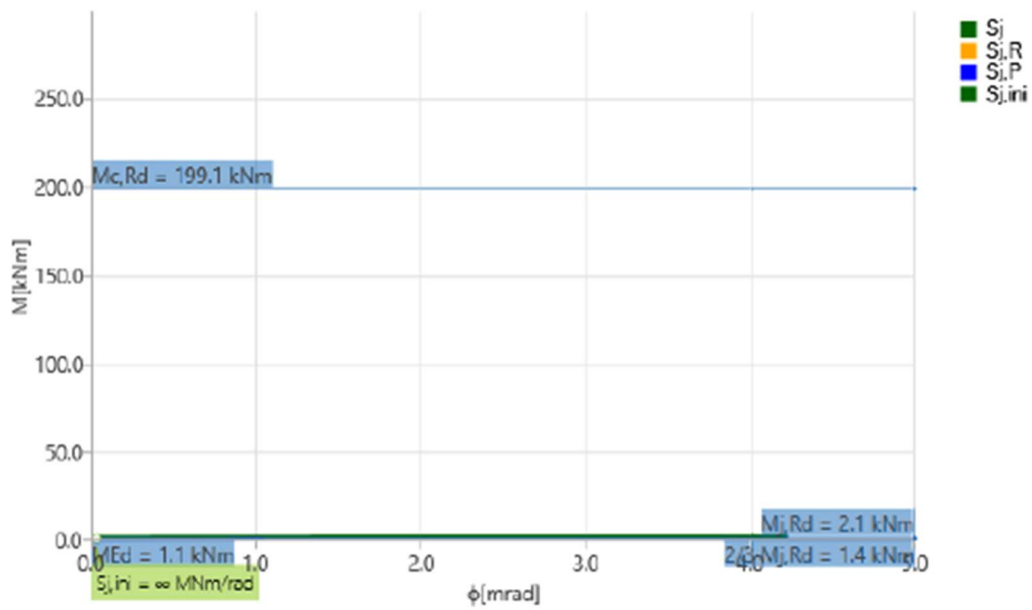

Stiffness diagram $M_y - \phi$. ULS-Set(14)

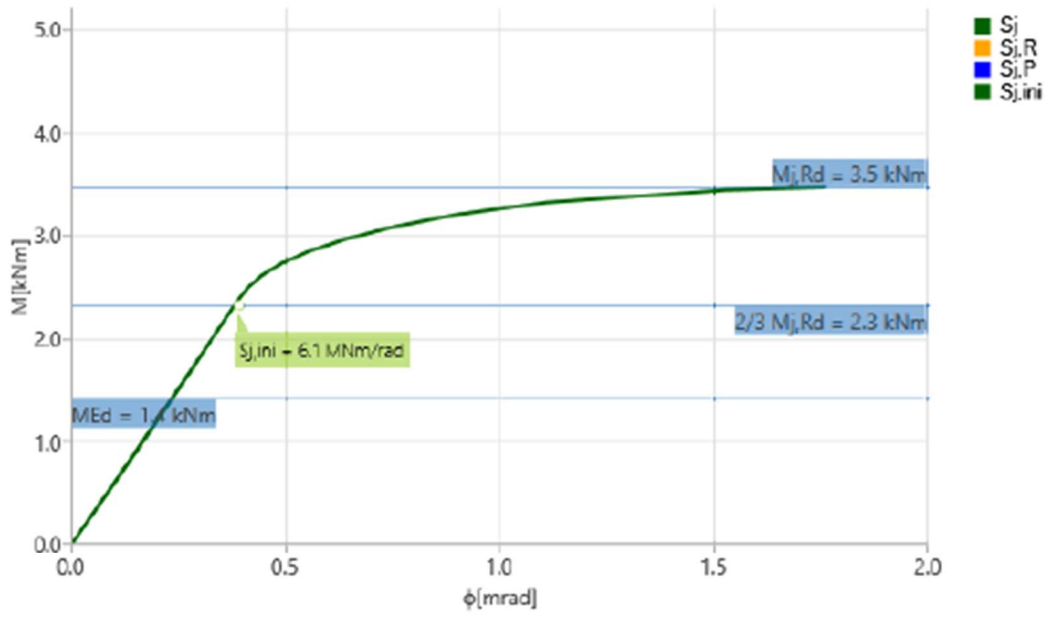

Stiffness diagram $M_x - \phi$. ULS-Set(15)

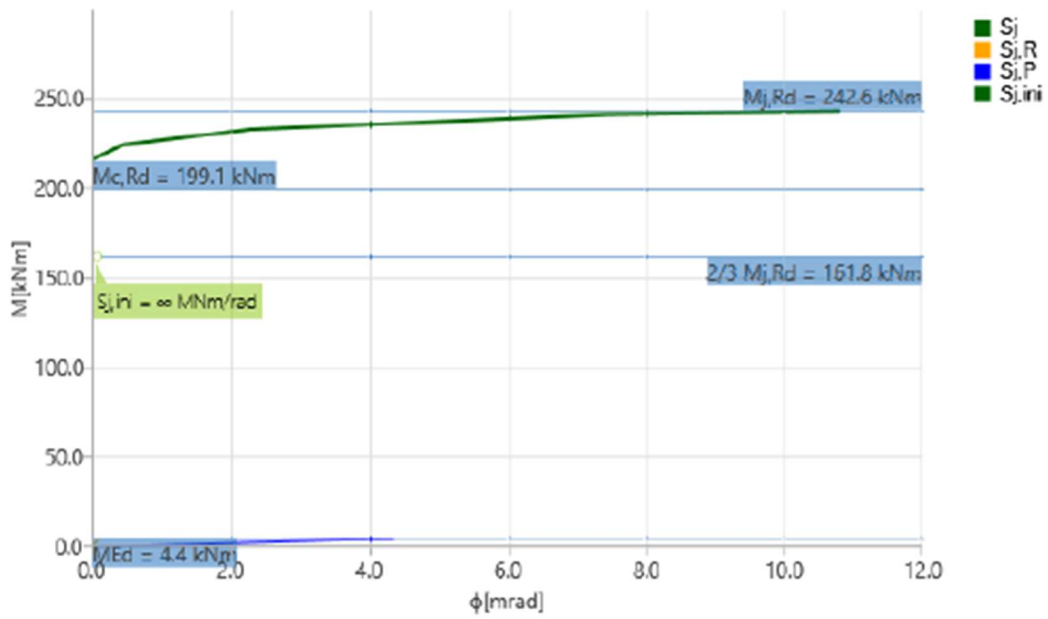

Stiffness diagram $M_y - \phi_y$. ULS-Set(15)

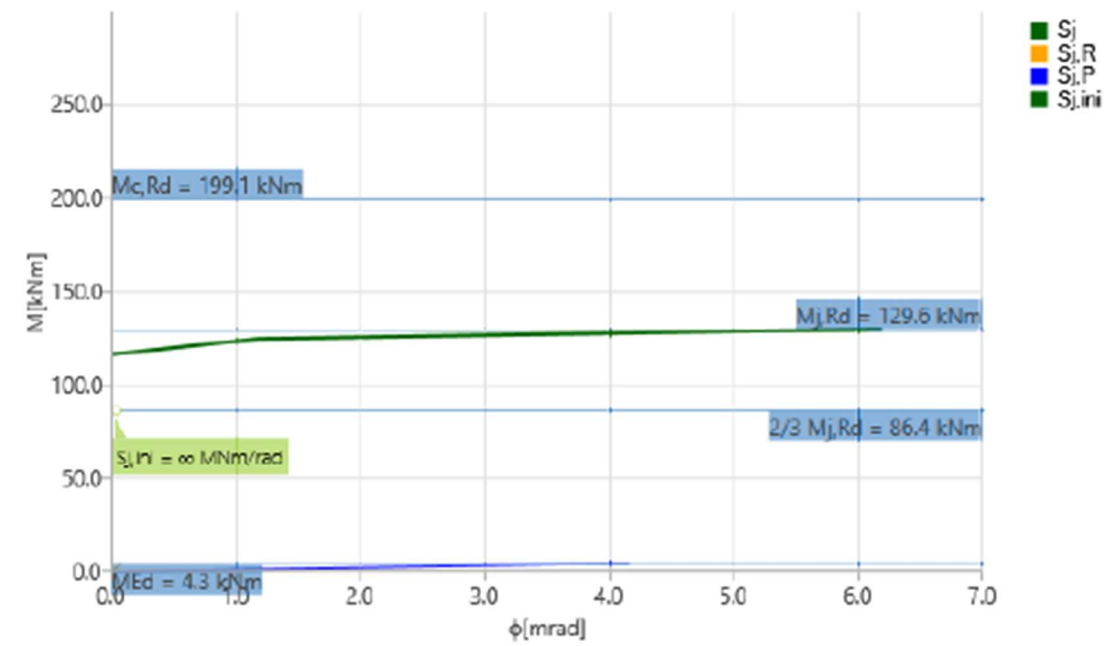
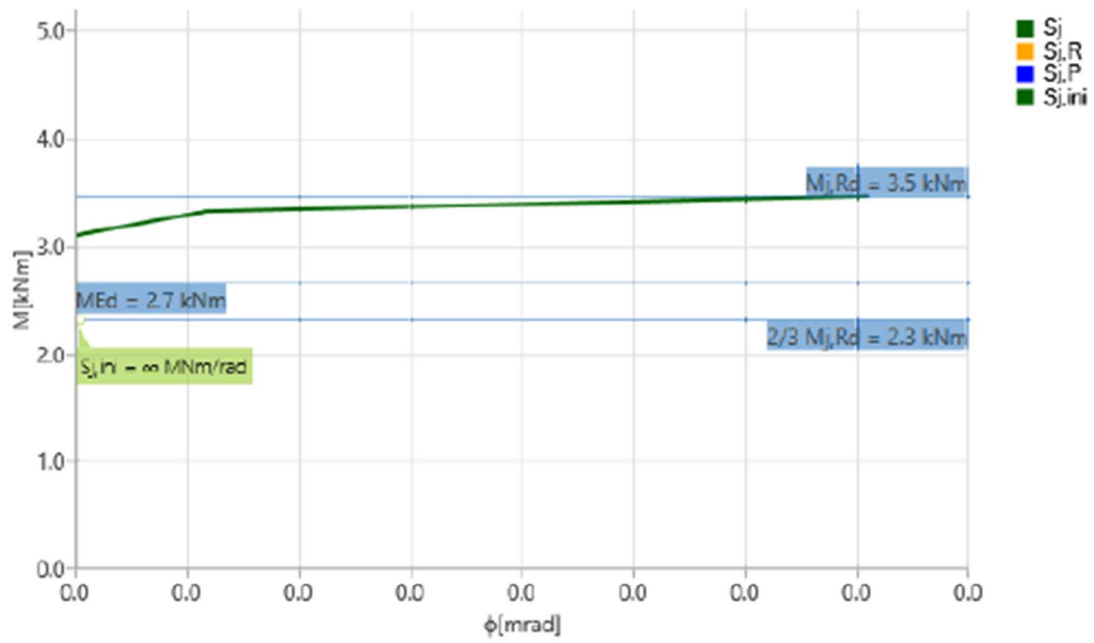

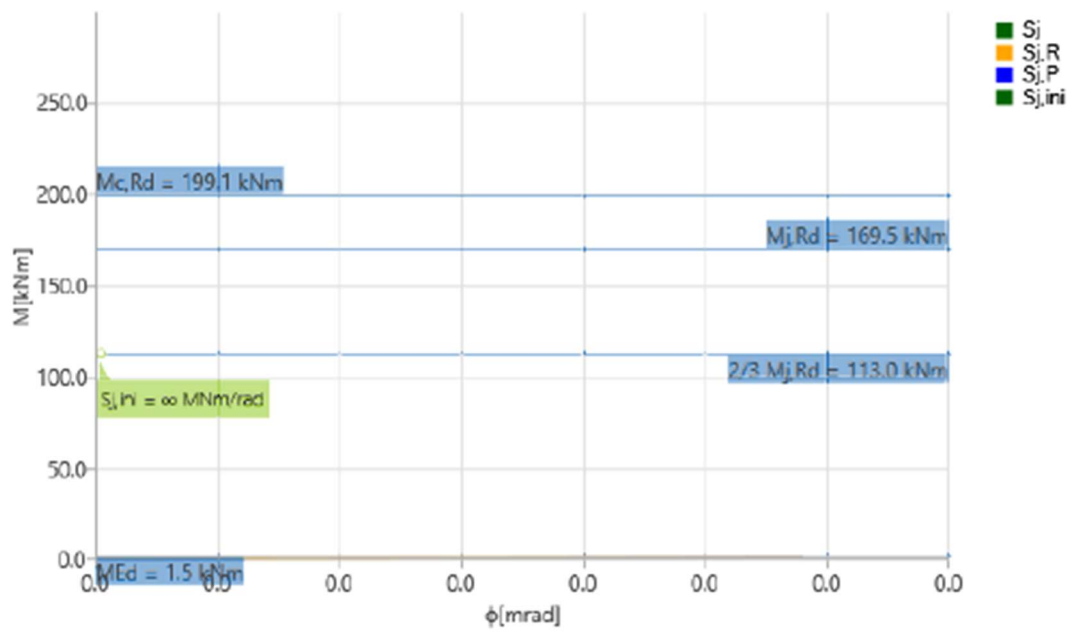
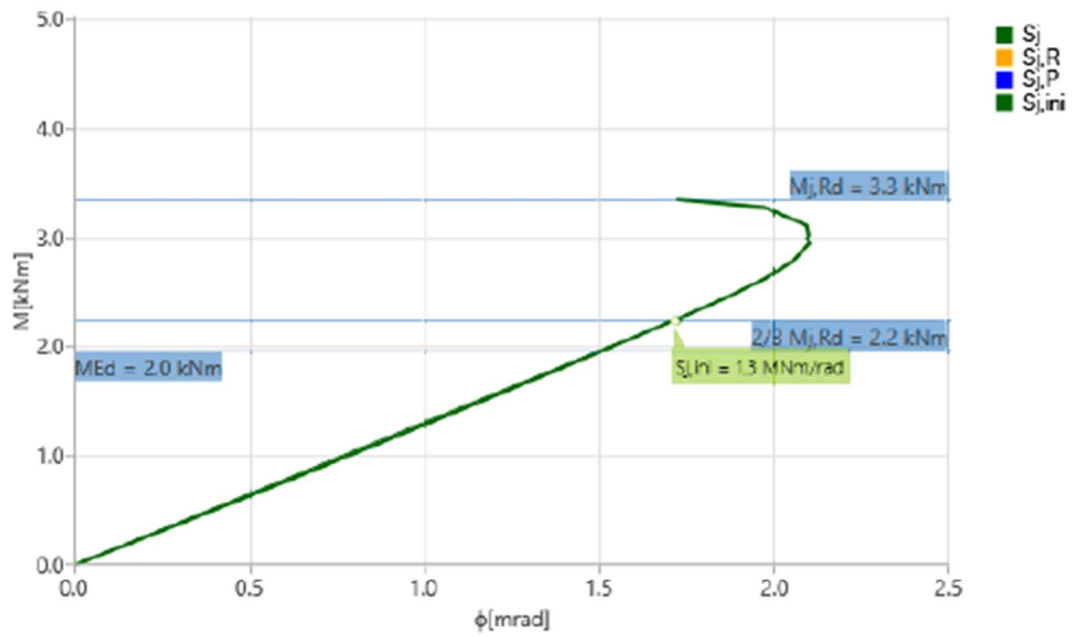

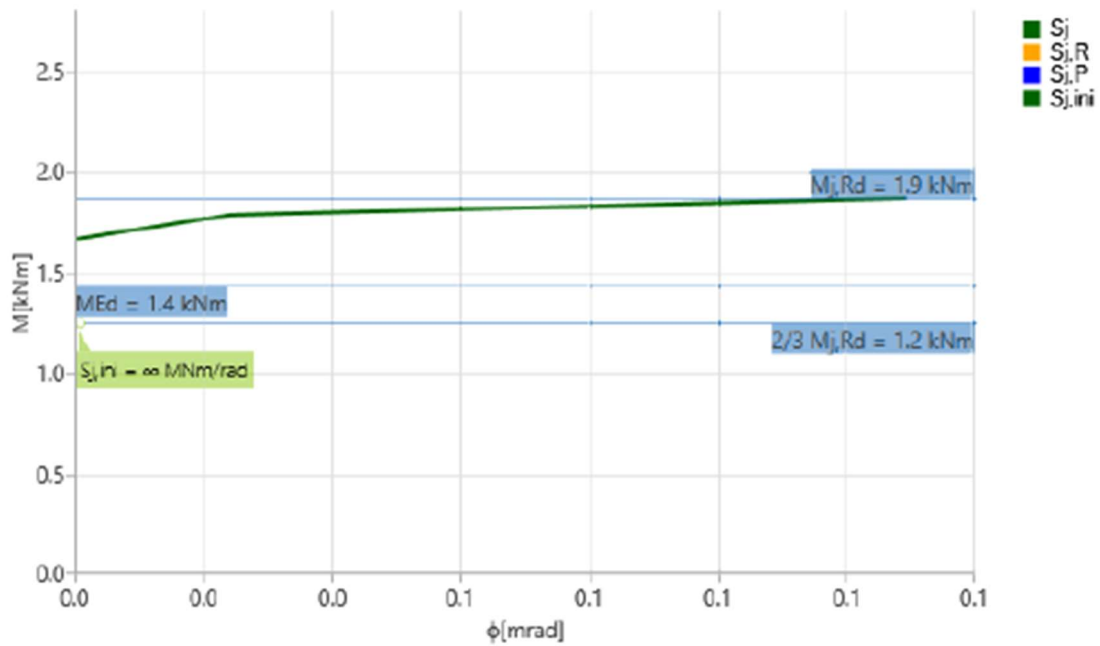

Stiffness diagram $M_x - \phi$, ULS-Set(21)

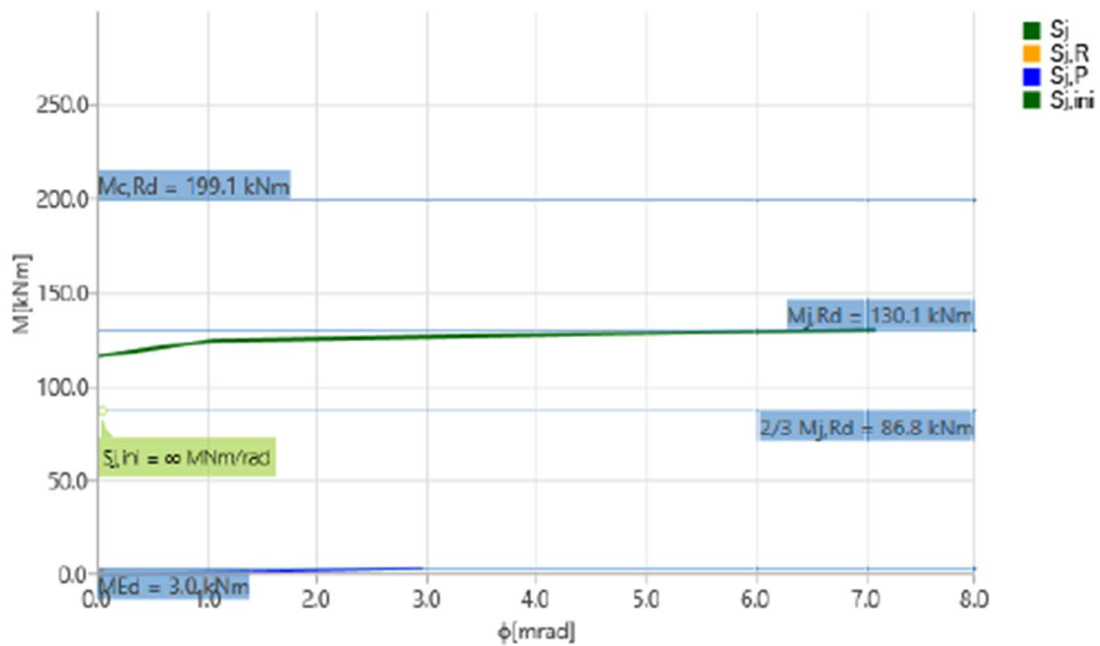

Stiffness diagram $M_y - \phi_y$, ULS-Set(21)

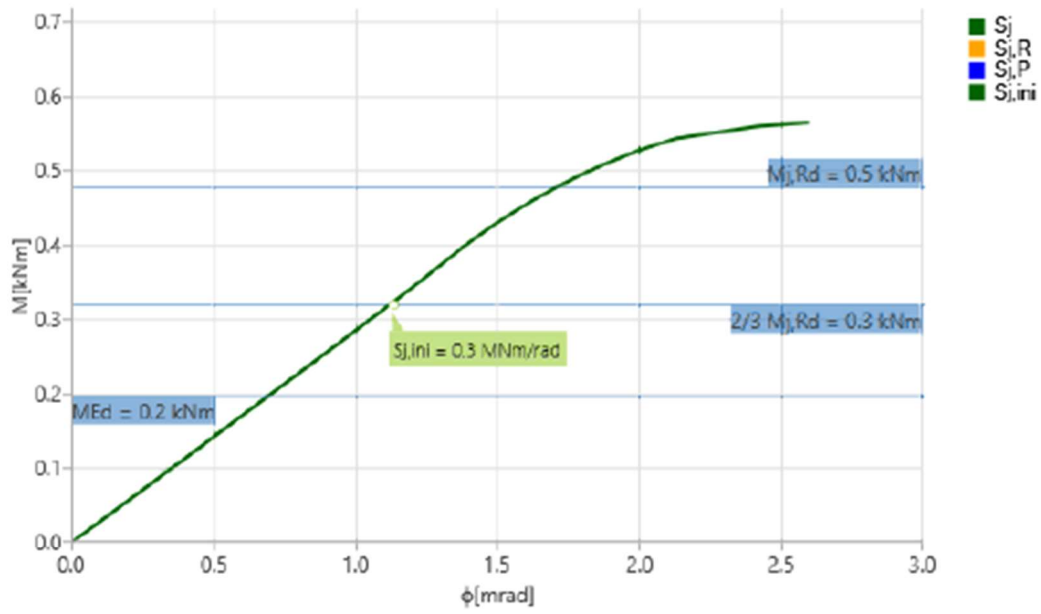

Stiffness diagram $M_x - \phi$. ULS-Set(25)

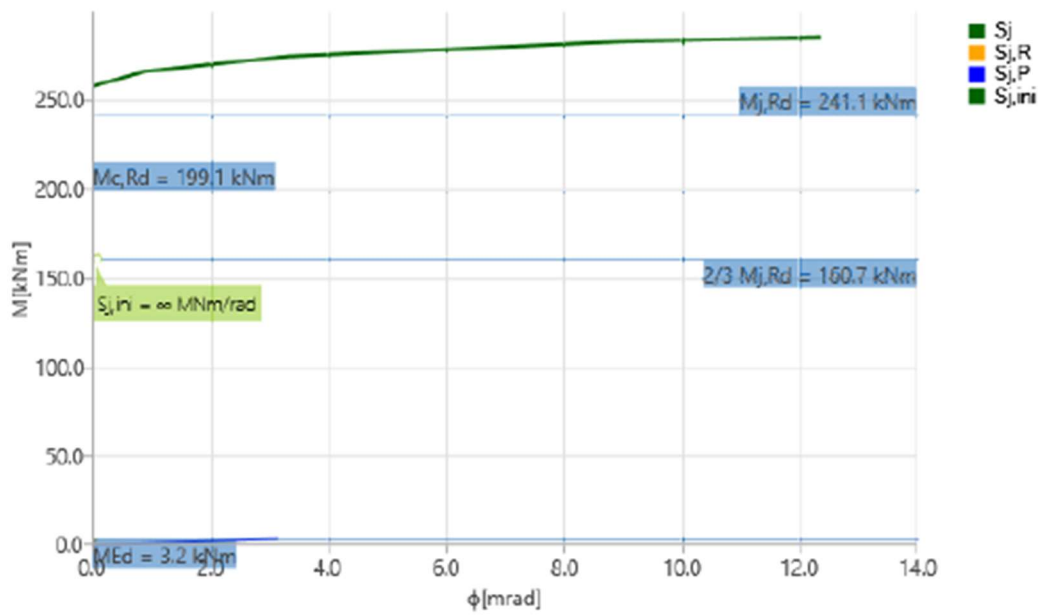

Stiffness diagram $M_y - \phi_y$. ULS-Set(25)

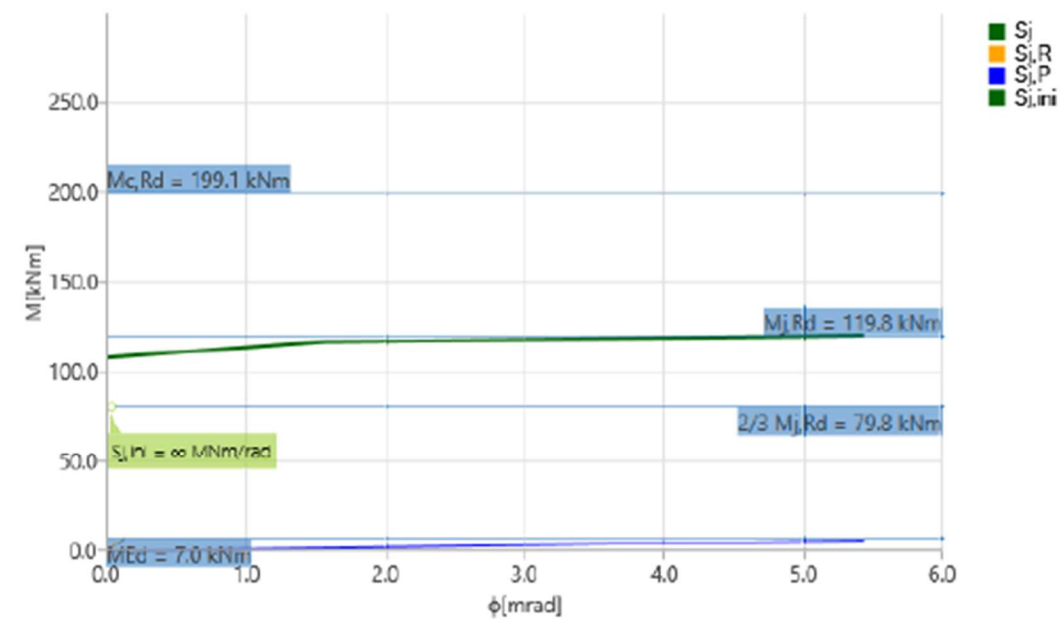
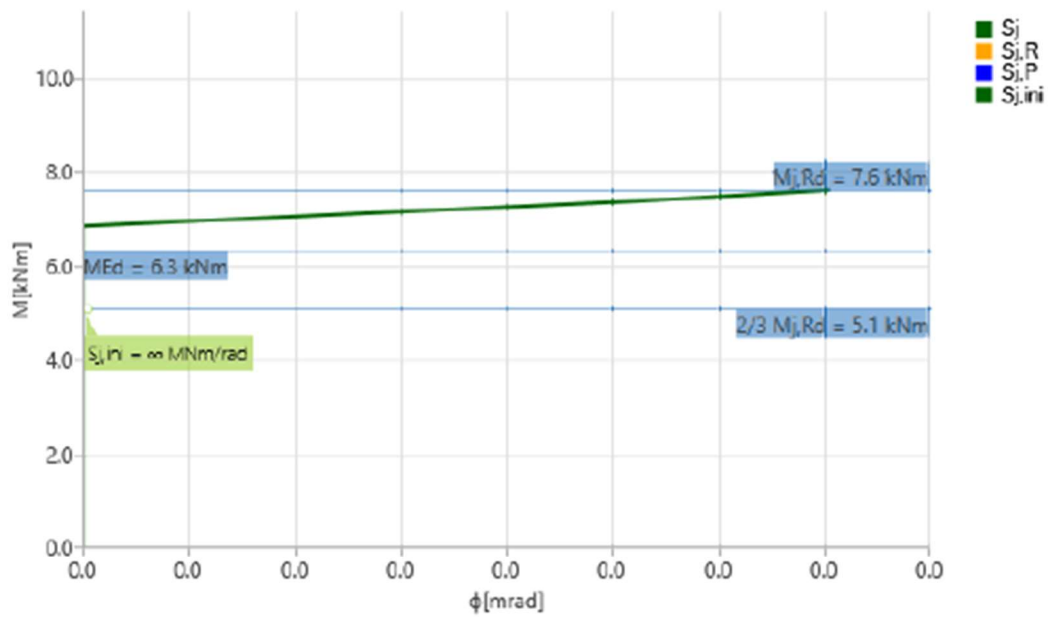

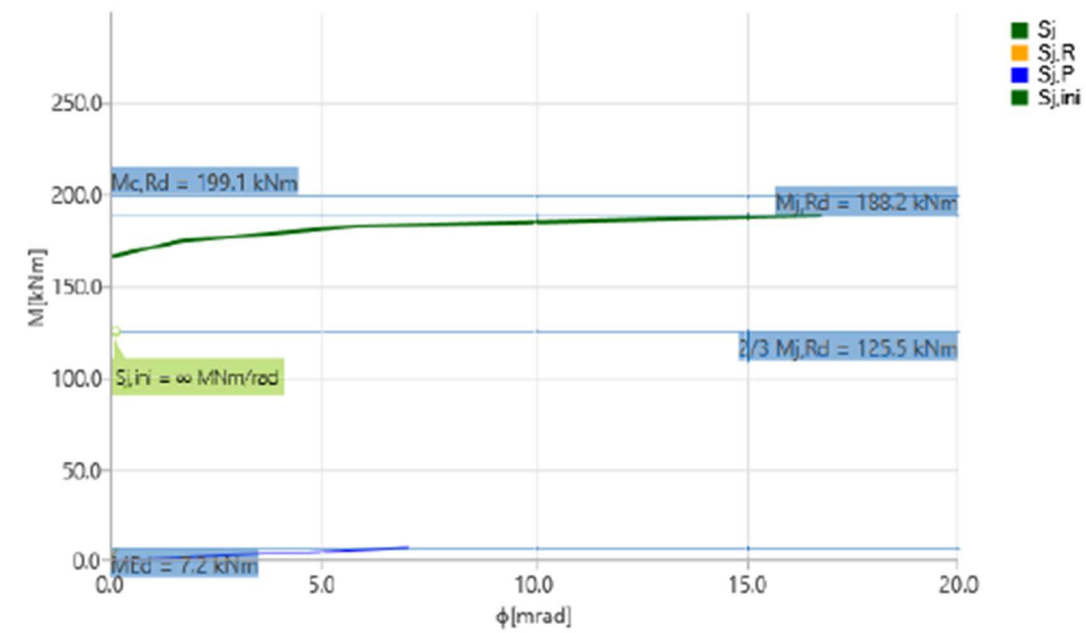
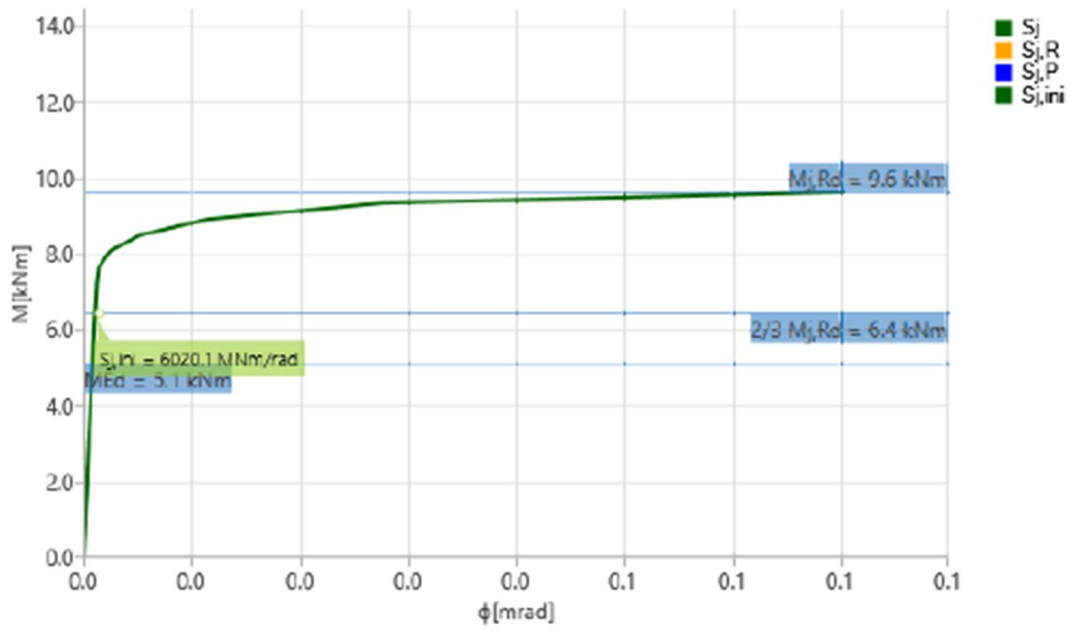

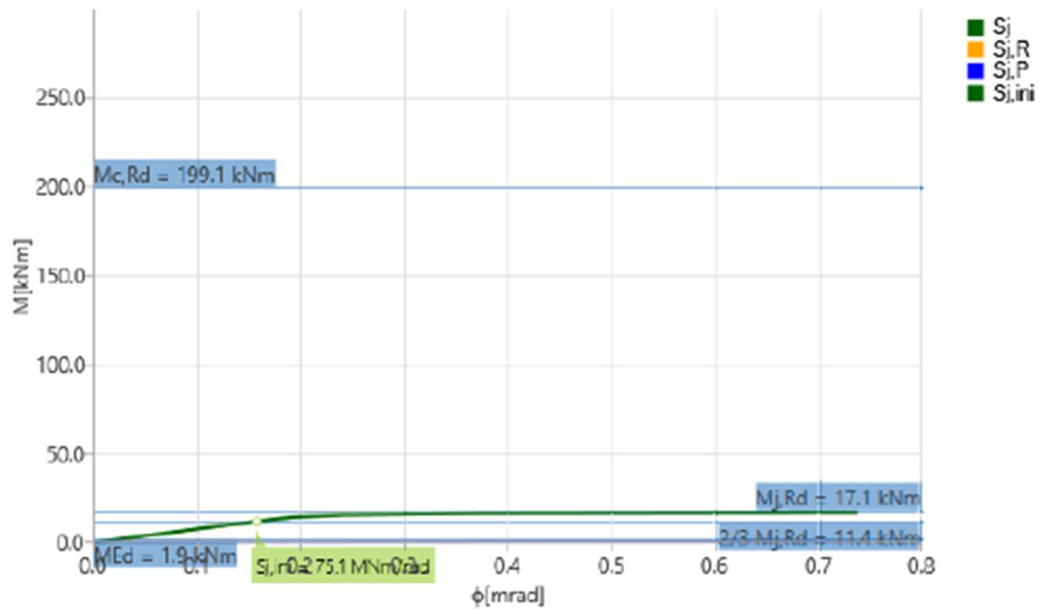

Stiffness diagram $M_z - \phi_z$, ULS-Set(1)

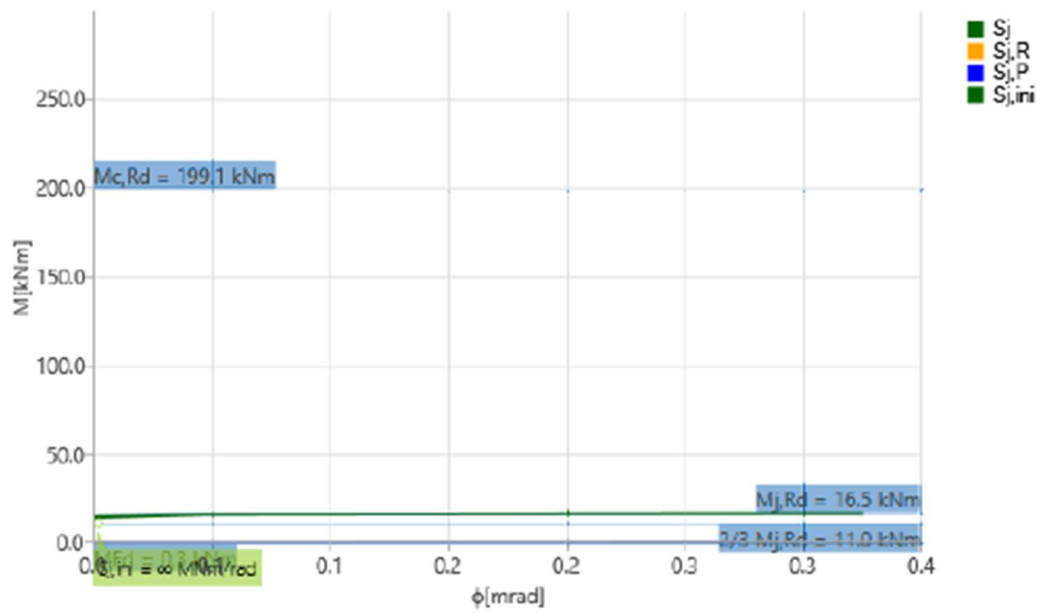

Stiffness diagram $M_z - \phi_z$, ULS-Set(2)

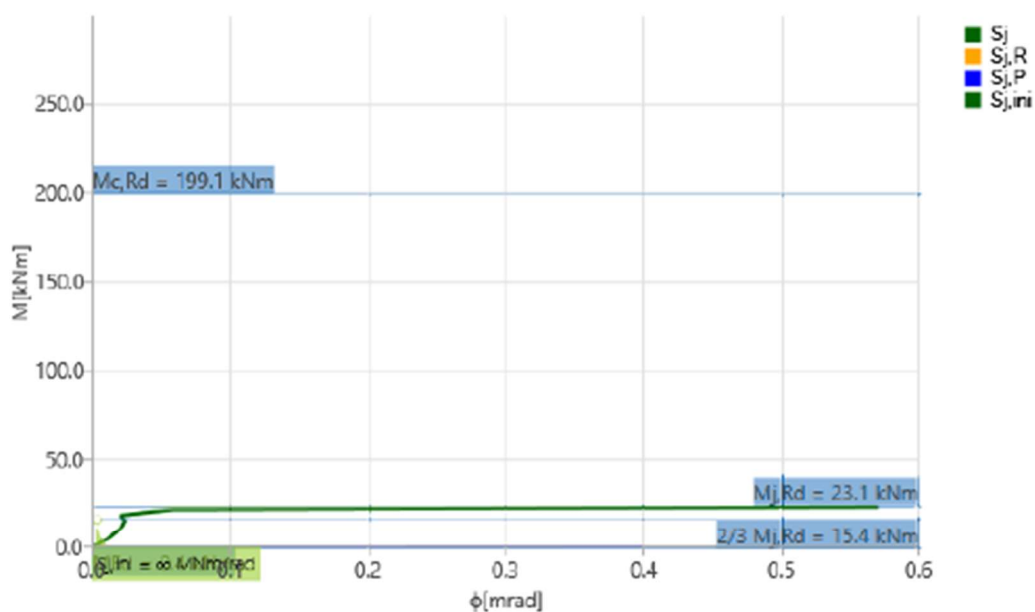

Stiffness diagram $M_z - \phi_z$, ULS-Set(13)

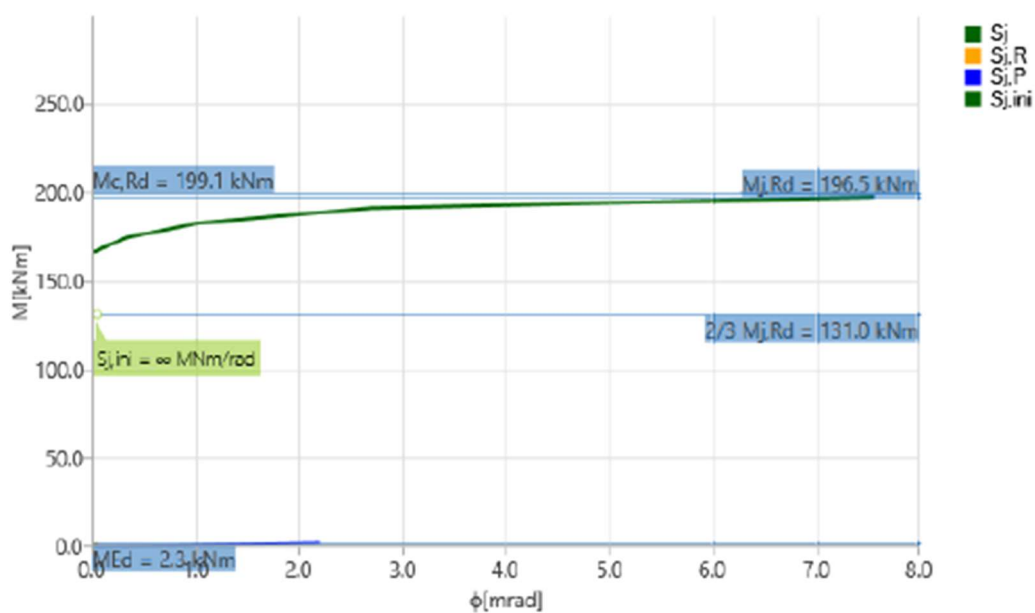

Stiffness diagram $M_z - \phi_z$, ULS-Set(14)

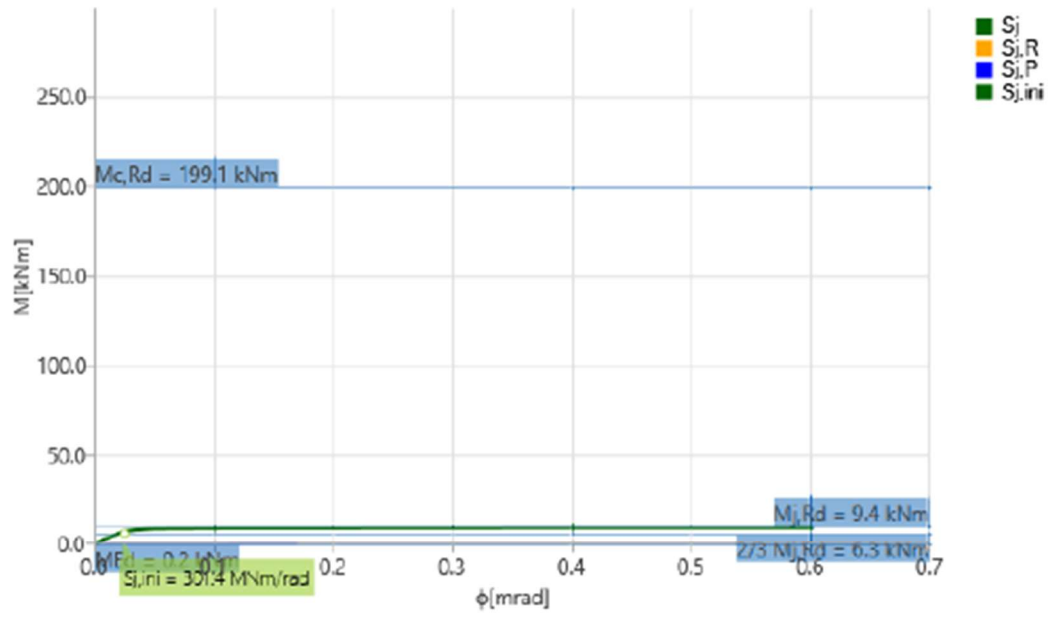

Stiffness diagram $M_z - \phi_z$, ULS-Set(15)

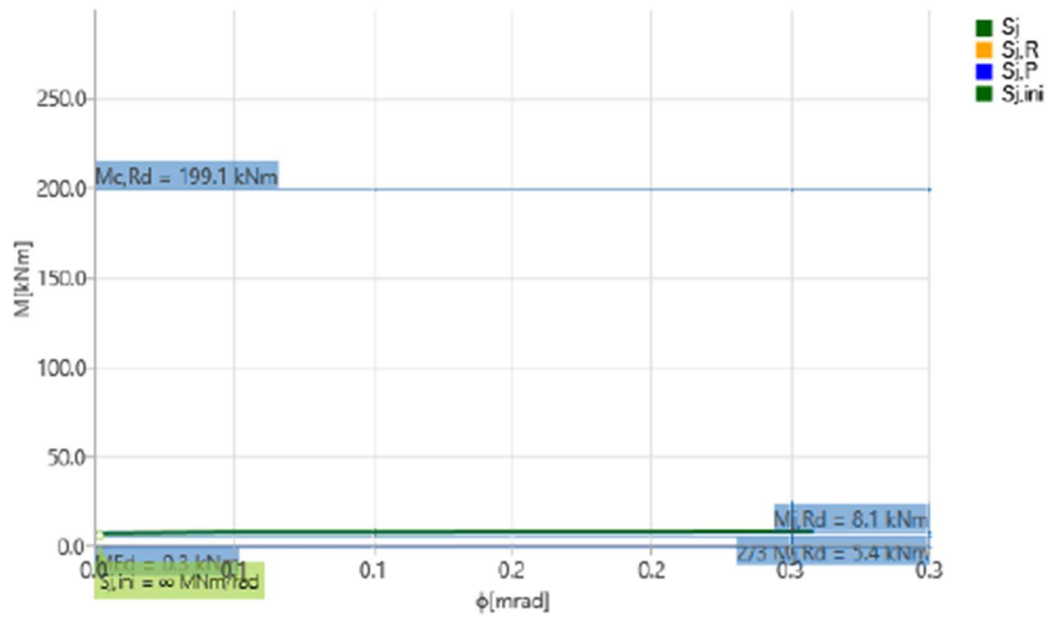

Stiffness diagram $M_z - \phi_z$, ULS-Set(17)

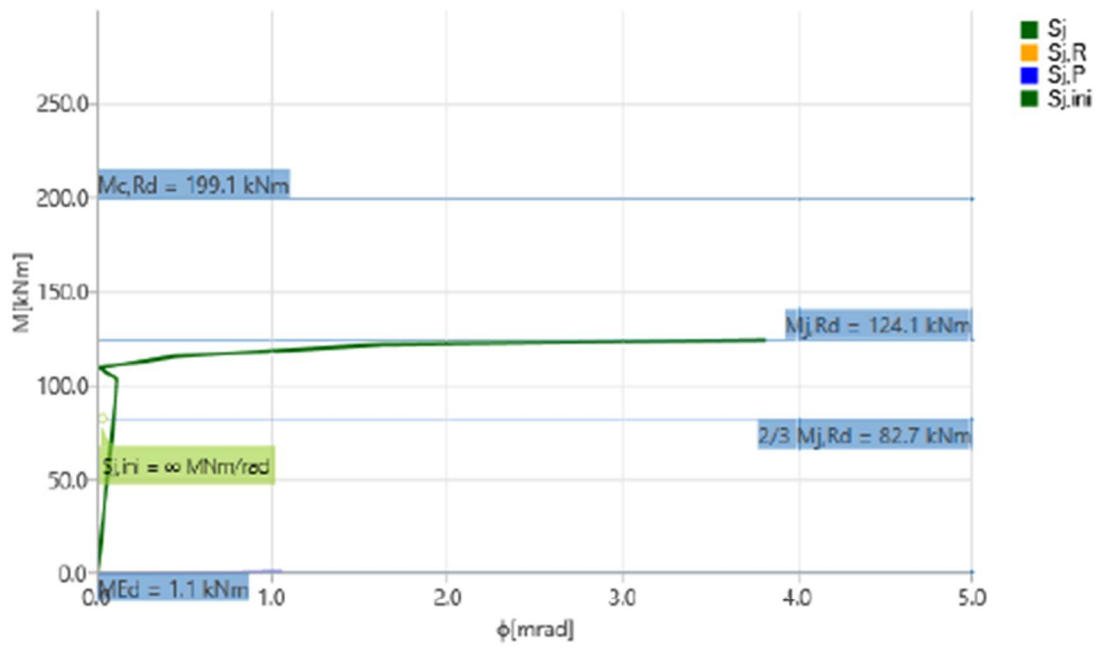

Stiffness diagram $M_z - \phi_z$, ULS-Set(19)

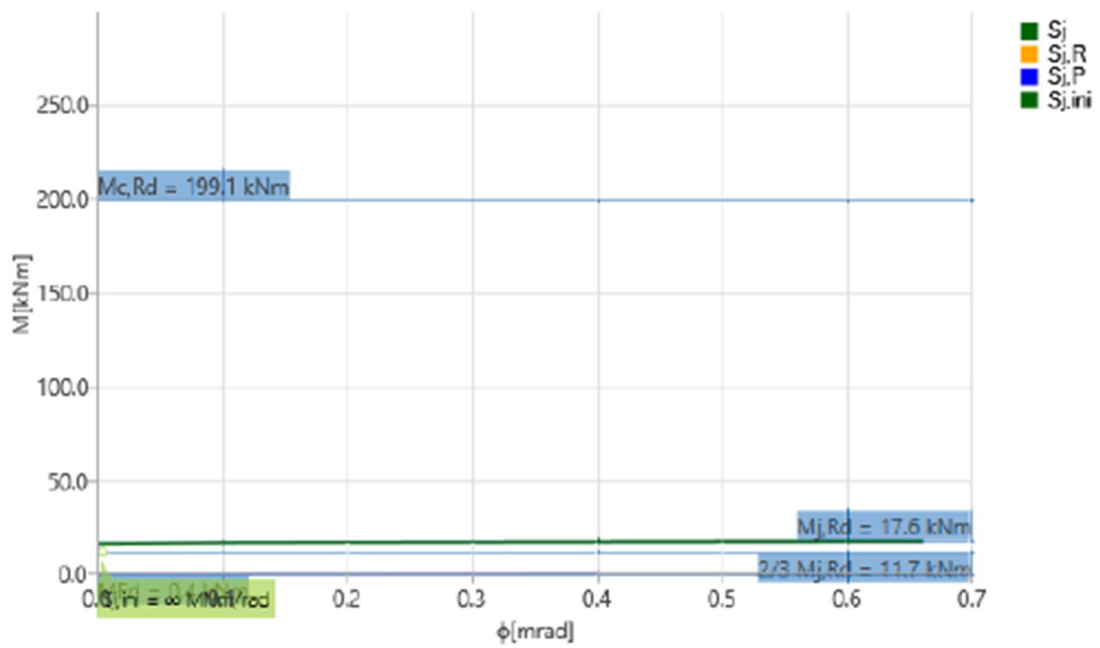

Stiffness diagram $M_z - \phi_z$, ULS-Set(21)

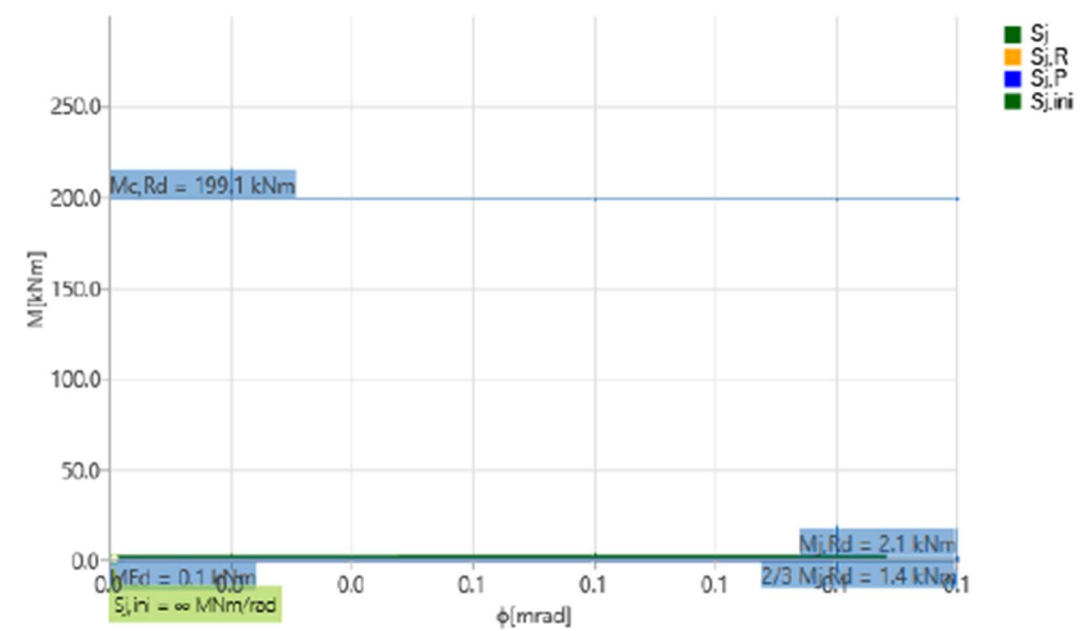
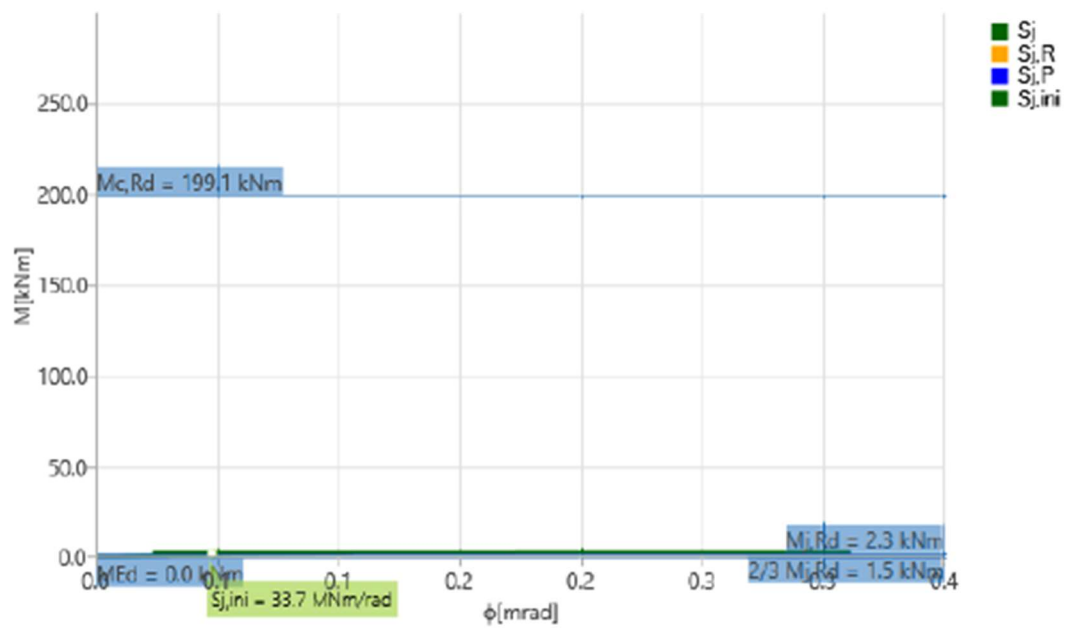

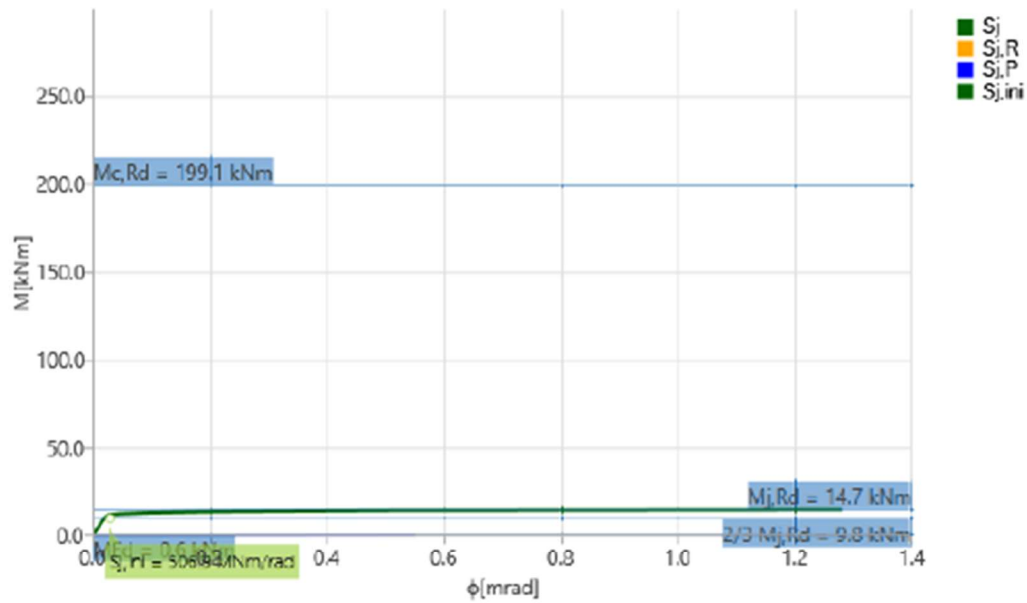
Stiffness diagram $M_z - \phi_z$, ULS-Set(35)**Axial stiffness**

Name	Component	Loads	N [kN]	$N_{j,Rd}$ [kN]	dx [mm]	S_t [MN/m]
B5618	N	ULS-Set(1)	-34.2	-41.5	0	36269189
		ULS-Set(2)	35.6	28.0	0	33804775
		ULS-Set(13)	-21.5	-13.7	0	20424816
		ULS-Set(14)	24.9	49.1	0	23608170
		ULS-Set(15)	-32.5	-79.2	0	1591
		ULS-Set(17)	32.7	42.5	0	31008244
		ULS-Set(19)	30.3	51.6	0	28739885
		ULS-Set(21)	34.4	44.9	0	32627689
		ULS-Set(25)	-30.8	-74.5	0	32616090
		ULS-Set(33)	32.1	38.6	0	30430048
		ULS-Set(35)	-33.1	-62.6	0	35069647

Symbol explanation

$N_{j,Rd}$	Tension (compression) resistance
S_t	Secant axial stiffness
δ	Longitudinal deformation

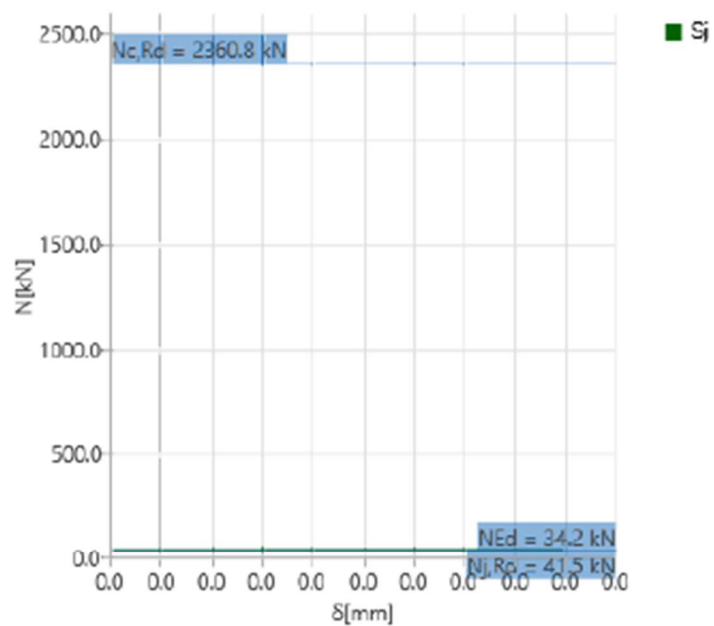

Stiffness diagram N - δ , ULS-Set(1)

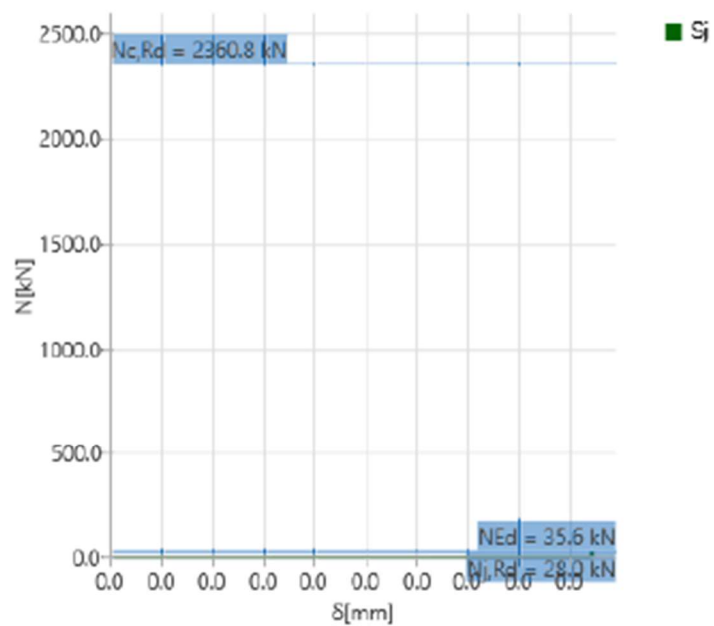

Stiffness diagram N - δ , ULS-Set(2)

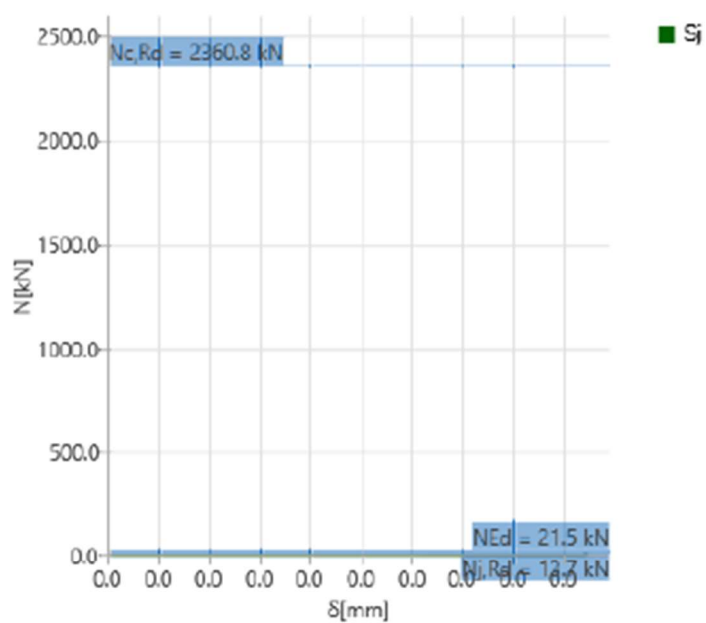
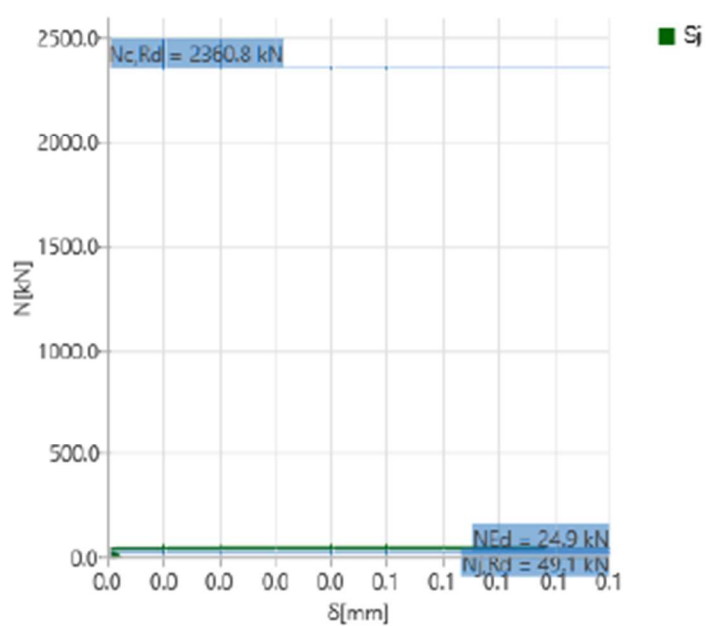
Stiffness diagram N - δ , ULS-Set(13)Stiffness diagram N - δ , ULS-Set(14)

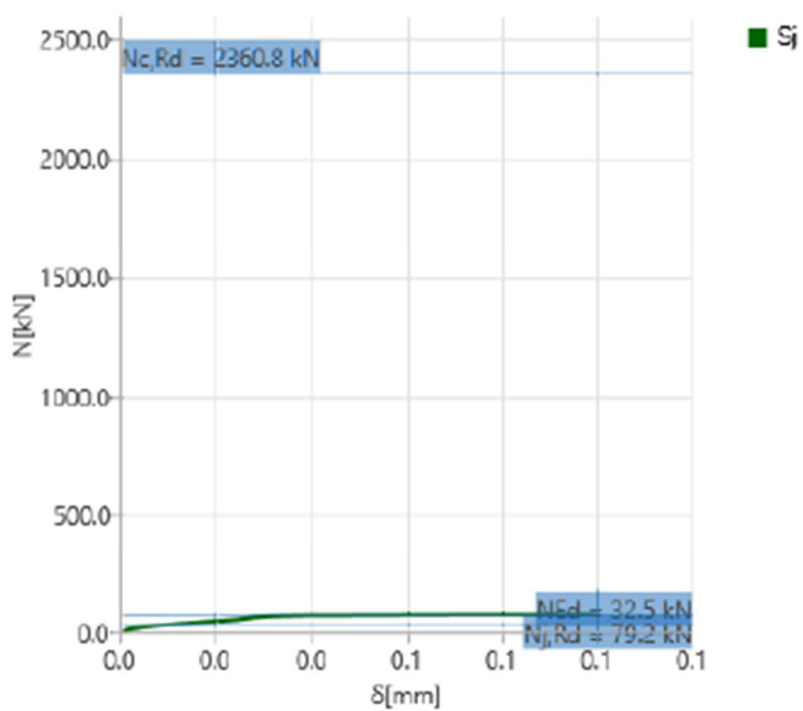

Stiffness diagram N - δ , ULS-Set(15)

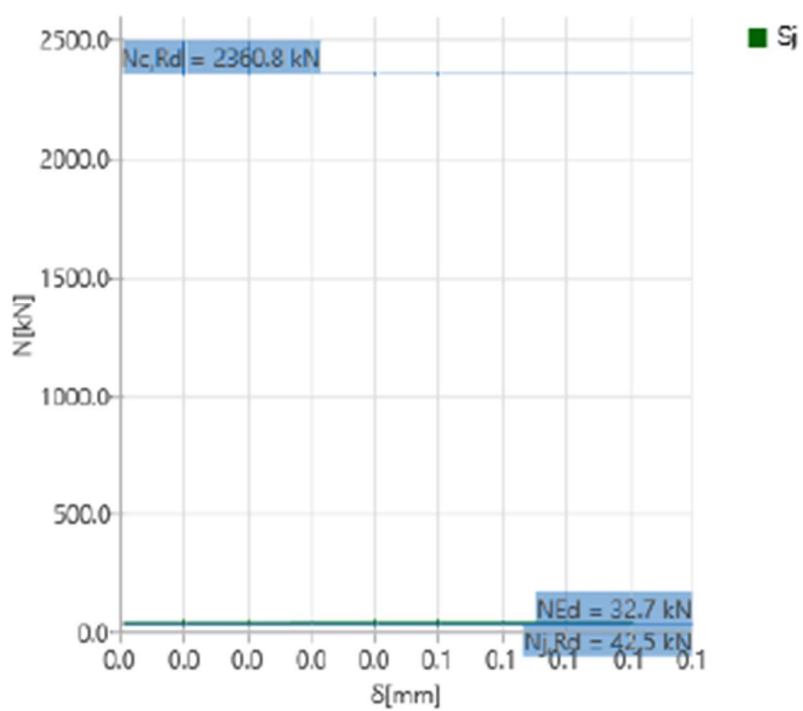

Stiffness diagram N - δ , ULS-Set(17)

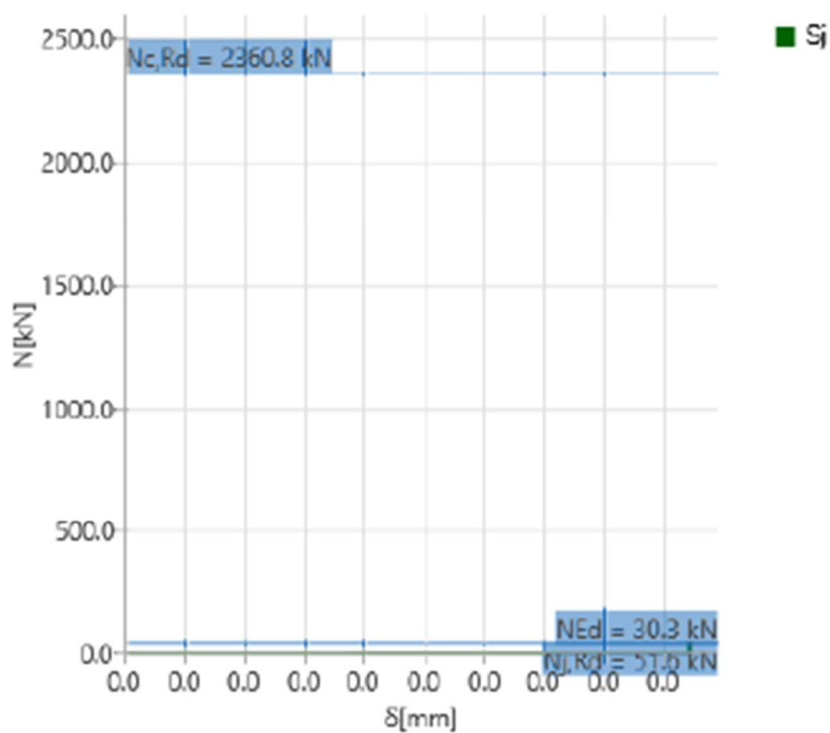
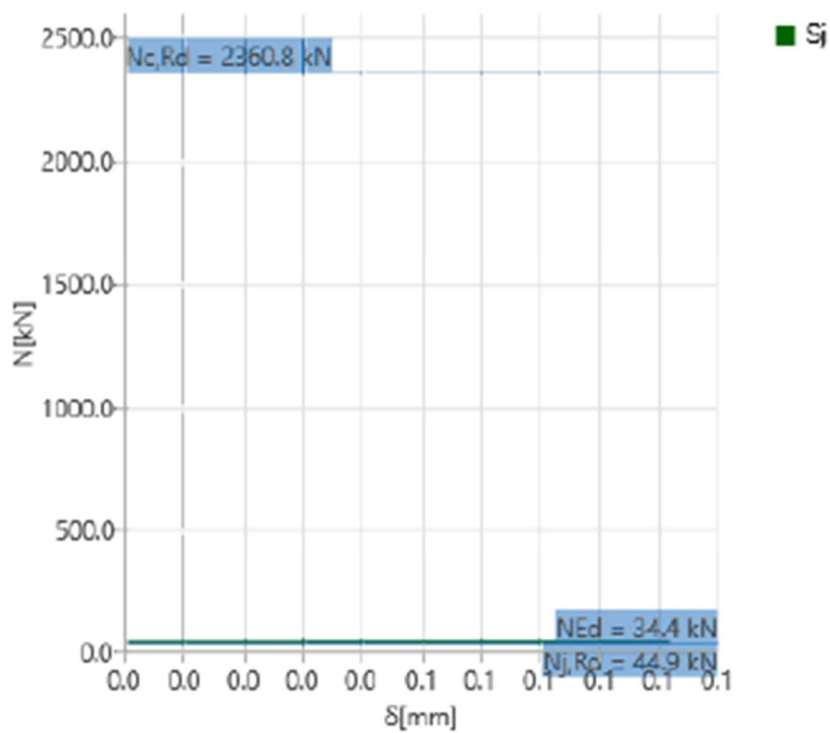
Stiffness diagram N - δ , ULS-Set(19)Stiffness diagram N - δ , ULS-Set(21)

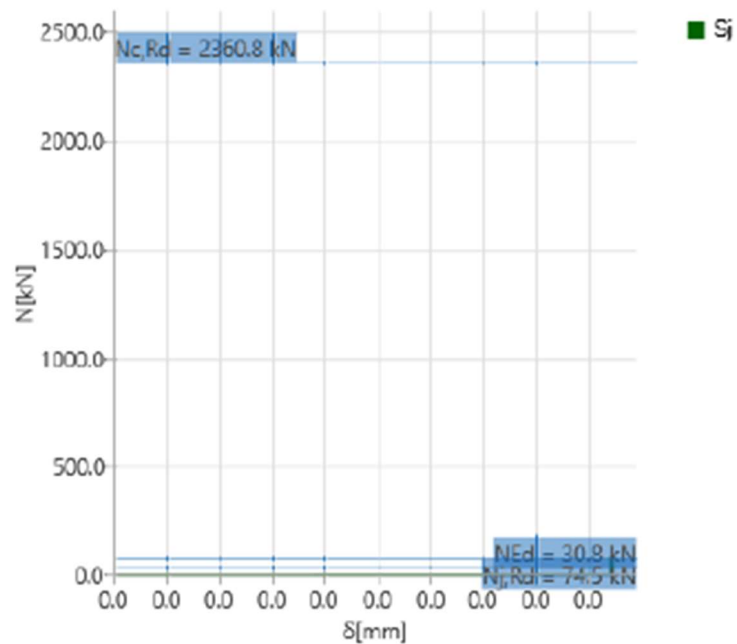
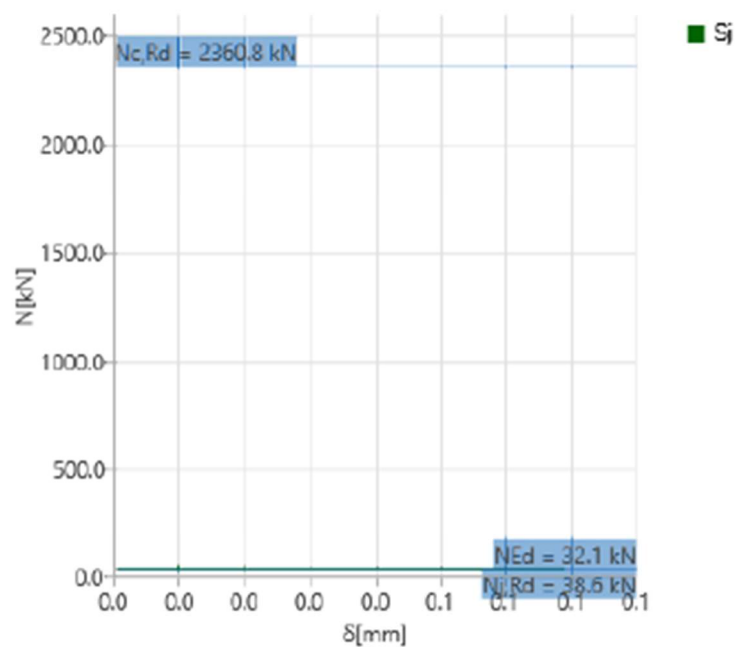
Stiffness diagram N - δ , ULS-Set(25)Stiffness diagram N - δ , ULS-Set(33)

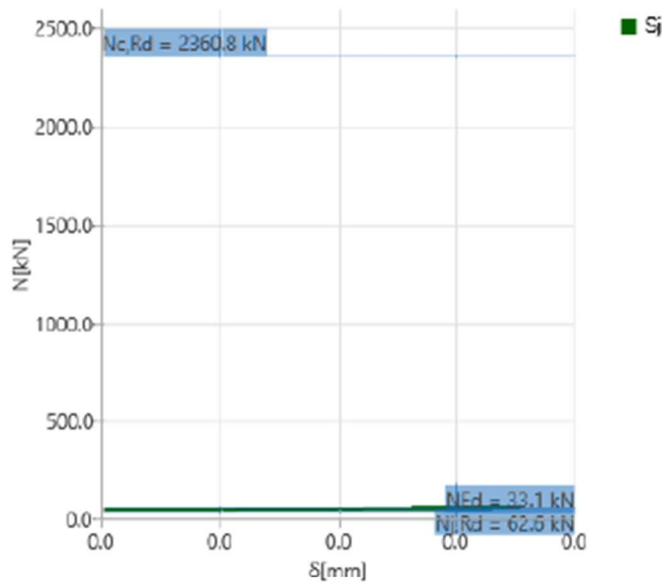
Stiffness diagram N - δ , ULS-Set(35)

Code settings

Item	Value	Unit	Reference
YM0	1.00	-	EN 1993-1-1: 6.1
YM1	1.00	-	EN 1993-1-1: 6.1
YM2	1.25	-	EN 1993-1-1: 6.1
YM3	1.25	-	EN 1993-1-8: 2.2
Yc	1.50	-	EN 1992-1-1: 2.4.2.4
Yinst	1.20	-	EN 1992-4: Table 4.1
Joint coefficient β_j	0.67	-	EN 1993-1-8: 6.2.5
Effective area - influence of mesh size	0.10	-	
Friction coefficient - concrete	0.25	-	EN 1993-1-8
Friction coefficient in slip-resistance	0.30	-	EN 1993-1-8 tab 3.7
Limit plastic strain	0.05	-	EN 1993-1-5
Weld stress evaluation	Plastic redistribution		
Detailing	No		
Distance between bolts [d]	2.20	-	EN 1993-1-8: tab 3.3
Distance between bolts and edge [d]	1.20	-	EN 1993-1-8: tab 3.3
Concrete breakout resistance check	Both		EN 1992-4: 7.2.1.4 and 7.2.2.5
Use calculated a_b in bearing check.	Yes		EN 1993-1-8: tab 3.4
Cracked concrete	Yes		EN 1992-4
Local deformation check	No		CIDECT DG 1, 3 - 1.1
Local deformation limit	0.03	-	CIDECT DG 1, 3 - 1.1

Item	Value	Unit	Reference
Geometrical nonlinearity (GMNA)	Yes		Analysis with large deformations for hollow section joints
Braced system	No		EN 1993-1-8: 5.2.2.5

5.8. Karakteristični spoj pokrova i kosog dijela stupa „S1“

Design

Name	Con N5697
Description	
Analysis	Stress, strain/ loads in equilibrium

Beams and columns

Name	Cross-section	β - Direction [°]	γ - Pitch [°]	α - Rotation [°]	Offset ex [mm]	Offset ey [mm]	Offset ez [mm]	Forces in
B5536	1 - Massive O Hollow(CHS273,8)	0.0	0.0	0.0	0	0	0	Position
B5537	1 - Massive O Hollow(CHS273,8)	0.0	0.0	60.0	-120	50	-150	Position
B5544	1 - Massive O Hollow(CHS273,8)	0.0	0.0	0.0	0	0	0	Position
B5722	2 - CHS(cf)219.1/12.5	0.0	0.0	0.0	-325	-180	150	Position

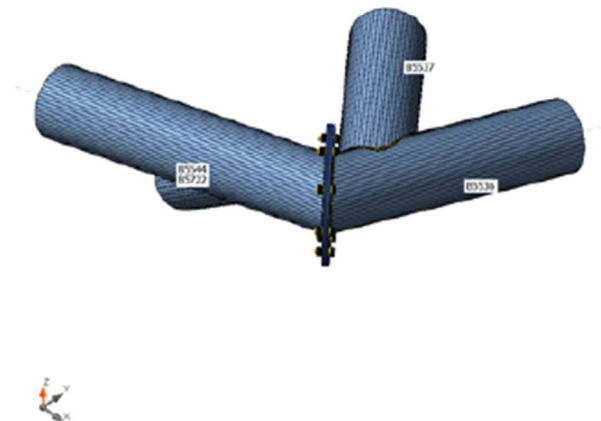

Cross-sections

Name	Material
1 - Massive O Hollow(CHS273,8)	S 355
2 - CHS(cf)219.1/12.5	S 355

Bolts

Name	Bolt assembly	Diameter [mm]	f_u [MPa]	Gross area [mm ²]
M20 8.8	M20 8.8	20	800.0	314

Load effects (forces in equilibrium)

Name	Member	N [kN]	Vy [kN]	Vz [kN]	Mx [kNm]	My [kNm]	Mz [kNm]
ULS-Set(1)	B5536	109.7	1.8	-15.9	-5.3	4.6	6.8
	B5537	68.3	-0.1	-20.2	2.2	-23.4	-0.4
	B5544	149.4	-1.0	-3.7	-1.5	1.3	-6.6
	B5722	118.8	0.5	4.9	6.0	25.8	-8.0
ULS-Set(6)	B5536	106.0	1.7	-15.0	-5.3	4.3	6.4
	B5537	67.6	-0.1	-19.0	2.1	-22.6	-0.4
	B5544	142.9	-1.0	-2.9	-1.6	0.7	-6.2
	B5722	111.7	0.5	5.1	5.8	24.6	-7.7
ULS-Set(9)	B5536	98.8	1.7	-12.1	-4.2	5.6	5.9
	B5537	65.9	0.0	-14.6	1.6	-16.5	-0.5
	B5544	131.5	-0.8	-3.1	-1.3	1.8	-5.3
	B5722	97.8	0.5	3.6	4.9	19.4	-6.9
ULS-Set(10)	B5536	102.4	1.7	-13.0	-4.2	5.9	6.3
	B5537	66.6	0.0	-15.8	1.7	-17.3	-0.5
	B5544	138.0	-0.9	-3.9	-1.3	2.4	-5.6
	B5722	104.9	0.6	3.4	5.1	20.5	-7.2
ULS-Set(12)	B5536	107.1	1.8	-15.7	-4.8	5.1	6.9
	B5537	65.8	-0.1	-19.8	2.0	-22.6	-0.3
	B5544	147.1	-1.0	-4.7	-1.4	2.5	-6.5
	B5722	118.3	0.6	4.7	5.9	25.6	-8.0
ULS-Set(27)	B5536	62.4	0.9	-13.5	-4.1	-0.1	4.3
	B5537	30.4	-0.1	-18.5	1.9	-22.8	0.1
	B5544	90.8	-0.8	-2.8	-0.9	-0.4	-5.0
	B5722	85.6	0.2	4.6	4.4	22.8	-5.3
ULS-Set(31)	B5536	63.5	1.0	-14.2	-3.6	0.7	4.8
	B5537	28.7	-0.1	-19.3	1.8	-22.8	0.3
	B5544	94.9	-0.9	-4.6	-0.7	1.4	-5.3
	B5722	92.2	0.4	4.3	4.5	23.8	-5.7
ULS-Set(42)	B5536	71.6	0.9	-8.0	-1.8	5.9	4.5
	B5537	46.6	0.4	-9.0	0.8	-7.9	-0.7
	B5544	98.4	-0.4	-4.1	-0.7	3.4	-3.0
	B5722	73.1	0.7	0.7	3.2	11.3	-5.1
ULS-Set(46)	B5536	70.8	1.5	-10.4	-2.7	4.5	5.9
	B5537	43.2	0.2	-13.0	1.2	-14.1	0.0
	B5544	100.5	-1.2	-4.8	-0.6	3.4	-4.9
	B5722	82.2	1.0	2.5	3.5	17.1	-6.0
ULS-Set(47)	B5536	86.8	1.4	-11.8	-4.2	3.6	5.1
	B5537	56.0	0.0	-14.9	1.7	-17.4	-0.4
	B5544	116.5	-0.8	-2.1	-1.3	0.3	-5.0
	B5722	89.7	0.4	3.6	4.7	18.9	-6.1

Check

Summary

Name	Value	Status
Analysis	100.0%	OK
Plates	0.7 < 5.0%	OK
Bolts	88.6 < 100%	OK
Welds	98.3 < 100%	OK
Buckling	Not calculated	
GMNA	Calculated	

Plates

Name	Thickness [mm]	Loads	σ_{Ed} [MPa]	ϵ_{pl} [%]	σ_{cEd} [MPa]	Status
B5536	8.0	ULS-Set(1)	253.0	0.0	0.0	OK
B5537	8.0	ULS-Set(1)	183.3	0.0	0.0	OK
B5544	8.0	ULS-Set(1)	356.4	0.7	0.0	OK
B5722	12.5	ULS-Set(1)	326.3	0.0	0.0	OK
PP1a	12.0	ULS-Set(1)	355.2	0.1	50.4	OK
PP1b	12.0	ULS-Set(1)	355.2	0.1	50.4	OK

Design data

Material	f_y [MPa]	ϵ_{lim} [%]
S 355	355.0	5.0

Symbol explanation

ϵ_{pl}	Strain
σ_{Ed}	Eq. stress
σ_{cEd}	Contact stress
f_y	Yield strength
ϵ_{lim}	Limit of plastic strain

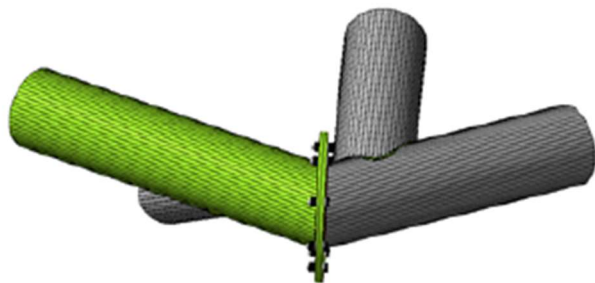

Overall check, ULS-Set(1)

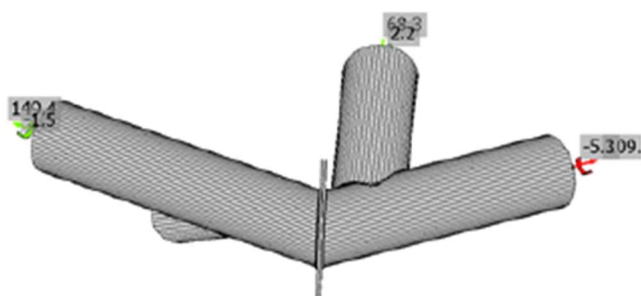

Strain check, ULS-Set(1)

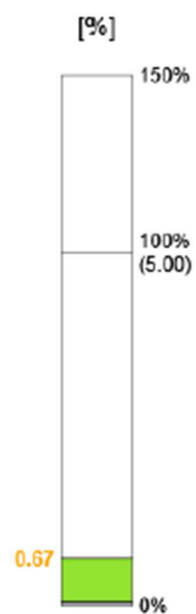

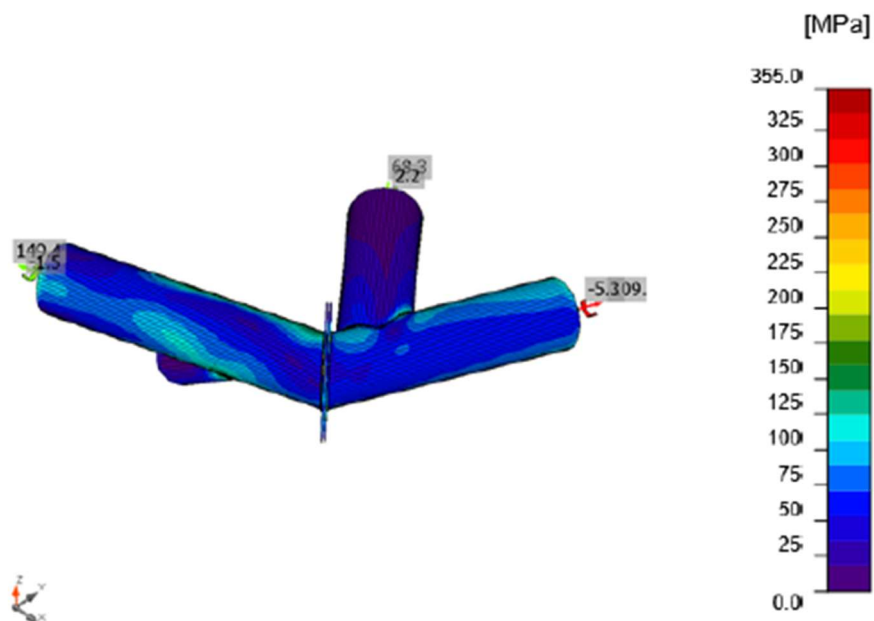

Equivalent stress, ULS-Set(1)

Bolts

	Name	Loads	$F_{t,Ed}$ [kN]	V [kN]	U_{t1} [%]	$F_{b,Rd}$ [kN]	U_{t8} [%]	U_{t18} [%]	Status
	B1	ULS-Set(1)	80.3	31.8	56.9	235.2	33.8	74.4	OK
	B2	ULS-Set(1)	0.0	29.2	0.0	235.2	31.1	31.1	OK
	B3	ULS-Set(1)	0.5	24.9	0.4	235.2	26.5	26.8	OK
	B4	ULS-Set(1)	5.4	19.9	3.8	235.2	21.2	23.9	OK
	B5	ULS-Set(1)	35.0	17.2	24.8	235.2	18.3	36.0	OK
	B6	ULS-Set(1)	34.4	20.7	24.3	235.2	22.0	39.4	OK
	B7	ULS-Set(1)	46.7	27.0	33.1	235.2	28.7	52.3	OK
	B8	ULS-Set(1)	107.7	30.2	76.3	235.2	32.1	86.6	OK

Design data

Name	$F_{t,Rd}$ [kN]	$B_{p,Rd}$ [kN]	$F_{v,Rd}$ [kN]
M20 8.8 - 1	141.1	279.3	94.1

Symbol explanation

$F_{t,Rd}$	Bolt tension resistance EN 1993-1-8 tab. 3.4
$F_{t,Ed}$	Tension force
$B_{p,Rd}$	Punching shear resistance
V	Resultant of shear forces V_y, V_z in bolt
$F_{v,Rd}$	Bolt shear resistance EN 1993-1-8 table 3.4
$F_{b,Rd}$	Plate bearing resistance EN 1993-1-8 tab. 3.4
U_t	Utilization in tension
U_s	Utilization in shear

Welds (Plastic redistribution)

Item	Edge	Throat th. [mm]	Length [mm]	Loads	$\sigma_{w,Ed}$ [MPa]	ϵ_{pl} [%]	σ_{\perp} [MPa]	τ_{\parallel} [MPa]	τ_{\perp} [MPa]	U_t [%]	U_c [%]	Status
PP1a	B5536	▲4.0	934	ULS-Set(1)	428.2	0.8	191.2	-149.7	-162.9	98.3	37.1	OK
PP1b	B5544	▲4.0	934	ULS-Set(1)	428.2	0.8	185.5	-97.6	-200.3	98.3	38.6	OK
B5536-arc 52	B5537	▲3.0▲	967	ULS-Set(1)	388.7	0.0	7.6	-104.8	-185.2	84.6	17.1	OK
B5544-arc 39	B5722	▲6.0	803	ULS-Set(1)	427.0	0.1	-158.1	141.2	-180.3	98.0	43.9	OK
		▲3.0▲	967	ULS-Set(1)	169.8	0.0	-126.7	-32.3	56.7	39.0	16.4	OK

Design data

	β_w [-]	$\sigma_{w,Rd}$ [MPa]	0.9σ [MPa]
S 355	0.90	435.6	352.8

Symbol explanation

ϵ_{pl}	Strain
$\sigma_{w,Ed}$	Equivalent stress
$\sigma_{w,Rd}$	Equivalent stress resistance
σ_{\perp}	Perpendicular stress
τ_{\parallel}	Shear stress parallel to weld axis
τ_{\perp}	Shear stress perpendicular to weld axis
0.9σ	Perpendicular stress resistance - $0.9 \cdot f_u / \gamma_{M2}$
β_w	Correlation factor EN 1993-1-8 tab. 4.1
U_t	Utilization
U_c	Weld capacity utilization

Buckling

Buckling analysis was not calculated.

Code settings

Item	Value	Unit	Reference
YM0	1.00	-	EN 1993-1-1: 6.1
YM1	1.00	-	EN 1993-1-1: 6.1
YM2	1.25	-	EN 1993-1-1: 6.1

Item	Value	Unit	Reference
Y _{M3}	1.25	-	EN 1993-1-8: 2.2
Y _c	1.50	-	EN 1992-1-1: 2.4.2.4
Y _{inst}	1.20	-	EN 1992-4: Table 4.1
Joint coefficient β _j	0.67	-	EN 1993-1-8: 6.2.5
Effective area - influence of mesh size	0.10	-	
Friction coefficient - concrete	0.25	-	EN 1993-1-8
Friction coefficient in slip-resistance	0.30	-	EN 1993-1-8 tab 3.7
Limit plastic strain	0.05	-	EN 1993-1-5
Weld stress evaluation	Plastic redistribution		
Detailing	No		
Distance between bolts [d]	2.20	-	EN 1993-1-8: tab 3.3
Distance between bolts and edge [d]	1.20	-	EN 1993-1-8: tab 3.3
Concrete breakout resistance check	Both		EN 1992-4: 7.2.1.4 and 7.2.2.5
Use calculated a _b in bearing check.	Yes		EN 1993-1-8: tab 3.4
Cracked concrete	Yes		EN 1992-4
Local deformation check	No		CIDECT DG 1, 3 - 1.1
Local deformation limit	0.03	-	CIDECT DG 1, 3 - 1.1
Geometrical nonlinearity (GMNA)	Yes		Analysis with large deformations for hollow section joints
Braaced system	No		EN 1993-1-8: 5.2.2.5

5.9. Vlačni spoj rubnog stupa „S2“

Project item Con N5944

Design

Name	Con N5944
Description	
Analysis	Stress, strain/ loads in equilibrium

Beams and columns

Name	Cross-section	β - Direction [°]	γ - Pitch [°]	α - Rotation [°]	Offset ex [mm]	Offset ey [mm]	Offset ez [mm]	Forces in
B6256	1 - CHS(cf)355.6/8.0	0.0	0.0	0.0	0	0	0	Position
B6257	1 - CHS(cf)355.6/8.0	0.0	0.0	0.0	0	0	0	Position

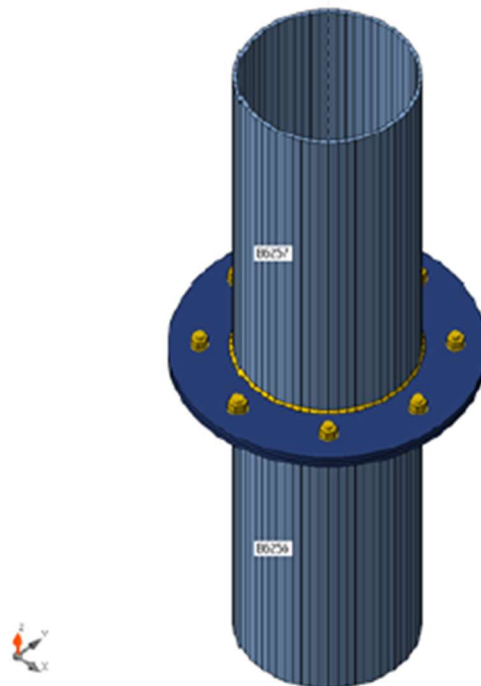

Cross-sections

Name	Material
1 - CHS(cf)355.6/8.0	S 355

Bolts

Name	Bolt assembly	Diameter [mm]	f_u [MPa]	Gross area [mm ²]
M20 8.8	M20 8.8	20	800.0	314

Load effects (forces in equilibrium)

Name	Member	N [kN]	Vy [kN]	Vz [kN]	Mx [kNm]	My [kNm]	Mz [kNm]
ULS-Set(2)	B6256	302.9	0.0	1.3	-0.7	-5.3	-3.5
	B6257	-302.9	0.0	-1.3	0.7	5.3	3.5
ULS-Set(27)	B6256	301.8	0.1	1.4	-1.0	-5.4	-3.1
	B6257	-301.8	-0.1	-1.4	1.0	5.4	3.1
ULS-Set(30)	B6256	299.4	0.1	1.0	-0.1	-4.8	-3.5
	B6257	-299.4	-0.1	-1.0	0.1	4.8	3.5

Check

Summary

Name	Value	Status
Analysis	100.0%	OK
Plates	0.0 < 5.0%	OK
Bolts	0.8 < 100%	OK
Welds	27.9 < 100%	OK
Buckling	Not calculated	
GMNA	Calculated	

Plates

Name	Thickness [mm]	Loads	σ_{Ed} [MPa]	ϵ_{pl} [%]	σ_{cEd} [MPa]	Status
B6256	8.0	ULS-Set(2)	50.8	0.0	0.0	OK
B6257	8.0	ULS-Set(2)	48.2	0.0	0.0	OK
PP1a	12.0	ULS-Set(27)	2.9	0.0	4.0	OK
PP1b	12.0	ULS-Set(27)	2.8	0.0	4.0	OK

Design data

Material	f_y [MPa]	ϵ_{lim} [%]
S 355	355.0	5.0

Symbol explanation

ϵ_{pl}	Strain
σ_{Ed}	Eq. stress
σ_{cEd}	Contact stress
f_y	Yield strength
ϵ_{lim}	Limit of plastic strain

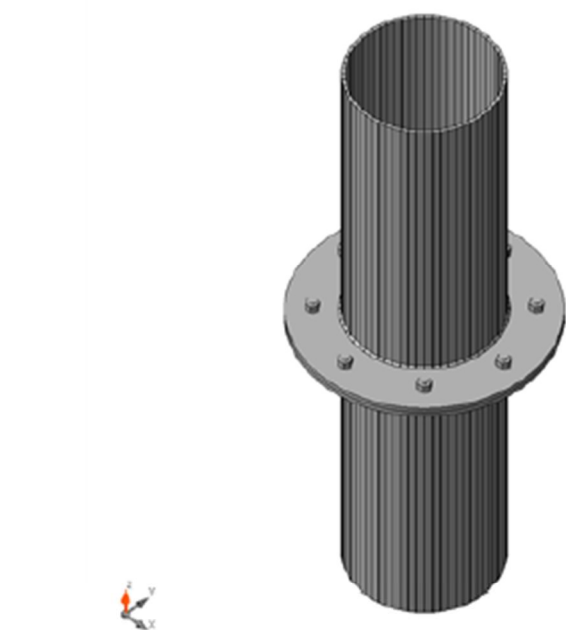

Overall check, ULS-Set(2)

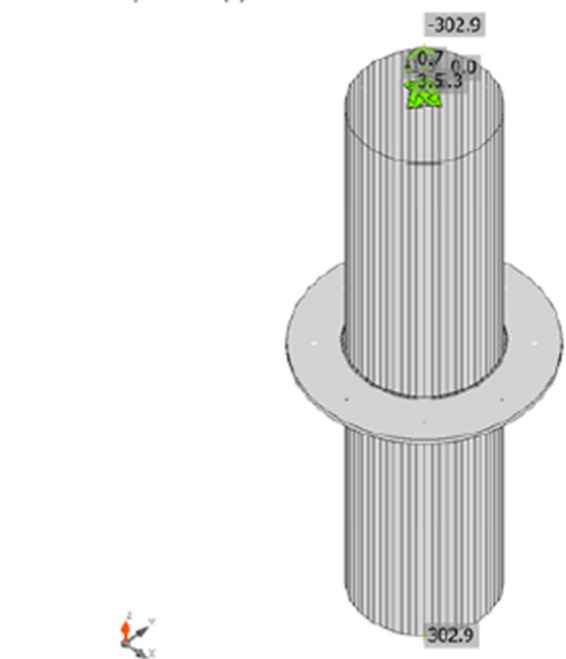

Strain check, ULS-Set(2)



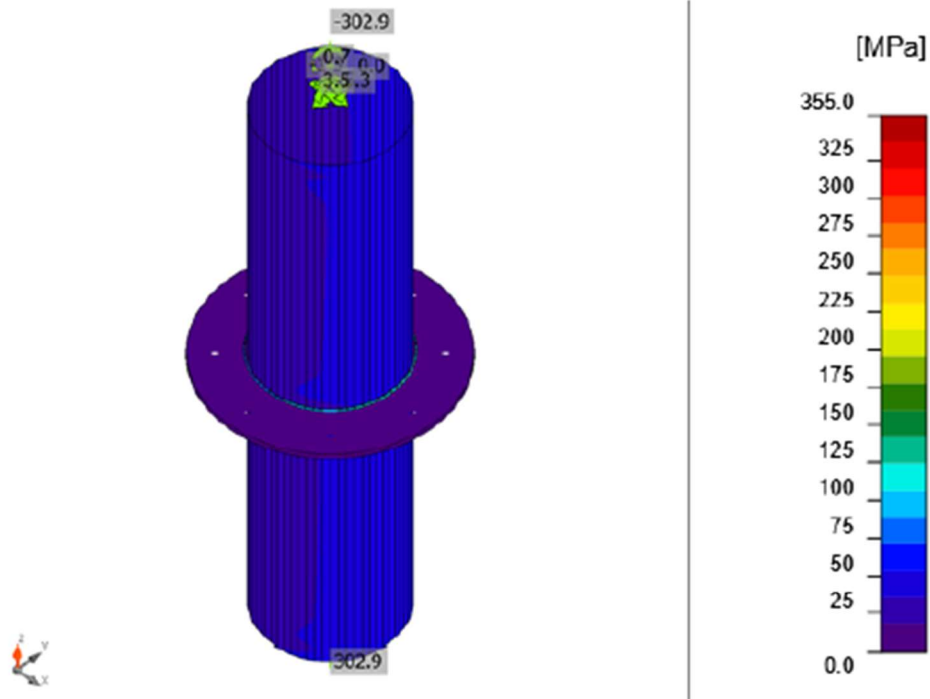

Equivalent stress, ULS-Set(2)

Bolts

	Name	Loads	$F_{t,Ed}$ [kN]	V [kN]	U_{t1} [%]	$F_{b,Rd}$ [kN]	U_{t2} [%]	U_{t3} [%]	Status
	B1	ULS-Set(27)	0.1	0.4	0.1	235.2	0.4	0.4	OK
	B2	ULS-Set(27)	0.1	0.4	0.1	235.2	0.5	0.5	OK
	B3	ULS-Set(27)	0.1	0.6	0.0	235.2	0.6	0.7	OK
	B4	ULS-Set(27)	0.1	0.7	0.0	235.2	0.7	0.8	OK
	B5	ULS-Set(27)	0.1	0.7	0.1	235.2	0.8	0.8	OK
	B6	ULS-Set(27)	0.1	0.7	0.1	235.2	0.7	0.8	OK
	B7	ULS-Set(27)	0.1	0.6	0.1	235.2	0.6	0.6	OK
	B8	ULS-Set(27)	0.1	0.4	0.1	235.2	0.4	0.5	OK

Design data

Name	$F_{t,Rd}$ [kN]	$B_{p,Rd}$ [kN]	$F_{v,Rd}$ [kN]
M20 8.8 - 1	141.1	279.3	94.1

Symbol explanation

$F_{t,Rd}$	Bolt tension resistance EN 1993-1-8 tab. 3.4
$F_{t,Ed}$	Tension force
$B_{p,Rd}$	Punching shear resistance
V	Resultant of shear forces V_y, V_z in bolt
$F_{v,Rd}$	Bolt shear resistance EN_1993-1-8 table 3.4
$F_{b,Rd}$	Plate bearing resistance EN 1993-1-8 tab. 3.4
U_t	Utilization in tension
U_s	Utilization in shear

Welds (Plastic redistribution)

Item	Edge	Throat th. [mm]	Length [mm]	Loads	$\sigma_{w,Ed}$ [MPa]	ϵ_{pl} [%]	σ_{\perp} [MPa]	τ_{\parallel} [MPa]	τ_{\perp} [MPa]	U_t [%]	U_{tc} [%]	Status
PP1a	B6256	▲4.0	1092	ULS-Set(2)	121.7	0.0	-63.6	0.2	59.9	27.9	22.2	OK
PP1b	B6257	▲4.0	1092	ULS-Set(2)	121.5	0.0	-63.5	1.1	59.8	27.9	22.2	OK

Design data

	β_w [-]	$\sigma_{w,Rd}$ [MPa]	0.9σ [MPa]
S 355	0.90	435.6	352.8

Symbol explanation

ϵ_{pl}	Strain
$\sigma_{w,Ed}$	Equivalent stress
$\sigma_{w,Rd}$	Equivalent stress resistance
σ_{\perp}	Perpendicular stress
τ_{\parallel}	Shear stress parallel to weld axis
τ_{\perp}	Shear stress perpendicular to weld axis
0.9σ	Perpendicular stress resistance - $0.9 \cdot f_u / \gamma_{M2}$
β_w	Corelation factor EN 1993-1-8 tab. 4.1
U_t	Utilization
U_{tc}	Weld capacity utilization

Buckling

Buckling analysis was not calculated.

Code settings

Item	Value	Unit	Reference
YM0	1.00	-	EN 1993-1-1: 6.1
YM1	1.00	-	EN 1993-1-1: 6.1
YM2	1.25	-	EN 1993-1-1: 6.1
YM3	1.25	-	EN 1993-1-8: 2.2
YC	1.50	-	EN 1992-1-1: 2.4.2.4
Yinst	1.20	-	EN 1992-4: Table 4.1

Item	Value	Unit	Reference
Joint coefficient β_j	0.67	-	EN 1993-1-8: 6.2.5
Effective area - influence of mesh size	0.10	-	
Friction coefficient - concrete	0.25	-	EN 1993-1-8
Friction coefficient in slip-resistance	0.30	-	EN 1993-1-8 tab 3.7
Limit plastic strain	0.05	-	EN 1993-1-5
Weld stress evaluation	Plastic redistribution		
Detailing	No		
Distance between bolts [d]	2.20	-	EN 1993-1-8: tab 3.3
Distance between bolts and edge [d]	1.20	-	EN 1993-1-8: tab 3.3
Concrete breakout resistance check	Both		EN 1992-4: 7.2.1.4 and 7.2.2.5
Use calculated a_b in bearing check.	Yes		EN 1993-1-8: tab 3.4
Cracked concrete	Yes		EN 1992-4
Local deformation check	No		CIDECT DG 1, 3 - 1.1
Local deformation limit	0.03	-	CIDECT DG 1, 3 - 1.1
Geometrical nonlinearity (GMNA)	Yes		Analysis with large deformations for hollow section joints
Braced system	No		EN 1993-1-8: 5.2.2.5

5.10. Vlačni spoj trostrukog stupa „S1“

Project item Con N5943

Design

Name	Con N5943
Description	
Analysis	Stress, strain/ loads in equilibrium

Beams and columns

Name	Cross-section	β - Direction [°]	γ - Pitch [°]	α - Rotation [°]	Offset ex [mm]	Offset ey [mm]	Offset ez [mm]	Forces in
B6254	1 - CHS(cf)219.1/12.5	0.0	0.0	0.0	0	0	0	Position
B6255	1 - CHS(cf)219.1/12.5	0.0	0.0	0.0	0	0	0	Position

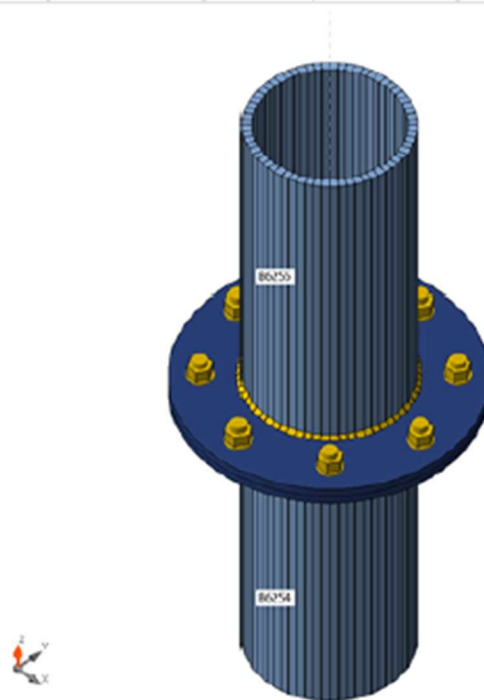

Cross-sections

Name	Material
1 - CHS(cf)219.1/12.5	S 355

Bolts

Name	Bolt assembly	Diameter [mm]	f_u [MPa]	Gross area [mm ²]
M20 8.8	M20 8.8	20	800.0	314

Load effects (forces in equilibrium)

Name	Member	N [kN]	Vy [kN]	Vz [kN]	Mx [kNm]	My [kNm]	Mz [kNm]
ULS-Set(2)	B6254	418.0	-7.5	-1.3	-2.3	-3.5	3.3
	B6255	-418.0	7.5	1.3	2.3	3.5	-3.3
ULS-Set(18)	B6254	413.6	-5.4	-1.4	-3.6	-3.5	4.0
	B6255	-413.6	5.4	1.4	3.6	3.5	-4.0
ULS-Set(21)	B6254	401.7	-5.1	-1.4	-3.2	-3.5	4.1
	B6255	-401.7	5.1	1.4	3.2	3.5	-4.1
ULS-Set(24)	B6254	406.1	-7.2	-1.2	-2.0	-3.6	3.4
	B6255	-406.1	7.2	1.2	2.0	3.6	-3.4

Check

Summary

Name	Value	Status
Analysis	100.0%	OK
Plates	0.0 < 5.0%	OK
Bolts	3.9 < 100%	OK
Welds	64.6 < 100%	OK
Buckling	Not calculated	
GMNA	Calculated	

Plates

Name	Thickness [mm]	Loads	σ_{Ed} [MPa]	ϵ_{pl} [%]	σ_{cEd} [MPa]	Status
B6254	12.5	ULS-Set(2)	70.4	0.0	0.0	OK
B6255	12.5	ULS-Set(2)	85.1	0.0	0.0	OK
PP1a	12.0	ULS-Set(18)	14.1	0.0	10.7	OK
PP1b	12.0	ULS-Set(18)	14.3	0.0	10.7	OK

Design data

Material	f_y [MPa]	ϵ_{lim} [%]
S 355	355.0	5.0

Symbol explanation

ϵ_{pl}	Strain
σ_{Ed}	Eq. stress
σ_{cEd}	Contact stress
f_y	Yield strength
ϵ_{lim}	Limit of plastic strain

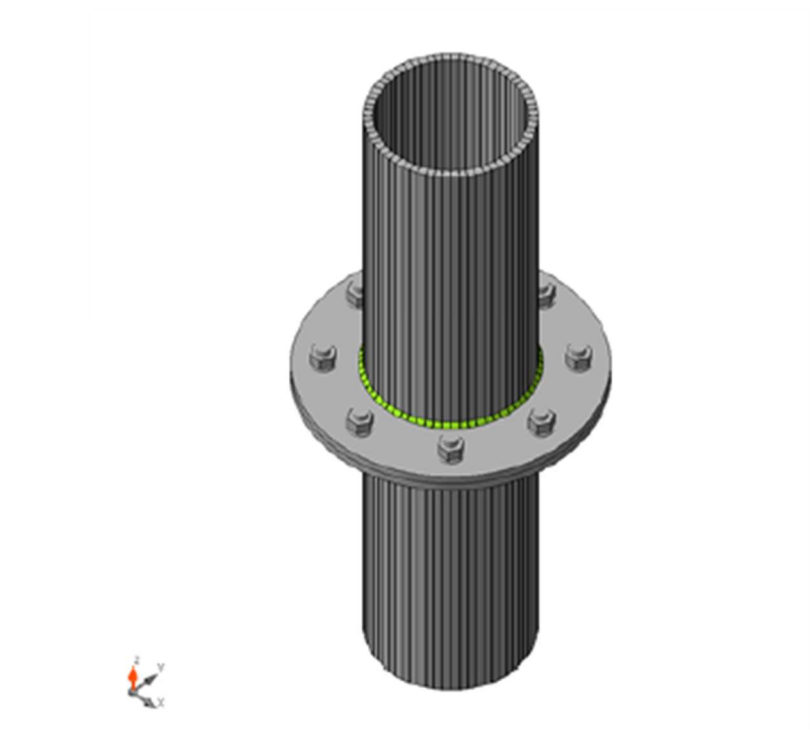

Overall check, ULS-Set(2)

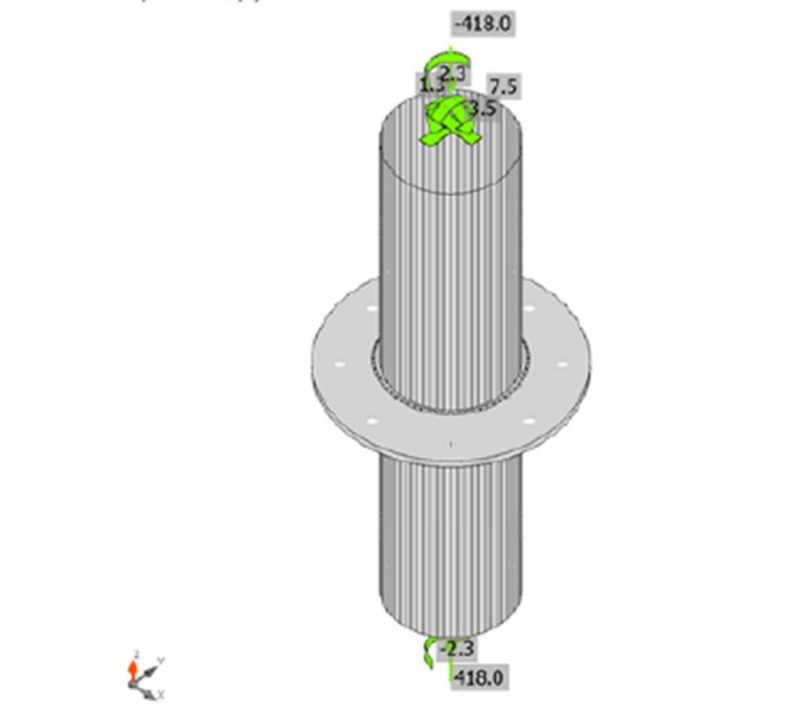

Strain check, ULS-Set(2)

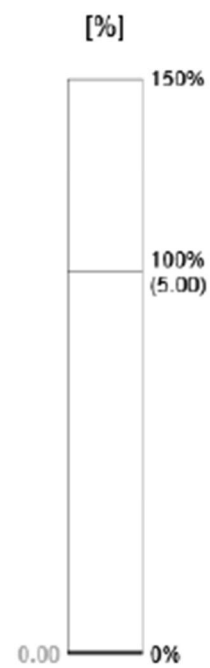

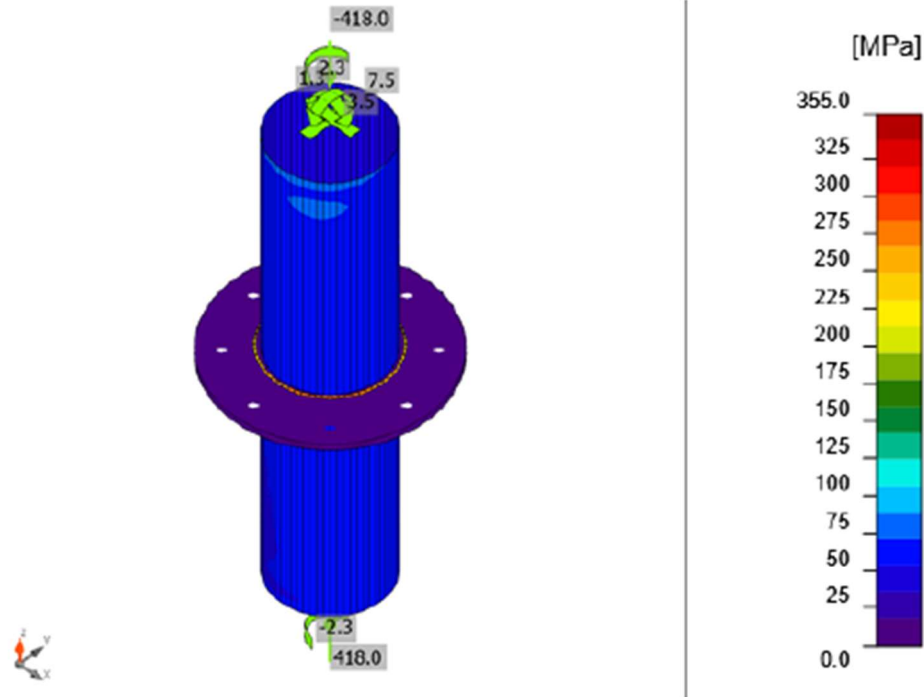

Equivalent stress, ULS-Set(2)

Bolts

	Name	Loads	$F_{t,Ed}$ [kN]	V [kN]	$U_{t,t}$ [%]	$F_{D,Rd}$ [kN]	$U_{t,s}$ [%]	$U_{t,t,s}$ [%]	Status
	B1	ULS-Set(18)	0.2	3.0	0.2	189.9	3.2	3.3	OK
	B2	ULS-Set(18)	0.2	2.5	0.1	187.4	2.6	2.7	OK
	B3	ULS-Set(18)	0.3	2.1	0.2	211.9	2.2	2.4	OK
	B4	ULS-Set(18)	0.3	2.2	0.2	198.6	2.3	2.5	OK
	B5	ULS-Set(18)	0.4	2.7	0.3	185.9	2.8	3.0	OK
	B6	ULS-Set(18)	0.3	3.2	0.2	194.4	3.4	3.6	OK
	B7	ULS-Set(18)	0.3	3.5	0.2	218.6	3.7	3.9	OK
	B8	ULS-Set(18)	0.3	3.4	0.2	208.5	3.6	3.8	OK

Design data

Name	$F_{t,Rd}$ [kN]	$B_{p,Rd}$ [kN]	$F_{v,Rd}$ [kN]
M20 8.8 - 1	141.1	279.3	94.1

Symbol explanation

$F_{t,Rd}$	Bolt tension resistance EN 1993-1-8 tab. 3.4
$F_{t,Ed}$	Tension force
$B_{p,Rd}$	Punching shear resistance
V	Resultant of shear forces V_y, V_z in bolt
$F_{v,Rd}$	Bolt shear resistance EN_1993-1-8 table 3.4
$F_{b,Rd}$	Plate bearing resistance EN 1993-1-8 tab. 3.4
U_t	Utilization in tension
U_s	Utilization in shear

Welds (Plastic redistribution)

Item	Edge	Throat th. [mm]	Length [mm]	Loads	$\sigma_{w,Ed}$ [MPa]	ϵ_{pl} [%]	σ_{\perp} [MPa]	τ_{\parallel} [MPa]	τ_{\perp} [MPa]	U_t [%]	U_c [%]	Status
PP1a	B6254	▲4.0	649	ULS-Set(18)	280.0	0.0	-147.9	17.9	136.1	64.3	51.0	OK
PP1b	B6255	▲4.0	649	ULS-Set(18)	281.4	0.0	-149.1	16.2	136.8	64.6	51.0	OK

Design data

	β_w [-]	$\sigma_{w,Rd}$ [MPa]	0.9σ [MPa]
S 355	0.90	435.6	352.8

Symbol explanation

ϵ_{pl}	Strain
$\sigma_{w,Ed}$	Equivalent stress
$\sigma_{w,Rd}$	Equivalent stress resistance
σ_{\perp}	Perpendicular stress
τ_{\parallel}	Shear stress parallel to weld axis
τ_{\perp}	Shear stress perpendicular to weld axis
0.9σ	Perpendicular stress resistance - $0.9 \cdot f_u / \gamma_{M2}$
β_w	Corelation factor EN 1993-1-8 tab. 4.1
U_t	Utilization
U_c	Weld capacity utilization

Buckling

Buckling analysis was not calculated.

Code settings

Item	Value	Unit	Reference
YM0	1.00	-	EN 1993-1-1: 6.1
YM1	1.00	-	EN 1993-1-1: 6.1
YM2	1.25	-	EN 1993-1-1: 6.1
YM3	1.25	-	EN 1993-1-8: 2.2
YC	1.50	-	EN 1992-1-1: 2.4.2.4
YInst	1.20	-	EN 1992-4: Table 4.1

Item	Value	Unit	Reference
Joint coefficient β_j	0.87	-	EN 1993-1-8: 6.2.5
Effective area - influence of mesh size	0.10	-	
Friction coefficient - concrete	0.25	-	EN 1993-1-8
Friction coefficient in slip-resistance	0.30	-	EN 1993-1-8 tab 3.7
Limit plastic strain	0.05	-	EN 1993-1-5
Weld stress evaluation	Plastic redistribution		
Detailing	No		
Distance between bolts [d]	2.20	-	EN 1993-1-8: tab 3.3
Distance between bolts and edge [d]	1.20	-	EN 1993-1-8: tab 3.3
Concrete breakout resistance check	Both		EN 1992-4: 7.2.1.4 and 7.2.2.5
Use calculated a_b in bearing check.	Yes		EN 1993-1-8: tab 3.4
Cracked concrete	Yes		EN 1992-4
Local deformation check	No		CIDECT DG 1, 3 - 1.1
Local deformation limit	0.03	-	CIDECT DG 1, 3 - 1.1
Geometrical nonlinearity (GMNA)	Yes		Analysis with large deformations for hollow section joints
Braced system	No		EN 1993-1-8: 5.2.2.5

6. AB MONOLITNI ELEMENTI KONSTRUKCIJE

6.1. AB temeljne stope

6.1.1. Temeljna stopa „TS1“

6.1.1.1. Reakcije na mjerodavnoj temeljnoj stopi

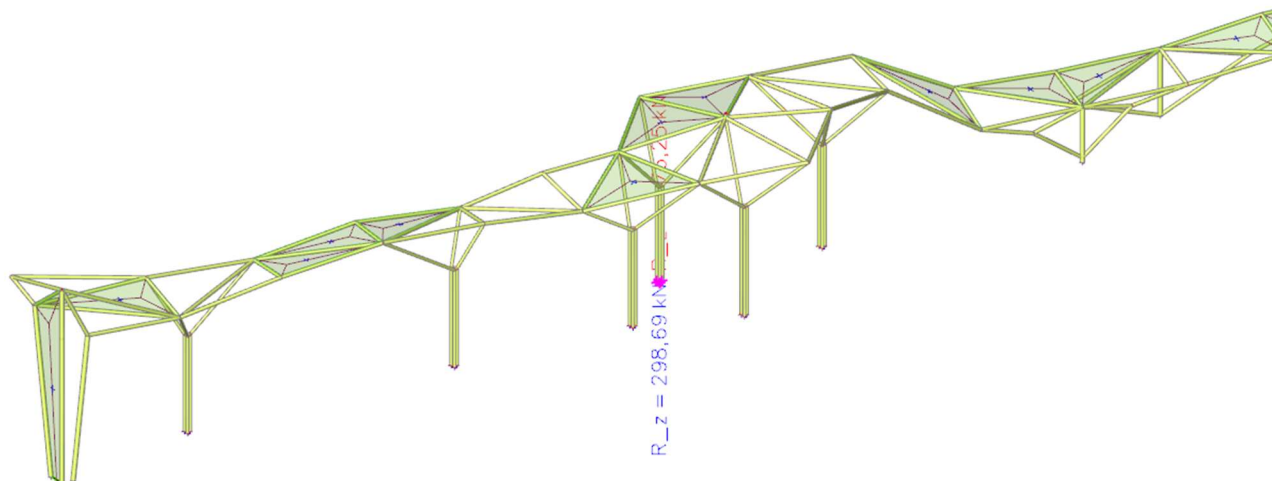

Slika 97: Mjerodavna reakcija za proračun temeljne stope „TS1“

Resultant of reactions

Linear calculation

Combination: ULS-Set B (auto)

Extreme: Global

Selection: Sn594..Sn596, N5761, N5763, N5765

System: Global

x [m]	y [m]	z [m]	Case	R _x [kN]	R _y [kN]	R _z [kN]	M _x [kNm]	M _y [kNm]	M _z [kNm]
-14,494	1626,820	0,000	ULS-Set B (auto)/1	-9,25	0,71	66,92	-7,41	-50,16	-2,03
-14,494	1626,820	0,000	ULS-Set B (auto)/2	4,83	-23,38	173,86	139,75	33,01	-7,00
-14,494	1626,820	0,000	ULS-Set B (auto)/3	1,86	1,49	-76,25	-13,14	15,40	4,12
-14,494	1626,820	0,000	ULS-Set B (auto)/4	-0,78	-10,15	298,69	65,77	-5,06	-12,89
-14,494	1626,820	0,000	ULS-Set B (auto)/5	-4,21	2,25	-59,61	-17,94	-26,57	4,22
-14,494	1626,820	0,000	ULS-Set B (auto)/6	-8,70	-0,28	78,10	-0,45	-51,36	-2,20
-14,494	1626,820	0,000	ULS-Set B (auto)/7	6,76	-9,30	220,27	59,39	47,54	-10,32
-14,494	1626,820	0,000	ULS-Set B (auto)/8	5,29	-11,20	277,49	71,91	37,34	-12,99

Name	Combination key
ULS-Set B (auto)/1	G + dg + 1.50*w1(x) + 0.90*T-
ULS-Set B (auto)/2	1.35*G + 1.35*dg + 0.75*s + 1.50*w2(y) + 0.90*T+
ULS-Set B (auto)/3	G + dg + 0.90*T+ + 1.50*w3(odizanje)
ULS-Set B (auto)/4	1.35*G + 1.35*dg + 0.75*s + 0.90*T- + 1.50*w3(pritisak)
ULS-Set B (auto)/5	G + dg + 0.90*T- + 1.50*w3(odizanje)
ULS-Set B (auto)/6	G + dg + 0.90*w1(x) + 1.50*T-
ULS-Set B (auto)/7	1.35*G + 1.35*dg + 0.75*s + 1.50*T+ + 0.90*w3(pritisak)
ULS-Set B (auto)/8	1.35*G + 1.35*dg + 1.50*s + 0.90*T+ + 0.90*w3(pritisak)

Tablica 9: Tablični prikaz reakcija na mjerodavnoj temeljnoj stopi „TS1“

6.1.1.2. Dimenzioniranje temelja pozicije „TS1“ – 220 x 220 x 100 cm

PRORAČUN TEMELJA SAMCA POZICIJE "TS1"

MATERIJALI

Beton:

Klasa betona **C 25/30**

$$f_{ck} = 25,00 \text{ MPa}$$

$$f_{cd} = 16,67 \text{ MPa}$$

Armatura:

Tip armature: **B 500B**

$$f_{yk} = 500,00 \text{ MPa}$$

$$f_{yd} = 434,78 \text{ MPa}$$

Koeficijenti sigurnosti materijala:

$$\gamma_c = 1,5$$

$$\gamma_s = 1,15$$

$$f_{cd} = \frac{f_{ck}}{\gamma_c} \quad f_{yd} = \frac{f_{yk}}{\gamma_s}$$

GEOMETRIJSKE KARAKTERISTIKE TEMELJA

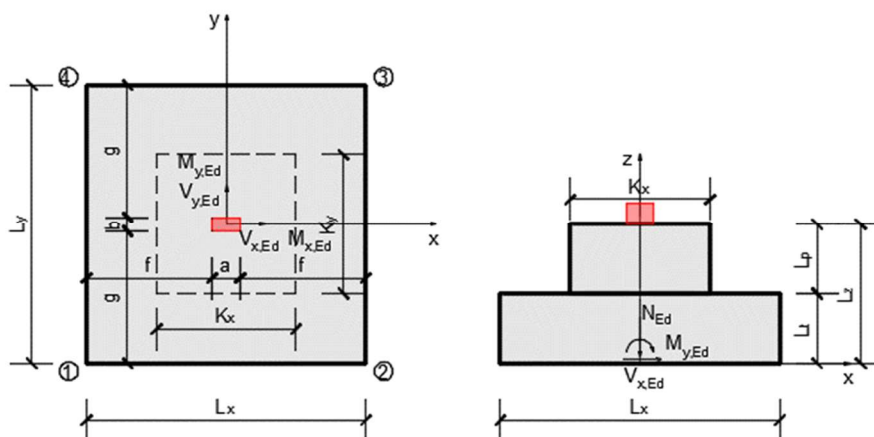

$$L_x = 220 \text{ cm}$$

$$L_y = 220 \text{ cm}$$

$$L_t = 100 \text{ cm}$$

$$L_p = 0 \text{ cm}$$

$$L_z = 100 \text{ cm}$$

$$a = 20 \text{ cm}$$

$$b = 20 \text{ cm}$$

$$f = 100 \text{ cm}$$

$$g = 100 \text{ cm}$$

$$K_x = 150 \text{ cm}$$

$$K_y = 60 \text{ cm}$$

$$d = 95,0 \text{ cm}$$

$$d_1 = 5,0 \text{ cm}$$

$$A_t = 4,84 \text{ m}^2$$

$$W_x = 1,7747 \text{ m}^3$$

$$W_y = 1,7747 \text{ m}^3$$

$$I_x = 1,9521 \text{ m}^4$$

$$I_y = 1,9521 \text{ m}^4$$

$$A_t = L_x \cdot L_y$$

$$W_x = \frac{L_x \cdot L_y^2}{6} \quad W_y = \frac{L_y \cdot L_x^2}{6}$$

$$W_y = \frac{L_y \cdot L_x^2}{6} \quad I_y = \frac{L_y \cdot L_x^3}{12}$$

d - statička visina

d1 - udaljenost dna temelja od težišta armature

$$d = L_t - d_1$$

REZNE SILE ZA DIMENZIONIRANJE TEMELJA

Tablica reznih sila od stupova koje se prenose na temelje

Kombinacije opterećenja	$M_{x,Eds}$ (kNm)	$M_{y,Eds}$ (kNm)	$V_{x,Eds}$ (kN)	$V_{y,Eds}$ (kN)	N_{Eds} (kN)
(Mmax, Nprip)	6,83	122,35	0	0	190,25
(Nmax, Mprip)					
.					
.					

Visina zemlje (od vrha do vrha temeljne stope)

z= cm

$\gamma_z =$	<input type="text" value="20"/>	kN/m ³
$\gamma_b =$	<input type="text" value="25"/>	kN/m ³
$N_z =$	<input type="text" value="15,76"/>	kN
$N_t =$	<input type="text" value="121"/>	kN

N_z - sila od težine zemlje
 N_t - sila od težine temelja

$$N_{Ed} = N_{Eds} + N_z + N_t$$

$$M_{x,Ed} = M_{x,Eds} + V_{y,Eds} \cdot L_z$$

$$M_{y,Ed} = M_{y,Eds} + V_{x,Eds} \cdot L_z$$

Tablica reznih za dimenzioniranje temelja

Kombinacije opterećenja	$M_{x,Ed}$ (kNm)	$M_{y,Ed}$ (kNm)	N_{Ed} (kN)
(Mmax, Nprip)	6,83	122,35	374,88
(Nmax, Mprip)			
.			
.			

PRORAČUN NAPREZANJA ISPOD TEMELJNE STOPE

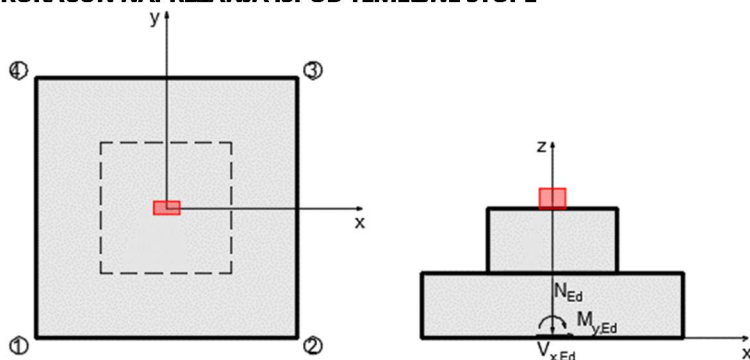

$$\sigma_1 = \frac{N_{Ed}}{A_t} + \frac{M_{y,Ed}}{W_y} - \frac{M_{x,Ed}}{W_x} \quad \sigma_2 = \frac{N_{Ed}}{A_t} + \frac{M_{y,Ed}}{W_y} + \frac{M_{x,Ed}}{W_x} \quad e_x = \frac{M_{x,Ed}}{N_{Ed}}$$

$$\sigma_3 = \frac{N_{Ed}}{A_t} - \frac{M_{y,Ed}}{W_y} + \frac{M_{x,Ed}}{W_x} \quad \sigma_4 = \frac{N_{Ed}}{A_t} - \frac{M_{y,Ed}}{W_y} - \frac{M_{x,Ed}}{W_x} \quad e_y = \frac{M_{y,Ed}}{N_{Ed}}$$

U slučaju da je $e > L/6$ potrebna je redukcija temeljne stope!

Kombinacije opterećenja	e_x (cm)	$L_x/6$ (cm)	e_y (cm)	$L_y/6$ (cm)
(Mmax, Nprp)	1,82	36,67	32,64	36,67
(Nmax, Mprp)				
.				
.				

Kombinacije opterećenja	σ_1 (kPa)	σ_2 (kPa)	σ_3 (kPa)	σ_4 (kPa)
(Mmax, Nprp)	12,36	150,24	142,55	4,66
(Nmax, Mprp)				
.				
.				

Shematski prikaz reducirane površine temelja

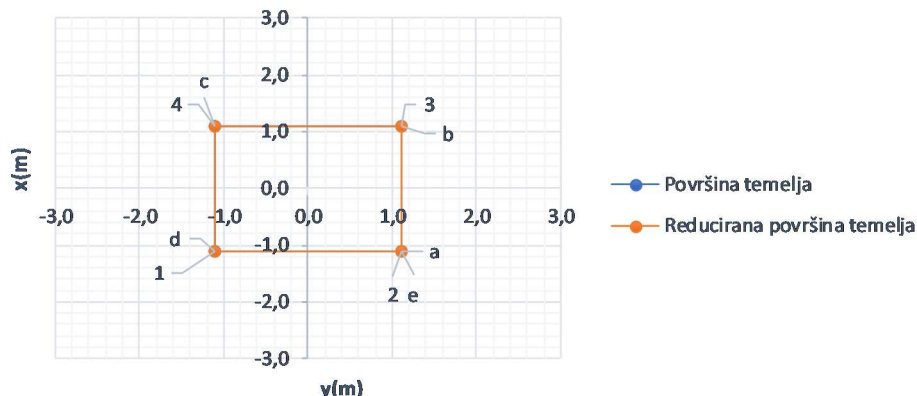
 σ_{\max}

150,24 kPa

<

 σ_{dop}

325 kPa

Zadovoljava!

PRORAČUN POTREBNE ARMATURE U TEMELJU

Kombinacije opterećenja	x-smjer			y-smjer		
	μA	ζ	As1 (cm ²)	μB	ζ	As1 (cm ²)
Kritična kombinacija	0,004	0,987	3,39	0,003	0,990	2,41

Napomena: As1 je ukupna armatura potrebna u temeljnoj stopi u jednom smjeru!

Potrebna armatura	x-smjer		y-smjer	
	(cm ²)	(cm ² /m')	(cm ²)	(cm ² /m')
Potrebna armatura	3,39	1,54	2,41	1,10

Minimalna armatura u temelju $A_{smin} = 6,50$ (cm²/m') $A_{smin} = 0.0013 \cdot b \cdot d$

	x-smjer	y-smjer
Odabrana mreža		
Odabrane šipke	Ø12 / 15	Ø12 / 15
Ukupna armatura	7,54 cm ² /m'	7,54 cm ² /m'

6.1.1.3. Odabrana armatura za temelj pozicije „TS1“

U donju i gornju zonu postaviti šipkastu armaturu Ø 12/15 ($A_s = 6.79$ cm²/m') obostrano. Po rubu temelja postaviti konstruktivnu armaturu 2Ø10.

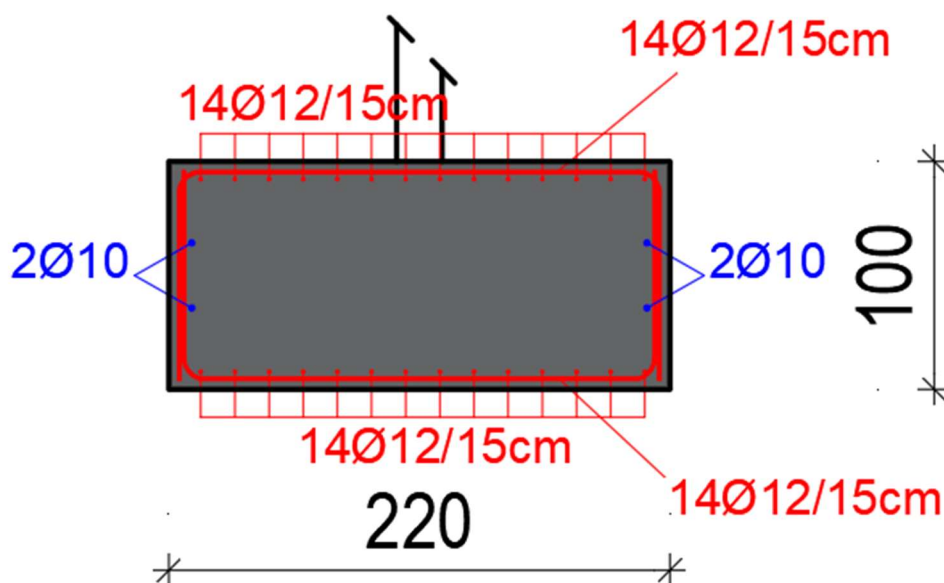

Slika 98: Shematski prikaz armature temelja pozicije TS1

6.1.2. Temeljna stopa „TS2“

6.1.2.1. Reakcije na mjerodavnoj temeljnoj stopi

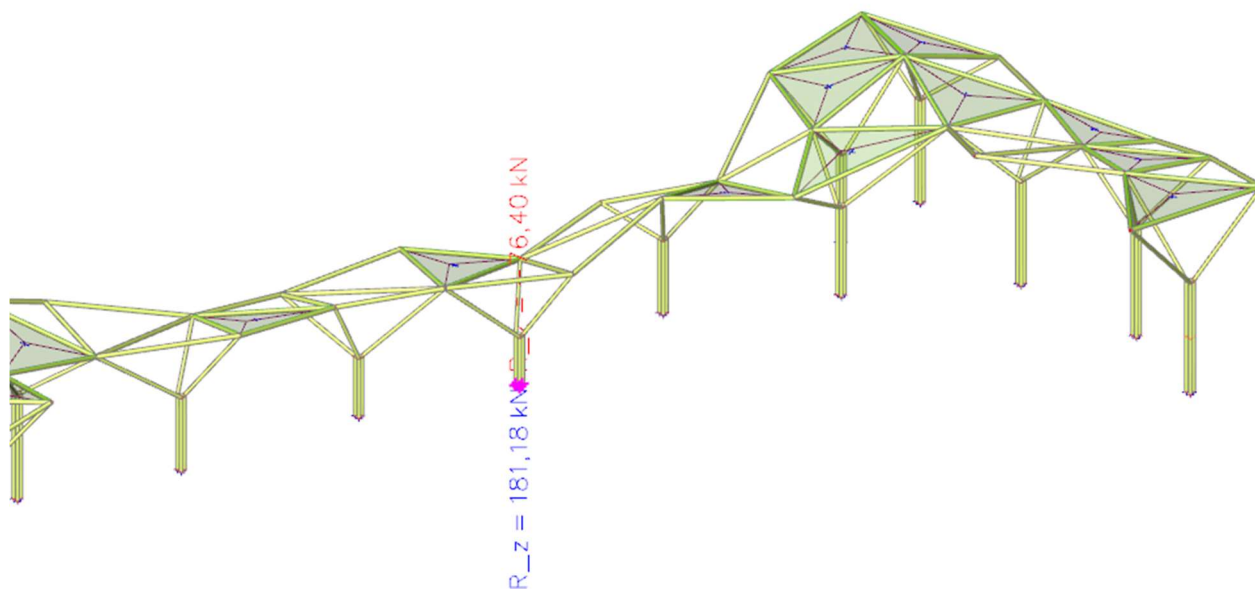

Slika 99: Mjerodavna reakcija za proračun temeljne stope „TS2“

Resultant of reactions

Linear calculation

Combination: ULS-Set B (auto)

Extreme: Global

Selection: Sn627..Sn629, N5827, N5829, N5831

System: Global

x [m]	y [m]	z [m]	Case	R _x [kN]	R _y [kN]	R _z [kN]	M _x [kNm]	M _y [kNm]	M _z [kNm]
157,706	1622,029	0,000	ULS-Set B (auto)/1	61,02	-12,25	-50,66	19,12	199,28	4,30
157,706	1622,029	0,000	ULS-Set B (auto)/2	-50,37	29,24	155,45	5,67	-193,90	-1,83
157,706	1622,029	0,000	ULS-Set B (auto)/3	92,55	-7,69	-76,40	19,32	298,31	8,47
157,706	1622,029	0,000	ULS-Set B (auto)/4	-81,90	24,68	181,18	5,47	-292,93	-6,00
157,706	1622,029	0,000	ULS-Set B (auto)/5	-68,91	6,98	99,47	-6,64	-224,01	-2,59
157,706	1622,029	0,000	ULS-Set B (auto)/6	61,37	-2,82	-8,84	79,03	175,09	9,42
157,706	1622,029	0,000	ULS-Set B (auto)/7	-93,66	14,01	151,32	-2,75	-315,29	-6,03
157,706	1622,029	0,000	ULS-Set B (auto)/8	94,14	-5,99	-63,04	22,86	300,01	8,71
157,706	1622,029	0,000	ULS-Set B (auto)/9	-76,57	-0,58	115,05	7,46	-254,18	-9,09
157,706	1622,029	0,000	ULS-Set B (auto)/10	93,39	0,89	-39,92	57,07	282,06	11,99

Name	Combination key
ULS-Set B (auto)/1	G + dg + 0.90*T- + 1.50*w3(odizanje)
ULS-Set B (auto)/2	1.35*G + 1.35*dg + 0.75*s + 0.90*T+ + 1.50*w3(pritisak)
ULS-Set B (auto)/3	G + dg + 1.50*T- + 0.90*w3(odizanje)
ULS-Set B (auto)/4	1.35*G + 1.35*dg + 0.75*s + 1.50*T+ + 0.90*w3(pritisak)
ULS-Set B (auto)/5	G + dg + 1.50*w1(x) + 0.90*T+
ULS-Set B (auto)/6	1.35*G + 1.35*dg + 0.75*s + 1.50*w2(y) + 0.90*T-
ULS-Set B (auto)/7	G + dg + 0.75*s + 0.90*w1(x) + 1.50*T+
ULS-Set B (auto)/8	1.35*G + 1.35*dg + 1.50*T- + 0.90*w3(odizanje)
ULS-Set B (auto)/9	G + dg + 1.50*T+ + 0.90*w3(odizanje)
ULS-Set B (auto)/10	1.35*G + 1.35*dg + 0.75*s + 0.90*w2(y) + 1.50*T-

Tablica 10: Tablični prikaz reakcija na mjerodavnoj temeljnoj stopi „TS2“

6.1.2.2. Dimenzioniranje temelja pozicije „TS2“ – 300 x 300 x 100 cm

PRORAČUN TEMELJA SAMCA POZICIJE "TS2"

MATERIJALI

Beton:

Klasa betona **C 25/30**

$$f_{ck} = 25,00 \text{ MPa}$$

$$f_{cd} = 16,67 \text{ MPa}$$

Armatura:

Tip armature: **B 500B**

$$f_{yk} = 500,00 \text{ MPa}$$

$$f_{yd} = 434,78 \text{ MPa}$$

Koeficijenti sigurnosti materijala:

$$\gamma_c = 1,5$$

$$\gamma_s = 1,15$$

$$f_{cd} = \frac{f_{ck}}{\gamma_c} \quad f_{yd} = \frac{f_{yk}}{\gamma_s}$$

GEOMETRIJSKE KARAKTERISTIKE TEMELJA

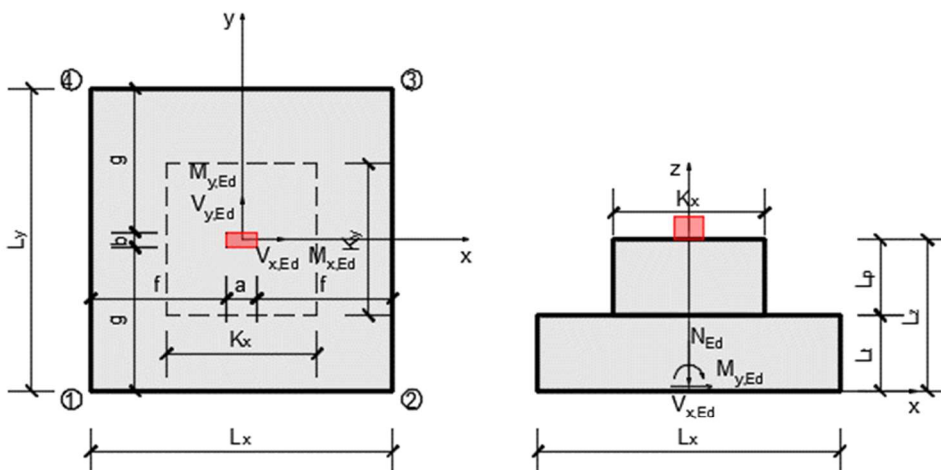

$L_x =$	220	cm
$L_y =$	220	cm
$L_t =$	100	cm
$L_p =$	0	cm
$L_z =$	100	cm
$a =$	20	cm
$b =$	20	cm

$f =$	100	cm
$g =$	100	cm
$K_x =$	150	cm
$K_y =$	60	cm

$d =$	95,0	cm
$d_1 =$	5,0	cm

$A_t =$	4,84	m ²
$W_x =$	1,7747	m ³
$W_y =$	1,7747	m ³
$I_x =$	1,9521	m ⁴
$I_y =$	1,9521	m ⁴

$$A_t = L_x \cdot L_y$$

$$W_x = \frac{L_x \cdot L_y^2}{6} \quad W_y = \frac{L_y \cdot L_x^2}{6}$$

$$W_y = \frac{L_y \cdot L_x^2}{6} \quad I_y = \frac{L_y \cdot L_x^3}{12}$$

d - statička visina

d₁ - udaljenost dna temelja od težišta armature

$$d = L_t - d_1$$

REZNE SILE ZA DIMENZIONIRANJE TEMELJA

Tablica reznih sila od stupova koje se prenose na temelje

Kombinacije opterećenja	$M_{x,Eds}$ (kNm)	$M_{y,Eds}$ (kNm)	$V_{x,Eds}$ (kN)	$V_{y,Eds}$ (kN)	N_{Eds} (kN)
(Mmax, Nprip)	132,49	99,51	0	0	38,82
(Nmax, Mprip)					
.					
.					

Visina zemlje (od vrha do vrha temeljne stope)

z= cm

$$\gamma_z = \begin{array}{|c|} \hline 20 \\ \hline \end{array} \text{ kN/m}^3$$

$$\gamma_b = \begin{array}{|c|} \hline 25 \\ \hline \end{array} \text{ kN/m}^3$$

$$N_z = \begin{array}{|c|} \hline 15,76 \\ \hline \end{array} \text{ kN}$$

$$N_t = \begin{array}{|c|} \hline 121 \\ \hline \end{array} \text{ kN}$$

Nz - sila od težine zemlje

Nt- sila od težine temelja

$$N_{Ed} = N_{Eds} + N_z + N_t$$

$$M_{x,Ed} = M_{x,Eds} + V_{y,Eds} \cdot L_z$$

$$M_{y,Ed} = M_{y,Eds} + V_{x,Eds} \cdot L_z$$

Tablica reznih za dimenzioniranje temelja

Kombinacije opterećenja	$M_{x,Ed}$ (kNm)	$M_{y,Ed}$ (kNm)	N_{Ed} (kN)
(Mmax, Nprip)	132,49	99,51	223,45
(Nmax, Mprip)			
.			
.			

PRORAČUN NAPREZANJA ISPOD TEMELJNE STOPE

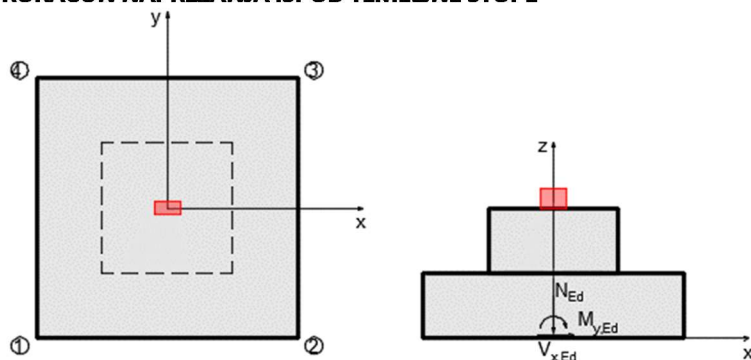

$$\sigma_1 = \frac{N_{Ed}}{A_t} + \frac{M_{y,Ed}}{W_y} - \frac{M_{x,Ed}}{W_x} \quad \sigma_2 = \frac{N_{Ed}}{A_t} + \frac{M_{y,Ed}}{W_y} + \frac{M_{x,Ed}}{W_x} \quad e_x = \frac{M_{x,Ed}}{N_{Ed}}$$

$$\sigma_3 = \frac{N_{Ed}}{A_t} - \frac{M_{y,Ed}}{W_y} + \frac{M_{x,Ed}}{W_x} \quad \sigma_4 = \frac{N_{Ed}}{A_t} - \frac{M_{y,Ed}}{W_y} - \frac{M_{x,Ed}}{W_x} \quad e_y = \frac{M_{y,Ed}}{N_{Ed}}$$

U slučaju da je $e > L/6$ potrebna je redukcija temeljne stope!

Kombinacije opterećenja	e_x (cm)	$L_x/6$ (cm)	e_y (cm)	$L_y/6$ (cm)
(Mmax, Nprip)	59,29	36,67	44,53	36,67
(Nmax, Mprip)				
.				
.				

Kombinacije opterećenja	σ_1 (kPa)	σ_2 (kPa)	σ_3 (kPa)	σ_4 (kPa)
(Mmax, Nprip)	42,83	251,55	0,00	0,00
(Nmax, Mprip)				
.				
.				

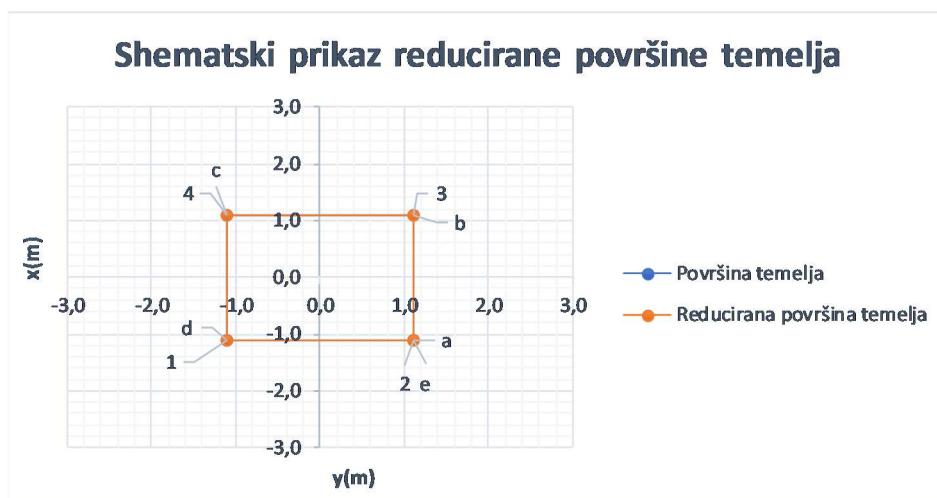
 σ_{max}

251,55 kPa

<

 σ_{dop}

325 kPa

Zadovoljava!

PRORAČUN POTREBNE ARMATURE U TEMELJU

Kombinacije opterećenja	x-smjer			y-smjer		
	μA	ζ	A_{s1} (cm^2)	μB	ζ	A_{s1} (cm^2)
Kritična kombinacija	0,003	0,990	2,31	0,003	0,987	2,81

Napomena: A_{s1} je ukupna armatura potrebna u temeljnoj stopi u jednom smjeru!

	x-smjer		y-smjer	
	(cm^2)	(cm^2/m')	(cm^2)	(cm^2/m')
Potrebna armatura	2,31	1,05	2,81	1,28

Minimalna armatura u temelju $A_{smin} = 6,50$ (cm^2/m') $A_{smin} = 0.0013 \cdot b \cdot d$

	x-smjer	y-smjer
Odabrana mreža		
Odabrane šipke	$\emptyset 12 / 15$	$\emptyset 12 / 15$
Ukupna armatura	$7,54$ cm^2/m'	$7,54$ cm^2/m'

6.1.2.3. Odabrana armatura za temelj pozicije „TS2“

U donju i gornju zonu postaviti šipkastu armaturu $\emptyset 12/15$ ($A_s = 6.79$ cm^2/m') obostrano. Po rubu temelja postaviti konstruktivnu armaturu $2\emptyset 10$.

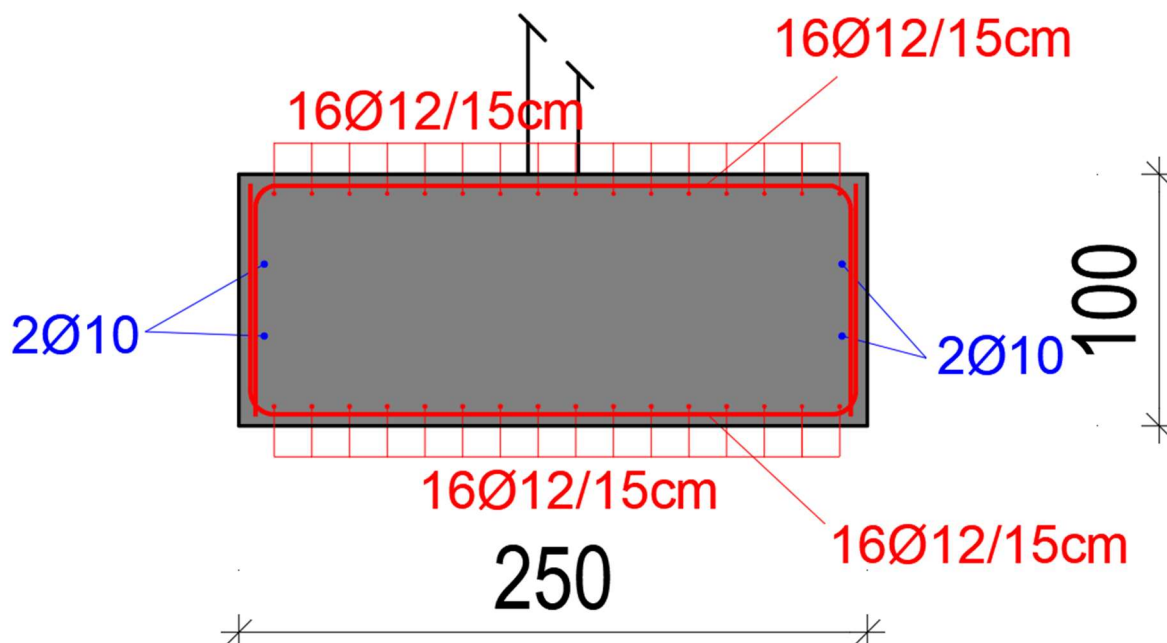

6.1.1. Temeljna stopa „TS3“

6.1.1.1. Reakcije na mjerodavnoj temeljnoj stopi

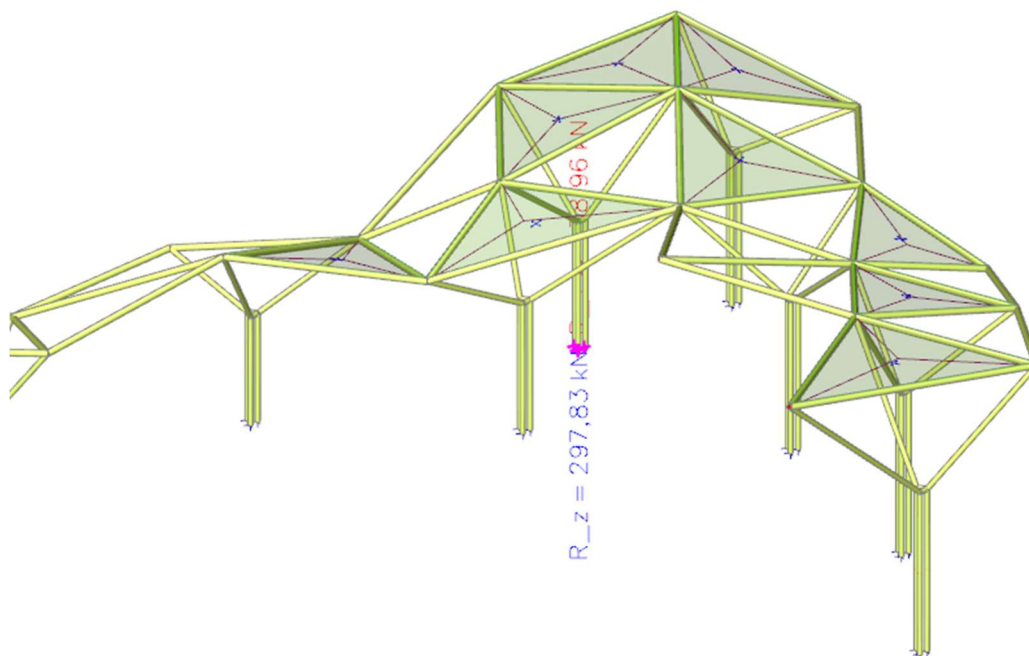

Slika 100: Mjerodavna reakcija za proračun temeljne stope „TS3“

Resultant of reactions

Linear calculation

Combination: ULS-Set B (auto)

Extreme: Global

Selection: Sn636..Sn638, N5845, N5847, N5849

System: Global

x [m]	y [m]	z [m]	Case	R _x [kN]	R _y [kN]	R _z [kN]	M _x [kNm]	M _y [kNm]	M _z [kNm]
185,571	1628,590	0,000	ULS-Set B (auto)/1	-29,41	-3,66	83,61	21,91	-139,83	-0,35
185,571	1628,590	0,000	ULS-Set B (auto)/2	24,96	-0,36	221,07	6,01	107,92	-1,45
185,571	1628,590	0,000	ULS-Set B (auto)/3	-13,54	-22,55	180,42	111,46	-70,39	-0,96
185,571	1628,590	0,000	ULS-Set B (auto)/4	23,44	3,91	-3,93	-20,94	115,10	0,96
185,571	1628,590	0,000	ULS-Set B (auto)/5	-15,83	0,15	-78,96	-1,05	-67,56	2,13
185,571	1628,590	0,000	ULS-Set B (auto)/6	15,60	-2,90	297,83	21,46	59,24	-1,85
185,571	1628,590	0,000	ULS-Set B (auto)/7	13,30	3,78	-65,31	-21,03	70,69	1,74
185,571	1628,590	0,000	ULS-Set B (auto)/8	-29,18	-4,70	138,13	28,61	-141,97	-0,82
185,571	1628,590	0,000	ULS-Set B (auto)/9	24,72	-8,93	104,29	41,32	115,23	-0,68
185,571	1628,590	0,000	ULS-Set B (auto)/10	6,49	0,64	132,24	-1,81	29,24	-2,19
185,571	1628,590	0,000	ULS-Set B (auto)/11	-15,90	-0,11	-54,48	0,99	-68,48	2,24

Name	Combination key
ULS-Set B (auto)/1	1.35*G + 1.35*dg + 0.90*w1(x) + 1.50*T+
ULS-Set B (auto)/2	G + dg + 0.75*s + 1.50*T- + 0.90*w3(pritisak)
ULS-Set B (auto)/3	1.35*G + 1.35*dg + 0.75*s + 1.50*w2(y) + 0.90*T+
ULS-Set B (auto)/4	G + dg + 1.50*T- + 0.90*w3(odizanje)
ULS-Set B (auto)/5	G + dg + 0.90*T+ + 1.50*w3(odizanje)
ULS-Set B (auto)/6	1.35*G + 1.35*dg + 0.75*s + 0.90*T- + 1.50*w3(pritisak)
ULS-Set B (auto)/7	G + dg + 0.90*T- + 1.50*w3(odizanje)
ULS-Set B (auto)/8	1.35*G + 1.35*dg + 0.75*s + 0.90*w1(x) + 1.50*T+
ULS-Set B (auto)/9	G + dg + 0.90*w2(y) + 1.50*T-
ULS-Set B (auto)/10	G + dg + 0.75*s + 1.50*w1(x) + 0.90*T-
ULS-Set B (auto)/11	1.35*G + 1.35*dg + 0.90*T+ + 1.50*w3(odizanje)

Tablica 11: Tablični prikaz reakcija na mjerodavnoj temeljnoj stopi „TS3“

6.1.1.2. Dimenzioniranje temelja pozicije „TS3“ 250 x 250 x 100 cm

PRORAČUN TEMELJA SAMCA POZICIJE "TS3"

MATERIJALI

Beton:

Klasa betona **C 25/30** $f_{ck} = 25,00$ MPa $f_{cd} = 16,67$ MPa

Armatura:

Tip armature: **B 500B** $f_{yk} = 500,00$ MPa $f_{yd} = 434,78$ MPa

Koeficijenti sigurnosti materijala:

 $\gamma_c = 1,5$ $\gamma_s = 1,15$

$$f_{cd} = \frac{f_{ck}}{\gamma_c} \quad f_{yd} = \frac{f_{yk}}{\gamma_s}$$

GEOMETRIJSKE KARAKTERISTIKE TEMELJA

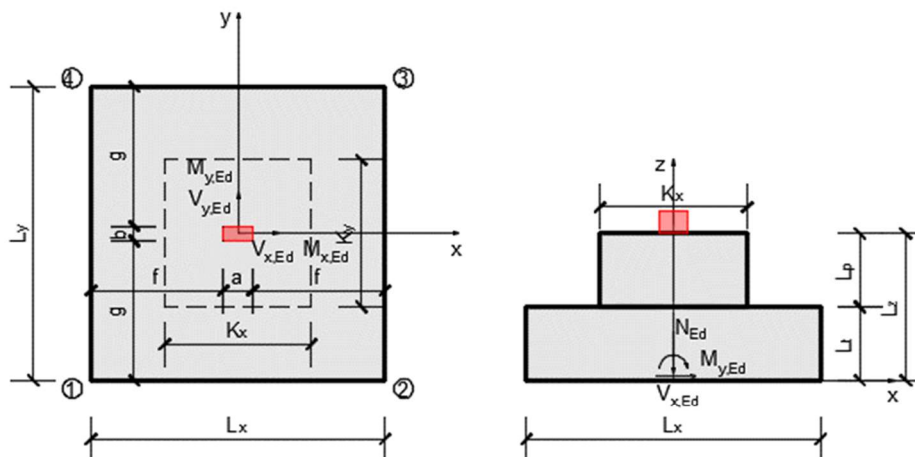

$L_x =$	300	cm
$L_y =$	300	cm
$L_t =$	100	cm
$L_p =$	0	cm
$L_z =$	100	cm
$a =$	20	cm
$b =$	20	cm

$f =$	140	cm
$g =$	140	cm
$K_x =$	150	cm
$K_y =$	60	cm

$d =$	95,0	cm
$d_1 =$	5,0	cm

$A_t =$	9,00	m ²
$W_x =$	4,5000	m ³
$W_y =$	4,5000	m ³
$I_x =$	6,7500	m ⁴
$I_y =$	6,7500	m ⁴

$$A_t = L_x \cdot L_y$$

$$W_x = \frac{L_x \cdot L_y^2}{6} \quad W_y = \frac{L_y \cdot L_x^2}{6}$$

$$W_y = \frac{L_y \cdot L_x^2}{6} \quad I_y = \frac{L_y \cdot L_x^3}{12}$$

d - statička visina

d₁ - udaljenost dna temelja od težišta armature

$$d = L_t - d_1$$

REZNE SILE ZA DIMENZIONIRANJE TEMELJA

Tablica reznih sila od stupova koje se prenose na temelje

Kombinacije opterećenja	$M_{x,Eds}$ (kNm)	$M_{y,Eds}$ (kNm)	$V_{x,Eds}$ (kN)	$V_{y,Eds}$ (kN)	N_{Eds} (kN)
(Mmax, Nprip)	132,49	99,51	0	0	38,82
(Nmax, Mprip)					
.					
.					

Visina zemlje (od vrha do vrha temeljne stope)

z= cm

$\gamma_z =$	<input type="text" value="20"/>	kN/m ³
$\gamma_b =$	<input type="text" value="25"/>	kN/m ³
$N_z =$	<input type="text" value="32,4"/>	kN
$N_t =$	<input type="text" value="225"/>	kN

N_z - sila od težine zemlje

N_t - sila od težine temelja

$$N_{Ed} = N_{Eds} + N_z + N_t$$

$$M_{x,Ed} = M_{x,Eds} + V_{y,Eds} \cdot L_z$$

$$M_{y,Ed} = M_{y,Eds} + V_{x,Eds} \cdot L_z$$

Tablica reznih za dimenzioniranje temelja

Kombinacije opterećenja	$M_{x,Ed}$ (kNm)	$M_{y,Ed}$ (kNm)	N_{Ed} (kN)
(Mmax, Nprip)	132,49	99,51	386,31
(Nmax, Mprip)			
.			
.			

PRORAČUN NAPREZANJA ISPOD TEMELJNE STOPE

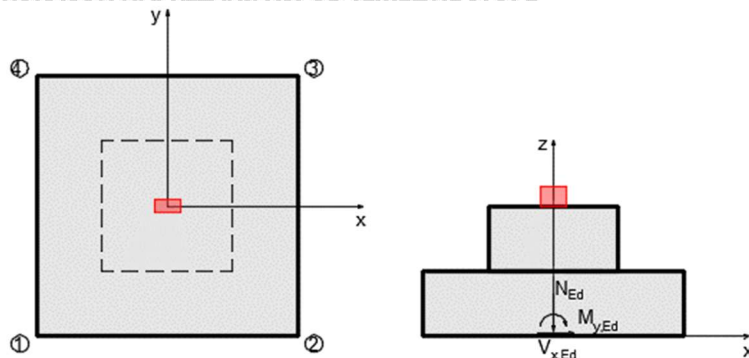

$$\sigma_1 = \frac{N_{Ed}}{A_t} + \frac{M_{y,Ed}}{W_y} - \frac{M_{x,Ed}}{W_x} \quad \sigma_2 = \frac{N_{Ed}}{A_t} + \frac{M_{y,Ed}}{W_y} + \frac{M_{x,Ed}}{W_x} \quad e_x = \frac{M_{x,Ed}}{N_{Ed}}$$

$$\sigma_3 = \frac{N_{Ed}}{A_t} - \frac{M_{y,Ed}}{W_y} + \frac{M_{x,Ed}}{W_x} \quad \sigma_4 = \frac{N_{Ed}}{A_t} - \frac{M_{y,Ed}}{W_y} - \frac{M_{x,Ed}}{W_x} \quad e_y = \frac{M_{y,Ed}}{N_{Ed}}$$

U slučaju da je $e > L/6$ potrebna je redukcija temeljne stope!

Kombinacije opterećenja	e_x (cm)	$L_x/6$ (cm)	e_y (cm)	$L_y/6$ (cm)
(Mmax, Nprip)	34,30	50,00	25,76	50,00
(Nmax, Mprip)				
.				
.				

Kombinacije opterećenja	σ_1 (kPa)	σ_2 (kPa)	σ_3 (kPa)	σ_4 (kPa)
(Mmax, Nprip)	50,21	94,68	35,55	0,00
(Nmax, Mprip)				
.				
.				

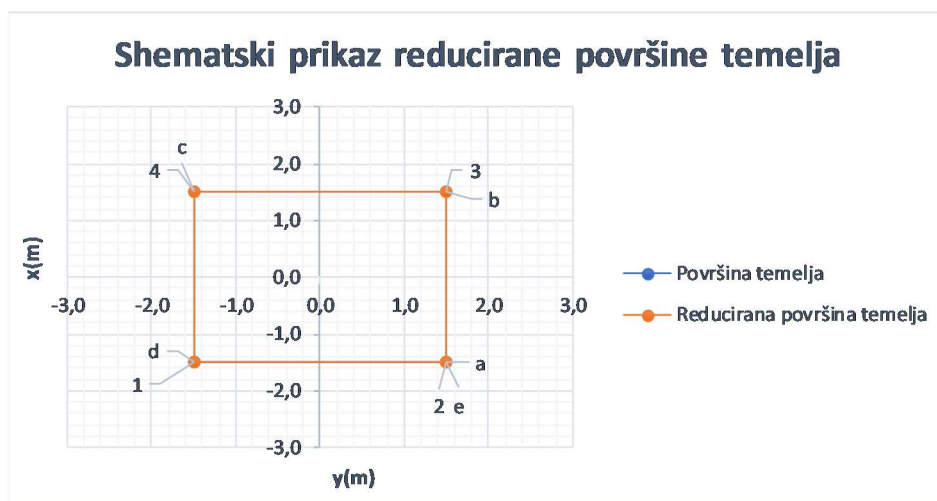
 σ_{max}

94,68 kPa

<

 σ_{dop}

325 kPa

Zadovoljava!

PRORAČUN POTREBNE ARMATURE U TEMELJU

Kombinacije opterećenja	x-smjer			y-smjer		
	μA	ζ	As1 (cm ²)	μB	ζ	As1 (cm ²)
Kritična kombinacija	0,004	0,987	4,19	0,004	0,987	4,56

Napomena: As1 je ukupna armatura potrebna u temeljnoj stopi u jednom smjeru!

	x-smjer		y-smjer	
	(cm ²)	(cm ² /m')	(cm ²)	(cm ² /m')
Potrebna armatura	4,19	1,40	4,56	1,52

Minimalna armatura u temelju: $A_{smin} = \boxed{6,50}$ (cm²/m') $A_{smin} = 0.0013 \cdot b \cdot d$

	x-smjer	y-smjer
Odabrana mreža		
Odabrane šipke	Ø12 / 15	Ø12 / 15
Ukupna armatura	7,54 cm ² /m'	7,54 cm ² /m'

6.1.1.3. Odabrana armatura za temelj pozicije „TS3“

U donju i gornju zonu postaviti šipkastu armaturu Ø 12/15 ($A_s = 6.79 \text{ cm}^2/\text{m}'$) obostrano. Po rubu temelja postaviti konstruktivnu armaturu 2Ø10.

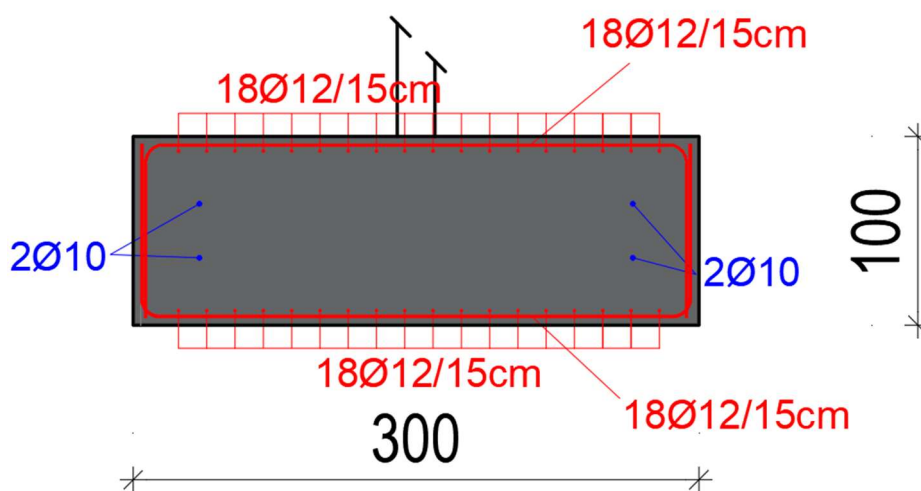

7. Nacrti



LEGENDA ČELIČNIH ELEMENATA

S1 stup vanjske nadstrešnice - CFCHS 219.1x12.5 (S355)
 S2 stup niskog dijela nadstrešnice - CFCHS 355.6x8.0 (S355)
 S3 rubni stup nadstrešnice - CFCHS 355.6x8.0 (S355)

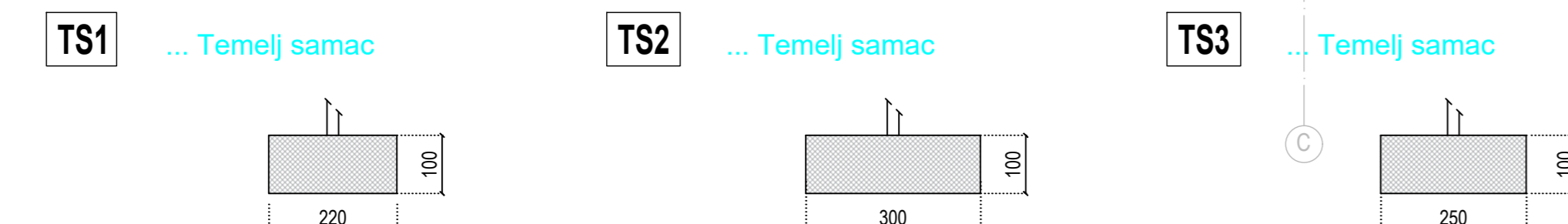

PLAN POZICIJA TEMELJA VANJSKE NADSTREŠNICE
M 1:100

BETON, ČELIČ
 ARHITEKTURA: 2023
 KLASA ODLIČNOSTI: IV
 ZASTUPNIK: Ilija Boko
 MARKISANO ŽRNO ŽALJEVAČKA 22000

	DIPLOMSKI RAD	
	TITULA:	GLAVNI PROJEKT NADSTREŠNICE "KING CROSS"
	MENTORICA:	dr.sc. Ivica Boko
	STUDENT:	Filip Čoga
	PRILOG:	Plan pozicija temelja vanjske nadstrešnice između osi N1 i N12
BR. PROJEKTA:	1:100	
DATA:	lipanj 2023.	

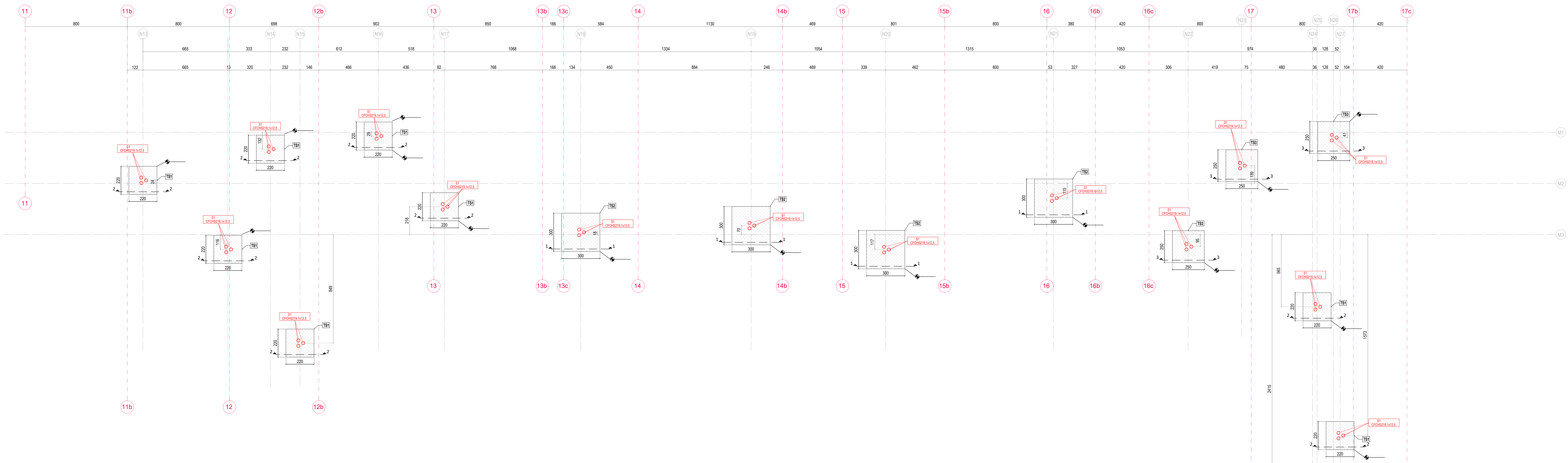

LEGENDA ČELIČNIH ELEMENATA

- S1 stup vanjske nadstrešnice ○ - CFCHS 219x12,5 (S355)
- TS1 stup niskog dijela nadstrešnice ○ - CFCHS 355x6x8,0 (S355)
- S3 rubni stup nadstrešnice ○ - CFCHS 355x6x8,0 (S355)

© 2023. Sveučilište u Splitu, Fakultet građovinarstva, arhitekture i inženjeringa
 Sveučilište u Splitu, Fakultet građovinarstva, arhitekture i inženjeringa
 Sveučilište u Splitu, Fakultet građovinarstva, arhitekture i inženjeringa
 Sveučilište u Splitu, Fakultet građovinarstva, arhitekture i inženjeringa

Karakteristični presjeci:
M 1:25

TS2 ... Temelj samac

Presjek 1-1:

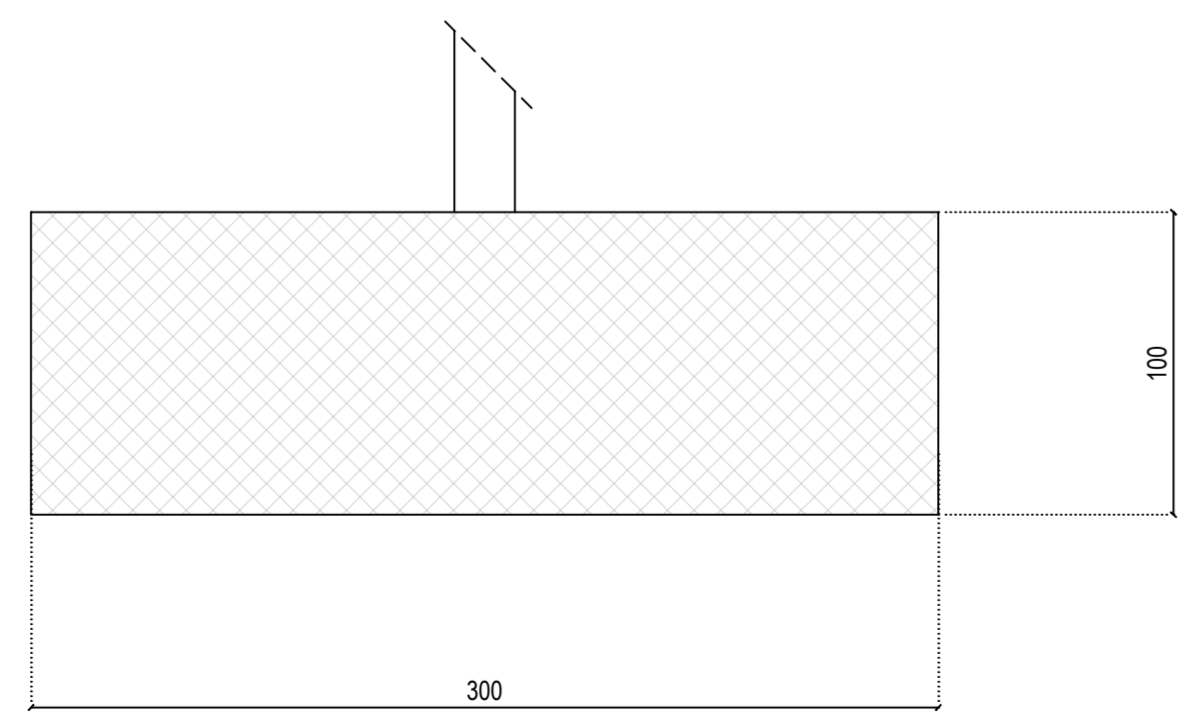

TS1 ... Temelj samac

Presjek 2-2:

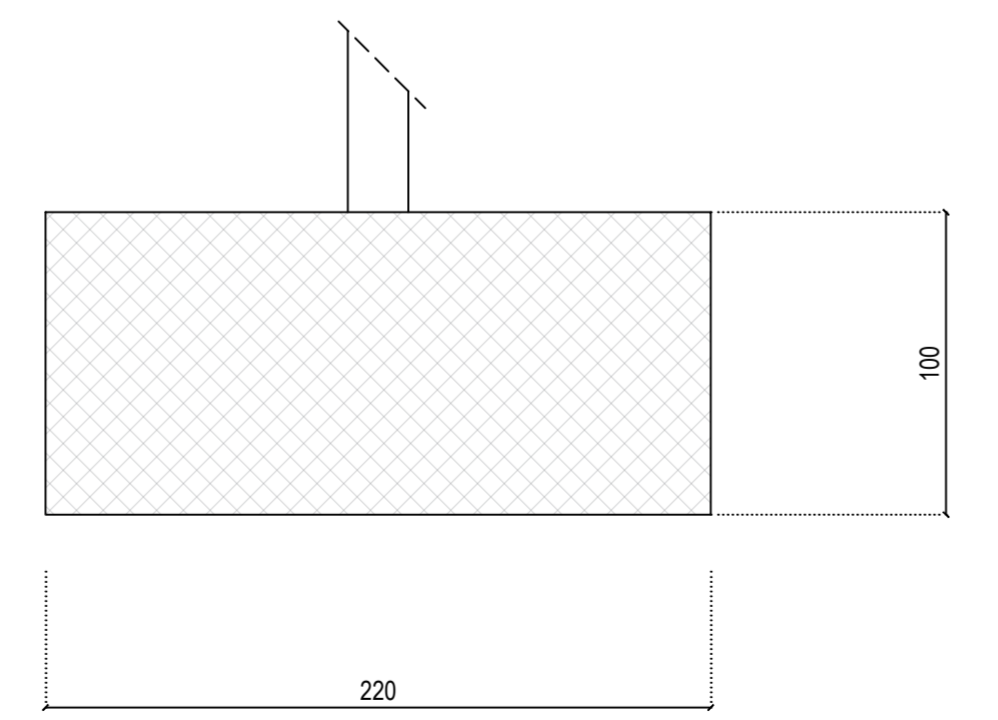

TS3 ... Temelj samac

Presjek 3-3:

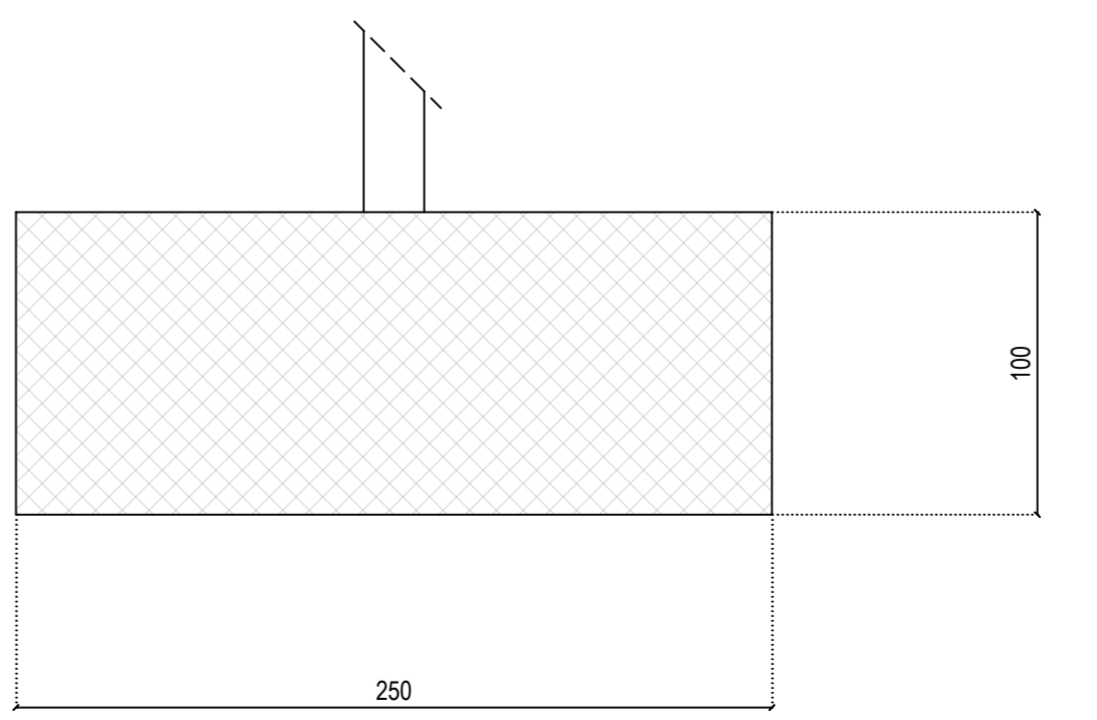

PLAN POZICIJA TEMELJA VANJSKE NADSTREŠNICE
M 1:100

IZ OBLASTI GRAĐEVINARSTVA I ARHITEKTURE
 IZ OBLASTI GRAĐEVINARSTVA I ARHITEKTURE
 IZ OBLASTI GRAĐEVINARSTVA I ARHITEKTURE

	DIPLOMSKI RAD	
	GLAVNI PROJEKT NADSTREŠNICE "KING CROSS"	
	dr. sc. Ivica Bekić	
	Filip Čopa	
Sveučilište u Splitu, Fakultet građovinarstva, arhitekture i inženjeringa	Plan pozicija temelja vanjske nadstrešnice (opisni del N13.1.027)	1:100 1:100
lipanj 2023.	2	2



LEGENDA:

[S1] stup vanjske nadstrešnice	○ - CFCHS 219x12,5 (S355)
[S2] stup niskog dijela nadstrešnice	○ - CFCHS 355,6x8,0 (S355)
[S3] rubni stup nadstrešnice	○ - CFCHS 355,6x8,0 (S355)
[SK1] kosi dio stupa S1	○ - CFCHS 219,1x12,5 (S355)
[PK] krovni nosači	○ - CFCHS 273x8,0 (S355)

Ukupna površina: 101,11 m²
 Ukupna dužina: 101,11 m
 Ukupna težina: 101,11 t
 Ukupna težina: 101,11 t
 Ukupna težina: 101,11 t

PLAN POZICIJA ELEMENATA VANJSKE NADSTREŠNICE
 M 1:100

BETON, C 30/37
 ARMATURA: S355
 KLASA OČUVANOSTI: NC20/25
 ZASTITNI SLOJ: 30 mm
 Maksimalno žono odstupanje: 20 mm

	DIPLOMSKI RAD		
	TITRA: GLAVNI PROJEKT NADSTREŠNICE "KING CROSS"		
	MENTORICA: dr.sc. Ivica Boko		
	STUDENT: Filip Čoga	BRIGADA: Plan pozicija elemenata vanjske nadstrešnice između osi N1 i N12	ŠKEMA: 1:100
	DATA: lipanj 2023.	BRIGADNI PROJEKCIJA	3

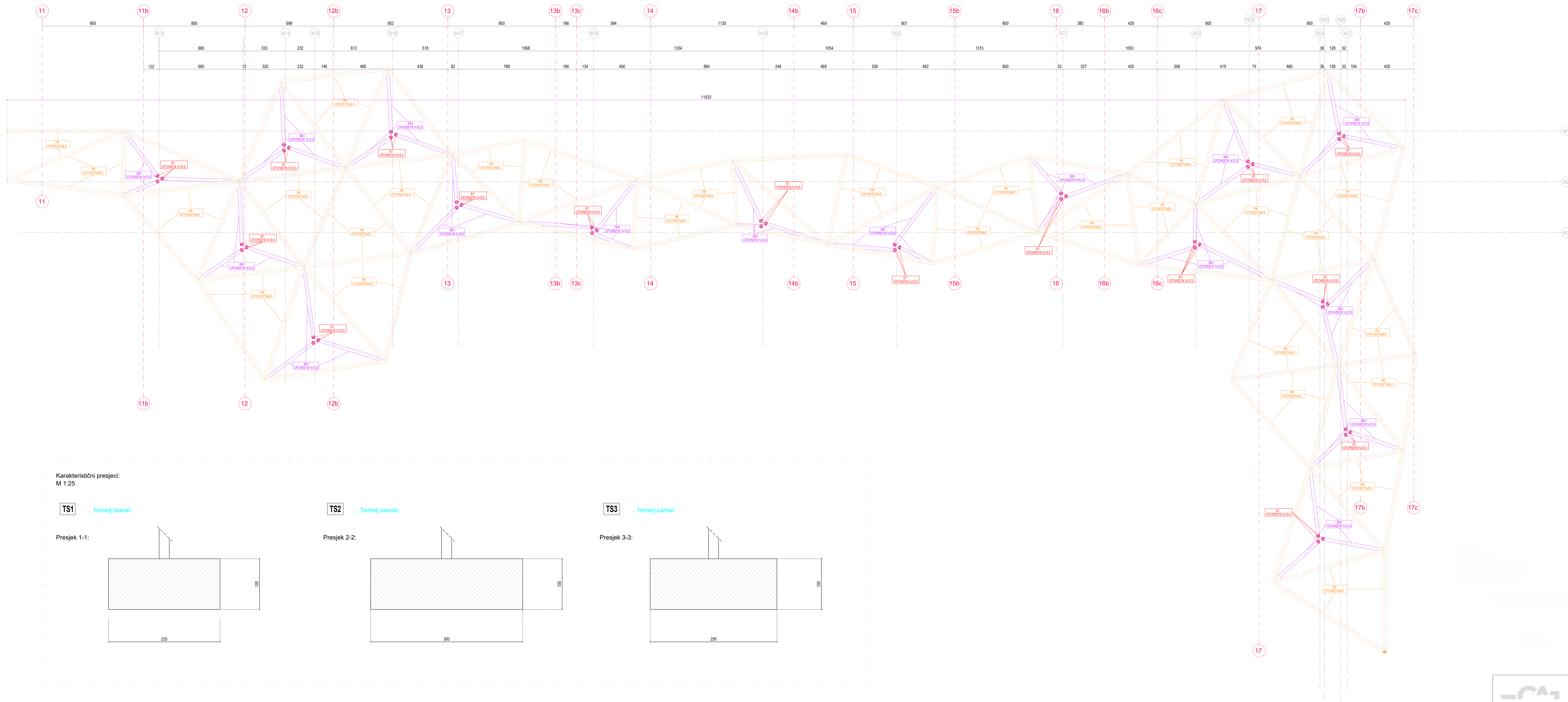

LEGENDA:

S1 stup vanjske nadstrešnice	○ - CFCHS 219x12,5 (S355)
S2 stup niskog dijela nadstrešnice	○ - CFCHS 355,5x8,0 (S355)
S3 rubni stup nadstrešnice	○ - CFCHS 355,5x8,0 (S355)
SK1 nosi do stupa S1	○ - CFCHS 219,1x12,5 (S355)
PK izvorni nosači	○ - CFCHS 273x8,0 (S355)

Karakteristični presjeci:
M 1:25

TS1 ... Temelj samac

Presjek 1-1:

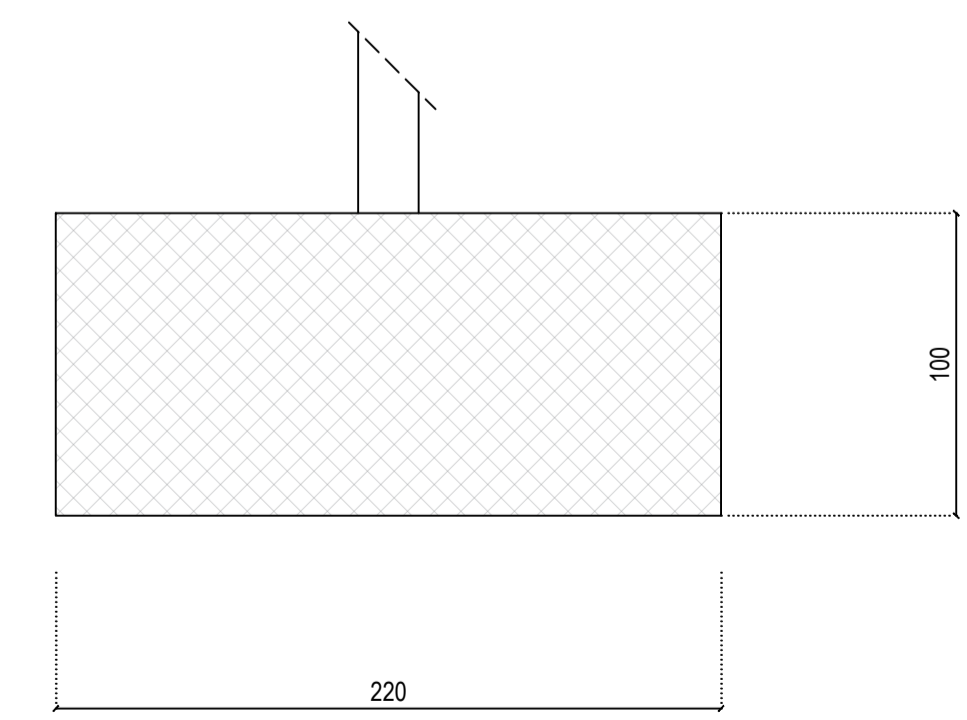

TS2 ... Temelj samac

Presjek 2-2:

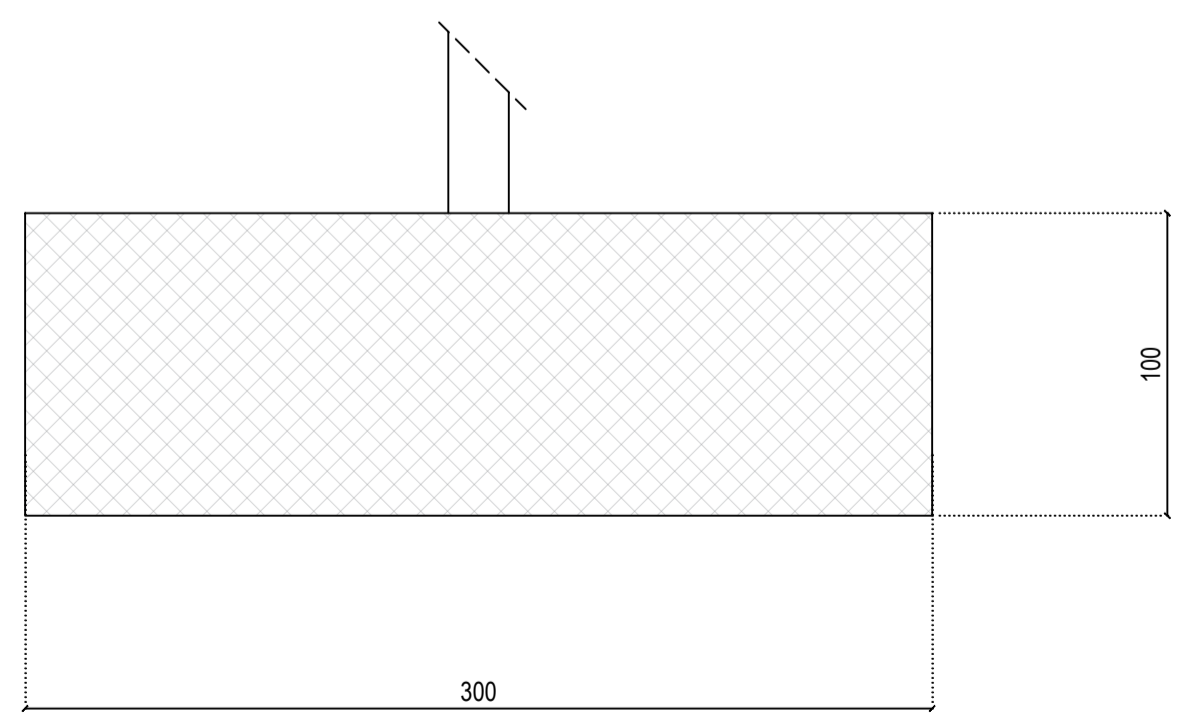

TS3 ... Temelj samac

Presjek 3-3:

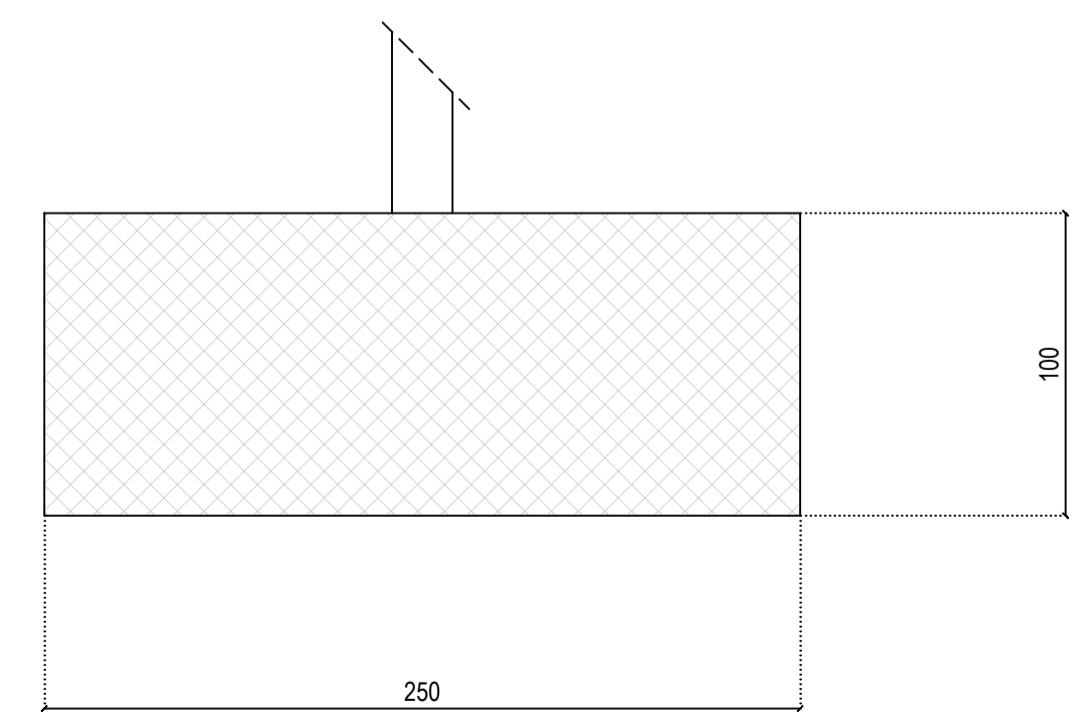

PLAN POZICIA ELEMENTA VANJSKE NADSTREŠNICE
M 1:100

	DIPLOMSKI RAD		
	Tema: GLAVNI PROJEKT NADSTREŠNICE "YING CROSS"		
	Mentorica: dr. sc. Ivana Bokić		Mentor: Filip Čigrić
	Predmet: Plan pozicija elemenata vanjske nadstrešnice i susedstva		Datum: 11.10.2023.
		Stranica: 4	1:100

Presjek 1-1:

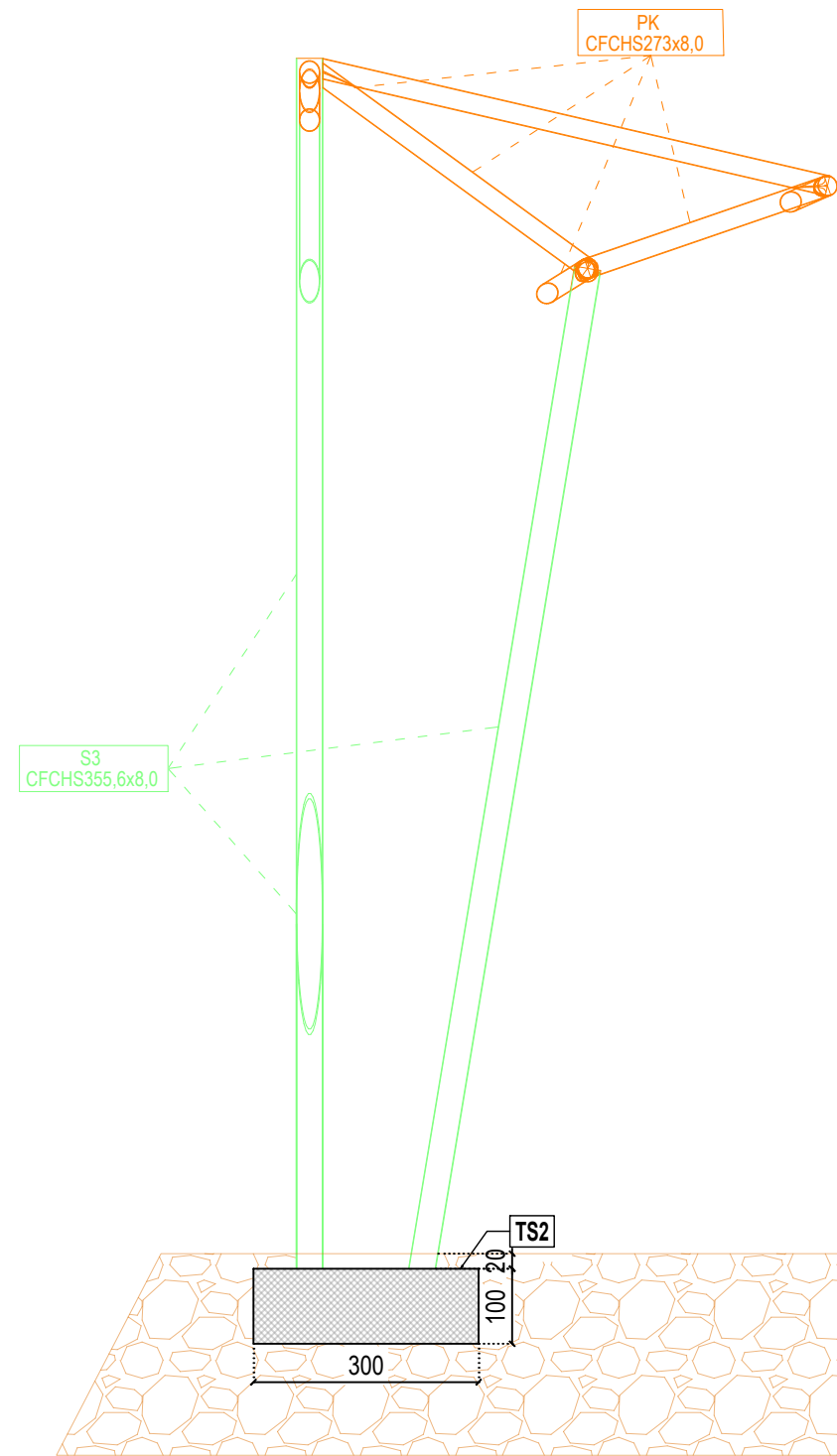

Presjek 2-2:

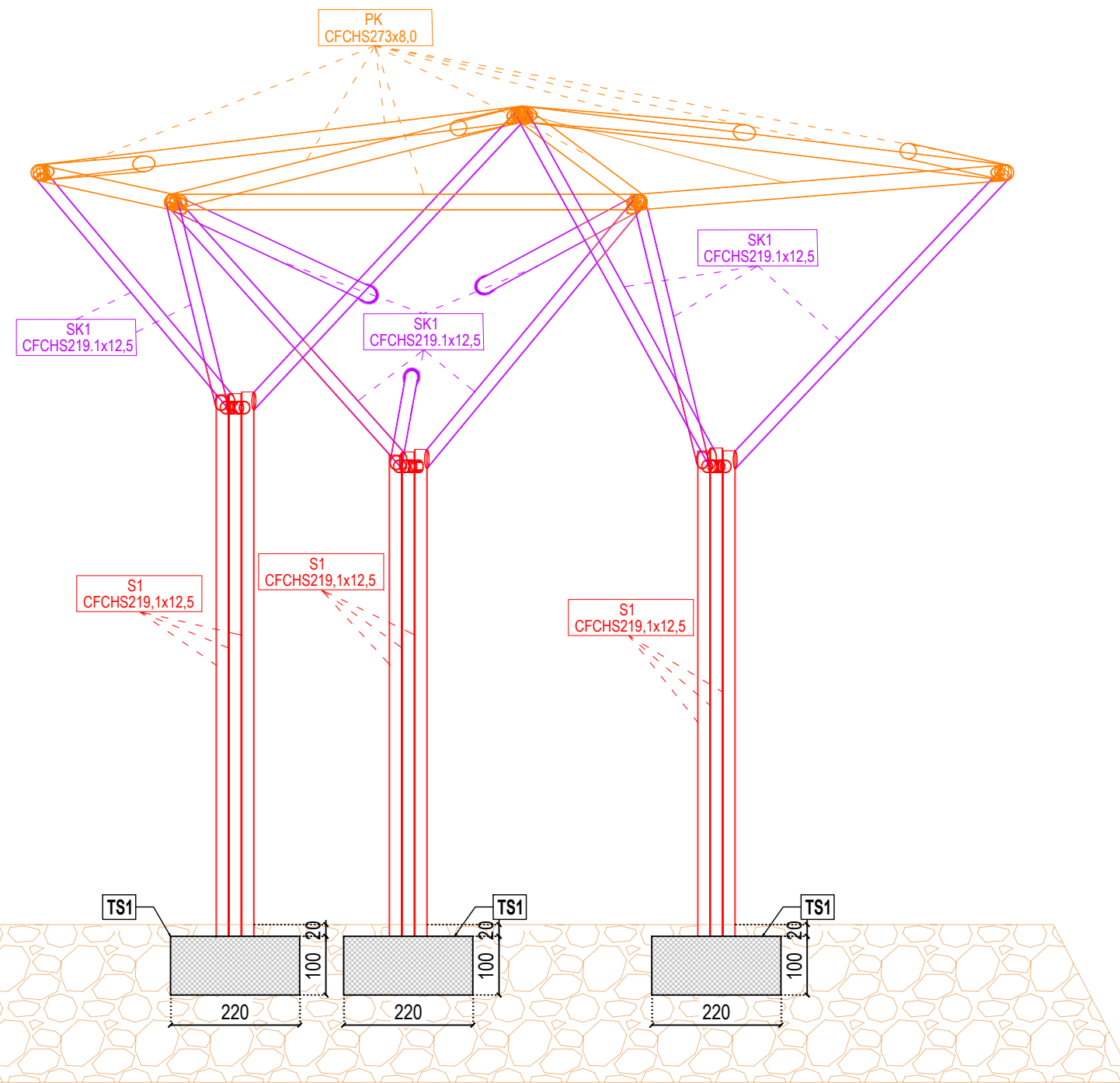

LEGENDA:

- S1 stup vanjske nadstrešnice ○ - CFCHS 219x12,5 (S355)
- S2 stup niskog dijela nadstrešnice ○ - CFCHS 355,6x8,0 (S355)
- S3 rubni stup nadstrešnice ○ - CFCHS 355,6x8,0 (S355)
- SK1 kosi dio stupa S1 ○ - CFCHS 219,1x12,5 (S355)
- PK krovni nosači ○ - CFCHS 273x8,0 (S355)

Dijela napomene:
 -Svi elementi od čelika S355,0
 -Svi elementi moraju se izvoditi prema HRN EN 1090-2
 -Klasa izvedbe: EXC1
 -Visine kate i dimenzije kontrolirati na licu mjesta
 -Zaštiti konstrukciju od korozije podinčavanjem

PRESJEK 1-1 I 2-2
 M 1:100

BETON: C 30/37
 ARMATURA: B500B
 KLASA IZLOŽENOSTI XC2, XF4
 ZAŠTITNI SLOJ: ≥ 3 5mm
 MAKSIMALNO ZRNO AGREGATA: 32mm

 SVEUČILIŠTE U SPLITU, FAKULTET GRAĐEVINARSTVA, ARHITEKTURE I GEODEZIJE	DIPLOMSKI RAD	
	TEMA: GLAVNI PROJEKT NADSTREŠNICE "KING CROSS"	
	MENTORICA: dr.sc. Ivica Boko	
	STUDENT: Filip Čoga	
	SADRŽAJ: Presjek 1-1 i 2-2	MJERILO: 1:100
DATUM: lipanj 2023.	BROJ PRILOGA: 5	

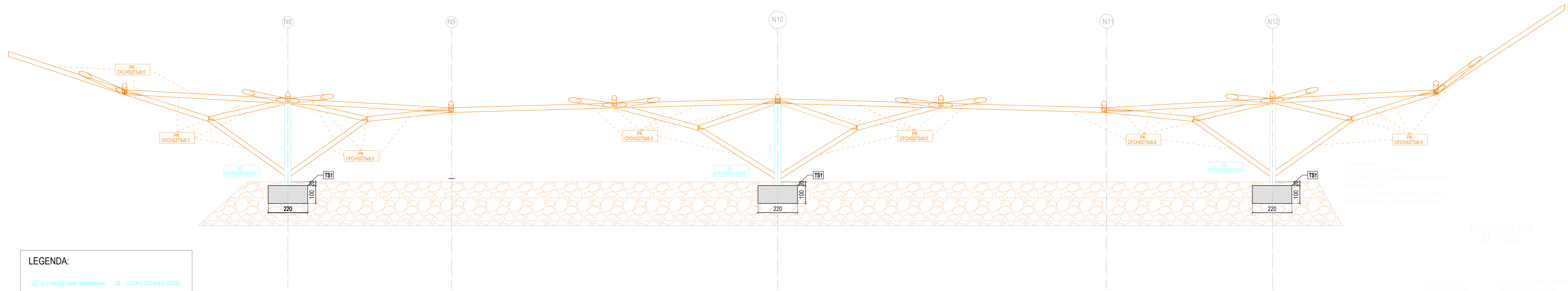

Opće napomene:
 - Svi elementi od čelika S355.0
 - Svi elementi izrađeni prema HRN EN 1090-2
 - Klasa čelika: S355
 - Dimenzije i dimenzije (područni na licu mesta)
 - Zaštita korozivnosti od korozije građevinske

PRESJEK 3-3
 M 1:100

BETON: C30/37
 ARMATURA: B500C
 KLASA IZIČIENOSTI: S355.0
 ZAŠTITNI SLOJ: c=3.5mm
 MAKIMALNO ZRNO AGREGATA: 32mm

LEGENDA:

S2	stup niskog dijela nadstrešnice	○	- CFCHS 355,6x8,0 (S355)
PK	krovni nosači	○	- CFCHS 273x8,0 (S355)

<p>SVEUČILIŠTE U SPLITU, FAKULTET GRAĐEVINARSTVA, ARHITEKTURE I GEODEZIJE</p>	DIPLOMSKI RAD	
	TEMA: GLAVNI PROJEKT NADSTREŠNICE "KING CROSS"	
	MENTORICA: dr.sc. Ivica Boko	
	STUDENT: Filip Čoga	
	SADRŽAJ: Presjek 3-3	MJERILO: 1:100
DATUM: lipanj 2023.		BROJ PRILOGA: 6

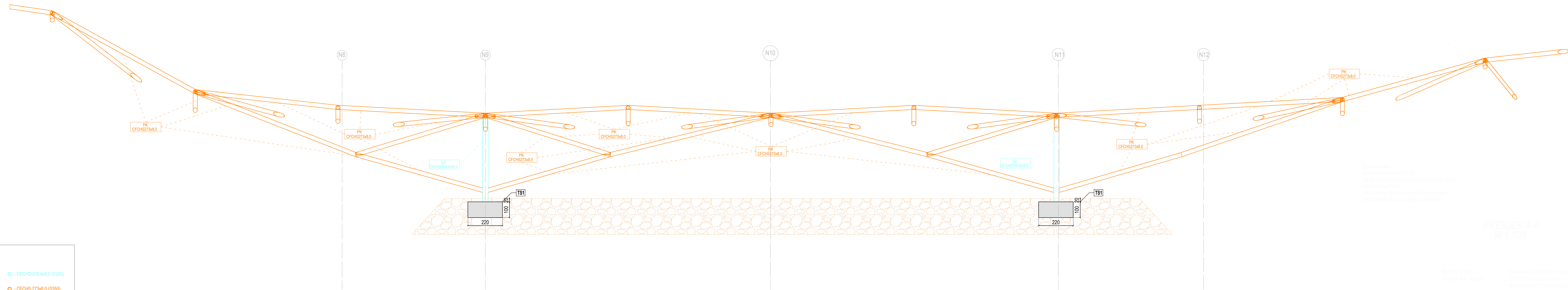

Opisni napomena:
 - Svi elementi su izrađeni od čelika S355/J2
 - Svi elementi nosači su izrađeni prema EN 1090-2
 - Aluina izvedba: EXC3
 - Vrijednosti i dimenzije komponenti su isti kao na slici
 - Čakovi konstrukcije su nastali prilikom izvođenja

PRESJEK 4-4
 M 1:100

BETON: C 20/25
 ARMATURA: S355/J2
 KLASA ISPOVJEDNOSTI: XC2, XF4
 ZAŠTITNI SLOJ: c=30mm
 MAXIMALNO ŽRNO AGREGATA: 12mm

LEGENDA:

S2 stup niskog dijela nadstrešnice	○ - CFCHS 355,6x8,0 (S355)
PK krovni nosači	○ - CFCHS 273x8,0 (S355)

 <p>SVEUČILIŠTE U SPLITU, FAKULTET GRAĐEVINARSTVA, ARHITEKTURE I INŽENJERINGA</p>	DIPLOMSKI RAD	
	TEMA:	GLAVNI PROJEKT NADSTREŠNICE "KING CROSS"
	MENTORICA:	dr.sc. Ivica Boko
	STUDENT:	Filip Čoga
SADRŽAJ:	Presjek 4-4	MJERILO: 1:100
BRIGADIR:		BRIGADIR: 7
DATUM:	lipanj 2023.	

8. Literatura

- [1] Androić, Dujmović, Džeba, Metalne konstrukcije 1, IGH Zagreb, 1994.
- [2] Androić, Dujmović, Džeba, Metalne konstrukcije 2, IA Projektiranje Zagreb, 1995.
- [3] Androić, Dujmović, Džeba, Metalne konstrukcije 3, IA Projektiranje Zagreb, 1995.