

# Proračun nosive konstrukcije zidane građevine

---

Pružer, Frane

Undergraduate thesis / Završni rad

2023

Degree Grantor / Ustanova koja je dodijelila akademski / stručni stupanj:

**University of Split, Faculty of Civil Engineering, Architecture and Geodesy / Sveučilište u Splitu, Fakultet građevinarstva, arhitekture i geodezije**

Permanent link / Trajna poveznica: <https://um.nsk.hr/um:nbn:hr:123:178204>

Rights / Prava: [In copyright](#)/[Zaštićeno autorskim pravom.](#)

Download date / Datum preuzimanja: **2025-02-12**



Repository / Repozitorij:

[FCEAG Repository - Repository of the Faculty of Civil Engineering, Architecture and Geodesy, University of Split](#)



UNIVERSITY OF SPLIT



**SVEUČILIŠTE U SPLITU  
FAKULTET GRAĐEVINARSTVA, ARHITEKTURE I GEODEZIJE**

# **ZAVRŠNI RAD**

**Frane Pruže**

**Split, 2023.**

**SVEUČILIŠTE U SPLITU  
FAKULTET GRAĐEVINARSTVA, ARHITEKTURE I GEODEZIJE**

## **Proračun nosive konstrukcije zidane građevine**

**Završni rad**

**Split, 2023.**

***Sažetak:***

U radu je prikazan proračun nosive zidane konstrukcije. Konstrukcija se sastoji od 3 etaže, prizemlja te 2 kata. Proračun sadrži dokaz nosivosti zidova na vertikalna opterećenja, dokaz nosivosti zidova na potres, određivanje širine temeljnih traka iz uvjeta nosivosti, te proračun međukatnih konstrukcija i određivanje potrebne armature.

***Ključne riječi:***

zidana konstrukcija, zid, temelj, međukatna konstrukcija, armatura, potres

## **Calculation of a load bearing masonry structure**

***Abstract:***

This paper presents the calculation of a load bearing masonry structure. The construction consists of three floors, ground floor and two floors. The calculation contains proof of the bearing capacity of the walls against earthquakes, the calculation of the width of the foundation strips from the load-bearing conditions, and the calculation of the interstory structures and the calculation of the reinforcement required.

***Keywords:***

masonry structure, wall, foundation, floor structure, reinforcement, earthquake

**SVEUČILIŠTE U SPLITU  
FAKULTET GRAĐEVINARSTVA, ARHITEKTURE I GEODEZIJE**

Split, Matice hrvatske 15

STUDIJ:               **PREDDIPLOMSKI STRUČNI STUDIJ GRAĐEVINARSTVA**  
KANDIDAT:         Frane Pruže  
MATIČNI BROJ (JMBAG): 0083221559  
KATEDRA:         **Katedra za teoriju konstrukcija**  
PREDMET:         Zidane konstrukcije

**ZADATAK ZA ZAVRŠNI RAD**

Tema: proračun nosive konstrukcije zidane građevine

Opis zadatka: Potrebno je izraditi proračun nosive konstrukcije zidane zgrade. Nosiva konstrukcija je zidana i omeđena serklažama. 1. i 2. etaža međukatne konstrukcije je AB ploča, a 3. etaža je sustav „bijeli strop“. Građevina se nalazi u potresnoj zoni gdje se očekuje vršno ubrzanje podloge  $a_g=0.23$  g s povratnim periodom od 475 godina. Proračunom je potrebno dokazati mehaničku otpornost i stabilnost konstrukcije u cjelini, kao i nekih tipičnih elemenata. Proračun treba provesti prema europskim normama EC1, EC6 i EC8, dopunjeno podacima o opterećenjima prema odgovarajućim hrvatskim normama i pravilnicima.

U Splitu, 13.09.2023.

Voditelj Završnog rada:

Dr. sc. Ivan Balić  
Dr. sc. Hrvoje Smoljanović

## SADRŽAJ

<b>1. TEHNIČKI OPIS .....</b>	<b>2.</b>
1.1 Općenito .....	2.
1.2 Opis nosive konstrukcije .....	2.
1.2.1 Temelji .....	2.
1.2.2 Zidovi .....	2.
1.2.3 Međukatne konstrukcije .....	2.
1.2.4 Ostale konstrukcije .....	3.
1.3 Osnovna djelovanja i kombinacije .....	3.
1.3.1 Osnovna djelovanja .....	3.
1.3.2 Osnovne kombinacije djelovanja .....	4.
<b>2. PRORAČUN HORIZONTALNIH KONSTRUKCIJA .....</b>	<b>5.</b>
2.1 Ploča POZ 100 i 200.....	5.
2.2 Ploča POZ 300 .....	9.
<b>3. PRORAČUN GREDA .....</b>	<b>13.</b>
3.1 Proračun potrebne armature u gredi u osi 2 i 4 za POZ 100 i 200 .....	13.
3.2 Proračun potrebne armature u gredi u osi 2 i 4 za POZ 300 .....	18.
<b>4. PRORAČUN ZIDOVA .....</b>	<b>23.</b>
4.1 Proračun zidova na vertikalna opterećenja .....	23.
4.1.1 Podaci za proračun zidova .....	23.
4.2 Proračun zidova na potres .....	31.
4.2.1 Proračun ukupne potresne sile .....	33.
4.2.2 Razdioba ukupne potresne sile po zidovima .....	33.
4.2.3 Razdioba ukupne potresne sile po zidovima .....	33.
4.2.4 Proračun zidova na potres .....	35.
<b>5. PRORAČUN TEMELJA .....</b>	<b>45.</b>
5.1 Temeljna traka u osi 1 .....	45.
5.2 Temeljna traka u osi 2 .....	45.
5.3 Temeljna traka u osi 3 .....	46.
5.4 Temeljna traka u osi 4 .....	46.
5.5 Temeljna traka u osi 5 .....	47.
5.6 Temeljna traka u osi A .....	47.
5.7 Temeljna traka u osi B .....	48.
5.8 Temeljna traka u osi C .....	48.
5.9 Temeljna traka u osi D .....	49.
5.10 Temeljna traka u osi E .....	49.
<b>6. GRAĐEVINSKI NACRTI .....</b>	<b>50.</b>

# 1. TEHNIČKI OPIS

## 1.1 Općenito

Predmet ovog Završnog rada je proračun nosive konstrukcije.

Građevina je troetažna, nepravilnog tlocrtnog oblika. Ukupna bruto površina građevine iznosi 535.95 m<sup>2</sup>, a ukupna visina 9.40 m, mjereno od podne ploče prizemlja. Građevina se nalazi u potresnoj zoni gdje se očekuje vršno ubrzanje podloge  $a_g=0.23$  g s povratnim periodom od 475 godina, II. području opterećenja vjetrom i području D opterećenja snijegom.

Međukatna konstrukcija iznad 1. i 2. etaže je armirano-betonska ploča, a iznad 3. etaže sitnorebrasta - sustava BIJELI STROP. Konstrukcija temelja je armirano-betonska, a sastoji se od: temeljnih traka, nadtemeljnih zidova i podne ploče prizemlja.

## 1.2 Opis nosive konstrukcije

### 1.2.1 Temelji

Računska nosivost tla iznosi  $\sigma_{R,d}=250$  kPa, što je nakon iskopa temelja potrebno utvrditi ispitivanjem. Temeljne trake izvesti (visine  $h=50$ ) izvesti od betona C30/37, armirati s B-500. Nadtemeljne zidove ( $d=35$  cm) i podnu ploču ( $d=15$  cm) izvesti od betona C30/37, armirati s B-500.

### 1.2.2 Zidovi

Nosive zidove zidati od blok opeke u vapneno-cementnom mortu (mort opće namjene). Zidovi su debljine  $t=25$  cm, a omeđeni su vertikalnim i horizontalnim serklažima.

Svojstva blok opeke i morta:

Grupa zidnih elemenata: 2

Srednja tlačna čvrstoća bloka:  $f_{b,min}=9.0$  N/mm<sup>2</sup>

Razred izvedbe: 2; zidni elementi kategorije I., propisani mort (mort zadanog sastava)

Za zidanje rabiti produžni mort marke M10 ( $f_m=10.0$  N/mm<sup>2</sup>), kojemu odgovara slijedeći volumni sastav:

cement :

hidratizirano vapno : pijesak = 1 : ( $\frac{1}{4}$  -  $\frac{1}{2}$ ) : (4 - 4 $\frac{1}{4}$ )

Obvezno je popunjavanje mortom horizontalnih i uspravnih sljubnica između zidnih blokova.

### 1.2.3 Međukatne konstrukcije

Međukatnu konstrukciju iznad 1. i 2. etaže izvesti kao a-b ploču debljine 15 cm, od betona C25/30 i armirati s B-500. Horizontalne serklaže ( $b/h=25/25$  cm) izvesti zajedno s pločom, od betona C25/30 i armirati s B-500.

Međukatnu konstrukciju iznad 3. etaže izraditi kao lakobetonsku roštiljnu konstrukciju - Bijeli strop, koju čine a-b gredice na osnovom razmaku od 65 cm s ispunom od porobetonskih blokova. Osnovnu armaturu gređica čini dvostruki rešetkasti nosač 7/7/4 mm čvrstoće čelika B-500 i šipkasta armatura B-500, određena proračunom. Poprečna rebra izvesti na osnovom razmaku min. 104 cm (4 reda ispuna), širine 4 cm i armirati s po  $\phi 10$  u gornjoj i donjoj zoni. Konstrukciju monolitizirati ispunjavanjem rebara glavnih i poprečnih nosača sitnozrnim betonom C25/30, a dan nakon cijelu gornju krovnu plohu zaliti rijetkom smjesom tankoslojnog morta i cementa u omjeru 1:1.

### 1.2.4 Ostale konstrukcije

Vertikalne i horizontalne serklaže izvesti od betona C30/37 i armirati s B-500. Sve vertikalne serklaže izbetonirati nakon zidanja zida. Moguće je ugraditi posebne blokove koji oblikuju oplatu serklaža. Horizontalne serklaže izvesti u razini međukatnih konstrukcija od betona C30/37 i armirati s B-500.

## 1.3 Osnovna djelovanja i kombinacije

### 1.3.1 Osnovna djelovanja

Osnovna djelovanja, na čiji utjecaj se dokazuje mehanička otpornost i stabilnost predmetne građevine, podijeljena su prema slijedećem:

Oznaka osnovnog djelovanja	Opis djelovanja
<b>G</b>	<b>Stalno djelovanje.</b> Vlastita težina elemenata nosive konstrukcije, obloga (podovi, žbuke), stalna oprema itd.
<b>Q1</b>	<b>Promjenjivo djelovanje:</b> sobe, dnevni boravak, kuhinja,..... 1.50 kN/m <sup>2</sup> stubište 3.00 kN/m <sup>2</sup> balkonske ploče 4.00 kN/m <sup>2</sup>
<b>Q2</b>	<b>Snijeg:</b> područje opterećenja snijegom: D nadmorska visina: ≤ 100 m.n.m. karakteristična vrijednost snijega na tlu: $s_k=0.35$ kN/m <sup>2</sup> opterećenje snijegom na krovu: $s=\mu_i C_e C_{t s k}=0.8*1.0*1.0*0.35= s=0.28$ kN/m <sup>2</sup> Napomena: Za opterećenje krova mjerodavno je korisno opterećenje od $q=1.5$ kN/m <sup>2</sup>
<b>Q3</b>	<b>Vjetar:</b> područje II. $v_{ref,0} = 30$ m/s koeficijent položaja ( $h \approx 10$ m, III. kategorija zemljišta): $c_e(z) = 2.0$ poredbeni tlak: $q_{ref} = \rho_{zraka} * v^2 / 2 = 1.25 * (30^2) / 2 / 1000 =$ $q_{ref} = 0.56$ kN/m <sup>2</sup> koeficijent vanjskog tlaka: $c_{pe} \approx 0.8$ koeficijent unutarnjeg tlaka: $c_{pi} \approx 0.3$ tlak vjetra na vanjske vertikalne površine: $w_e = q_{ref} * c_e(z) * c_{pe} = 0.56 * 2.0 * 0.8 =$ $w_e = 0.90$ kN/m <sup>2</sup> tlak vjetra na unutarnje vertikalne površine: $w_i = q_{ref} * c_e(z) * c_{pi} = 0.56 * 2.0 * 0.4 =$ $w_i = 0.45$ kN/m <sup>2</sup>
<b>S</b>	<b>Potres:</b> računsko ubrzanje tla: $a_g = 2.0$ m/s <sup>2</sup> razred tla: B faktor ponašanja (za zide): 2.5 faktor važnosti građevine: $\gamma_I = 1.0$



## 1.3.2 Osnovne kombinacije djelovanja

## Granično stanje uporabljivosti

Oznaka kombinacije	Parcijalni faktor za opterećenje	Koristi se za:	Parcijalni faktor za materijale
<b>GSU-1</b>	osnovna kombinacija: <b>1.0G+1.0Q1</b>	proračun progiba a-b ploča, kontrola naprezanja u tlu	ziđe: $\gamma_M=1.0$ beton: $\gamma_c=1.0$ čelik: $\gamma_s=1.0$

## Granično stanje nosivosti

Oznaka kombinacije	Parcijalni faktor za opterećenje	Koristi se za:	Parcijalni faktor za materijale
<b>GS N-1</b>	osnovna kombinacija: <b>1.35G+1.5Q1</b>	proračun ploča i zidova na vertikalna djelovanja	ziđe: $\gamma_M=2.2$ beton: $\gamma_c=1.5$ čelik: $\gamma_s=1.15$
<b>GS N-2</b>	potres: <b>1.0G+1.0S+0.3Q1</b>	proračun zidova na djelovanje potresa	ziđe: $\gamma_M=1.5$ beton: $\gamma_c=1.5$ čelik: $\gamma_s=1.15$

## 2. PRORAČUN HORIZONTALNIH KONSTRUKCIJA

### 2.1 Ploče POZ 100 i 200 (a-b ploča)

Opterećenje:

**Stalno + dodatno stalno djelovanje:**

pregradni zidovi  $0.50 \text{ kN/m}^2$

završni sloj poda  $0.50 \text{ kN/m}^2$

a-c estrih;  $d=6 \text{ cm}$ ;  $\gamma=22 \text{ kN/m}^3$

$1.32 \text{ kN/m}^2$

međukatna konstrukcija - a-b ploča;  $d=15 \text{ cm}$ ;  $\gamma=25 \text{ kN/m}^3$   $3.75 \text{ kN/m}^2$

**ukupno stalno djelovanje:  $g=6.10 \text{ kN/m}^2$**

**Promjenjivo djelovanje:**

sobe, dnevni boravak, kuhinja,...:  **$q=1.50 \text{ kN/m}^2$**

stubište:  **$q=3.00 \text{ kN/m}^2$**

balkoni:  **$q=4.00 \text{ kN/m}^2$**

Proračunski model ploče:

- ploča je modelirana plošnim elementima debljine  $d=15 \text{ cm}$
- ploča je slobodno oslonjena na zidove i horizontalne serklaže
- beton: C25/30; armatura: B500;  $E=30.5 \text{ GPa}$

Poprečni presjek ploče

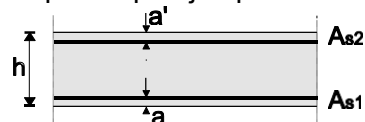

**$h=15 \text{ cm}$**

zaštitni sloj:  $a=a'=2.0 \text{ cm}$

$d=12.0 \text{ cm}$

Beton: **C 30/37**

$f_{ck}=30.0 \text{ MPa}$

$E_{cm}=32.8 \text{ GPa}$

$\gamma_c=1.5$

Armatura: **B 500B**

$f_y=500 \text{ MPa}$

$\gamma_s=1.15$

**Limitirajući moment savijanja:**

$$M_{Rd,lim}=0.159*(b_w*d^2)*f_{cd}$$

$$M_{Rd,lim}=0.159*(1.0*0.120^2)*(30/1.5)*1000=45.8 \text{ kNm}$$

**Min. i max. % armature za ploče:**

$$A_{s,min}=0.0015*b*d=0.0015*100*12.0=1.80 \text{ cm}^2/\text{m}$$

$$A_{s,min}=0.6*b*d/f_{yk}=0.6*100*12.0/500=1.44 \text{ cm}^2/\text{m}$$

$$A_{s,max}=0.31*b*d*(f_{cd}/f_{yd})=0.31*100*12.0*(30/1.5)/(500/1.15)=17.11 \text{ cm}^2/\text{m}$$

**Proračun armature:**

Za proračun armature ploča usvaja se  $\zeta \approx 0.9$ . Potrebna armatura:

$$A_s = M_{Ed} * 100 / (\zeta * d * f_{yd}) = M_{Ed} * 100 / (0.9 * 12.0 * (50/1.15)) = M_{Ed} * 0.21$$

$$A_s = 0.21 * 1.35 * G + 0.21 * 1.5 * Q1 = 0.28 * G + 0.32 * Q1$$

*Napomene:*

-Prethodni izraz vrijedi za moment  $M_{Ed}$  u [kNm] i armaturu  $A_s$  u [cm<sup>2</sup>].

-Armaturu u polju zbog preraspodjele povećati 30 %.

### Ploča pozicije 101/201

#### Shema 2

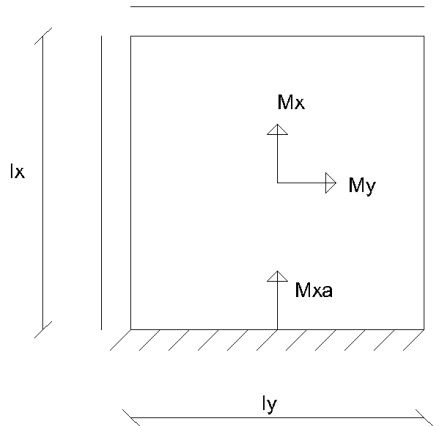

$$l_x = 5.4 \text{ m} ; l_y = 9.7 \text{ m}$$

$$l_y / l_x = 9.7 / 5.4 = 1.80$$

#### Analiza opterećenja

$$p = 1.35 \cdot g + 1.5 \cdot q$$

$$p = 1.35 \cdot 6.1 + 1.5 \cdot 1.5 = 10.49 \text{ kN/m}^2$$

#### Proračun momenata

$$k_x = 0.0572 ; k_y = 0.0052$$

$$k_{xa} = -0.1184$$

$$M_x = k_x \cdot p \cdot l_x^2 = 0.0572 \cdot 10.49 \cdot 5.4^2 = 17.49 \text{ kNm/m}$$

$$M_y = k_y \cdot p \cdot l_y^2 = 0.0052 \cdot 10.49 \cdot 9.7^2 = 5.13 \text{ kNm/m}$$

$$M_{xa} = k_{xa} \cdot p \cdot l_x^2 = -0.1184 \cdot 10.49 \cdot 5.4^2 = -36.22 \text{ kNm/m}$$

#### Proračun armature

$$A_{sx} = M_x \cdot 100 / (0.9 \cdot d \cdot f_{yd})$$

$$A_{sx} = (17.49 \cdot 100) / (0.9 \cdot 12 \cdot 43.48) = 3.72 \text{ cm}^2/\text{m}$$

$$A_{sy} = M_y \cdot 100 / (0.9 \cdot d \cdot f_{yd})$$

$$A_{sy} = (5.13 \cdot 100) / (0.9 \cdot 12 \cdot 43.48) = 1.09 \text{ cm}^2/\text{m}$$

$$A_{sxa} = M_{xa} \cdot 100 / (0.9 \cdot d \cdot f_{yd})$$

$$A_{sxa} = (36.22 \cdot 100) / (0.9 \cdot 12 \cdot 43.48) = 7.71 \text{ cm}^2/\text{m}$$

### Ploča pozicije 102/202

#### Shema 3

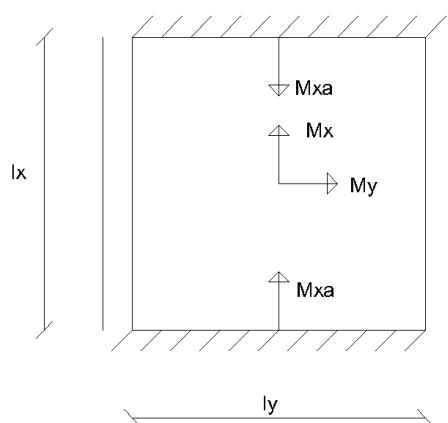

$$l_x = 6.4 \text{ m} ; l_y = 7.9 \text{ m}$$

$$l_y / l_x = 7.9 / 6.4 = 1.23$$

#### Analiza opterećenja

$$p = 1.35 \cdot g + 1.5 \cdot q$$

$$p = 1.35 \cdot 6.1 + 1.5 \cdot 1.5 = 10.49 \text{ kN/m}^2$$

#### Proračun momenata

$$k_x = 0.0357 ; k_y = 0.0113$$

$$k_{xa} = -0.0770$$

$$M_x = k_x \cdot p \cdot l_x^2 = 0.0357 \cdot 10.49 \cdot 6.4^2 = 21.79 \text{ kNm/m}$$

$$M_y = k_y \cdot p \cdot l_y^2 = 0.0113 \cdot 10.49 \cdot 7.9^2 = 7.40 \text{ kNm/m}$$

$$M_{xa} = k_{xa} \cdot p \cdot l_x^2 = -0.0770 \cdot 10.49 \cdot 6.4^2 = -33.08 \text{ kNm/m}$$

#### Proračun armature

$$A_{sx} = M_x \cdot 100 / (0.9 \cdot d \cdot f_{yd})$$

$$A_{sx} = (21.79 \cdot 100) / (0.9 \cdot 12 \cdot 43.48) = 4.64 \text{ cm}^2/\text{m}$$

$$A_{sy} = M_y \cdot 100 / (0.9 \cdot d \cdot f_{yd})$$

$$A_{sy} = (7.4 \cdot 100) / (0.9 \cdot 12 \cdot 43.48) = 1.57 \text{ cm}^2/\text{m}$$

$$A_{sxa} = M_{xa} \cdot 100 / (0.9 \cdot d \cdot f_{yd})$$

$$A_{sxa} = (33.08 \cdot 100) / (0.9 \cdot 12 \cdot 43.48) = 7.04 \text{ cm}^2/\text{m}$$

## Ploča pozicije 103/203

### Shema 2

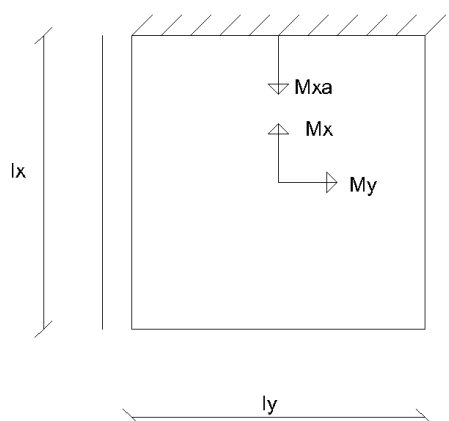

$$l_x = 5.1 \text{ m} ; l_y = 9.8 \text{ m}$$

$$l_y / l_x = 9.8 / 5.1 = 1.92$$

#### **Analiza opterećenja**

$$p = 1.35 \cdot g + 1.5 \cdot q$$

$$p = 1.35 \cdot 6.1 + 1.5 \cdot 1.5 = 10.49 \text{ kN/m}^2$$

#### **Proračun momenata**

$$k_x = 0.0586 ; k_y = 0.0044$$

$$k_{xa} = -0.1203$$

$$M_x = k_x \cdot p \cdot l_x^2 = 0.0586 \cdot 10.49 \cdot 5.1^2 = 15.99 \text{ kNm/m}$$

$$M_y = k_y \cdot p \cdot l_y^2 = 0.0044 \cdot 10.49 \cdot 9.8^2 = 4.43 \text{ kNm/m}$$

$$M_{xa} = k_{xa} \cdot p \cdot l_x^2 = -0.1203 \cdot 10.49 \cdot 5.1^2 = -32.82 \text{ kNm/m}$$

#### **Proračun armature**

$$A_{sx} = M_x \cdot 100 / (0.9 \cdot d \cdot f_{yd})$$



$$A_{sx} = (15.99 \cdot 100) / (0.9 \cdot 12 \cdot 43.48) = 3.41 \text{ cm}^2/\text{m}$$

$$A_{sy} = M_y \cdot 100 / (0.9 \cdot d \cdot f_{yd})$$

$$A_{sy} = (4.43 \cdot 100) / (0.9 \cdot 12 \cdot 43.48) = 0.94 \text{ cm}^2/\text{m}$$

$$A_{sxa} = M_{xa} \cdot 100 / (0.9 \cdot d \cdot f_{yd})$$

$$A_{sxa} = (32.82 \cdot 100) / (0.9 \cdot 12 \cdot 43.48) = 6.99 \text{ cm}^2/\text{m}$$

 **upeti rub**  
 **slobodno oslonjeni rub**

$q$  – jednoliko raspodijeljeno opterećenje  
 Poissonov koeficijent = 0.15

$M_x = k_x \cdot q \cdot l_x^2$  ;  $M_x^a = k_x^a \cdot q \cdot l_x^2$   
 $M_y = k_y \cdot q \cdot l_y^2$  ;  $M_y^b = k_y^b \cdot q \cdot l_y^2$

Schema 1		Schema 2		Schema 3		Schema 4		Schema 5		Schema 6		
$l_y/l_x$	$k_x$	$k_y$	$k_x$	$k_y$	$k_x$	$k_y$	$k_x$	$k_y$	$k_x$	$k_y$	$k_x$	$k_y$
0.50	0.0079	0.0991	0.0084	0.0908	0.0084	0.0570	-0.0205	-0.1189	0.0048	0.0560	-0.0203	-0.1135
0.55	0.0103	0.0923	0.0109	0.0826	0.0054	0.0543	-0.0249	-0.1148	0.0062	0.0514	-0.0247	-0.1078
0.60	0.0131	0.0857	0.0135	0.0747	0.0072	0.0514	-0.0294	-0.1104	0.0081	0.0476	-0.0291	-0.1021
0.65	0.0162	0.0792	0.0162	0.0670	0.0092	0.0483	-0.0341	-0.1057	0.0101	0.0436	-0.0336	-0.0964
0.70	0.0194	0.0730	0.0194	0.0599	0.0114	0.0451	-0.0390	-0.1008	0.0122	0.0398	-0.0381	-0.0906
0.75	0.0230	0.0669	0.0221	0.0533	0.0139	0.0418	-0.0442	-0.0957	0.0145	0.0359	-0.0427	-0.0845
0.80	0.0269	0.0611	0.0249	0.0472	0.0164	0.0385	-0.0496	-0.0905	0.0169	0.0323	-0.0471	-0.0781
0.85	0.0307	0.0577	0.0277	0.0417	0.0191	0.0354	-0.0548	-0.0852	0.0191	0.0289	-0.0513	-0.0720
0.90	0.0344	0.0507	0.0304	0.0369	0.0217	0.0324	-0.0598	-0.0798	0.0211	0.0257	-0.0551	-0.0661
0.95	0.0383	0.0462	0.0330	0.0327	0.0243	0.0295	-0.0648	-0.0745	0.0232	0.0228	-0.0586	-0.0603
1.00	0.0423	0.0423	0.0354	0.0291	0.0269	0.0269	-0.0699	-0.0699	0.0252	0.0202	-0.0517	-0.0546
1.10	0.0500	0.0353	0.0399	0.0288	0.0288	0.0288	-0.0717	-0.0680	0.0287	0.0158	-0.0676	-0.0467
1.20	0.0575	0.0293	0.0438	0.0180	0.0365	0.0182	-0.0869	-0.0530	0.0316	0.0123	-0.0722	-0.0399
1.30	0.0644	0.0244	0.0471	0.0143	0.0406	0.0148	-0.0937	-0.0462	0.0340	0.0096	-0.0757	-0.0341
1.40	0.0710	0.0204	0.0500	0.0115	0.0442	0.0122	-0.0993	-0.0405	0.0359	0.0075	-0.0782	-0.0293
1.50	0.0722	0.0173	0.0524	0.0094	0.0473	0.0100	-0.1041	-0.0358	0.0374	0.0060	-0.0800	-0.0254
1.60	0.0826	0.0146	0.0544	0.0076	0.0499	0.0081	-0.1082	-0.0317	0.0386	0.0048	-0.0814	-0.0221
1.70	0.0874	0.0124	0.0561	0.0062	0.0521	0.0066	-0.1116	-0.0282	0.0395	0.0039	-0.0825	-0.0193
1.80	0.0916	0.0107	0.0572	0.0052	0.0540	0.0055	-0.1143	-0.0252	0.0402	0.0031	-0.0834	-0.0171
1.90	0.0954	0.0091	0.0586	0.0044	0.0556	0.0046	-0.1167	-0.0226	0.0408	0.0026	-0.0842	-0.0154
2.00	0.0991	0.0079	0.0594	0.0037	0.0570	0.0040	-0.1189	-0.0205	0.0412	0.0022	-0.0847	-0.0141
Množitelj	$q \cdot l_x^2$	$q \cdot l_y^2$	$q \cdot l_x^2$	$q \cdot l_y^2$	$q \cdot l_x^2$	$q \cdot l_y^2$	$q \cdot l_x^2$	$q \cdot l_y^2$	$q \cdot l_x^2$	$q \cdot l_y^2$	$q \cdot l_x^2$	$q \cdot l_y^2$

## 2.2 Ploča POZ 300 (bijeli strop)

Međukatna konstrukcija POZ 300 je sitnorebrasti stropni sustav s lakobetonskom ispunom.

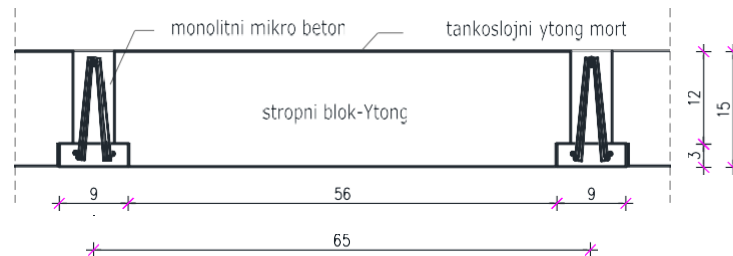

Poprečni presjek stropnog sustava 'bijeli strop – osnovni sustav'

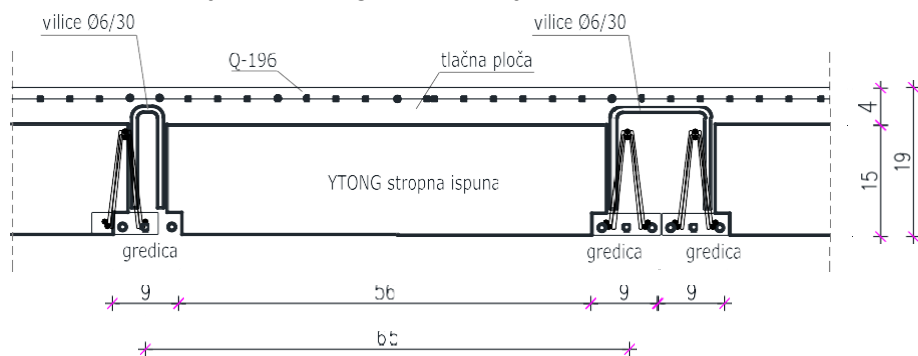

Poprečni presjek stropnog sustava 'bijeli strop – sustav sa tlačnom pločom debljine 4 cm

### Djelovanje:

#### Stalno djelovanje:

izolacije, instalacije, žbuka  $0.50 \text{ kN/m}^2$

beton za pad;  $d=5-10 \text{ cm}$ ;  $\gamma=22.0 \text{ kN/m}^3$ ;  $0.075 \cdot 22.0 = 1.65 \text{ kN/m}^2$

tlačna AB ploča;  $d=4 \text{ cm}$ ;  $\gamma=25.0 \text{ kN/m}^3$ ;  $0.04 \cdot 25.0 = 1.00 \text{ kN/m}^2$

međukatna konstrukcija - bijeli strop  $1.30 \text{ kN/m}^2$

$g=4.45 \text{ kN/m}^2$

**Promjenjivo djelovanje** (neprohodni krov):  $q=1.50 \text{ kN/m}^2$

Računsko djelovanje:  $q_{sd}=1.35 \cdot 4.45 + 1.5 \cdot 1.5 = 8.26 \text{ kN/m}^2$

### Poprečni presjek ploče

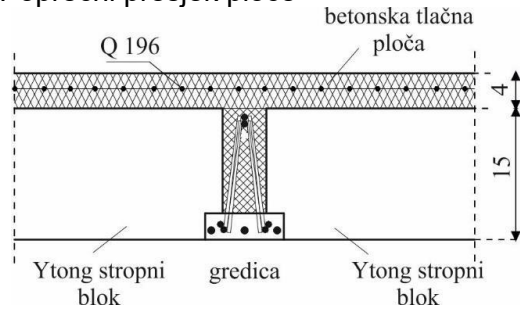

Statička visina:  $d=17.5$  cm

Krak sila:  $z \approx 15.5$  cm

Razmak gredica:  $b_w = 65$  cm

Beton: **C 30/37**

$f_{ck} = 30.0$  MPa

$E_{cm} = 32.8$  GPa

$\gamma_c = 1.5$

Armatura: **B 500B**

$f_y = 500$  MPa

$\gamma_s = 1.15$

### Limitirajući moment savijanja:

$$M_{Rd,lim} = 0.159 \cdot (b_w \cdot d^2) \cdot f_{cd}$$

$$M_{Rd,lim} = 0.159 \cdot (0.65 \cdot 0.175^2) \cdot (30/1.5) \cdot 1000 = 63.3 \text{ kNm}$$

### Nosivost na poprečnu silu bez udjela betona:

Dijagonale:  $4\Phi 4$

$$V_{Rd} = \frac{D^2 \cdot \pi}{4} \cdot 4 \cdot f_{yd} \cdot \cos(45) =$$

$$V_{Rd} = (0.4^2 \cdot 3.14/4) \cdot 4 \cdot 43.48 \cdot 0.707 = 15.44 \text{ kN}$$

### Proračun armature u donjoj zoni gredice:

$$A_s = M_{Ed} \cdot 100 / (z \cdot f_{yd}) = M_{Ed} \cdot 100 / (15.5 \cdot (50/1.15)) = M_{Ed} \cdot 0.15$$

*Napomene:*

-Prethodni izraz vrijedi za moment

$M_{Ed}$  u [kNm] i armaturu  $A_s$  u [cm<sup>2</sup>].

### Ploča pozicije 301

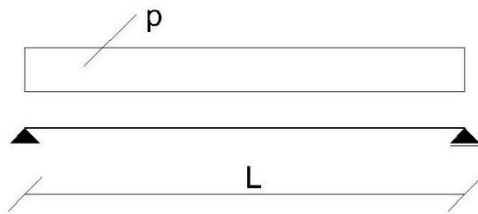

$L=5.4$  m; razmak gredica 65 cm

**Analiza opterećenja:**

$$p = (1.35 \cdot 4.45 + 1.5 \cdot 1.5) \cdot 0.65 = 5.37 \text{ kN/m}$$

**Rezne sile:**

$$M_{Ed} = p \cdot L^2 / 8 = 5.37 \cdot 5.1^2 / 8 = 19.57 \text{ kNm}$$

**Armatura:**

$$A_s = M_{Ed} \cdot 100 / (z \cdot f_{yd}) = 19.57 \cdot 100 / (15.5 \cdot 43.48)$$

$$A_s = 2.91 \text{ cm}^2$$

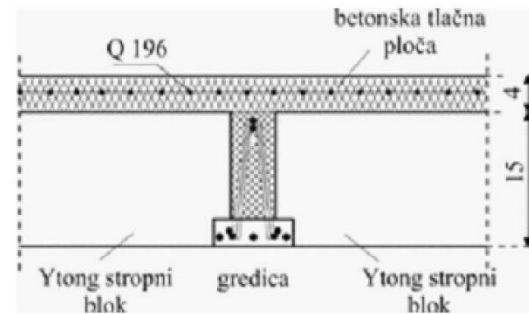

Krak sila  $z \approx 15.5$  cm

Armatura: **B 500B**

$f_y = 500$  MPa

$\gamma_s = 1.15$

### Ploča pozicije 302

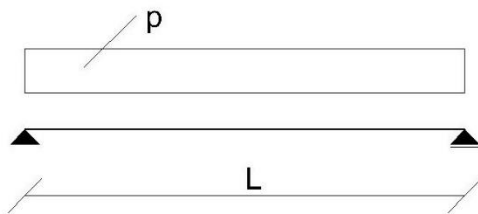

$L=6.4$  m; razmak gredica 65 cm

**Analiza opterećenja:**

$$p = (1.35 \cdot 4.45 + 1.5 \cdot 1.5) \cdot 0.65 = 5.37 \text{ kN/m}$$

**Rezne sile:**

$$M_{Ed} = p \cdot L^2 / 8 = 5.37 \cdot 6.4^2 / 8 = 27.49 \text{ kNm}$$

**Armatura:**

$$A_s = M_{Ed} \cdot 100 / (z \cdot f_{yd}) = 27.49 \cdot 100 / (15.5 \cdot 43.48)$$

$$A_s = 4.08 \text{ cm}^2$$

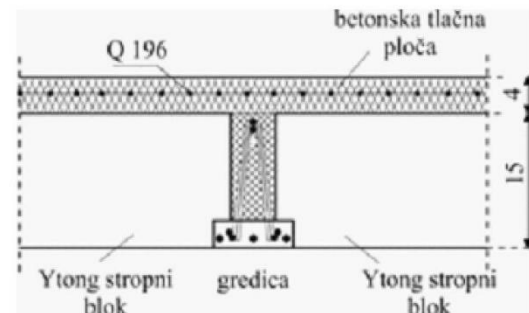

Krak sila  $z \approx 15.5$  cm

Armatura: **B 500B**

$f_y = 500$  MPa

$\gamma_s = 1.15$



### Ploča pozicije 303

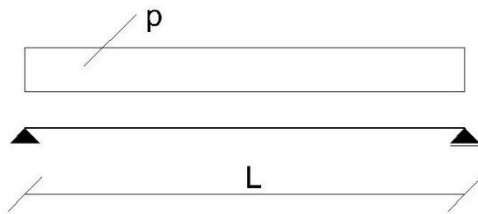

$L=5.1$  m; razmak gredica 65 cm

**Analiza opterećenja:**

$$p = (1.35 \cdot 4.45 + 1.5 \cdot 1.5) \cdot 0.65 = 5.37 \text{ kN/m}$$

**Rezne sile:**

$$M_{Ed} = p \cdot L^2 / 8 = 5.37 \cdot 5.1^2 / 8 = 17.46 \text{ kNm}$$

**Armatura:**

$$A_s = M_{Ed} \cdot 100 / (z \cdot f_{yd}) = 17.46 \cdot 100 / (15.5 \cdot 43.48)$$

$$A_s = 2.59 \text{ cm}^2$$

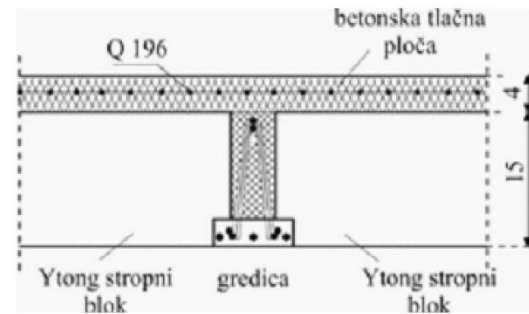

Krak sila  $z \approx 15.5$  cm

Armatura: **B 500B**

$f_y = 500$  MPa

$\gamma_s = 1.15$

### 3. PRORAČUN GREDA

#### 3.1. Proračun potrebne armature u gredi u osi 2 i 4 za POZ 100 i 200

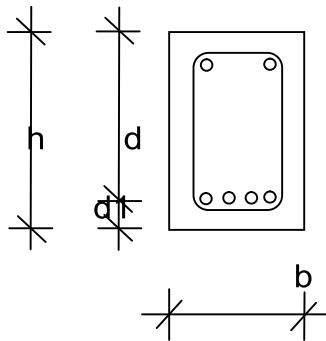

$h_f = 15 \text{ cm}$  – debljina ploče

$$h = \frac{0.85 \cdot L}{10} = \frac{0.85 \cdot 338}{10} = 28,7 \text{ cm} \rightarrow \text{odabrano } h = 35 \text{ cm (manje ne zadovoljava)}$$

$b_w = 25 \text{ cm}$

$d = 35 - 5 = 30 \text{ cm}$

$\gamma_c = 25 \text{ kN/m}^3$

$$g_{gr} = b_w \cdot h \cdot \gamma_c = 0,25 \cdot 0,35 \cdot 25 = 2.19 \text{ kN/m}$$

Proračunski model

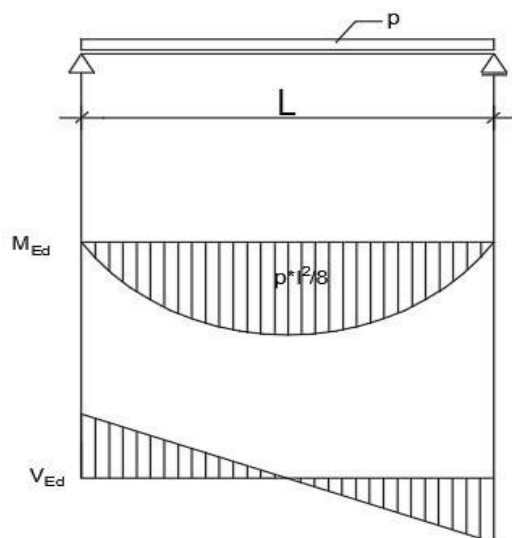

$L = 3.38 \text{ m}$

### Analiza opterećenja

$$g_{\text{ploče}}=6.10 \text{ kN/m}^2$$

$$q_{\text{ploče}}=1.5 \text{ kN/m}^2$$

### Utjecajna širina grede:

$$B=4.31 \text{ m}$$

### opterećenje od ploče

#### stalno opterećenje:

$$g_{\text{ekv}}=g \cdot B=6.10 \cdot 4.31= 26.29 \text{ kN/m}$$

#### promjenjivo opterećenje:

$$q_{\text{ekv}}=q \cdot B=1.5 \cdot 4.31= 6.47 \text{ kN/m}$$

### opterećenje vlastite težine na gredu

$$g_{\text{gr}}=b \cdot h \cdot \gamma_c=0.25 \cdot 0.35 \cdot 25 = 2.19 \text{ kN/m}$$

### Ukupno opterećenje

$$g_{\text{uk}}=g_{\text{ekv}}+g_{\text{gr}}=26.29+2.19 = 28.48 \text{ kN/m}$$

$$q_{\text{uk}}=q_{\text{ekv}}=6.47 \text{ kN/m}$$

$$p= 1.35 \cdot g+1.5 \cdot q$$

$$p= 1.35 \cdot 28.48+1.5 \cdot 6.47=48.15 \text{ kN/m}^2$$

### Proračun momenata

$$M_{\text{Ed}}=p \cdot L^2/ 8 = 48,15 \cdot 3.38^2/ 8 = 68.76 \text{ kNm/m}$$

### Proračun vertikalne sile

$$V_{\text{Ed}}=p \cdot L/2=48.15 \cdot 3.38/2=81.37 \text{ kN}$$

### Dimenzioniranje:

BETON: 30/37

$$f_{\text{ck}}=30 \text{ MPa}$$

$$f_{cd} = f_{ck} / \gamma_c = 30 / 1.5 = 20 \text{ MPa}$$

ARMATURA: B500B

$$f_{yk} = 500 \text{ MPa}$$

$$f_{yd} = f_{yk} / \gamma_s = 500 / 1.15 = 434.78 \text{ MPa}$$

Dimenzioniranje na momet savijanja:

$$\mu_{sd} = \frac{M_{Ed,A}}{b_{eff} \cdot d^2 \cdot f_{cd}} = \frac{68.76 \times 100}{25 \cdot 30^2 \cdot 2} = 0.153$$

-iz tablice za  $\epsilon_{s1} = 10\text{‰}$  uzimamo:  $\epsilon_{c2} = 3.4\text{‰}$ ,  $\xi = 0.254$ ,  $\zeta = 0.895$ ,  $\mu_{sd} = 0.155$

-armatura:

$$A_{s1} = \frac{M_{Ed,1}}{\zeta \cdot d \cdot f_{yd}} = \frac{6876}{0.895 \cdot 30 \cdot 43.48} = 5.89 \text{ cm}^2$$

ODABRANO:  $A_{s1} = 6.16 \text{ cm}^2$ ,  $4\phi 14$

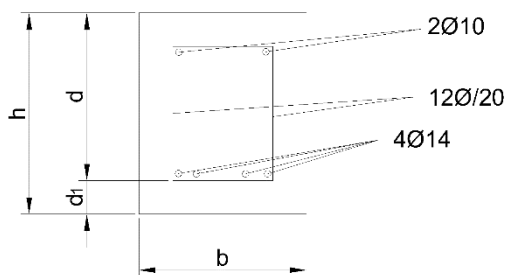

Uzdužna armatura na poprečnu silu ( $V_{Rd,c}$ ):

$$V_{Ed} = 81,37 \text{ kN}$$

$$V_{Rd,c} = [C_{Rdc} \cdot k \cdot (100 \cdot \rho_l \cdot f_{ck})^{1/3} + k_1 \cdot \sigma_{cp}] \cdot b_w \cdot d$$

$$C_{Rdc} = \frac{0,18}{\gamma_c} = \frac{0,18}{1,5} = 0,12$$

$$k = 1,0 + \sqrt{\frac{200}{d}} = 1,0 + \sqrt{\frac{200}{300}} = 1,816 \leq 2,0 \rightarrow k = 1,816$$

$$k_1 = 0,15$$

$$\sigma_{cp} = \frac{N_{Ed}}{A_c} = 0 \quad (N_{Ed} = 0)$$

$$V_{Rdc} = [0,12 \cdot 1,816 \cdot (100 \cdot 0,00861 \cdot 30)^{1/3} + 0,15 \cdot 0] \cdot 250 \cdot 300 = 38313 \text{ N}$$

$$V_{Rdc} = 48,313 \text{ kN} < V_{Ed} = 81,37 \text{ kN}$$

$V_{Rd,c}$  mora biti veća od:

$$V_{Rd,c} \geq [v_{min} + k_1 \cdot \sigma_{cp}] \cdot b_w \cdot d$$

$$v_{min} = 0,035 \cdot k^{3/2} \cdot f_{ck}^{1/2} = 0,035 \cdot 1,816^{3/2} \cdot 30^{1/2} = 0,47$$

$$V_{Rd,c} \geq 0,47 \cdot 250 \cdot 300 = 35250 \text{ N} = 35,25 \text{ kN}$$

$$48,31 \text{ kN} > 35,25 \text{ kN} \quad (\text{uvjet je zadovoljen})$$

Maksimalna poprečna sila

$$V_{Rd,max} = 0,5 \cdot v \cdot b_w \cdot d \cdot f_{cd}$$

$$v = 0,6 \cdot \left(1,0 - \frac{f_{ck}}{250}\right) = 0,6 \cdot \left(1,0 - \frac{30}{250}\right) = 0,528$$

$$V_{Rd,max} = 0,5 \cdot 0,528 \cdot 250 \cdot 300 \cdot 20 = 618750 \text{ N}$$

$$V_{Rd,max} = 818,75 \text{ kN} > V_{Ed} = 81,37 \text{ kN}$$

Maksimalni razmak spona ( $s_{max}$ ):

$$\frac{V_{Ed}}{V_{Rd,max}} = \frac{81,37}{818,75} \approx 0,1 \rightarrow V_{Ed} = 0,1 \cdot V_{Rd,max} < 0,3 \cdot V_{Rd,max}$$

$$s_{w,max} = \min(0,75 \cdot d; 30 \text{ cm}) = \min(22,5 \text{ cm}; 30 \text{ cm}) \rightarrow s_{w,max} = 30 \text{ cm}$$

Minimalna površina jedne grane spona ( $A_{sw,min}$ ):

$$A_{sw,min} = \frac{\rho_{w,min} \cdot s_{w,max} \cdot b_w}{m} = \frac{0,00110 \cdot 30 \cdot 30}{2} = 0,495 \text{ cm}^2$$

$$\text{odabrane spona: } \Phi 12/30 \text{ cm} \quad (A_{sw} = 1,13 \text{ cm}^2)$$

Otpornost elementa sa minimalnom poprečnom armaturom:

$$V_{Rd} = V_{Rd,s} = \frac{A_{sw}}{s} \cdot z \cdot f_{ywd} \cdot m \cdot ctg\theta$$

$$z \approx 0,9 \cdot d \quad (\text{krak unutrašnjih sila})$$

$$\theta = 45^\circ \quad (\text{kut nagiba tlačnih dijagonala})$$

$$V_{Rd,s} = \frac{1,13}{30} \cdot (0,9 \cdot 30) \cdot 43,48 \cdot 2 \cdot 1 = 88,43 \text{ kN} > V_{Ed,0} = 81,37 \text{ kN}$$

(dovoljna je nosivost minimalne poprečne armature)

Potreban razmak spona ( $s_{pot}$ ):

$$s_{pot} \leq m \cdot A_{sw} \cdot f_{yd} \cdot z / V_{sd} = 2 \cdot 1,13 \cdot 43,48 \cdot (30 \cdot 0,9) / 81,37 = 32,61 \text{ m}$$

*odabrane spona:  $\Phi 12/30 \text{ cm}$*

-Površina minimalne armature za grede

Minimalna površina uzdužne armature:

$$A_{s1,min} \geq 0,26 \cdot f_{ctm} / f_{yk} \cdot b_t \cdot d \geq 0,0013 \cdot b_t \cdot d$$

$b_t$  – srednja širina vlačnog područja

$d$  – statička visina

$f_{ctm}$  – srednja vlačna čvrstoća betona

$f_{yk}$  – karakteristična granica popuštanja čelika

$$A_{s1,min} \geq 0,26 \cdot \frac{f_{ctm}}{f_{yk}} \cdot b_t \cdot d \geq 0,0013 \cdot b_t \cdot d$$

$$A_{s1,min} \geq 0,26 \cdot \frac{f_{ctm}}{f_{yk}} \cdot b_t \cdot d \geq 0,26 \cdot \frac{2,9}{500} \cdot 30 \cdot 30 = 1,36 \text{ cm}^2$$

$$A_{s1,min} \geq 0,0013 \cdot b_t \cdot d \geq 0,0013 \cdot 30 \cdot 30 = 1,17 \text{ cm}^2$$

**LEŽAJ:**      *odabrano:  $2\Phi 12$  ( $A_{sw} = 2,26 \text{ cm}^2$ )*

### 3.1. Proračun potrebne armature u gredi u osi 2 i 4 za POZ 300

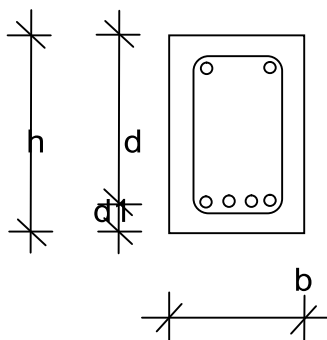

$h_f = 15 \text{ cm}$  – debljina ploče

$$h = \frac{0.85 \cdot L}{10} = \frac{0.85 \cdot 3.38}{10} = 28,7 \text{ cm} \rightarrow \text{odabrano } h = 35 \text{ cm (manje ne zadovoljava)}$$

$$b_w = 25 \text{ cm}$$

$$d = 35 - 5 = 30 \text{ cm}$$

$$\gamma_c = 25 \text{ kN/m}^3$$

$$g_{gr} = b_w \cdot h \cdot \gamma_c = 0,25 \cdot 0,35 \cdot 25 = 2.19 \text{ kN/m}$$

Proračunski model

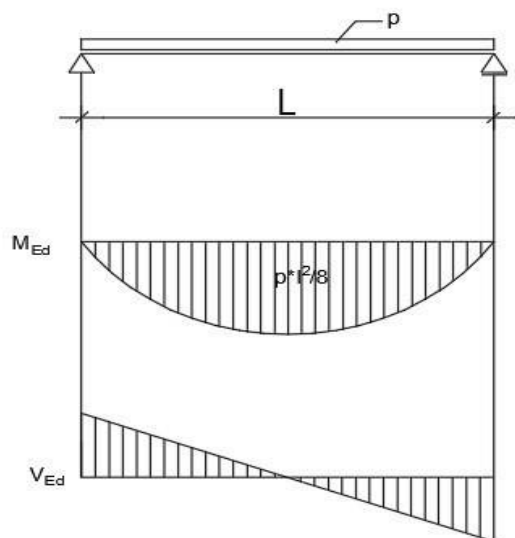

$$L = 3.38 \text{ m}$$

Analiza opterećenja

$$g_{\text{ploče}}=4.45 \text{ kN/m}^2$$

$$q_{\text{ploče}}=1.5 \text{ kN/m}^2$$

Utjecajna širina grede:

$$B=5.93 \text{ m}$$

opterećenje od pločestalno opterećenje:

$$g_{\text{ekv}}=g \cdot B=4.45 \cdot 5.93= 26.39 \text{ kN/m}$$

promjenjivo opterećenje:

$$q_{\text{ekv}}=q \cdot B=1.5 \cdot 5.93= 8.88 \text{ kN/m}$$

opterećenje vlastite težine na gredu

$$g_{\text{gr}}=b \cdot h \cdot \gamma_c=0.25 \cdot 0.35 \cdot 25 = 2.19 \text{ kN/m}$$

Ukupno opterećenje

$$g_{\text{uk}}=g_{\text{ekv}}+g_{\text{gr}}=26.39+2.19 = 28.58 \text{ kN/m}$$

$$q_{\text{uk}}=q_{\text{ekv}}=8.88 \quad \text{kN/m}$$

$$p= 1.35 \cdot g+1.5 \cdot q$$

$$p= 1.35 \cdot 28.58+1.5 \cdot 8.88=51.9 \text{ kN/m}^2$$

Proračun momenata

$$M_{\text{Ed}}=p \cdot L^2/ 8 = 51,9 \cdot 3.38^2/ 8 = 74.11 \text{ kNm/m}$$

Proračun vertikalne sile

$$V_{\text{Ed}}=p \cdot L/2=51.9 \cdot 3.38/2=87.71 \text{ kN}$$

Dimenzioniranje:

BETON: 30/37

$f_{\text{ck}}=30 \text{ MPa}$



$$f_{cd} = f_{ck} / \gamma_c = 30 / 1.5 = 20 \text{ MPa}$$

ARMATURA: B500B

$$f_{yk} = 500 \text{ MPa}$$

$$f_{yd} = f_{yk} / \gamma_s = 500 / 1.15 = 434.78 \text{ MPa}$$

Dimenzioniranje na moment

savijanja:

$$\mu_{sd} = \frac{M_{Ed,A}}{b_{eff} \cdot d^2 \cdot f_{cd}} = \frac{74.11 \times 100}{25 \cdot 30^2 \cdot 2} = 0.164$$

-iz tablice za  $\epsilon_{s1} = 10\text{‰}$  uzimamo:  $\epsilon_{c2} = 3.5\text{‰}$ ,  $\xi = 0.259$ ,  $\zeta = 0.892$ ,  $\mu_{sd} = 0.159$

-armatura:

$$A_{s1} = \frac{M_{Ed,1}}{\zeta \cdot d \cdot f_{yd}} = \frac{7411}{0.892 \cdot 30 \cdot 43,48} = 6,37 \text{ cm}^2$$

$$M_{Rd,lim} = \mu_{sd,lim} \cdot b \cdot d^2 \cdot f_{cd} = 0.164 \cdot 25 \cdot 30^2 \cdot 2 = 7380 = 73,80 \text{ kNm}$$

$$A_{s1} = \frac{M_{Rd,lim}}{\zeta \cdot d \cdot f_{yd}} + \frac{M_{Ed} - M_{Rd,lim}}{(d - d_2) \cdot f_{yd}} = \frac{7380}{0,892 \cdot 30 \cdot 43,48} + \frac{7411 - 7380}{(30 - 5) \cdot 43,48} = 6,37 \text{ cm}^2$$

$$A_{s2} = \frac{M_{Ed} - M_{Rd,lim}}{(d - d_2) \cdot f_{yd}} = \frac{74,11 - 73,80}{(30 - 5) \cdot 43,48} = 0.028 \text{ cm}^2$$

ODABRANO:  $A_{s1} = 6.16 \text{ cm}^2$ ,  $4\phi 14$ ,  $A_{s2} = 1.57 \text{ cm}^2$ ,  $2\phi 10$

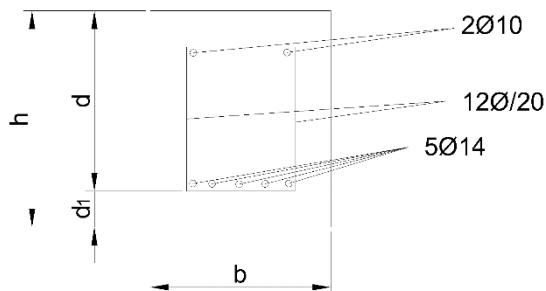

Uzdužna armatura na poprečnu silu ( $V_{Rd,c}$ ):

$$V_{Ed} = 87,71 \text{ kN}$$

$$V_{Rd,c} = [C_{Rdc} \cdot k \cdot (100 \cdot \rho_l \cdot f_{ck})^{1/3} + k_1 \cdot \sigma_{cp}] \cdot b_w \cdot d$$

$$C_{Rdc} = \frac{0,18}{\gamma_c} = \frac{0,18}{1,5} = 0,12$$

$$k = 1,0 + \sqrt{\frac{200}{d}} = 1,0 + \sqrt{\frac{200}{300}} = 1,816 \leq 2,0 \rightarrow k = 1,816$$

$$k_1 = 0,15$$

$$\sigma_{cp} = \frac{N_{Ed}}{A_c} = 0 \quad (N_{Ed} = 0)$$

$$V_{Rdc} = [0,12 \cdot 1,816 \cdot (100 \cdot 0,00861 \cdot 30)^{1/3} + 0,15 \cdot 0] \cdot 250 \cdot 300 = 38313 \text{ N}$$

$$V_{Rdc} = 48,313 \text{ kN} < V_{Ed} = 87,71 \text{ kN}$$

$V_{Rd,c}$  mora biti veća od:

$$V_{Rd,c} \geq [v_{min} + k_1 \cdot \sigma_{cp}] \cdot b_w \cdot d$$

$$v_{min} = 0,035 \cdot k^{3/2} \cdot f_{ck}^{1/2} = 0,035 \cdot 1,816^{3/2} \cdot 30^{1/2} = 0,47$$

$$V_{Rd,c} \geq 0,47 \cdot 250 \cdot 300 = 35250 \text{ N} = 35,25 \text{ kN}$$

$$48,31 \text{ kN} > 35,25 \text{ kN} \quad (\text{uvjet je zadovoljen})$$

Maksimalna poprečna sila

$$V_{Rd,max} = 0,5 \cdot v \cdot b_w \cdot d \cdot f_{cd}$$

$$v = 0,6 \cdot \left(1,0 - \frac{f_{ck}}{250}\right) = 0,6 \cdot \left(1,0 - \frac{30}{250}\right) = 0,528$$

$$V_{Rd,max} = 0,5 \cdot 0,528 \cdot 250 \cdot 300 \cdot 20 = 618750 \text{ N}$$

$$V_{Rd,max} = 818,75 \text{ kN} > V_{Ed} = 87,71 \text{ kN}$$

Maksimalni razmak spona ( $s_{max}$ ):

$$\frac{V_{Ed}}{V_{Rd,max}} = \frac{87,71}{818,75} \approx 0,1 \rightarrow V_{Ed} = 0,1 \cdot V_{Rd,max} < 0,3 \cdot V_{Rd,max}$$

$$s_{w,max} = \min(0,75 \cdot d; 30 \text{ cm}) = \min(22,5 \text{ cm}; 30 \text{ cm}) \rightarrow s_{w,max} = 22,5 \text{ cm}$$

Minimalna površina jedne grane spona ( $A_{sw,min}$ ):

$$A_{sw,min} = \frac{\rho_{w,min} \cdot s_{w,max} \cdot b_w}{m} = \frac{0,00110 \cdot 30 \cdot 30}{2} = 0,495 \text{ cm}^2$$

$$\text{odabrane spona: } \Phi 12/20 \text{ cm} \quad (A_{sw} = 1,13 \text{ cm}^2)$$

Otpornost elementa sa minimalnom poprečnom armaturom:

$$V_{Rd} = V_{Rd,s} = \frac{A_{sw}}{s} \cdot z \cdot f_{ywd} \cdot m \cdot ctg\theta$$

$$z \approx 0,9 \cdot d \quad (\text{krak unutrašnjih sila})$$

$$\theta = 45^\circ \quad (\text{kut nagiba tlačnih dijagonala})$$

$$V_{Rd,s} = \frac{1,13}{30} \cdot (0,9 \cdot 30) \cdot 43,48 \cdot 2 \cdot 1 = 88,43 \text{ kN} > V_{Ed,0} = 87,71 \text{ kN}$$

(dovoljna je nosivost minimalne poprečne armature)

Potreban razmak spona ( $s_{pot}$ ):

$$s_{pot} \leq m \cdot A_{sw} \cdot f_{yd} \cdot z / V_{sd} = 2 \cdot 1,13 \cdot 43,48 \cdot (30 \cdot 0,9) / 81,37 = 32,61 \text{ m}$$

*odabrane spone:  $\Phi 12/20 \text{ cm}$*

-Površina minimalne armature za grede

Minimalna površina uzdužne armature:

$$A_{s1,min} \geq 0,26 \cdot f_{ctm} / f_{yk} \cdot b_t \cdot d \geq 0,0013 \cdot b_t \cdot d$$

$b_t$  – srednja širina vlačnog područja

$d$  – statička visina

$f_{ctm}$  – srednja vlačna čvrstoća betona

$f_{yk}$  – karakteristična granica popuštanja čelika

$$A_{s1,min} \geq 0,26 \cdot \frac{f_{ctm}}{f_{yk}} \cdot b_t \cdot d \geq 0,0013 \cdot b_t \cdot d$$

$$A_{s1,min} \geq 0,26 \cdot \frac{f_{ctm}}{f_{yk}} \cdot b_t \cdot d \geq 0,26 \cdot \frac{2,9}{500} \cdot 30 \cdot 30 = \mathbf{1,36 \text{ cm}^2}$$

$$A_{s1,min} \geq 0,0013 \cdot b_t \cdot d \geq 0,0013 \cdot 30 \cdot 30 = 1,17 \text{ cm}^2$$

**LEŽAJ:**      *odabrano:  $2\Phi 12$  ( $A_{sw} = 2,26 \text{ cm}^2$ )*

## 4. PRORAČUN ZIDOVA

### 4.1 Proračun zidova na vertikalna opterećenja

#### 4.1.1 Podaci za proračun zidova:

blok opeka, dimenzije:  $d \times š \times v = 25 \times 25 \times 23.8$  cm srednja

tlačna čvrstoća bloka:  $f_{ck,sred} = 10.0$  MPa

normalizirana tlačna čvrstoća bloka:  $f_b = 10.0 \cdot \delta = 10 \cdot 1.15 = 11.5$  MPa grupa zidnih blokova: 2 ( $K = 0.45$ )

mort: M10 ( $f_m = 10.0$  MPa)

tlačna čvrstoća zida:  $f_k = K \times f_b^{0.7} \times f_m^{0.3} = 0.45 \cdot 11.5^{0.7} \cdot 10.0^{0.3} = 4.96$  MPa faktor smanjenja za vitkost i ekscentričnost:  $\Phi_{i,m} = 0.70$

parcijalni koef. sigurnosti za materijale:  $\gamma_M = 2.2$  (razred proizvodnje B, razred izvedbe 2.) debljina nosivih zidova:  $t = 25$  cm

**računska uzdužna sila:  $N_{Sd} = N_g \cdot 1.35 + N_q \cdot 1.5$**

**računska nosivost na uzdužnu silu:  $N_{Rd} = \Phi_{i,m} \cdot A \cdot f_k / \gamma_M$**

U proračunu zidova na vertikalna djelovanja dokazuje se da je

$$N_{Sd} < N_{Rd}$$

Proračun se provodi tablično kako je prikazano na slijedećoj

stranici gdje je:  $L$  = računski duljina zida [m]

$t$  = debljina zida [m]

$g$  = stalno opterećenje po jednoj međukatnoj konstrukciji

$q$  = promjenjivo opterećenje po jednoj međukatnoj konstrukciji

$g_z$  = vlastita težina zida;  $g_z = t \cdot \gamma_z + g_{zbuke} = 0.25 \cdot 10.0 +$

$0.025 \cdot 20.0 = 2.50 + 0.50 = 3.00$  kN/m<sup>2</sup>  $L'$  i  $b'$  = utjecajna duljina i širina međukatne ploče koja se oslanja na zid [m]

$n$  = broj etaža (broj međukatnih ploča)

$N_g$  = vertikalno stalno djelovanje:  $N_g = (g \cdot L' \cdot b' + g_z \cdot L \cdot h) \cdot n$   $N_q$  =

vertikalno promjenjivo djelovanje:  $N_q = (q \cdot L' \cdot b') \cdot n$   $o$  = duljina otvora [m]

$A_z$  = računski površina zida:  $A_z = (L - o) \cdot t$  [m<sup>2</sup>]

## Zid ZX1

<p><b>Geometrijske karakteristike zida:</b>  duljina zida: <math>L=9.7</math> m  debljina zida: <math>t=0.25</math> m  visina zida: <math>h=3*3.00\text{m}+0.40\text{m}=9.40</math> m</p> <p><b>Utjecajne površine ploča:</b>  <math>A_{zx1,100}=16.79</math> m<sup>2</sup> <math>A_{zx1,200}=16.79</math> m<sup>2</sup>  <math>A_{zx1,300}=23.34</math> m<sup>2</sup></p> <p><b>Analiza opterećenja:</b>  Stalno: <math>g_{100}=6.10</math> kN/m<sup>2</sup>  <math>g_{200}=6.10</math> kN/m<sup>2</sup> <math>g_{300}=4.45</math> kN/m<sup>2</sup>  Pokretno: <math>q_{100}=1.50</math> kN/m<sup>2</sup>  <math>q_{200}=1.50</math> kN/m<sup>2</sup> <math>q_{300}=1.50</math> kN/m<sup>2</sup>  Vlastita težina zida (<math>t=0.25\text{m}</math>):  <math>g_z=3.00</math> kN/m<sup>2</sup></p>	<p><b>Proračun zida na vertikalna opterećenja:</b></p> <p><b>Uzdužna sila od stalnog djelovanja:</b>  <math>N_g=A_{zx1,100}*g_{100}+A_{zx1,200}*g_{200}+A_{zx1,300}*g_{300}+L*h*g_z</math>  <math>N_g=16.79*6.10+16.79*6.10+23.34*4.45+9.7*9.40*3.00</math>  <math>N_g=583</math> KN</p> <p><b>Uzdužna sila od pokretnog djelovanja:</b>  <math>N_q=A_{zx1,100}*q_{100}+A_{zx1,200}*q_{200}+A_{zx1,300}*q_{300}</math>  <math>N_q=16.79*1.50+16.79*1.50+23.34*1.50</math>  <math>N_q=86</math> KN</p> <p><b>Računska uzdužna sila:</b>  <math>N_{sd}=1.35*N_g+1.5*N_q</math>  <math>N_{sd}=1.35*583+1.5*86=916</math> kN</p> <p><b>Računska otpornost:</b>  <math>N_{Rd}=\Phi_{i,m} * A * f_k / \gamma_M</math>  <math>N_{Rd}=0.7*(970*25)*0.496/2.2=3827</math> kN &gt; 916 kN</p>
--	---

## Zid ZX2

<p><b>Geometrijske karakteristike zida:</b>  duljina zida: <math>L=4.72</math> m  debljina zida: <math>t=0.25</math> m  visina zida: <math>h=3*3.00\text{m}+0.40\text{m}=9.40</math> m</p> <p><b>Utjecajne površine ploča:</b>  <math>A_{zx2,100}=27.26</math> m<sup>2</sup> <math>A_{zx2,200}=27.26</math> m<sup>2</sup>  <math>A_{zx2,300}=35.62</math> m<sup>2</sup></p> <p><b>Analiza opterećenja:</b>  Stalno: <math>g_{100}=6.10</math> kN/m<sup>2</sup>  <math>g_{200}=6.10</math> kN/m<sup>2</sup> <math>g_{300}=4.45</math> kN/m<sup>2</sup>  Pokretno: <math>q_{100}=1.50</math> kN/m<sup>2</sup>  <math>q_{200}=1.50</math> kN/m<sup>2</sup> <math>q_{300}=1.50</math> kN/m<sup>2</sup>  Vlastita težina zida (<math>t=0.25\text{m}</math>):  <math>g_z=3.00</math> kN/m<sup>2</sup></p>	<p><b>Proračun zida na vertikalna opterećenja:</b></p> <p><b>Uzdužna sila od stalnog djelovanja:</b>  <math>N_g=A_{zx2,100}*g_{100}+A_{zx2,200}*g_{200}+A_{zx2,300}*g_{300}+L*h*g_z</math>  <math>N_g=27.26*6.10+27.26*6.10+35.62*4.45+4.72*9.40*3.00</math>  <math>N_g=625</math> KN</p> <p><b>Uzdužna sila od pokretnog djelovanja:</b>  <math>N_q=A_{zx2,100}*q_{100}+A_{zx2,200}*q_{200}+A_{zx2,300}*q_{300}</math>  <math>N_q=27.26*1.50+27.26*1.50+35.62*1.50</math>  <math>N_q=136</math> KN</p> <p><b>Računska uzdužna sila:</b>  <math>N_{sd}=1.35*N_g+1.5*N_q</math>  <math>N_{sd}=1.35*625+1.5*136=1048</math> kN</p> <p><b>Računska otpornost:</b>  <math>N_{Rd}=\Phi_{i,m} * A * f_k / \gamma_M</math>  <math>N_{Rd}=0.7*(472*25)*0.496/2.2=1862</math> kN &gt; 1048 kN</p>
---	--

## Zid ZX3

<p><b>Geometrijske karakteristike zida:</b>  duljina zida: <math>L=2.6</math> m  debljina zida: <math>t=0.25</math> m  visina zida: <math>h=3*3.00m+0.40m=9.40</math> m</p> <p><b>Utjecajne površine ploča:</b>  <math>A_{zx3,100}=7.52</math> m<sup>2</sup> <math>A_{zx3,200}=7.52</math> m<sup>2</sup>  <math>A_{zx3,300}=13.52</math> m<sup>2</sup></p> <p><b>Analiza opterećenja:</b>  Stalno: <math>g_{100}=6.10</math> kN/m<sup>2</sup>  <math>g_{200}=6.10</math> kN/m<sup>2</sup> <math>g_{300}=4.45</math> kN/m<sup>2</sup>  Pokretno: <math>q_{100}=1.50</math> kN/m<sup>2</sup>  <math>q_{200}=1.50</math> kN/m<sup>2</sup> <math>q_{300}=1.50</math> kN/m<sup>2</sup>  Vlastita težina zida (<math>t=0.25m</math>):  <math>g_z=3.00</math> kN/m<sup>2</sup></p>	<p><b>Proračun zida na vertikalna opterećenja:</b></p> <p><b>Uzdužna sila od stalnog djelovanja:</b>  <math>N_g=A_{zx3,100}*g_{100}+ A_{zx3,200}*g_{200}+ A_{zx3,300}*g_{300}+L*h*g_z</math>  <math>N_g=7.52*6.10+7.52*6.10+13.52*4.45+2.6*9.40*3.00</math>  <math>N_g=226</math> KN</p> <p><b>Uzdužna sila od pokretnog djelovanja:</b>  <math>N_q=A_{zx3,100}*q_{100}+ A_{zx3,200}*q_{200}+ A_{zx3,300}*q_{300}</math>  <math>N_q=7.52*1.50+7.52*1.50+13.52*1.50</math>  <math>N_q=43</math> KN</p> <p><b>Računska uzdužna sila:</b>  <math>N_{sd}=1.35*N_g+1.5*N_q</math>  <math>N_{sd}=1.35*226+1.5*43= 370</math> kN</p> <p><b>Računska otpornost:</b>  <math>N_{Rd}=\phi_{i,m} * A * f_k / \gamma_M</math>  <math>N_{Rd}=0.7*(260*25)*0.496/2.2= 1026</math> kN&gt;370 kN</p>
---	---

## ZID ZX4

<p><b>Geometrijske karakteristike zida:</b>  duljina zida: <math>L=2.6</math> m  debljina zida: <math>t=0.25</math> m  visina zida: <math>h=3*3.00m+0.40m=9.40</math> m</p> <p><b>Utjecajne površine ploča:</b>  <math>A_{zx4,100}=1.6</math> m<sup>2</sup> <math>A_{zx4,200}=1.6</math> m<sup>2</sup>  <math>A_{zx4,300}=1.6</math> m<sup>2</sup></p> <p><b>Analiza opterećenja:</b>  Stalno: <math>g_{100}=6.10</math> kN/m<sup>2</sup>  <math>g_{200}=6.10</math> kN/m<sup>2</sup> <math>g_{300}=6.10</math> kN/m<sup>2</sup>  Pokretno: <math>q_{100}=3</math> kN/m<sup>2</sup>  <math>q_{200}=3</math> kN/m<sup>2</sup> <math>q_{300}=3</math> kN/m<sup>2</sup>  Vlastita težina zida (<math>t=0.25m</math>):  <math>g_z=3.00</math> kN/m<sup>2</sup></p>	<p><b>Proračun zida na vertikalna opterećenja:</b></p> <p><b>Uzdužna sila od stalnog djelovanja:</b>  <math>N_g=A_{zx4,100}*g_{100}+ A_{zx4,200}*g_{200}+ A_{zx4,300}*g_{300}+L*h*g_z</math>  <math>N_g=3*(1.6*6.1)+2.6*9.40*3.00</math> <math>N_g=104</math> KN</p> <p><b>Uzdužna sila od pokretnog djelovanja:</b>  <math>N_q=A_{zx4,100}*q_{100}+ A_{zx4,200}*q_{200}+ A_{zx4,300}*q_{300}</math>  <math>N_q=3*1.6*3</math>  <math>N_q=15</math> KN</p> <p><b>Računska uzdužna sila:</b>  <math>N_{sd}=1.35*N_g+1.5*N_q</math>  <math>N_{sd}=1.35*104+1.5*15= 163</math> kN</p> <p><b>Računska otpornost:</b>  <math>N_{Rd}=\phi_{i,m} * A * f_k / \gamma_M</math>  <math>N_{Rd}=0.7*(260*25)*0.496/2.2= 1026</math> kN&gt;163 kN</p>
--	--

**ZID ZX5**

<p><b>Geometrijske karakteristike zida:</b>  duljina zida: <math>L=2.6</math> m  debljina zida: <math>t=0.25</math> m  visina zida: <math>h=3*3.00\text{m}+0.40\text{m}=9.40</math> m</p> <p><b>Utjecajne površine ploča:</b>  <math>A_{zx1,100}=4.68</math> m<sup>2</sup> <math>A_{zx1,200}=4.68</math> m<sup>2</sup>  <math>A_{zx1,300}=13.24</math> m<sup>2</sup></p> <p><b>Analiza opterećenja:</b>  Stalno: <math>g_{100}=6.10</math> kN/m<sup>2</sup>  <math>g_{200}=6.10</math> kN/m<sup>2</sup> <math>g_{300}=4.45</math> kN/m<sup>2</sup>  Pokretno: <math>q_{100}=1.50</math> kN/m<sup>2</sup>  <math>q_{200}=1.50</math> kN/m<sup>2</sup> <math>q_{300}=1.50</math> kN/m<sup>2</sup>  Vlastita težina zida (<math>t=0.25\text{m}</math>):  <math>g_z=3.00</math> kN/m<sup>2</sup></p>	<p><b>Proračun zida na vertikalna opterećenja:</b></p> <p><b>Uzdužna sila od stalnog djelovanja:</b>  <math>N_g=A_{zx5,100}*g_{100}+A_{zx5,200}*g_{200}+A_{zx5,300}*g_{300}+L*h*g_z</math>  <math>N_g=4.68*6.10+4.68*6.10+13.24*4.45+2.6*9.40*3.00</math>  <math>N_g=190</math> KN</p> <p><b>Uzdužna sila od pokretnog djelovanja:</b>  <math>N_q=A_{zx5,100}*q_{100}+A_{zx5,200}*q_{200}+A_{zx5,300}*q_{300}</math>  <math>N_q=4.68*1.50+4.68*1.50+13.24*1.50</math>  <math>N_q=34</math> KN</p> <p><b>Računska uzdužna sila:</b>  <math>N_{sd}=1.35*N_g+1.5*N_q</math>  <math>N_{sd}=1.35*190+1.5*34=308</math> kN</p> <p><b>Računska otpornost:</b>  <math>N_{Rd}=\phi_{i,m} * A * f_k / \gamma_M</math>  <math>N_{Rd}=0.7*(260*25)*0.496/2.2=1026</math> kN &gt; 308 kN</p>
--	---

**ZID ZX6**

<p><b>Geometrijske karakteristike zida:</b>  duljina zida: <math>L=5.23</math> m  debljina zida: <math>t=0.25</math> m  visina zida: <math>h=3*3.00\text{m}+0.40\text{m}=9.40</math> m</p> <p><b>Utjecajne površine ploča:</b>  <math>A_{zx2,100}=27.26</math> m<sup>2</sup> <math>A_{zx2,200}=27.26</math> m<sup>2</sup>  <math>A_{zx2,300}=35,62</math> m<sup>2</sup></p> <p><b>Analiza opterećenja:</b>  Stalno: <math>g_{100}=6.10</math> kN/m<sup>2</sup>  <math>g_{200}=6.10</math> kN/m<sup>2</sup> <math>g_{300}=4.45</math> kN/m<sup>2</sup>  Pokretno: <math>q_{100}=1.50</math> kN/m<sup>2</sup>  <math>q_{200}=1.50</math> kN/m<sup>2</sup> <math>q_{300}=1.50</math> kN/m<sup>2</sup>  Vlastita težina zida (<math>t=0.25\text{m}</math>):  <math>g_z=3.00</math> kN/m<sup>2</sup></p>	<p><b>Proračun zida na vertikalna opterećenja:</b></p> <p><b>Uzdužna sila od stalnog djelovanja:</b>  <math>N_g=A_{zx6,100}*g_{100}+A_{zx6,200}*g_{200}+A_{zx6,300}*g_{300}+L*h*g_z</math>  <math>N_g=27.26*6.10+27.26*6.10+35.62*4.45+5.23*9.40*3.00</math>  <math>N_g=639</math> KN</p> <p><b>Uzdužna sila od pokretnog djelovanja:</b>  <math>N_q=A_{zx6,100}*q_{100}+A_{zx6,200}*q_{200}+A_{zx6,300}*q_{300}</math>  <math>N_q=27.26*1.50+27.26*1.50+35.62*1.50</math>  <math>N_q=136</math> KN</p> <p><b>Računska uzdužna sila:</b>  <math>N_{sd}=1.35*N_g+1.5*N_q</math>  <math>N_{sd}=1.35*639+1.5*136=1067</math> kN</p> <p><b>Računska otpornost:</b>  <math>N_{Rd}=\phi_{i,m} * A * f_k / \gamma_M</math>  <math>N_{Rd}=0.7*(523*25)*0.496/2.2=2064</math> kN &gt; 1067 kN</p>
---	--

**ZID ZX7**

<p><b>Geometrijske karakteristike zida:</b>  duljina zida: <math>L=10.20</math> m  debljina zida: <math>t=0.25</math> m  visina zida: <math>h=3*3.00+0.40=9.40</math> m</p> <p><b>Utjecajne površine ploča:</b>  <math>A_{zx7,100}=20.48</math> m<sup>2</sup> <math>A_{zx7,200}=20.48</math> m<sup>2</sup>  <math>A_{zx7,300}=28.35</math> m<sup>2</sup></p> <p><b>Analiza opterećenja:</b>  Stalno: <math>g_{100}=6.10</math> kN/m<sup>2</sup>  <math>g_{200}=6.10</math> kN/m<sup>2</sup> <math>g_{300}=4.45</math> kN/m<sup>2</sup>  Pokretno: <math>q_{100}=1.50</math> kN/m<sup>2</sup>  <math>q_{200}=1.50</math> kN/m<sup>2</sup> <math>q_{300}=1.50</math> kN/m<sup>2</sup>  Vlastita težina zida (<math>t=0.25</math>m):  <math>g_z=3.00</math> kN/m<sup>2</sup></p>	<p><b>Proračun zida na vertikalna opterećenja:</b></p> <p><b>Uzdužna sila od stalnog djelovanja:</b>  <math>N_g=A_{zx7,100}*g_{100}+ A_{zx7,200}*g_{200}+ A_{zx7,300}*g_{300}+L*h*g_z</math>  <math>N_g=20.48*6.10+20.48*6.10+28.45*4.45+10.20*9.40*3.00</math>  <math>N_g=665</math> KN</p> <p><b>Uzdužna sila od pokretnog djelovanja:</b>  <math>N_q=A_{zx7,100}*q_{100}+ A_{zx7,200}*q_{200}+ A_{zx7,300}*q_{300}</math>  <math>N_q=20.48*1.50+20.48*1.50+28.45*1.50</math>  <math>N_q=105</math> KN</p> <p><b>Računska uzdužna sila:</b>  <math>N_{sd}=1.35*N_g+1.5*N_q</math>  <math>N_{sd}=1.35*665+1.5*105= 1056</math> KN</p> <p><b>Računska otpornost:</b>  <math>N_{Rd}=\phi_{1,m} * A * f_k / \gamma_M</math>  <math>N_{Rd}=0.7*(1020*25)*0.496/2.2= 4024</math> kN &gt; 1056 kN</p>
---	--



**ZID ZY1**

<p><b>Geometrijske karakteristike zida:</b>  duljina zida: <math>L=5.35</math> m  debljina zida: <math>t=0.25</math> m  visina zida: <math>h=3*3.00m+0.40m=9.40</math> m</p> <p><b>Utjecajne površine ploča:</b>  <math>A_{zy1,100}=7.09</math> m<sup>2</sup> <math>A_{zy1,200}=7.09</math> m<sup>2</sup>  <math>A_{zy1,300}=0</math> m<sup>2</sup></p> <p><b>Analiza opterećenja:</b>  Stalno: <math>g_{100}=6.10</math> kN/m<sup>2</sup>  <math>g_{200}=6.10</math> kN/m<sup>2</sup> <math>g_{300}=4.45</math> kN/m<sup>2</sup>  Pokretno: <math>q_{100}=1.50</math> kN/m<sup>2</sup>  <math>q_{200}=1.50</math> kN/m<sup>2</sup> <math>q_{300}=1.50</math> kN/m<sup>2</sup></p> <p>Vlastita težina zida (<math>t=0.25m</math>):  <math>g_z=3.00</math> kN/m<sup>2</sup></p>	<p><b>Proračun zida na vertikalna opterećenja:</b></p> <p><b>Uzdužna sila od stalnog djelovanja:</b>  <math>N_g=A_{zy1,100}*g_{100}+ A_{zy1,200}*g_{200}+ A_{zy1,300}*g_{300}+L*h*g_z</math>  <math>N_g=7.09*6.10+7.09*6.10+0*4.45+5.35*9.40*3.00</math>  <math>N_g=238</math> KN</p> <p><b>Uzdužna sila od pokretnog djelovanja:</b>  <math>N_q=A_{zy1,100}*q_{100}+ A_{zy1,200}*q_{200}+ A_{zy1,300}*q_{300}</math>  <math>N_q=7.09*1.50+7.09*1.50+0*1.50</math>  <math>N_q=22</math> KN</p> <p><b>Računska uzdužna sila:</b>  <math>N_{sd}=1.35*N_g+1.5*N_q</math>  <math>N_{sd}=1.35*238+1.5*22= 355</math> kN</p> <p><b>Računska otpornost:</b>  <math>N_{Rd}=\Phi_{i,m} * A * f_k / \gamma_M</math>  <math>N_{Rd}=0.7*(535*25)*0.496/2.2= 2111</math> kN&gt;355 kN</p>
--	--

**ZID ZY2**

<p><b>Geometrijske karakteristike zida:</b>  duljina zida: <math>L=11.93</math> m  debljina zida: <math>t=0.25</math> m  visina zida: <math>h=3*3.00m+0.40m=9.40</math> m</p> <p><b>Utjecajne površine ploča:</b>  <math>A_{zy2,100}=19.43</math> m<sup>2</sup> <math>A_{zy2,200}=19.43</math> m<sup>2</sup>  <math>A_{zy2,300}=0</math> m<sup>2</sup></p> <p><b>Analiza opterećenja:</b>  Stalno: <math>g_{100}=6.10</math> kN/m<sup>2</sup>  <math>g_{200}=6.10</math> kN/m<sup>2</sup> <math>g_{300}=4.45</math> kN/m<sup>2</sup>  Pokretno: <math>q_{100}=1.50</math> kN/m<sup>2</sup>  <math>q_{200}=1.50</math> kN/m<sup>2</sup> <math>q_{300}=1.50</math> kN/m<sup>2</sup></p> <p>Vlastita težina zida (<math>t=0.25m</math>):  <math>g_z=3.00</math> kN/m<sup>2</sup></p>	<p><b>Proračun zida na vertikalna opterećenja:</b></p> <p><b>Uzdužna sila od stalnog djelovanja:</b>  <math>N_g=A_{zy2,100}*g_{100}+ A_{zy2,200}*g_{200}+ A_{zy2,300}*g_{300}+L*h*g_z</math>  <math>N_g=19.43*6.10+19.43*6.10+0*4.45+11.93*9.40*3.00</math>  <math>N_g=574</math> KN</p> <p><b>Uzdužna sila od pokretnog djelovanja:</b>  <math>N_q=A_{zy2,100}*q_{100}+ A_{zy2,200}*q_{200}+ A_{zy2,300}*q_{300}</math>  <math>N_q=19.43*1.50+19.43*1.50+0*1.50</math>  <math>N_q=59</math> KN</p> <p><b>Računska uzdužna sila:</b>  <math>N_{sd}=1.35*N_g+1.5*N_q</math>  <math>N_{sd}=1.35*574+1.5*59= 864</math> kN</p> <p><b>Računska otpornost:</b>  <math>N_{Rd}=\Phi_{i,m} * A * f_k / \gamma_M</math>  <math>N_{Rd}=0.7*(1193*25)*0.496/2.2= 4707</math> kN&gt;863 kN</p>
---	--

**ZID ZY3**

<p><b>Geometrijske karakteristike zida:</b>  duljina zida: <math>L=6.83</math> m  debljina zida: <math>t=0.25</math> m  visina zida: <math>h=3*3.00m+0.40m=9.40</math> m</p> <p><b>Utjecajne površine ploča:</b>  <math>A_{zy1,100}=4.67</math> m<sup>2</sup> <math>A_{zy1,200}=4.67</math> m<sup>2</sup>  <math>A_{zy1,300}=4.67</math> m<sup>2</sup></p> <p><b>Analiza opterećenja:</b>  Stalno: <math>g_{100}=6.10</math> kN/m<sup>2</sup>  <math>g_{200}=6.10</math> kN/m<sup>2</sup> <math>g_{300}=4.45</math> kN/m<sup>2</sup>  Pokretno: <math>q_{100}=1.50</math> kN/m<sup>2</sup>  <math>q_{200}=1.50</math> kN/m<sup>2</sup> <math>q_{300}=1.50</math> kN/m<sup>2</sup>  Vlastita težina zida (<math>t=0.25m</math>):  <math>g_z=3.00</math> kN/m<sup>2</sup></p>	<p><b>Proračun zida na vertikalna opterećenja:</b></p> <p><b>Uzdužna sila od stalnog djelovanja:</b>  <math>N_g=A_{zy1,100}*g_{100}+ A_{zy1,200}*g_{200}+ A_{zy1,300}*g_{300}+L*h*g_z</math>  <math>N_g=4.67*6.10+4.67*6.10+4.67*4.45+6.83*9.40*3.00</math>  <math>N_g=278</math> KN</p> <p><b>Uzdužna sila od pokretnog djelovanja:</b>  <math>N_q=A_{zy1,100}*q_{100}+ A_{zy1,200}*q_{200}+ A_{zy1,300}*q_{300}</math>  <math>N_q=4.67*1.50+4.67*1.50+4.67*1.50</math>  <math>N_q=21</math> KN</p> <p><b>Računska uzdužna sila:</b>  <math>N_{sd}=1.35*N_g+1.5*N_q</math>  <math>N_{sd}=1.35*278+1.5*21= 407</math> KN</p> <p><b>Računska otpornost:</b>  <math>N_{Rd}=\Phi_{i,m} * A * f_k / \gamma_M</math>  <math>N_{Rd}=0.7*(683*25)*0.496/2.2= 2695</math> kN &gt; 407 KN</p>
---	--

**ZID ZY4**

<p><b>Geometrijske karakteristike zida:</b>  duljina zida: <math>L=6.83</math> m  debljina zida: <math>t=0.25</math> m  visina zida: <math>h=3*3.00m+0.40m=9.40</math> m</p> <p><b>Utjecajne površine ploča:</b>  <math>A_{zy2,100}=17.24</math> m<sup>2</sup> <math>A_{zy2,200}=17.24</math> m<sup>2</sup>  <math>A_{zy2,300}=4.67</math> m<sup>2</sup></p> <p><b>Analiza opterećenja:</b>  Stalno: <math>g_{100}=6.10</math> kN/m<sup>2</sup>  <math>g_{200}=6.10</math> kN/m<sup>2</sup> <math>g_{300}=4.45</math> kN/m<sup>2</sup>  Pokretno: <math>q_{100}=1.50</math> kN/m<sup>2</sup>  <math>q_{200}=1.50</math> kN/m<sup>2</sup> <math>q_{300}=1.50</math> kN/m<sup>2</sup>  Vlastita težina zida (<math>t=0.25m</math>):  <math>g_z=3.00</math> kN/m<sup>2</sup></p>	<p><b>Proračun zida na vertikalna opterećenja:</b></p> <p><b>Uzdužna sila od stalnog djelovanja:</b>  <math>N_g=A_{zy2,100}*g_{100}+ A_{zy2,200}*g_{200}+ A_{zy2,300}*g_{300}+L*h*g_z</math>  <math>N_g=17.24*6.10+17.24*6.10+4.67*4.45+6.83*9.40*3.00</math>  <math>N_g=424</math> KN</p> <p><b>Uzdužna sila od pokretnog djelovanja:</b>  <math>N_q=A_{zy2,100}*q_{100}+ A_{zy2,200}*q_{200}+ A_{zy2,300}*q_{300}</math>  <math>N_q=17.24*1.50+17.24*1.50+4.67*1.50</math>  <math>N_q=59</math> KN</p> <p><b>Računska uzdužna sila:</b>  <math>N_{sd}=1.35*N_g+1.5*N_q</math>  <math>N_{sd}=1.35*424+1.5*59= 613</math> KN</p> <p><b>Računska otpornost:</b>  <math>N_{Rd}=\Phi_{i,m} * A * f_k / \gamma_M</math>  <math>N_{Rd}=0.7*(638*25)*0.496/2.2= 2695</math> kN &gt; 613 KN</p>
---	--

**ZID ZY5**

<p><b>Geometrijske karakteristike zida:</b>  duljina zida: <math>L=5.25</math> m  debljina zida: <math>t=0.25</math> m  visina zida: <math>h=3*3.00+0.40=9.40</math> m</p> <p><b>Utjecajne površine ploča:</b>  <math>A_{zy1,100}=7.53</math> m<sup>2</sup> <math>A_{zy1,200}=7.53</math> m<sup>2</sup>  <math>A_{zy1,300}=0</math> m<sup>2</sup></p> <p><b>Analiza opterećenja:</b>  Stalno: <math>g_{100}=6.10</math> kN/m<sup>2</sup>  <math>g_{200}=6.10</math> kN/m<sup>2</sup> <math>g_{300}=4.45</math> kN/m<sup>2</sup>  Pokretno: <math>q_{100}=1.50</math> kN/m<sup>2</sup>  <math>q_{200}=1.50</math> kN/m<sup>2</sup> <math>q_{300}=1.50</math> kN/m<sup>2</sup></p> <p>Vlastita težina zida (<math>t=0.25</math>m):  <math>g_z=3.00</math> kN/m<sup>2</sup></p>	<p><b>Proračun zida na vertikalna opterećenja:</b></p> <p><b>Uzdužna sila od stalnog djelovanja:</b>  <math>N_g=A_{zy1,100}*g_{100}+A_{zy1,200}*g_{200}+A_{zy1,300}*g_{300}+L*h*g_z</math>  <math>N_g=7.53*6.10+7.53*6.10+0*4.45+5.25*9.40*3.00</math>  <math>N_g=240</math> KN</p> <p><b>Uzdužna sila od pokretnog djelovanja:</b>  <math>N_q=A_{zy1,100}*q_{100}+A_{zy1,200}*q_{200}+A_{zy1,300}*q_{300}</math>  <math>N_q=7.53*1.50+7.53*1.50+0*1.50</math>  <math>N_q=23</math> KN</p> <p><b>Računska uzdužna sila:</b>  <math>N_{sd}=1.35*N_g+1.5*N_q</math>  <math>N_{sd}=1.35*240+1.5*23=359</math> kN</p> <p><b>Računska otpornost:</b>  <math>N_{Rd}=\Phi_{i,m} * A * f_k / \gamma_M</math>  <math>N_{Rd}=0.7*(525*25)*0.496/2.2=2072</math> kN &gt; 359 kN</p>
--	--

**ZID ZY6**

<p><b>Geometrijske karakteristike zida:</b>  duljina zida: <math>L=5.25</math> m  debljina zida: <math>t=0.25</math> m  visina zida: <math>h=3*3.00+0.40=9.40</math> m</p> <p><b>Utjecajne površine ploča:</b>  <math>A_{zy1,100}=7.53</math> m<sup>2</sup> <math>A_{zy1,200}=7.53</math> m<sup>2</sup>  <math>A_{zy1,300}=0</math> m<sup>2</sup></p> <p><b>Analiza opterećenja:</b>  Stalno: <math>g_{100}=6.10</math> kN/m<sup>2</sup>  <math>g_{200}=6.10</math> kN/m<sup>2</sup> <math>g_{300}=4.45</math> kN/m<sup>2</sup>  Pokretno: <math>q_{100}=1.50</math> kN/m<sup>2</sup>  <math>q_{200}=1.50</math> kN/m<sup>2</sup> <math>q_{300}=1.50</math> kN/m<sup>2</sup></p> <p>Vlastita težina zida (<math>t=0.25</math>m):  <math>g_z=3.00</math> kN/m<sup>2</sup></p>	<p><b>Proračun zida na vertikalna opterećenja:</b></p> <p><b>Uzdužna sila od stalnog djelovanja:</b>  <math>N_g=A_{zy1,100}*g_{100}+A_{zy1,200}*g_{200}+A_{zy1,300}*g_{300}+L*h*g_z</math>  <math>N_g=7.53*6.10+7.53*6.10+0*4.45+5.25*9.40*3.00</math>  <math>N_g=240</math> KN</p> <p><b>Uzdužna sila od pokretnog djelovanja:</b>  <math>N_q=A_{zy1,100}*q_{100}+A_{zy1,200}*q_{200}+A_{zy1,300}*q_{300}</math>  <math>N_q=7.53*1.50+7.53*1.50+0*1.50</math>  <math>N_q=23</math> KN</p> <p><b>Računska uzdužna sila:</b>  <math>N_{sd}=1.35*N_g+1.5*N_q</math>  <math>N_{sd}=1.35*240+1.5*23=359</math> kN</p> <p><b>Računska otpornost:</b>  <math>N_{Rd}=\Phi_{i,m} * A * f_k / \gamma_M</math>  <math>N_{Rd}=0.7*(525*25)*0.496/2.2=2072</math> kN &gt; 359 kN</p>
--	--

## 4.2. Proračun zidova na potres

### 4.2.1. Proračun ukupne potresne poprečne sile

Ukupna potresna poprečna sila iznosi:

$$F_b = \gamma_1 * S_d(T_1) * W$$

gdje je:

$S_d(T_1)$  = ordinata računskog spektra za period  $T_1$

$\gamma_1$  – faktor važnosti građevine ( $\gamma_1=1.0$ )

$$S_d(T_1) = \alpha * S^{2.5}/q$$

$\alpha = a_g/g = 2.0/10 = 0.2$ ;  $S = 1.2$  (B kategorija tla)

$q = 2.5$  (faktor ponašanja konstrukcije)

$$S_d(T_1) = 0.2 * 1.2^{2.5} / 2.5 = 0.24$$

$W$  = računska težina zgrade:

3. ETAŽA I POZ 300:

$$\text{POZ 300: } (g + \varphi * \psi_{2i} q) * A = (4.45 + 1.0 * 0.3 * 1.5) * 178.65 = 876 \text{ kN}$$

grede i nadvoji 300:  $b * h * L_{uk} * \gamma_c =$

$$0.25 * 0.25 * 71.5 * 25.0 + 0.35 * 0.25 * 6.75 * 25.0 = 127 \text{ kN}$$

zidovi 3. etaže:  $g_z * h_z * L_{uk} = 3.0 * 3.4 * 71.5 = 730 \text{ kN}$

$$W_3 = 1733 \text{ Kn}$$

2. ETAŽA I POZ 200:

$$\text{POZ 200: } (g + \varphi * \psi_{2i} q) * A = (6.10 + 0.5 * 0.3 * 1.5) * 178.65 = 1130 \text{ kN}$$

grede i nadvoji 200:  $b * h * L_{uk} * \gamma_c = 0.25 * 0.25 * 71.5 * 25.0 + 0.35 * 0.25 * 6.75 * 25.0 = 127 \text{ kN}$

zidovi 2. etaže:  $g_z * h_z * L_{uk} = 3.0 * 3.0 * 71.5 = 644 \text{ kN}$

$$W_2 = 1901 \text{ kN}$$

1. ETAŽA I POZ 100:

$$\text{POZ 100: } (g + \varphi * \psi_{2i} q) * A = (6.10 + 0.5 * 0.3 * 1.5) * 178.65 = 1130 \text{ kN}$$

grede i nadvoji 100:  $b * h * L_{uk} * \gamma_c = 0.25 * 0.25 * 71.5 * 25.0 + 0.35 * 0.25 * 6.75 * 25.0 = 127 \text{ kN}$

zidovi 1. etaže:  $g_z * h_z * L_{uk} = 3.0 * 3.0 * 71.5 = 644 \text{ kN}$

$$W_1 = 1901 \text{ kN}$$

Izračun težina skoncentriranih u razini međukatnih konstrukcija:

$$W_{300} = W_3 = 1733 \text{ kN}$$

$$W_{200} = W_2 = 1901 \text{ kN}$$

$$W_{100} = W_1 = 1901 \text{ kN}$$

Ukupna računaska težina zgrade:

$$W = 1901 + 1901 + 1733 = 5535 \text{ kN}$$

Specifična računaska težina zgrade:

$$w = (W_1 + W_2 + W_3) / A_{uk} = 5535 / (178.65 \cdot 3) = 10.33 \text{ kN/m}^2$$

Ukupna potresna poprečna sila iznosi:

$$F_b = 0.24 \cdot 5535 = 1329 \text{ kN}$$

#### 4.2.2. Razdioba ukupne potresne sile po etažama

$$F_{b,100} = F_b \cdot (W_{100} \cdot h_{100}) / (W_{100} \cdot h_{100} + W_{200} \cdot h_{200} + W_{300} \cdot h_{300}) = \dots = 227 \text{ kN}$$

$$F_{b,200} = F_b \cdot (W_{200} \cdot h_{200}) / (W_{100} \cdot h_{100} + W_{200} \cdot h_{200} + W_{300} \cdot h_{300}) = \dots = 454 \text{ kN}$$

$$F_{b,300} = F_b \cdot (W_{300} \cdot h_{300}) / (W_{100} \cdot h_{100} + W_{200} \cdot h_{200} + W_{300} \cdot h_{300}) = \dots = 649 \text{ kN}$$

Ukupna potresna poprečna sila:

$$V_{Ed} = 1330 \text{ kN}$$

Ukupan moment savijanja:

$$M_{Ed} = F_{b,100} \cdot h_{100} + F_{b,200} \cdot h_{200} + F_{b,300} \cdot h_{300} =$$

$$227 \cdot 3.0 + 454 \cdot 6.0 + 649 \cdot 9.4 = 12298 \text{ kNm}$$

$$M_{Ed} = 12298 \text{ kNm}$$

#### 4.2.3. Razdioba ukupne potresne sile po zidovima

Ukupna potresna poprečna sila:

$$V_{Ed} = 1330 \text{ kN}$$

Početna krutost zida bez otvora:

$$K_e = \frac{GA}{1.2h \left[ 1 + \alpha \frac{G}{E} \left( \frac{h}{L} \right)^2 \right]}$$

$E \cong$  modul elastičnosti:  $1000f_k$

$G =$  modul posmika ( $G \cong E/6$ )

$t =$  debljina zida

$h =$  svjetla visina zida  $L =$  duljina zida

$A =$  površina zida ( $A = t \cdot L$ )  $\alpha =$  proračunski koeficijent

za punu upetost na gornjem i

donjem katu  $\alpha = 0.83$  za konzolni zid  $\alpha = 3.33$

Početna krutost zida s otvorima za prozore

$$K_{e,otv.} = K_e \cdot k_1$$

$$k_1 = \left( 1 - \frac{t \sum L_i}{0.85A} \right)$$

$\sum L_i =$  zbroj duljina svih otvora u zidu

$A =$  površina zida ( $A = t \cdot L$ )

$$V_{Ed,ix} = V_{Ed} * K_{ix} / \Sigma K_{ix}$$

$$V_{Ed,iy} = V_{Ed} * K_{iy} / \Sigma K_{iy}$$

<b>F<sub>b</sub></b>	<b>1330</b>	<b>kN</b>	ukupna sila od potresa	
<b>M<sub>b</sub></b>	<b>12298</b>	<b>kNm</b>	ukupan moment od potresa	
<b>E</b>	<b>4960</b>	<b>MPa</b>	modul elastičnosti	
<b>G</b>	<b>827</b>	<b>MPa</b>	modul posmika	
<b>f<sub>k</sub></b>	<b>4,96</b>	<b>MPa</b>	tlačna čvrstoća zida	
<b>γ<sub>M</sub></b>	<b>1,5</b>		parcijalni faktor sigurnosti za žiđe	
<b>γ<sub>S</sub></b>	<b>1,15</b>		parcijalni faktor sigurnosti za čelik	
<b>h</b>	<b>3,00</b>	<b>m</b>	svijetla visina zida	
<b>α</b>	<b>3,33</b>	<b>m</b>		
<b>f<sub>vk0</sub></b>	<b>0,3</b>	<b>MPa</b>	osnovna posmična čvrstoća	

ZID	debljina zida t [m]	duljina zida L [m]	površina zida A [m <sup>2</sup> ]	Σ duljina otvora Li [m <sup>2</sup> ]	visina zida H [m]	početna krutost bez otvora K <sub>e</sub>	krutost k <sub>1</sub>	krutost sa otvorima K <sub>e,otv</sub>	poprečna sila V <sub>Sd</sub> [kN]	moment M <sub>Sd</sub> [kNm]
ZX1	0,25	9,70	2,43	2,4	9,4	528,8	0,71	374,9	382	3533
ZX2	0,25	4,72	1,18	0,0	9,4	221,3	1,00	221,3	226	2086
ZX3	0,25	2,60	0,65	0,0	9,4	85,8	1,00	85,8	88	809
ZX4	0,25	2,60	0,65	0,9	9,4	85,8	0,59	50,9	52	480
ZX5	0,25	2,60	0,65	0,0	9,4	85,8	1,00	85,8	88	809
ZX6	0,25	5,23	1,31	0,0	9,4	253,9	1,00	253,9	259	2393
ZX7	0,25	7,25	1,81	2,4	9,4	380,1	0,61	232,1	237	2187
								1304,7	1330	12298

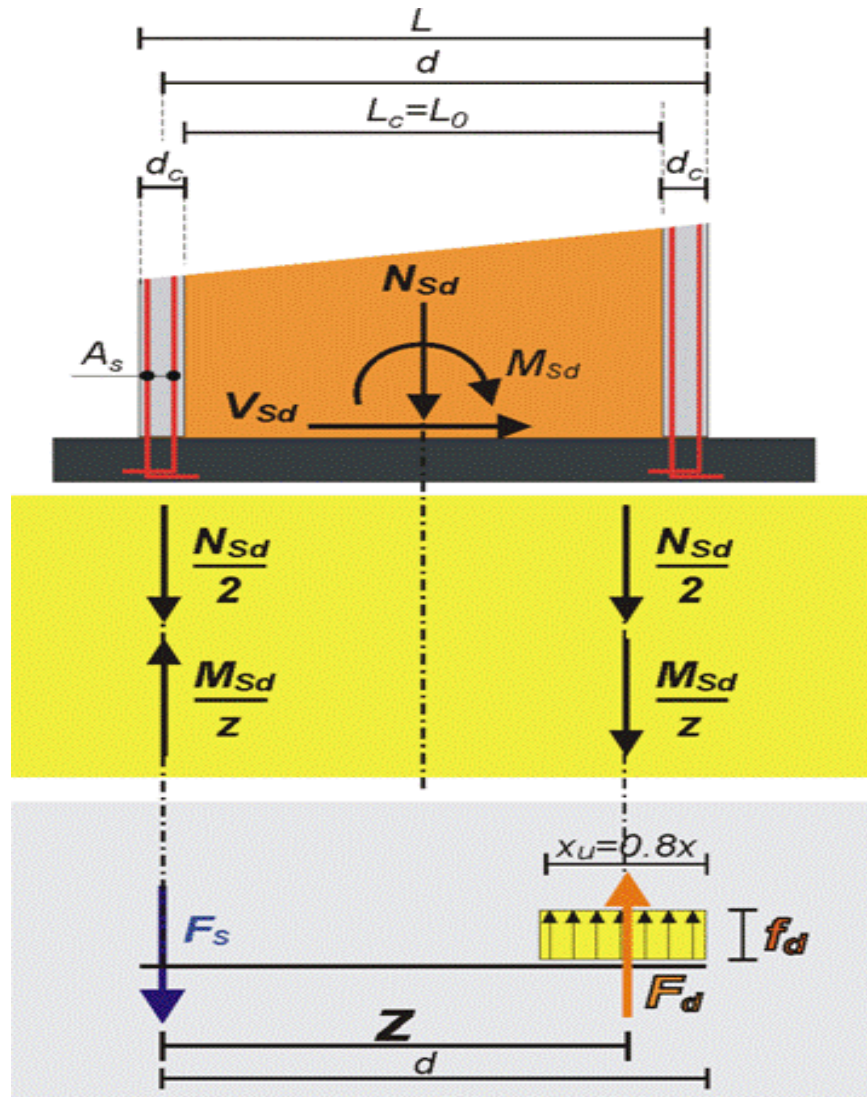

#### 4.2.4. Proračun zidova na potres

Podaci za proračun zidova:

tlačna čvrstoća zida:  $f_k = K \times f^{0.7} \times f_m^{0.3} =$

$0.45 \times 9^{0.7} \times 10.0^{0.3} = 4.18 \text{ MPa}$  parcijalni koef.

sigurnosti za materijale:  $\gamma_M = 1.5$

karakteristična posmična čvrstoća:  $f_{vk} = f_{vk0} + 0.4 \times \sigma_d =$

$f_{vk} < 0.065 \times f_b = 0.065 \times 9 = 0.59 \text{ MPa}$

U proračunu zidova na potres dokazuje se da je:



**1/  $V_{Sd} < V_{Rd}$**  računski poprečna sila:

$V_{Sd}$  računski nosivost na poprečnu silu:

$$V_{Rd} = A * f_{vk} / \gamma_M = x_u * t * f_{vk} / \gamma_M$$

**2/  $F_d < F_{Rd}$**

računski tlačna sila na rubu:  $F_d = M_{Sd} / z + N_{Sd} / 2$

računski uzdužna sila:  $N_{Sd} = (N_g + N_q * \psi_{2i})$

računski moment savijanja:  $M_{Sd}$

$z$  = krak unutarnjih sila;  $z \approx 0.8 * d$  računski nosivost na tlačnu

sili na rubu:

$$F_{Rd} = x_u * t * f_k / \gamma_m$$

$$x_u = 2(d-z) \approx 0.4 * d$$

$$\gamma_m = 1.5$$

Potrebna površina armature vertikalnih serklaža:

**3/  $A_{s1} = F_s / f_{yd}$  [cm<sup>2</sup>]** računski vlačna sila:

$$F_s = M_{Sd} / z - N_{Sd} / 2$$

$$f_{yd} = f_{yk} / \gamma_s$$

$$f_{yk} = 500 \text{ MPa}; \quad \gamma_s = 1.15$$

## Zid ZX1

<p><b>Geometrijske karakteristike zida:</b>  duljina zida: <math>L=9,70</math> m  debljina zida: <math>t=0.25</math> m  statička visina: <math>d=L-0.30/2=9,70-0.30/2=9,55</math> m  krak sila: <math>z=0.8*d=0.8*9,55=7,64</math> m  duljina zida u tlaku:  <math>x_u=2*(d-z)=2*(9,55-7,64)= 3,82</math> m</p> <p><b>Mehaničke karakteristike zida:</b>  tlačna čvrstoća: <math>f_k=4.96</math> MPa  osnovna posmična čvrstoća: <math>f_{vk0}=0.3</math> MPa</p> <p><b>Unutarnje sile:</b>  Poprečna sila: <math>V_{sd}=382</math> kN Moment:  <math>M_{sd}=3553</math> kNm  Uzdužna sila: <math>N_{sd}=N_g+0.3*N_q=583+0.3*86= 609</math> kN</p>	<p style="text-align: center;"><b>Proračun zida na potres:</b></p> <p><b>Dokaz nosivosti u tlaku:</b>  <math>F_d=N_{sd}/2+M_{sd}/z=609/2+3553/7,64= 770</math> kN  <math>F_{Rd}=f_k*t*x_u/\gamma_M=(4.96/10)*25*382/1.5= 3157</math> kN &gt; 664 kN</p> <p><b>Armatura vertikalnog serklaža:</b>  vlačna sila: <math>F_s=(M_{sd}/z-N_{sd}/2)=3553/7,64-609/2= 161</math> kN  <math>A_s=F_s/f_{yd}=161/(50/1.15)= 3.7</math> cm<sup>2</sup></p> <p><b>Nosivost na poprečnu silu:</b>  <math>f_{vk}=f_{vk0}+0.4\sigma_m=0.3+0.4*F_d/(t*x_u)</math>  <math>f_{vk}=0.3+0.4*770/(0.25*3.82)/1000=0,32</math> MPa &lt;  <math>0.065*f_b=0.065*9=0.59</math> MPa  <math>V_{Rd}=f_{vk}*x_u*t/\gamma_M=0.59*382*25/1.5/10= 396</math> kN &gt; 382 kN</p>
--	---

## Zid ZX2

<p><b>Geometrijske karakteristike zida:</b>  duljina zida: <math>L=4,72</math> m  debljina zida: <math>t=0.25</math> m  statička visina: <math>d=L-0.30/2=4,72-0.30/2=4.57</math> m  krak sila: <math>z=0.8*d=0.8*4.57=3.66</math> m  duljina zida u tlaku:  <math>x_u=2*(d-z)=2*(4.57-3.66)= 1,82</math> m</p> <p><b>Mehaničke karakteristike zida:</b>  tlačna čvrstoća: <math>f_k=4.96</math> MPa  osnovna posmična čvrstoća: <math>f_{vk0}=0.3</math> MPa</p> <p><b>Unutarnje sile:</b>  Poprečna sila: <math>V_{sd}=226</math> kN Moment:  <math>M_{sd}=2086</math> kNm  Uzdužna sila: <math>N_{sd}=N_g+0.3*N_q=625+0.3*136= 666</math> kN</p>	<p style="text-align: center;"><b>Proračun zida na potres:</b></p> <p><b>Dokaz nosivosti u tlaku:</b>  <math>F_d=N_{sd}/2+M_{sd}/z=666/2+2086/3.66= 903</math> kN  <math>F_{Rd}=f_k*t*x_u/\gamma_M=(4.96/10)*25*182/1.5= 1504</math> kN &gt; 903 kN</p> <p><b>Armatura vertikalnog serklaža:</b>  vlačna sila: <math>F_s=(M_{sd}/z-N_{sd}/2)=2086/3,66-666/2= 237</math> kN  <math>A_s=F_s/f_{yd}=237/(50/1.15)= 5.45</math> cm<sup>2</sup></p> <p><b>Nosivost na poprečnu silu:</b>  <math>f_{vk}=f_{vk0}+0.4\sigma_m=0.3+0.4*F_d/(t*x_u)</math>  <math>f_{vk}=0.3+0.4*903/(0.25*1.82)/1000=0,89</math> MPa &lt;  <math>0.065*f_b=0.065*9=0.59</math> MPa  <math>V_{Rd}=f_{vk}*x_u*t/\gamma_M=0.79*182*25/1.5/10= 240</math> kN &gt; 226 kN</p>
---	--

## Zid ZX3

<p><b>Geometrijske karakteristike zida:</b>  duljina zida: <math>L=2.60</math> m  debljina zida: <math>t=0.25</math> m  statička visina: <math>d=L-0.30/2=2.60-0.30/2=2.45</math> m  krak sila: <math>z=0.8*d=0.8*2.45=1.96</math> m  duljina zida u tlaku:  <math>x_u=2*(d-z)=2*(2.45-1.96)=0.98</math> m</p> <p><b>Mehaničke karakteristike zida:</b>  tlačna čvrstoća: <math>f_k=4.96</math> MPa  osnovna posmična čvrstoća: <math>f_{vk0}=0.3</math> MPa</p> <p><b>Unutarnje sile:</b>  Poprečna sila: <math>V_{sd}=88</math> kN Moment:  <math>M_{sd}=809</math> kNm  Uzdužna sila: <math>N_{sd}=N_g+0.3*N_q=226+0.3*43=239</math> kN</p>	<p><b>Proračun zida na potres:</b></p> <p><b>Dokaz nosivosti u tlaku:</b>  <math>F_d=N_{sd}/2+M_{sd}/z=239/2+809/1.96=532</math> kN  <math>F_{Rd}=f_k*t*x_u/\gamma_M=(4.96/10)*25*98/1.5=810</math> kN &gt; 532 kN</p> <p><b>Armatura vertikalnog serklaža:</b>  vlačna sila: <math>F_s=(M_{sd}/z-N_{sd}/2)=809/1.96-239/2=293</math> kN  <math>A_s=F_s/f_{yd}=293/(50/1.15)=6.78</math> cm<sup>2</sup></p> <p><b>Nosivost na poprečnu silu:</b>  <math>f_{vk}=f_{vk0}+0.4\sigma_m=0.3+0.4*F_d/(t*x_u)</math>  <math>f_{vk}=0.3+0.4*532/(0.25*0.98)/1000=0.87</math> MPa &lt;  <math>0.065*f_b=0.065*9=0.59</math> MPa  <math>V_{Rd}=f_{vk}*x_u*t/\gamma_M=0.87*98*25/1.5/10=142</math> kN &gt; 88 kN</p>
--	---

## Zid ZX4

<p><b>Geometrijske karakteristike zida:</b>  duljina zida: <math>L=2.60</math> m  debljina zida: <math>t=0.25</math> m  statička visina: <math>d=L-0.30/2=2.60-0.30/2=2.45</math> m  krak sila: <math>z=0.8*d=0.8*2.45=1.96</math> m  duljina zida u tlaku:  <math>x_u=2*(d-z)=2*(2.45-1.96)=0.98</math> m</p> <p><b>Mehaničke karakteristike zida:</b>  tlačna čvrstoća: <math>f_k=4.96</math> MPa  osnovna posmična čvrstoća: <math>f_{vk0}=0.3</math> MPa</p> <p><b>Unutarnje sile:</b>  Poprečna sila: <math>V_{sd}=52</math> kN Moment:  <math>M_{sd}=480</math> kNm  Uzdužna sila: <math>N_{sd}=N_g+0.3*N_q=104+0.3*15=109</math> kN</p>	<p><b>Proračun zida na potres:</b></p> <p><b>Dokaz nosivosti u tlaku:</b>  <math>F_d=N_{sd}/2+M_{sd}/z=109/2+480/1.96=300</math> kN  <math>F_{Rd}=f_k*t*x_u/\gamma_M=(4.96/10)*25*98/1.5=810</math> kN &gt; 300 kN</p> <p><b>Armatura vertikalnog serklaža:</b>  vlačna sila: <math>F_s=(M_{sd}/z-N_{sd}/2)=480/1.96-109/2=191</math> kN  <math>A_s=F_s/f_{yd}=191/(50/1.15)=4.39</math> cm<sup>2</sup></p> <p><b>Nosivost na poprečnu silu:</b>  <math>f_{vk}=f_{vk0}+0.4\sigma_m=0.3+0.4*F_d/(t*x_u)</math>  <math>f_{vk}=0.3+0.4*300/(0.25*0.98)/1000=0.49</math> MPa &lt;  <math>0.065*f_b=0.065*9=0.59</math> MPa  <math>V_{Rd}=f_{vk}*x_u*t/\gamma_M=0.59*98*25/1.5/10=96</math> kN &gt; 52 kN</p>
--	--

## Zid ZX5

<p><b>Geometrijske karakteristike zida:</b>  duljina zida: <math>L=2.60</math> m  debljina zida: <math>t=0.25</math> m</p> <p>statička visina: <math>d=L-0.30/2=2.60-0.30/2=2.45</math> m  krak sila: <math>z=0.8*d=0.8*2.45=1.96</math> m  duljina zida u tlaku:  <math>x_u=2*(d-z)=2*(2.45-1.96)=0.98</math> m</p> <p><b>Mehaničke karakteristike zida:</b>  tlačna čvrstoća: <math>f_k=4.96</math> MPa  osnovna posmična čvrstoća: <math>f_{vk0}=0.3</math> MPa</p> <p><b>Unutarnje sile:</b>  Poprečna sila: <math>V_{sd}=88</math> kN Moment:  <math>M_{sd}=809</math> kNm  Uzdužna sila: <math>N_{sd}=N_g+0.3*N_q=190+0.3*34=200</math> kN</p>	<p style="text-align: center;"><b>Proračun zida na potres:</b></p> <p><b>Dokaz nosivosti u tlaku:</b>  <math>F_d=N_{sd}/2+M_{sd}/z=200/2+809/1.96=513</math> kN  <math>F_{Rd}=f_k*t*x_u/\gamma_M=(4.96/10)*25*98/1.5=810</math> kN &gt; 513 kN</p> <p><b>Armatura vertikalnog serklaža:</b>  vlačna sila: <math>F_s=(M_{sd}/z-N_{sd}/2)=809/1.96-200/2=312</math> kN  <math>A_s=F_s/f_{yd}=312/(50/1.15)=7.17</math> cm<sup>2</sup></p> <p><b>Nosivost na poprečnu silu:</b>  <math>f_{vk}=f_{vk0}+0.4\sigma_m=0.3+0.4*F_d/(t*x_u)</math>  <math>f_{vk}=0.3+0.4*513/(0.25*0.98)/1000=0.84</math> MPa &lt;  <math>0.065*f_b=0.065*9=0.59</math> MPa  <math>V_{Rd}=f_{vk}*x_u*t/\gamma_M=0.84*98*25/1.5/10=137</math> kN &gt; 88 kN</p>
--	---

## Zid ZX6

<p><b>Geometrijske karakteristike zida:</b>  duljina zida: <math>L=5.23</math> m  debljina zida: <math>t=0.25</math> m</p> <p>statička visina: <math>d=L-0.30/2=5.23-0.30/2=5.08</math> m  krak sila: <math>z=0.8*d=0.8*5.08=4.06</math> m  duljina zida u tlaku:  <math>x_u=2*(d-z)=2*(5.08-4.06)=2.04</math> m</p> <p><b>Mehaničke karakteristike zida:</b>  tlačna čvrstoća: <math>f_k=4.96</math> MPa  osnovna posmična čvrstoća: <math>f_{vk0}=0.3</math> MPa</p> <p><b>Unutarnje sile:</b>  Poprečna sila: <math>V_{sd}=259</math> kN Moment:  <math>M_{sd}=2393</math> kNm  Uzdužna sila: <math>N_{sd}=N_g+0.3*N_q=639+0.3*136=680</math> kN</p>	<p style="text-align: center;"><b>Proračun zida na potres:</b></p> <p><b>Dokaz nosivosti u tlaku:</b>  <math>F_d=N_{sd}/2+M_{sd}/z=680/2+2393/4.06=929</math> kN  <math>F_{Rd}=f_k*t*x_u/\gamma_M=(4.96/10)*25*204/1.5=1686</math> kN &gt; 929 kN</p> <p><b>Armatura vertikalnog serklaža:</b>  vlačna sila: <math>F_s=(M_{sd}/z-N_{sd}/2)=2393/4.06-680/2=249</math> kN  <math>A_s=F_s/f_{yd}=249/(50/1.15)=5.73</math> cm<sup>2</sup></p> <p><b>Nosivost na poprečnu silu:</b>  <math>f_{vk}=f_{vk0}+0.4\sigma_m=0.3+0.4*F_d/(t*x_u)</math>  <math>f_{vk}=0.3+0.4*929/(0.25*2.04)/1000=0.73</math> MPa &lt;  <math>0.065*f_b=0.065*9=0.59</math> MPa  <math>V_{Rd}=f_{vk}*x_u*t/\gamma_M=0.73*204*25/1.5/10=260</math> kN &gt; 259 kN</p>
---	---

**Zid ZX7**

<p><b>Geometrijske karakteristike zida:</b>  duljina zida: <math>L=7,25</math> m  debljina zida: <math>t=0.25</math> m  statička visina: <math>d=L-0.30/2=7.25-0.30/2=7.10</math> m  krak sila: <math>z=0.8*d=0.8*7.10=5.68</math> m  duljina zida u tlaku:  <math>x_u=2*(d-z)=2*(7.10-5.68)=2.84</math> m</p> <p><b>Mehaničke karakteristike zida:</b>  tlačna čvrstoća: <math>f_k=4.96</math> MPa  osnovna posmična čvrstoća: <math>f_{vk0}=0.3</math> MPa</p> <p><b>Unutarnje sile:</b>  Poprečna sila: <math>V_{Sd}=237</math> kN Moment:  <math>M_{Sd}=2187</math> kNm  Uzdužna sila: <math>N_{Sd}=N_g+0.3*N_q=665+0.3*105=697</math> kN</p>	<p><b>Proračun zida na potres: Dokaz nosivosti u tlaku:</b>  <math>F_d=N_{Sd}/2+M_{Sd}/z=697/2+2187/5.68=734</math> kN  <math>F_{Rd}=f_k*t*x_u/\gamma_M=(4.96/10)*25*284/1.5=2348</math> kN &gt; 734 kN</p> <p><b>Armatura vertikalnog serklaža:</b>  vlačna sila: <math>F_s=(M_{Sd}/z-N_{Sd}/2)=2184/5.68-697/2=36</math> kN  <math>A_s=F_s/f_{yd}=249/(50/1.15)=0.83</math> cm<sup>2</sup></p> <p><b>Nosivost na poprečnu silu:</b>  <math>f_{vk}=f_{vk0}+0.4\sigma_m=0.3+0.4*F_d/(t*x_u)</math>  <math>f_{vk}=0.3+0.4*734/(0.25*2.84)/1000=0.41</math> MPa &lt;  <math>0.065*f_b=0.065*9=0.59</math> MPa  <math>V_{Rd}=f_{vk}*x_u*t/\gamma_M=0.59*284*25/1.5/10=280</math> kN &gt; 237 kN</p>
---	--

ZID	deblji na zida t [m]	dulji na zida L [m]	površni na zida A [m <sup>2</sup> ]	Σdulji na otvora Li [m <sup>2</sup> ]	visin a zida H [m]	počet na krutos t bez otvor a K <sub>e</sub>	kruto st k <sub>1</sub>	krutost sa otvori ma K <sub>e,otv</sub>	popreč na sila V <sub>Sd</sub> [kN]	mome nt M <sub>Sd</sub> [kNm]
ZY1	0,25	5,35	1,34	1,2	9,4	261,5	0,74	192,5	158	1459
ZY2	0,25	11,93	2,98	1,8	9,4	661,6	0,82	544,2	446	4126
ZY3	0,25	6,83	1,71	1,7	9,4	354,2	0,72	253,5	208	1922
ZY4	0,25	6,83	1,71	1,0	9,4	354,2	0,83	293,2	240	2223
ZY5	0,25	5,25	1,31	1,8	9,4	255,1	0,60	152,2	125	1154
ZY6	0,25	5,25	1,31	1,2	9,4	255,1	0,73	186,5	153	1414
								1622,1	1330	12298

## Zid ZY1

<p><b>Geometrijske karakteristike zida:</b>  duljina zida: <math>L=5,35</math> m  debljina zida: <math>t=0,25</math> m  statička visina: <math>d=L-0,30/2=5,35-0,30/2=5,20</math> m  krak sila: <math>z=0,8*d=0,8*5,20=4,16</math> m  duljina zida u tlaku:  <math>x_u=2*(d-z)=2*(5,20-4,16)= 2,08</math> m</p> <p><b>Mehaničke karakteristike zida:</b>  tlačna čvrstoća: <math>f_k=4,96</math> MPa  osnovna posmična čvrstoća: <math>f_{vk0}=0,3</math> MPa</p> <p><b>Unutarnje sile:</b>  Poprečna sila: <math>V_{Sd}=158</math> kN Moment:  <math>M_{Sd}=1459</math> kNm  Uzdužna sila: <math>N_{Sd}=N_g+0,3*N_q=238+0,3*22= 245</math> kN</p>	<p style="text-align: center;"><b>Proračun zida na potres:</b></p> <p><b>Dokaz nosivosti u tlaku:</b>  <math>F_d=N_{Sd}/2+M_{Sd}/z=245/2+1459/4,16= 473</math> kN  <math>F_{Rd}=f_k*t*x_u/\gamma_M=(4,96/10)*25*208/1,5= 1720</math> kN &gt; 473 kN</p> <p><b>Armatura vertikalnog serklaža:</b>  vlačna sila: <math>F_s=(M_{Sd}/z-N_{Sd}/2)=1459/4,16-245/2= 228</math> kN  <math>A_s=F_s/f_{yd}=228/(50/1,15)= 5,25</math> cm<sup>2</sup></p> <p><b>Nosivost na poprečnu silu:</b>  <math>f_{vk}=f_{vk0}+0,4\sigma_m=0,3+0,4*F_d/(t*x_u)</math>  <math>f_{vk}=0,3+0,4*473/(0,25*2,08)/1000=0,36</math> MPa &lt;  <math>0,065*f_b=0,065*9=0,59</math> MPa  <math>V_{Rd}=f_{vk}*x_u*t/\gamma_M=0,59*208*25/1,5/10= 205</math> kN &gt; 158 kN</p>
--	--

## Zid ZY2

<p><b>Geometrijske karakteristike zida:</b>  duljina zida: <math>L=11,93</math> m  debljina zida: <math>t=0,25</math> m  statička visina: <math>d=L-0,30/2=11,93-0,30/2=11,78</math> m  krak sila: <math>z=0,8*d=0,8*11,78=9,42</math> m  duljina zida u tlaku:  <math>x_u=2*(d-z)=2*(11,78-9,42)= 4,72</math> m</p> <p><b>Mehaničke karakteristike zida:</b>  tlačna čvrstoća: <math>f_k=4,96</math> MPa  osnovna posmična čvrstoća: <math>f_{vk0}=0,3</math> MPa</p> <p><b>Unutarnje sile:</b>  Poprečna sila: <math>V_{Sd}=446</math> kN Moment:  <math>M_{Sd}=4162</math> kNm  Uzdužna sila: <math>N_{Sd}=N_g+0,3*N_q=574+0,3*59= 592</math> kN</p>	<p style="text-align: center;"><b>Proračun zida na potres:</b></p> <p><b>Dokaz nosivosti u tlaku:</b>  <math>F_d=N_{Sd}/2+M_{Sd}/z=592/2+4162/9,42= 738</math> kN  <math>F_{Rd}=f_k*t*x_u/\gamma_M=(4,96/10)*25*472/1,5= 3902</math> kN &gt; 738 kN</p> <p><b>Armatura vertikalnog serklaža:</b>  vlačna sila: <math>F_s=(M_{Sd}/z-N_{Sd}/2)=4162/9,42-592/2= 146</math> kN  <math>A_s=F_s/f_{yd}=146/(50/1,15)= 3,36</math> cm<sup>2</sup></p> <p><b>Nosivost na poprečnu silu:</b>  <math>f_{vk}=f_{vk0}+0,4\sigma_m=0,3+0,4*F_d/(t*x_u)</math>  <math>f_{vk}=0,3+0,4*738/(0,25*4,72)/1000=0,44</math> MPa &lt;  <math>0,065*f_b=0,065*9=0,59</math> MPa  <math>V_{Rd}=f_{vk}*x_u*t/\gamma_M=0,59*472*25/1,5/10= 464</math> kN &gt; 446 kN</p>
---	--

## Zid ZY3

<p><b>Geometrijske karakteristike zida:</b>  duljina zida: <math>L=6.83</math> m  debljina zida: <math>t=0.25</math> m  statička visina: <math>d=L-0.30/2=6.83-0.30/2=6.68</math> m  krak sila: <math>z=0.8*d=0.8*6.68=5.34</math> m  duljina zida u tlaku:  <math>x_u=2*(d-z)=2*(6.68-5.34)=2.68</math> m</p> <p><b>Mehaničke karakteristike zida:</b>  tlačna čvrstoća: <math>f_k=4.96</math> MPa  osnovna posmična čvrstoća: <math>f_{vk0}=0.3</math> MPa</p> <p><b>Unutarnje sile:</b>  Poprečna sila: <math>V_{sd}=208</math> kN Moment:  <math>M_{sd}=1922</math> kNm  Uzdužna sila: <math>N_{sd}=N_g+0.3*N_q=278+0.3*21=285</math> kN</p>	<p><b>Proračun zida na potres:</b></p> <p><b>Dokaz nosivosti u tlaku:</b>  <math>F_d=N_{sd}/2+M_{sd}/z=285/2+1922/5.34=502</math> kN  <math>F_{Rd}=f_k*t*x_u/\gamma_M=(4.96/10)*25*268/1.5=2215</math> kN &gt; 502 kN</p> <p><b>Armatura vertikalnog serklaža:</b>  vlačna sila: <math>F_s=(M_{sd}/z-N_{sd}/2)=1922/5.34-285/2=217</math> kN  <math>A_s=F_s/f_{yd}=217/(50/1.15)=4.99</math> cm<sup>2</sup></p> <p><b>Nosivost na poprečnu silu:</b>  <math>f_{vk}=f_{vk0}+0.4\sigma_m=0.3+0.4*F_d/(t*x_u)</math>  <math>f_{vk}=0.3+0.4*502/(0.25*2.68)/1000=0.3</math> MPa &lt;  <math>0.065*f_b=0.065*9=0.59</math> MPa  <math>V_{Rd}=f_{vk}*x_u*t/\gamma_M=0.59*268*25/1.5/10=264</math> kN &gt; 208 kN</p>
--	--

## Zid ZY4

<p><b>Geometrijske karakteristike zida:</b>  duljina zida: <math>L=6.83</math> m  debljina zida: <math>t=0.25</math> m  statička visina: <math>d=L-0.30/2=6.83-0.30/2=6.68</math> m  krak sila: <math>z=0.8*d=0.8*6.68=5.34</math> m  duljina zida u tlaku:  <math>x_u=2*(d-z)=2*(6.68-5.34)=2.68</math> m</p> <p><b>Mehaničke karakteristike zida:</b>  tlačna čvrstoća: <math>f_k=4.96</math> MPa  osnovna posmična čvrstoća: <math>f_{vk0}=0.3</math> MPa</p> <p><b>Unutarnje sile:</b>  Poprečna sila: <math>V_{sd}=240</math> kN Moment:  <math>M_{sd}=2223</math> kNm  Uzdužna sila: <math>N_{sd}=N_g+0.3*N_q=424+0.3*59=442</math> kN</p>	<p><b>Proračun zida na potres:</b></p> <p><b>Dokaz nosivosti u tlaku:</b>  <math>F_d=N_{sd}/2+M_{sd}/z=442/2+2223/5.34=634</math> kN  <math>F_{Rd}=f_k*t*x_u/\gamma_M=(4.96/10)*25*268/1.5=2215</math> kN &gt; 634 kN</p> <p><b>Armatura vertikalnog serklaža:</b>  vlačna sila: <math>F_s=(M_{sd}/z-N_{sd}/2)=2223/5.34-442/2=195</math> kN  <math>A_s=F_s/f_{yd}=195/(50/1.15)=4.48</math> cm<sup>2</sup></p> <p><b>Nosivost na poprečnu silu:</b>  <math>f_{vk}=f_{vk0}+0.4\sigma_m=0.3+0.4*F_d/(t*x_u)</math>  <math>f_{vk}=0.3+0.4*634/(0.25*2.68)/1000=0.38</math> MPa &lt;  <math>0.065*f_b=0.065*9=0.59</math> MPa  <math>V_{Rd}=f_{vk}*x_u*t/\gamma_M=0.59*268*25/1.5/10=264</math> kN &gt; 240 kN</p>
--	---



## Zid ZY5

<p><b>Geometrijske karakteristike zida:</b>  duljina zida: <math>L=5.25</math> m  debljina zida: <math>t=0.25</math> m  statička visina: <math>d=L-0.30/2=5.25-0.30/2=5.10</math> m  krak sila: <math>z=0.8*d=0.8*5.10=4.08</math> m  duljina zida u tlaku:  <math>x_u=2*(d-z)=2*(5.10-4.08)=2.04</math> m</p> <p><b>Mehaničke karakteristike zida:</b>  tlačna čvrstoća: <math>f_k=4.96</math> MPa  osnovna posmična čvrstoća: <math>f_{vk0}=0.3</math> MPa</p> <p><b>Unutarnje sile:</b>  Poprečna sila: <math>V_{sd}=125</math> kN Moment:  <math>M_{sd}=1154</math> kNm  Uzdužna sila: <math>N_{sd}=N_g+0.3*N_q=240+0.3*23=247</math> kN</p>	<p style="text-align: center;"><b>Proračun zida na potres:</b></p> <p><b>Dokaz nosivosti u tlaku:</b>  <math>F_d=N_{sd}/2+M_{sd}/z=247/2+1154/4.08=406</math> kN  <math>F_{Rd}=f_k*t*x_u/\gamma_M=(4.96/10)*25*204/1.5=1686</math> kN &gt; 406 kN</p> <p><b>Armatura vertikalnog serklaža:</b>  vlačna sila: <math>F_s=(M_{sd}/z-N_{sd}/2)=1154/4.08-247/2=159</math> kN  <math>A_s=F_s/f_{yd}=159/(50/1.15)=3.66</math> cm<sup>2</sup></p> <p><b>Nosivost na poprečnu silu:</b>  <math>f_{vk}=f_{vk0}+0.4\sigma_m=0.3+0.4*F_d/(t*x_u)</math>  <math>f_{vk}=0.3+0.4*406/(0.25*2.04)/1000=0.32</math> MPa &lt;  <math>0.065*f_b=0.065*9=0.59</math> MPa  <math>V_{Rd}=f_{vk}*x_u*t/\gamma_M=0.59*204*25/1.5/10=201</math> kN &gt; 125 kN</p>
--	---

## Zid ZY6

<p><b>Geometrijske karakteristike zida:</b>  duljina zida: <math>L=5.25</math> m  debljina zida: <math>t=0.25</math> m  statička visina: <math>d=L-0.30/2=5.25-0.30/2=5.10</math> m  krak sila: <math>z=0.8*d=0.8*5.10=4.08</math> m  duljina zida u tlaku:  <math>x_u=2*(d-z)=2*(5.10-4.08)=2.04</math> m</p> <p><b>Mehaničke karakteristike zida:</b>  tlačna čvrstoća: <math>f_k=4.96</math> MPa  osnovna posmična čvrstoća: <math>f_{vk0}=0.3</math> MPa</p> <p><b>Unutarnje sile:</b>  Poprečna sila: <math>V_{sd}=153</math> kN Moment:  <math>M_{sd}=1414</math> kNm  Uzdužna sila: <math>N_{sd}=N_g+0.3*N_q=240+0.3*23=247</math> kN</p>	<p style="text-align: center;"><b>Proračun zida na potres:</b></p> <p><b>Dokaz nosivosti u tlaku:</b>  <math>F_d=N_{sd}/2+M_{sd}/z=247/2+1414/4.08=470</math> kN  <math>F_{Rd}=f_k*t*x_u/\gamma_M=(4.96/10)*25*204/1.5=1686</math> kN &gt; 470 kN</p> <p><b>Armatura vertikalnog serklaža:</b>  vlačna sila: <math>F_s=(M_{sd}/z-N_{sd}/2)=1414/4.08-247/2=223</math> kN  <math>A_s=F_s/f_{yd}=223/(50/1.15)=5.12</math> cm<sup>2</sup></p> <p><b>Nosivost na poprečnu silu:</b>  <math>f_{vk}=f_{vk0}+0.4\sigma_m=0.3+0.4*F_d/(t*x_u)</math>  <math>f_{vk}=0.3+0.4*470/(0.25*2.04)/1000=0.37</math> MPa &lt;  <math>0.065*f_b=0.065*9=0.59</math> MPa  <math>V_{Rd}=f_{vk}*x_u*t/\gamma_M=0.59*204*25/1.5/10=201</math> kN &gt; 153 kN</p>
--	---

## 5. PRORAČUN TEMELJA

### TEMELJNA TRAKA U OSI 1

<p><b>Analiza opterećenja:</b></p> <p>Uzdužna sila u zidu ZX1(L=9.7 m):          stalno djelovanje: <math>N_g=583</math> KN          korisno djelovanje: <math>N_q=86</math> KN</p> <p>Težina temeljne trake:          (pretpostavka B/H=50 cm/50 cm):  <math>N_{g,i}=B \cdot H \cdot L \cdot \gamma_B</math>  <math>N_{g,i}=0.5 \cdot 0.5 \cdot 9.7 \cdot 25 = 61</math> kN</p> <p><b>Računska uzdužna sila:</b></p> <p><math>N_{sd}=1.35 \cdot (N_g + N_{g,i}) + 1.5 \cdot N_q</math>  <math>N_{sd}=1.35 \cdot (583 + 61) + 1.5 \cdot 86 = 999</math> kN  <math>n_{sd} = N_{sd} / L = 999 / 9.70 = 103</math> kN/m</p>	<p><b>Proračun širine temeljne trake:</b></p> <p>Dopuštena nosivost tla:</p> <p><math>\sigma_{Rd} = 250</math> kPa          Naprezanje u tlu:  <math>\sigma_{sd} = n_{sd} / (B \cdot 1.0 \text{ m}) &lt; \sigma_{Rd}</math></p> <p>Širina temeljne trake:</p> <p><math>B &gt; n_{sd} / \sigma_{Rd}</math>  <math>B &gt; 103 / 250 = 0.41</math> m (usvojeno 50 cm)</p>
--	--

### TEMELJNA TRAKA U OSI 2

<p><b>Analiza opterećenja:</b></p> <p>Uzdužna sila u zidu ZX2, ZX3(L=10.70 m):          stalno djelovanje: <math>N_g=851</math> KN          korisno djelovanje: <math>N_q=179</math> KN</p> <p>Težina temeljne trake:          (pretpostavka B/H=50 cm/50 cm):  <math>N_{g,i}=B \cdot H \cdot L \cdot \gamma_B</math>  <math>N_{g,i}=0.5 \cdot 0.5 \cdot 10.7 \cdot 25 = 67</math> kN</p> <p><b>Računska uzdužna sila:</b></p> <p><math>N_{sd}=1.35 \cdot (N_g + N_{g,i}) + 1.5 \cdot N_q</math>  <math>N_{sd}=1.35 \cdot (851 + 67) + 1.5 \cdot 179 = 1507</math> kN  <math>n_{sd} = N_{sd} / L = 1507 / 10.70 = 140</math> kN/m</p>	<p><b>Proračun širine temeljne trake:</b></p> <p>Dopuštena nosivost tla:</p> <p><math>\sigma_{Rd} = 250</math> kPa          Naprezanje u tlu:  <math>\sigma_{sd} = n_{sd} / (B \cdot 1.0 \text{ m}) &lt; \sigma_{Rd}</math></p> <p>Širina temeljne trake:</p> <p><math>B &gt; n_{sd} / \sigma_{Rd}</math>  <math>B &gt; 140 / 250 = 0.56</math> m (usvojeno 60 cm)</p>
---	--

**TEMELJNA TRAKA U OSI 3**

<p><b>Analiza opterećenja:</b></p> <p>Uzdužna sila u zidu ZX4(L=2.60 m):          stalno djelovanje: <math>N_g=104</math> KN          korisno djelovanje: <math>N_q=15</math> KN</p> <p>Težina temeljne trake:          (pretpostavka B/H=50 cm/50 cm):  <math>N_{g,t}=B \cdot H \cdot L \cdot \gamma_B</math>  <math>N_{g,t}=0.5 \cdot 0.5 \cdot 2.6 \cdot 25 = 17</math> kN</p> <p><b>Računska uzdužna sila:</b></p> <p><math>N_{sd}=1.35 \cdot (N_g + N_{g,t}) + 1.5 \cdot N_q</math>  <math>N_{sd}=1.35 \cdot (104 + 17) + 1.5 \cdot 15 = 186</math> kN  <math>n_{sd} = N_{sd} / L = 186 / 2.60 = 72</math> kN/m</p>	<p><b>Proračun širine temeljne trake:</b></p> <p>Dopuštena nosivost tla:</p> <p><math>\sigma_{Rd}=250</math> kPa          Naprezanje u tlu:  <math>\sigma_{sd} = n_{sd} / (B \cdot 1.0 \text{ m}) &lt; \sigma_{Rd}</math></p> <p>Širina temeljne trake:</p> <p><math>B &gt; n_{sd} / \sigma_{Rd}</math>  <math>B &gt; 72 / 250 = 0.29</math> m (usvojeno 50 cm)</p>
--	---

**TEMELJNA TRAKA U OSI 4**

<p><b>Analiza opterećenja:</b></p> <p>Uzdužna sila u zidu ZX5, ZX6(L=11.20 m):          stalno djelovanje: <math>N_g=829</math> KN          korisno djelovanje: <math>N_q=170</math> KN</p> <p>Težina temeljne trake:          (pretpostavka B/H=50 cm/50 cm):  <math>N_{g,t}=B \cdot H \cdot L \cdot \gamma_B</math>  <math>N_{g,t}=0.5 \cdot 0.5 \cdot 11.2 \cdot 25 = 70</math> kN</p> <p><b>Računska uzdužna sila:</b></p> <p><math>N_{sd}=1.35 \cdot (N_g + N_{g,t}) + 1.5 \cdot N_q</math>  <math>N_{sd}=1.35 \cdot (829 + 70) + 1.5 \cdot 170 = 1468</math> kN  <math>n_{sd} = N_{sd} / L = 1468 / 11.20 = 131</math> kN/m</p>	<p><b>Proračun širine temeljne trake:</b></p> <p>Dopuštena nosivost tla:</p> <p><math>\sigma_{Rd}=250</math> kPa          Naprezanje u tlu:  <math>\sigma_{sd} = n_{sd} / (B \cdot 1.0 \text{ m}) &lt; \sigma_{Rd}</math></p> <p>Širina temeljne trake:</p> <p><math>B &gt; n_{sd} / \sigma_{Rd}</math>  <math>B &gt; 131 / 250 = 0.53</math> m (usvojeno 60 cm)</p>
---	--

**TEMELJNA TRAKA U OSI 5**

<p><b>Analiza opterećenja:</b></p> <p>Uzdužna sila u zidu ZX7(L=10.20 m):          stalno djelovanje: <math>N_g=665</math> KN          korisno djelovanje: <math>N_q=105</math> KN</p> <p>Težina temeljne trake:          (pretpostavka B/H=50 cm/50 cm):  <math>N_{g,t}=B \cdot H \cdot L \cdot \gamma_B</math>  <math>N_{g,t}=0.5 \cdot 0.5 \cdot 10.20 \cdot 25 = 64</math> kN</p> <p><b>Računska uzdužna sila:</b></p> <p><math>N_{sd}=1.35 \cdot (N_g + N_{g,t}) + 1.5 \cdot N_q</math>  <math>N_{sd}=1.35 \cdot (665 + 64) + 1.5 \cdot 105 = 1142</math> kN  <math>n_{sd} = N_{sd} / L = 1142 / 10.20 = 112</math> kN/m</p>	<p><b>Proračun širine temeljne trake:</b></p> <p>Dopuštena nosivost tla:</p> <p><math>\sigma_{Rd}=250</math> kPa          Naprezanje u tlu:  <math>\sigma_{sd} = n_{sd} / (B \cdot 1.0 \text{ m}) &lt; \sigma_{Rd}</math></p> <p>Širina temeljne trake:</p> <p><math>B &gt; n_{sd} / \sigma_{Rd}</math>  <math>B &gt; 112 / 250 = 0.45</math> m (usvojeno 50 cm)</p>
---	--

**TEMELJNA TRAKA U OSI A**

<p><b>Analiza opterećenja:</b></p> <p>Uzdužna sila u zidu ZY3 (L=6.83 m):          stalno djelovanje: <math>N_g=278</math> KN          korisno djelovanje: <math>N_q=21</math> KN</p> <p>Težina temeljne trake:          (pretpostavka B/H=50 cm/50 cm):  <math>N_{g,t}=B \cdot H \cdot L \cdot \gamma_B</math>  <math>N_{g,t}=0.5 \cdot 0.5 \cdot 6.83 \cdot 25 = 43</math> kN</p> <p><b>Računska uzdužna sila:</b></p> <p><math>N_{sd}=1.35 \cdot (N_g + N_{g,t}) + 1.5 \cdot N_q</math>  <math>N_{sd}=1.35 \cdot (278 + 43) + 1.5 \cdot 21 = 465</math> kN  <math>n_{sd} = N_{sd} / L = 465 / 6.83 = 68</math> kN/m</p>	<p><b>Proračun širine temeljne trake:</b></p> <p>Dopuštena nosivost tla:</p> <p><math>\sigma_{Rd}=250</math> kPa          Naprezanje u tlu:  <math>\sigma_{sd} = n_{sd} / (B \cdot 1.0 \text{ m}) &lt; \sigma_{Rd}</math></p> <p>Širina temeljne trake:</p> <p><math>B &gt; n_{sd} / \sigma_{Rd}</math>  <math>B &gt; 68 / 250 = 0.27</math> m (usvojeno 50 cm)</p>
--	---

**TEMELJNA TRAKA U OSI B**

<p><b>Analiza opterećenja:</b></p> <p>Uzdužna sila u zidu ZY3, ZY5 (L=10.60 m):          stalno djelovanje: <math>N_g=478</math> KN          korisno djelovanje: <math>N_q=45</math> KN</p> <p>Težina temeljne trake:          (pretpostavka B/H=50 cm/50 cm):  <math>N_{g,i}=B \cdot H \cdot L \cdot \gamma_B</math>  <math>N_{g,i}=0.5 \cdot 0.5 \cdot 10.60 \cdot 25 = 66</math> kN</p> <p><b>Računska uzdužna sila:</b></p> <p><math>N_{sd}=1.35 \cdot (N_g + N_{g,i}) + 1.5 \cdot N_q</math>  <math>N_{sd}=1.35 \cdot (478 + 66) + 1.5 \cdot 45 = 802</math> kN  <math>n_{sd} = N_{sd} / L = 802 / 10.60 = 76</math> kN/m</p>	<p><b>Proračun širine temeljne trake:</b></p> <p>Dopuštena nosivost tla:</p> <p><math>\sigma_{Rd}=250</math> kPa          Naprezanje u tlu:  <math>\sigma_{sd} = n_{sd} / (B \cdot 1.0 \text{ m}) &lt; \sigma_{Rd}</math></p> <p>Širina temeljne trake:</p> <p><math>B &gt; n_{sd} / \sigma_{Rd}</math>  <math>B &gt; 76 / 250 = 0.31</math> m (usvojeno 50 cm)</p>
--	---

**TEMELJNA TRAKA U OSI C**

<p><b>Analiza opterećenja:</b></p> <p>Uzdužna sila u zidu ZY4(L=6.83 m):          stalno djelovanje: <math>N_g=278</math> KN          korisno djelovanje: <math>N_q=21</math> KN</p> <p>Težina temeljne trake:          (pretpostavka B/H=50 cm/50 cm):  <math>N_{g,i}=B \cdot H \cdot L \cdot \gamma_B</math>  <math>N_{g,i}=0.5 \cdot 0.5 \cdot 6.83 \cdot 25 = 43</math> kN</p> <p><b>Računska uzdužna sila:</b></p> <p><math>N_{sd}=1.35 \cdot (N_g + N_{g,i}) + 1.5 \cdot N_q</math>  <math>N_{sd}=1.35 \cdot (278 + 43) + 1.5 \cdot 21 = 719</math> kN  <math>n_{sd} = N_{sd} / L = 719 / 6.83 = 106</math> kN/m</p>	<p><b>Proračun širine temeljne trake:</b></p> <p>Dopuštena nosivost tla:</p> <p><math>\sigma_{Rd}=250</math> kPa          Naprezanje u tlu:  <math>\sigma_{sd} = n_{sd} / (B \cdot 1.0 \text{ m}) &lt; \sigma_{Rd}</math></p> <p>Širina temeljne trake:</p> <p><math>B &gt; n_{sd} / \sigma_{Rd}</math>  <math>B &gt; 106 / 250 = 0.42</math> m (usvojeno 50 cm)</p>
--	--

**TEMELJNA TRAKA U OSI D**

<p><b>Analiza opterećenja:</b></p> <p>Uzdužna sila u zidu ZY4(L=11.93 m):          stalno djelovanje: <math>N_g=574</math> KN          korisno djelovanje: <math>N_q=59</math> KN</p> <p>Težina temeljne trake:          (pretpostavka B/H=50 cm/50 cm):  <math>N_{g,i}=B \cdot H \cdot L \cdot \gamma_B</math>  <math>N_{g,i}=0.5 \cdot 0.5 \cdot 11.93 \cdot 25 = 73</math> kN</p> <p><b>Računska uzdužna sila:</b></p> <p><math>N_{sd}=1.35 \cdot (N_g + N_{g,i}) + 1.5 \cdot N_q</math>  <math>N_{sd}=1.35 \cdot (574 + 73) + 1.5 \cdot 59 = 962</math> kN  <math>n_{sd} = N_{sd} / L = 962 / 11.93 = 81</math> kN/m</p>	<p><b>Proračun širine temeljne trake:</b></p> <p>Dopuštena nosivost tla:</p> <p><math>\sigma_{Rd}=250</math> kPa          Naprezanje u tlu:  <math>\sigma_{sd} = n_{sd} / (B \cdot 1.0 \text{ m}) &lt; \sigma_{Rd}</math></p> <p>Širina temeljne trake:</p> <p><math>B &gt; n_{sd} / \sigma_{Rd}</math>  <math>B &gt; 81 / 250 = 0.32</math> m (usvojeno 50 cm)</p>
--	---

**TEMELJNA TRAKA U OSI E**

<p><b>Analiza opterećenja:</b></p> <p>Uzdužna sila u zidu ZY6(L=5.25 m):          stalno djelovanje: <math>N_g=240</math> KN          korisno djelovanje: <math>N_q=23</math> KN</p> <p>Težina temeljne trake:          (pretpostavka B/H=50 cm/50 cm):  <math>N_{g,i}=B \cdot H \cdot L \cdot \gamma_B</math>  <math>N_{g,i}=0.5 \cdot 0.5 \cdot 5.25 \cdot 25 = 33</math> kN</p> <p><b>Računska uzdužna sila:</b></p> <p><math>N_{sd}=1.35 \cdot (N_g + N_{g,i}) + 1.5 \cdot N_q</math>  <math>N_{sd}=1.35 \cdot (240 + 33) + 1.5 \cdot 23 = 404</math> kN  <math>n_{sd} = N_{sd} / L = 404 / 5.25 = 77</math> kN/m</p>	<p><b>Proračun širine temeljne trake:</b></p> <p>Dopuštena nosivost tla:</p> <p><math>\sigma_{Rd}=250</math> kPa          Naprezanje u tlu:  <math>\sigma_{sd} = n_{sd} / (B \cdot 1.0 \text{ m}) &lt; \sigma_{Rd}</math></p> <p>Širina temeljne trake:</p> <p><math>B &gt; n_{sd} / \sigma_{Rd}</math>  <math>B &gt; 77 / 250 = 0.31</math> m (usvojeno 50 cm)</p>
---	---

## **6. GRAĐEVINSKI NACRTI**

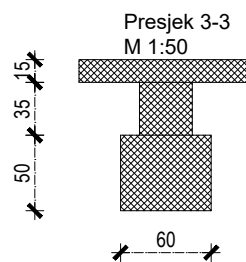
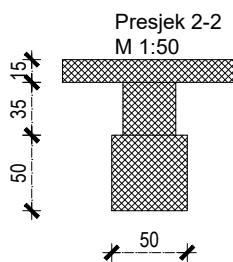
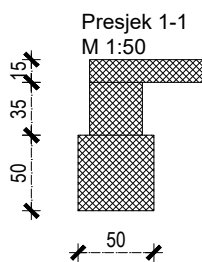
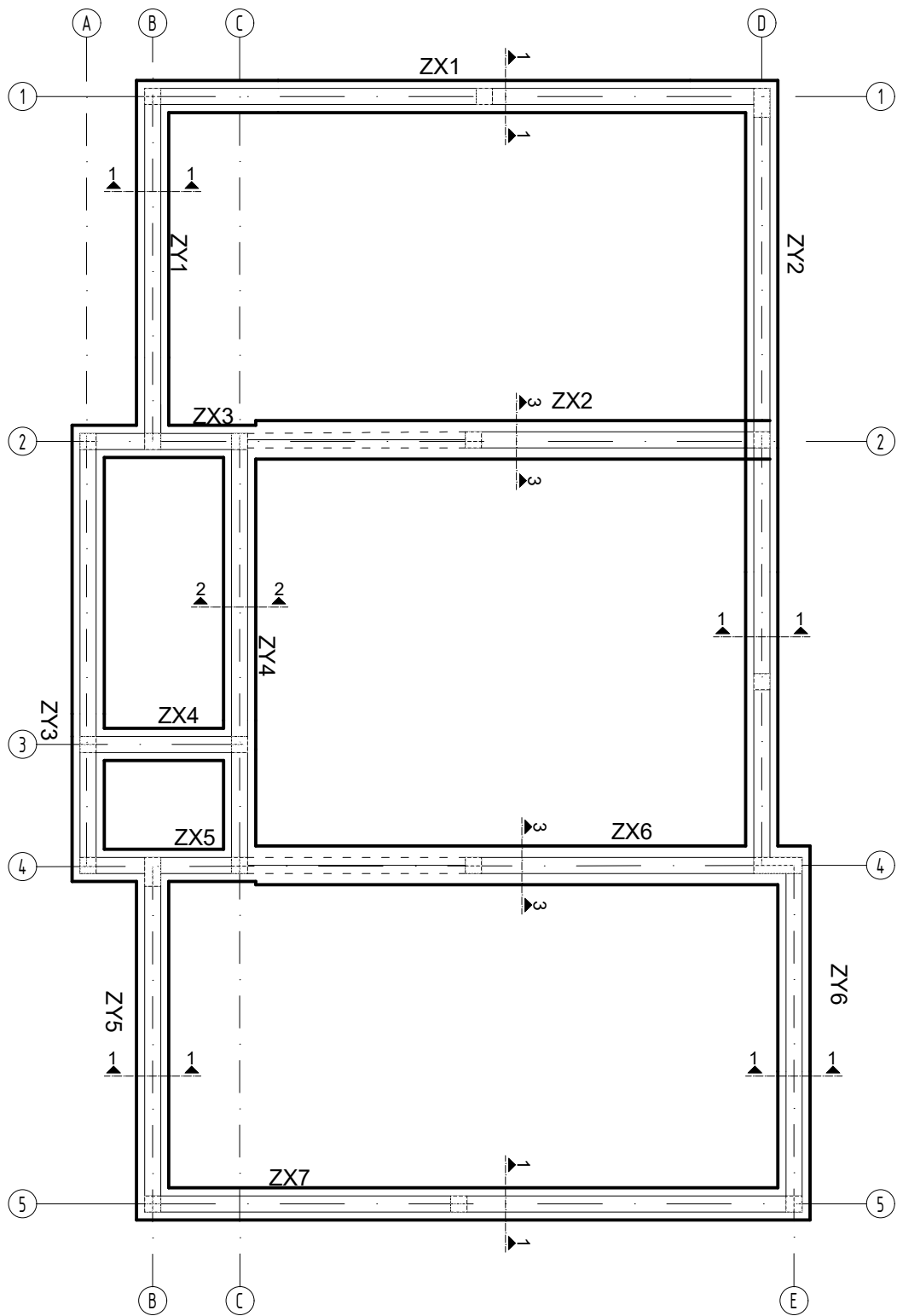

SVEUČILIŠTE U SPLITU ◊ Fakultet građevinarstva, arhitekture i geodezije

Matice hrvatske 15, HR 21000, SPLIT [www.gradst.hr](http://www.gradst.hr)

STRUČNI STUDIJ GRAĐEVINARSTVA

predmet: ZAVRŠNI RAD

student-ica: Frane Pruže

mjerilo: M 1:100

sadržaj: TLOCRT TEMELJA

datum: 22.8.2023

list: 1



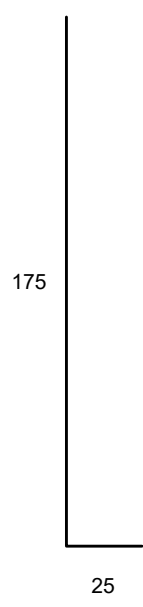
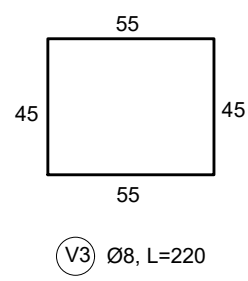
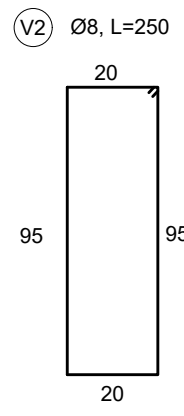
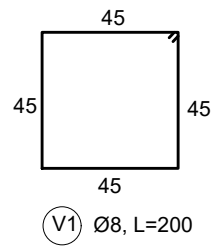
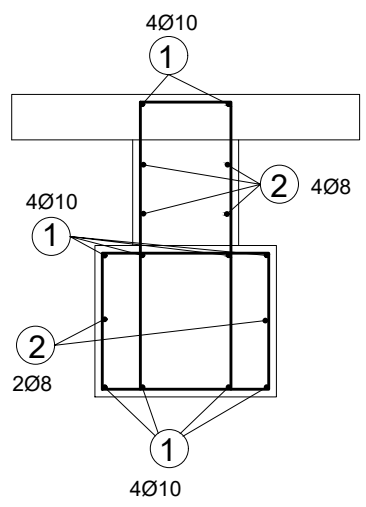
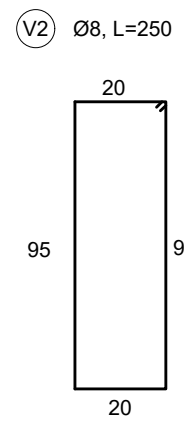
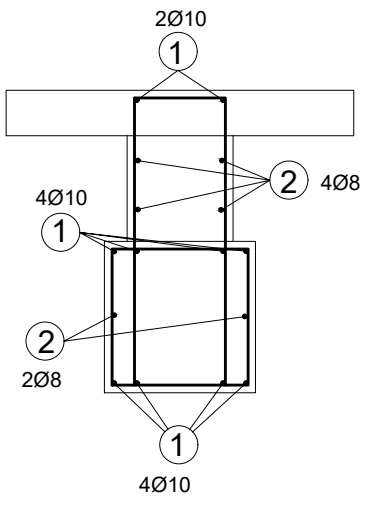
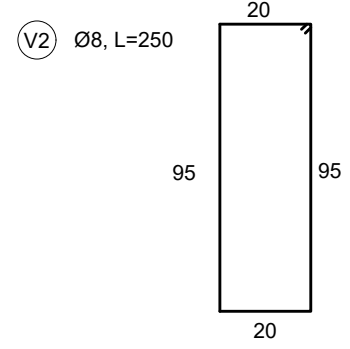
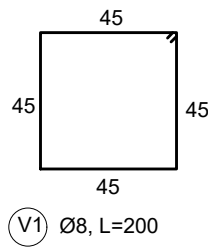
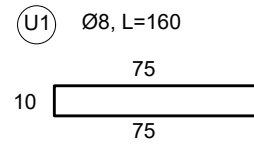
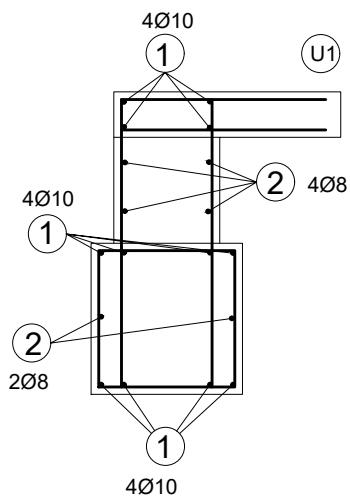

ANKERI NA MJESTU  
VERTIKALNIH  
SERKLAŽA  
A1) Ø12, L=200



SVEUČILIŠTE U SPLITU ◊ Fakultet građevinarstva, arhitekture i geodezije  
Matice hrvatske 15, HR 21000, SPLIT www.gradstf.hr

STRUČNI STUDIJ GRAĐEVINARSTVA

predmet: ZAVRŠNI RAD

student-ica: Frane Pruže

mjerilo: M 1:100

sadržaj: ARMATURA TEMELJA

datum: 22.8.2023

list: 2

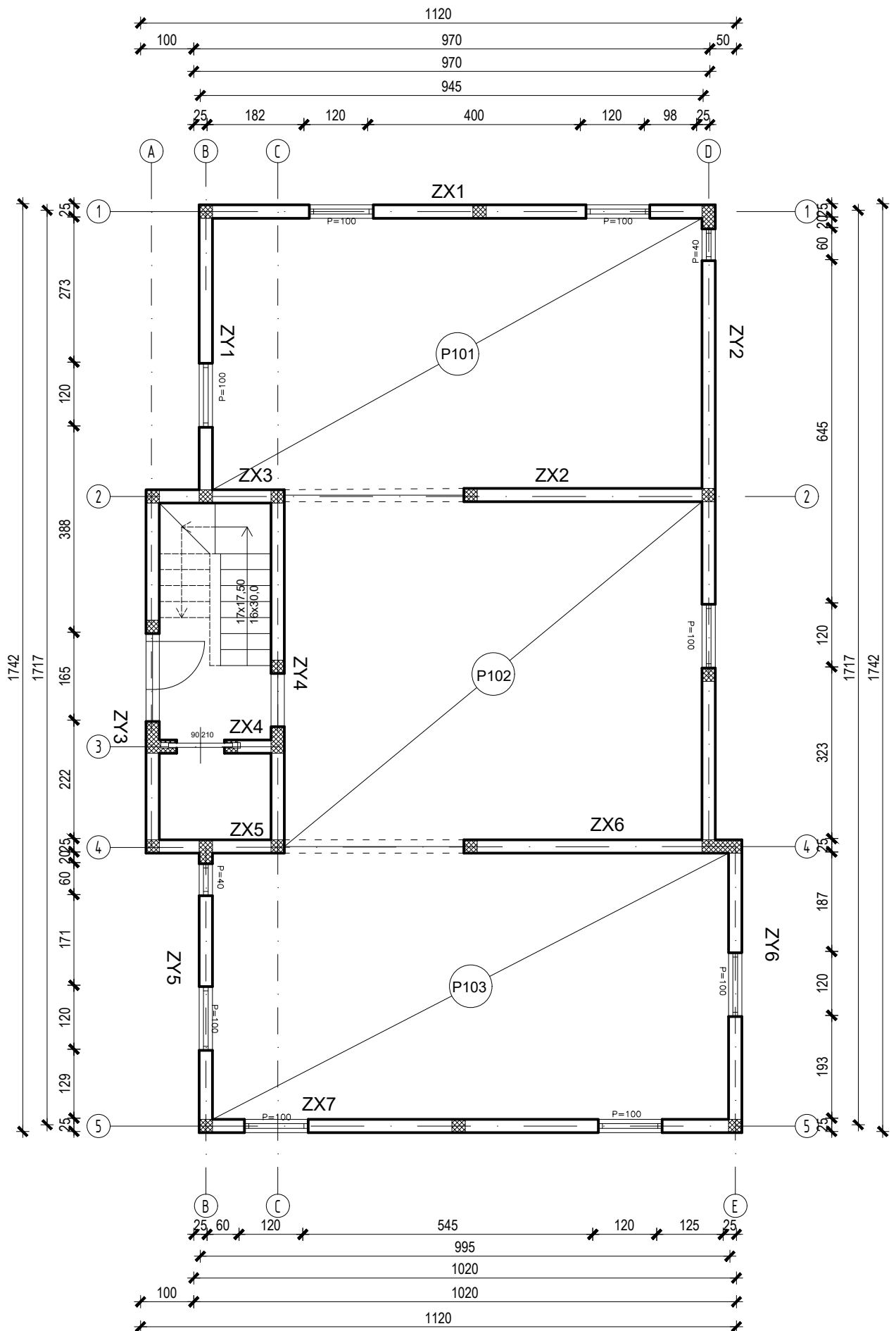

SVEUČILIŠTE U SPLITU ◊ Fakultet građevinarstva, arhitekture i geodezije  
 Matice hrvatske 15, HR 21000, SPLIT www.gradst.hr

STRUČNI STUDIJ GRAĐEVINARSTVA

predmet: ZAVRŠNI RAD

student-ica: Frane Pruže

mjerilo: M 1:100

sadržaj: PLAN POZICIJA 100

datum: 22.8.2023

list: 3

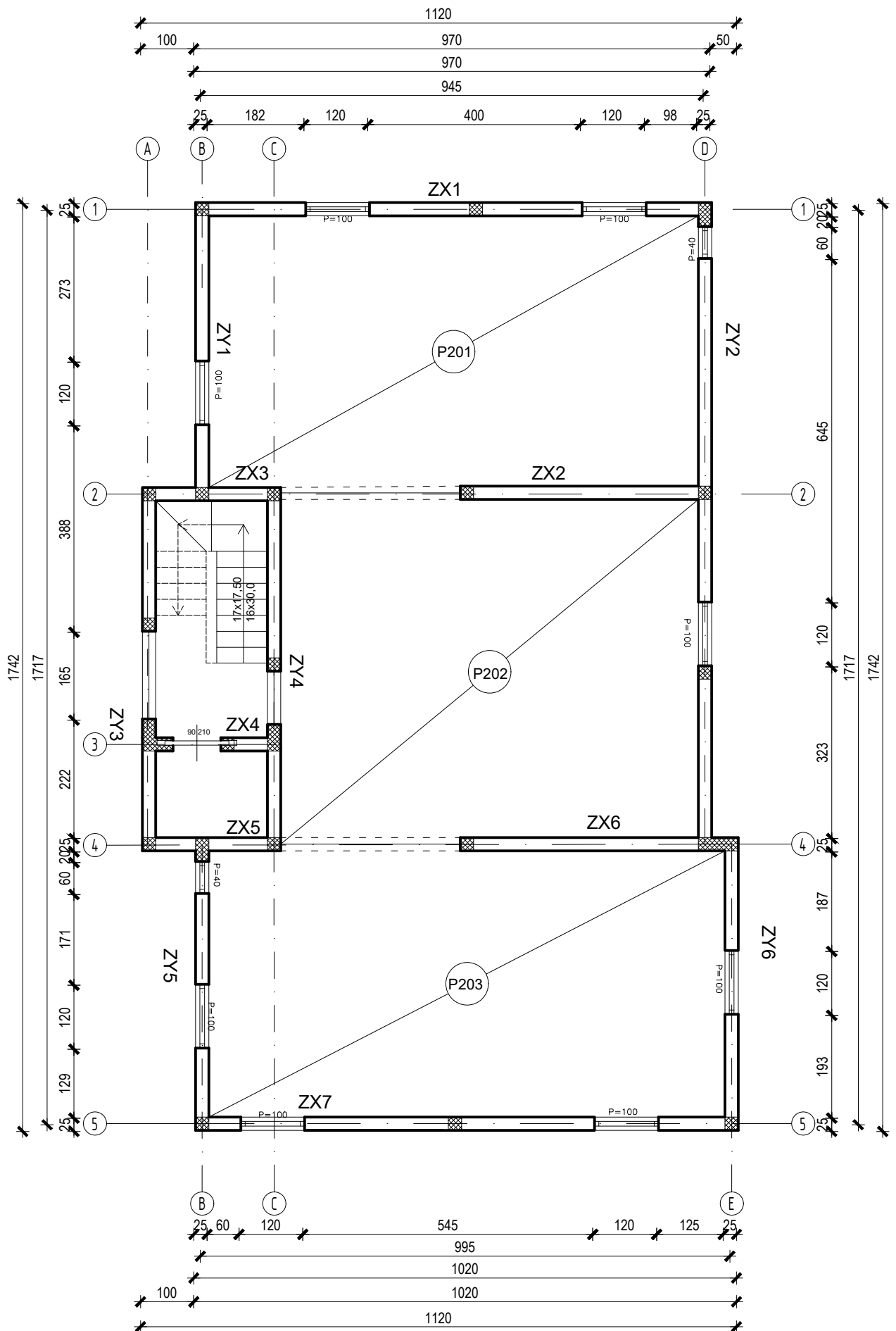

SVEUČILIŠTE U SPLITU ◊ Fakultet građevinarstva, arhitekture i geodezije

Matice hrvatske 15, HR 21000, SPLIT [www.gradstf.hr](http://www.gradstf.hr)

STRUČNI STUDIJ GRAĐEVINARSTVA

predmet: ZAVRŠNI RAD

student-ica: Frane Pruže

mjerilo: M 1:100

sadržaj: PLAN POZICIJA 200

datum: 22.8.2023

list: 4

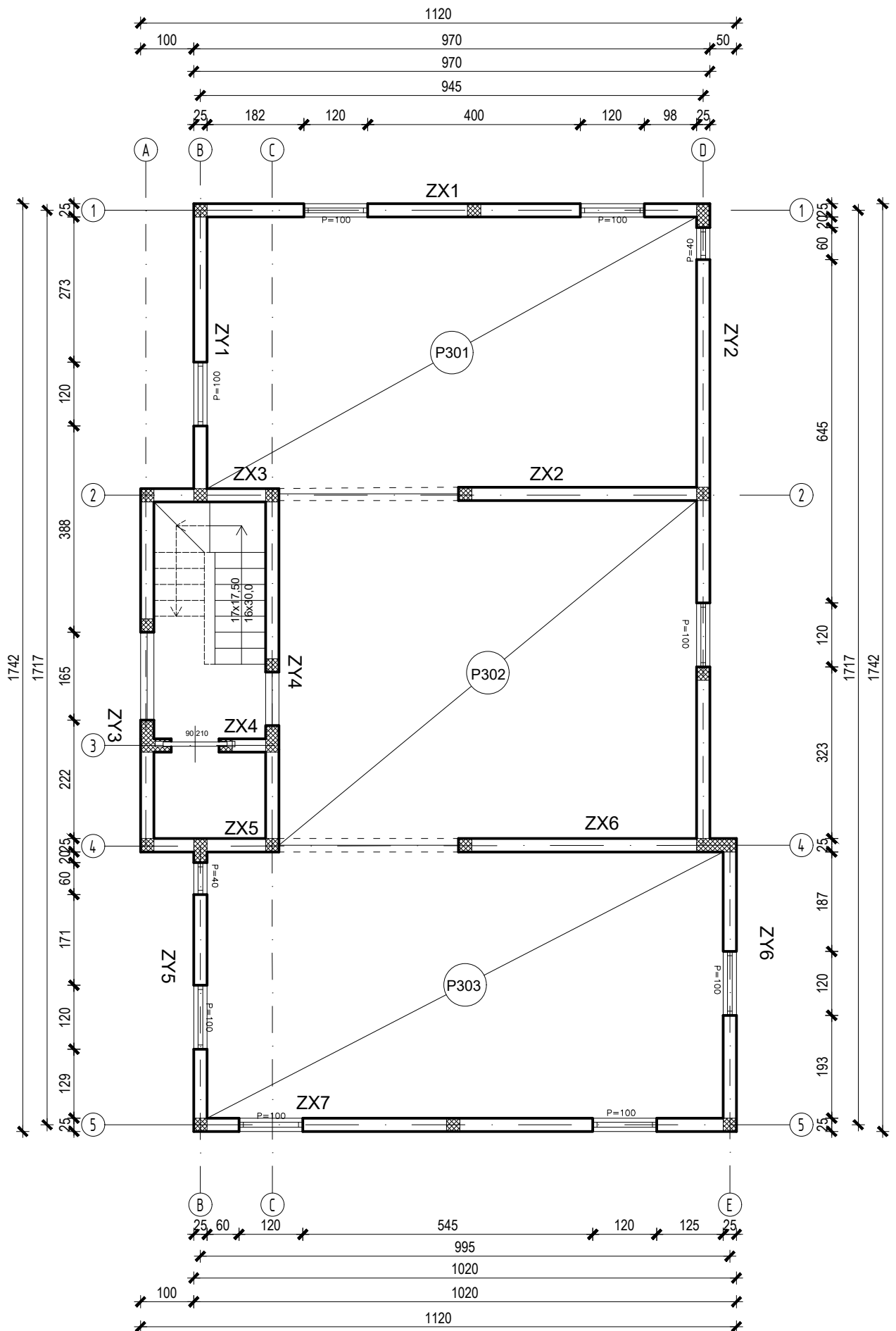

SVEUČILIŠTE U SPLITU ◊ Fakultet građevinarstva, arhitekture i geodezije

Matice hrvatske 15, HR 21000, SPLIT [www.gradst.hr](http://www.gradst.hr)

STRUČNI STUDIJ GRAĐEVINARSTVA

predmet: ZAVRŠNI RAD

student-ica: Frane Pruže

mjerilo: M 1:100

sadržaj: PLAN POZICIJA 300

datum: 22.8.2023

list: 5

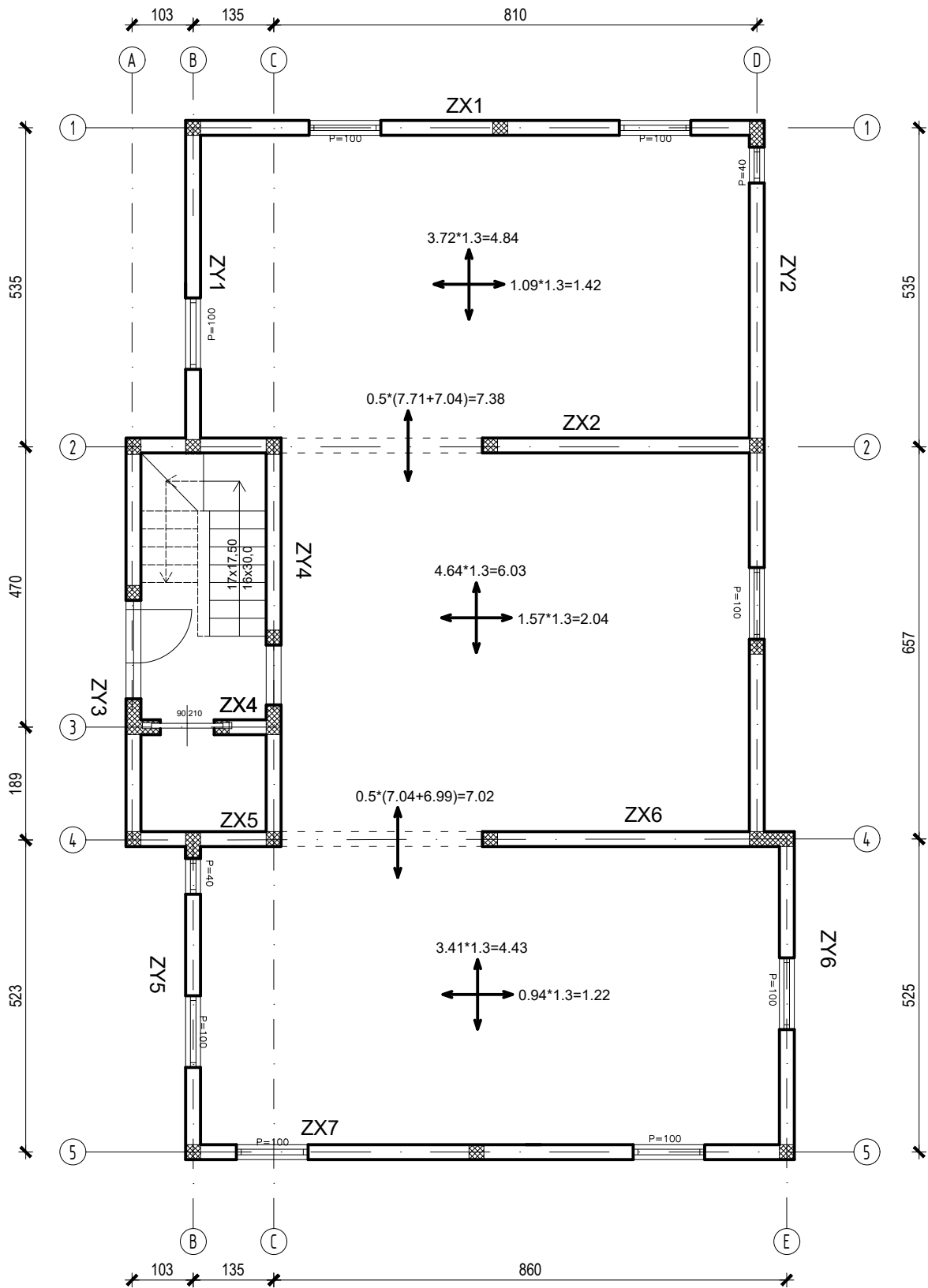

SVEUČILIŠTE U SPLITU ◊ Fakultet građevinarstva, arhitekture i geodezije

Matice hrvatske 15, HR 21000, SPLIT [www.gradstf.hr](http://www.gradstf.hr)

STRUČNI STUDIJ GRAĐEVINARSTVA

predmet: ZAVRŠNI RAD

student-ica: Frane Pruže

mjerilo: M 1:100

sadržaj: RASPODJELA ARMATURE PLOČE POZ 100 I 200 datum: 22.8.2023

list: 6



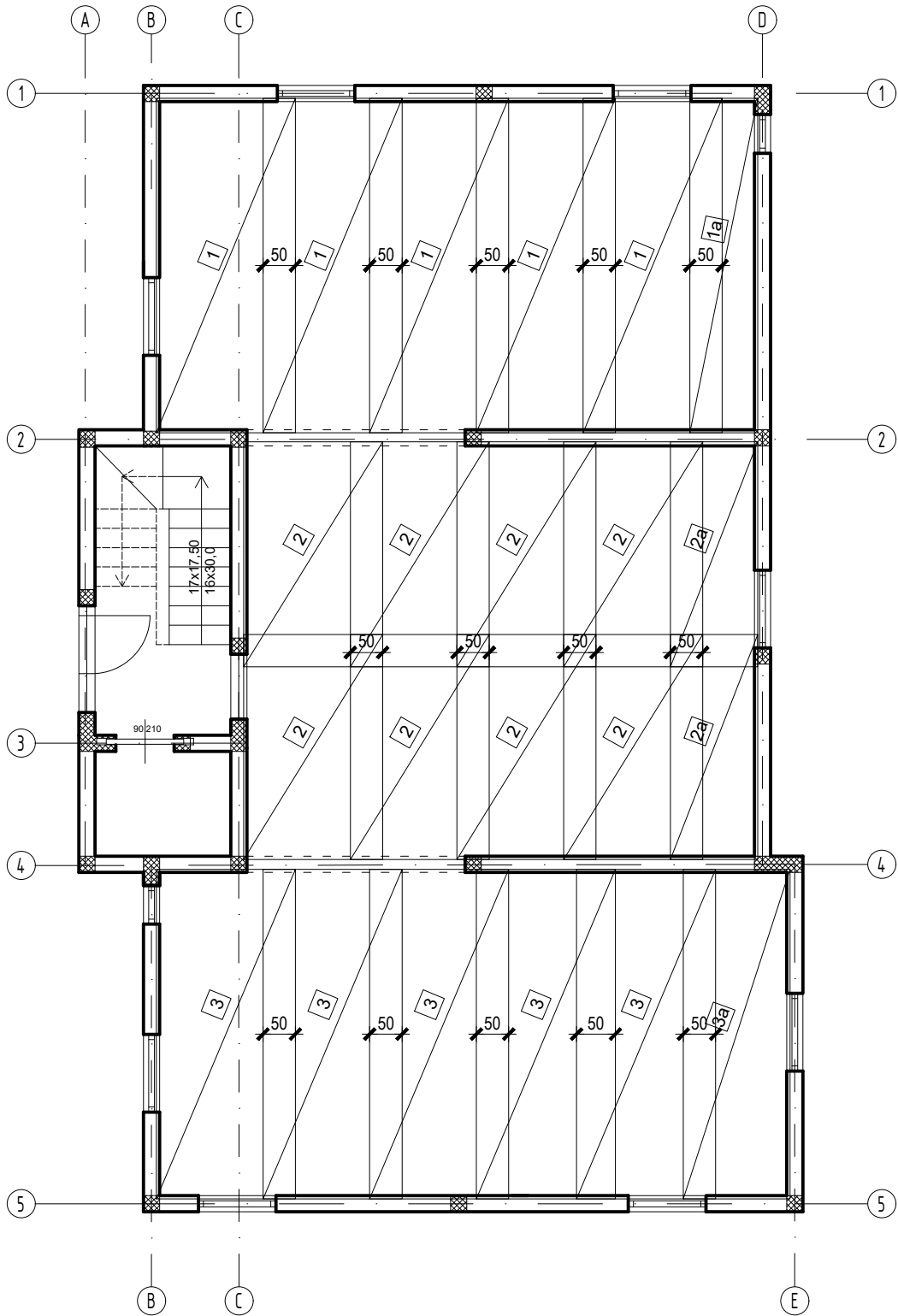

1 Q-503 518x215 5 kom

1a Q-503 518x105 2 kom

2 Q-636 348x215 8 kom

2a Q-636 348x135 2 kom

3 Q-503 510x215 5 kom

3a Q-503 510x165 2 kom



SVEUČILIŠTE U SPLITU ◊ Fakultet građevinarstva, arhitekture i geodezije

Matice hrvatske 15, HR 21000, SPLIT www.gradstf.hr

STRUČNI STUDIJ GRAĐEVINARSTVA

predmet: ZAVRŠNI RAD

student-ica: Frane Pruže

mjerilo: M 1:100

sadržaj: ARMATURA POZ 100 I 200 DONJA ZONA

datum: 22.8.2023

list: 8

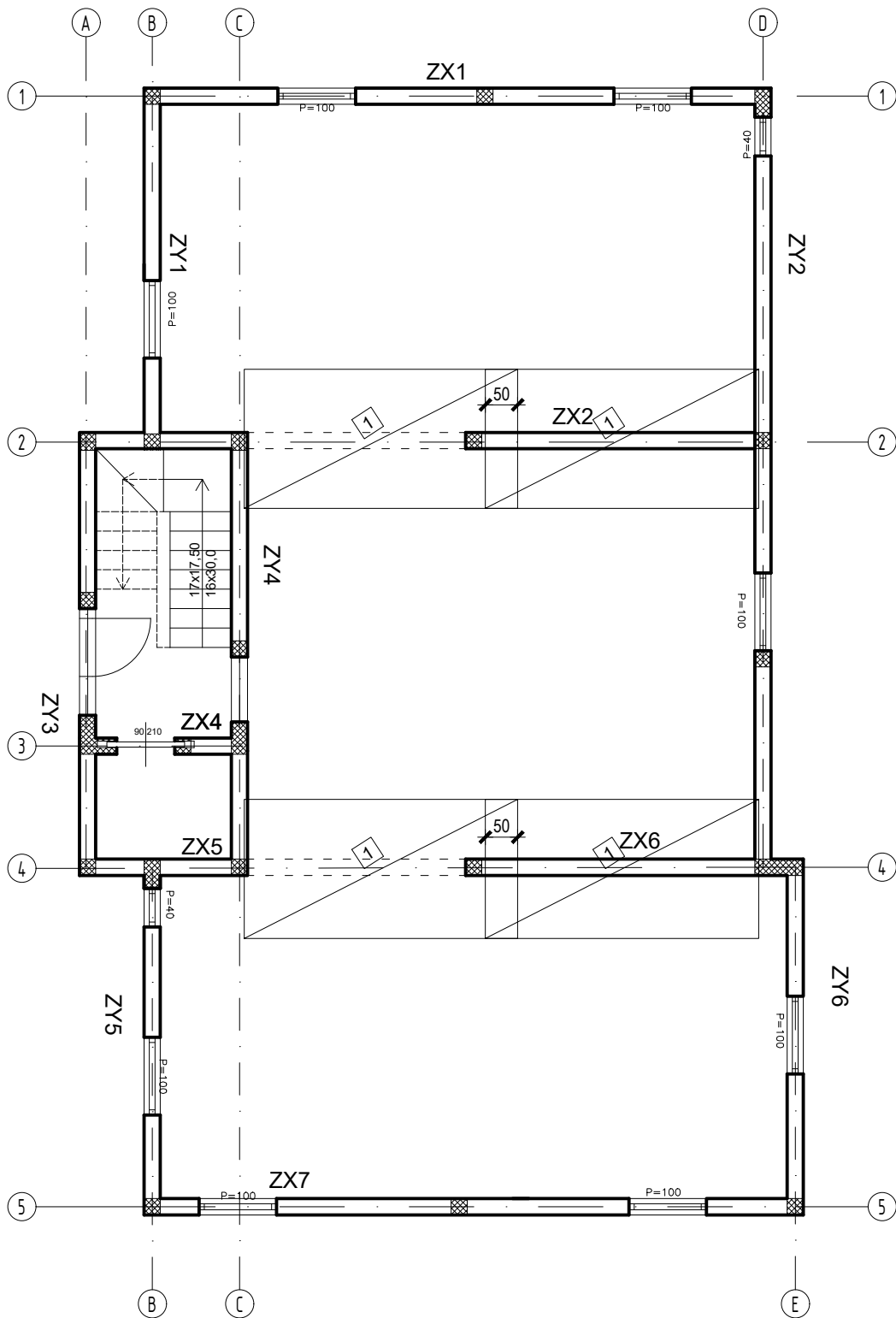

1 Q-785 423x215 4 kom



SVEUČILIŠTE U SPLITU ◊ Fakultet građevinarstva, arhitekture i geodezije

Matice hrvatske 15, HR 21000, SPLIT www.gradstf.hr

STRUČNI STUDIJ GRAĐEVINARSTVA

predmet: ZAVRŠNI RAD

student-ica: Frane Pruže

mjerilo: M 1:100

sadržaj: ARMATURA POZ 100 I 200 GORNJA ZONA

datum: 22.8.2023

list: 9



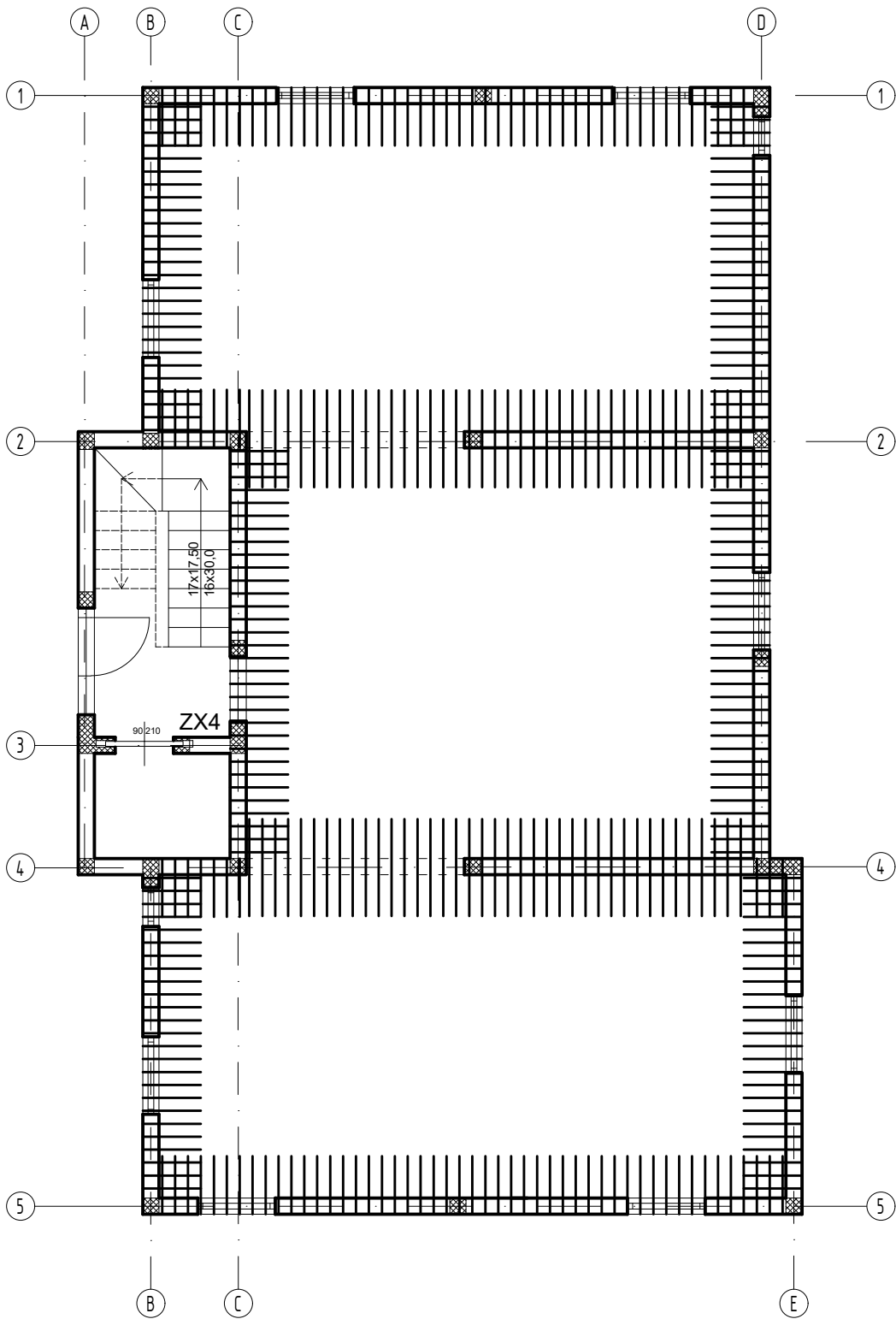

HORIZONTALAN SERKLAŽ 1:25

RUBNI HORIZONTALAN SERKLAŽ 1:25

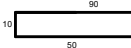
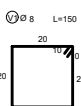
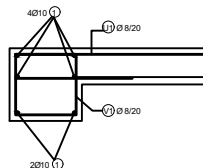
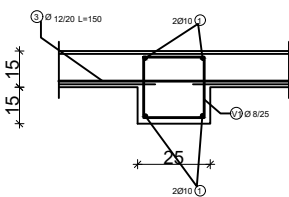

SVEUČILIŠTE U SPLITU ◊ Fakultet građevinarstva, arhitekture i geodezije  
Matice hrvatske 15, HR 21000, SPLIT www.gradstf.hr

STRUČNI STUDIJ GRAĐEVINARSTVA

predmet: ZAVRŠNI RAD

student-ica: Frane Pruže

sadržaj: ARMATURA POZ 100 I 200 DONJA ZONA ŠIPKE datum: 22.8.2023

mjerilo: M 1:100

list: 10

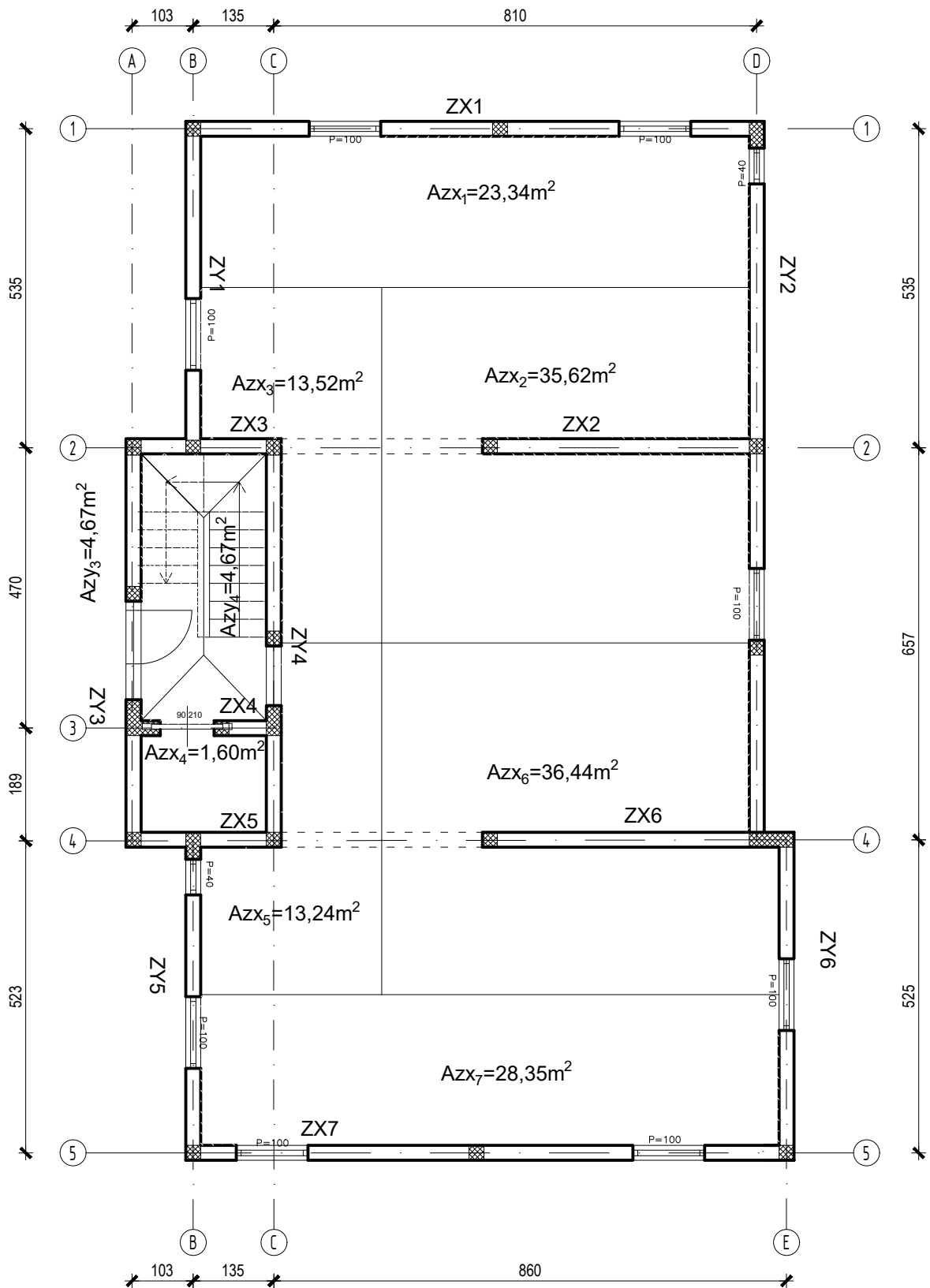

SVEUČILIŠTE U SPLITU ◊ Fakultet građevinarstva, arhitekture i geodezije

Matice hrvatske 15, HR 21000, SPLIT [www.gradst.hr](http://www.gradst.hr)

STRUČNI STUDIJ GRAĐEVINARSTVA

predmet: ZAVRŠNI RAD

student-ica: Frane Pruže

mjerilo: M 1:100

sadržaj: UTJECAJ POVRŠINE POZ 300

datum: 22.8.2023

list: 11

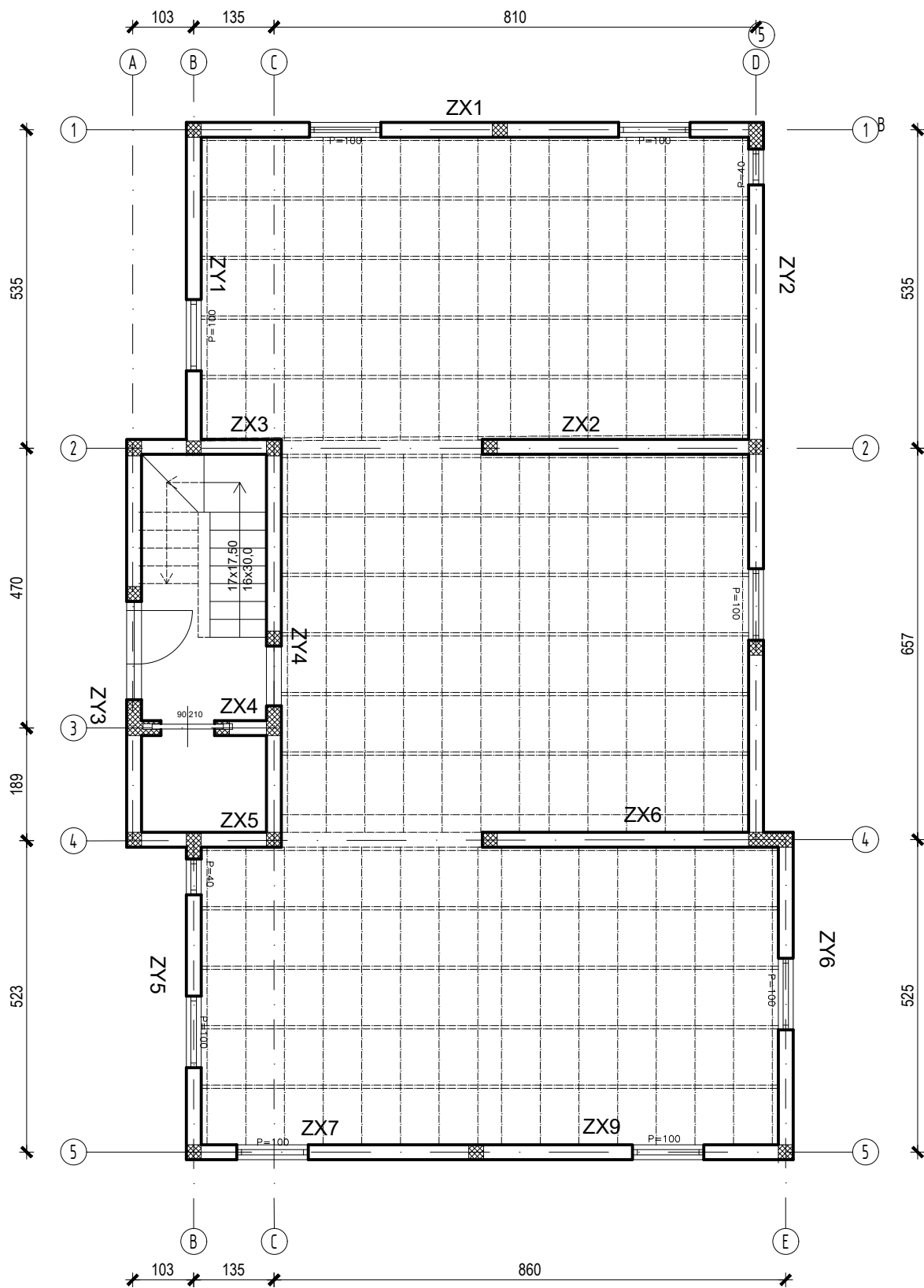

SVEUČILIŠTE U SPLITU ◊ Fakultet građevinarstva, arhitekture i geodezije

Matice hrvatske 15, HR 21000, SPLIT [www.gradst.hr](http://www.gradst.hr)

STRUČNI STUDIJ GRAĐEVINARSTVA

predmet: ZAVRŠNI RAD

student-ica: Frane Pruže

mjerilo: M 1:100

sadržaj: PLAN POLAGANJA GREĐICA POZ 300

datum: 22.8.2023

list: 12

# PRESJEK ZIDA U OSI 1 M 1:100

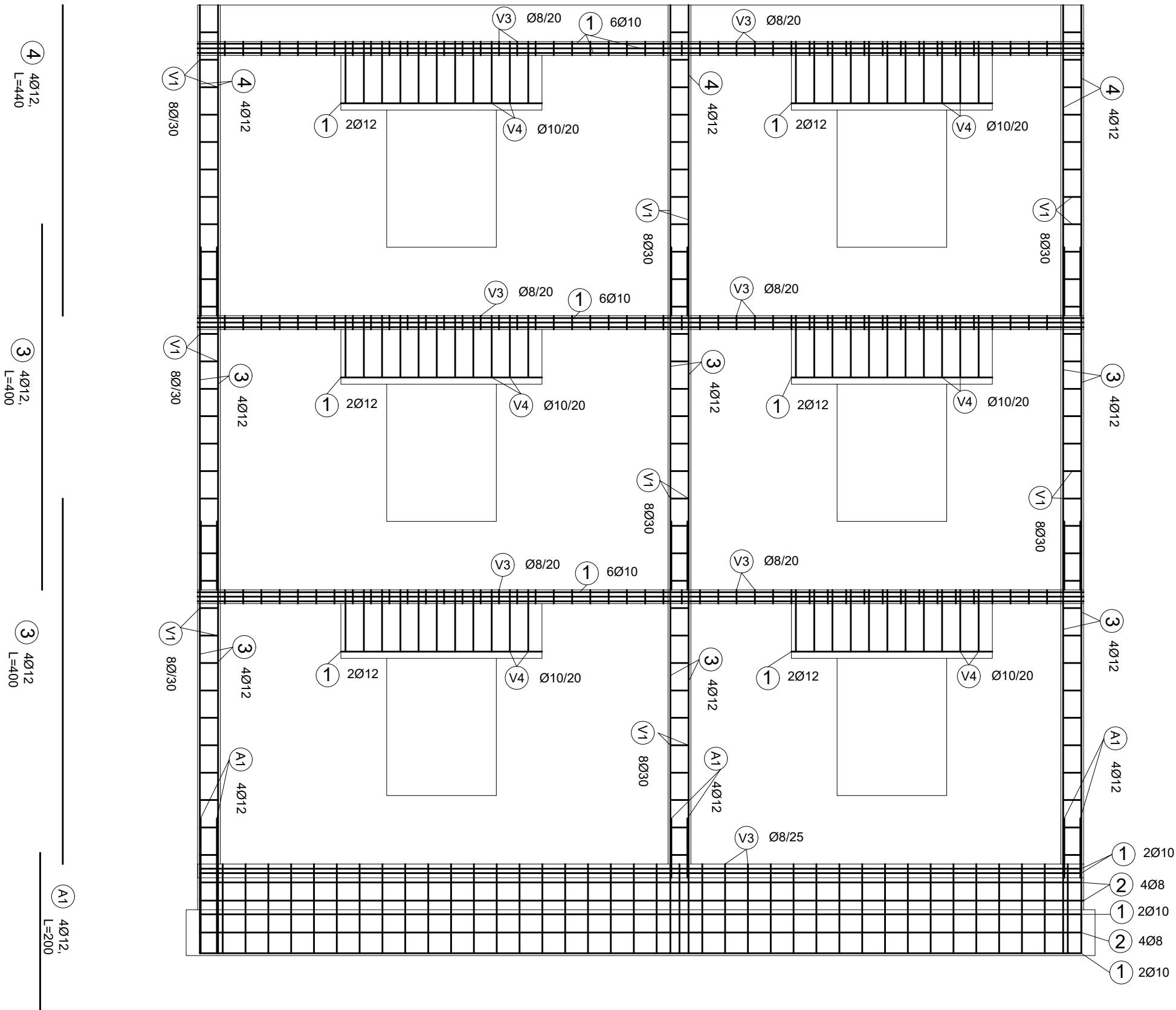

SVEUČILIŠTE U SPLITU ♦ Fakultet građevinarstva, arhitekture i geodezije  
Matice hrvatske 15, HR 21000, SPLIT [www.gradst.hr](http://www.gradst.hr)

STRUČNI STUDIJ GRAĐEVINARSTVA

predmet: ZAVRŠNI RAD

student-ica: Frane Pruže

sadržaj: PRESJEK ZIDA U OSI 1

datum: 22.8.2023

mjerilo: M 1:100

list: 13