

Glavni projekt trgovačkog centra u Trogiru

Grozdanić, Gabrijelela

Master's thesis / Diplomski rad

2016

Degree Grantor / Ustanova koja je dodijelila akademski / stručni stupanj:

University of Split, Faculty of Civil Engineering, Architecture and Geodesy / Sveučilište u Splitu, Fakultet građevinarstva, arhitekture i geodezije

Permanent link / Trajna poveznica: <https://um.nsk.hr/um:nbn:hr:123:040962>

Rights / Prava: [In copyright](#)/[Zaštićeno autorskim pravom.](#)

Download date / Datum preuzimanja: **2025-01-03**



Repository / Repozitorij:

[FCEAG Repository - Repository of the Faculty of Civil Engineering, Architecture and Geodesy, University of Split](#)



**SVEUČILIŠTE U SPLITU
FAKULTET GRAĐEVINARSTVA, ARHITEKTURE I
GEODEZIJE**



DIPLOMSKI RAD

Gabrijela Grozdanić

Split, 2016.

**SVEUČILIŠTE U SPLITU
FAKULTET GRAĐEVINARSTVA, ARHITEKTURE I
GEODEZIJE**

Gabrijela Grozdanić

Glavni projekt trgovačkog centra u Trogiru

Diplomski rad

Split, 2016.

Glavni projekt trgovačkog centra u Trogiru

Sažetak:

U radu je prikazan glavni projekt trgovačkog centra u Trogiru. Građevina je polumontažne izvedbe, sadrži kombinaciju AB (monolitnih) ploča i ošupljene prednapete (montažne) ploče kao međukatne konstrukcije, montažne stupove i AB monolitne zidove kao vertikalne elemente te čeličnu krovnu rešetku. Projekt sadrži proračun nosivih konstrukcijskih elemenata, karakteristične građevinske nacрте i tehnički opis.

Ključne riječi:

Trgovački centar, glavni projekt, polumontažna izvedba

Main design of the shopping center in Trogir

Abstract:

Main design of the shopping center in Trogir is presented in this work. Building is semi-prefabricated and contains combination of monolithic reinforcement slab and hollow prestressed slabs as ceiling construction between storeys, reinforced concrete walls and prefabricated columns as vertical elements and steel truss roof structure. The work includes the calculation of the supporting elements and characteristic construction plans as well as technical description of the construction.

Keywords:

Shopping center, main design, semi prefabricated construction



SVEUČILIŠTE U SPLITU
FAKULTET GRAĐEVINARSTVA,
ARHITEKTURE I GEODEZIJE

UNIVERSITY OF SPLIT
FACULTY OF CIVIL ENGINEERING,
ARCHITECTURE AND GEODESY

STUDIJ: **SVEUČILIŠNI DIPLOMSKI STUDIJ**

SMJER: **KONSTRUKCIJE**

KANDIDAT: **Gabrijela Grozdanić**

BROJ INDEKSA: **523**

KATEDRA: **Katedra za Betonske konstrukcije i mostove**

PREDMET: **Betonske konstrukcije**

ZADATAK ZA DIPLOMSKI RAD

Tema: **Glavni projekt trgovačkog centra u Trogiru**

Opis Zadatka: Na temelju danih podloga, potrebno je izraditi glavni projekt trgovačkog centra u Trogiru. Izrađeni projekt mora sadržavati:

- tehnički opis
- plan kontrole i osiguranja kvalitete
- proračune
- građevinske nacрте

U Splitu, ožujak 2016.

Voditelj diplomskog rada:

Predsjednik povjerenstva za
diplomske ispite

Prof. dr. sc. Alen Harapin

Prof. dr. sc. Ivica Boko

Sadržaj

1. TEHNIČKI OPIS	5
1.1.1 Temelji.....	6
1.1.2 Zidovi	6
1.1.3 Stupovi.....	6
1.1.4 Međukatne konstrukcije	6
1.1.5 Izvedba.....	6
2. PLAN KONTROLE I OSIGURANJA KVALITETE	8
2.1 Općenito.....	8
2.2 Betonski, armiranobetonski i tesarski radovi.....	8
3. OPĆI I POSEBNI TEHNIČKI UVJETI	14
3.1 Oplate i skele	14
3.2 Transport i ugradnja betona	16
3.3 Betoniranje pri visokim vanjskim temperaturama.....	17
3.4 Betoniranje pri niskim vanjskim temperaturama.....	18
4. NAČIN ZBRINJAVANJA GRAĐEVNOG OTPADA	19
5. UVJETI ODRŽAVANJA I PROJEKTIRANI VIJEK TRAJANJA	20
5.1 Osnovna djelovanja i kombinacije.....	23
5.1.1 Osnovna djelovanja	23
5.1.2 Osnovne kombinacije djelovanja.....	24
6. ANALIZA OPTEREĆENJA.....	25
6.1 Ploča prizemlja (ploča nad garažom).....	25
6.2 Krov	26
6.3 Stubišta i podesti.....	27
6.4 Vjetar	28
6.5 Snijeg	38
6.6 Potres	39
6.7 Kombinacije djelovanja	41
6.7.1 Osnovne kombinacije djelovanja.....	41
6.7.2 Seizmičke kombinacije djelovanja	41
7. PRORAČUN KROVNE REŠETKE.....	42
7.1 Dimenzioniranje podrožnica.....	44
7.1.1 Rezne sile.....	44
7.1.2 Dimenzioniranje	46
7.2 Dimenzioniranje glavne rešetke.....	48

7.2.1	Gornji pojas	48
7.2.2	Dimenzioniranje donjeg pojasa	52
7.2.3	Dimenzioniranje ispune	56
7.2.4	Dimenzioniranje vertikalala	58
7.2.5	Dimenzioniranje vertikalala iznad stupa	60
7.3	Dimenzioniranje poprečne rešetke 1	62
7.3.1	Dimenzioniranje gornjeg pojasa	62
7.3.2	Dimenzioniranje donjeg pojasa	67
7.3.3	Dimenzioniranje ispune	72
7.3.4	Dimenzioniranje vertikalala	74
7.4	Dimenzioniranje poprečne rešetke 2	76
7.4.1	Dimenzioniranje gornjeg pojasa	76
7.4.2	Dimenzioniranje donjeg pojasa	81
7.4.3	Dimenzioniranje ispuna	85
7.4.4	Dimenzioniranje vertikalala	87
7.5	Dimenzioniranje čeličnog stupa (pozicija 100-pozicija 200)	89
8.	PRORAČUN PODNE PLOČE POZICIJA 001	90
8.1	Rezultati proračuna	90
9.	PRORAČUN MEĐUETAŽNE KONSTRUKCIJE (šuplje ploče) POZICIJA 101	94
9.1	Odabir šuplje ploče	94
9.2	Međukatni T-nosač G5-G8	96
9.2.1	Analiza opterećenja	96
9.2.2	1. faza	96
9.2.3	Dimenzioniranje na moment savijanja	97
9.2.4	Dimenzioniranje na poprečnu silu	98
9.2.5	2. faza	100
9.2.6	Dimenzioniranje na moment savijanja (polje)	101
9.2.7	Dimenzioniranje na moment savijanja (ležaj)	101
9.2.8	Dimenzioniranje na poprečnu silu	102
9.2.9	Dimenzioniranje kratke konzole na međukatnom T nosaču	104
9.2.10	Kontrola pukotina greda	105
9.2.11	Kontrola progiba grede	107
9.3	Međukatni nosač G1-G3	109
9.3.1	Analiza opterećenja	109
9.3.2	Rezne sile	110
9.3.3	Dimenzioniranje na moment savijanja	110

9.3.4	Dimenzioniranje na poprečnu silu.....	111
9.3.5	2. faza.....	113
1.1.1.	Rezne sile.....	113
9.3.6	Dimenzioniranje na moment savijanja (polje).....	114
9.3.7	Dimenzioniranje na moment savijanja (ležaj).....	114
9.3.8	Dimenzioniranje na poprečnu silu.....	115
9.3.9	Dimenzioniranje kratke konzole na međukatnom T nosaču	117
9.4	Ukupno međуетаžni nosači:.....	118
9.5	Proračun kratkih konzola na stupovima.....	119
9.5.1	Analiza opterećenja	119
9.5.2	Dimenzioniranje na moment savijanja	119
9.5.3	Dimenzioniranje na poprečnu silu.....	120
10.	PRORAČUN MEĐUETAŽNE KONSTRUKCIJE (monolitne ploče).....	122
10.1	Proračun ploče pozicija 102 – granično stanje nosivosti.....	122
10.1.2	Proračun ploče pozicija 103 – granično stanje nosivosti.....	134
10.1.3	Kontrola pukotina greda pozicija 100	149
10.1.4	Kontrola progiba grede pozicija 106	151
10.1.5	Proračun ploče pozicija 201 – granično stanje nosivosti.....	153
10.1.6	Kontrola pukotina greda pozicija 200-krov.....	169
10.1.7	Kkontrola progiba grede pozicija 106	170
11.	DIMENZIONIRANJE VERTIKALNIH ELEMENATA	173
11.1	Zidovi u smjeru x	176
11.1.1	Proračun zida u smjeru x – dimenzioniranje promatranog zida	178
11.2	Zid u smjeru x	185
11.2.1	Proračun zida u smjeru x – dimenzioniranje promatranog zida	187
11.3	Zidni nosač u smjeru x.....	194
11.3.1	Proračun na poprečnu silu $h=6,15m$	198
11.4	Zid u smjeru x	200
11.4.1	Proračun zida u smjeru x – dimenzioniranje promatranog zida	202
11.5	Zid u smjeru x	209
11.5.1	Proračun zida u smjeru x – dimenzioniranje promatranog zida	211
11.6	Zid u smjeru y	218
11.6.1	Proračun zida u smjeru x – dimenzioniranje promatranog zida	220
12.	PRORAČUN STUPOVA.....	227
12.1	Proračun stupova – kvadratni stupovi.....	231
12.2	Stupovi S1 i S2	233

12.2.1	Proračun na poprečnu silu	234
12.3	Stupovi S5 i S6	235
12.3.1	Proračun na poprečnu silu	236
12.4	Stupovi S8 i S10	238
12.4.1	Proračun na poprečnu silu	239
12.5	Stup S4.....	241
12.5.1	Proračun na poprečnu silu	242
12.6	Stupovi S (3,7,9,11,12) (kratki)	243
12.6.1	Proračun na poprečnu silu	244
13.	PRORAČUN STUBIŠTA	246
14.	PRORAČUN TEMELJA.....	248
14.1	Proračun trakastih temelja vanjskih i unutarnjih zidova:.....	248
14.1.1	Unutarnje temeljne trake:	249
14.1.2	Unutarnje temeljne trake:	251
14.1.3	Vanjske temeljne trake:	253
14.1.4	Vanjske temeljne trake:	255
14.2	Proračun temelja samca	257
14.2.1	Temelji stupova S1 i S2.....	257
14.2.2	Temelji stupova S5 i S6.....	259
14.2.3	Temelji stupova S10 i S8.....	261
14.2.4	Temelj stupa SP 4.....	264
14.2.5	Temelji stupova S3, S7, S9, S11 i S12.....	266
15.	GRAFIČKI PRILOZI.....	268

1. TEHNIČKI OPIS

Predmet zadatka ovog diplomskog rada je izrada glavnog projekta nosive konstrukcije trgovačkog centra u Trogiru. Građevina se sastoji od podzemne etaže visine 3 m i nadzemne etaže s visinom 4,75 m. Raster tlocrta zgrade je nepravilnog kvadratnog oblika. Tlocrtna površina objekta je 3298 m², dok je ukupna visina 12-13,5 m ovisno o promatranom dijelu objekta.

Vertikalnu nosivu konstrukciju čine armiranobetonski stupovi i armiranobetonski zidovi. Stupovi su montažni elementi, dok se zidovi izvode monolitno. Međukatnu nosivu konstrukciju čine dijelom armiranobetonske ploče s gredama, a dijelom prednapete šuplje ploče sa međuetaznim nosačima oslonjenim na stupove. Šuplje ploče i međuetazni nosači su montažni elementi, a armiranobetonske ploče monolitni. Vertikalna komunikacija je ostvarena liftovima, eskalatorom i stubištem koje je dvokrako, monolitno i izvodi se od betona klase C30/37 te armira armaturnim mrežama B500B. Krovna konstrukcija se sastoji dijelom od armiranobetonske ploče sa rebrima (iznad skladišnog prostora), a drugim dijelom od čelične rešetke sa panelima koja se oslanja na armiranobetonske stupove i zidove. Krovna rešetka se sastoji od glavne rešetke sastavljene od I profila i kvadratnih profila, poprečne rešetke, podrožnica, konstrukcije za ovješeni strop i panela.

U konstrukciji horizontalne (seizmičke, sile od vjetra) sile preuzimaju zidovi i stupovi te međukatna ploča i temelji. Temelji su predviđeni kao samci za stupove, trake za zidove te su na djelovima spojeni u manju temeljnu ploču zbog jednostavnijeg izvođenja. Temelji samci su povezani gredama kako bi sačinjavali jednu krutu cjelinu zbog boljeg prijenosa sila.

Građevina se nalazi u blizini Trogira i smještena je u zonu gdje poredbeno vršno ubrzanje temeljnog tla iznosi $\alpha=0.22g$ prema važećoj seizmičkoj karti (povratni period 475 godina za GSN), III. području opterećenja vjetrom (osnovna brzina vjetra je 30 m/s) i II. zoni opterećenja snijegom (opterećenje iznosi 0.45 kN/m²).

U proračunu su dane osnovne dimenzije i količine armature za pojedine konstruktivne elemente. Elementi koji nisu računati armiraju se konstruktivno ($\geq 0.1\%$ površine betonskog presjeka).

1.1.1 Temelji

Računska granična nosivost tla iznosi $\sigma_{R,d}=500$ kPa, što je nakon iskopa temelja potrebno utvrditi ispitivanjem. Temeljne ploče su nepravilnog oblika (visine $h=40$ cm), temelji „samci“ (dimenzija $b \times b=250 \times 250 - 280 \times 280$ cm i visine $h=60-70$ cm) i temeljne trake širine $b=120$ cm i visine $h=50$ cm. Predviđeni su od betona C30/37 $\varnothing_{agr} \leq 32$ mm i armirani s B-500B. Zaštitni slojevi betona do armature iznose min. 5 cm.

1.1.2 Zidovi

Svi zidovi su izvedeni od betona C30/37 i armirani s B500B, s potrebnim hidrotermičkim slojevima širine 40 i 30 cm. Zaštitni slojevi betona do armature iznose min. 3 cm.

1.1.3 Stupovi

Stupovi su kvadratnog poprečnog presjeka. Na poziciji 100 imaju konzole za prihvat međukatne konstrukcije (šupljih ploča i međetažnih nosača), dok na poziciji 200 imaju proširenja za oslanjanje čelične krovne rešetke. Dimenzije stupova su od 35×35 , 55×55 i 60×60 cm. Stupovi se izvode iz betona klase C30/37 i armiraju armaturnim šipkama B500B.

1.1.4 Međukatne konstrukcije

Međukatnu nosivu konstrukciju zgrade tvore prednapete šuplje ploče visine $h=50$ cm. Šuplje ploče su max. dimenzija 1600 cm, oslanjanju se na međetažne grede T poprečnog presjeka duljine 800 cm. Preko šupljih ploča postavlja se topping u sloju od 10 cm kako bi se stvorila kruta horizontalna konstrukcija. Pozicije 102 i 103 su armiranobetonske ploče s rebrima. Izvode se iz betona klase C30/37 i armiraju armaturnim mrežama B500B.

1.1.5 Izvedba

Iskop građevinske jame do nivoa 4.80m (6.25) ispod nivoa prizemlja buduće građevine izvršit će se u širokom iskopu s vertikalnim zasjekom (7:1). Pri zasijecanju potrebno je ukloniti sve nestabilne slojeve. Zasijek treba zaštititi prskanim betonom debljine $d=5-10$ cm uz armiranje armaturnom mrežom Q-196 i geotehničkim sidrima po potrebi prema posebnom projektu. Pristup jami predviđen je na mjestu buduće rampe. Nakon iskopa

potrebno je temeljnu plohu ručno očistiti od ostataka razlomljenog materijala, kao i eventualnu glinovitu ispunu iz pukotina. Po obavljenom čišćenju temeljne plohe potrebno je neravnine i udubine (škrape) popuniti i izravnati podložnim betonom C 16/20 do projektirane kote temeljenja.

Ukoliko se naiđe na kavernu (pukotinu), veće udubine i relativno manje širine, a nije moguće potpuno uklanjanje gline crvenice, sanaciju izvesti tako da se glina očisti do dubine cca 50 cm ispod kote temeljenja, a nastali prostor do projektirane kote temeljenja "plombira", tj. zapuni podbetonom.

U trenutku izrade projektne dokumentacije nije poznat izvođač konstrukcije. Prilikom izrade statičkog proračuna usklađena je geometrija presjeka elemenata konstrukcije s izvođačkim mogućnostima većine građevinskih firmi. Prilikom odabira izvođača moguće je da dođe do manjih odstupanja u obliku poprečnog presjeka pojedinih elemenata u odnosu na elemente iz statičkog proračuna, ali se ne očekuju bitna odstupanja, koja bi imala utjecaj na ukupnu stabilnost građevine te je dovoljno ove razlike obraditi u izvedbenom projektu konstrukcije.

Opterećenja su uzeta prema podacima dobivenim od strane investitora, projektanata instalacija te prema normama i pravilima struke.

Zbog veličine i složenosti građevine u cilju osiguranja što kvalitetnije izvedbe nosive konstrukcije investitor je dužan osigurati projektantski nadzor nad konstrukcijom tijekom cijelog vremena izvedbe konstrukcije u skladu s Zakonom o gradnji (NN1 53/13).

2. PLAN KONTROLE I OSIGURANJA KVALITETE

2.1 Općenito

Izvoditelj je odgovoran za kvalitetu izvođenja radova i za uredno poslovanje. Izvoditelj ne smije odstupati od projekta bez pismenog odobrenja nadzornog inženjera i investitora, a uz prethodnu suglasnost projektanta. Sve izmjene se moraju unijeti u građevinsku knjigu i građevinski dnevnik.

Kvaliteta korištenog građevinskog materijala, poluproizvoda i gotovih proizvoda, kao i kvaliteta izvedenih radova mora odgovarati prethodno navedenim uvjetima propisanim važećim propisima, standardima, uvjetima iz tehničke dokumentacije te uvjetima iz ugovora.

Ukoliko izvoditelj ugrađuje materijal koji nije standardiziran, za isti je dužan pribaviti odgovarajuće dokaze o kakvoći i priložiti ih u pismenoj formi.

Pri izvođenju građevine, izvoditelj je dužan pridržavati se navedenih propisa kao i svih ostalih pravilnika, tehničkih normativa, posebnih uvjeta za izradu, ugradnju i obradu pojedinih elemenata građevine, kao i standarda propisanih za izvođenje radova na građevini (temeljenje, betonski radovi, skele i oplata, armatura, čelik za armiranje, kontrola kvalitete betona i čelika, zidanje zidova, završni radovi), kako bi osigurao da izvedena građevina odgovara projektu te svim propisima i standardima RH.

2.2 Betonski, armiranobetonski i tesarski radovi

2.2.1 Beton

Sve komponente betona (agregat, cement, voda, dodaci) te beton kao materijal, trebaju udovoljavati zahtjevima važećih normi, propisa i pravila struke. Izvoditelj je dužan izraditi projekt betona u skladu s projektom konstrukcije i dostaviti ga na suglasnost projektantu objekta.

Kontrola kvalitete betona sastoji se od kontrole proizvodnje i kontrole suglasnosti s uvjetima projekta konstrukcije i projekta betona.

Betonski radovi moraju se izvoditi prema projektu konstrukcije i projektu betona (kojeg je dužan izraditi izvođač), a u svemu sukladno s Tehničkim propisom za betonske konstrukcije (N.N. 139/09, 14/10, 125/10, 136/12) te svim pratećim normativima.

Kod projektiranog betona u projektu mora biti specificiran razred tlačne čvrstoće (marka betona) i to kao karakteristična vrijednost 95%-tne vjerojatnosti s kriterijima sukladnosti prema normi HRN EN 206-1. Sastavni materijali od kojih se beton proizvodi ili koji mu se pri proizvodnji dodaju, moraju ispunjavati zahtjeve normi na koje upućuje norma HRN EN 206-1 i zahtjeve prema Tehničkom propisu za betonske konstrukcije.

Zahtjevi za isporuku betona i informacije proizvođača betona korisniku moraju sadržavati podatke prema normi HRN EN 206-1. Uzimanje uzoraka, priprema ispitnih uzoraka i ispitivanje svojstava svježeg betona provodi se prema normama niza HRN EN 12350, a ispitivanje svojstava očvrstnalog betona prema normama niza HRN EN 12390.

Eventualna vremenski ubrzana proizvodnja betonskih elemenata, u cilju ubrzanja građenja, dopuštena je samo uz poseban projekt tehnologije izvođenja i dokaz zahtjevanih svojstava prethodnim ispitivanjima.

Za svako odstupanje od projekta, nadzorni inženjer je dužan izvijestiti projektanta i investitora. Nužna je njega ugrađenog betona da se ne pojave štetne pukotine, a u svemu prema projektu betona, važećim propisima i pravilima struke.

2.2.2 Betonski čelik

Betonski čelici trebaju udovoljavati zahtjevima važećih propisa. Za čelik za armiranje primjenjuju se norme nHRN EN 10080-1 Čelik za armiranje betona – Zavarljivi armaturni čelik

– 1. dio: Opći zahtjevi (prEN 10080-1:1999), nHRN EN 10080-2 Čelik za armiranje betona – Zavarljivi armaturni čelik

– 2. dio: Tehnički uvjeti isporuke čelika razreda A (prEN 10080-2:1999), nHRN EN 10080-3 Čelik za armiranje betona – Zavarljivi armaturni čelik

– 3. dio: Tehnički uvjeti isporuke čelika razreda B (prEN 10080-3:1999), nHRN EN 10080-4 Čelik za armiranje betona – Zavarljivi armaturni čelik

– 4. dio: Tehnički uvjeti isporuke čelika razreda C (prEN 10080-4:1999), nHRN EN 10080-5 Čelik za armiranje betona – Zavarljivi armaturni čelik

- 5. dio: Tehnički uvjeti isporuke zavarenih armaturnih mreža (prEN 10080-5:1999), nHRN EN 10080-6 Čelik za armiranje betona – Zavarljivi armaturni čelik
- 6. dio: Tehnički uvjeti isporuke zavarenih rešetki za gredice (prEN 10080-6:1999).

Potvrđivanje sukladnosti čelika za armiranje provodi se prema odredbama Dodataka A norme nHRN EN 10080-1 i odredbama posebnog propisa.

Uzimanje uzoraka, priprema ispitnih uzoraka i ispitivanje svojstava čelika za armiranje provodi se prema normama nizova nHRN EN 10080, odnosno nHRN EN 10138, i prema normama niza HRN EN ISO 15630 i prema normi HRN EN 10002-1.

Preklopi se izvode prema odredbama priznatim tehničkim pravilima iz Priloga H Tehničkog propisa za betonske konstrukcije, odnosno prema normi HRN ENV 1992-1-1:2004.

Sva armatura je iz čelika B500 u obliku šipki ili mreža. Osobito poštivati projektom predviđene razmake i zaštitne slojeve armature. Ni jedno betoniranje elementa ne može započeti bez prethodnog detaljnog pregleda armature od strane nadzornog inženjera i njegove dozvole.

2.2.3 Prekidi betoniranja

Prekid i nastavci betoniranja konstrukcija moraju biti obrađeni projektom betona.

2.2.4 Oplata

Za izvedbu svih betonskih i armiranobetonskih elemenata potrebno je pravovremeno izraditi, postaviti i učvrstiti odgovarajuću drvenu, metalnu ili sličnu oplatu. Oplata mora odgovarati mjerama građevinskih nacрта, detalja i planova oplata. Podupiranjem i razupiranjem oplata mora se osigurati njena stabilnost i nedeformabilnost pod teretom ugrađene mješavine. Unutarnje površine moraju biti ravne i glatke, bilo da su vertikalne, horizontalne ili kose. Postavljena oplata mora se lako i jednostavno rastaviti, bez udaranja i upotrebe pomoćnih alata i sredstava čime bi se "mlada" konstrukcija izložila štetnim vibracijama. Ako se nakon skidanja oplata ustanovi da izvedena konstrukcija dimenzijama i oblikom ne odgovara projektu izvođač je obavezan istu srušiti i ponovo izvesti prema

projektu. Prije ugradnje svježe mješavine betona u oplatu, istu, ako je drvena, potrebno je dobro navlažiti, a ako je metalna mora se premazati odgovarajućim premazom.

Izvođač ne može započeti betoniranje dok nadzor ne izvrši pregled postavljene oplata i pismeno je ne odobri.

2.2.5 Primijenjeni standardi

Standardi za beton – osnovni

HRN EN 206-1:2002 Beton – 1. dio: Specifikacije, svojstva, proizvodnja i sukladnost (EN 206-1:2000)

HRN EN 206-1/A1:2004 Beton – 1. dio: Specifikacija, svojstva, proizvodnja i sukladnost (EN 206-1:2000/A1:2004)

nHRN EN 206-1/A2 Beton – 1. dio: Specifikacija, svojstva, proizvodnja i sukladnost (EN 206-1:2000/prA2:2004)

Standardi za beton - ostali

HRN EN 12350-1 Ispitivanje svježeg betona – 1. dio: Uzorkovanje

HRN EN 12350-2 Ispitivanje svježeg betona – 2. dio: Ispitivanje slijeganjem

HRN EN 12350-3 Ispitivanje svježeg betona – 3. dio: VeBe ispitivanje

HRN EN 12350-4 Ispitivanje svježeg betona – 4. dio: Stupanj zbijenosti

HRN EN 12350-5 Ispitivanje svježeg betona – 5. dio: Ispitivanje rasprostriranjem

HRN EN 12350-6 Ispitivanje svježeg betona – 6. dio: Gustoća

HRN EN 12350-7 Ispitivanje svježeg betona – 7. dio: Sadržaj pora – Tlačne metode

HRN EN 12390-1 Ispitivanje očvrsnulog betona – 1. dio: Oblik, dimenzije i drugi zahtjevi za uzorke i kalupe

HRN EN 12390-2 Ispitivanje očvrsnulog betona – 2. dio: Izradba i njegovanje uzoraka za ispitivanje čvrstoće

HRN EN 12390-3 Ispitivanje očvrsnulog betona – 3. dio: Tlačna čvrstoća uzoraka

HRN EN 12390-6 Ispitivanje očvrsnulog betona – 6. dio: Vlačna čvrstoća cijepanjem uzoraka

HRN EN 12390-7 Ispitivanje očvrsnulog betona – 7. dio: Gustoća očvrsnulog betona

HRN EN 12390-8 Ispitivanje očvrsnulog betona – 8. dio: Dubina prodiranja vode pod tlakom

prCEN/TS 12390-9	Ispitivanje očvrtnulog betona – 9. dio: otpornost na smrzavanje ljuštenjem
ISO 2859-1	Plan uzorkovanja za atributni nadzor – 1. dio: Plan uzorkovanja indeksiran prihvatljivim nivoom kvalitete (AQL) za nadzor količine po količine
ISO 3951	Postupci uzorkovanja i karta nadzora s varijablama nesukladnosti
HRN U.M1.057	Granulometrijski sastav mješavina agregata za beton
HRN U.M1.016	Beton. Ispitivanje otpornosti na djelovanje mraza
HRN EN 480-11	Dodaci betonu, mortu I injekcijskim smjesama – Metode ispitivanja – 11. dio: Utvrđivanje karakteristika zračnih pora u očvrtnulom betonu
HRN EN12504-1	Ispitivanje betona u konstrukcijama – 1. dio: Izvađeni uzorci – Uzimanje, pregled i ispitivanje tlačne čvrstoće
HRN EN 12504-2	Ispitivanje betona u konstrukcijama – 2. dio: Nerazorno ispitivanje – Određivanje veličine odskoka
HRN EN 12504-3	Ispitivanje betona u konstrukciji – 3. dio: Određivanje sile čupanja
HRN EN 12504-4	Ispitivanje betona u konstrukciji – 4. dio: Određivanje brzine ultrazvuka
prEN 13791:2003	Ocjena tlačne čvrstoće betona u konstrukcijama ili u konstrukcijskim elementima

Standardi za čelik za armiranje – osnovni

nHRN EN 10080-1	Čelik za armiranje betona – Zavarljivi armaturni čelik – 1.dio: Opći zahtjevi (prEN 10080-1:1999)
nHRN EN 10080-2	Čelik za armiranje betona – Zavarljivi armaturni čelik – 2. dio: Tehnički uvjeti isporuke čelika razreda A (prEN 10080-2:1999)
nHRNEN 10080-3	Čelik za armiranje betona – Zavarljivi armaturni čelik – 3. dio: Tehnički uvjeti isporuke čelika razreda B (prEN 10080-3:1999)
nHRN EN 10080-4	Čelik za armiranje betona – Zavarljivi armaturni čelik – 4. dio: Tehnički uvjeti isporuke čelika razreda C (prEN 10080-4:1999)
nHRN EN 10080-5	Čelik za armiranje betona – Zavarljivi armaturni čelik – 5. dio: Tehnički uvjeti isporuke zavarenih armaturnih mreža (prEN 10080-5:1999)
nHRN EN 10080-6	Čelik za armiranje betona – Zavarljivi armaturni čelik – 6. dio: Tehnički uvjeti isporuke zavarenih rešetki za gredice (prEN 10080-6:1999)

Standardi za čelik za armiranje – ostali

HRN EN 10020	Definicije i razredba vrsta čelika
HRN EN 10025	Toplovaljani proizvodi od nelegiranih konstrukcijskih čelika – Tehnički uvjeti isporuke
HRN EN 10027-1	Sustavi označivanja čelika – 1. dio: Nazivi čelika, glavni simboli
HRN EN 10027-2	Sustavi označivanja čelika – 2. dio: Brojčani sustav
EN 10079	Definicije čeličnih proizvoda
HRN EN 10204	Metalni proizvodi – Vrste dokumenata o ispitivanju (uključuje dopunu A1:1995)
prEN ISO 17660	Zavarivanje čelika za armiranje
HRN EN 287-1	Provjera osposobljenosti zavarivača – Zavarivanje taljenjem – 1. dio: Čelici
HRN EN 719	Koordinacija zavarivanja – Zadaci i odgovornosti
HRN EN 729-3	Zahtjevi za kakvoću zavarivanja – Zavarivanje taljenjem metalnih materijala – 3. dio: Standardni zahtjevi za kakvoću
HRN EN ISO 4063	Zavarivanje i srodni postupci – Nomenklatura postupaka i referentni brojevi
HRN EN ISO 377	Čelik i čelični proizvodi – Položaj i priprema uzoraka i ispitnih uzoraka za mehanička ispitivanja
HRN EN 10002-1	Metalni materijali – Vlačni pokus – 1. dio: Metoda ispitivanja (pri sobnoj temperaturi)
HRN EN ISO 15630-1	Čelik za armiranje i prednapinjanje betona – Ispitne metode – 1. dio: Armaturene šipke i žice
HRN EN ISO 15630-2	Čelik za armiranje i prednapinjanje betona – Ispitne metode – 2. dio: Zavarene mreže

Ostali standardi

ENV 1992-1-1	Eurokod 2 – Projektiranje betonskih konstrukcija – 1. dio: Opća pravila i pravila za zgrade
ENV 1992-1-2	Eurokod 2 – Projektiranje betonskih konstrukcija – 1-2 dio: Opća pravila – Projektiranje konstrukcije na požar

Ovlaštene organizacije i institucije za atestiranje nalaze se na listi Glasnika Zavoda kojeg izdaje Državni zavod za normizaciju i graditeljstvo.

Izvoditelj je dužan osiguravati dokaze o kvaliteti radova i ugrađenih proizvoda i opreme prema Zakonu i prema zahtjevima iz projekta te u tom smislu mora čuvati

dokumentaciju o ispitivanju ugrađenog materijala, proizvoda i opreme prema programu ispitivanja iz projekta.

Nadzorni inženjer dužan je voditi računa da je kvaliteta radova, ugrađenih proizvoda i opreme u skladu sa zahtjevima projekta te da je kvaliteta dokazana propisanim ispitivanjima i dokumentima. Nadzorni inženjer dužan je da za tehnički pregled priredi završno izvješće o izvedbi građevine.

2.2.6 Ostali radovi i materijali

Svi ostali materijali i proizvodi koji se ugrađuju u objekt trebaju biti kvalitetni i trajni, uz zadovoljenje svih važećih normi, propisa i pravila struke. Za sve se upotrijebljene materijale provode tekuća i kontrolna ispitivanja, odnosno prilažu atesti isporučitelja. Izvedba svih radova treba biti ispravna, kvalitetna i pod stalnim stručnim nadzorom. Za svako odstupanje primijenjenog gradiva ili gotovog proizvoda od projekta, potrebna je suglasnost projektanta i investitora.

3. OPĆI I POSEBNI TEHNIČKI UVJETI

3.1 Oplate i skele

Skele i oplate moraju imati takvu sigurnost i krutost da bez slijeganja i štetnih deformacija mogu primiti opterećenja i utjecaje koji nastaju tijekom izvedbe radova. Skela i oplata moraju biti izvedeni tako da se osigurava puna sigurnost radnika i sredstava rada kao i sigurnost prolaznika, prometa, susjednih objekata i okoline uopće.

Materijali za izradu skela i oplata moraju biti propisane kvalitete. Nadzorni inženjer treba odobriti oplatu prije početka betoniranja.

Kod izrade projekta oplate mora se uzeti u obzir kompaktiranje pomoću vibratora na oplati tamo gdje je to potrebno.

Oplata mora sadržavati sve otvore i detalje prikazane u nacrtima, odnosno tražene od nadzornog inženjera.

Oplata odnosno skela treba osigurati da se beton ne onečisti. Obje moraju biti dovoljno čvrste i krute da odole pritiscima kod ugradnje i vibriranja i da spriječe ispupčenja. Nadzorni inženjer će, tamo gdje mu se čini potrebno, tražiti proračunski dokaz stabilnosti i progibanja.

Nadvišenja oplata dokazuju se računski i geodetski se provjeravaju prije betoniranja.

Oplata mora biti toliko vodotijesna da spriječi istjecanje cementnog mlijeka.

Ukoliko se za učvršćenje oplata rabe metalne šipke od kojih dio ostaje ugrađen u betonu, kraj stalno ugrađenog dijela ne smije biti bliži površini od 5 cm. Šupljina koja ostaje nakon uklanjanja šipke mora se dobro ispuniti, naročito ako se radi o ploham koje će biti izložene protjecanju vode. Ovakav način učvršćenja ne smije se upotrijebiti za vidljive plohe betona.

Žičane spojnice za pridržavanje oplata ne smiju prolaziti kroz vanjske plohe gdje bi bile vidljive.

Radne reške moraju biti, gdje god je moguće, horizontalne ili vertikalne i moraju biti na istoj visini zadržavajući kontinuitet.

Pristup oplati i skeli radi čišćenja, kontrole i preuzimanja, mora biti osiguran.

Oplata mora biti tako izrađena, naročito za nosače i konstrukcije izložene proticanju vode, da se skidanje može obaviti lako i bez oštećenja rubova i površine.

Površina oplata mora biti očišćena od inkrustacija i sveg materijala koji bi mogao štetno djelovati na izložene vanjske plohe.

Kad se oplata premazuje uljem, mora se spriječiti prljanje betona i armature.

Oplata, ukoliko je drvena, mora prije betoniranja biti natopljena vodom na svim površinama koje će doći u dodir s betonom i zaštićena od prljanja za beton premazom vapnom.

Skidanje oplata se mora izvršiti čim je to provedivo, naročito tamo gdje oplata ne dozvoljava polijevanje betona, ali nakon što je beton dovoljno očvrstnuo. Svi popravci betona trebaju se izvršiti na predviđen način i to što je prije moguće.

Oplata se mora skidati prema određenom redoslijedu, pažljivo i stručno, da se izbjegnu oštećenja. Moraju se poduzeti mjere predostrožnosti za slučaj neplaniranog kolapsa. Nadzorni inženjer će odrediti kad se mora, odnosno može, skidati oplata.

Sve skele (za oplatu, pomoćne i fasadne) moraju se izvesti od zdravoga drva ili čeličnih cijevi potrebnih dimenzija.

Sve skele moraju biti stabilne, ukružene dijagonalno u poprečnom i uzdužnom smislu, te solidno vezane sponama i kliještima. Mosnice i ograde trebaju biti također dovoljno ukružene. Skelama treba dati nadvišenje koje se određuje iskustveno u ovisnosti o građevini ili proračunski. Ako to traži nadzorni inženjer, vanjska skela, s vanjske strane, treba biti prekrivena tršćanim ili lanenim pletivom kako bi se uz općenitu zaštitu osigurala i kvalitetnija izvedba i zaštita fasadnog lica.

Skele moraju biti izrađene prema pravilima struke i propisima Pravilnika o higijenskim i tehničkim zaštitnim mjerama u građevinarstvu.

Nadzorni inženjer mora zabraniti izradu i primjenu oplata i skela koje prema njegovom mišljenju ne bi mogle osigurati traženu kvalitetu lica gotovog betona ili su neprihvatljive kvalitete ili sigurnosti. Prijem gotove skele ili oplate vrši se vizualno, geodetskom kontrolom i ostalom izmjerom. Pregled i prijem gotove skele, oplate i armature vrši nadzorni inženjer. Bez obzira na odobrenu primjenu skela, oplate i armature, izvođač snosi punu odgovornost za sigurnost i kvalitetu radova.

3.2 Transport i ugradnja betona

S betoniranjem se može početi samo na osnovi pismene potvrde o preuzimanju podloge, skele, oplate i armature te po odobrenju programa betoniranja od nadzornog inženjera.

Beton se mora ugrađivati prema unaprijed izrađenom programu i izabranom sistemu.

Vrijeme transporta i drugih manipulacija sa svježim betonom ne smije biti duže od onog koje je utvrđeno u toku prethodnih ispitivanja (promjena konzistencije s vremenom pri raznim temperaturama).

Transportna sredstva ne smiju izazivati segregaciju smjese betona.

U slučaju transporta betona auto-miješalicama, poslije pražnjenja auto-miješalice treba oprati bubanj, a prije punjenja treba provjeriti je li ispražnjena sva voda iz bubnja.

Zabranjeno je korigiranje sadržaja vode u gotovom svježem betonu bez prisustva tehnologa za beton.

Dozvoljena visina slobodnog pada betona je 1,0 m. Nije dozvoljeno transportiranje betona po kosinama.

Transportna sredstva se ne smiju oslanjati na oplatu ili armaturu kako ne bi dovela u pitanje njihov projektirani položaj.

Svaki započeti betonski odsjek, konstruktivni dio ili element objekta mora biti neprekidno izbetoniran u opsegu, koji je predviđen programom betoniranja, bez obzira na radno vrijeme, brze vremenske promjene ili isključenja pojedinih uređaja mehanizacije pogona.

Ako dođe do neizbježnog, nepredvidljivog prekida rada, betoniranje mora biti završeno tako da se na mjestu prekida može izraditi konstruktivno i tehnološki odgovarajući radni spoj. Izrada takvog radnog spoja moguća je samo uz odobrenje nadzornog inženjera.

Svježi beton mora se ugrađivati vibriranjem u slojevima čija debljina ne smije biti veća od 70 cm. Sloj betona koji se ugrađuje mora vibriranjem biti dobro spojen s prethodnim donjim slojem betona. Ako dođe do prekida betoniranja, prije nastavka betoniranja površina donjeg sloja betona mora biti dobro očišćena ispuhivanjem i ispiranjem, a po potrebi i pjeskarenjem.

Beton treba ubaciti što bliže njegovom konačnom položaju u konstrukciji da bi se izbjegla segregacija. Smije se vibrirati samo oplatom ukliješten beton. Nije dozvoljeno transportiranje betona pomoću pervibratora.

Ugrađeni beton ne smije imati temperaturu veću od 45 °C u periodu od 3 dana nakon ugradnje.

3.3 Betoniranje pri visokim vanjskim temperaturama

Niska početna temperatura svježeg betona ima višestruko povoljan utjecaj na poboljšanje uvjeta za betoniranje masivnih konstrukcija. Stoga je sniženje temperature svježeg betona i održavanje iste u propisanim granicama od posebnog značaja. Za održavanje temperature svježeg betona unutar dopuštenih 25 °C, neophodno je poduzeti sljedeće mjere:

- krupne frakcije agregata hladiti raspršivanjem vode po površini deponije, što se ne preporuča s frakcijama do 8 mm, zbog poteškoća s održavanjem konzistencije betona,
- deponije pijeska zaštititi nadstrešnicama,
- silose za cement, rezervoare, miješalicu, cijevi itd. zaštititi od sunca bojenjem u bijelo.

Ukoliko ovi postupci hlađenja nisu dostatni, daljnje sniženje temperature može se postići hlađenjem vode u posebnim postrojenjima (coolerima).

Za vrijeme visokih dnevnih temperatura (oko 30 °C), kada postoje poteškoće s održavanjem dozvoljene temperature svježeg betona, početak radova na betoniranju treba pomaknuti prema hladnijem dijelu dana (noć, jutro).

Vrijeme od spravljanja betona do ugradnje treba biti što kraće, kako bi se izbjegli problemi pri pražnjenju transportnih sredstava i ugradnji zbog smanjenja obradivosti.

Ugrađivanje se mora odvijati brzo i bez zastoja. Redosljed betoniranja mora omogućiti povezivanje novog betona s prethodnim.

U uvjetima vrućeg vremena najpogodnije je njegovanje vodom. Njegovanje treba početi čim beton počne očvršćivati. Ako je intenzitet isparavanja blizu kritične granice, površina se može finim raspršivanjem vode održavati vlažnom, bez opasnosti od ispiranja.

Čelične oplata treba rashlađivati vodom, a podloga prije betoniranja mora biti dobro nakvašena.

Ukoliko se u svježem betonu pojave pukotine, treba ih zatvoriti revibriranjem.

Voda koja se upotrebljava za njegovanje ne smije biti mnogo hladnija od betona, kako razlike između temperature betona na površini i unutar jezgre ne bi prouzročile pojavu pukotina. Stoga je efikasan način njegovanja pokrivanje betona materijalima koji vodu upijaju i zadržavaju (juta, spužvasti materijal i sl.) te dodatno prekrivanje plastičnom folijom.

Prekrivanje povoljno djeluje i na utjecaj razlika temperatura noć - dan.

3.4 Betoniranje pri niskim vanjskim temperaturama

Betoniranje pri temperaturama nižim od +5 °C moguće je uz pridržavanje mjera za zimsko betoniranje.

Upotreba smrznutog agregata u mješavini nije dozvoljena, a zagrijavanje pijeska parom nije preporučljivo zbog poteškoća s održavanjem konzistencije betona.

Pri ugradnji svježi beton mora imati minimalnu temperaturu od +6 °C, koja se na nižim temperaturama zraka ($0 < t < +5$ °C) može postići samo zagrijavanjem vode, pri čemu temperatura mješavine agregata i vode prije dodavanja cementa ne smije prijeći +25 °C. Temperatura svježeg betona u zimskom periodu na mjestu ugradnje mora biti od +6 °C do +15 °C.

Da bi se omogućio normalni tok procesa stvrdnjavanja i spriječilo smrzavanje, odmah poslije ugradnje, beton se toplinski zaštićuje prekrivanjem otvorenih površina izolacijskim materijalima i izolacijom čeličnih oplata.

Toplinska izolacija betona mora biti takva da osigura postizanje najmanje 50 % projektirane čvrstoće na pritisak prije nego što beton bude izložen djelovanju mraza.

Pri temperaturama zraka nižim od +5 °C, temperatura svježeg betona mjeri se najmanje jedanput u toku 2h.

4. NAČIN ZBRINJAVANJA GRAĐEVNOG OTPADA

Način zbrinjavanja građevnog otpada mora biti u skladu s propisima o otpadu. Osnovni propis iz tog područja je: Zakon o održivom gospodarenju otpadom (NN 94/13), koji u sebi sadrži sve ostale relevantne pravilnike: Pravilnik o vrstama otpada, Pravilnik o postupanju s otpadom...

Prema navedenom zakonu građevni otpad spada u inertni otpad jer uopće ne sadrži ili sadrži malo tvari koje podliježu fizikalnoj, kemijskoj i biološkoj razgradnji pa ne ugrožavaju okoliš.

Nakon završetka radova gradilište treba očistiti od otpadaka i suvišnog materijala i okolni dio terena dovesti u prvobitno stanje.

Pravilnikom o vrstama otpada određeno je da je proizvođač otpada čija se vrijedna sredstva mogu iskoristiti dužan otpad razvrstavati na mjestu nastanka, odvojeno skupljati po vrstama i osigurati uvjete skladištenja za očuvanje kakvoće u svrhu ponovne obrade.

Taj pravilnik predviđa slijedeće moguće postupke s otpadom:

-kemijsko-fizikalna obrada

-biološka obrada

-termička obrada

-kondicioniranje otpada

-odlaganje otpada

Kemijsko-fizikalna obrada otpada je obrada kemijsko-fizikalnim metodama s ciljem mijenjanja njegovih kemijsko-fizikalnih, odnosno bioloških svojstava, a može biti: neutralizacija, taloženje, ekstrakcija, redukcija, oksidacija, dezinfekcija, centrifugiranje, filtracija, sedimentacija, rezervna osmoza.

Biološka obrada je obrada biološkim metodama s ciljem mijenjanja kemijskih, fizikalnih, odnosno bioloških svojstava, a može biti: aerobna i anaerobna razgradnja.

Termička obrada je obrada termičkim postupkom. Provodi se s ciljem mijenjanja kemijskih, fizikalnih, odnosno bioloških svojstava, a može biti: spaljivanje, piroliza, isparavanje, destilacija, sinteriranje, žarenje, taljenje, zataljivanje u staklo.

Kondicioniranje otpada je priprema za određeni način obrade ili odlaganja, a može biti: usitnjavanje, ovlaživanje, pakiranje, odvodnjavanje, oprašivanje, očvršćivanje te postupci kojima se smanjuje utjecaj štetnih tvari koje sadrži otpad.

S građevnim otpadom treba postupiti u skladu s Pravilnikom o uvjetima za postupanje s otpadom.

Taj pravilnik predviđa moguću termičku obradu za slijedeći otpad:

- drvo
- plastiku
- asfalt koji sadrži katran
- katran i proizvodi koji sadrže katran

Kondicioniranjem se može obraditi slijedeći otpad:

- građevinski materijali na bazi azbesta
- asfalt koji sadrži katran
- asfalt (bez katrana)
- katran i proizvodi koji sadrže katran
- izolacijski materijal koji sadrži azbest
- miješani građevni otpad i otpad od rušenja

Najveći dio građevnog otpada (prethodno obrađen ili neobrađen) može se odvesti u najbliže javno odlagalište otpada: beton, cigle, pločice i keramika, građevinski materijali na bazi gipsa, drvo, staklo, plastika, bakar, bronca, mjed, aluminij, olovo, cink, željezo i čelik, kositar, miješani materijali, kablovi, zemlja i kamenje i ostali izolacijski materijali.

Nakon završetka radova gradilište treba očistiti od otpada i suvišnog materijala, postupiti prema iznesenom, a okolni dio terena dovesti u prvobitno stanje.

5. UVJETI ODRŽAVANJA I PROJEKTIRANI VIJEK TRAJANJA

Razmatrana građevina ne zahtjeva poseban tretman održavanja.

Ipak, ukopanost u tlo i relativna blizina agresivne sredine (mora) zahtijevaju povećanu mjeru opreza i pojačani nadzor nad svim elementima (konstruktivnim i nekonstruktivnim) građevina. Tehnološkim mjerama, koje su navedene u ovom projektu pokušalo se dobiti što kvalitetniju i trajniju konstrukciju. U tom smislu neophodno je poštovati mjere za postizanje kvalitete materijala i konstrukcija, kao i posebne tehničke uvjete.

Radnje u okviru održavanja betonskih konstrukcija treba provoditi prema odredbama Priloga J.3. Održavanje betonskih konstrukcija, Tehničkog propisa za betonske

konstrukcije (N.N. 139/09, 14/10, 125/10, 136/12) i normama na koje upućuje Prilog J.3., te odgovarajućom primjenom odredbi ostalih priloga Tehničkog propisa za betonske konstrukcije (N.N. 139/09, 14/10, 125/10, 136/12).

Redoviti pregled predmetne građevine, od strane kvalificiranih osoba, a u svrhu održavanja konstrukcije za predmetnu građevinu treba provoditi najmanje svakih 5 godina (zgrade javne namjene). Izvanredne preglede građevine provoditi nakon nekog izvanrednog događaja (ekstremne vremenske neprilike, potres, požar, eksplozija i slično) ili prema zahtjevu inspekcije.

Osim ovih pregleda preporučuje se da korisnici građevine vrše godišnje preglede i ukoliko primjete neku nepravilnost na konstrukciji zatraže redoviti ili izvanredni pregled i prije roka predviđenog ovim projektom. Način obavljanja pregleda uključuje:

- vizualni pregled, u kojeg je uključeno utvrđivanje položaja i veličine napuklina i pukotina te drugih oštećenja bitnih za očuvanje mehaničke otpornosti i stabilnosti građevine,
- utvrđivanja stanja zaštitnog sloja armature, za betonske konstrukcije u umjereno ili jako agresivnom okolišu,
- utvrđivanje veličine progiba glavnih nosivih elemenata betonske konstrukcije za slučaj osnovnog djelovanja, ako se na temelju vizualnog pregleda sumnja u ispunjavanje bitnog zahtjeva mehaničke otpornosti i stabilnosti.

Nakon obavljenih pregleda konstrukcije potrebno je izraditi dokumentaciju o stanju konstrukcije nakon pregleda sa potrebnim mjerama i radovima na saniranju i održavanju konstrukcije. Ovu i drugu dokumentaciju o održavanju betonske konstrukcije dužan je trajno čuvati vlasnik građevine.

Manje nedostatke može ispraviti stručna osoba (zanatlija) na licu mjesta, a kod većih zahvata vlasnik (ili korisnici) građevine dužni su postupiti prema potrebnim zahtjevima i mjerama iz dokumentacije o stanju konstrukcije te izvesti neophodne radove održavanja, obnove i izmjene uređaja i dijelova te radove popravka, ojačanja i rekonstrukcije.

Sve radove pregleda i izvedbe radova na konstrukciji potrebno je povjeriti za to ovlaštenim osobama.

Norme za ispitivanje i održavanje građevina :

HRN ENV 13269

Održavanje – Smjernice za izradu ugovora o održavanju

HRN EN 13306

Nazivlje u održavanju

HRN ENV 13670-1:2002	Izvedba betonskih konstrukcija – 1. dio: Općenito (ENV 13670-1:2000)
HRN U.M1.047:1987	Ispitivanje konstrukcija visokogradnje pokusnim opterećenjem i ispitivanje do sloma
HRN EN 4866:1999	Mehaničke vibracije i udari – Vibracije građevina – Smjernice za mjerenje vibracija i ocjenjivanje njihova utjecaja na građevine (ISO 4866:1990+Dopuna 1:1994+Dopuna 2:1996)
prEN 13791:2003	Ocjena tlačne čvrstoće betona u konstrukcijama ili u konstrukcijskim elementima
HRN ISO 15686-1:2002	Zgrade i druge građevine – Planiranje vijeka uporabe – 1. dio: Opća načela (ISO 15686-1:2000)
HRN ISO 15686-2:2002	Zgrade i druge građevine – Planiranje vijeka uporabe – 2. dio: Postupci predviđanja vijeka uporabe (ISO 15686-2:2001)
HRN ISO 15686-3:2004	Zgrade i druge građevine – Planiranje vijeka uporabe – 3. dio: Neovisne ocjene (auditi) i pregledi svojstava (ISO 15686-3:2002)
HRN 12504-1:2000	Ispitivanje betona u konstrukcijama – 1. dio: Izvađeni uzorci – Uzimanje, pregled i ispitivanje tlačne čvrstoće (EN 12504-1:2000)
HRN 12504-2:2001	Svojstva betona u konstrukcijama – 2.dio: Nerozorno ispitivanje – Određivanje indeksa sklerometra (EN 12504-2:2001)
nHRN EN 12504-3	Ispitivanje betona u konstrukcijama – 3. dio: Određivanje sile čupanja (pull-out) (prEN 12504-3:2003)
HRN EN 12504-4:2004	Ispitivanje betona – 4. dio: Određivanje brzine ultrazvučnog impulsa (EN 12504-4:2004)
HRN EN 12390-1:2001	Ispitivanje očvrsloga betona – 1. dio: Oblik, dimenzije i drugi zahtjevi za uzorke i kalupe (EN 12390-1:2000)
HRN EN 12390-3:2002	Ispitivanje očvrsloga betona – 3. dio: Tlačna čvrstoća ispitnih uzoraka (EN 12390-3:2001)

Očekivani vijek trajanja građevina je 50 godina. Preduvjet za postizanje očekivanog vijeka trajanja je pravilna izvedba te pravilno održavanje u skladu s prethodno navedenim zahtjevima te zakonima i pravilima struke.

5.1 Osnovna djelovanja i kombinacije

5.1.1 Osnovna djelovanja

Osnovna djelovanja, na čiji utjecaj se dokazuje mehanička otpornost i stabilnost predmetne građevine, podijeljena su prema slijedećem:

Oznaka osnovnog djelovanja	Opis djelovanja
G	Stalno djelovanje. Vlastita težina elemenata nosive konstrukcije,
dG	Dodatno stalno djelovanje. Težina obloga (podovi, žbuke), stalna oprema
Q1	Promjenjivo djelovanje: prodajni prostor 7.00 kN/m ² stubište 5.00 kN/m ² skladište 10.0 kN/m ²
Q2	Snijeg: područje opterećenja snijegom: II nadmorska visina: ≤ 100 m.n.m. karakteristična vrijednost snijega na tlu: $s_k=0.45$ kN/m ² opterećenje snijegom na krovu: $s=0.36$ kN/m ²
w	Vjetar: područje III. $v_{ref,0} = 30$ m/s koeficijent unutarnjeg tlaka: $c_{pi} \cong 0.3$ tlak vjetra na vanjske vertikalne površine: $w_e = q_{ref} * C_e(z) * C_{pe}$ tlak vjetra na unutarnje vertikalne površine: $w_i = q_{ref} * C_e(z) * C_{pi}$
S	Potres: računsko ubrzanje tla: $a=0,22g$ m/s ² razred tla: A faktor ponašanja: $q=3,0$

5.1.2 Osnovne kombinacije djelovanja

Granično stanje uporabljivosti

Oznaka kombinacije	Parcijalni faktor za opterećenje	Koristi se za:	Parcijalni faktor za materijale
GSU-1	osnovna kombinacija: $1.0(g+\Delta g)+1.0q$	proračun progiba i pukotina a-b ploča	beton: $\gamma_c=1.5$ čelik: $\gamma_s=1.15$

Granično stanje nosivosti

Oznaka kombinacije	Parcijalni faktor za opterećenje	Koristi se za:	Parcijalni faktor za materijale
GSN-1	osnovna kombinacija: $1.35(g+\Delta g)+ 1.5Q$	proračun ploča, rešetke, stupova i zidova na vertikalna djelovanja kontrola naprezanja u tlu	beton: $\gamma_c=1.5$ čelik: $\gamma_s=1.15$
GSN-2	potres: $1.0(g+\Delta g)+0.5Q +1.0S$	proračun zidova i stupova na djelovanje potresa kontrola naprezanja u tlu	beton: $\gamma_c=1.3$ čelik: $\gamma_s=1.0$

6. ANALIZA OPTEREĆENJA

6.1 Ploča prizemlja (ploča nad garažom)

a) stalno opterećenje

Uključeno je kroz numerički model.

b) dodatno stalno opterećenje

	d (m)	g (kN/m ³)	$d \times g$
Završni slojevi poda	0.025	25.0	0.625
PE folija	0,015	-	-
Termoizolacija	0,05	1,5	0,075
Instalacije	0.10	25.0	2.50

Ukupno dodatno stalno opterećenje: $\Delta g = 3.20$ (kN/m²)

c) pokretno opterećenje

$$q = 7.0 \text{ (kN/m}^2\text{)}$$

NAPOMENA: Nije vršena kombinacija opterećenja, tj. postavljanje pokretnog opterećenja u najkritičnije položaje, već je pokretno opterećenje uvećano za 20%.

6.2 Krov

a) stalno opterećenje

Uključeno je kroz numerički model.

b) dodatno stalno opterećenje

	d (m)	g (kg/m ²)
Krovni panel	0,20	35,8
Instalacije	-	150

Ukupno dodatno stalno opterećenje: $\Delta g = 1,86$ (kN/m²)

c) pokretno opterećenje

Obzirom da je na krov neprohodan, ali postoji mogućnost pojave pokretnog opterećenja zbog raznih popravaka usvojeno je opterećenje $q = 1,00$ kN/m².

Krov se sastoji od prohodnog i neprohodnog dijela (prohodni – ab ploča, neprohodni – čelična rešetka s panelima).

NAPOMENA: Nije vršena kombinacija opterećenja, tj. postavljanje pokretnog opterećenja u najkritičnije položaje, već je pokretno opterećenje uvećano za 20%.

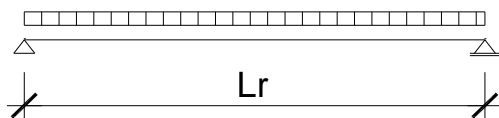

6.3 Stubišta i podesti

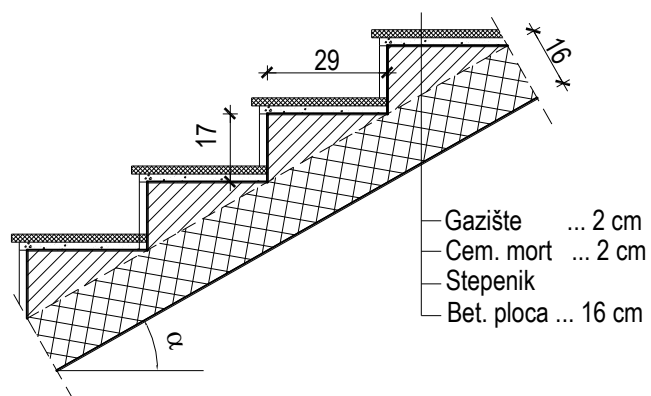

Slika 1: Geometrija stubišta

a) stalno opterećenje

Vlastita težina ploče (u vert. projekciji)	4.5 kN/m ²
Vlastita težina stepenika	2.0 kN/m ²
Ostalo stalno opterećenje	1.0 kN/m ²
Ukupno stalno opterećenje	7.5 kN/m²

b) pokretno opterećenje

Korisni teret (HRN 1991-2-1)	5.0 kN/m ²
Ukupno pokretno opterećenje	5.0 kN/m²

6.4 Vjetar

Objekt se nalazi u III. vjetrovnoj zoni.

Napomena: Kosi krov se odnosi na južni dio krova koji je u nagibu.

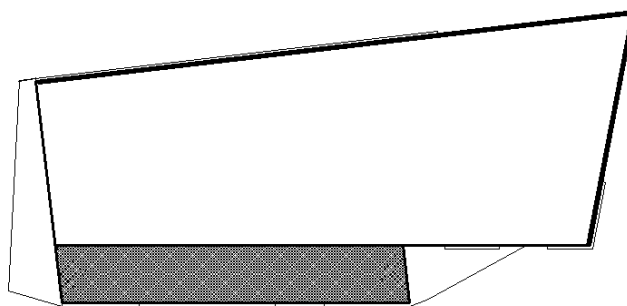

Slika 2: Tlocrtni prikaz građevine

$v_{ref,0} = 30 \text{ m/s}$ - osnovna poredbena brzina vjetra

$C_{dir} = 1,0$

$C_{tem} = 1,0$

$C_{alt} = 1,0$

$v_{ref} = C_{alt} \cdot C_{tem} \cdot C_{dir} \cdot v_{ref,0} = 1,0 \cdot 1,0 \cdot 1,0 \cdot 30 = 30 \text{ m/s}$

$\rho_{zr} = 1.25 \text{ kg/m}^3$

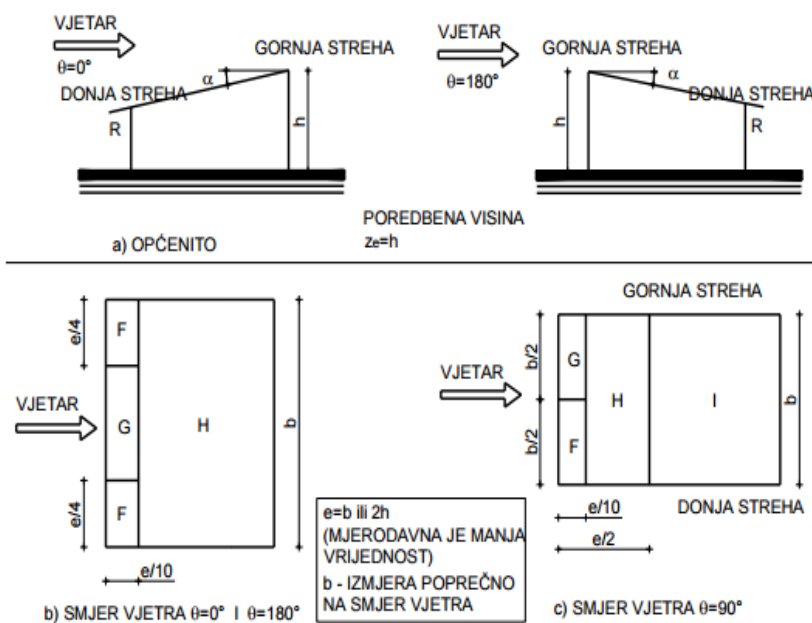

$$\rho_{zr} = 1.25 \text{ kg/m}^3 \approx 1.25 \frac{\text{kg}}{\text{m}^3}$$

$$c_r(z) = \left[k_r \cdot \ln \left(\frac{z}{z_0} \right) \right];$$

$$k_r = 0,19 \cdot \left(\frac{z_0}{z_{0,II}} \right)^{0,07} = 0,19 \cdot \left(\frac{6,25}{0,3} \right)^{0,07} = 0,23$$

visina objekta $h=6,25\text{m}$;

$$c_r(z) = \left[k_r \cdot \ln \left(\frac{z}{z_0} \right) \right] = \left[0,23 \cdot \ln \left(\frac{6,25}{0,3} \right) \right] = 0,7$$

Srednja brzina vjetra:

$$v_m(z) = c_r(z) \cdot c_0(z) \cdot v_{ref} = 0,7 \cdot 1,0 \cdot 30 = 21 \text{ m/s}$$

Turbulencija:

$$l_v(z) = \frac{1}{c_0(z) \cdot \ln \left(\frac{z}{z_0} \right)} = \frac{1}{1,0 \cdot \ln \left(\frac{6,25}{0,3} \right)} = 0,33$$

Maksimalni tlak brzine vjetra:

$$q_p(z) = [1 + 7 \cdot l_v(z)] \frac{\rho_z}{2} \cdot v_m^2(z) = [1 + 7 \cdot 0,33] \frac{1,25}{2} \cdot 21^2 = 0,91 \text{ kN/m}^2$$

$h=6,25\text{m}$; $b_0=55\text{m}$; $b_{90}=9,0\text{m} \rightarrow z_e=h=6,25\text{m}$

Nagib α	Smjer vjetra $\theta = 0^\circ$						Smjer vjetra $\theta = 180^\circ$					
	Područje						Područje					
	F		G		H		F		G		H	
	$c_{pe,10}$	$c_{pe,1}$	$c_{pe,10}$	$c_{pe,1}$	$c_{pe,10}$	$c_{pe,1}$	$c_{pe,10}$	$c_{pe,1}$	$c_{pe,10}$	$c_{pe,1}$	$c_{pe,10}$	$c_{pe,1}$
5°	-1,7	-2,5	-1,2	-2,0	-0,6	-1,2	-2,3	-2,5	-1,3	-2,0	-0,8	-1,2
15°	-0,9	-2,0	-0,8	-1,5	-0,3		-2,5	-2,8	-1,3	-2,0	-0,9	-1,2
	+0,2		+0,2		+0,2							
30°	-0,5	-1,5	-0,5	-1,5	-0,2		-1,1	-2,3	-0,8	-1,5	-0,8	
	+0,7		+0,7		+0,4							
45°	+0,7		+0,7		+0,6		-0,6	-1,3	-0,5		-0,7	
60°	+0,7		+0,7		+0,7		-0,5	-1,0	-0,5		-0,5	
75°	+0,8		+0,8		+0,8		-0,5	-1,0	-0,5		-0,5	

Nagib α	Smjer vjetra $\theta = 90^\circ$							
	Područje							
	F		G		H		I	
	$c_{pe,10}$	$c_{pe,1}$	$c_{pe,10}$	$c_{pe,1}$	$c_{pe,10}$	$c_{pe,1}$	$c_{pe,10}$	$c_{pe,1}$
5°	-1,6	-2,2	-1,8	-2,0	-0,6	-1,2	-0,5	
15°	-1,3	-2,0	-1,9	-2,5	-0,8	-1,2	-0,7	-1,2
30°	-1,2	-2,0	-1,5	-2,0	-1,0	-1,3	-0,8	-1,2
45°	-1,2	-2,0	-1,4	-2,0	-1,0	-1,3	-0,9	-1,2
60°	-1,2	-2,0	-1,2	-2,0	-1,0	-1,3	-0,7	-1,2
75°	-1,2	-2,0	-1,2	-2,0	-1,0	-1,3	-0,5	

Kod $\theta = 0^\circ$ i nagiba strehe od $\alpha = +15^\circ$ do $+30^\circ$ tlak se brzo mijenja između + i - vrijednosti tako da su dane obje

Može se upotrijebiti linearna interpolacija za međukutove nagiba ako su vrijednosti istog predznaka

III. kategorija terena:

SMJER VJETRA $\Theta = 0^\circ$

$$e = \min \{b; 2h\} = \min \{55m; 2 \cdot 6,25 = 12,5m\} = 12,5m$$

$$e/4 = 3,13 \text{ m}$$

$$e/10 = 1,25 \text{ m}$$

za nagib 5°

PODRUČJE	F	G	H
c_{pe}	-2,02	-1,2	-0,6

Napomena: koeficijent za područje F je određen linearnom interpolacijom

SMJER VJETRA $\Theta = 90^\circ$

$$e = \min \{b; 2h\} = \min \{9m; 2 \cdot 6,25 = 12,5m\} = 9m$$

$$e/4 = 2,25 \text{ m}$$

$$e/10 = 0,9 \text{ m}$$

za nagib 5°

PODRUČJE	F	G	H	I
c_{pe}	-2,07	-1,91	-0,6	-0,5

Pritisak vjetra na unutrašnje površine:

$$w_i = q_p \cdot c_{pi} = 0,91 \cdot (\pm c_{pi}) \frac{kN}{m^2}$$

Pritisak vjetra na vanjske površine:

$$w_e = q_p \cdot c_{pe} = 0,91 \cdot c_{pe} \frac{kN}{m^2}$$

PODRUČJE	F	G	H	
$C_{pe,10}$ za 0	-2,02	-1,2	-0,6	
w_e (kN/m ²)	-1,84	-1,09	-0,55	
PODRUČJE	F	G	H	I
$C_{pe,10}$ za 90	-2,07	-1,91	-0,6	-0,5
w_e (kN/m ²)	-1,88	-1,74	-0,55	-0,45

Koeficijent unutarnjeg tlaka c_{pi} za zgrade bez unutarnjih pregrada funkcija je omjera otvora μ .

$$\mu = \frac{\sum \text{ploha otvora u zavjetrini i na stranama usporednima sa smjerom vjetra}}{\sum_i \text{ploha otvora u privjetroj strani, na strani u zavjetrini stranama usporednima sa smjerom vjetra}}$$

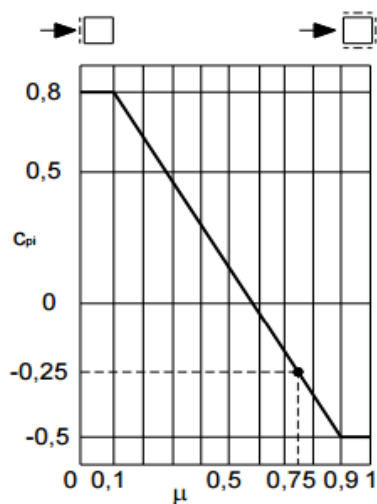

$$\mu_{za90^\circ} = 0,88 \rightarrow c_{pi} = -0,45$$

$$\mu_{za0^\circ} = 0,62 \rightarrow c_{pi} = -0,09$$

$$w_i = q_p \cdot C_{pi} = 0,91 \cdot (-0,45) = -0,41 \frac{kN}{m^2}$$

$$w_i = q_p \cdot C_{pi} = 0,91 \cdot (-0,09) = -0,082 \frac{kN}{m^2}$$

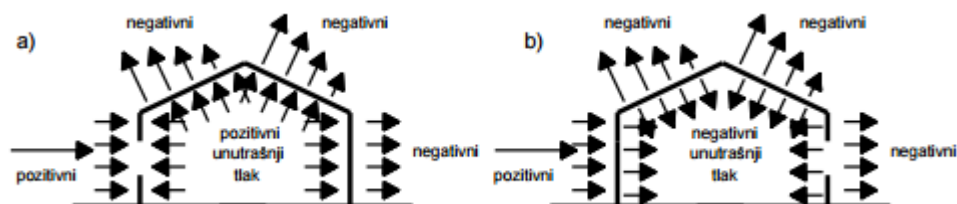

PODRUČJE	F 0°	G 0°	H 0°	
$w_e(\text{kN/m}^2)$ 0°	-1,84	-1,09	-0,55	
$w_i(\text{kN/m}^2)$ 0°	-0,082	-0,082	-0,082	
$w_1(\text{kN/m}^2)$	-1,76	-1,008	-0,47	
$w_e(\text{kN/m}^2)$ 90°	-1,88	-1,74	-0,55	-0,45
$w_i(\text{kN/m}^2)$ 90°	-0,41	-0,41	-0,41	-0,41
$w_2(\text{kN/m}^2)$	-1,47	-1,33	-0,14	-0,04

Napomena: Ravni krov se odnosi na sjeverni dio krova koji je u nezatnom nagibu te ima zid visok 6 m sa sjeverne strane

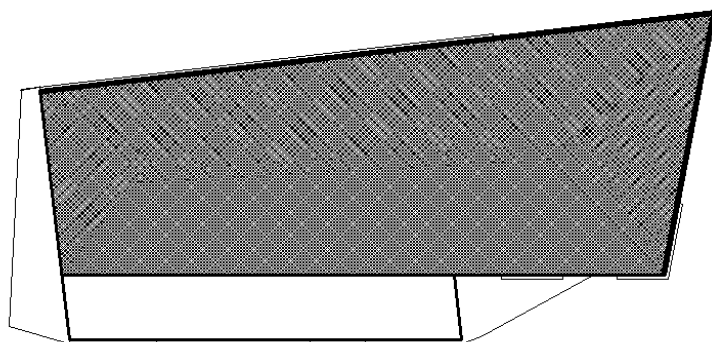

$v_{ref,0} = 30 \text{ m/s}$ - osnovna poredbena brzina vjetra

$$C_{dir} = 1,0$$

$$C_{tem} = 1,0$$

$$C_{alt} = 1,0$$

$$v_{ref} = C_{alt} \cdot C_{tem} \cdot C_{dir} = 30,0 \cdot 1,0 \cdot 1,0 \cdot 1,0 = 30 \text{ m/s}$$

$$\rho_{zr} = 1,25 \text{ kg/m}^3$$

$$\rho_{zr} = 1,25 \text{ kg/m}^3 \approx 1,25 \frac{\text{kg}}{\text{m}^3}$$

$$c_r(z) = \left[k_r \cdot \ln \left(\frac{z}{z_0} \right) \right];$$

$$k_r = 0,19 \cdot \left(\frac{z_0}{z_{o,II}} \right)^{0,07} = 0,19 \cdot \left(\frac{6,25}{0,3} \right)^{0,07} = 0,23$$

visina objekta $h=6,25\text{m}$;

$$c_r(z) = \left[k_r \cdot \ln \left(\frac{z}{z_0} \right) \right] = \left[0,23 \cdot \ln \left(\frac{6,25}{0,3} \right) \right] = 0,7$$

Srednja brzina vjetra:

$$v_m(z) = c_r(z) \cdot c_0(z) \cdot v_{ref} = 0,7 \cdot 1,0 \cdot 30 = 21\text{m/s}$$

Turbulencija:

$$l_v(z) = \frac{1}{c_0(z) \cdot \ln \left(\frac{z}{z_0} \right)} = \frac{1}{1,0 \cdot \ln \left(\frac{6,25}{0,3} \right)} = 0,33$$

Maksimalni tlak brzine vjetra:

$$q_p(z) = \left[1 + 7 \cdot l_v(z) \right] \frac{\rho_z}{2} \cdot v_m^2(z) = \left[1 + 7 \cdot 0,33 \right] \frac{1,25}{2} \cdot 21^2 = 0,91\text{kN/m}^2$$

$h=6,25\text{m}$; $b_0=90\text{m}$; $b_{90}=35,0\text{m} \rightarrow z_e=h=6,25\text{m}$

Vrsta krova		Područje							
		F		G		H		I	
		$c_{pe,10}$	$c_{pe,1}$	$c_{pe,10}$	$c_{pe,1}$	$c_{pe,10}$	$c_{pe,1}$	$c_{pe,10}$	$c_{pe,1}$
Oštri zabati		-1,8	-2,5	-1,2	-2,0	-0,7	-1,2	+0,2	-0,2
S nadozidima	$h_p/h = 0,025$	-1,6	-2,2	-1,1	-1,8	-0,7	-1,2	+0,2	-0,2
	$h_p/h = 0,05$	-1,4	-2,0	-0,9	-1,6	-0,7	-1,2	+0,2	-0,2
	$h_p/h = 0,10$	-1,2	-1,8	-0,8	-1,4	-0,7	-1,2	+0,2	-0,2
Zaobljeni zabati	$r/h = 0,05$	-1,0	-1,5	-1,2	-1,8	-0,4		+0,2	-0,2
	$r/h = 0,10$	-0,7	-1,2	-0,8	-1,4	-0,3		+0,2	-0,2
	$r/h = 0,20$	-0,5	-0,8	-0,5	-0,8	-0,3		+0,2	-0,2
Izlomljeni zabati	$\alpha = 30^\circ$	-1,0	-1,5	-1,0	-1,5	-0,3		+0,2	-0,2
	$\alpha = 45^\circ$	-1,2	-1,8	-1,3	-1,9	-0,4		+0,2	-0,2
	$\alpha = 60^\circ$	-1,3	-1,9	-1,3	-1,9	-0,5		+0,2	-0,2

III. kategorija terena:

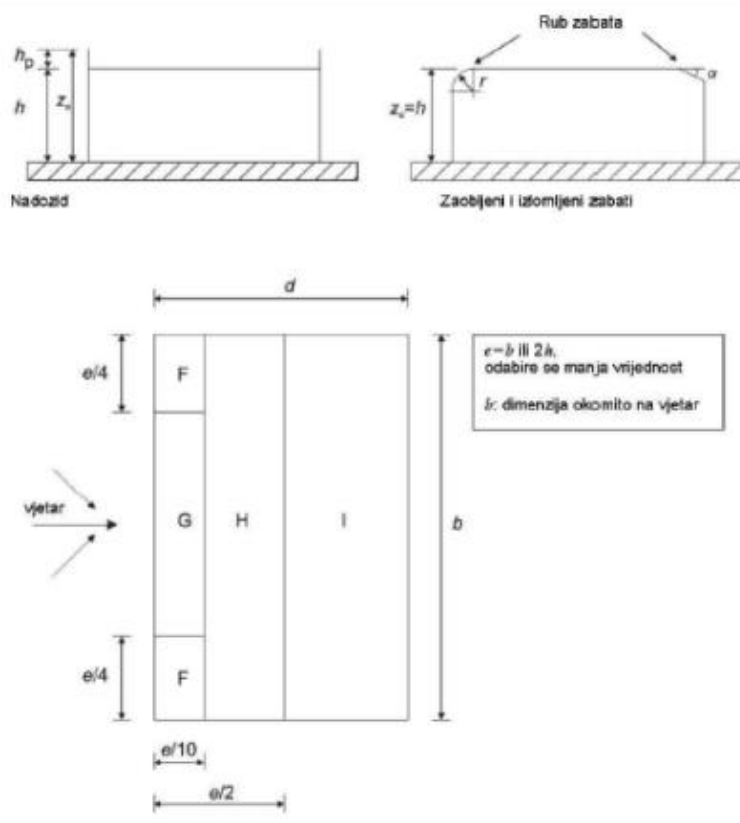
SMJER VJETRA $\Theta = 0^{\circ}$

$$e = \min \{b; 2h\} = \min \{90m; 2 \cdot 6,25 = 12,5m\} = 12,5m$$

$$e/4 = 3,13 \text{ m}$$

$$e/10 = 1,25 \text{ m}$$

za nagib 2°

PODRUČJE	F	G	H	I
c_{pe}	-1,00	-0,8	-0,3	$\pm 0,2$

Napomena: koeficijent za područje F je određen linearnom interpolacijom

SMJER VJETRA $\Theta = 90^{\circ}$

Napomena: i u ovom smjeru su zaobljeni zabati

$$e = \min \{b; 2h\} = \min \{35m; 2 \cdot 6,25 = 12,5m\} = 12,5m$$

$$e/4 = 3,13 \text{ m}$$

$$e/10 = 1,25 \text{ m}$$

za nagib 2°

PODRUČJE	F	G	H	I
c_{pe}	-1,00	-0,8	-0,3	$\pm 0,2$

Pritisak vjetra na unutrašnje površine:

$$w_i = q_p \cdot c_{pi} = 0,91 \cdot (\pm c_{pi}) \frac{kN}{m^2}$$

Pritisak vjetra na vanjske površine:

$$w_e = q_p \cdot c_{pe} = 0,91 \cdot c_{pe} \frac{kN}{m^2}$$

PODRUČJE	F	G	H	I
C_{pe} za 0	-1,0	-0,8	-0,3	$\pm 0,2$
$w_e(kN/m^2)$	-0,91	-1,35	-0,27	$\pm 0,18$
PODRUČJE	F	G	H	I
C_{pe} za 90	-1,0	-0,8	-0,3	$\pm 0,2$
$w_e(kN/m^2)$	-0,91	-1,35	-0,27	$\pm 0,18$

Koeficijent unutarnjeg tlaka c_{pi} za zgrade bez unutarnjih pregrada funkcija je omjera otvora μ .

$$\mu = \frac{\sum \text{ploha otvora u zavjetrini i na stranama usporednimsa smjerom vjetra}}{\sum \text{ploha otvora u privjetrenoj strani, na strani u zavjetrini i na stranama usporednimsa smjerom vjetra}}$$

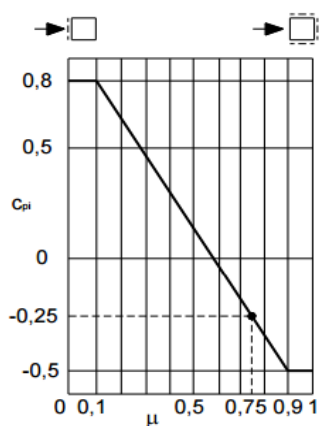

$$\mu_{za90^\circ} = 0,88 \rightarrow c_{pi} = -0,45$$

$$\mu_{za0} = 0,62 \rightarrow c_{pi} = -0,09$$

$$w_i = q_p \cdot C_{pi} = 0,91 \cdot (-0,45) = -0,41 \frac{kN}{m^2}$$

$$w_i = q_p \cdot C_{pi} = 0,91 \cdot (-0,09) = -0,082 \frac{kN}{m^2}$$

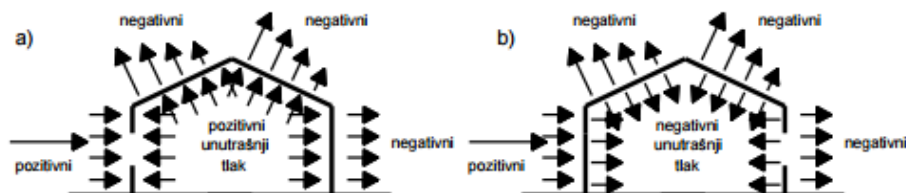

PODRUČJE	F	G	H	I
$w_e(kN/m^2) 0^\circ$	-0,91	-1,35	-0,27	$\pm 0,18$
$w_i(kN/m^2) 0^\circ$	-0,082	-0,082	-0,082	-0,082
$w_1(kN/m^2)$	-0,992	-1,43	-0,35	-0,26
$w_e(kN/m^2) 90^\circ$	-0,91	-1,35	-0,27	$\pm 0,18$
$w_i(kN/m^2) 90^\circ$	-0,41	-0,41	-0,41	-0,41
$w_2(kN/m^2)$	-1,32	-1,76	-0,68	-0,59

-vertikalni zidovi

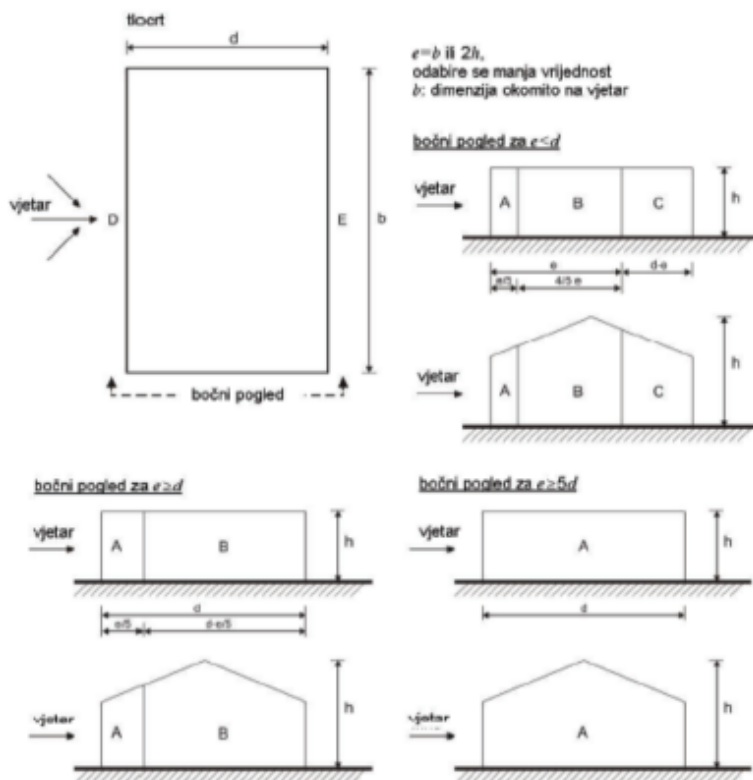

Područje	A		B		C		D		E	
	$c_{pe,10}$	$c_{pe,1}$	$c_{pe,10}$	$c_{pe,1}$	$c_{pe,10}$	$c_{pe,1}$	$c_{pe,10}$	$c_{pe,1}$	$c_{pe,10}$	$c_{pe,1}$
5	-1,2	-1,4	-0,8	-1,1	-0,5		+0,8	+1,0		-0,7
1	-1,2	-1,4	-0,8	-1,1	-0,5		+0,8	+1,0		-0,5
$\leq 0,25$	-1,2	-1,4	-0,8	-1,1	-0,5		+0,7	+1,0		-0,3

SMJER VJETRA $\Theta = 0^\circ$

$$e = \min \{b; 2h\} = \min \{90m; 2 \cdot 11,5 = 23m\} = 23m$$

$$e/5 = 4,6 \text{ m}$$

$$e4/5 = 18,4 \text{ m}$$

Pritisak vjetra na površine:

$$w_i = q_p \cdot c_{pi} = 0,91 \cdot (\pm c_{pi}) \frac{kN}{m^2}$$

PODRUČJE	A	B	C	D	E
C_{pe} za 0	-1,2	-0,8	-0,5	+0,8	-0,5
w_e (kN/m ²)	-1,09	-0,73	-0,45	0,73	-0,45

SMJER VJETRA $\Theta = 90^\circ$

$$e = \min \{b; 2h\} = \min \{35m; 2 \cdot 6,25 = 12,5m\} = 12,5m$$

$$e/5 = 3,125 \text{ m}$$

$$e4/5 = 10 \text{ m}$$

Pritisak vjetra na površine:

$$w_i = q_p \cdot c_{pi} = 0,91 \cdot (\pm c_{pi}) \frac{kN}{m^2}$$

PODRUČJE	A	B	C	D	E
C_{pe} za 0	-1,2	-0,8	-0,5	+0,8	-0,5
w_e (kN/m ²)	-1,09	-0,73	-0,45	0,73	-0,45

-trenje

$$w_{fr} = q_p \cdot c_{tr} = 0,91 \cdot 0,02 = 0,018 \frac{kN}{m^2}$$

$$N_{fr} = w_{fr} \cdot \frac{l_{objekta}}{2} \cdot l = 0,113 \cdot \frac{95,25}{2} \cdot 35,39 = 190,46kN$$

6.5 Snijeg

Opterećenje snijegom na krovu

$$s = \mu_1 \cdot C_e \cdot C_t \cdot s_k$$

- μ_1 - koef. oblika za opterećenje snijegom

krov nagiba $0^\circ \leq \beta \leq 15^\circ \Rightarrow \mu_1 = 0,8$

- s_k - karakteristična vrijednost opterećenja na tlu u $[kN/m^2]$

grad Split, područje C (zona II), nadmorska visina do 100 m $\Rightarrow s_k = 0,45 [kN/m^2]$

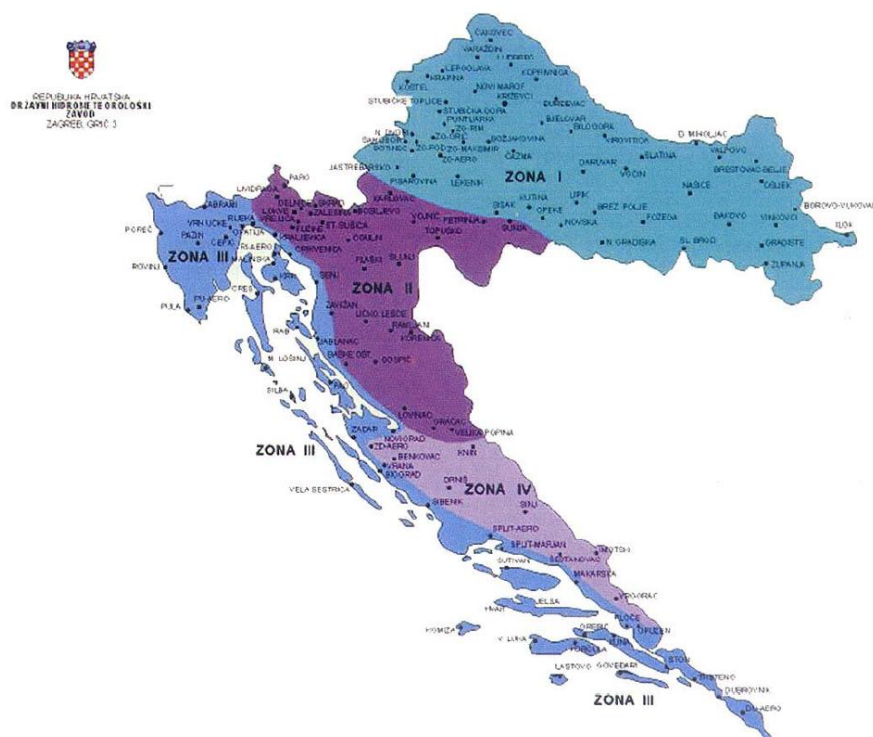

Slika 3: Karta područja za opterećenja snijegom

- C_e - koef. izloženosti $\Rightarrow C_e = 1,0$

- C_t - toplinski koef. $\Rightarrow C_t = 1,0$

$$s = \mu_1 \cdot C_e \cdot C_t \cdot s_k$$

$$\Rightarrow s = 0,8 \cdot 1,0 \cdot 1,0 \cdot 0,45 = 0,36 [kN/m^2]$$

$$s_1 = 0,36 \text{ kN/m}^2$$

$$s_2 = 0,18 \text{ kN/m}^2$$

6.6 Potres

Potresne sile proračunate su metodom spektralne analize prema EC-8 pomoću računalnog programa koristeći prostorni model konstrukcije. Građevina se nalazi u blizini Trogira i smještena je u zonu gdje poredbeno vršno ubrzanje temeljnog tla iznosi $\alpha=0.222g$ prema važećoj seizmičkoj karti (povratni period 475 godina za GSN).

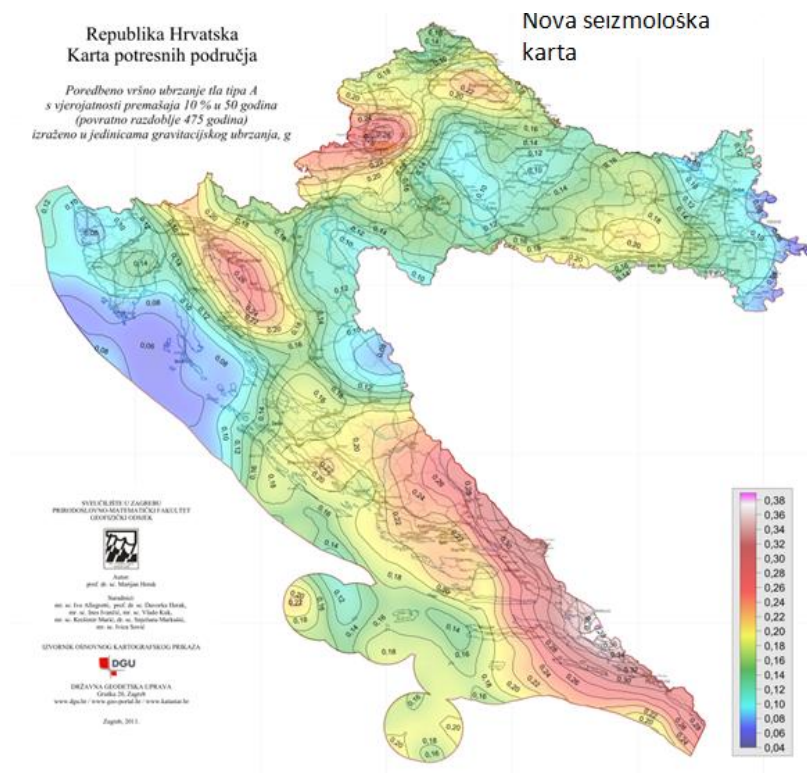

Slika 4: Seizmiološka karta Republike Hrvatske, HRN



Slika 5: Prikaz parametara za promatranu lokaciju

Građevina je temeljena na tlu klase B („Naslage vrlo krutog pijeska, šljunka ili prekonsolidirane gline, debljine do nekoliko desetaka metara, s postupnim povećanjem mehaničkih svojstava s dubinom i brzinom širenja poprečnih valova; $v_s=360-800\text{m/s}$ “). Pretpostavlja se srednja klasa ponašanja: DCM (medium ductility)

$$\alpha = \frac{a_g}{g} = 0,22$$

$$S = 1,2$$

$$\beta_0 = 0,2$$

$$T_B = 0,15 \quad ; \quad T_C = 0,5 \quad ; \quad T_D = 2,0$$

Faktor značaja: $\gamma = 1.20$ (zgrada povećane seizmičke otpornosti).

Faktor ponašanja $q=3$ - nepovezani zidovi

Građevina potresne sile preuzima obodnim zidovima i stupovima.

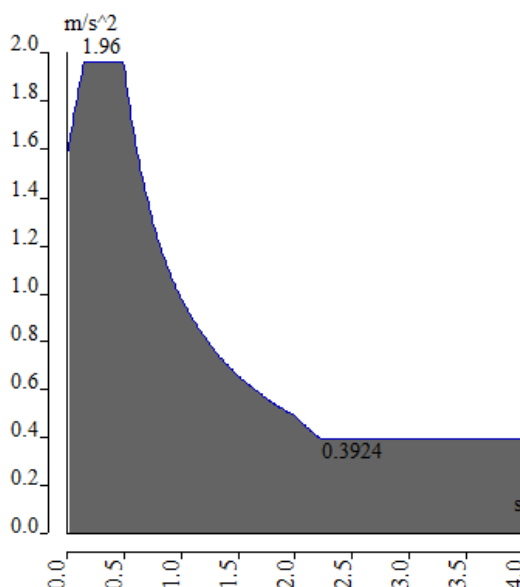

Slika 6: Proračunski spektar odgovora

Potresno djelovanje je automatski generirano računalom na temelju sudjelujućih masa generiranih iz opterećenja vlastitom težinom, dodatnog stalnog opterećenja, te na temelju masa generiranih iz jednog dijela pokretnog opterećenja.

Na temelju tih ulaznih podataka napravljena je modalna analiza iz koje su dobiveni vlastiti oblici konstrukcije i njima pripadajući periodi sa sudjelujućim masama.

6.7 Kombinacije djelovanja

Na temelju navedenih i prikazanih opterećenja izrađene su kombinacije mjerodavne za pojedine konstruktivne elemente. U ovom slučaju uzete su mjerodavne kombinacije koje se odnose na krajnje granično stanje i granično stanje uporabivosti za svaki pojedinačni element.

6.7.1 Osnovne kombinacije djelovanja

Kombinacije krajnjeg graničnog stanja za krovnu konstrukciju:

$$\text{GSN 1 – Snijeg – } 1,35 (g+\Delta g) + 1,5s$$

$$\text{GSN 2 – Vjetar } 0^\circ \text{ – } 1,35 (g+\Delta g) + 1,5w_0$$

$$\text{GSN 3 – Vjetar } 90^\circ \text{ – } 1,35 (g+\Delta g) + 1,5w_{90}$$

Kombinacije krajnjeg graničnog stanja za međukatnu konstrukciju:

$$\text{GSN 4 – } 1,35 (g+\Delta g) + 1,5p$$

Kombinacije krajnjeg graničnog stanja za zidove i stupove:

$$\text{GSN 2 – Vjetar } 0^\circ \text{ – } 1,35 (g+\Delta g) + 1,5w_0$$

$$\text{GSN 3 – Vjetar } 90^\circ \text{ – } 1,35 (g+\Delta g) + 1,5w_{90}$$

$$\text{GSN 1 – Snijeg – } 1,35 (g+\Delta g) + 1,5s$$

Kombinacije krajnjeg graničnog stanja za temelje:

$$\text{GSN 5 – } 1,35 (g+\Delta g) + 1,5p + 0,9(1,5 s)$$

Kombinacije krajnjeg graničnog stanja uporabe:

$$\text{GSU 1 – } 1,0 (g+\Delta g) + 1,0p$$

$$\text{GSU 2 – } 1,0 (g+\Delta g) + 1,0s$$

6.7.2 Seizmičke kombinacije djelovanja

$$\text{GSN – } S_x \text{ – } 1,00 (g+\Delta g) + 0,5q + 1,0S_x + 0,3S_y$$

$$\text{GSN – } S_y \text{ – } 1,00 (g+\Delta g) + 0,5q + 1,0S_y + 0,3S_x$$

7. PRORAČUN KROVNE REŠETKE

Krovna rešetka se nalazi na dijelu objekta koji je pretežno skeletni sustav. Rešetka se sastoji od 9 glavnih rešetkastih nosača, tri poprečne rešetke i podrožnica za prihvat krovnih panela.

Dio krova koji čini krovna rešetka nije predviđen kao prohodan. Opterećenje na krovnu rešetku čine vlastita težina, dodatno stalno opterećenje (krovni panel + instalacije), vjetar, snijeg i minimalno pokretno opterećenje.

Rešetka je dimenzionirana u programskom paketu „SCIA Engineer 16“.

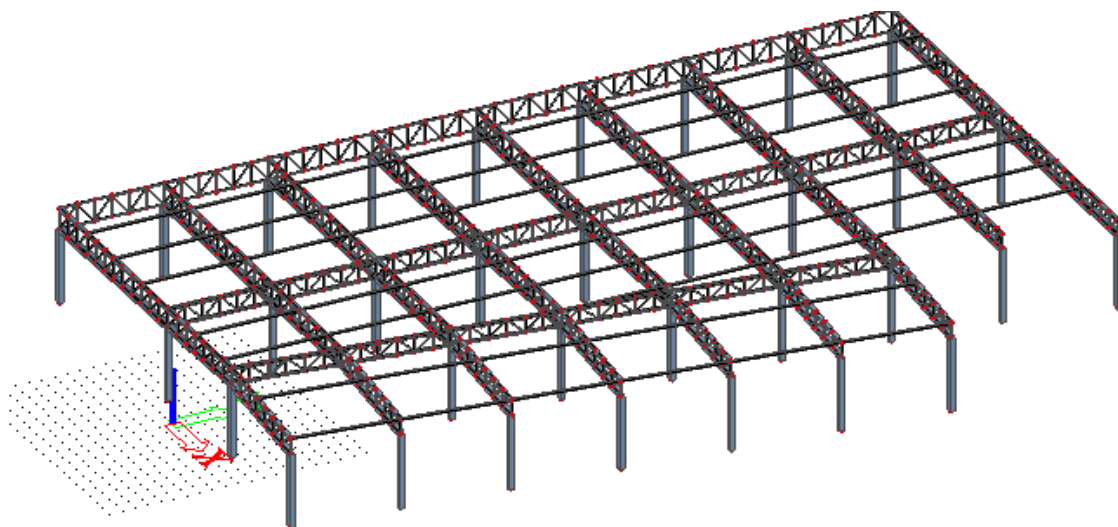

Slika 7: Prikaz modela krovne rešetke

Opterećenje na rešetku:

-dodatno stalno

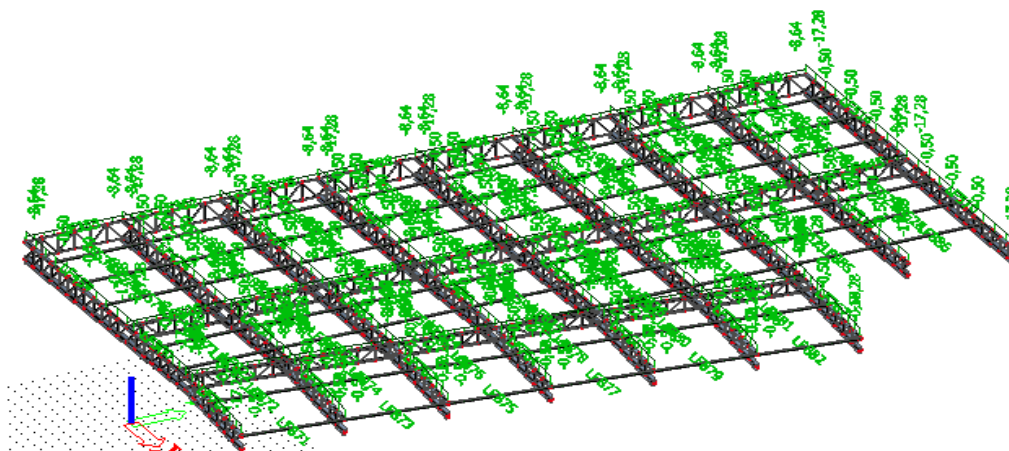

Slika 8: Prikaz raspodjele dodatnog stalnog opterećenja

-snijeg

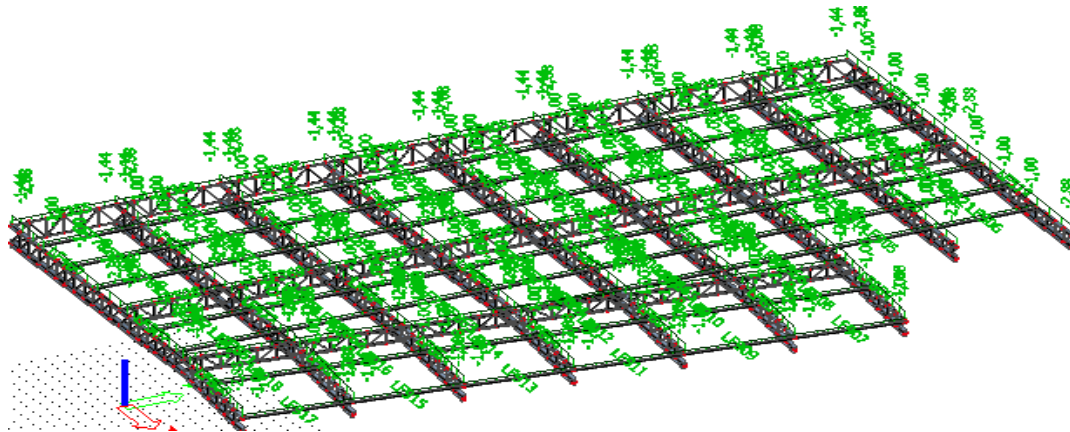

Slika 9: Prikaz raspodjele opterećenja snijegom

- vjetar 90 °

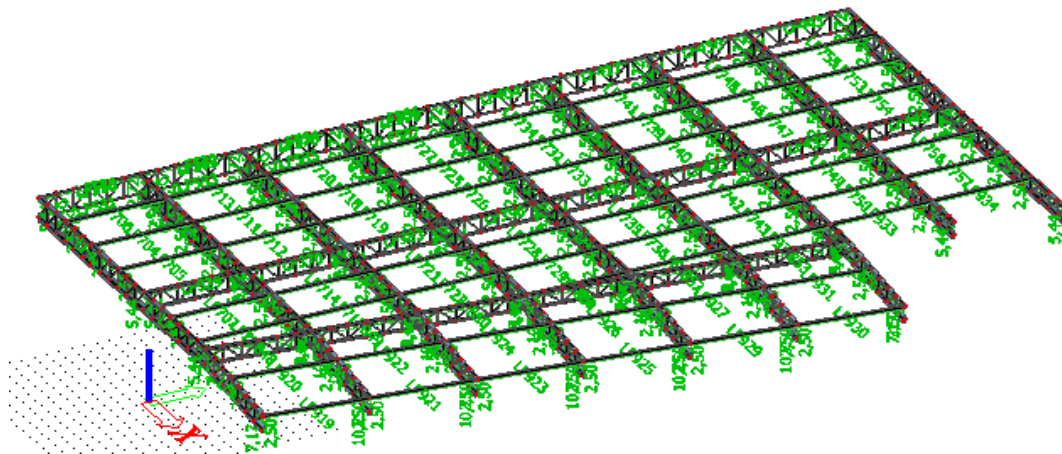

Slika 10: Prikaz raspodjele opterećenja vjetrom

-vjetar 0°

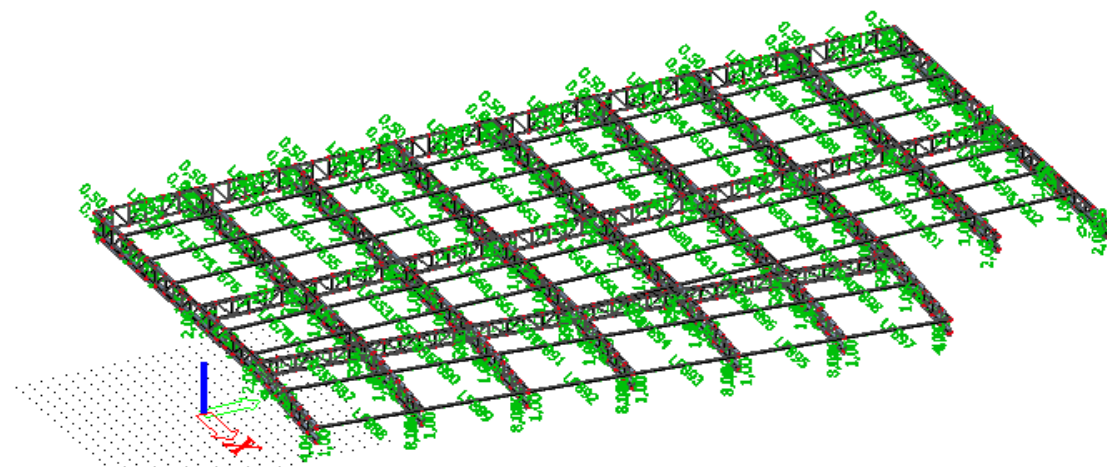

Slika 11: Prikaz raspodjele opterećenja vjetrom

7.1 Dimenzioniranje podrožnica

Kritično opterećenje vjetar iz smjera 0°

- Kombinacija: GSN - Snijeg $1,35 \cdot (g + \Delta g) + 1,5 \cdot s$

7.1.1 Rezne sile

❖ M_y (kNm)

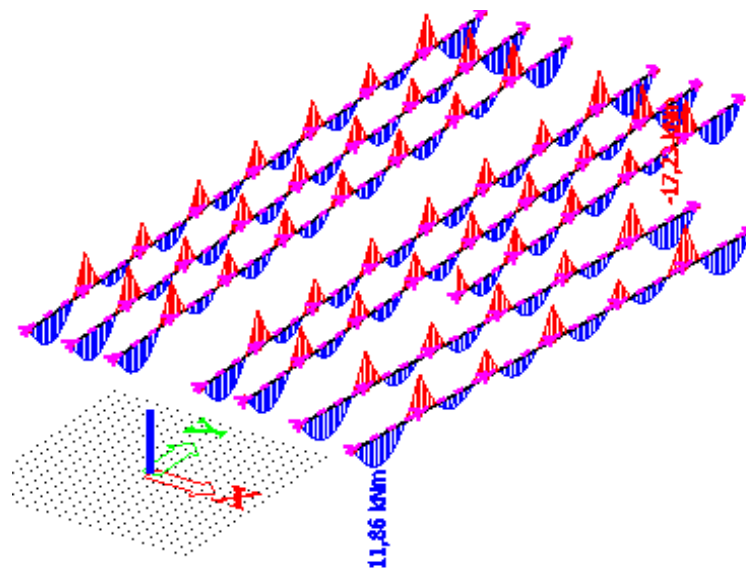

❖ V_z (kN)

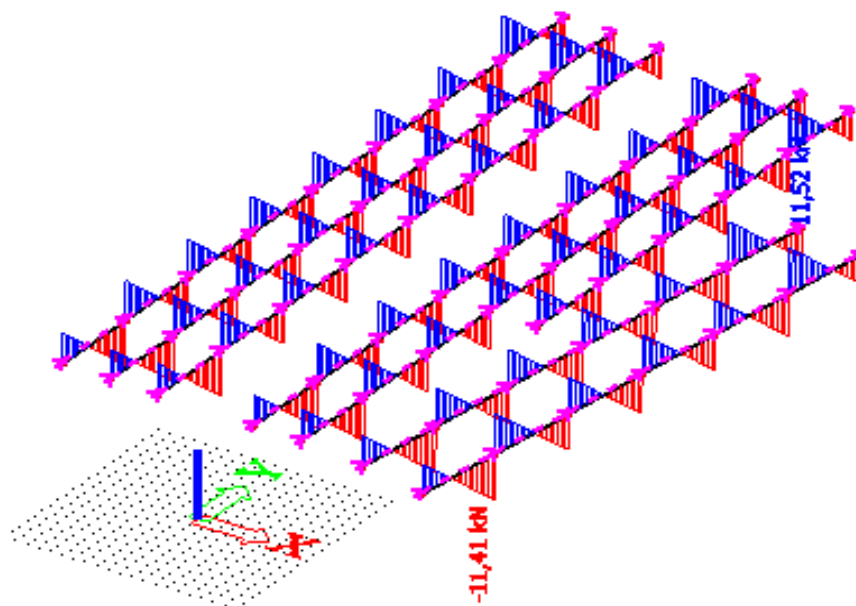

❖ N (kN)

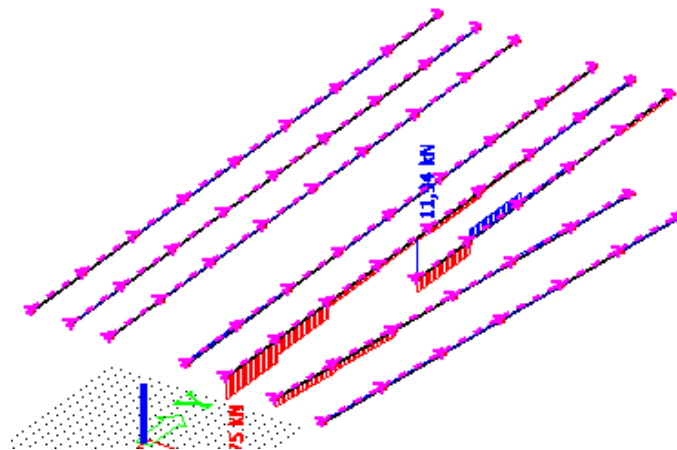

7.1.2 Dimenzioniranje

Member B1	8,124 m	HEA240	S 355	CO1	0,85 -
-----------	---------	--------	-------	-----	--------

Partial safety factors	
Gamma M0 for resistance of cross-sections	1,00
Gamma M1 for resistance to instability	1,00
Gamma M2 for resistance of net sections	1,25

Material		
Yield strength fy	355,0	MPa
Ultimate strength fu	490,0	MPa
Fabrication	Rolled	

....SECTION CHECK:....

The critical check is on position 4,062 m

Internal forces	Calculated	Unit
N,Ed	0,00	kN
Vy,Ed	0,00	kN
Vz,Ed	0,00	kN
T,Ed	0,00	kNm
My,Ed	134,68	kNm
Mz,Ed	0,00	kNm

Classification for cross-section design

According to EN 1993-1-1 article 5.5.2

Classification of Internal Compression parts

According to EN 1993-1-1 Table 5.2 Sheet 1

Maximum width-to-thickness ratio	21,87
Class 1 Limit	58,58
Class 2 Limit	67,53
Class 3 Limit	100,89

-> Internal Compression parts Class 1

Classification of Outstand Flanges

According to EN 1993-1-1 Table 5.2 Sheet 2

Maximum width-to-thickness ratio	7,94
Class 1 Limit	7,32
Class 2 Limit	9,14
Class 3 Limit	11,20

-> Outstand Flanges Class 2

-> Section classified as Class 2 for cross-section design

Bending moment check for My

According to EN 1993-1-1 article 6.2.5 and formula (6.12)/(6.13)

Wply	7,4583e-04	m ³
Mply,Rd	284,77	kNm
Unity check	0,51	-

The member satisfies the section check.

....STABILITY CHECK:....

Classification for member buckling design

Decisive position for stability classification: 0,812 m

Classification of Internal Compression parts

According to EN 1993-1-1 Table 5.2 Sheet 1

Maximum width-to-thickness ratio	21,87
Class 1 Limit	58,58
Class 2 Limit	67,53
Class 3 Limit	100,89

-> Internal Compression parts Class 1

Classification of Outstand Flanges

According to EN 1993-1-1 Table 5.2 Sheet 2

Maximum width-to-thickness ratio	7,94
Class 1 Limit	7,32
Class 2 Limit	9,14
Class 3 Limit	11,20

-> Outstand Flanges Class 2

-> Section classified as Class 2 for member buckling design

LTB parameters		
Student version	Student version	Student version
Imperfection Alpha,LT	0,21	
Reduction factor Chi,LT	0,60	
Design buckling resistance Mb,Rd	158,47	kNm
Unity check	0,85	-

Mcr parameters		
Student version	Student version	Student version
LTB length L	8,124	m
Influence of load position	no influence	
Correction factor k	1,00	
Correction factor kw	1,00	
LTB moment factor C1	1,13	
LTB moment factor C2	0,45	
LTB moment factor C3	0,53	
Shear center distance dz	0	mm
Distance of load application z.g	0	mm
Mono-symmetry constant beta,y	0	mm
Mono-symmetry constant z,j	0	mm

Note: C parameters are determined according to ECSS 119 2006 / Galea 2002.
The member satisfies the stability check.

MATERIJAL

$f_y = 355 \text{ N/mm}^2$
 $f_u = 510 \text{ N/mm}^2$
 $\epsilon = 0,814$
 $E = 210000 \text{ N/mm}^2$
 $G = 80777 \text{ N/mm}^2$
 $\nu = 0,3$

REZNE SILE**PARC. FAKTORI SIG.**

$\gamma_{M0} = 1,1$
 $\gamma_{M1} = 1,1$
 $\gamma_{M2} = 1,25$

PARAMETRI

$A = 76,800 \text{ cm}^2$
 $A_y = 59,700 \text{ cm}^2$
 $A_z = 25,200 \text{ cm}^2$
 $I_y = 7763,200 \text{ cm}^4$
 $W_y = 675,100 \text{ cm}^3$
 $W_{ply} = 744,600 \text{ cm}^3$
 $i_y = 10,100 \text{ cm}$
 $I_z = 2768,800 \text{ cm}^4$
 $W_z = 230,700 \text{ cm}^3$
 $W_{plz} = 351,700 \text{ cm}^3$
 $i_z = 6,000 \text{ cm}$
 $I_t = 41,600 \text{ cm}^4$
 $I_\omega = 328485,900 \text{ cm}^6$

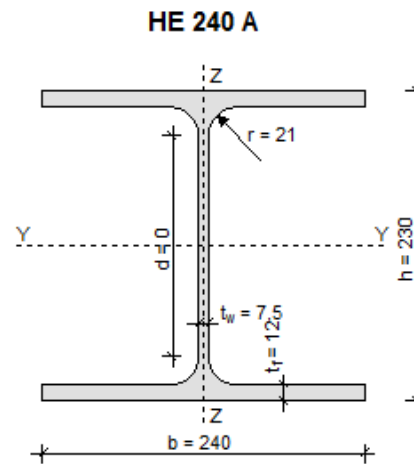

7.2 Dimenzioniranje glavne rešetke

7.2.1 Gornji pojas

Kritično opterećenje snijegom

- Kombinacija: GSN - Snijeg $1,35 \cdot (g + \Delta g) + 1,5 \cdot s$

Rezne sile

M_y (kNm)

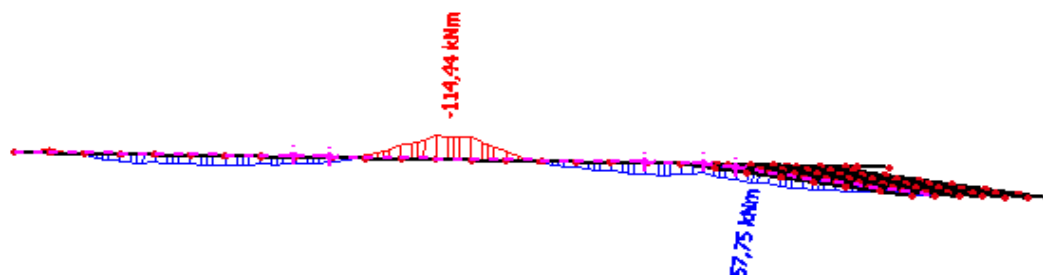

V_z (kN)

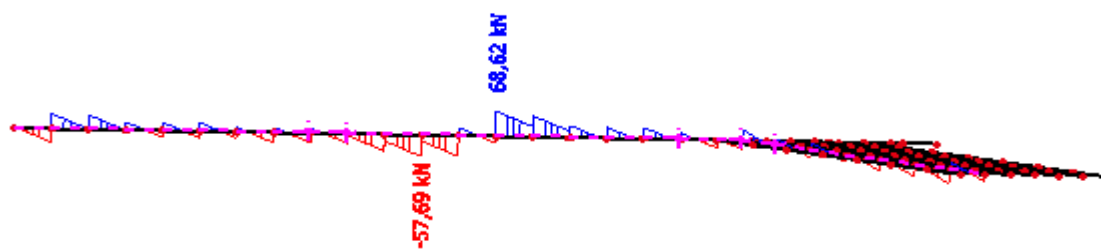

N (kN)

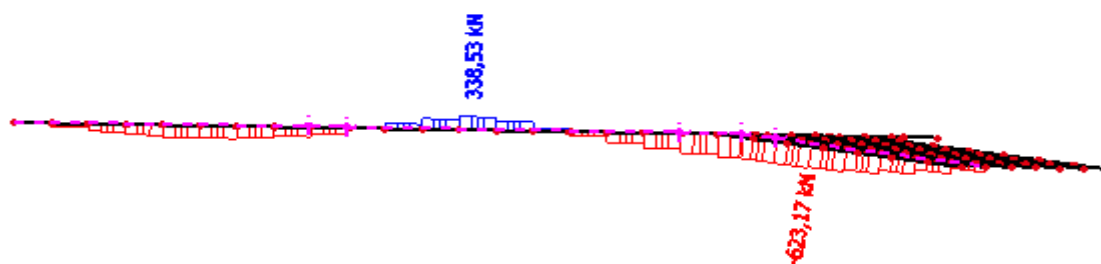

MATERIJAL

$f_y = 355 \text{ N/mm}^2$
 $f_u = 510 \text{ N/mm}^2$
 $\epsilon = 0,814$
 $E = 210000 \text{ N/mm}^2$
 $G = 80777 \text{ N/mm}^2$
 $\nu = 0,3$

REZNE SILE

PARC. FAKTORI SIG.

$\gamma_{M0} = 1,1$
 $\gamma_{M1} = 1,1$
 $\gamma_{M2} = 1,25$

PARAMETRI

$A = 76,800 \text{ cm}^2$
 $A_y = 59,700 \text{ cm}^2$
 $A_z = 25,200 \text{ cm}^2$
 $I_y = 7763,200 \text{ cm}^4$
 $W_y = 675,100 \text{ cm}^3$
 $W_{ply} = 744,600 \text{ cm}^3$
 $i_y = 10,100 \text{ cm}$
 $I_z = 2768,800 \text{ cm}^4$
 $W_z = 230,700 \text{ cm}^3$
 $W_{plz} = 351,700 \text{ cm}^3$
 $i_z = 6,000 \text{ cm}$
 $I_t = 41,600 \text{ cm}^4$
 $I_{\omega} = 328485,900 \text{ cm}^6$

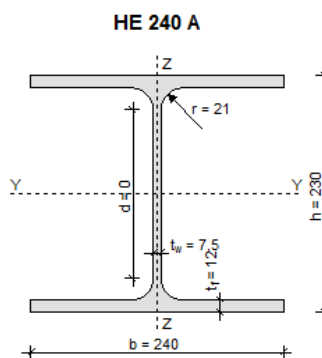

Member B1083	15,953 m	HEA240	S 355	GSN-SNJIJEG	0,71 -
--------------	----------	--------	-------	-------------	--------

Partial safety factors	
Gamma M0 for resistance of cross-sections	1,00
Gamma M1 for resistance to instability	1,00
Gamma M2 for resistance of net sections	1,25

Material		
Yield strength f_y	355,0	MPa
Ultimate strength f_u	490,0	MPa
Fabrication	Rolled	

.....SECTION CHECK:.....

The critical check is on position 10.938 m

Internal forces	Calculated	Unit
N,Ed	-471,59	kN
Vy,Ed	0,21	kN
Vz,Ed	-19,73	kN
T,Ed	0,00	kNm
My,Ed	6,92	kNm
Mz,Ed	-0,10	kNm

Classification for cross-section design

According to EN 1993-1-1 article 5.5.2

Classification of Internal Compression parts

According to EN 1993-1-1 Table 5.2 Sheet 1

Maximum width-to-thickness ratio	21,87
Class 1 Limit	26,85
Class 2 Limit	30,92
Class 3 Limit	36,75

=> Internal Compression parts Class 1

Classification of Outstand Flanges

According to EN 1993-1-1 Table 5.2 Sheet 2

Maximum width-to-thickness ratio	7,94
Class 1 Limit	7,32
Class 2 Limit	8,14
Class 3 Limit	11,21

=> Outstand Flanges Class 2

=> Section classified as Class 2 for cross-section design

Compression check

According to EN 1993-1-1 article 6.2.4 and formula (6.9)

A	7,6800e-03	m ²
Nc,Rd	2726,40	kN
Unity check	0,17	-

Bending moment check for My

According to EN 1993-1-1 article 6.2.5 and formula (6.12),(6.13)

Wpl,y	7,4583e-04	m ³
Mpl,y,Rd	264,77	kNm
Unity check	0,03	-

Bending moment check for Mz

According to EN 1993-1-1 article 6.2.5 and formula (6.12),(6.13)

Wpl,z	3,5167e-04	m ³
Mpl,z,Rd	124,84	kNm
Unity check	0,00	-

Shear check for Vy

According to EN 1993-1-1 article 6.2.6 and formula (6.17)

Eta	1,20	
Av	5,9737e-03	m ²
Vpl,y,Rd	1224,38	kN
Unity check	0,00	-

Shear check for Vz

According to EN 1993-1-1 article 6.2.6 and formula (6.17)

Eta	1,20	
Av	2,5140e-03	m ²
Vpl,z,Rd	515,27	kN
Unity check	0,04	-

Unity check	0,00	-
-------------	------	---

Note: The unity check for torsion is lower than the limit value of 0,05. Therefore torsion is considered as insignificant and is ignored in the combined checks.

Combined bending, axial force and shear force check
According to EN 1993-1-1 article 6.2.9.1 and formula (6.41)

MN _y ,Rd	250,25	kNm
Alpha	2,00	
Mpl,z,Rd	124,84	kNm
Beta	1,00	

Unity check (6.41) = 0,00 + 0,00 = 0,00 -

Note: Since the shear forces are less than half the plastic shear resistances their effect on the moment resistances is neglected.

Note: Since the axial force satisfies criteria (6.35) of EN 1993-1-1 article 6.2.9.1(4) its effect on the moment resistance about the z-z axis is neglected.

The member satisfies the section check.

.....**STABILITY CHECK:**.....

Classification for member buckling design

Decisive position for stability classification: 8,203 m

Classification of Internal Compression parts

According to EN 1993-1-1 Table 5.2 Sheet 1

Maximum width-to-thickness ratio	21,87
Class 1 Limit	26,85
Class 2 Limit	30,92
Class 3 Limit	37,27

=> Internal Compression parts Class 1

Classification of Outstand Flanges

According to EN 1993-1-1 Table 5.2 Sheet 2

Maximum width-to-thickness ratio	7,94
Class 1 Limit	7,32
Class 2 Limit	8,14
Class 3 Limit	11,24

=> Outstand Flanges Class 2

=> Section classified as Class 2 for member buckling design

Flexural Buckling check

According to EN 1993-1-1 article 6.3.1.1 and formula (6.46)

Buckling parameters	yy	zz	
<small>*Student version* *Student version* *Student version* *Student version* *Student version* *Student version*</small>			
Sway type	sway	non-sway	
System length L	1,367	7,749	m
Buckling factor k	1,00	1,00	
Buckling length Lcr	1,367	7,749	m
Critical Euler load Ncr	86039,88	956,04	kN
Slenderness Lambda	13,60	129,03	
Relative slenderness Lambda,rel	0,18	1,69	
Limit slenderness Lambda,rel,0	0,20	0,20	
Buckling curve	b	c	
Imperfection Alpha	0,34	0,49	
Reduction factor Chi	1,00	0,26	
Buckling resistance Nb,Rd	2726,40	710,32	kN

Flexural Buckling verification		
<small>*Student version* *Student version* *Student version* *Student version* *Student version* *Student version*</small>		
Cross-section area A	7,6800e-03	m ²
Buckling resistance Nb,Rd	710,32	kN
Unity check	0,66	-

Torsional(-Flexural) Buckling check

According to EN 1993-1-1 article 6.3.1.1 and formula (6.46)

Note: For this I-section the Torsional(-Flexural) buckling resistance is higher than the resistance for Flexural buckling. Therefore Torsional(-Flexural) buckling is not printed on the output.

Lateral Torsional Buckling check

According to EN 1993-1-1 article 6.3.2.1 & 6.3.2.3 and formula (6.54)

LTB parameters		
<small>*Student version* *Student version* *Student version* *Student version* *Student version* *Student version*</small>		
Method for LTB curve	Alternative case	
Cross-section plastic modulus Wpl,y	7,4583e-04	m ³
Elastic critical moment Mcr	255,24	kNm
Relative slenderness Lambda,rel,LT	1,02	
Limit slenderness Lambda,rel,LT,0	0,40	

Note: The slenderness or bending moment is such that Lateral Torsional Buckling effects may be ignored according to EN 1993-1-1 article 6.3.2.2(4).

Mcr parameters		
<small>*Student version* *Student version* *Student version* *Student version* *Student version* *Student version*</small>		
LTB length L	7,749	m
<small>*Student version* *Student version* *Student version* *Student version* *Student version* *Student version*</small>		

Mcr parameters		
Influence of load position	no influence	
Correction factor k	1,00	
Correction factor kw	1,00	
LTB moment factor C1	1,23	
LTB moment factor C2	0,38	
LTB moment factor C3	0,53	
Shear center distance dz	0	mm
Distance of load application zg	0	mm
Mono-symmetry constant beta,y	0	mm
Mono-symmetry constant zj	0	mm

Note: C parameters are determined according to ECSS 119 2006 / Galea 2002.

Bending and axial compression check
According to EN 1993-1-1 article 6.3.3 and formula (6.61),(6.62)

Bending and axial compression check parameters		
Interaction method	alternative method 1	
Cross-section area A	7,6800e-03	m ²
Cross-section plastic modulus Wpl,y	7,4583e-04	m ³
Cross-section plastic modulus Wpl,z	3,5167e-04	m ³
Design compression force N,Ed	471,59	kN
Design bending moment (maximum) My,Ed	13,76	kNm
Design bending moment (maximum) Mz,Ed	-0,67	kNm
Characteristic compression resistance N,Rk	2726,40	kN
Characteristic moment resistance My,Rk	284,77	kNm
Characteristic moment resistance Mz,Rk	124,84	kNm
Reduction factor Chi,y	1,00	
Reduction factor Chi,z	0,26	
Modified reduction factor Chi,LT,mod	1,00	
Interaction factor kyy	1,66	
Interaction factor kyz	0,80	
Interaction factor kzy	0,77	
Interaction factor kzz	0,64	

Maximum moment My,Ed is derived from beam B1083 position 10,254 m.
Maximum moment Mz,Ed is derived from beam B1083 position 8,203 m.

Interaction method 1 parameters		
Critical Euler load Ncr,y	86039,88	kN
Critical Euler load Ncr,z	956,04	kN
Elastic critical load Ncr,T	3277,48	kN
Cross-section plastic modulus Wpl,y	7,4583e-04	m ³
Cross-section elastic modulus Wel,y	6,7500e-04	m ³
Cross-section plastic modulus Wpl,z	3,5167e-04	m ³
Cross-section elastic modulus Wel,z	2,3100e-04	m ³
Second moment of area Iy	7,7600e-05	m ⁴
Second moment of area Iz	2,7700e-05	m ⁴
Torsional constant It	4,1600e-07	m ⁴
Method for equivalent moment factor Cmy,0	Table A.2 Line 2 (General)	
Design bending moment (maximum) My,Ed	13,76	kNm
Maximum relative deflection delta,z	-0,2	mm
Equivalent moment factor Cmy,0	1,00	
Method for equivalent moment factor Cmz,0	Table A.2 Line 2 (General)	
Design bending moment (maximum) Mz,Ed	-0,67	kNm
Maximum relative deflection delta,y	0,1	mm
Equivalent moment factor Cmz,0	0,58	
Factor mu,y	1,00	
Factor mu,z	0,58	
Factor epsilon,y	0,33	
Factor a,LT	0,98	
Critical moment for uniform bending Mcr,0	207,27	kNm
Relative slenderness Lambda,rel,0	1,13	
Limit relative slenderness Lambda,rel,0,lim	0,18	
Equivalent moment factor Cmy	1,00	
Equivalent moment factor Cmy	0,58	
Equivalent moment factor CmLT	1,51	
Factor b,LT	0,00	
Factor c,LT	0,05	
Factor d,LT	0,00	
Factor e,LT	0,01	
Factor w,y	1,10	
Factor w,z	1,50	
Factor n,pl	0,17	
Maximum relative slenderness Lambda,rel,max	1,69	
Factor Cyy	0,92	
Factor Cyz	1,00	
Factor Czy	0,60	
Factor Cz z	1,03	

Unity check (6.61) = 0,17 + 0,09 + 0,00 = 0,26 -
Unity check (6.62) = 0,66 + 0,04 + 0,00 = 0,71 -

Shear Buckling check
According to EN 1993-1-5 article 5 & 7.1 and formula (5.10) & (7.1)

Shear Buckling parameters		
Buckling field length a	15,953	m
Web	unstiffened	
Web height hw	206	mm
Web thickness t	8	mm
Material coefficient epsilon	0,81	
Shear correction factor Eta	1,20	

Shear Buckling verification	
Web slenderness hw/t	27,47
Web slenderness limit	48,82

Note: The web slenderness is such that Shear Buckling effects may be ignored according to EN 1993-1-5 article 5.1(2).
The member satisfies the stability check.

7.2.2 Dimenzioniranje donjeg pojasa

Kritično opterećenje snijeg

- Kombinacija $1,35 \cdot (g + \Delta g) + 1,5 \cdot s$

Rezne sile

➤ M_y (kNm)

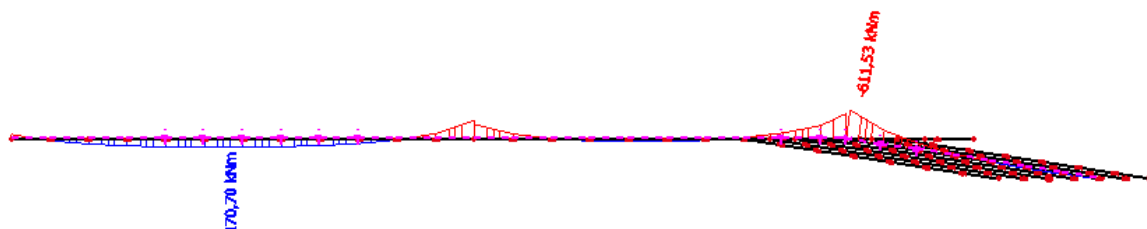

➤ V_z (kN)

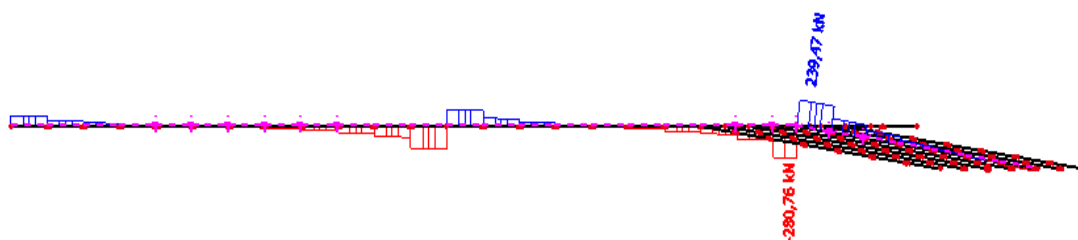

➤ N (kN)

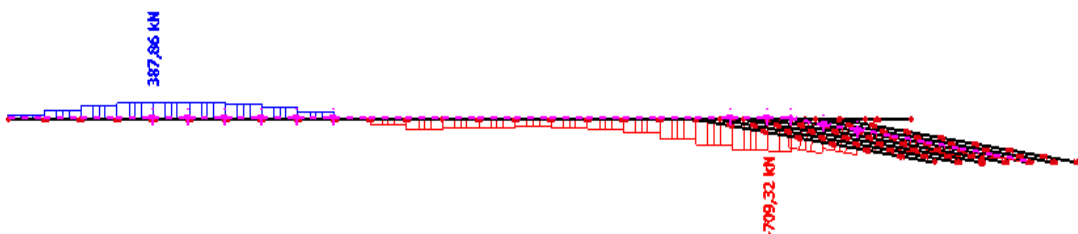

MATERIJAL

$f_y = 355 \text{ N/mm}^2$
 $f_u = 510 \text{ N/mm}^2$
 $\varepsilon = 0,814$
 $E = 210000 \text{ N/mm}^2$
 $G = 80777 \text{ N/mm}^2$
 $\nu = 0,3$

REZNE SILE

PARC. FAKTORI SIG.

$\gamma_{M0} = 1,1$
 $\gamma_{M1} = 1,1$
 $\gamma_{M2} = 1,25$

PARAMETRI

$A = 97,300 \text{ cm}^2$
 $A_y = 75,400 \text{ cm}^2$
 $A_z = 31,700 \text{ cm}^2$
 $I_y = 13670,000 \text{ cm}^4$
 $W_y = 1012,800 \text{ cm}^3$
 $W_{ply} = 1112,200 \text{ cm}^3$
 $i_y = 11,900 \text{ cm}$
 $I_z = 4762,600 \text{ cm}^4$
 $W_z = 340,200 \text{ cm}^3$
 $W_{plz} = 518,100 \text{ cm}^3$
 $i_z = 7,000 \text{ cm}$
 $I_t = 62,100 \text{ cm}^4$
 $I_{\omega} = 785366,600 \text{ cm}^6$

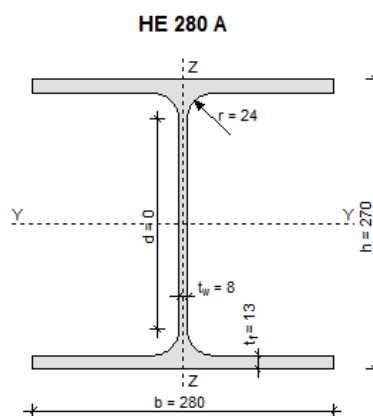

Member B1963	9,101 m	HEA280	S 355	GSN-SNJIJEG	0,94 -
--------------	---------	--------	-------	-------------	--------

Partial safety factors	
Gamma M0 for resistance of cross-sections	1,00
Gamma M1 for resistance to instability	1,00
Gamma M2 for resistance of net sections	1,25

Material		
Yield strength f_y	355,0	MPa
Ultimate strength f_u	490,0	MPa
Fabrication	Rolled	

.....SECTION CHECK:.....

The critical check is on position 1.300 m

Internal forces	Calculated	Unit
N,Ed	-974,99	kN
Vy,Ed	-0,32	kN
Vz,Ed	133,50	kN
T,Ed	-0,03	kNm
My,Ed	-30,39	kNm
Mz,Ed	-0,01	kNm

Classification for cross-section design

According to EN 1993-1-1 article 5.5.2

Classification of Internal Compression parts

According to EN 1993-1-1 Table 5.2 Sheet 1

Maximum width-to-thickness ratio	24,50
Class 1 Limit	26,85
Class 2 Limit	30,92
Class 3 Limit	38,73

=> Internal Compression parts Class 1

Classification of Outstand Flanges

According to EN 1993-1-1 Table 5.2 Sheet 2

Maximum width-to-thickness ratio	8,62
Class 1 Limit	7,32
Class 2 Limit	8,14
Class 3 Limit	11,20

=> Outstand Flanges Class 3

=> Section classified as Class 3 for cross-section design

Compression check

According to EN 1993-1-1 article 6.2.4 and formula (6.9)

A	9,7300e-03	m ²
Nc,Rd	3454,15	kN
Unity check	0,28	-

Bending moment check for My

According to EN 1993-1-1 article 6.2.5 and formula (6.12),(6.14)

W _{el,y,min}	1,0100e-03	m ³
M _{el,y,Rd}	358,55	kNm
Unity check	0,08	-

Bending moment check for Mz

According to EN 1993-1-1 article 6.2.5 and formula (6.12),(6.14)

W _{el,z,min}	3,4000e-04	m ³
M _{el,z,Rd}	120,70	kNm
Unity check	0,00	-

Shear check for Vy

According to EN 1993-1-1 article 6.2.6 and formula (6.17)

Eta	1,20	
Av	7,5360e-03	m ²
V _{pl,y,Rd}	1544,57	kN
Unity check	0,00	-

Shear check for Vz

According to EN 1993-1-1 article 6.2.6 and formula (6.17)

Eta	1,20	
Av	3,1780e-03	m ²
V _{pl,z,Rd}	651,36	kN
Unity check	0,20	-

Unity check	0,00	-
-------------	------	---

Note: The unity check for torsion is lower than the limit value of 0,05. Therefore torsion is considered as insignificant and is ignored in the combined checks.

Combined bending, axial force and shear force check
According to EN 1993-1-1 article 6.2.9.2 and formula (6.42)

Normal stresses		
Fibre	1	
Sigma.N,Ed	100,2	MPa
Sigma.My,Ed	29,9	MPa
Sigma.Mz,Ed	0,0	MPa
Sigma.tot,Ed	130,2	MPa
Unity check	0,37	-

The member satisfies the section check.

...:STABILITY CHECK:...

Classification for member buckling design
Decisive position for stability classification: 0,000 m
Classification of Internal Compression parts
According to EN 1993-1-1 Table 5.2 Sheet 1

Maximum width-to-thickness ratio	24,50
Class 1 Limit	32,40
Class 2 Limit	37,30
Class 3 Limit	56,20

=> Internal Compression parts Class 1

Classification of Outstand Flanges
According to EN 1993-1-1 Table 5.2 Sheet 2

Maximum width-to-thickness ratio	8,62
Class 1 Limit	7,32
Class 2 Limit	8,14
Class 3 Limit	11,21

=> Outstand Flanges Class 3

=> Section classified as Class 3 for member buckling design

Flexural Buckling check
According to EN 1993-1-1 article 6.3.1.1 and formula (6.46)

Buckling parameters	YY	ZZ	
Sway type	sway	non-sway	
System length L	1,300	2,600	m
Buckling factor k	1,00	1,00	
Buckling length Lcr	1,300	2,600	m
Critical Euler load Ncr	168016,87	14594,17	kN
Slenderness Lambda	10,96	37,17	
Relative slenderness Lambda,rel	0,14	0,49	
Limit slenderness Lambda,rel,0	0,20	0,20	
Buckling curve	b	c	
Imperfection Alpha	0,34	0,49	
Reduction factor Chi	1,00	0,85	
Buckling resistance Nb,Rd	3454,15	2937,79	kN

Flexural Buckling verification		
Cross-section area A	9,7300e-03	m ²
Buckling resistance Nb,Rd	2937,79	kN
Unity check	0,33	-

Torsional(-Flexural) Buckling check
According to EN 1993-1-1 article 6.3.1.1 and formula (6.46)
Note: For this I-section the Torsional(-Flexural) buckling resistance is higher than the resistance for Flexural buckling. Therefore Torsional(-Flexural) buckling is not printed on the output.

Lateral Torsional Buckling check
According to EN 1993-1-1 article 6.3.2.1 & 6.3.2.3 and formula (6.54)

LTB parameters		
Method for LTB curve	Alternative case	
Cross-section elastic modulus W _{el,y}	1,0100e-03	m ³
Elastic critical moment M _{cr}	5291,88	kNm
Relative slenderness Lambda,rel,LT	0,26	
Limit slenderness Lambda,rel,LT,0	0,40	

Note: The slenderness or bending moment is such that Lateral Torsional Buckling effects may be ignored according to EN 1993-1-1 article 6.3.2.2(4).

M _{cr} parameters		
LTB length L	2,600	m
Influence of load position	no influence	

Mcr parameters		
Correction factor k	1,00	
Correction factor kw	1,00	
LTB moment factor C1	2,57	
LTB moment factor C2	0,26	
LTB moment factor C3	1,00	
Shear center distance d,z	0	mm
Distance of load application z,g	0	mm
Mono-symmetry constant beta,y	0	mm
Mono-symmetry constant z,j	0	mm

Note: C parameters are determined according to ECSS 119 2006 / Galea 2002.

Bending and axial compression check

According to EN 1993-1-1 article 6.3.3 and formula (6.61),(6.62)

Bending and axial compression check parameters		
Interaction method	alternative method 1	
Cross-section area A	9,7300e-03	m ²
Cross-section elastic modulus Wel,y	1,0100e-03	m ³
Cross-section elastic modulus Wel,z	3,4000e-04	m ³
Design compression force N,Ed	974,99	kN
Design bending moment (maximum) My,Ed	-204,78	kNm
Design bending moment (maximum) Mz,Ed	-0,42	kNm
Characteristic compression resistance N,Rk	3454,15	kN
Characteristic moment resistance My,Rk	358,55	kNm
Characteristic moment resistance Mz,Rk	120,70	kNm
Reduction factor Chi,y	1,00	
Reduction factor Chi,z	0,85	
Modified reduction factor Chi,LT,mod	1,00	
Interaction factor k,y,y	1,07	
Interaction factor k,y,z	1,01	
Interaction factor k,z,y	1,06	
Interaction factor k,z,z	1,00	

Maximum moment My,Ed is derived from beam B1963 position 0,000 m.

Maximum moment Mz,Ed is derived from beam B1963 position 2,600 m.

Interaction method 1 parameters		
Critical Euler load N,cr,y	168016,87	kN
Critical Euler load N,cr,z	14594,17	kN
Elastic critical load N,cr,T	15335,62	kN
Cross-section elastic modulus Wel,y	1,0100e-03	m ³
Second moment of area Iy	1,3700e-04	m ⁴
Second moment of area Iz	4,7600e-05	m ⁴
Torsional constant It	6,2100e-07	m ⁴
Method for equivalent moment factor C,my,0	Table A.2 Line 2 (General)	
Design bending moment (maximum) My,Ed	-204,78	kNm
Maximum relative deflection delta,z	0,9	mm
Equivalent moment factor C,my,0	1,00	
Method for equivalent moment factor C,mz,0	Table A.2 Line 2 (General)	
Design bending moment (maximum) Mz,Ed	-0,42	kNm
Maximum relative deflection delta,y	0,0	mm
Equivalent moment factor C,mz,0	0,94	
Factor mu,y	1,00	
Factor mu,z	0,99	
Factor epsilon,y	2,02	
Factor a,LT	1,00	
Critical moment for uniform bending Mcr,0	2080,63	kNm
Relative slenderness Lambda,rel,0	0,42	
Limit relative slenderness Lambda,rel,0,lim	0,31	
Equivalent moment factor C,my	1,00	
Equivalent moment factor C,mz	0,94	
Equivalent moment factor C,mLT	1,06	

Unity check (6.61) = 0,28 + 0,61 + 0,00 = 0,90

Unity check (6.62) = 0,33 + 0,60 + 0,00 = 0,94

Shear Buckling check

According to EN 1993-1-5 article 5 & 7.1 and formula (5.10) & (7.1)

Shear Buckling parameters		
Buckling field length a	9,101	m
Web	unstiffened	
Web height hw	244	mm
Web thickness t	8	mm
Material coefficient epsilon	0,81	
Shear correction factor Eta	1,20	

Shear Buckling verification	
Web slenderness hw/t	30,50
Web slenderness limit	48,82

7.2.3 Dimenzioniranje ispune

Kritično opterećenje snijeg

- Kombinacija $1,35 \cdot (g + \Delta g) + 1,5 \cdot s$

Rezne sile

➤ N (kN)

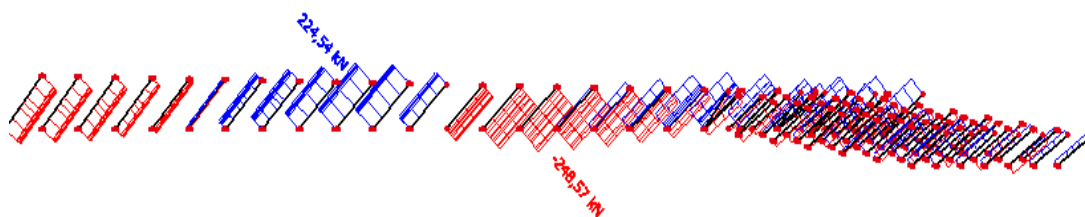

MATERIJAL

$$f_y = 355 \text{ N/mm}^2$$

$$f_u = 510 \text{ N/mm}^2$$

$$\varepsilon = 0,814$$

$$E = 210000 \text{ N/mm}^2$$

$$G = 80777 \text{ N/mm}^2$$

$$\nu = 0,3$$

REZNE SILE

PARC. FAKTORI SIG.

$$\gamma_{M0} = 1,1$$

$$\gamma_{M1} = 1,1$$

$$\gamma_{M2} = 1,25$$

PARAMETRI

$$A = 18,927 \text{ cm}^2$$

$$A_y = 4,000 \text{ cm}^2$$

$$A_z = 11,000 \text{ cm}^2$$

$$I_y = 452,364 \text{ cm}^4$$

$$W_y = 64,623 \text{ cm}^3$$

$$W_{ply} = 82,015 \text{ cm}^3$$

$$i_y = 4,889 \text{ cm}$$

$$I_z = 155,614 \text{ cm}^4$$

$$W_z = 44,461 \text{ cm}^3$$

$$W_{plz} = 50,771 \text{ cm}^3$$

$$i_z = 2,867 \text{ cm}$$

$$I_t = 914,667 \text{ cm}^4$$

$$I_\omega = 0,000 \text{ cm}^6$$

CFRHS 140x70x5

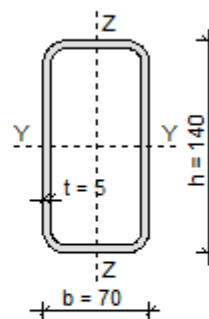

Member	B1233	1,925 m	CFRHS140X70X5	S 355	GSN-SNJIJEG	0,97 -
--------	-------	---------	---------------	-------	-------------	--------

Note: EN 1993-1-3 article 1.1(3) specifies that this part does not apply to cold formed CHS and RHS sections. The default EN 1993-1-1 code check is executed instead of the EN 1993-1-3 code check.

Partial safety factors	
Gamma M0 for resistance of cross-sections	1,00
Gamma M1 for resistance to instability	1,00
Gamma M2 for resistance of net sections	1,25

Material		
Yield strength fy	355,0	MPa
Ultimate strength fu	510,0	MPa
Fabrication	Cold formed	

....SECTION CHECK:....

The critical check is on position 0.000 m

Internal forces	Calculated	Unit
N,Ed	-408,99	kN
Vy,Ed	0,00	kN
Vz,Ed	0,00	kN
T,Ed	0,00	kNm
My,Ed	0,00	kNm
Mz,Ed	0,00	kNm

Classification for cross-section design

According to EN 1993-1-1 article 5.5.2

Classification of Internal Compression parts

According to EN 1993-1-1 Table 5.2 Sheet 1

Maximum width-to-thickness ratio	25,00
Class 1 Limit	26,85
Class 2 Limit	30,92
Class 3 Limit	34,17

=> Section classified as Class 1 for cross-section design

Compression check

According to EN 1993-1-1 article 6.2.4 and formula (6.9)

A	1,9360e-03	m ²
Nc,Rd	687,28	kN
Unity check	0,60	-

The member satisfies the section check.

....STABILITY CHECK:....

Classification for member buckling design

Decisive position for stability classification: 0,000 m

Classification of Internal Compression parts

According to EN 1993-1-1 Table 5.2 Sheet 1

Maximum width-to-thickness ratio	25,00
Class 1 Limit	26,85
Class 2 Limit	30,92
Class 3 Limit	34,17

=> Section classified as Class 1 for member buckling design

Flexural Buckling check

According to EN 1993-1-1 article 6.3.1.1 and formula (6.46)

Buckling parameters	yy		zz
	sway	non-sway	
Sway type	sway	non-sway	
System length L	1,925	1,925	m
Buckling factor k	1,00	1,00	
Buckling length Lcr	1,925	1,925	m
Critical Euler load Ncr	2636,60	887,53	kN
Slenderness Lambda	39,01	67,24	
Relative slenderness Lambda,rel	0,51	0,88	
Limit slenderness Lambda,rel,0	0,20	0,20	
Buckling curve	c	c	
Imperfection Alpha	0,49	0,49	
Reduction factor Chi	0,84	0,61	
Buckling resistance Nb,Rd	575,30	420,74	kN

Flexural Buckling verification

Cross-section area A	1,9360e-03	m ²
Buckling resistance Nb,Rd	420,74	kN
Unity check	0,97	-

Note: The cross-section concerns a RHS section which is not susceptible to Torsional(-Flexural) Buckling. The member satisfies the stability check.

7.2.4 Dimenzioniranje vertikala

Kritično opterećenje snijeg

- Kombinacija $1,35 \cdot (g + \Delta g) + 1,5 \cdot s$

Rezne sile

➤ $N \text{ (kN)} = 260,16 \text{ kN}$

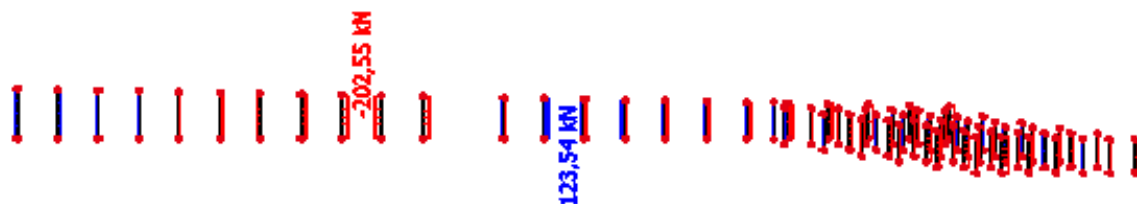

MATERIJAL

$f_y = 355 \text{ N/mm}^2$
 $f_u = 510 \text{ N/mm}^2$
 $\varepsilon = 0,814$
 $E = 210000 \text{ N/mm}^2$
 $G = 80777 \text{ N/mm}^2$
 $\nu = 0,3$

REZNE SILE

PARC. FAKTORI SIG.

$\gamma_{M0} = 1,1$
 $\gamma_{M1} = 1,1$
 $\gamma_{M2} = 1,25$

PARAMETRI

$A = 16,215 \text{ cm}^2$
 $A_y = 2,880 \text{ cm}^2$
 $A_z = 7,680 \text{ cm}^2$
 $I_y = 194,230 \text{ cm}^4$
 $W_y = 38,846 \text{ cm}^3$
 $W_{ply} = 49,392 \text{ cm}^3$
 $i_y = 3,461 \text{ cm}$
 $I_z = 90,259 \text{ cm}^4$
 $W_z = 30,086 \text{ cm}^3$
 $W_{plz} = 34,722 \text{ cm}^3$
 $i_z = 2,359 \text{ cm}$
 $I_t = 450,000 \text{ cm}^4$
 $I_\omega = 0,000 \text{ cm}^6$

CFRHS 100x60x6

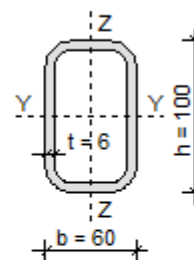

Member B1220	1,430 m	CFRHS100X60X6	S 355	GSN-SNJIJEG	0,85 -
--------------	---------	---------------	-------	-------------	--------

Note: EN 1993-1-3 article 1.1(3) specifies that this part does not apply to cold formed CHS and RHS sections. The default EN 1993-1-1 code check is executed instead of the EN 1993-1-3 code check.

Partial safety factors	
Gamma M0 for resistance of cross-sections	1,00
Gamma M1 for resistance to instability	1,00
Gamma M2 for resistance of net sections	1,25

Material		
Yield strength fy	355,0	MPa
Ultimate strength fu	510,0	MPa
Fabrication	Cold formed	

....SECTION CHECK:....

The critical check is on position 0.000 m

Internal forces	Calculated	Unit
N,Ed	-334,18	kN
Vy,Ed	0,00	kN
Vz,Ed	0,00	kN
T,Ed	0,00	kNm
My,Ed	0,00	kNm
Mz,Ed	0,00	kNm

Classification for cross-section design
According to EN 1993-1-1 article 5.5.2
Classification of Internal Compression parts
According to EN 1993-1-1 Table 5.2 Sheet 1

Maximum width-to-thickness ratio	13,67
Class 1 Limit	26,85
Class 2 Limit	30,92
Class 3 Limit	34,17

=> Section classified as Class 1 for cross-section design

Compression check
According to EN 1993-1-1 article 6.2.4 and formula (6.9)

A	1,6830e-03	m ²
Nc,Rd	597,47	kN
Unity check	0,56	-

The member satisfies the section check.

....STABILITY CHECK:....

Classification for member buckling design
Decisive position for stability classification: 0,000 m
Classification of Internal Compression parts
According to EN 1993-1-1 Table 5.2 Sheet 1

Maximum width-to-thickness ratio	13,67
Class 1 Limit	26,85
Class 2 Limit	30,92
Class 3 Limit	34,17

=> Section classified as Class 1 for member buckling design

Flexural Buckling check
According to EN 1993-1-1 article 6.3.1.1 and formula (6.46)

Buckling parameters	yy	zz	
Sway type	sway	non-sway	
System length L	1,430	1,430	m
Buckling factor k	1,00	1,00	
Buckling length Lcr	1,430	1,430	m
Critical Euler load Ncr	2080,13	924,05	kN
Slenderness Lambda	40,95	61,44	
Relative slenderness Lambda,rel	0,54	0,80	
Limit slenderness Lambda,rel,0	0,20	0,20	
Buckling curve	c	c	
Imperfection Alpha	0,49	0,49	
Reduction factor Chi	0,82	0,66	
Buckling resistance Nb,Rd	491,52	394,08	kN

Flexural Buckling verification		
Cross-section area A	1,6830e-03	m ²
Buckling resistance Nb,Rd	394,08	kN
Unity check	0,85	-

Torsional/Flexural Buckling check

7.2.5 Dimenzioniranje vertikala iznad stupa

Kritično opterećenje snijeg

- Kombinacija $1,35 \cdot (g+\Delta g)+1,5 \cdot s$

Rezne sile

➤ $N \text{ (kN)} = -213,61 \text{ kN}$

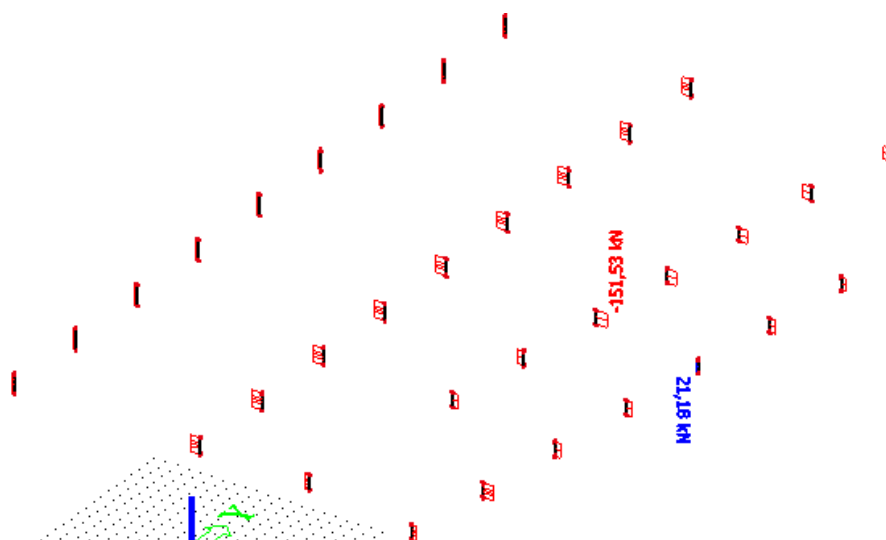

MATERIJAL

$$f_y = 355 \text{ N/mm}^2$$

$$f_u = 510 \text{ N/mm}^2$$

$$\varepsilon = 0,814$$

$$E = 210000 \text{ N/mm}^2$$

$$G = 80777 \text{ N/mm}^2$$

$$\nu = 0,3$$

REZNE SILE

PARC. FAKTORI SIG.

$$\gamma_{M0} = 1,1$$

$$\gamma_{M1} = 1,1$$

$$\gamma_{M2} = 1,25$$

PARAMETRI

$$A = 17,927 \text{ cm}^2$$

$$A_y = 7,000 \text{ cm}^2$$

$$A_z = 7,000 \text{ cm}^2$$

$$I_y = 262,429 \text{ cm}^4$$

$$W_y = 52,486 \text{ cm}^3$$

$$W_{ply} = 62,411 \text{ cm}^3$$

$$i_y = 3,826 \text{ cm}$$

$$I_z = 262,429 \text{ cm}^4$$

$$W_z = 52,486 \text{ cm}^3$$

$$W_{plz} = 62,411 \text{ cm}^3$$

$$i_z = 3,826 \text{ cm}$$

$$I_t = 1000,000 \text{ cm}^4$$

$$I_\omega = 0,000 \text{ cm}^6$$

CFRHS 100x100x5

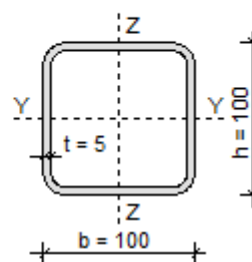

Member B1886	1,165 m	CFRHS100X100X5	S 355	GSN-SNJJEG	0,75 -
--------------	---------	----------------	-------	------------	--------

Note: EN 1993-1-3 article 1.1(3) specifies that this part does not apply to cold formed CHS and RHS sections. The default EN 1993-1-1 code check is executed instead of the EN 1993-1-3 code check.

Partial safety factors	
Gamma M0 for resistance of cross-sections	1,00
Gamma M1 for resistance to instability	1,00
Gamma M2 for resistance of net sections	1,25

Material		
Yield strength f_y	355,0	MPa
Ultimate strength f_u	510,0	MPa
Fabrication	Cold formed	

....SECTION CHECK:....

The critical check is on position 0.000 m

Internal forces	Calculated	Unit
N,Ed	-441,66	kN
Vy,Ed	0,00	kN
Vz,Ed	0,00	kN
T,Ed	0,00	kNm
My,Ed	0,00	kNm
Mz,Ed	0,00	kNm

Classification for cross-section design

According to EN 1993-1-1 article 5.5.2

Classification of Internal Compression parts

According to EN 1993-1-1 Table 5.2 Sheet 1

Maximum width-to-thickness ratio	17,00
Class 1 Limit	26,85
Class 2 Limit	30,92
Class 3 Limit	34,17

=> Section classified as Class 1 for cross-section design

Compression check

According to EN 1993-1-1 article 6.2.4 and formula (6.9)

A	1,8360e-03	m ²
Nc,Rd	651,78	kN
Unity check	0,68	-

The member satisfies the section check.

....STABILITY CHECK:....

Classification for member buckling design

Decisive position for stability classification: 0.000 m

Classification of Internal Compression parts

According to EN 1993-1-1 Table 5.2 Sheet 1

Maximum width-to-thickness ratio	17,00
Class 1 Limit	26,85
Class 2 Limit	30,92
Class 3 Limit	34,17

=> Section classified as Class 1 for member buckling design

Flexural Buckling check

According to EN 1993-1-1 article 6.3.1.1 and formula (6.46)

Buckling parameters	yy	zz	
Sway type	sway	non-sway	
System length L	1,165	1,165	m
Buckling factor k	1,00	1,00	
Buckling length Lcr	1,165	1,165	m
Critical Euler load Ncr	4136,66	4136,66	kN
Slenderness Lambda	30,33	30,33	
Relative slenderness Lambda,rel	0,40	0,40	
Limit slenderness Lambda,rel,0	0,20	0,20	
Buckling curve	c	c	
Imperfection Alpha	0,49	0,49	
Reduction factor Chi	0,90	0,90	
Buckling resistance Nb,Rd	585,91	585,91	kN

Flexural Buckling verification		
Cross-section area A	1,8360e-03	m ²
Buckling resistance Nb,Rd	585,91	kN
Unity check	0,75	-

7.3 Dimenzioniranje poprečne rešetke 1

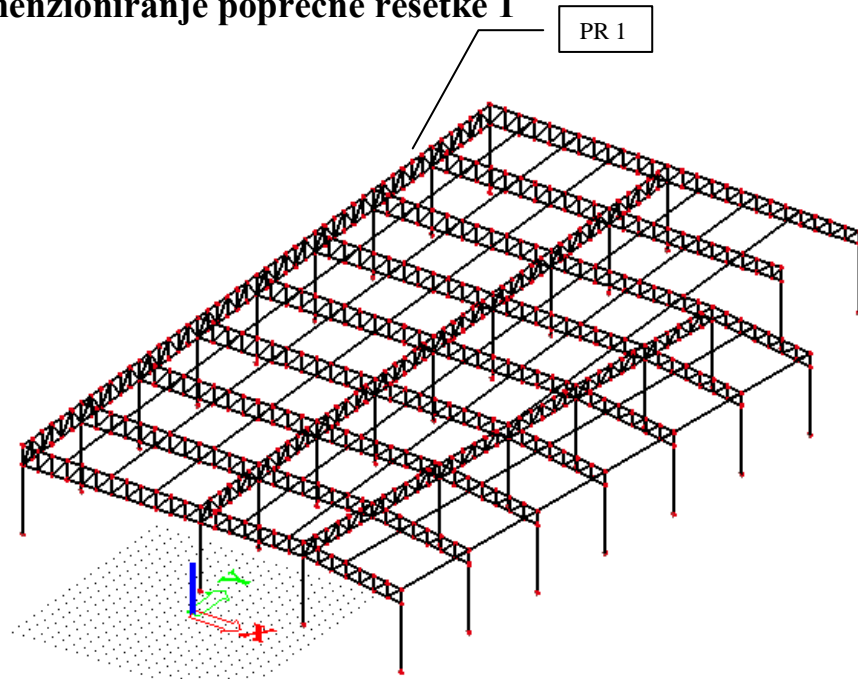

Slika 12: Prikaz položaja poprečne rešetke

7.3.1 Dimenzioniranje gornjeg pojasa

Kritično opterećenje snijeg

- Kombinacija $1,35 \cdot (g + \Delta g) + 1,5 \cdot s$

Rezne sile

➤ M_y (kNm) = 3,95 kNm

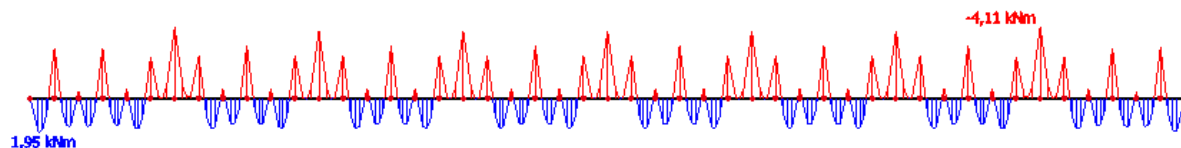

➤ V_z (kN) = 11,78 kN

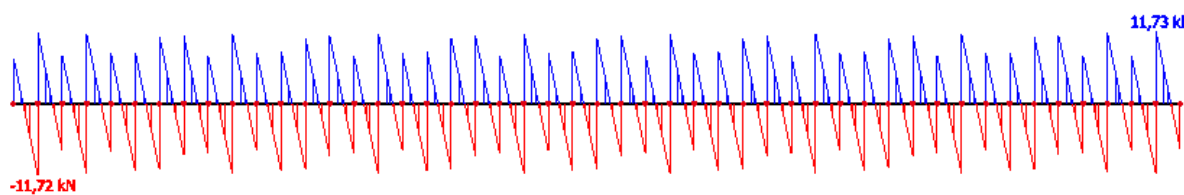

➤ N (kN) = 42,76 kN

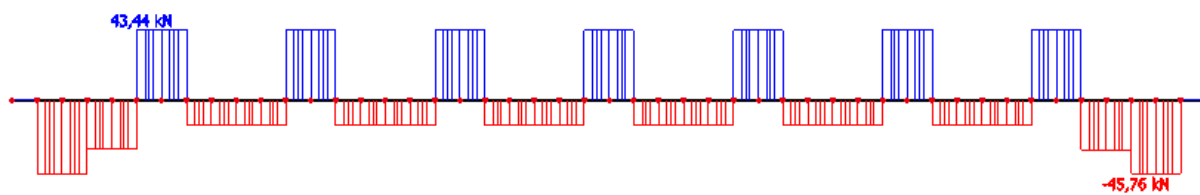

Member B1064	8,100 m	HEA120	S 355	GSN-SNJJEG	0,77 -
--------------	---------	--------	-------	------------	--------

Partial safety factors	
Gamma M0 for resistance of cross-sections	1,00
Gamma M1 for resistance to instability	1,00
Gamma M2 for resistance of net sections	1,25

Material		
Yield strength f_y	355,0	MPa
Ultimate strength f_u	490,0	MPa
Fabrication	Rolled	

....SECTION CHECK:....

The critical check is on position 6.750 m

Internal forces	Calculated	Unit
N,Ed	-45,76	kN
Vy,Ed	-0,01	kN
Vz,Ed	-11,36	kN
T,Ed	0,00	kNm
My,Ed	-2,90	kNm
Mz,Ed	-0,03	kNm

Classification for cross-section design

According to EN 1993-1-1 article 5.5.2

Classification of Internal Compression parts

According to EN 1993-1-1 Table 5.2 Sheet 1

Maximum width-to-thickness ratio	14,80
Class 1 Limit	26,85
Class 2 Limit	30,92
Class 3 Limit	50,72

=> Internal Compression parts Class 1

Classification of Outstand Flanges

According to EN 1993-1-1 Table 5.2 Sheet 2

Maximum width-to-thickness ratio	5,69
Class 1 Limit	7,32
Class 2 Limit	8,14
Class 3 Limit	11,22

=> Outstand Flanges Class 1

=> Section classified as Class 1 for cross-section design

Compression check

According to EN 1993-1-1 article 6.2.4 and formula (6.9)

A	2,5300e-03	m ²
Nc,Rd	898,15	kN
Unity check	0,05	-

Bending moment check for My

According to EN 1993-1-1 article 6.2.5 and formula (6.12),(6.13)

Wpl,y	1,1958e-04	m ³
Mpl,y,Rd	42,45	kNm
Unity check	0,07	-

Bending moment check for Mz

According to EN 1993-1-1 article 6.2.5 and formula (6.12),(6.13)

Wpl,z	5,8750e-05	m ³
Mpl,z,Rd	20,86	kNm
Unity check	0,00	-

Shear check for Vy

According to EN 1993-1-1 article 6.2.6 and formula (6.17)

Eta	1,20	
Av	2,0050e-03	m ²
Vpl,y,Rd	410,94	kN
Unity check	0,00	-

Shear check for Vz

According to EN 1993-1-1 article 6.2.6 and formula (6.17)

Eta	1,20	
Av	8,4200e-04	m ²
Vpl,z,Rd	172,58	kN
Unity check	0,07	-

Unity check	0,00	-
-------------	------	---

Note: The unity check for torsion is lower than the limit value of 0,05. Therefore torsion is considered as insignificant and is ignored in the combined checks.

Combined bending, axial force and shear force check
According to EN 1993-1-1 article 6.2.9.1 and formula (6.41)

Mpl,y,Rd	42,45	kNm
Alpha	2,00	
Mpl,z,Rd	20,86	kNm
Beta	1,00	

Unity check (6.41) = 0,00 + 0,00 = 0,01 -

Note: Since the shear forces are less than half the plastic shear resistances their effect on the moment resistances is neglected.

Note: Since the axial force satisfies both criteria (6.33) and (6.34) of EN 1993-1-1 article 6.2.9.1(4) its effect on the moment resistance about the y-y axis is neglected.

Note: Since the axial force satisfies criteria (6.35) of EN 1993-1-1 article 6.2.9.1(4) its effect on the moment resistance about the z-z axis is neglected.

The member satisfies the section check.

.....**STABILITY CHECK**.....

Classification for member buckling design

Decisive position for stability classification: 0,000 m

Classification of Internal Compression parts

According to EN 1993-1-1 Table 5.2 Sheet 1

Maximum width-to-thickness ratio	14,80
Class 1 Limit	186,11
Class 2 Limit	214,54
Class 3 Limit	741,62

=> Internal Compression parts Class 1

Classification of Outstand Flanges

According to EN 1993-1-1 Table 5.2 Sheet 2

Maximum width-to-thickness ratio	5,69
Class 1 Limit	7,32
Class 2 Limit	8,14
Class 3 Limit	11,31

=> Outstand Flanges Class 1

=> Section classified as Class 1 for member buckling design

Flexural Buckling check

According to EN 1993-1-1 article 6.3.1.1 and formula (6.46)

Buckling parameters	yy	zz	
Sway type	sway	non-sway	
System length L	1,350	8,100	m
Buckling factor k	1,00	1,00	
Buckling length Lcr	1,350	8,100	m
Critical Euler load Ncr	6891,66	72,97	kN
Slenderness Lambda	27,58	268,06	
Relative slenderness Lambda,rel	0,36	3,51	
Limit slenderness Lambda,rel,0	0,20	0,20	
Buckling curve	b	c	
Imperfection Alpha	0,34	0,49	
Reduction factor Chi	0,94	0,07	
Buckling resistance Nb,Rd	845,40	63,91	kN

Flexural Buckling verification		
Cross-section area A	2,5300e-03	m ²
Buckling resistance Nb,Rd	63,91	kN
Unity check	0,72	

Torsional(-Flexural) Buckling check

According to EN 1993-1-1 article 6.3.1.1 and formula (6.46)

Note: For this I-section the Torsional(-Flexural) buckling resistance is higher than the resistance for Flexural buckling. Therefore Torsional(-Flexural) buckling is not printed on the output.

Lateral Torsional Buckling check

According to EN 1993-1-1 article 6.3.2.1 & 6.3.2.3 and formula (6.54)

LTB parameters		
Method for LTB curve	Alternative case	
Cross-section plastic modulus Wpl,y	1,1958e-04	m ³
Elastic critical moment Mcr	44,42	kNm
Relative slenderness Lambda,rel,LT	0,98	
Limit slenderness Lambda,rel,LT,0	0,40	

Note: The slenderness or bending moment is such that Lateral Torsional Buckling effects may be ignored according to EN 1993-1-1 article 6.3.2.2(4).

Mcr parameters		
LTB length L	8,100	m
Influence of load position	no influence	
Correction factor k	1,00	
Correction factor kw	1,00	
LTB moment factor C1	2,32	
LTB moment factor C2	0,88	
LTB moment factor C3	0,41	
Shear center distance d,z	0	mm
Distance of load application z,g	0	mm
Mono-symmetry constant beta,y	0	mm
Mono-symmetry constant z,j	0	mm

Note: C parameters are determined according to ECCS 119 2006 / Galea 2002.

Bending and axial compression check

According to EN 1993-1-1 article 6.3.3 and formula (6.61),(6.62)

Bending and axial compression check parameters		
Interaction method	alternative method 1	
Cross-section area A	2,5300e-03	m ²
Cross-section plastic modulus Wpl,y	1,1958e-04	m ³
Cross-section plastic modulus Wpl,z	5,8750e-05	m ³
Design compression force N,Ed	45,76	kN
Design bending moment (maximum) My,Ed	-2,90	kNm
Design bending moment (maximum) Mz,Ed	0,04	kNm
Characteristic compression resistance N,Rk	898,15	kN
Characteristic moment resistance My,Rk	42,45	kNm
Characteristic moment resistance Mz,Rk	20,86	kNm
Reduction factor Chi,y	0,94	
Reduction factor Chi,z	0,07	
Modified reduction factor Chi,LT,mod	1,00	
Interaction factor k,yy	1,86	
Interaction factor k,yz	0,61	
Interaction factor k,zy	0,73	
Interaction factor k,zz	0,34	

Maximum moment My,Ed is derived from beam B1064 position 6,750 m.

Maximum moment Mz,Ed is derived from beam B1064 position 0,000 m.

Interaction method 1 parameters		
Critical Euler load N,cr,y	6891,66	kN
Critical Euler load N,cr,z	72,97	kN
Elastic critical load N,cr,T	1524,20	kN
Cross-section plastic modulus Wpl,y	1,1958e-04	m ³
Cross-section elastic modulus Wel,y	1,0600e-04	m ³
Cross-section plastic modulus Wpl,z	5,8750e-05	m ³
Cross-section elastic modulus Wel,z	3,8500e-05	m ³
Second moment of area Iy	6,0600e-06	m ⁴
Second moment of area Iz	2,3100e-06	m ⁴
Torsional constant It	5,9900e-08	m ⁴
Method for equivalent moment factor C,my,0	Table A.2 Line 2 (General)	
Design bending moment (maximum) My,Ed	-2,90	kNm
Maximum relative deflection delta,z	-0,2	mm
Equivalent moment factor C,my,0	1,00	
Method for equivalent moment factor C,mz,0	Table A.2 Line 1 (Linear)	
Ratio of end moments Psi,z	-0,89	
Equivalent moment factor C,mz,0	0,33	
Factor mu,y	1,00	
Factor mu,z	0,39	
Factor epsilon,y	1,51	
Factor a,LT	0,99	
Critical moment for uniform bending Mcr,0	19,18	kNm
Relative slenderness Lambda,rel,0	1,49	
Limit relative slenderness Lambda,rel,0,lim	0,24	
Equivalent moment factor C,my	1,00	
Equivalent moment factor C,mz	0,33	
Equivalent moment factor C,mLT	1,64	
Factor b,LT	0,00	
Factor c,LT	0,01	
Factor d,LT	0,00	
Factor e,LT	0,00	
Factor w,y	1,13	
Factor w,z	1,50	
Factor n,pl	0,05	
Maximum relative slenderness Lambda,rel,max	3,51	
Factor C,yy	0,89	
Factor C,yz	0,98	
Factor C,zy	0,46	
Factor C,zz	1,01	

Unity check (6.61) = 0,05 + 0,13 + 0,00 = 0,18 -

Unity check (6.62) = 0,72 + 0,05 + 0,00 = 0,77 -

Shear Buckling check

According to EN 1993-1-5 article 5 & 7.1 and formula (5.10) & (7.1)

Shear Buckling parameters		
Buckling field length a	8,100	m
Web	unstiffened	
Web height hw	98	mm
Web thickness t	5	mm
Material coefficient epsilon	0,81	
Shear correction factor Eta	1,20	

Shear Buckling verification	
Web slenderness hw/t	19,60
Web slenderness limit	48,82

Note: The web slenderness is such that Shear Buckling effects may be ignored according to EN 1993-1-5 article 5.1(2).
The member satisfies the stability check.

Proračunski profil gornjeg pojasa poprečne rešetke je HEA 120 sa iskoristivosti 77% na mjerodavnu kombinaciju GSN Snijeg. Profil je povećan na HEA 180 zbog izvedbe spojeva i predviđene reklame duž cijelog objekta koja se oslanja na Poprečnu rešetku 1, a njen utjecaj nije uzet u obzir ovim proračunom.

MATERIJAL

$f_y = 355 \text{ N/mm}^2$
 $f_u = 510 \text{ N/mm}^2$
 $\epsilon = 0,814$
 $E = 210000 \text{ N/mm}^2$
 $G = 80777 \text{ N/mm}^2$
 $\nu = 0.3$

PARAMETRI

$A = 45,300 \text{ cm}^2$
 $A_y = 35,500 \text{ cm}^2$
 $A_z = 14,500 \text{ cm}^2$
 $I_y = 2510,300 \text{ cm}^4$
 $W_y = 293,600 \text{ cm}^3$
 $W_{ply} = 324,900 \text{ cm}^3$
 $i_y = 7,400 \text{ cm}$
 $I_z = 924,600 \text{ cm}^4$
 $W_z = 102,700 \text{ cm}^3$
 $W_{plz} = 156,500 \text{ cm}^3$
 $i_z = 4,500 \text{ cm}$
 $I_t = 14,800 \text{ cm}^4$
 $I_\omega = 60210,900 \text{ cm}^6$

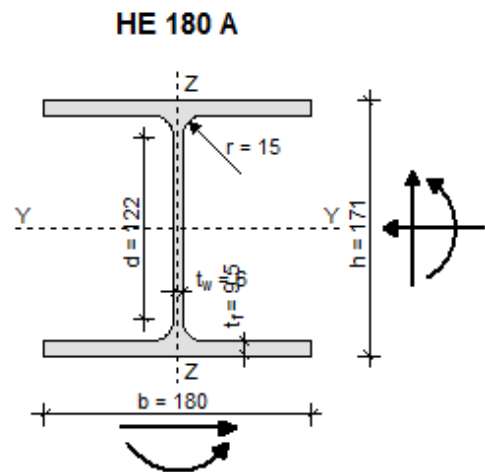

7.3.2 Dimenzioniranje donjeg pojasa

Kritično opterećenje snijeg

- Kombinacija $1,35 \cdot (g+\Delta g)+1,5 \cdot s$

Rezne sile

➤ M_y (kNm) = 2,36 kNm

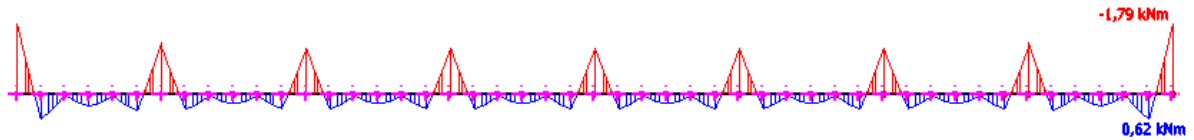

➤ V_z (kN) = 2,46 kNm

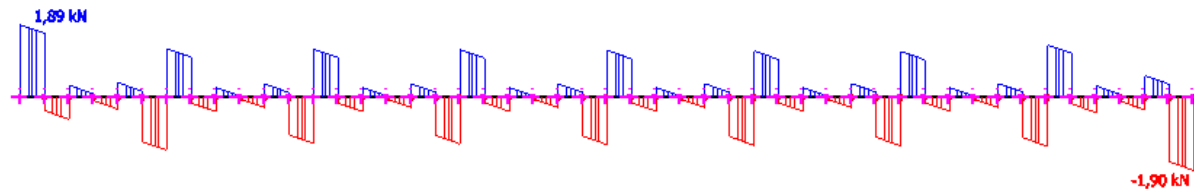

➤ N (kN) = +47,05 kNm; N (kN) = -7,64 kNm

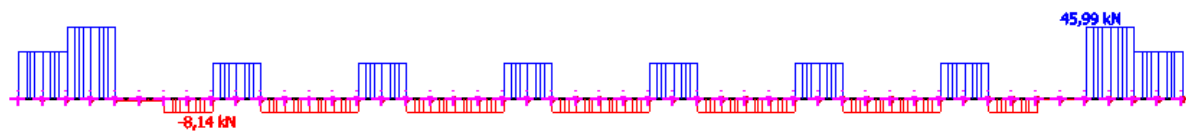

Member B887	8,100 m	HEA100A	S 355	GSN-SNJJEG	0,35 -
-------------	---------	---------	-------	------------	--------

Partial safety factors	
Gamma M0 for resistance of cross-sections	1,00
Gamma M1 for resistance to instability	1,00
Gamma M2 for resistance of net sections	1,25

Material		
Yield strength f_y	355,0	MPa
Ultimate strength f_u	490,0	MPa
Fabrication	Rolled	

....SECTION CHECK:....

The critical check is on position 0.000 m

Internal forces	Calculated	Unit
N,Ed	-8,14	kN
V _y ,Ed	0,01	kN
V _z ,Ed	1,27	kN
T,Ed	0,00	kNm
M _y ,Ed	-1,20	kNm
M _z ,Ed	-0,05	kNm

Classification for cross-section design

According to EN 1993-1-1 article 5.5.2

Classification of Internal Compression parts

According to EN 1993-1-1 Table 5.2 Sheet 1

Maximum width-to-thickness ratio	13,33
Class 1 Limit	52,53
Class 2 Limit	60,49
Class 3 Limit	66,03

=> Internal Compression parts Class 1

Classification of Outstand Flanges

According to EN 1993-1-1 Table 5.2 Sheet 2

Maximum width-to-thickness ratio	6,53
Class 1 Limit	7,32
Class 2 Limit	8,14
Class 3 Limit	11,29

=> Outstand Flanges Class 1

=> Section classified as Class 1 for cross-section design

Compression check

According to EN 1993-1-1 article 6.2.4 and formula (6.9)

A	1,5600e-03	m ²
N _{c,Rd}	553,80	kN
Unity check	0,01	-

Bending moment check for M_y

According to EN 1993-1-1 article 6.2.5 and formula (6.12),(6.13)

W _{pl,y}	5,8333e-05	m ³
M _{pl,y,Rd}	20,71	kNm
Unity check	0,06	-

Bending moment check for M_z

According to EN 1993-1-1 article 6.2.5 and formula (6.12),(6.13)

W _{pl,z}	2,8458e-05	m ³
M _{pl,z,Rd}	10,10	kNm
Unity check	0,00	-

Shear check for V_y

According to EN 1993-1-1 article 6.2.6 and formula (6.17)

Eta	1,20	
A _v	1,1680e-03	m ²
V _{pl,y,Rd}	239,40	kN
Unity check	0,00	-

Shear check for V_z

According to EN 1993-1-1 article 6.2.6 and formula (6.17)

Eta	1,20	
A _v	6,1510e-04	m ²
V _{pl,z,Rd}	126,07	kN
Unity check	0,01	-

Unity check	0,00	-
-------------	------	---

Note: The unity check for torsion is lower than the limit value of 0,05. Therefore torsion is considered as insignificant and is ignored in the combined checks.

Combined bending, axial force and shear force check
According to EN 1993-1-1 article 6.2.9.1 and formula (6.41)

Mpl,y,Rd	20,71	kNm
Alpha	2,00	
Mpl,z,Rd	10,10	kNm
Beta	1,00	

Unity check (6.41) = $0,00 + 0,00 = 0,01$ -

Note: Since the shear forces are less than half the plastic shear resistances their effect on the moment resistances is neglected.

Note: Since the axial force satisfies both criteria (6.33) and (6.34) of EN 1993-1-1 article 6.2.9.1(4) its effect on the moment resistance about the y-y axis is neglected.

Note: Since the axial force satisfies criteria (6.35) of EN 1993-1-1 article 6.2.9.1(4) its effect on the moment resistance about the z-z axis is neglected.

The member satisfies the section check.

.....**STABILITY CHECK:**.....

Classification for member buckling design

Decisive position for stability classification: 0,000 m

Classification of Internal Compression parts

According to EN 1993-1-1 Table 5.2 Sheet 1

Maximum width-to-thickness ratio	13,33
Class 1 Limit	52,53
Class 2 Limit	60,49
Class 3 Limit	66,03

=> Internal Compression parts Class 1

Classification of Outstand Flanges

According to EN 1993-1-1 Table 5.2 Sheet 2

Maximum width-to-thickness ratio	6,53
Class 1 Limit	7,32
Class 2 Limit	8,14
Class 3 Limit	11,29

=> Outstand Flanges Class 1

=> Section classified as Class 1 for member buckling design

Flexural Buckling check

According to EN 1993-1-1 article 6.3.1.1 and formula (6.46)

Buckling parameters	yy	zz	
Sway type	sway	non-sway	
System length L	1,350	8,100	m
Buckling factor k	1,00	1,00	
Buckling length Lcr	1,350	8,100	m
Critical Euler load Ncr	2695,25	29,08	kN
Slenderness Lambda	34,64	333,44	
Relative slenderness Lambda,rel	0,45	4,36	
Limit slenderness Lambda,rel,0	0,20	0,20	
Buckling curve	b	c	
Imperfection Alpha	0,34	0,49	
Reduction factor Chi	0,90	0,05	
Buckling resistance Nb,Rd	500,83	26,14	kN

Flexural Buckling verification		
Cross-section area A	1,5600e-03	m^2
Buckling resistance Nb,Rd	26,14	kN
Unity check	0,31	

Torsional(-Flexural) Buckling check

According to EN 1993-1-1 article 6.3.1.1 and formula (6.46)

Note: For this I-section the Torsional(-Flexural) buckling resistance is higher than the resistance for Flexural buckling. Therefore Torsional(-Flexural) buckling is not printed on the output.

Lateral Torsional Buckling check

According to EN 1993-1-1 article 6.3.2.1 & 6.3.2.3 and formula (6.54)

LTB parameters		
Method for LTB curve	Alternative case	
Cross-section plastic modulus Wpl,y	5,8333e-05	m^3
Elastic critical moment Mcr	32,59	kNm
Relative slenderness Lambda,rel,LT	0,80	
Limit slenderness Lambda,rel,LT,0	0,40	

Note: The slenderness or bending moment is such that Lateral Torsional Buckling effects may be ignored according to EN 1993-1-1 article 6.3.2.2(4).

Mcr parameters		
LTB length L	8,100	m
Influence of load position	no influence	
Correction factor k	1,00	
Correction factor kw	1,00	
LTB moment factor C1	4,19	
LTB moment factor C2	2,08	
LTB moment factor C3	0,41	
Shear center distance d,z	0	mm
Distance of load application z,g	0	mm
Mono-symmetry constant beta,y	0	mm
Mono-symmetry constant z,j	0	mm

Note: C parameters are determined according to ECCS 119 2006 / Galea 2002.

Bending and axial compression check

According to EN 1993-1-1 article 6.3.3 and formula (6.61),(6.62)

Bending and axial compression check parameters		
Interaction method	alternative method 1	
Cross-section area A	1,5600e-03	m ²
Cross-section plastic modulus Wpl,y	5,8333e-05	m ³
Cross-section plastic modulus Wpl,z	2,8458e-05	m ³
Design compression force N,Ed	8,14	kN
Design bending moment (maximum) My,Ed	-1,20	kNm
Design bending moment (maximum) Mz,Ed	-0,05	kNm
Characteristic compression resistance N,Rk	553,80	kN
Characteristic moment resistance My,Rk	20,71	kNm
Characteristic moment resistance Mz,Rk	10,10	kNm
Reduction factor Chi,y	0,90	
Reduction factor Chi,z	0,05	
Modified reduction factor Chi,LT,mod	1,00	
Interaction factor k,yy	1,24	
Interaction factor k,yz	0,45	
Interaction factor k,zy	0,60	
Interaction factor k,zz	0,46	

Maximum moment My,Ed is derived from beam B887 position 0,000 m.

Maximum moment Mz,Ed is derived from beam B887 position 0,000 m.

Interaction method 1 parameters		
Critical Euler load N,cr,y	2695,25	kN
Critical Euler load N,cr,z	29,08	kN
Elastic critical load N,cr,T	986,19	kN
Cross-section plastic modulus Wpl,y	5,8333e-05	m ³
Cross-section elastic modulus Wel,y	5,1980e-05	m ³
Cross-section plastic modulus Wpl,z	2,8458e-05	m ³
Cross-section elastic modulus Wel,z	1,8400e-05	m ³
Second moment of area Iy	2,3700e-06	m ⁴
Second moment of area Iz	9,2060e-07	m ⁴
Torsional constant It	2,5100e-08	m ⁴
Method for equivalent moment factor C,my,0	Table A.2 Line 2 (General)	
Design bending moment (maximum) My,Ed	-1,20	kNm
Maximum relative deflection delta,z	0,2	mm
Equivalent moment factor C,my,0	1,00	
Method for equivalent moment factor C,mz,0	Table A.2 Line 1 (Linear)	
Ratio of end moments Psi,z	-0,99	
Equivalent moment factor C,mz,0	0,45	
Factor mu,y	1,00	
Factor mu,z	0,73	
Factor epsilon,y	4,43	
Factor a,LT	0,99	
Critical moment for uniform bending Mcr,0	7,78	kNm
Relative slenderness Lambda,rel,0	1,63	
Limit relative slenderness Lambda,rel,0,lim	0,38	
Equivalent moment factor C,my	1,00	
Equivalent moment factor C,mz	0,45	
Equivalent moment factor C,mLT	1,17	
Factor b,LT	0,00	
Factor c,LT	0,00	
Factor d,LT	0,00	
Factor e,LT	0,00	
Factor w,y	1,12	
Factor w,z	1,50	
Factor n,pl	0,01	
Maximum relative slenderness Lambda,rel,max	4,36	
Factor C,yy	0,94	
Factor C,yz	0,96	
Factor C,zy	0,73	
Factor C,zz	0,98	

Unity check (6.61) = 0,02 + 0,07 + 0,00 = 0,09 -

Unity check (6.62) = 0,31 + 0,04 + 0,00 = 0,35 -

Shear Buckling check

According to EN 1993-1-5 article 5 & 7.1 and formula (5.10) & (7.1)

Shear Buckling parameters		
Buckling field length a	8,100	m
Web	unstiffened	
Web height hw	80	mm
Web thickness t	4	mm
Material coefficient epsilon	0,81	
Shear correction factor Eta	1,20	

Shear Buckling verification	
Web slenderness hw/t	19,05
Web slenderness limit	48,82

Note: The web slenderness is such that Shear Buckling effects may be ignored according to EN 1993-1-5 article 5.1(2).
The member satisfies the stability check.

Proračunski profil donjeg pojasa poprečne rešetke je HEA 100. Profil je povećan na HEA 180 zbog izvedbe spojeva i predviđene reklame duž cijelog objekta koja se oslanja na Poprečnu rešetku 1, a njen utjecaj nije uzet u obzir ovim proračunom.

MATERIJAL

$f_y = 355 \text{ N/mm}^2$
 $f_u = 510 \text{ N/mm}^2$
 $\varepsilon = 0,814$
 $E = 210000 \text{ N/mm}^2$
 $G = 80777 \text{ N/mm}^2$
 $\nu = 0.3$

PARAMETRI

$A = 45,300 \text{ cm}^2$
 $A_y = 35,500 \text{ cm}^2$
 $A_z = 14,500 \text{ cm}^2$
 $I_y = 2510,300 \text{ cm}^4$
 $W_y = 293,600 \text{ cm}^3$
 $W_{ply} = 324,900 \text{ cm}^3$
 $i_y = 7,400 \text{ cm}$
 $I_z = 924,600 \text{ cm}^4$
 $W_z = 102,700 \text{ cm}^3$
 $W_{plz} = 156,500 \text{ cm}^3$
 $i_z = 4,500 \text{ cm}$
 $I_t = 14,800 \text{ cm}^4$
 $I_\omega = 60210,900 \text{ cm}^6$

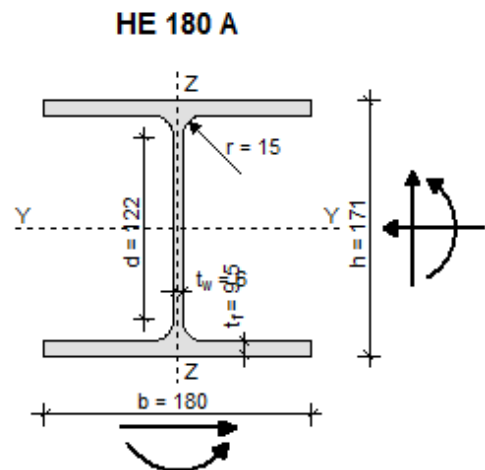

7.3.3 Dimenzioniranje ispune

Kritično opterećenje snijeg

- Kombinacija $1,35 \cdot (g + \Delta g) + 1,5 \cdot s$

Rezne sile

➤ $N \text{ (kN)} = -71,1 \text{ kN}$

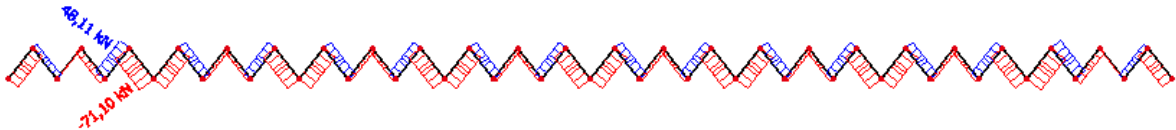

MATERIJAL

$$f_y = 355 \text{ N/mm}^2$$

$$f_u = 510 \text{ N/mm}^2$$

$$\varepsilon = 0,814$$

$$E = 210000 \text{ N/mm}^2$$

$$G = 80777 \text{ N/mm}^2$$

$$\nu = 0,3$$

PARAMETRI

$$A = 6,950 \text{ cm}^2$$

$$A_y = 3,500 \text{ cm}^2$$

$$A_z = 3,500 \text{ cm}^2$$

$$I_y = 23,700 \text{ cm}^4$$

$$W_y = 9,500 \text{ cm}^3$$

$$W_{ply} = 11,700 \text{ cm}^3$$

$$i_y = 1,850 \text{ cm}$$

$$I_z = 23,700 \text{ cm}^4$$

$$W_z = 9,500 \text{ cm}^3$$

$$W_{plz} = 11,700 \text{ cm}^3$$

$$i_z = 1,800 \text{ cm}$$

$$I_t = 40,400 \text{ cm}^4$$

$$I_\omega = 0,000 \text{ cm}^6$$

50x50x4

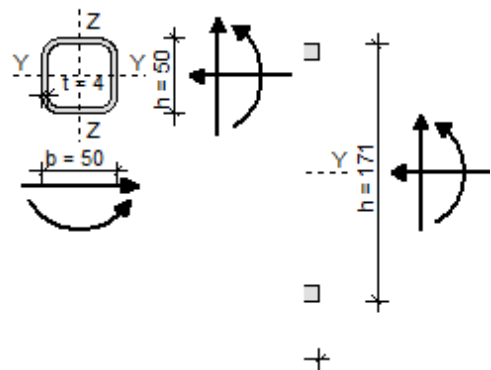

Member B1643	2,174 m	CFRHS50X50X4	S 355	GSN-SNJIJEG	0,95 -
--------------	---------	--------------	-------	-------------	--------

Note: EN 1993-1-3 article 1.1(3) specifies that this part does not apply to cold formed CHS and RHS sections. The default EN 1993-1-1 code check is executed instead of the EN 1993-1-3 code check.

Partial safety factors	
Gamma M0 for resistance of cross-sections	1,00
Gamma M1 for resistance to instability	1,00
Gamma M2 for resistance of net sections	1,25

Material		
Yield strength f_y	355,0	MPa
Ultimate strength f_u	510,0	MPa
Fabrication	Cold formed	

....SECTION CHECK:....

The critical check is on position 0.000 m

Internal forces	Calculated	Unit
N,Ed	-71,10	kN
V _y ,Ed	0,00	kN
V _z ,Ed	0,00	kN
T,Ed	0,00	kNm
M _y ,Ed	0,00	kNm
M _z ,Ed	0,00	kNm

Classification for cross-section design

According to EN 1993-1-1 article 5.5.2

Classification of Internal Compression parts

According to EN 1993-1-1 Table 5.2 Sheet 1

Maximum width-to-thickness ratio	9,50
Class 1 Limit	26,85
Class 2 Limit	30,92
Class 3 Limit	34,17

=> Section classified as Class 1 for cross-section design

Compression check

According to EN 1993-1-1 article 6.2.4 and formula (6.9)

A	6,9500e-04	m ²
N _{c,Rd}	246,72	kN
Unity check	0,29	-

The member satisfies the section check.

....STABILITY CHECK:....

Classification for member buckling design

Decisive position for stability classification: 0.000 m

Classification of Internal Compression parts

According to EN 1993-1-1 Table 5.2 Sheet 1

Maximum width-to-thickness ratio	9,50
Class 1 Limit	26,85
Class 2 Limit	30,92
Class 3 Limit	34,17

=> Section classified as Class 1 for member buckling design

Flexural Buckling check

According to EN 1993-1-1 article 6.3.1.1 and formula (6.46)

Buckling parameters	yy	zz	
Sway type	sway	non-sway	
System length L	2,174	2,174	m
Buckling factor k	1,00	1,00	
Buckling length L _{cr}	2,174	2,174	m
Critical Euler load N _{cr}	104,11	104,11	kN
Slenderness Lambda	117,63	117,63	
Relative slenderness Lambda _{rel}	1,54	1,54	
Limit slenderness Lambda _{rel,0}	0,20	0,20	
Buckling curve	c	c	
Imperfection Alpha	0,49	0,49	
Reduction factor Chi	0,30	0,30	
Buckling resistance N _{b,Rd}	74,53	74,53	kN

Flexural Buckling verification		
Cross-section area A	6,9500e-04	m ²
Buckling resistance N _{b,Rd}	74,53	kN
Unity check	0,95	-

7.3.4 Dimenzioniranje vertikala

Kritično opterećenje snijeg

- Kombinacija $1,35 \cdot (g + \Delta g) + 1,5 \cdot s$

Rezne sile

➤ $N \text{ (kN)} = -17,16 \text{ kN}$

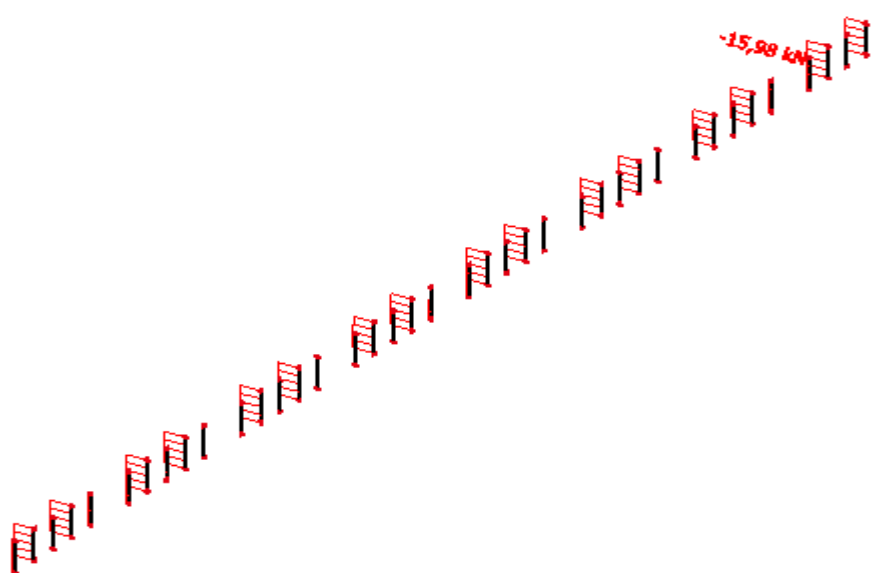

MATERIJAL

$f_y = 355 \text{ N/mm}^2$

$f_u = 510 \text{ N/mm}^2$

$\epsilon = 0,814$

$E = 210000 \text{ N/mm}^2$

$G = 80777 \text{ N/mm}^2$

$\nu = 0,3$

PARAMETRI

$A = 5,350 \text{ cm}^2$

$A_y = 2,700 \text{ cm}^2$

$A_z = 2,700 \text{ cm}^2$

$I_y = 11,100 \text{ cm}^4$

$W_y = 5,600 \text{ cm}^3$

$W_{ply} = 7,010 \text{ cm}^3$

$i_y = 1,440 \text{ cm}$

$I_z = 11,100 \text{ cm}^4$

$W_z = 5,600 \text{ cm}^3$

$W_{plz} = 7,000 \text{ cm}^3$

$i_z = 1,400 \text{ cm}$

$I_t = 19,400 \text{ cm}^4$

$I_\omega = 0,000 \text{ cm}^6$

40x40x4

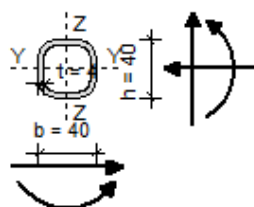

Proračunski profil vertikala poprečne rešetke je 30x30x3. Profil je povećan na 40x40x4 zbog izvedbe spojeva, mogućnosti varenje (stijenka > 4mm) i predviđene reklame duž cijelog objekta koja se oslanja na Poprečnu rešetku 1, a njen utjecaj nije uzet u obzir ovim proračunom.

Member B670	1,704 m	CFRHS30X30X3	S 355	GSN-SNIJEG	0,81 -
-------------	---------	--------------	-------	------------	--------

Note: EN 1993-1-3 article 1.1(3) specifies that this part does not apply to cold formed CHS and RHS sections. The default EN 1993-1-1 code check is executed instead of the EN 1993-1-3 code check.

Partial safety factors	
Gamma M0 for resistance of cross-sections	1,00
Gamma M1 for resistance to instability	1,00
Gamma M2 for resistance of net sections	1,25

Material		
Yield strength f_y	355,0	MPa
Ultimate strength f_u	510,0	MPa
Fabrication	Cold formed	

....SECTION CHECK:....

The critical check is on position 1.704 m

Internal forces	Calculated	Unit
N,Ed	-15,98	kN
Vy,Ed	0,00	kN
Vz,Ed	0,00	kN
T,Ed	0,00	kNm
My,Ed	0,00	kNm
Mz,Ed	0,00	kNm

Classification for cross-section design

According to EN 1993-1-1 article 5.5.2

Classification of Internal Compression parts

According to EN 1993-1-1 Table 5.2 Sheet 1

Maximum width-to-thickness ratio	7,00
Class 1 Limit	26,85
Class 2 Limit	30,92
Class 3 Limit	34,17

=> Section classified as Class 1 for cross-section design

Compression check

According to EN 1993-1-1 article 6.2.4 and formula (6.9)

A	3,0100e-04	m ²
Nc,Rd	106,86	kN
Unity check	0,15	-

The member satisfies the section check.

....STABILITY CHECK:....

Classification for member buckling design

Decisive position for stability classification: 0,000 m

Classification of Internal Compression parts

According to EN 1993-1-1 Table 5.2 Sheet 1

Maximum width-to-thickness ratio	7,00
Class 1 Limit	26,85
Class 2 Limit	30,92
Class 3 Limit	34,17

=> Section classified as Class 1 for member buckling design

Flexural Buckling check

According to EN 1993-1-1 article 6.3.1.1 and formula (6.46)

Buckling parameters	yy	zz	
Sway type	sway	non-sway	
System length L	1,704	1,704	m
Buckling factor k	1,00	1,00	
Buckling length Lcr	1,704	1,704	m
Critical Euler load Ncr	24,98	24,98	kN
Slenderness Lambda	158,02	158,02	
Relative slenderness Lambda,rel	2,07	2,07	
Limit slenderness Lambda,rel,0	0,20	0,20	
Buckling curve	c	c	
Imperfection Alpha	0,49	0,49	
Reduction factor Chi	0,19	0,19	
Buckling resistance Nb,Rd	19,79	19,79	kN

Flexural Buckling verification		
Cross-section area A	3,0100e-04	m ²
Buckling resistance Nb,Rd	19,79	kN
Unity check	0,81	-

7.4 Dimenzioniranje poprečne rešetke 2

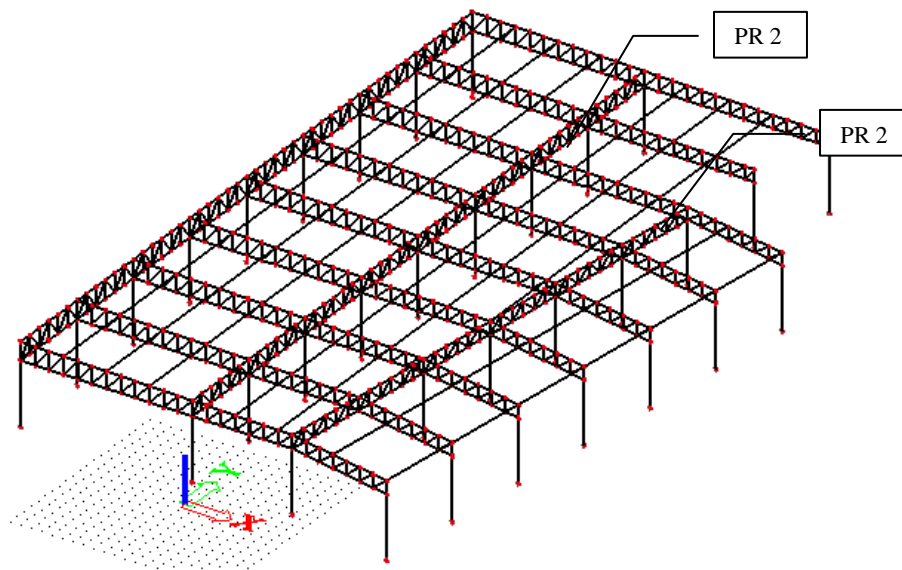

Slika 13: Prostorni prikaz rešetke

7.4.1 Dimenzioniranje gornjeg pojasa

Kritično opterećenje snijeg

- Kombinacija $1,35 \cdot (g + \Delta g) + 1,5 \cdot s$

Rezne sile

➤ M_y (kNm) = 2,97 kNm

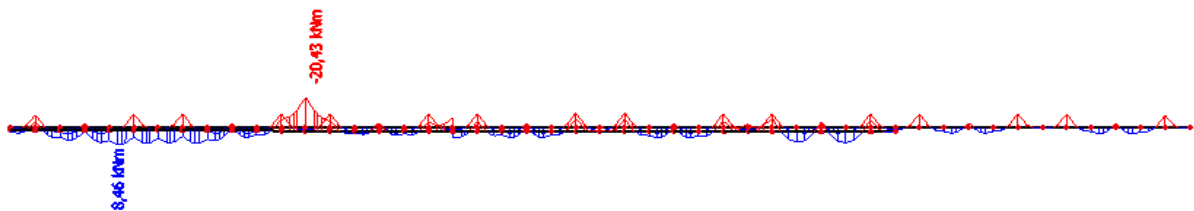

➤ V_z (kN) = 9,03 kN

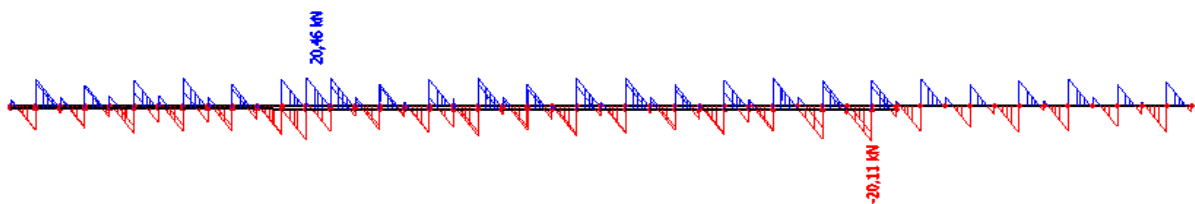

➤ N (kN) = - 42,61 kN



Member B2035	8,150 m	HEA240	S 355	GSN-SNJIJEG	1,00 -
--------------	---------	--------	-------	-------------	--------

Partial safety factors	
Gamma M0 for resistance of cross-sections	1,00
Gamma M1 for resistance to instability	1,00
Gamma M2 for resistance of net sections	1,25

Material	
Yield strength f_y	355,0 MPa
Ultimate strength f_u	490,0 MPa
Fabrication	Rolled

.....SECTION CHECK:.....

The critical check is on position 8.150 m

Internal forces	Calculated	Unit
N,Ed	-593,81	kN
Vy,Ed	-0,05	kN
Vz,Ed	1,12	kN
T,Ed	0,00	kNm
My,Ed	26,66	kNm
Mz,Ed	-0,79	kNm

Classification for cross-section design

According to EN 1993-1-1 article 5.5.2

Classification of Internal Compression parts

According to EN 1993-1-1 Table 5.2 Sheet 1

Maximum width-to-thickness ratio	21,87
Class 1 Limit	26,85
Class 2 Limit	30,92
Class 3 Limit	41,48

=> Internal Compression parts Class 1

Classification of Outstand Flanges

According to EN 1993-1-1 Table 5.2 Sheet 2

Maximum width-to-thickness ratio	7,94
Class 1 Limit	7,32
Class 2 Limit	8,14
Class 3 Limit	11,23

=> Outstand Flanges Class 2

=> Section classified as Class 2 for cross-section design

Compression check

According to EN 1993-1-1 article 6.2.4 and formula (6.9)

A	7,6800e-03	m ²
Nc,Rd	2726,40	kN
Unity check	0,22	-

Bending moment check for My

According to EN 1993-1-1 article 6.2.5 and formula (6.12),(6.13)

Wpl,y	7,4583e-04	m ³
Mpl,y,Rd	264,77	kNm
Unity check	0,10	-

Bending moment check for Mz

According to EN 1993-1-1 article 6.2.5 and formula (6.12),(6.13)

Wpl,z	3,5167e-04	m ³
Mpl,z,Rd	124,84	kNm
Unity check	0,01	-

Shear check for Vy

According to EN 1993-1-1 article 6.2.6 and formula (6.17)

Eta	1,20	
Av	5,9737e-03	m ²
Vpl,y,Rd	1224,38	kN
Unity check	0,00	-

Shear check for Vz

According to EN 1993-1-1 article 6.2.6 and formula (6.17)

Eta	1,20	
Av	2,5140e-03	m ²
Vpl,z,Rd	515,27	kN
Unity check	0,00	-

Unity check	0,00	-
-------------	------	---

Note: The unity check for torsion is lower than the limit value of 0,05. Therefore torsion is considered as insignificant and is ignored in the combined checks.

Combined bending, axial force and shear force check
According to EN 1993-1-1 article 6.2.9.1 and formula (6.41)

MN _y ,Rd	236,69	kNm
Alpha	2,00	
MN _z ,Rd	124,84	kNm
Beta	1,09	

Unity check (6.41) = 0,01 + 0,00 = 0,02 -

Note: Since the shear forces are less than half the plastic shear resistances their effect on the moment resistances is neglected.

The member satisfies the section check.

....:STABILITY CHECK:....

Classification for member buckling design

Decisive position for stability classification: 0,000 m

Classification of Internal Compression parts

According to EN 1993-1-1 Table 5.2 Sheet 1

Maximum width-to-thickness ratio	21,87
Class 1 Limit	418,71
Class 2 Limit	482,68
Class 3 Limit	2629,36

=> Internal Compression parts Class 1

Classification of Outstand Flanges

According to EN 1993-1-1 Table 5.2 Sheet 2

Maximum width-to-thickness ratio	7,94
Class 1 Limit	7,32
Class 2 Limit	8,14
Class 3 Limit	12,72

=> Outstand Flanges Class 2

=> Section classified as Class 2 for member buckling design

Flexural Buckling check

According to EN 1993-1-1 article 6.3.1.1 and formula (6.46)

Buckling parameters	yy	zz	
Sway type	sway	non-sway	
System length L	1,355	8,150	m
Buckling factor k	1,00	1,00	
Buckling length L _{cr}	1,355	8,150	m
Critical Euler load N _{cr}	87591,10	864,32	kN
Slenderness Lambda	13,48	135,71	
Relative slenderness Lambda _{rel}	0,18	1,78	
Limit slenderness Lambda _{rel,0}	0,20	0,20	
Buckling curve	b	c	
Imperfection Alpha	0,34	0,49	
Reduction factor Chi	1,00	0,24	
Buckling resistance N _b ,Rd	2726,40	653,78	kN

Flexural Buckling verification		
Cross-section area A	7,6800e-03	m ²
Buckling resistance N _b ,Rd	653,78	kN
Unity check	0,91	-

Torsional(-Flexural) Buckling check

According to EN 1993-1-1 article 6.3.1.1 and formula (6.46)

Note: For this I-section the Torsional(-Flexural) buckling resistance is higher than the resistance for Flexural buckling. Therefore Torsional(-Flexural) buckling is not printed on the output.

Lateral Torsional Buckling check

According to EN 1993-1-1 article 6.3.2.1 & 6.3.2.3 and formula (6.54)

LTB parameters		
Method for LTB curve	Alternative case	
Cross-section plastic modulus W _{pl,y}	7,4583e-04	m ³
Elastic critical moment M _{cr}	491,74	kNm
Relative slenderness Lambda _{LT}	0,73	
Limit slenderness Lambda _{rel,LT,0}	0,40	

Note: The slenderness or bending moment is such that Lateral Torsional Buckling effects may be ignored according to EN 1993-1-1 article 6.3.2.2(4).

M _{cr} parameters		
LTB length L	8,150	m
Influence of load position	no influence	
Correction factor k	1,00	

Student version *Student version* *Student version* *Student version* *Student vers

Mcr parameters		
Correction factor kw	1,00	
LTB moment factor C1	2,53	
LTB moment factor C2	0,24	
LTB moment factor C3	1,00	
Shear center distance d,z	0	mm
Distance of load application z,g	0	mm
Mono-symmetry constant beta,y	0	mm
Mono-symmetry constant z,j	0	mm

Note: C parameters are determined according to ECSS 119 2006 / Galea 2002.

Bending and axial compression check

According to EN 1993-1-1 article 6.3.3 and formula (6.61),(6.62)

Bending and axial compression check parameters		
Interaction method	alternative method 1	
Cross-section area A	7,6800e-03	m ²
Cross-section plastic modulus Wpl,y	7,4583e-04	m ³
Cross-section plastic modulus Wpl,z	3,5167e-04	m ³
Design compression force N,Ed	593,81	kN
Design bending moment (maximum) My,Ed	26,66	kNm
Design bending moment (maximum) Mz,Ed	-0,79	kNm
Characteristic compression resistance N,Rk	2726,40	kN
Characteristic moment resistance My,Rk	264,77	kNm
Characteristic moment resistance Mz,Rk	124,84	kNm
Reduction factor Chi,y	1,00	
Reduction factor Chi,z	0,24	
Modified reduction factor Chi,LT,mod	1,00	
Interaction factor k,yy	2,19	
Interaction factor k,yz	3,27	
Interaction factor k,zy	0,82	
Interaction factor k,zz	1,52	

Maximum moment My,Ed is derived from beam B2035 position 8,150 m.
Maximum moment Mz,Ed is derived from beam B2035 position 8,150 m.

Interaction method 1 parameters		
Critical Euler load N,cr,y	87591,10	kN
Critical Euler load N,cr,z	864,32	kN
Elastic critical load N,cr,T	3198,16	kN
Cross-section plastic modulus Wpl,y	7,4583e-04	m ³
Cross-section elastic modulus Wel,y	6,7500e-04	m ³
Cross-section plastic modulus Wpl,z	3,5167e-04	m ³
Cross-section elastic modulus Wel,z	2,3100e-04	m ³
Second moment of area Iy	7,7600e-05	m ⁴
Second moment of area Iz	2,7700e-05	m ⁴
Torsional constant It	4,1600e-07	m ⁴
Method for equivalent moment factor C,my,0	Table A.2 Line 2 (General)	
Design bending moment (maximum) My,Ed	26,66	kNm
Maximum relative deflection delta,z	-0,3	mm
Equivalent moment factor C,my,0	1,00	
Method for equivalent moment factor C,mz,0	Table A.2 Line 1 (Linear)	
Ratio of end moments Psi,z	0,47	
Equivalent moment factor C,mz,0	0,92	
Factor mu,y	1,00	
Factor mu,z	0,37	
Factor epsilon,y	0,51	
Factor a,LT	0,99	
Critical moment for uniform bending Mcr,0	194,68	kNm
Relative slenderness Lambda,rel,0	1,17	
Limit relative slenderness Lambda,rel,0,lim	0,23	
Equivalent moment factor C,my	1,00	
Equivalent moment factor C,mz	0,92	
Equivalent moment factor C,mLT	1,97	
Factor b,LT	-0,00	
Factor c,LT	0,09	
Factor d,LT	-0,00	
Factor e,LT	0,02	
Factor w,y	1,10	
Factor w,z	1,50	
Factor n,pl	0,22	
Maximum relative slenderness Lambda,rel,max	1,78	
Factor C,yy	0,91	
Factor C,yz	0,63	
Factor C,zy	0,47	
Factor C,zz	0,73	

Unity check (6.61) = 0,22 + 0,22 + 0,02 = 0,46 -
Unity check (6.62) = 0,91 + 0,08 + 0,01 = 1,00 -

Shear Buckling check

According to EN 1993-1-5 article 5 & 7.1 and formula (5.10) & (7.1)

Shear Buckling parameters	
Buckling field length a	8,150 m

Shear Buckling parameters		
Web	unstiffened	
Web height h_w	206	mm
Web thickness t	8	mm
Material coefficient epsilon	0,81	
Shear correction factor Eta	1,20	

Shear Buckling verification	
Web slenderness h_w/t	27,47
Web slenderness limit	48,82

MATERIJAL

$f_y = 355 \text{ N/mm}^2$
 $f_u = 510 \text{ N/mm}^2$
 $\varepsilon = 0,814$
 $E = 210000 \text{ N/mm}^2$
 $G = 80777 \text{ N/mm}^2$
 $\nu = 0.3$

REZNE SILE**PARC. FAKTORI SIG.**

$\gamma_{M0} = 1,1$
 $\gamma_{M1} = 1,1$
 $\gamma_{M2} = 1,25$

PARAMETRI

$A = 76,800 \text{ cm}^2$
 $A_y = 59,700 \text{ cm}^2$
 $A_z = 25,200 \text{ cm}^2$
 $I_y = 7763,200 \text{ cm}^4$
 $W_y = 675,100 \text{ cm}^3$
 $W_{ply} = 744,600 \text{ cm}^3$
 $i_y = 10,100 \text{ cm}$
 $I_z = 2768,800 \text{ cm}^4$
 $W_z = 230,700 \text{ cm}^3$
 $W_{plz} = 351,700 \text{ cm}^3$
 $i_z = 6,000 \text{ cm}$
 $I_t = 41,600 \text{ cm}^4$
 $I_\omega = 328485,900 \text{ cm}^6$

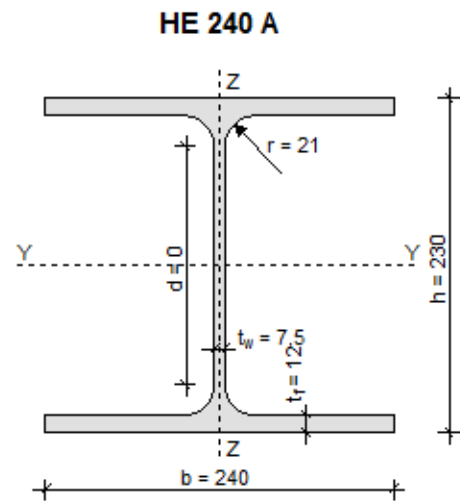

7.4.2 Dimenzioniranje donjeg pojasa

Kritično opterećenje snijeg

- Kombinacija $1,35 \cdot (g+\Delta g)+1,5 \cdot s$

Rezne sile

➤ M_y (kNm) = 2,26 kNm

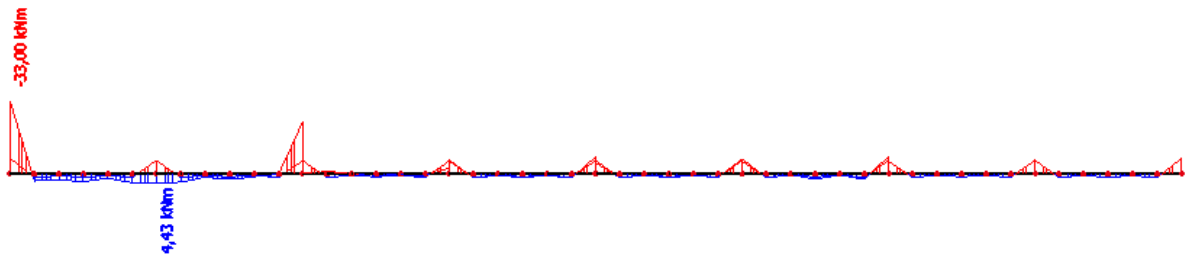

➤ V_z (kN) = 2,37 kNm

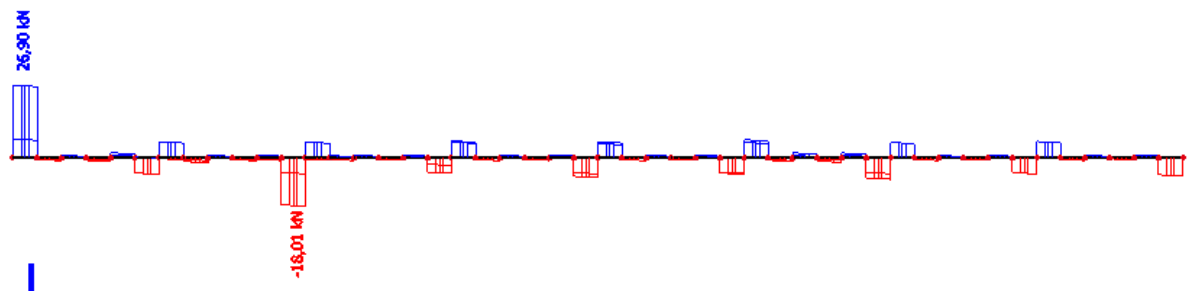

➤ N (kN) = - 16,53 kNm; N (kN) = - 60,99 kNm

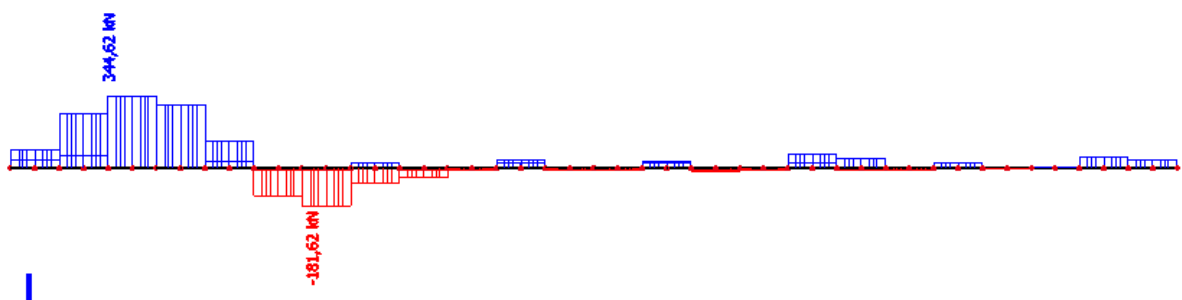

Unity check	0,00	-
-------------	------	---

Note: The unity check for torsion is lower than the limit value of 0,05. Therefore torsion is considered as insignificant and is ignored in the combined checks.

Combined bending, axial force and shear force check
According to EN 1993-1-1 article 6.2.9.1 and formula (6.41)

Mpl,y,Rd	152,35	kNm
Alpha	2,00	
Mpl,z,Rd	72,33	kNm
Beta	1,00	

Unity check (6.41) = 0,08 + 0,01 = 0,09 -

Note: Since the shear forces are less than half the plastic shear resistances their effect on the moment resistances is neglected.

Note: Since the axial force satisfies both criteria (6.33) and (6.34) of EN 1993-1-1 article 6.2.9.1(4) its effect on the moment resistance about the y-y axis is neglected.

Note: Since the axial force satisfies criteria (6.35) of EN 1993-1-1 article 6.2.9.1(4) its effect on the moment resistance about the z-z axis is neglected.

The member satisfies the section check.

....**STABILITY CHECK**....

Classification for member buckling design

Decisive position for stability classification: 5,436 m

Classification of Internal Compression parts

According to EN 1993-1-1 Table 5.2 Sheet 1

Maximum width-to-thickness ratio	20,62
Class 1 Limit	26,85
Class 2 Limit	30,92
Class 3 Limit	37,07

=> Internal Compression parts Class 1

Classification of Outstand Flanges

According to EN 1993-1-1 Table 5.2 Sheet 2

Maximum width-to-thickness ratio	7,88
Class 1 Limit	7,32
Class 2 Limit	8,14
Class 3 Limit	11,23

=> Outstand Flanges Class 2

=> Section classified as Class 2 for member buckling design

Flexural Buckling check

According to EN 1993-1-1 article 6.3.1.1 and formula (6.46)

Buckling parameters	yy	zz	
Sway type	sway	non-sway	
System length L	1,355	8,150	m
Buckling factor k	1,00	1,00	
Buckling length Lcr	1,355	8,150	m
Critical Euler load Ncr	41651,94	418,12	kN
Slenderness Lambda	16,36	163,30	
Relative slenderness Lambda,rel	0,21	2,14	
Limit slenderness Lambda,rel,0	0,20	0,20	
Buckling curve	b	c	
Imperfection Alpha	0,34	0,49	
Reduction factor Chi	0,99	0,17	
Buckling resistance Nb,Rd	1900,33	334,00	kN

Flexural Buckling verification

Cross-section area A	5,3800e-03	m ²
Buckling resistance Nb,Rd	334,00	kN
Unity check	0,59	

Torsional(-Flexural) Buckling check

According to EN 1993-1-1 article 6.3.1.1 and formula (6.46)

Note: For this I-section the Torsional(-Flexural) buckling resistance is higher than the resistance for Flexural buckling. Therefore Torsional(-Flexural) buckling is not printed on the output.

Lateral Torsional Buckling check

According to EN 1993-1-1 article 6.3.2.1 & 6.3.2.3 and formula (6.54)

LTB parameters		
Method for LTB curve	Alternative case	
Cross-section plastic modulus Wpl,y	4,2917e-04	m ³
Elastic critical moment Mcr	275,18	kNm
Relative slenderness Lambda,rel,LT	0,74	
Limit slenderness Lambda,rel,LT,0	0,40	

Note: The slenderness or bending moment is such that Lateral Torsional Buckling effects may be ignored according to EN 1993-1-1 article 6.3.2.2(4).

Mcr parameters		
LTB length L	8,150	m
Influence of load position	no influence	
Correction factor k	1,00	
Correction factor kw	1,00	
LTB moment factor C1	2,98	
LTB moment factor C2	0,92	
LTB moment factor C3	0,41	
Shear center distance d,z	0	mm
Distance of load application z,g	0	mm
Mono-symmetry constant beta,y	0	mm
Mono-symmetry constant z,j	0	mm

Note: C parameters are determined according to ECCS 119 2006 / Galea 2002.

Bending and axial compression check

According to EN 1993-1-1 article 6.3.3 and formula (6.61),(6.62)

Bending and axial compression check parameters		
Interaction method	alternative method 1	
Cross-section area A	5,3800e-03	m ²
Cross-section plastic modulus Wpl,y	4,2917e-04	m ³
Cross-section plastic modulus Wpl,z	2,0375e-04	m ³
Design compression force N,Ed	195,78	kN
Design bending moment (maximum) My,Ed	-43,08	kNm
Design bending moment (maximum) Mz,Ed	-1,07	kNm
Characteristic compression resistance N,Rk	1909,90	kN
Characteristic moment resistance My,Rk	152,35	kNm
Characteristic moment resistance Mz,Rk	72,33	kNm
Reduction factor Chi,y	0,99	
Reduction factor Chi,z	0,17	
Modified reduction factor Chi,LT,mod	1,00	
Interaction factor k,yy	1,56	
Interaction factor k,yz	1,01	
Interaction factor k,zy	0,70	
Interaction factor k,zz	0,73	

Maximum moment My,Ed is derived from beam B2049 position 8,150 m.
Maximum moment Mz,Ed is derived from beam B2049 position 0,000 m.

Interaction method 1 parameters		
Critical Euler load N,cr,y	41651,94	kN
Critical Euler load N,cr,z	418,12	kN
Elastic critical load N,cr,T	2174,62	kN
Cross-section plastic modulus Wpl,y	4,2917e-04	m ³
Cross-section elastic modulus Wel,y	3,8900e-04	m ³
Cross-section plastic modulus Wpl,z	2,0375e-04	m ³
Cross-section elastic modulus Wel,z	1,3400e-04	m ³
Second moment of area Iy	3,6900e-05	m ⁴
Second moment of area Iz	1,3400e-05	m ⁴
Torsional constant It	2,1000e-07	m ⁴
Method for equivalent moment factor C,my,0	Table A.2 Line 2 (General)	
Design bending moment (maximum) My,Ed	-43,08	kNm
Maximum relative deflection delta,z	0,7	mm
Equivalent moment factor C,my,0	1,00	
Method for equivalent moment factor C,mz,0	Table A.2 Line 2 (General)	
Design bending moment (maximum) Mz,Ed	-1,07	kNm
Maximum relative deflection delta,y	0,6	mm
Equivalent moment factor C,mz,0	0,64	
Factor mu,y	1,00	
Factor mu,z	0,58	
Factor epsilon,y	3,04	
Factor a,LT	0,99	
Critical moment for uniform bending Mcr,0	92,20	kNm
Relative slenderness Lambda,rel,0	1,29	
Limit relative slenderness Lambda,rel,0,lim	0,29	
Equivalent moment factor C,my	1,00	
Equivalent moment factor C,mz	0,64	
Equivalent moment factor C,mLT	1,43	
Factor b,LT	0,00	
Factor c,LT	0,18	
Factor d,LT	0,00	
Factor e,LT	0,03	
Factor w,y	1,10	
Factor w,z	1,50	
Factor n,pl	0,10	
Maximum relative slenderness Lambda,rel,max	2,14	
Factor C,yy	0,92	
Factor C,yz	0,84	
Factor C,zy	0,61	
Factor C,zz	0,95	

Unity check (6.61) = 0,10 + 0,44 + 0,01 = 0,56 -

Unity check (6.62) = 0,59 + 0,20 + 0,01 = 0,80 -

Shear Buckling check

According to EN 1993-1-5 article 5 & 7.1 and formula (5.10) & (7.1)

Shear Buckling parameters		
Buckling field length a	8,150	m
Web	unstiffened	
Web height hw	170	mm
Web thickness t	7	mm
Material coefficient epsilon	0,81	
Shear correction factor Eta	1,20	

Shear Buckling verification	
Web slenderness hw/t	26,15
Web slenderness limit	48,82

Note: The web slenderness is such that Shear Buckling effects may be ignored according to EN 1993-1-5 article 5.1(2).
The member satisfies the stability check.

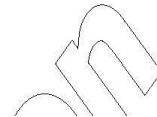

MATERIJAL

$$f_y = 355 \text{ N/mm}^2$$

$$f_u = 510 \text{ N/mm}^2$$

$$\varepsilon = 0,814$$

$$E = 210000 \text{ N/mm}^2$$

$$G = 80777 \text{ N/mm}^2$$

$$\nu = 0.3$$

REZNE SILE

PARC. FAKTORI SIG.

$$\gamma_{M0} = 1,1$$

$$\gamma_{M1} = 1,1$$

$$\gamma_{M2} = 1,25$$

PARAMETRI

$$A = 53,800 \text{ cm}^2$$

$$A_y = 41,600 \text{ cm}^2$$

$$A_z = 18,100 \text{ cm}^2$$

$$I_y = 3692,100 \text{ cm}^4$$

$$W_y = 388,600 \text{ cm}^3$$

$$W_{ply} = 429,500 \text{ cm}^3$$

$$i_y = 8,300 \text{ cm}$$

$$I_z = 1335,500 \text{ cm}^4$$

$$W_z = 133,600 \text{ cm}^3$$

$$W_{plz} = 203,800 \text{ cm}^3$$

$$i_z = 5,000 \text{ cm}$$

$$I_t = 21,000 \text{ cm}^4$$

$$I_\omega = 108000,000 \text{ cm}^6$$

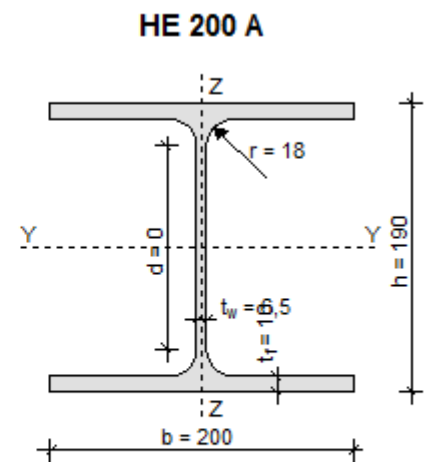

7.4.3 Dimenzioniranje ispuna

Kritično opterećenje snijeg

- Kombinacija $1,35 \cdot (g+\Delta g)+1,5 \cdot s$

Rezne sile

➤ $N \text{ (kN)} = -86,52 \text{ kN}$

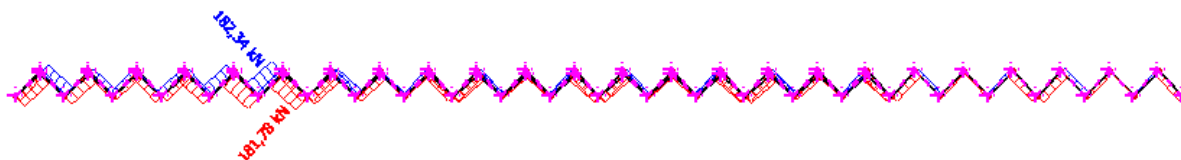

MATERIJAL

$$f_y = 355 \text{ N/mm}^2$$

$$f_u = 510 \text{ N/mm}^2$$

$$\varepsilon = 0,814$$

$$E = 210000 \text{ N/mm}^2$$

$$G = 80777 \text{ N/mm}^2$$

$$\nu = 0.3$$

REZNE SILE

PARC. FAKTORI SIG.

$$\gamma_{M0} = 1,1$$

$$\gamma_{M1} = 1,1$$

$$\gamma_{M2} = 1,25$$

PARAMETRI

$$A = 11,927 \text{ cm}^2$$

$$A_y = 4,000 \text{ cm}^2$$

$$A_z = 4,000 \text{ cm}^2$$

$$I_y = 81,531 \text{ cm}^4$$

$$W_y = 23,295 \text{ cm}^3$$

$$W_{ply} = 28,021 \text{ cm}^3$$

$$i_y = 2,615 \text{ cm}$$

$$I_z = 81,531 \text{ cm}^4$$

$$W_z = 23,295 \text{ cm}^3$$

$$W_{plz} = 28,021 \text{ cm}^3$$

$$i_z = 2,615 \text{ cm}$$

$$I_t = 343,000 \text{ cm}^4$$

$$I_\omega = 0,000 \text{ cm}^6$$

70x70x5

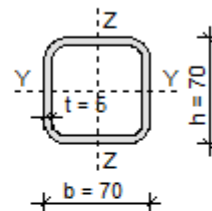

Member B2053	1,817 m	CFRHS70X70X5	S 355	GSN-SNJJEG	0,95 -
--------------	---------	--------------	-------	------------	--------

Note: EN 1993-1-3 article 1.1(3) specifies that this part does not apply to cold formed CHS and RHS sections. The default EN 1993-1-1 code check is executed instead of the EN 1993-1-3 code check.

Partial safety factors	
Gamma M0 for resistance of cross-sections	1,00
Gamma M1 for resistance to instability	1,00
Gamma M2 for resistance of net sections	1,25

Material	
Yield strength fy	355,0 MPa
Ultimate strength fu	510,0 MPa
Fabrication	Cold formed

....SECTION CHECK:....

The critical check is on position 1.817 m

Internal forces	Calculated	Unit
N,Ed	-248,93	kN
Vy,Ed	0,00	kN
Vz,Ed	0,00	kN
T,Ed	0,00	kNm
My,Ed	0,00	kNm
Mz,Ed	0,00	kNm

Classification for cross-section design

According to EN 1993-1-1 article 5.5.2

Classification of Internal Compression parts

According to EN 1993-1-1 Table 5.2 Sheet 1

Maximum width-to-thickness ratio	11,00
Class 1 Limit	26,85
Class 2 Limit	30,92
Class 3 Limit	34,17

=> Section classified as Class 1 for cross-section design

Compression check

According to EN 1993-1-1 article 6.2.4 and formula (6.9)

A	1,2360e-03	m ²
Nc,Rd	438,78	kN
Unity check	0,57	-

The member satisfies the section check.

....STABILITY CHECK:....

Classification for member buckling design

Decisive position for stability classification: 0,000 m

Classification of Internal Compression parts

According to EN 1993-1-1 Table 5.2 Sheet 1

Maximum width-to-thickness ratio	11,00
Class 1 Limit	26,85
Class 2 Limit	30,92
Class 3 Limit	34,17

=> Section classified as Class 1 for member buckling design

Flexural Buckling check

According to EN 1993-1-1 article 6.3.1.1 and formula (6.46)

Buckling parameters	yy	zz	
Sway type	sway	non-sway	
System length L	1,817	1,817	m
Buckling factor k	1,00	1,00	
Buckling length Lcr	1,817	1,817	m
Critical Euler load Ncr	531,12	531,12	kN
Slenderness Lambda	69,45	69,45	
Relative slenderness Lambda,rel	0,91	0,91	
Limit slenderness Lambda,rel,0	0,20	0,20	
Buckling curve	c	c	
Imperfection Alpha	0,49	0,49	
Reduction factor Chi	0,59	0,59	
Buckling resistance Nb,Rd	260,79	260,79	kN

Flexural Buckling verification	
Cross-section area A	1,2360e-03 m ²
Buckling resistance Nb,Rd	260,79 kN
Unity check	0,95 -

7.4.4 Dimenzioniranje vertikala

Kritično opterećenje snijeg

- Kombinacija $1,35 \cdot (g + \Delta g) + 1,5 \cdot s$

Rezne sile

➤ N (kN) = - 16,79 kN

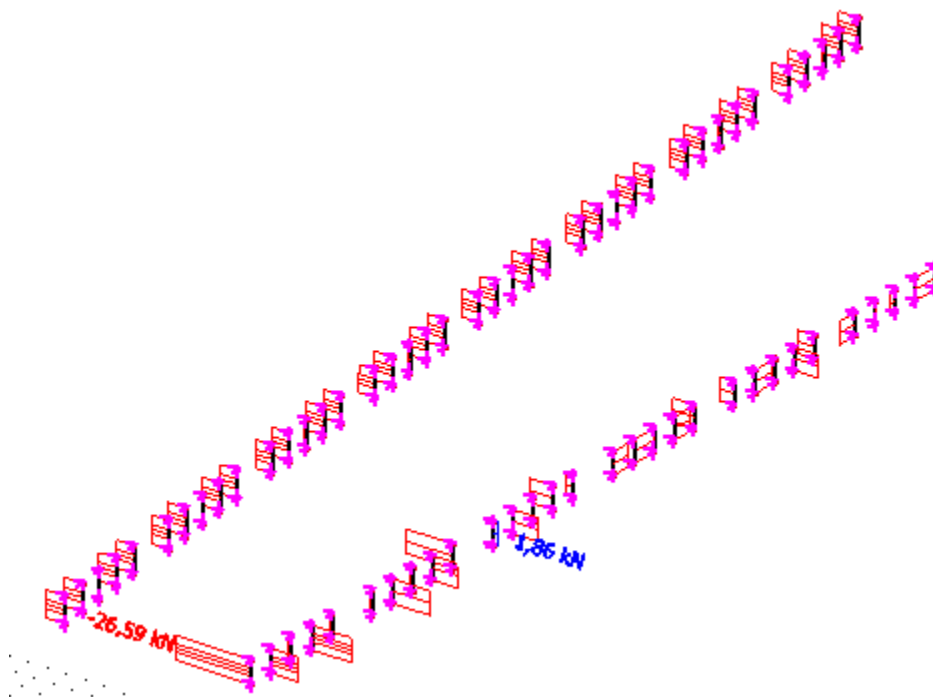

MATERIJAL

$$f_y = 355 \text{ N/mm}^2$$

$$f_u = 510 \text{ N/mm}^2$$

$$\varepsilon = 0,814$$

$$E = 210000 \text{ N/mm}^2$$

$$G = 80777 \text{ N/mm}^2$$

$$\nu = 0.3$$

PARAMETRI

$$A = 5,350 \text{ cm}^2$$

$$A_y = 2,700 \text{ cm}^2$$

$$A_z = 2,700 \text{ cm}^2$$

$$I_y = 11,100 \text{ cm}^4$$

$$W_y = 5,600 \text{ cm}^3$$

$$W_{ply} = 7,010 \text{ cm}^3$$

$$i_y = 1,440 \text{ cm}$$

$$I_z = 11,100 \text{ cm}^4$$

$$W_z = 5,600 \text{ cm}^3$$

$$W_{plz} = 7,000 \text{ cm}^3$$

$$i_z = 1,400 \text{ cm}$$

$$I_t = 19,400 \text{ cm}^4$$

$$I_\omega = 0,000 \text{ cm}^6$$

40x40x4

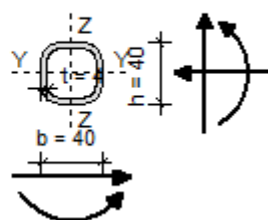

Member B2030	1,228 m	CFRHS40X30X3	S 355	GSN-SNJJEG	0,91 -
--------------	---------	--------------	-------	------------	--------

Note: EN 1993-1-3 article 1.1(3) specifies that this part does not apply to cold formed CHS and RHS sections. The default EN 1993-1-1 code check is executed instead of the EN 1993-1-3 code check.

Partial safety factors	
Gamma M0 for resistance of cross-sections	1,00
Gamma M1 for resistance to instability	1,00
Gamma M2 for resistance of net sections	1,25

Material	
Yield strength f_y	355,0 MPa
Ultimate strength f_u	510,0 MPa
Fabrication	Cold formed

....SECTION CHECK:....

The critical check is on position 1.228 m

Internal forces	Calculated	Unit
N,Ed	-39,55	kN
Vy,Ed	0,00	kN
Vz,Ed	0,00	kN
T,Ed	0,00	kNm
My,Ed	0,00	kNm
Mz,Ed	0,00	kNm

Classification for cross-section design

According to EN 1993-1-1 article 5.5.2

Classification of Internal Compression parts

According to EN 1993-1-1 Table 5.2 Sheet 1

Maximum width-to-thickness ratio	10,33
Class 1 Limit	26,85
Class 2 Limit	30,92
Class 3 Limit	34,17

=> Section classified as Class 1 for cross-section design

Compression check

According to EN 1993-1-1 article 6.2.4 and formula (6.9)

A	3,6100e-04	m ²
Nc,Rd	128,16	kN
Unity check	0,31	-

The member satisfies the section check.

....STABILITY CHECK:....

Classification for member buckling design

Decisive position for stability classification: 0,000 m

Classification of Internal Compression parts

According to EN 1993-1-1 Table 5.2 Sheet 1

Maximum width-to-thickness ratio	10,33
Class 1 Limit	26,85
Class 2 Limit	30,92
Class 3 Limit	34,17

=> Section classified as Class 1 for member buckling design

Flexural Buckling check

According to EN 1993-1-1 article 6.3.1.1 and formula (6.46)

Buckling parameters	yy	zz	
Sway type	sway	non-sway	
System length L	1,228	1,228	m
Buckling factor k	1,00	1,00	
Buckling length Lcr	1,228	1,228	m
Critical Euler load Ncr	99,86	63,18	kN
Slenderness Lambda	86,56	108,82	
Relative slenderness Lambda,rel	1,13	1,42	
Limit slenderness Lambda,rel,0	0,20	0,20	
Buckling curve	c	c	
Imperfection Alpha	0,49	0,49	
Reduction factor Chi	0,47	0,34	
Buckling resistance Nb,Rd	59,85	43,62	kN

Flexural Buckling verification	
Cross-section area A	3,6100e-04 m ²
Buckling resistance Nb,Rd	43,62 kN
Unity check	0,91 -

7.5 Dimenzioniranje čeličnog stupa (pozicija 100-pozicija 200)

MATERIJAL

$f_y = 355 \text{ N/mm}^2$
 $f_u = 510 \text{ N/mm}^2$
 $\varepsilon = 0,814$
 $E = 210000 \text{ N/mm}^2$
 $G = 80777 \text{ N/mm}^2$
 $\nu = 0,3$

REZNE SILE

$N_{Sd} = -600 \text{ kN}$

PARC. FAKTORI SIG.

$\gamma_{M0} = 1,1$
 $\gamma_{M1} = 1,1$
 $\gamma_{M2} = 1,25$

PARAMETRI

$A = 52,800 \text{ cm}^2$
 $A_y = 26,400 \text{ cm}^2$
 $A_z = 26,400 \text{ cm}^2$
 $I_y = 2546,000 \text{ cm}^4$
 $W_y = 282,900 \text{ cm}^3$
 $W_{ply} = 336,000 \text{ cm}^3$
 $i_y = 6,940 \text{ cm}$
 $I_z = 2546,000 \text{ cm}^4$
 $W_z = 282,900 \text{ cm}^3$
 $W_{plz} = 336,000 \text{ cm}^3$
 $i_z = 6,900 \text{ cm}$
 $I_t = 4189,000 \text{ cm}^4$
 $I_\omega = 0,000 \text{ cm}^6$

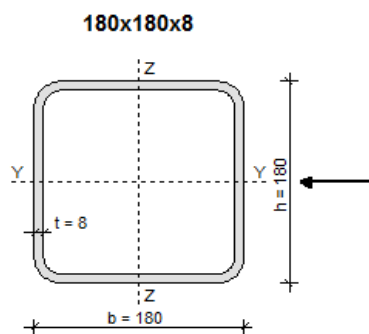

KLASIFIKACIJA POPREČNOG PRESJEKA

HRBAT

$$\frac{h - 3 \cdot t_f}{t_w} = 19,50 \leq 33 \cdot \varepsilon = 26,85 \Rightarrow \text{KLASA 1}$$

POJASNICA

$$\frac{b - 3 \cdot t_w}{t_f} = 19,50 \leq 33 \cdot \varepsilon = 26,85 \Rightarrow \text{KLASA 1}$$

POPREČNI PRESJEK JE SVRSTAN U **KLASU 1**

OTPORNOST POPREČNOG PRESJEKA

UZDUŽNA SILA N_{Sd}

$$N_{c,Rd} = \frac{A \cdot f_y}{\gamma_{M0}} = 1704 \text{ kN} \geq N_{Sd} = 600 \text{ kN}$$

OTPORNOST ELEMENTA

UZDUŽNA TLAČNA OTPORNOST

$$\lambda_1 = \pi \cdot \sqrt{\frac{E}{f_y}} = 76,41, \beta_A = 1,00$$

OS Y-Y

$$l_{iy} = 500 \text{ cm}$$

$$\lambda_{y1} = \frac{l_{iy}}{i_y} = 72,05$$

$$\bar{\lambda}_y = \frac{\lambda_{y1}}{\lambda_1} \cdot \sqrt{\beta_A} = 0,943$$

LINIJA IZVIJANJA a

$$\chi_y = 0,7051$$

OS Z-Z

$$l_{iz} = 500 \text{ cm}$$

$$\lambda_{z1} = \frac{l_{iz}}{i_z} = 72,46$$

$$\bar{\lambda}_z = \frac{\lambda_{z1}}{\lambda_1} \cdot \sqrt{\beta_A} = 0,948$$

LINIJA IZVIJANJA a

$$\chi_z = 0,7014$$

$$N_{b,Rd} = \chi_{\min} \cdot N_{c,Rd} = 1195,19 \text{ kN} \geq N_{Sd} = 600 \text{ kN}$$

8. PRORAČUN PODNE PLOČE POZICIJA 001

Podna ploča 001 se nalazi u garaži na koti -4.30m, debljine je 20 cm i oslonjena je na tlo sa dopuštenim napreznanjima od 500 kPa. Ploče 002 je debljine 25 cm i nalazi se na koti -5.25m dok je ploča 003 debljine 25 cm i nalazi se na koti -6.25m.

Koeficijent posteljice tla određen je preko dopuštenog napreznanja u tlu i dopuštenog slijeganja.

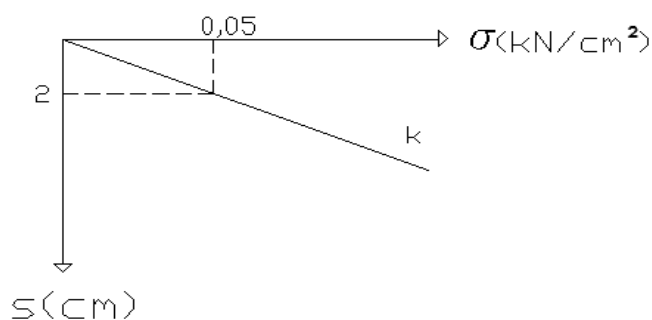

Slika 14: Dijagram odnosa napreznanja u tlu i slijeganja

$$k_s = \frac{\sigma_{dop}}{s} = \frac{0,05(kN / cm^2)}{2,0(cm)} = 0,025kN / cm^3$$

$$k_s = 25(MN / m^3)$$

8.1 Rezultati proračuna

Rezultati proračuna unutarnjih sila:

Prikazane su anvelope minimalnih i maksimalnih vrijednosti momenata savijanja od mjerodavne kombinacije za pojedini smjer: GSN 1,35 •(g+Δg)+1,5•p

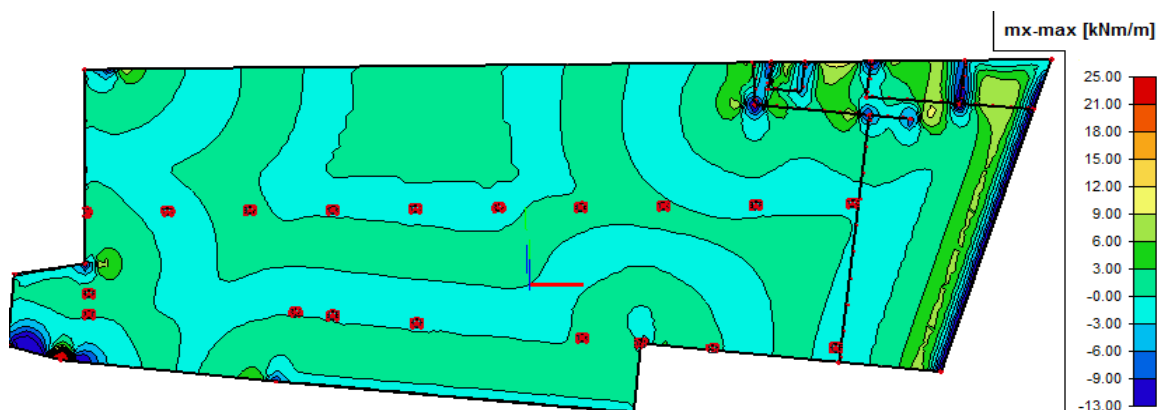

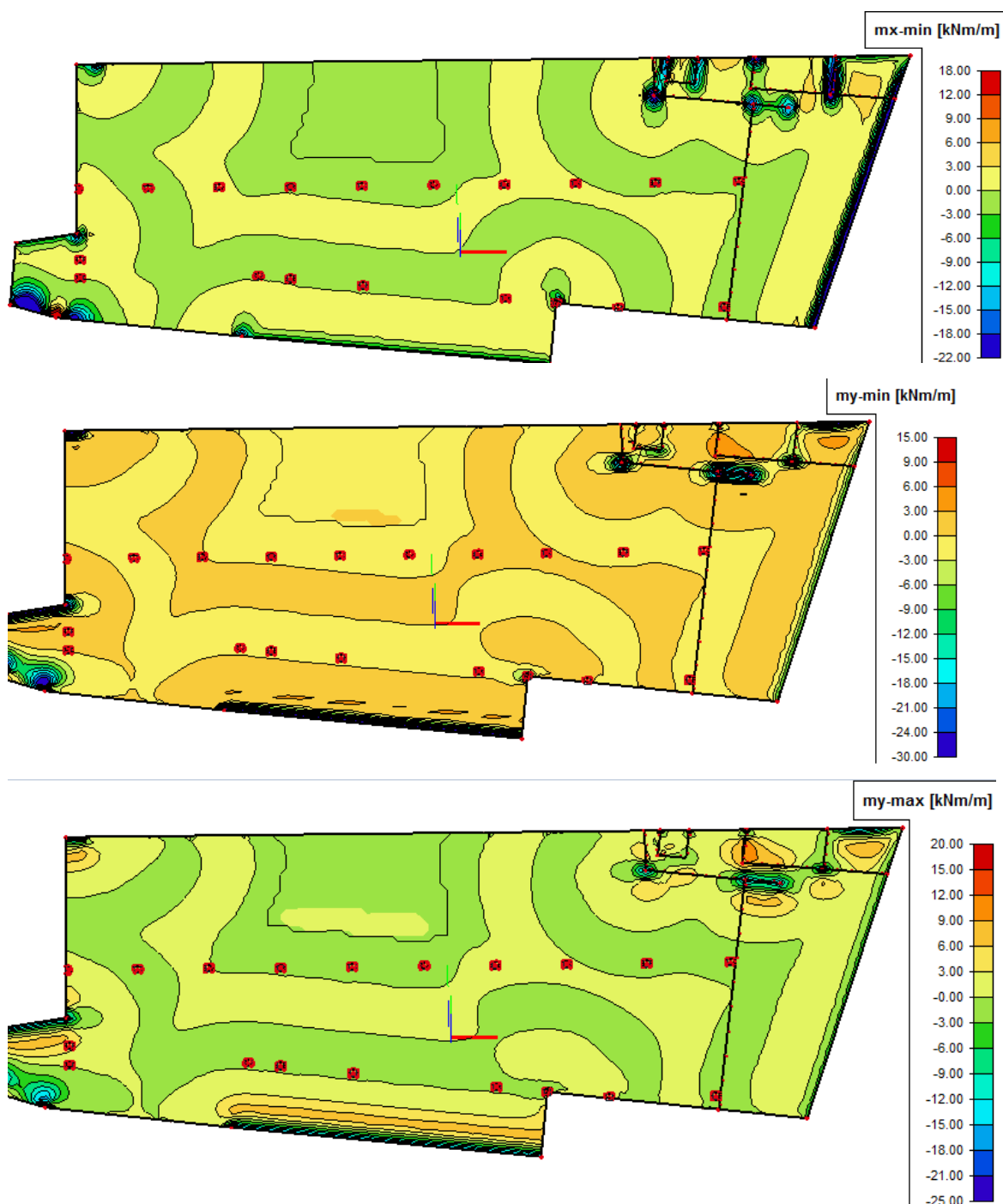

Slika 15: Prikaz minimalnih i maksimalnih momenata savijanja za smjer x i y

Relativne deformacije armature i betona:

$$\mu_{ed} = 0.159; \quad \zeta \approx 0.892 \quad \varepsilon_c / \varepsilon_s = 3.5/10.0$$

Momenti nosivosti betona i armature (prikazani u tablicama u nastavku):

$$M_{Ed,c,lim} = \mu_{Ed,lim} \cdot b \cdot d^2 \cdot f_{cd} = 0.159 \cdot b \cdot d^2 \cdot f_{cd}$$

$$M_{Ed,s,lims} = A_s \cdot \zeta \cdot d \cdot f_{yd}$$

Mjerodavna granična nosivost armiranobetonskog presjeka je manja od spomenutih vrijednosti.

Dimenzije poprečnog presjeka ploče (m³):

$$b=100 \text{ cm} \quad h=20 \text{ cm}; \quad d=17 \text{ cm}$$

Minimalna i maksimalna površina armature:

$$A_{s1,\min} = 0.1\% b h = 0.001 \cdot 100 \cdot 20 = 2,0 \text{ cm}^2$$

$$A_{s1,\max} = 2.0\% b h = 0.020 \cdot 100 \cdot 20 = 40 \text{ cm}^2$$

Dimenzioniranje:

Donja zona (pozitivni moment savijanja) $\rightarrow M_{Ed,\max} = 4,5 \text{ kNm}$

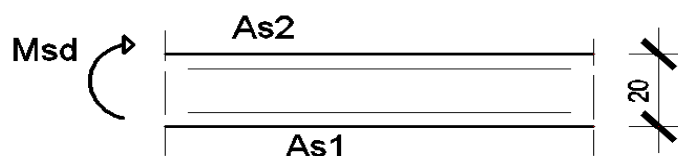

Slika 16: Skica položaja armature u donjoj zoni ploče

$$C 30/37 \quad f_{cd} = \frac{f_{ck}}{\gamma_c} = \frac{30}{1.5} = 20.0 \text{ MPa}; \quad f_{cd} = 2.0 \text{ kN/cm}^2$$

$$B 500 \quad f_{yd} = \frac{f_{yk}}{\gamma_s} = \frac{500}{1.15} = 435 \text{ MPa}; \quad f_{yd} = 43.5 \text{ kN/cm}^2$$

Mreža	Površina	Moment nosivosti čelika	Moment nosivosti betona	Postotak armiranosti presjeka
	cm ² /m ³	MEd,s,lim kNm	MEd,c,lim kNm	
Q-166	1,66	10,94	91,90	0,08
Q-188	1,88	12,40	91,90	0,09
Q-196	1,96	12,92	91,90	0,10
Q-226	2,26	14,90	91,90	0,11
Q-257	2,57	16,94	91,90	0,13
Q-283	2,83	18,66	91,90	0,14
Q-335	3,35	22,09	91,90	0,17
Q-385	3,85	25,38	91,90	0,19
Q-424	4,24	27,96	91,90	0,21

Tablica 1: Momenti nosivosti za odabranu mrežastu armaturu i betonski presjek

-odabrana mreža Q – 226 ($A_s = 2,26 \text{ cm}^2$)

Gornja zona (negativni moment savijanja) $\rightarrow M_{Ed,min} = -6,0kNm$

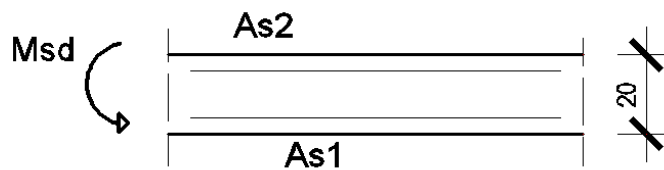

Slika 17: Skica položaja armature u gornjoj zoni ploče

Mreža	Površina cm ² /m'	Moment nosivosti čelika	Moment nosivosti betona	Postotak armiranosti presjeka
		MEd,s,lim kNm	MEd,c,lim kNm	
Q-166	1,66	10,94	91,90	0,08
Q-188	1,88	12,40	91,90	0,09
Q-196	1,96	12,92	91,90	0,10
Q-226	2,26	14,90	91,90	0,11
Q-257	2,57	16,94	91,90	0,13
Q-283	2,83	18,66	91,90	0,14
Q-335	3,35	22,09	91,90	0,17
Q-385	3,85	25,38	91,90	0,19
Q-424	4,24	27,96	91,90	0,21

Tablica 1: Momenti nosivosti za odabranu mrežastu armaturu i betonski presjek

-odabrana mreža Q – 226 ($A_s = 2,26\text{cm}^2$)



Ploče 002 i 003 se armiraju u gornjoj i donjoj zoni sa Q – 257 ($A_s = 2,57\text{cm}^2$)

9. PRORAČUN MEĐUETAŽNE KONSTRUKCIJE (šuplje ploče)

POZICIJA 101

9.1 Odabir šuplje ploče

-Priložena stranica je iz kataloga proizvođača „Obendorfer“ sa tipovima šupljih ploča ovisno o rasponu i opterećenju. Odabrana je ploča VSD – 4 – 50 –C.

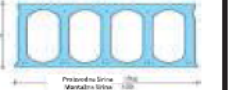
Svijetli raspon							Svijetli raspon
	VSD-4-40-B	VSD-4-40-C	VSD-4-45-B	VSD-4-45-C	VSD-4-50-B	VSD-4-50-C	
7,5							7,5
8,0	25,2	30,6					8,0
8,5	21,9	28,4					8,5
9,0	19,1	24,9	28,8	34,6			9,0
9,5	16,7	22,0	25,4	30,6			9,5
10,0	14,7	19,4	22,5	27,2	34,5	39,1	10,0
10,5	12,9	17,2	19,9	24,2	30,8	34,9	10,5
11,0	11,4	15,3	17,7	21,6	27,6	31,3	11,0
11,5	10,1	13,7	15,8	19,4	24,8	28,2	11,5
12,0	8,9	12,2	14,1	17,4	22,3	25,5	12,0
12,5	7,9	10,9	12,6	15,6	20,1	23,0	12,5
13,0	6,9	9,8	11,3	14,1	18,2	20,9	13,0
13,5	6,1	8,8	10,1	12,7	16,4	18,9	13,5
14,0	5,4	7,8	9,0	11,5	14,9	17,2	14,0
14,5		7,0	8,1	10,3	13,5	15,6	14,5
15,0		6,3	7,2	9,3	12,2	14,2	15,0
15,5		5,6	6,4	8,4	11,1	13,0	15,5
16,0		5,0	5,7	7,6	10,0	11,8	16,0
16,5			5,1	6,8	9,1	10,8	16,5
17,0				6,1	8,2	9,8	17,0
17,5				5,5	7,4	8,9	17,5
18,0					6,7	8,1	18,0
18,5					6,0	7,4	18,5
19,0					5,4	6,7	19,0
19,5						6,0	19,5
20,0						5,5	20,0
20,5							20,5
9FT	4,80		6,00		6,50		kN/m ²
g ₁	5,20		6,45		7,00		kN/m ²
Zalijevanje	19,0		20,0		21,0		l/m ²
Beton	C55/67						Beton
Dubina ležaja	15 cm						Dubina ležaja

Dopušteno opterećenje q za međukatnu konstrukciju (kN/m²) za karakteristične utjecaje $q = g_2 + q_1$ (usvojeno dodatno stalno $g_2 = 2,0$ kN/m², $\psi_1 = 0,5$, $\psi_2 = 0,3$)

Raspon ploče: $l=16,0\text{m}$

Stalno dodatno opterećenje: $\Delta g = 3,2 \text{ kN} / \text{m}^2$

Pokretno opterećenje: $q = 7,0 \text{ kN} / \text{m}^2$

$q_{UK} = 10,2 \text{ kN} / \text{m}^2$ - ukupno opterećenje

Odabrani tip ploče:

2.1.2.5 specifikacijski list VSD

Tip: VSD-4-50-C

Vrsta betona: C55/67/B4
 Prednapeti čelik: ST-1570/1770
 Gore: $2 \times 1/2''$ šipke = $2,00 \text{ cm}^2$
 Dolje: $21 \times 1/2''$ šipke = $21,00 \text{ cm}^2$
 Prednapinjanje: $1100\text{N}/\text{mm}^2$

Vlastita težina bez betona za zaljevanje: $6,30 \text{ kN}/\text{m}^2$
 Beton za zaljevanje: $21,00 \text{ l}/\text{m}^2$

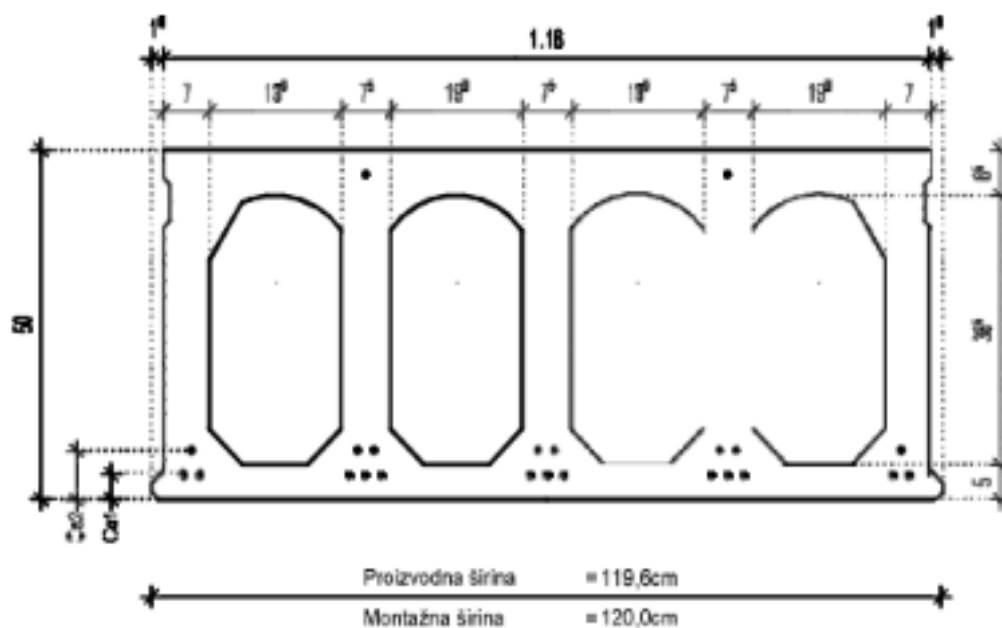

c_{q1} -Os šipke - 1. položaj = 3,5cm

c_{q2} -Os šipke - 2. položaj = 7,0cm

9.2 Međukatni T-nosač G5-G8

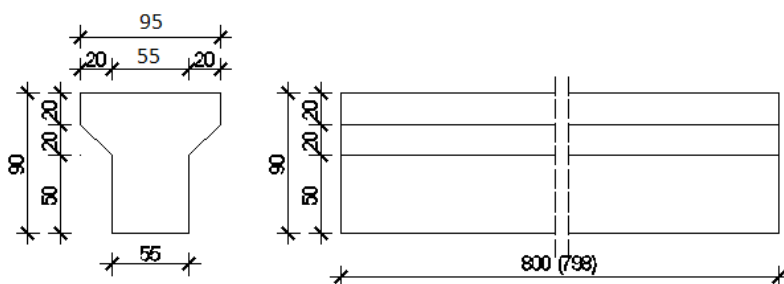

$h=80$ cm

$L_{1n}=850-50-2=798$ cm

$A=6150$ cm²=0,62 m²

$$A_{nosac} = 0,62 \text{ m}^2$$

$$\gamma_b = 25 \text{ kN/m}^3$$

Materijal:

Beton:

C 50/67

Čelik:

B 500

9.2.1 Analiza opterećenja

-Vlastita težina nosača: $g_n = 0,62 \cdot 25 = 15,5 \text{ kN/m}$

-Težina šuplje ploče: $g_{pl} = w_{T2} = 6,3 \text{ kN/m}^2 = 6,3 \cdot 16,0 = 100,8 \text{ kN/m}$

-Težina betona za monolitizaciju iznad nosača: $g_b = (0,1 \cdot 16) \cdot 25 = 40 \text{ kN/m}$

-Stalno dodatno opterećenje: $\Delta g = 3,2 \text{ kN/m}^2 = 3,2 \cdot 16,0 = 51,2 \text{ kN/m}$

-Pokretno opterećenje: $q = q_u = 7,0 \text{ kN/m}^2 = 7,0 \cdot 16,0 = 112 \text{ kN/m}$

9.2.2 1. faza

-ukupno stalno opterećenje:

$$q = g_{pl} + g_n + g_b = 100,8 + 15,5 + 40 = 155,3 \text{ kN/m}$$

9.2.2.1 Rezne sile

-statički sustav

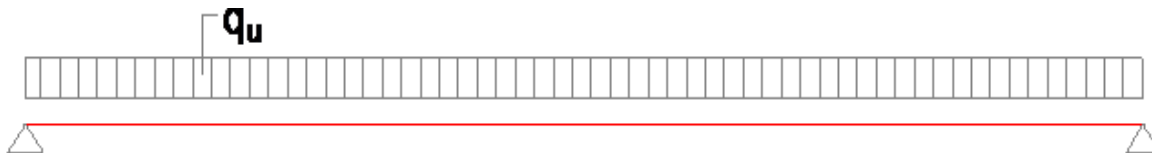

Slika 18: Prikaz statičkog sustava prve faze

Moment savijanja u polju:

$$M_{sd} = 1.35 \cdot \frac{q \cdot l_n^2}{8} = 1.35 \cdot \frac{155,3 \cdot 7,98^2}{8} = 1668,86 \text{ kNm}$$

Poprečna sila na ležaju:

$$V_{sd} = 1.35 \cdot \frac{g \cdot l_n}{2} = 1.35 \cdot \frac{155,3 \cdot 7,98}{2} = 836,5 \text{ kN}$$

9.2.3 Dimenzioniranje na moment savijanja

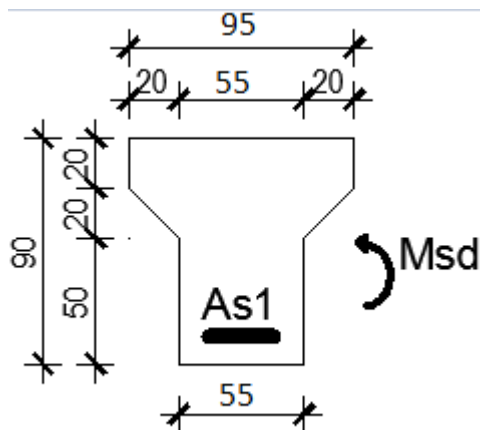

$$M_{sd} = 1652,75 \text{ kNm}$$

$$h = 90 \text{ cm}$$

$$d_1 = 10 \text{ cm}$$

$$d = 80 \text{ cm}$$

$$C 50 / 67 \quad f_{cd} = \frac{f_{ck}}{\gamma_s} = \frac{50}{1.5} = 33,33 \text{ MPa} = 3,33 \text{ kN / cm}^2$$

$$B 500 \quad f_{yd} = \frac{f_{yk}}{\gamma_s} = \frac{500}{1.15} = 434,8 \text{ MPa} = 43,48 \text{ kN / cm}^2$$

$$\mu_{sd} = \frac{M_{sd}}{bd^2 f_{cd}} = \frac{1668,86 \cdot 100}{95 \cdot 80^2 \cdot 3,3} = 0,088$$

$$\text{za } \varepsilon_{s1} = 10\text{‰}, \quad \varepsilon_{c2} = 2,0\text{‰}, \quad \zeta = 0,938,$$

$$\xi = 0,167$$

$$A_{s1} = \frac{M_{sd}}{\zeta \cdot d \cdot f_{yd}} = \frac{1668,86 \cdot 100}{0,938 \cdot 80 \cdot 43,48} = 51,15 \text{ cm}^2$$

Odabrano: 14Φ22 ($A_s = 53,22 \text{ cm}^2$)

Armatura je zbog pukotina smanjena na profile 17Φ20 ($A_s = 53,83 \text{ cm}^2$). (2 reda)

9.2.4 Dimenzioniranje na poprečnu silu

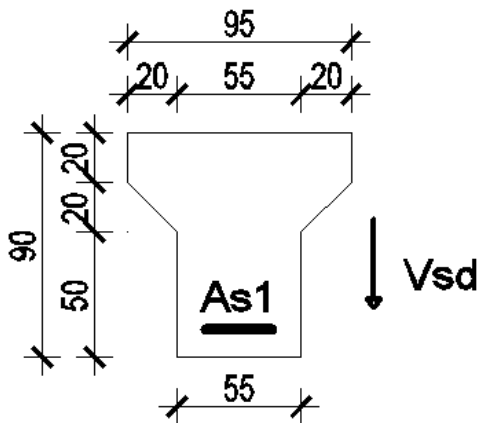

$$V_{Ed} = 836,5 \text{ kN}$$

- beton: **C50/67**

$$f_{ck} = 50 \text{ MPa}$$

$$f_{cd} = 50 / 1,5 = 33,33 \text{ MPa}$$

-armatura : **B 500**

$$f_{yk} = 500 \text{ MPa}$$

$$f_{yd} = 500 / 1,15 = 434,80 \text{ MPa}$$

$$\Sigma A_s = 58,9 \text{ cm}^2 \rightarrow 12\Phi 25$$

$$\rho_l = \frac{\Sigma A_s}{A_c} = \frac{53,22}{6150} = 0,00865$$

Dio poprečne sile koju presjek preuzima bez poprečne armature:

$$V_{Rd,C} = \left[C_{RdC} \cdot k \cdot (100 \cdot \rho_l \cdot f_{ck})^{\frac{1}{3}} + k_1 \cdot \sigma_{cp} \right] \cdot b_w \cdot d$$

$$k = 1,0 + \sqrt{\frac{200}{d}} = 1,0 + \sqrt{\frac{200}{800}} = 1,5 < 2,0$$

$$k_1 = 0,15$$

$$\sigma_{cp} = N_{sd} / A_c = 0,0$$

$$C_{RdC} = \frac{0,18}{\gamma_c} = 0,12$$

$$V_{Rd,C} = \left[0,12 \cdot 1,5 \cdot (100 \cdot 0,00865 \cdot 50)^{\frac{1}{3}} + 0,15 \cdot 0,0 \right] \cdot 550 \cdot 800 = 278,0 \text{ kN}$$

$V_{Rd,C}$, mora bit veće od:

$$V_{Rd,C} \geq \left[v_{\min} + k_1 \cdot \sigma_{cp} \right] \cdot b_w \cdot d$$

$$k_1 = 0,15$$

$$v_{\min} = 0,035 \cdot k^{\frac{3}{2}} \cdot f_{ck}^{\frac{1}{2}} = 0,035 \cdot 1,5^{\frac{3}{2}} \cdot 50^{\frac{1}{2}} = 0,45$$

$$\sigma_{cp} = N_{sd} / A_c = 0,0$$

$$V_{Rd,C} = 278,0 \text{ kN} > [0,45 + 0] \cdot 550 \cdot 800 = 198 \text{ kN}$$

$$V_{Rd,C} = 278,0 \text{ kN} < V_{Ed,max} = 836,5 \text{ kN}$$

Maksimalna poprečna sila koju se ne smije prijeći (dio poprečne sile koje mogu preuzeti tlačne dijagonale):

$$V_{Rd,max} = 0,5 \cdot \nu \cdot b_w \cdot d \cdot f_{cd}$$

$$\nu = 0,6 \left[1,0 - \frac{f_{ck}}{250} \right] = 0,6 \left[1,0 - \frac{50}{250} \right] = 0,48$$

$$V_{Rd,max} = 0,5 \cdot 0,48 \cdot 550 \cdot 800 \cdot 33,3 = 3196,8kN > V_{Ed,max} = 836,5kN$$

$$\frac{V_{Ed,max}}{V_{Rd,max}} = \frac{836,5}{3196,8} = 0,26$$

$$V_{Ed} = 0,26 \cdot V_{Rd,max}$$

$$s_{max} = \min \{0,6d; 30cm\} = \min \{48cm; 30cm\} = 30cm$$

$$\rho_{min} = 0,0013(C50 / 67)$$

$$\max .razmak : s \leq \frac{m \cdot A_{sw}}{\rho_{min} \cdot b_w} = \frac{2 \cdot 0,79}{0,0013 \cdot 55} = 22,09cm \rightarrow \Phi 10$$

Nosivost vilica za maksimalni razmak (20cm)

$$f_{ywd} = \frac{f_{yk}}{\gamma_s} = \frac{500}{1,15} = 434,8Mpa$$

$$V_{Rd} = V_{Rd,S} = \frac{A_{sw}}{s} \cdot z \cdot f_{ywd} \cdot m \cdot ctg \Theta$$

$$V_{Rd} = V_{Rd,S} = \frac{0,79}{20} \cdot (0,9 \cdot 80) \cdot 43,48 \cdot 2 \cdot 1 = 247,31kN$$

$$V_{Ed} = 836,5kN > V_{Rd} = 247,31kN$$

Kontroliramo nosivost betona:

$$V_{Rd,max} = \frac{\alpha_{cw} \cdot b_w \cdot z \cdot \nu_1 \cdot f_{cd}}{\tan \theta + ctg \theta} = \frac{1,0 \cdot 550 \cdot (0,9 \cdot 800) \cdot 0,6 \cdot 50}{\tan 45 + ctg 45} = 5940kN$$

$$V_{Rd,max} = 5940kN > V_{Ed,max} = 836,5kN$$

Potrebna kosa armatura za preuzimanje računске poprečne sile

$$A_{s,w} \leq \frac{s \cdot V_{Ed,s}}{z \cdot f_{yd} \cdot (ctg \theta + ctg \alpha) \cdot \sin \alpha} = \frac{836,5 \cdot 100}{0,9 \cdot 80 \cdot 43,48 \cdot (1,0 + 1,0) \cdot 1,0} = 13,36cm$$

Odabrane spone $\varnothing 10/20$ cm, $m=2$, $A_{sw}=1,13\text{cm}^2$ + kosa armatura $4\varnothing 20$ $A_{sw}=12,57\text{cm}^2$,
armatura B 500

9.2.5 2. faza

-ukupno stalno opterećenje:

$$\Delta g = 3,2 \text{ kN} / \text{m}^2 = 3,2 \cdot 16,0 = 51,2 \text{ kN} / \text{m}$$

-ukupno korisno opterećenje:

$$q_k = 7,0 \text{ kN} / \text{m}^2 = 7,0 \cdot 16,0 = 112 \text{ kN} / \text{m}$$

9.2.5.1 Rezne sile

-statički sustav

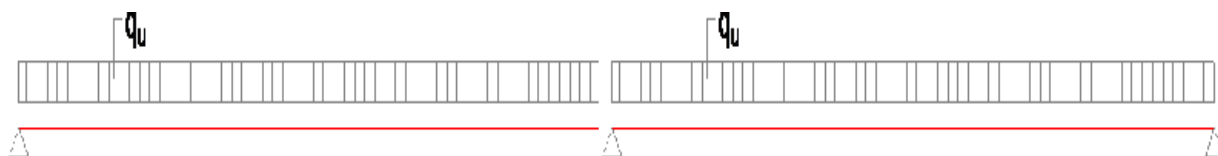

Slika 19: Prikaz statičkog sustava druge faze

Moment savijanja u polju:

$$M_{sd} = 1,35 \cdot 0,07 \cdot q \cdot l_n^2 + 1,5 \cdot 0,07 \cdot q_k \cdot l_n^2 = 1,35 \cdot 0,07 \cdot 51,2 \cdot 7,98^2 + 1,5 \cdot 0,07 \cdot 112 \cdot 7,98^2 = 1056,99 \text{ kNm}$$

Moment savijanja na ležaju:

$$M_{sd} = 1,35 \cdot (-0,106 \cdot q \cdot l_n^2) + 1,5 \cdot (-0,106 \cdot q_k \cdot l_n^2) = 1,35 \cdot (-0,106 \cdot 51,2 \cdot 7,98^2) + 1,5 \cdot (-0,106 \cdot 112 \cdot 7,98^2)$$

$$M_{sd} = -1600,6 \text{ kNm}$$

Poprečna sila na ležaju:

$$V_{sd} = 1,35 \cdot (1,130 \cdot q \cdot l_n) + 1,5 \cdot (1,130 \cdot q_k \cdot l_n) = 1,35 \cdot (1,130 \cdot 51,2 \cdot 7,98) + 1,5 \cdot (1,130 \cdot 112 \cdot 7,98)$$

$$V_{sd} = 2138,21 / 2 = 1069,1 \text{ kN}$$

Poprečna sila na kraju:

$$V_{sd} = 1,35 \cdot (0,375 \cdot q \cdot l_n) + 1,5 \cdot (0,375 \cdot q_k \cdot l_n) = 1,35 \cdot (0,375 \cdot 51,2 \cdot 7,98) + 1,5 \cdot (0,375 \cdot 112 \cdot 7,98)$$

$$V_{sd} = 747,42 \text{ kN}$$

9.2.6 Dimenzioniranje na moment savijanja (polje)

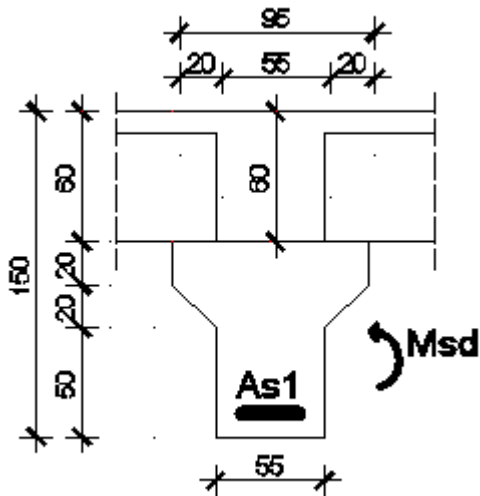

$$M_{sd} = 1056,99 \text{ kNm}$$

$$h = 150 \text{ cm}$$

$$d_1 = 10 \text{ cm}$$

$$d = 140 \text{ cm}$$

$$C 50 / 67 \quad f_{cd} = \frac{f_{ck}}{\gamma_s} = \frac{50}{1.5} = 33,33 \text{ MPa} = 3,33 \text{ kN / cm}^2$$

$$B 500 \quad f_{yd} = \frac{f_{yk}}{\gamma_s} = \frac{500}{1.15} = 434,8 \text{ MPa} = 43,48 \text{ kN / cm}^2$$

$$\mu_{sd} = \frac{M_{sd}}{bd^2 f_{cd}} = \frac{1056,99 \cdot 100}{55 \cdot 140^2 \cdot 3,3} = 0,033$$

$$\text{za } \varepsilon_{s1} = 10\text{‰}, \quad \varepsilon_{c2} = 1,1\text{‰}, \quad \zeta = 0,969, \quad \xi = 0,099$$

$$A_{s1} = \frac{M_{sd}}{\zeta \cdot d \cdot f_{yd}} = \frac{1056,99 \cdot 100}{0,965 \cdot 140 \cdot 43,48} = 17,99 \text{ cm}^2$$

Odabrano: 5Φ22 ($A_s = 19,01 \text{ cm}^2$)

Armatura je zbog velikih pukotina smanjena na profile 7Φ20 ($A_s = 21,99 \text{ cm}^2$)

9.2.7 Dimenzioniranje na moment savijanja (ležaj)

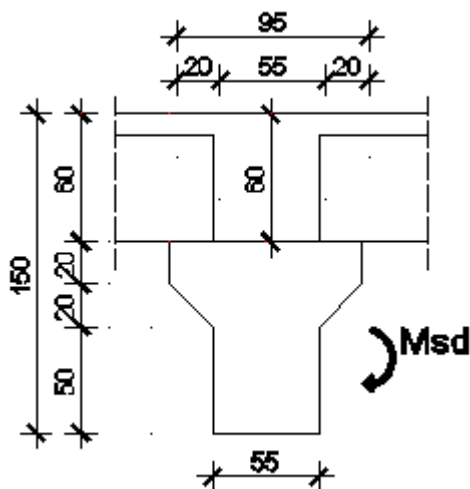

$$M_{sd} = 1600,6 \text{ kNm}$$

$$h = 150 \text{ cm}$$

$$d_1 = 10 \text{ cm}$$

$$d = 140 \text{ cm}$$

$$C 50 / 67 \quad f_{cd} = \frac{f_{ck}}{\gamma_s} = \frac{50}{1.5} = 33,33 \text{ MPa} = 3,33 \text{ kN / cm}^2$$

$$B 450C \quad f_{yd} = \frac{f_{yk}}{\gamma_s} = \frac{500}{1.15} = 434,8 \text{ MPa} = 43,48 \text{ kN / cm}^2$$

$$\mu_{sd} = \frac{M_{sd}}{bd^2 f_{cd}} = \frac{1600,6 \cdot 100}{55 \cdot 140^2 \cdot 3,3} = 0,049$$

$$za \quad \varepsilon_{s1} = 10\text{‰}, \quad \varepsilon_{c2} = 1,4\text{‰}, \quad \zeta = 0,958,$$

$$\xi = 0,123$$

$$A_{s1} = \frac{M_{sd}}{\zeta \cdot d \cdot f_{yd}} = \frac{1600,6 \cdot 100}{0,958 \cdot 140 \cdot 43,48} = 27,44 \text{ cm}^2$$

Odabrano: 9Φ20 ($A_s = 28,27 \text{ cm}^2$)

9.2.8 Dimenzioniranje na poprečnu silu

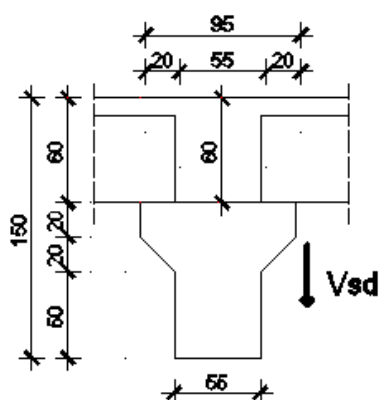

$$V_{Ed} = 1069,1 \text{ kN}$$

- beton: **C50/67**

$$f_{ck} = 50 \text{ MPa}$$

$$f_{cd} = 50/1,5 = 33,33 \text{ Mpa}$$

-armatura : **B 500**

$$f_{yk} = 500 \text{ MPa}$$

$$f_{yd} = 500/1,15 = 434,8 \text{ Mpa}$$

$$\Sigma A_s = 72,23 \text{ cm}^2 \rightarrow 14\Phi 22 + 5\Phi 22$$

$$\rho_l = \frac{\Sigma A_s}{A_c} = \frac{72,23}{12250} = 0,00589$$

Dio poprečne sile koju presjek preuzima bez poprečne armature:

$$V_{Rd,C} = \left[C_{RdC} \cdot k \cdot (100 \cdot \rho_l \cdot f_{ck})^{\frac{1}{3}} + k_1 \cdot \sigma_{cp} \right] \cdot b_w \cdot d$$

$$k = 1,0 + \sqrt{\frac{200}{d}} = 1,0 + \sqrt{\frac{200}{1400}} = 1,38 > 2,0 \Rightarrow k = 1,38$$

$$k_1 = 0,15$$

$$\sigma_{cp} = N_{sd} / A_c = 0,0$$

$$C_{RdC} = \frac{0,18}{\gamma_c} = 0,12$$

$$V_{Rd,C} = \left[0,12 \cdot 1,37 \cdot (100 \cdot 0,00589 \cdot 50)^{\frac{1}{3}} + 0,15 \cdot 0,0 \right] \cdot 550 \cdot 1400 = 390,9 \text{ kN}$$

$V_{Rd,C}$, mora biti veće od:

$$V_{Rd,C} \geq [v_{\min} + k_1 \cdot \sigma_{cp}] \cdot b_w \cdot d$$

$$k_1 = 0,15$$

$$v_{\min} = 0,035 \cdot k^{\frac{3}{2}} \cdot f_{ck}^{\frac{1}{2}} = 0,035 \cdot 1,38^{\frac{3}{2}} \cdot 50^{\frac{1}{2}} = 0,40$$

$$\sigma_{cp} = N_{sd} / A_c = 0,0$$

$$V_{Rd,C} = 390,9kN > [0,4 + 0] \cdot 550 \cdot 1400 = 308kN$$

$$V_{Rd,C} = 390,9kN < V_{Ed,max} = 1069,1kN$$

Maksimalna poprečna sila koju se ne smije prijeći (dio poprečne sile koje mogu preuzeti tlačne dijagonale):

$$V_{Rd,max} = 0,5 \cdot v \cdot b_w \cdot d \cdot f_{cd}$$

$$v = 0,6 \left[1,0 - \frac{f_{ck}}{250} \right] = 0,6 \left[1,0 - \frac{50}{250} \right] = 0,48$$

$$V_{Rd,max} = 0,5 \cdot 0,48 \cdot 550 \cdot 1400 \cdot 50 = 8400kN > V_{Ed,max} = 1069,1kN$$

$$\frac{V_{Ed,max}}{V_{Rd,max}} = \frac{1069,1}{8400} = 0,13$$

$$V_{Ed} = 0,13 \cdot V_{Rd,max}$$

$$s_{\max} = \min \{0,8d; 30cm\} = \min \{112cm; 30cm\} = 30cm$$

$$\rho_{\min} = 0,0013(C50 / 67)$$

$$\max .razmak : s \leq \frac{m \cdot A_{sw}}{\rho_{\min} \cdot b_w} = \frac{2 \cdot 0,79}{0,0013 \cdot 55} = 22,0cm \rightarrow \Phi 10$$

Nosivost vilica za maksimalni razmak (24cm)

$$f_{ywd} = \frac{f_{yk}}{\gamma_s} = \frac{500}{1,15} = 434,8Mpa$$

$$V_{Rd} = V_{Rd,S} = \frac{A_{sw}}{s} \cdot z \cdot f_{ywd} \cdot m \cdot ctg \Theta$$

$$V_{Rd} = V_{Rd,S} = \frac{0,79}{22} \cdot (0,9 \cdot 140) \cdot 43,48 \cdot 2 \cdot 1 = 360,66kN$$

$$V_{Ed} = 1069,1kN > V_{Rd} = 360,66kN$$

Kontroliramo nosivost betona:

$$V_{Rd,max} = \frac{\alpha_{cw} \cdot b_w \cdot z \cdot v_1 \cdot f_{cd}}{\tan \theta + ctg \theta} = \frac{1,0 \cdot 550 \cdot (0,9 \cdot 1400) \cdot 0,6 \cdot 50}{\tan 45 + ctg 45} = 10395 kN$$

$$V_{Rd,max} = 10395 kN > V_{Ed,max} = 1069,1 kN$$

Potrebna kosa armatura za preuzimanje računске poprečne sile

$$A_{s,w} \leq \frac{s \cdot V_{Ed,s}}{z \cdot f_{yd} \cdot (ctg \theta + ctg \alpha) \cdot \sin \alpha} = \frac{1069,1 \cdot 100}{0,9 \cdot 140 \cdot 43,48 \cdot (1,0 + 1,0) \cdot 1,0} = 9,75 cm$$

Odabrane sponе $\varnothing 10/20$ cm, $m=2$, $A_{sw}=1,13 cm^2$ + kosa armatura $3\varnothing 20$ $A_{sw}=9,42 cm^2$,
armatura B 500

9.2.9 Dimenzioniranje kratke konzole na međukatnom T nosaču

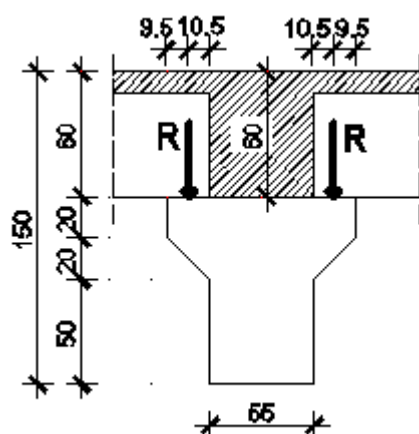

- beton: **C50/67**

$$f_{ck}=50 MPa$$

$$f_{cd}=50/1,5= 33,33 MPa$$

-armatura : **B 500**

$$f_{yk}=500 MPa$$

$$f_{yd}=500/1,15 = 434,8 MPa$$

Analiza opterećenja:

-Težina šuplje ploče: $g_{pl} = w_{T2} = 6,3 kN / m^2 = 6,3 \cdot \frac{16,0}{2,0} = 50,4 kN / m$

-Težina toppinga: $g_t = 2,5 kN / m^2 = 2,5 \cdot \frac{16,0}{2,0} = 20 kN / m$

-Stalno dodatno opterećenje: $\Delta g = 3,2 kN / m^2 = 3,2 \cdot \frac{16,0}{2} = 25,6 kN / m$

-Pokretno opterećenje: $q = q_u = 7,0 kN / m^2 = 7,0 \cdot \frac{16,0}{2} = 56 kN / m$

-ukupno stalno opterećenje:

$$g = g_{pl} + g_t + \Delta g = 50,4 + 20 + 25,6 = 96 \text{ kN} / m$$

-ukupno promjenjivo opterećenje:

$$q = 56 \text{ kN} / m$$

Reakcija šuplje ploče:

$$R = 1.35 \cdot g + 1.5 q = 1.35 \cdot 96 + 1.5 \cdot 56 = 213,6 \text{ kN} / m'$$

Moment savijanja:

$$M_{sd} = 0,105 \cdot R_n = 0,105 \cdot 213,6 = 22,43 \text{ kNm} / m$$

$$A_{s1} = \frac{M_{sd}}{0,8 \cdot d \cdot f_{yd}} = \frac{22,43 \cdot 100}{0,8 \cdot 30 \cdot 43,48} = 2,15 \text{ cm}^2 / m$$

Odabrano: $\Phi 10/20$ ($A_s = 5 \times 0,79 \text{ cm}^2$)

Otpornost na poprečnu silu:

$$V_{Ed} = \mu \cdot A_{sw} \cdot f_{yd} = 1,4 \cdot (0,79 \cdot 2 \cdot 5) \cdot 43,48 = 480,89 \text{ kN}$$

Vidljivo je da vilice T nosača imaju dostatnu nosivost na posmik te nije potrebna dodatna armatura.

$$F_c = \frac{R}{\sin \alpha} = \frac{186,6}{\sin 45^\circ} = 263,89 \text{ kN}$$

$$\sigma_c = \frac{F_c}{c \cdot b_{konz}} = \frac{263,89}{(0,2 \cdot 55) \cdot 100}$$

$$\sigma_c = 0,3 \text{ kN} / \text{cm}^2 \leq 0,45 \cdot f_{ck} = 2,25 \text{ kN} / \text{cm}^2$$

9.2.10 Kontrola pukotina greda

Granična širina pukotina prema EC-2 za uobičajenu sredinu iznosi $w_g = 0,3 \text{ mm}$. Odabrana vlačna armatura za polje je $7\Phi 20$ ($A_s = 21,99 \text{ cm}^2$) + $17\Phi 20$ ($A_s = 53,83 \text{ cm}^2$).

$M_{Ed,2-2} = 722,36 + 1236,19 \text{ kNm}$ - za granično stanje uporabljivosti

$b = 55 \text{ (cm)}$; $h = 150 \text{ (cm)}$; $d_1 = 10 \text{ (cm)}$; $d = 140 \text{ (cm)}$

Prognoza širine pukotina:

$$w_k = s_{r \max} \cdot (\varepsilon_{sm} - \varepsilon_{cm})$$

Proračun srednje deformacije armature:

$$\varepsilon_{sm} - \varepsilon_{cm} = \frac{\sigma_s - k_t \frac{f_{ct,eff}}{\rho_{p,eff}} (1 + \alpha_e \cdot \rho_{p,eff})}{E_s} \geq 0,6 \frac{\sigma_s}{E_s}$$

$$x = \frac{\alpha_{el} \cdot A_{s1}}{b} \cdot \left(-1 + \sqrt{1 + \frac{2 \cdot b \cdot d}{\alpha_{el} \cdot A_{s1}}} \right) = \frac{5,41 \cdot 75,82}{55} \cdot \left(-1 + \sqrt{1 + \frac{2 \cdot 55 \cdot 140}{5,41 \cdot 75,82}} \right) = 38,4 (cm)$$

$$\sigma_s = \frac{M_{Ed}}{z \cdot A_s} \approx \frac{M_{Ed}}{\left(d - \frac{x}{3} \right) \cdot A_s} = \frac{1958,55 \cdot 100}{\left(140 - \frac{38,4}{3} \right) \cdot 75,82} = 20,86 \left(\frac{kN}{cm^2} \right) = 208,6 (MPa)$$

$k_t = 0.4$ – Dugotrajno opterećenje

$E_s = 200.0$ GPa- modul elastičnosti armature

$E_{cm} = 32.80$ GPa- modul elastičnosti betona

Za C 50/67 $\rightarrow f_{ct,eff} = f_{ctm} = 4,1$ MPa

$$\alpha_e = \frac{E_s}{E_{cm}} = \frac{200}{37} = 5,41 \text{ - Odnos modula elastičnosti}$$

$$\rho_l = \frac{\Sigma A_s}{A_c} = \frac{75,82}{7700} = 0,00958 \text{ - Djelotvorni koeficijent armiranja glavnom vlačnom}$$

armaturom

$$\varepsilon_{sm} - \varepsilon_{cm} = \frac{208,6 - 0,4 \frac{4,1}{0,00958} (1 + 5,41 \cdot 0,00958)}{200000} \geq 0,6 \frac{208,6}{200000}$$

$$\frac{28,53}{200000} \geq \frac{125,16}{200000}$$

$$\varepsilon_{sm} - \varepsilon_{cm} = \frac{125,16}{200000} = 0,000626$$

Srednji razmak pukotina

$$s_{rmax} = k_3 \cdot c + k_1 \cdot k_2 \cdot k_4 \cdot \frac{\phi}{\rho_{p,eff}} (mm)$$

$\Phi = 18$ mm – Promjer najdeblje šipke

$c = 30$ mm – Zaštitni sloj uzdužne armature

$k_1 = 0.8$ – Rebrasta armatura

$k_2 = 0.5$ – Savijanje

$k_3 = 3.4$

$k_4 = 0.425$

$$s_{r_{\max}} = 3,4 \cdot 30 + 0,8 \cdot 0,5 \cdot 0,425 \cdot \frac{20}{0,00958} = 456 \text{ (mm)}$$

$$w_k = s_{r_{\max}} \cdot (\varepsilon_{sm} - \varepsilon_{cm}) = 456 \cdot 0,000626 = 0,286 \text{ mm} < 0,30 \text{ mm}$$

Odabrana armatura zadovoljava u pogledu širine pukotina

9.2.11 Kontrola progiba grede

Maksimalan progib očekuje se u vanjskim poljima:

$$M_{1-1} = 0,0 \text{ kNm}$$

$$M_{2-2} = 1958,55 \text{ kNm} \quad \text{kombinacija za GSU}$$

$$M_{3-3} = -1101 \text{ kNm}$$

$$A_{s2} = 24 \varnothing 20 = 75,82 \text{ cm}^2$$

$$A_{s3} = 9 \varnothing 20 = (A_s = 28,27 \text{ cm}^2)$$

Progib bez utjecaja puzanja!

Granični progib:

$$v_{\text{lim}} = \frac{L}{250} = \frac{800}{250} = 3,2 \text{ cm}$$

Beton: C 50/67; $f_{ck} = 50,0 \text{ MPa}$

$$E_{cm} = 9500 \cdot \sqrt[3]{f_{ck} + 8} = 9500 \cdot \sqrt[3]{50 + 8} \approx 36773 \text{ MPa}$$

$$f_{ct,m} = 0,3 \cdot (f_{ck})^{2/3} = 0,3 \cdot (50,0)^{2/3} = 4,07 \text{ MPa}$$

Čelik: B500B; $E_s = 200,0 \text{ GPa}$

$$\alpha_e = \frac{E_s}{E_{cm}} = \frac{200}{37} = 5,41$$

$$v_{\text{tot}} = k \cdot L^2 \cdot \frac{1}{r_{\text{tot}}}$$

$$\beta = |M_{1-1} + M_{3-3}| / |M_{2-2}| = |0,0 + 1101| / |1958,55| = 0,56$$

$$k = \frac{5}{48} \cdot (1 - 0,1 \cdot \beta) = 0,104 \cdot (1 - 0,1 \cdot 0,56) = 0,098$$

Srednja zakrivljenost u neraspucalom stanju:

$$\begin{aligned}
 I_I &= \frac{bh^3}{12} + \alpha_{el} \cdot \left[A_{s1} \cdot \left(\frac{h}{2} - d_2 \right)^2 + A_{s2} \cdot \left(\frac{h}{2} - d_1 \right)^2 \right] \\
 &= \frac{55 \cdot 150^3}{12} + 5,41 \cdot \left[28,27 \cdot \left(\frac{150}{2} - 10 \right)^2 + 75,82 \cdot \left(\frac{150}{2} - 10 \right)^2 \right] = \\
 &= 17847961,15 \text{ cm}^4
 \end{aligned}$$

$$M_{Ed} = M_{2-2} = 1958,55 \text{ kNm}$$

$$E_{c,eff} = E_{cm} = 37,0 \text{ GN/m}^2 = 3700,0 \text{ kN/cm}^2$$

$$\frac{1}{r_I} = \frac{M_{Ed}}{E_{c,eff} \cdot I_I} = \frac{1958,55 \cdot 100}{3700,0 \cdot 17847961} = 0,00000297 \frac{1}{\text{cm}}$$

$$x = \frac{\alpha_{el} \cdot A_{s1}}{b} \cdot \left(-1 + \sqrt{1 + \frac{2 \cdot b \cdot d}{\alpha_{el} \cdot A_{s1}}} \right) = \frac{5,41 \cdot 75,82}{55} \cdot \left(-1 + \sqrt{1 + \frac{2 \cdot 55 \cdot 140}{5,41 \cdot 75,82}} \right) = 38,84 \text{ (cm)}$$

Srednja zakrivljenost u raspucalom stanju:

$$\begin{aligned}
 I_{II} &= \frac{bx^3}{12} + bx \cdot \left(\frac{x}{2} \right)^2 + \alpha_{el} \cdot \left[A_{s1} \cdot (d - x)^2 + A_{s2} \cdot (x - d_2)^2 \right] \\
 &= \frac{55 \cdot 38,84^3}{12} + (55 \cdot 38,84) \cdot \left(\frac{38,84}{2} \right)^2 + 5,41 \cdot \left[75,82 \cdot (140 - 38,84)^2 + 28,27 \cdot (38,84 - 10)^2 \right] \\
 &= 5398303 \text{ cm}^4
 \end{aligned}$$

$$\frac{1}{r_{II}} = \frac{M_{Ed}}{E_{c,eff} \cdot I_{II}} = \frac{1958,55 \cdot 100}{3700 \cdot 5398303} = 0,0000098 \frac{1}{\text{cm}}$$

$$\sigma_{sr} = \frac{M_{cr}}{z \cdot A_s} ; \quad M_{cr} = f_{ctm} \cdot \frac{b \cdot h^2}{6} ; \quad f_{ctm} \approx 0,3 \cdot (f_{ck})^{2/3} ; \quad f_{ck} = 50,0 \text{ MPa}$$

$$f_{ctm} = 0,3 \cdot (f_{ck})^{2/3} = 0,3 \cdot (50,0)^{2/3} = 4,07 \text{ MPa}$$

$$M_{cr} = 0,407 \cdot \frac{55 \cdot 150^2}{6} = 83943 \text{ kNcm} = 839,43 \text{ kNm}$$

$$\sigma_{sr} = \frac{M_{cr}}{z \cdot A_s} \approx \frac{M_{cr}}{\left(d - \frac{x}{3} \right) \cdot A_s} = \frac{83943}{\left(140 - \frac{38,84}{3} \right) \cdot 75,82} = 8,71 \frac{\text{kN}}{\text{cm}^2} = 87,1 \text{ MPa}$$

$$\sigma_{s1} = \frac{M_{Ed}}{z \cdot A_{s1}} \approx \frac{M_{Ed}}{\left(d - \frac{x}{3}\right) \cdot A_{s1}} = \frac{1958,55 \cdot 100}{\left(140 - \frac{38,84}{3}\right) \cdot 75,82} = 21,42 \frac{kN}{cm^2} = 214,2 MPa$$

$$\frac{1}{r_I} = 0,00000297 \frac{1}{cm}$$

$$\frac{1}{r_{II}} = 0,0000098 \frac{1}{cm}$$

$$\zeta = 1 - \beta_1 \cdot \beta_2 \cdot \left(\frac{\sigma_{sr}}{\sigma_s}\right)^2 = 1 - 1,0 \cdot 0,5 \cdot \left(\frac{87,1}{214,2}\right)^2 = 0,92 - \text{koeficijent raspodjele}$$

$$\frac{1}{r_m} = \zeta \cdot \frac{1}{r_I} + (1 - \zeta) \cdot \frac{1}{r_{II}} = 0,92 \cdot 0,00000297 + (1 - 0,92) \cdot 0,0000098 = 0,0000035 \frac{1}{cm}$$

$$k = 0,098$$

$$L = 800,0 \text{ cm}$$

$$v_{tot,t=0} = k \cdot L^2 \cdot \frac{1}{r_{tot}} = 0,098 \cdot 800^2 \cdot 0,0000035 = 0,21 \text{ cm} < v_{lim} = 3,2 \text{ cm}$$

Odabrane dimezije grede i armatura zadovoljavaju u pogledu progiba!

9.3 Međukatni nosač G1-G3

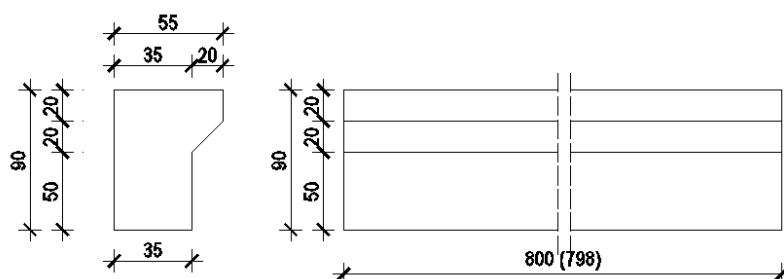

$$A_{nosac} = 0,375 \text{ m}^2$$

$$\gamma_b = 25 \text{ kN/m}^3$$

Materijal:

Beton:

C 50/67

Čelik:

B 500

$$L_{in} = 850 - 50 - 2 = 798 \text{ cm}$$

$$A = 3750 \text{ cm}^2 = 0,375 \text{ m}^2$$

9.3.1 Analiza opterećenja

-Vlastita težina nosača: $g_n = 0,375 \cdot 25 = 9,38 \text{ kN/m}$

-Težina šuplje ploče: $g_{pl} = w_{T2} = 6,3 \text{ kN/m}^2 = 6,3 \cdot 16,0 / 2 = 50,4 \text{ kN/m}$

-Težina betona za monolitizaciju iznad nosača: $g_b = (0,1 \cdot 16 / 2) \cdot 25 = 20 \text{ kN} / \text{m}$

-Stalno dodatno opterećenje: $\Delta g = 3,2 \text{ kN} / \text{m}^2 = 3,2 \cdot 16,0 / 2 = 25,6 \text{ kN} / \text{m}$

-Pokretno opterećenje: $q = q_u = 7,0 \text{ kN} / \text{m}^2 = 7,0 \cdot 16,0 / 2 = 56 \text{ kN} / \text{m}$

-ukupno stalno opterećenje:

$$g = g_{pl} + g_n + g_b = 9,38 + 50,4 + 20 = 79,78 \text{ kN} / \text{m}$$

-ukupno promjenjivo opterećenje:

$$q = 56 \text{ kN} / \text{m}$$

9.3.2 Rezne sile

-statički sustav

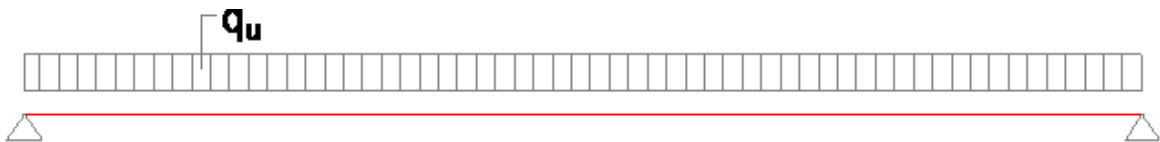

Slika 20: Prikaz statičkog sustava prve faze

Moment savijanja u polju:

$$M_{sd} = 1,35 \cdot \frac{g \cdot l_n^2}{8} = 1,35 \cdot \frac{79,78 \cdot 7,98^2}{8} = 857,32 \text{ kNm}$$

Poprečna sila na ležaju:

$$V_{sd} = 1,35 \cdot \frac{g \cdot l_n}{2} = 1,35 \cdot \frac{79,78 \cdot 7,98}{2} = 429,73 \text{ kN}$$

9.3.3 Dimenzioniranje na moment savijanja

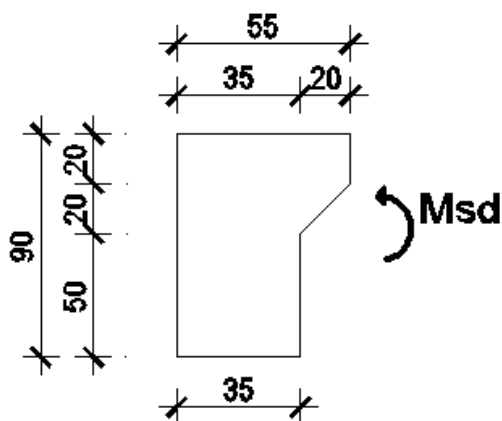

$$M_{sd} = 857,23 \text{ kNm}$$

$$h = 90 \text{ cm}$$

$$d_1 = 10 \text{ cm}$$

$$d = 80 \text{ cm}$$

$$C 50 / 67 \quad f_{cd} = \frac{f_{ck}}{\gamma_s} = \frac{50}{1,5} = 33,33 \text{ MPa} = 3,33 \text{ kN} / \text{cm}^2$$

$$B 500 \quad f_{yd} = \frac{f_{yk}}{\gamma_s} = \frac{500}{1,15} = 434,8 \text{ MPa} = 43,48 \text{ kN} / \text{cm}^2$$

$$\mu_{sd} = \frac{M_{sd}}{bd^2 f_{cd}} = \frac{857,23 \cdot 100}{55 \cdot 80^2 \cdot 3,3} = 0,07$$

$$\text{za } \varepsilon_{s1} = 10\text{‰}, \quad \varepsilon_{c2} = 1,7\text{‰}, \quad \zeta = 0,947, \quad \xi = 0,145$$

$$A_{s1} = \frac{M_{sd}}{\zeta \cdot d \cdot f_{yd}} = \frac{857,23 \cdot 100}{0,947 \cdot 80 \cdot 43,48} = 25,13 \text{ cm}^2$$

Odabrano: 7 Φ 22 ($A_s = 26,61 \text{ cm}^2$)

Profilu su zbog pukotina smanjeni 8 Φ 20 ($A_s = 25,13 \text{ cm}^2$). (2 reda)

9.3.4 Dimenzioniranje na poprečnu silu

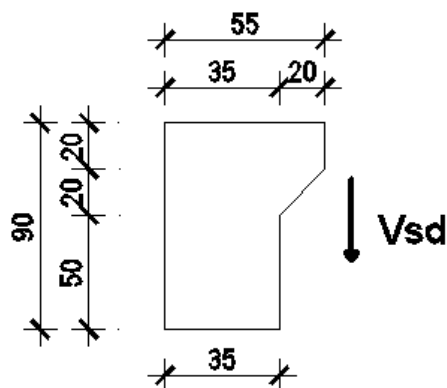

$$V_{sd} = 429,73 \text{ kN}$$

- beton: **C50/67**

$$f_{ck} = 50 \text{ MPa}$$

$$f_{cd} = 50/1,5 = 33,3 \text{ MPa}$$

-armatura : **B 500**

$$f_{yk} = 500 \text{ MPa}$$

$$f_{yd} = 500/1,15 = 434,8 \text{ MPa}$$

$$\Sigma A_s = 26,61 \text{ cm}^2 \rightarrow 7\Phi 22$$

$$\rho_l = \frac{\Sigma A_s}{A_c} = \frac{26,61}{3750} = 0,0071$$

Dio poprečne sile koju presjek preuzima bez poprečne armature:

$$V_{Rd,C} = \left[C_{RdC} \cdot k \cdot (100 \cdot \rho_l \cdot f_{ck})^{\frac{1}{3}} + k_1 \cdot \sigma_{cp} \right] \cdot b_w \cdot d$$

$$k = 1,0 + \sqrt{\frac{200}{d}} = 1,0 + \sqrt{\frac{200}{800}} = 1,5 > 2,0 \Rightarrow k = 1,50$$

$$k_1 = 0,15$$

$$\sigma_{cp} = N_{sd} / A_c = 0,0$$

$$C_{RdC} = \frac{0,18}{\gamma_c} = 0,12$$

$$V_{Rd,C} = \left[0,12 \cdot 1,5 \cdot (100 \cdot 0,0071 \cdot 50)^{\frac{1}{3}} + 0,15 \cdot 0,0 \right] \cdot 350 \cdot 800 = 165,64 \text{ kN}$$

$V_{Rd,C}$, mora biti veće od:

$$V_{Rd,C} \geq [v_{\min} + k_1 \cdot \sigma_{cp}] \cdot b_w \cdot d$$

$$k_1 = 0,15$$

$$v_{\min} = 0,035 \cdot k^{\frac{3}{2}} \cdot f_{ck}^{\frac{1}{2}} = 0,035 \cdot 1,5^{\frac{3}{2}} \cdot 50^{\frac{1}{2}} = 0,45$$

$$\sigma_{cp} = N_{sd} / A_c = 0,0$$

$$V_{Rd,C} = 165,64kN > [0,45 + 0] \cdot 350 \cdot 800 = 126kN$$

$$V_{Rd,C} = 165,64kN > V_{Ed,max} = 447,89kN$$

Maksimalna poprečna sila koju se ne smije prijeći (dio poprečne sile koje mogu preuzeti tlačne dijagonale):

$$V_{Rd,max} = 0,5 \cdot v \cdot b_w \cdot d \cdot f_{cd}$$

$$v = 0,6 \left[1,0 - \frac{f_{ck}}{250} \right] = 0,6 \left[1,0 - \frac{50}{250} \right] = 0,48$$

$$V_{Rd,max} = 0,5 \cdot 0,48 \cdot 350 \cdot 800 \cdot 33,3 = 2237,76kN > V_{Ed,max} = 447,89kN$$

$$\frac{V_{Ed,max}}{V_{Rd,max}} = \frac{447,89}{2237,76} = 0,2$$

$$V_{Ed} = 0,2 \cdot V_{Rd,max}$$

$$s_{\max} = \min \{0,8d; 30cm\} = \min \{64cm; 30cm\} = 30cm$$

$$\rho_{\min} = 0,0013(C50 / 67)$$

$$\max .razmak : s \leq \frac{m \cdot A_{sw}}{\rho_{\min} \cdot b_w} = \frac{2 \cdot 0,79}{0,0013 \cdot 35} = 34,7cm \rightarrow \Phi 10$$

Nosivost vilica za maksimalni razmak (34cm)

$$f_{ywd} = \frac{f_{yk}}{\gamma_s} = \frac{500}{1,15} = 434,8Mpa$$

$$V_{Rd} = V_{Rd,S} = \frac{A_{sw}}{s} \cdot z \cdot f_{ywd} \cdot m \cdot ctg \Theta$$

$$V_{Rd} = V_{Rd,S} = \frac{0,79}{34} \cdot (0,9 \cdot 80) \cdot 43,48 \cdot 2 \cdot 1 = 145,48kN$$

$$V_{Ed} = 447,89kN > V_{Rd} = 145,48kN$$

Kontroliramo nosivost betona:

$$V_{Rd,max} = \frac{\alpha_{cw} \cdot b_w \cdot z \cdot v_1 \cdot f_{cd}}{\tan \theta + ctg \theta} = \frac{1,0 \cdot 350 \cdot (0,9 \cdot 800) \cdot 0,6 \cdot 50}{\tan 45 + ctg 45} = 3780kN$$

$$V_{Rd,max} = 3780kN > V_{Ed,max} = 447,89kN$$

Potrebna kosa armatura za preuzimanje računске poprečne sile

$$A_{s,w} \leq \frac{s \cdot V_{Ed,s}}{z \cdot f_{yd} \cdot (ctg\theta + ctg\alpha) \cdot \sin\alpha} = \frac{447,89 \cdot 100}{0,9 \cdot 80 \cdot 43,48 \cdot (1,0 + 1,0) \cdot 1,0} = 7,15 \text{ cm}$$

Odabrane spone $\varnothing 10/20 \text{ cm}$, $m=2$, $A_{sw}=1,13 \text{ cm}^2$ + kosa armatura $3\varnothing 20$ $A_{sw}=9,42 \text{ cm}^2$,
armatura B 500

9.3.5 2. faza

-ukupno stalno opterećenje:

$$\Delta g = 3,2 \text{ kN/m}^2 = 3,2 \cdot 16,0 / 2 = 25,6 \text{ kN/m}$$

-ukupno korisno opterećenje:

$$q_k = 7,0 \text{ kN/m}^2 = 7,0 \cdot 16,0 / 2 = 56 \text{ kN/m}$$

1.1.1. Rezne sile

-statički sustav

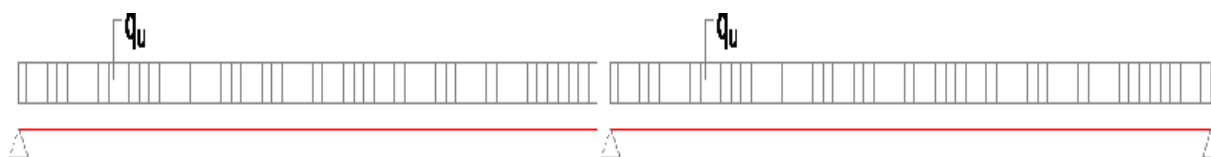

Slika 21: Prikaz statičkog sustava druge faze

Moment savijanja u polju:

$$M_{sd} = 1,35 \cdot 0,07 \cdot q \cdot l_n^2 + 1,5 \cdot 0,07 \cdot q_k \cdot l_n^2 = 1,35 \cdot 0,07 \cdot 25,6 \cdot 7,98^2 + 1,5 \cdot 0,07 \cdot 56 \cdot 7,98^2 = 528,5 \text{ kNm}$$

Moment savijanja na ležaju:

$$M_{sd} = 1,35 \cdot (-0,106 \cdot q \cdot l_n^2) + 1,5 \cdot (-0,106 \cdot q_k \cdot l_n^2) = 1,35 \cdot (-0,106 \cdot 25,6 \cdot 7,98^2) + 1,5 \cdot (-0,106 \cdot 56 \cdot 7,98^2)$$

$$M_{sd} = -800,3 \text{ kNm}$$

Poprečna sila na ležaju:

$$V_{sd} = 1,35 \cdot (1,130 \cdot q \cdot l_n) + 1,5 \cdot (1,130 \cdot q_k \cdot l_n) = 1,35 \cdot (1,130 \cdot 25,6 \cdot 7,98) + 1,5 \cdot (1,130 \cdot 56 \cdot 7,98)$$

$$V_{sd} = 1069,1 / 2 = 534,55 \text{ kN}$$

Poprečna sila na kraju:

$$V_{sd} = 1,35 \cdot (0,375 \cdot q \cdot l_n) + 1,5 \cdot (0,375 \cdot q_k \cdot l_n) = 1,35 \cdot (0,375 \cdot 25,6 \cdot 7,98) + 1,5 \cdot (0,375 \cdot 56 \cdot 7,98)$$

$$V_{sd} = 373,71 \text{ kN}$$

9.3.6 Dimenzioniranje na moment savijanja (polje)

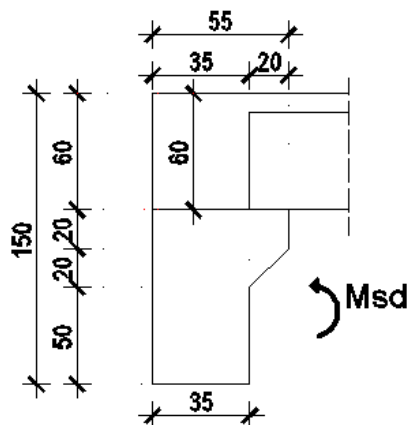

$$M_{sd} = 528,5 \text{ kNm}$$

$$h = 150 \text{ cm}$$

$$d_1 = 10 \text{ cm}$$

$$d = 140 \text{ cm}$$

$$C 50 / 67 \quad f_{cd} = \frac{f_{ck}}{\gamma_s} = \frac{50}{1,5} = 33,33 \text{ MPa} = 3,33 \text{ kN / cm}^2$$

$$B 500 \quad f_{yd} = \frac{f_{yk}}{\gamma_s} = \frac{500}{1,15} = 434,8 \text{ MPa} = 43,48 \text{ kN / cm}^2$$

$$\mu_{sd} = \frac{M_{sd}}{bd^2 f_{cd}} = \frac{528,5 \cdot 100}{55 \cdot 140^2 \cdot 3,3} = 0,023$$

$$\text{za } \varepsilon_{s1} = 10\text{‰}, \quad \varepsilon_{c2} = 0,9\text{‰}, \quad \zeta = 0,971, \quad \xi = 0,083$$

$$A_{s1} = \frac{M_{sd}}{\zeta \cdot d \cdot f_{yd}} = \frac{528,5 \cdot 100}{0,971 \cdot 140 \cdot 43,48} = 8,89 \text{ cm}^2$$

Odabrano: 3Φ20 ($A_s = 9,42 \text{ cm}^2$)

9.3.7 Dimenzioniranje na moment savijanja (ležaj)

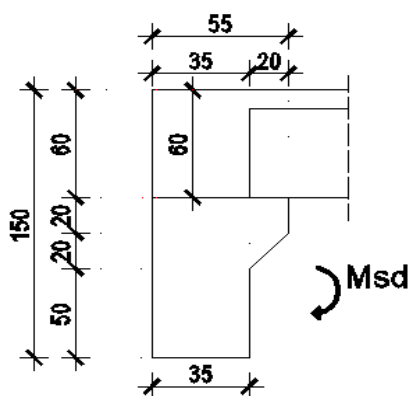

$$M_{sd} = 800,3 \text{ kNm}$$

$$h = 150 \text{ cm}$$

$$d_1 = 10 \text{ cm}$$

$$d = 140 \text{ cm}$$

$$C 50 / 67 \quad f_{cd} = \frac{f_{ck}}{\gamma_s} = \frac{50}{1,5} = 33,33 \text{ MPa} = 3,33 \text{ kN / cm}^2$$

$$B 500 \quad f_{yd} = \frac{f_{yk}}{\gamma_s} = \frac{500}{1,15} = 434,8 \text{ MPa} = 43,48 \text{ kN / cm}^2$$

$$\mu_{sd} = \frac{M_{sd}}{bd^2 f_{cd}} = \frac{800,3 \cdot 100}{35 \cdot 140^2 \cdot 3,3} = 0,035$$

$$\text{za } \varepsilon_{s1} = 10\text{‰}, \quad \varepsilon_{c2} = 1,1\text{‰}, \quad \zeta = 0,965,$$

$$\xi = 0,099$$

$$A_{s1} = \frac{M_{sd}}{\zeta \cdot d \cdot f_{yd}} = \frac{800,3 \cdot 100}{0,965 \cdot 140 \cdot 43,48} = 13,54 \text{ cm}^2$$

Odabrano: 4Φ22 ($A_s = 15,21 \text{ cm}^2$)

Profili su smanjeni 5Φ20 ($A_s = 15,71 \text{ cm}^2$)

9.3.8 Dimenzioniranje na poprečnu silu

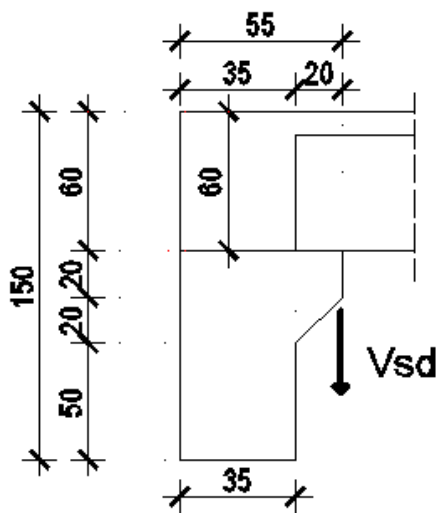

$$V_{Ed} = 534,55 \text{ kN}$$

- beton: **C50/67**

$$f_{ck} = 50 \text{ MPa}$$

$$f_{cd} = 50 / 1,5 = 33,33 \text{ MPa}$$

-armatura : **B 500**

$$f_{yk} = 500 \text{ MPa}$$

$$f_{yd} = 500 / 1,15 = 434,8 \text{ MPa}$$

$$\Sigma A_s = 24,63 \text{ cm}^2 \rightarrow 3\Phi 20 + 4\Phi 22$$

$$\rho_l = \frac{\Sigma A_s}{A_c} = \frac{24,63}{7050} = 0,0035$$

Dio poprečne sile koju presjek preuzima bez poprečne armature:

$$V_{Rd,C} = \left[C_{RdC} \cdot k \cdot (100 \cdot \rho_l \cdot f_{ck})^{\frac{1}{3}} + k_1 \cdot \sigma_{cp} \right] \cdot b_w \cdot d$$

$$k = 1,0 + \sqrt{\frac{200}{d}} = 1,0 + \sqrt{\frac{200}{1400}} = 1,38 > 2,0 \Rightarrow k = 1,38$$

$$k_1 = 0,15$$

$$\sigma_{cp} = N_{sd} / A_c = 0,0$$

$$C_{RdC} = \frac{0,18}{\gamma_c} = 0,12$$

$$V_{Rd,C} = \left[0,12 \cdot 1,38 \cdot (100 \cdot 0,0035 \cdot 50)^{\frac{1}{3}} + 0,15 \cdot 0,0 \right] \cdot 350 \cdot 1400 = 210,66 \text{ kN}$$

$V_{Rd,C}$, mora biti veće od:

$$V_{Rd,C} \geq [v_{\min} + k_1 \cdot \sigma_{cp}] \cdot b_w \cdot d$$

$$k_1 = 0,15$$

$$v_{\min} = 0,035 \cdot k^{\frac{3}{2}} \cdot f_{ck}^{\frac{1}{2}} = 0,035 \cdot 1,38^{\frac{3}{2}} \cdot 50^{\frac{1}{2}} = 0,396$$

$$\sigma_{cp} = N_{sd} / A_c = 0,0$$

$$V_{Rd,C} = 210,66kN > [0,396 + 0] \cdot 350 \cdot 1400 = 194,04kN$$

$$V_{Rd,C} = 210,66kN < V_{Ed,max} = 534,55kN$$

Maksimalna poprečna sila koju se ne smije prijeći (dio poprečne sile koje mogu preuzeti tlačne dijagonale):

$$V_{Rd,max} = 0,5 \cdot v \cdot b_w \cdot d \cdot f_{cd}$$

$$v = 0,6 \left[1,0 - \frac{f_{ck}}{250} \right] = 0,6 \left[1,0 - \frac{50}{250} \right] = 0,48$$

$$V_{Rd,max} = 0,5 \cdot 0,48 \cdot 350 \cdot 1400 \cdot 50 = 5880kN > V_{Ed,max} = 534,55kN$$

$$\frac{V_{Ed,max}}{V_{Rd,max}} = \frac{534,55}{5880} = 0,09$$

$$V_{Ed} = 0,09 \cdot V_{Rd,max}$$

$$s_{\max} = \min \{0,8d; 30cm\} = \min \{112cm; 30cm\} = 30cm$$

$$\rho_{\min} = 0,0013(C50 / 67)$$

$$\max .razmak : s \leq \frac{m \cdot A_{sw}}{\rho_{\min} \cdot b_w} = \frac{2 \cdot 0,79}{0,0013 \cdot 35} = 34,7cm \rightarrow \Phi 10$$

Nosivost vilica za maksimalni razmak (34cm)

$$f_{ywd} = \frac{f_{yk}}{\gamma_s} = \frac{500}{1,15} = 434,8Mpa$$

$$V_{Rd} = V_{Rd,S} = \frac{A_{sw}}{s} \cdot z \cdot f_{ywd} \cdot m \cdot ctg \Theta$$

$$V_{Rd} = V_{Rd,S} = \frac{0,79}{34} \cdot (0,9 \cdot 140) \cdot 43,48 \cdot 2 \cdot 1 = 254,58kN$$

$$V_{Ed} = 534,55kN > V_{Rd} = 254,58kN$$

Kontroliramo nosivost betona:

$$V_{Rd,max} = \frac{\alpha_{cw} \cdot b_w \cdot z \cdot v_1 \cdot f_{cd}}{\tan \theta + ctg \theta} = \frac{1,0 \cdot 350 \cdot (0,9 \cdot 1400) \cdot 0,6 \cdot 50}{\tan 45 + ctg 45} = 5512,5 kN$$

$$V_{Rd,max} = 5512,5 kN > V_{Ed,max} = 534,55 kN$$

Potrebna kosa armatura za preuzimanje računске poprečne sile

$$A_{s,w} \leq \frac{s \cdot V_{Ed,s}}{z \cdot f_{yd} \cdot (ctg \theta + ctg \alpha) \cdot \sin \alpha} = \frac{534,55 \cdot 100}{0,9 \cdot 140 \cdot 43,48 \cdot (1,0 + 1,0) \cdot 1,0} = 4,87 cm$$

Odabrane sponе $\varnothing 10/20$ cm, $m=2$, $A_{sw}=1,13 cm^2$ + kosa armatura $2\varnothing 20$ $A_{sw}=6,28 cm^2$,
armatura B 500

9.3.9 Dimenzioniranje kratke konzole na međukatnom T nosaču

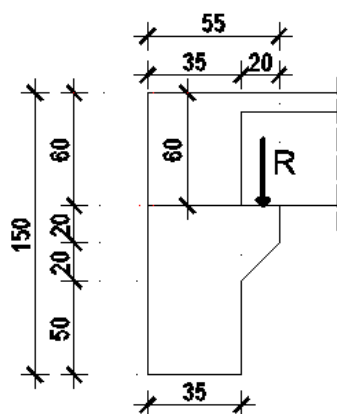

- beton: **C50/67**

$$f_{ck}=50 MPa$$

$$f_{cd}=50/1,5= 33,3 MPa$$

-armatura : **B 500**

$$f_{yk}=500 MPa$$

$$f_{yd}=500/1,15 = 434,8 MPa$$

Analiza opterećenja:

$$\text{-Težina šuplje ploče: } g_{pl} = w_{T2} = 6,3 kN / m^2 = 6,3 \cdot \frac{16,0}{2,0} = 50,4 kN / m$$

$$\text{-Stalno dodatno opterećenje: } \Delta g = 3,2 kN / m^2 = 3,2 \cdot \frac{16,0}{2} = 25,6 kN / m$$

$$\text{-Pokretno opterećenje: } q = q_u = 7,0 kN / m^2 = 7,0 \cdot \frac{16,0}{2} = 56 kN / m$$

-ukupno stalno opterećenje:

$$g = g_{pl} + \Delta g = 50,4 + 25,6 = 76 kN / m$$

-ukupno promjenjivo opterećenje:

$$q = 56 kN / m$$

Reakcija šuplje ploče:

$$R = 1,35 \cdot g + 1,5q = 1,35 \cdot 76 + 1,5 \cdot 56 = 186,6 \text{ kN} / \text{m}$$

Moment savijanja:

$$M_{sd} = 0,105 \cdot R_n = 0,105 \cdot 186,6 = 19,59 \text{ kNm} / \text{m}$$

$$A_{s1} = \frac{M_{sd}}{0,8 \cdot d \cdot f_{yd}} = \frac{19,59 \cdot 100}{0,8 \cdot 30 \cdot 43,48} = 1,877 \text{ cm}^2 / \text{m}$$

Odabrano: $\Phi 10/20$ ($A_s = 5 \times 0,79 \text{ cm}^2$)

Otpornost na poprečnu silu:

$$V_{Ed} = \mu \cdot A_{sw} \cdot f_{yd} = 1,4 \cdot (0,79 \cdot 2 \cdot 5) \cdot 43,48 = 480,89 \text{ kN}$$

Vidljivo je da vilice T nosača imaju dostatnu nosivost na posmik te nije potrebna dodatna armatura.

-Kontrola tlačnih naprezanja:

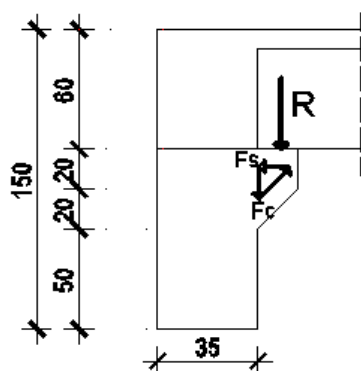

$$F_c = \frac{R}{\sin \alpha} = \frac{186,6}{\sin 45^\circ} = 263,89 \text{ kN}$$

$$c = 0,2 \cdot h$$

$$h = 40 \text{ cm}$$

$$b_{konz} = 100 \text{ cm}$$

$$\sigma_c = \frac{F_c}{c \cdot b_{konz}} = \frac{263,89}{(0,2 \cdot 35) \cdot 100}$$

$$\sigma_c = 0,38 \text{ kN} / \text{cm}^2 \leq 0,45 \cdot f_{ck} = 2,25 \text{ kN} / \text{cm}^2$$

9.4 Ukupno međuetajni nosači:

	Srednji nosač			Rubni nosač		
	polje	ležaj	poprečna	polje	ležaj	poprečna
1. faza	17 $\Phi 2$	-	$\Phi 10/20+4\Phi 2$	7 Φ	-	$\Phi 10/20+3\Phi 2$
2. faza	7 $\Phi 20$	9 $\Phi 2$	$\Phi 10/20+3\Phi 2$	3 Φ	4 $\Phi 22$	$\Phi 10/20+2\Phi 2$
ukupno	24 $\Phi 2$	9 $\Phi 2$	$\Phi 10/20+7\Phi 20$	10	4 $\Phi 22$	$\Phi 10/20+5\Phi 2$
konzole	$\Phi 10/20$			$\Phi 10/20$		

9.5 Proračun kratkih konzola na stupovima

9.5.1 Analiza opterećenja

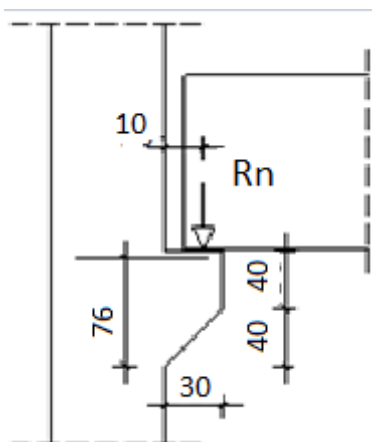

-Vlastita težina nosača: $g_n = 0,57 \cdot 25 = 14,25 \text{ kN/m} \Rightarrow R = 14,25 \cdot 4\text{m} = 57 \text{ kN}$

-Težina šuplje ploče: $g_{pl} = w_{T2} = 6,3 \text{ kN/m}^2; R = 6,3 \cdot 64,0 = 403,2 \text{ kN}$

-Težina betona za monolitizaciju iznad nosača: $R_b = (0,1 \cdot 64) \cdot 25 = 160 \text{ kN}$

-Stalno dodatno opterećenje: $\Delta g = 3,2 \text{ kN/m}^2; R = 3,2 \cdot 64 = 204,8 \text{ kN}$

-Pokretno opterećenje: $q = q_u = 7,0 \text{ kN/m}^2 = 7,0 \cdot 64,00 = 448 \text{ kN}$

$$R = (R_{pl} + R_n + R_b + R\Delta g) \cdot 1,35 + R_Q \cdot 1,5 = (57 + 403,2 + 160 + 204,8) \cdot 1,35 + 448 \cdot 1,5 = 1785,75 \text{ kN}$$

Reakcija međuetaznog nosača: $R_{UKUPNO} = 1785,75 \text{ kN}$

Dimenzioniranje kratkih konzola

$$h = 80 \text{ cm}$$

$$d_1 = 4 \text{ c m}$$

$$d = 76 \text{ cm}$$

$$C 30/37 \quad f_{cd} = \frac{f_{ck}}{\gamma_s} = \frac{30}{1,5} = 20,0 \text{ MPa} = 2,0 \text{ kN/cm}^2$$

$$B 450C \quad f_{yd} = \frac{f_{yk}}{\gamma_s} = \frac{450}{1,15} = 391,30 \text{ MPa} = 39,13 \text{ kN/cm}^2$$

9.5.2 Dimenzioniranje na moment savijanja

$$M_{sd} = 0,15 \cdot R_n = 0,15 \cdot 1785,75$$

$$M_{sd} = 267,86 \text{ kNm}$$

$$A_{s1} = \frac{M_{sd}}{0.8 \cdot d \cdot f_{yd}} = \frac{267,86 \cdot 100}{0.8 \cdot 76 \cdot 43,48} = 10,13 \text{ cm}^2$$

Odabrano: 6Φ18 (10,16 cm²)

9.5.3 Dimenzioniranje na poprečnu silu

$$V_{sd} = R_n = 1785,75 \text{ kN}$$

- beton: **C30/37**

$$f_{ck} = 30 \text{ MPa}$$

$$f_{cd} = 30/1,5 = 20,0 \text{ MPa}$$

- armatura : **B 450C**

$$f_{yk} = 450 \text{ MPa}$$

$$f_{yd} = 450/1,15 = 391,30 \text{ MPa}$$

$$V_{Rd,C} = \left[C_{RdC} \cdot k \cdot (100 \cdot \rho_l \cdot f_{ck})^{\frac{1}{3}} + k_1 \cdot \sigma_{cp} \right] \cdot b_w \cdot d$$

$$k = 1,0 + \sqrt{\frac{200}{d}} = 1,0 + \sqrt{\frac{200}{760}} = 1,51 < 2,0$$

$$k_1 = 0,15$$

$$\sigma_{cp} = N_{sd} / A_c = 0,0$$

$$C_{RdC} = \frac{0,18}{\gamma_c} = 0,12$$

$$V_{Rd,C} = \left[0,12 \cdot 1,51 \cdot \left(100 \cdot \frac{10,16}{55 \cdot 80} \cdot 30 \right)^{\frac{1}{3}} + 0,15 \cdot 0,0 \right] \cdot 550 \cdot 760 = 144,38 \text{ kN}$$

$V_{Rd,C}$,mora bit veće od:

$$V_{Rd,C} \geq \left[v_{\min} + k_1 \cdot \sigma_{cp} \right] \cdot b_w \cdot d$$

$$k_1 = 0,15$$

$$v_{\min} = 0,035 \cdot k^{\frac{3}{2}} \cdot f_{ck}^{\frac{1}{2}} = 0,035 \cdot 1,5^{\frac{3}{2}} \cdot 30^{\frac{1}{2}} = 0,35$$

$$\sigma_{cp} = N_{sd} / A_c = 0,0$$

$$V_{Rd,C} = 144,38 \text{ kN} > [0,35 + 0] \cdot 550 \cdot 760 = 146,3 \text{ kN}$$

$$V_{Rd,C} = 144,38 \text{ kN} < V_{Ed,max} = 1785,75 \text{ kN}$$

Maksimalna poprečna sila koju se ne smije prijeći (dio poprečne sile koje mogu preuzeti tlačne dijagonale):

$$V_{Rd,max} = 0,5 \cdot \nu \cdot b_w \cdot d \cdot f_{cd}$$

$$\nu = 0,6 \left[1,0 - \frac{f_{ck}}{250} \right] = 0,6 \left[1,0 - \frac{30}{250} \right] = 0,53$$

$$V_{Rd,max} = 0,5 \cdot 0,53 \cdot 550 \cdot 760 \cdot 20 = 2215,4 \text{ kN} > V_{Ed,max} = 1785,75 \text{ kN}$$

$$\frac{V_{Ed,max}}{V_{Rd,max}} = \frac{1785,75}{2215,4} = 0,8$$

$$V_{Ed} = 0,8 \cdot V_{Rd,max}$$

$$s_{max} = \min \{0,3d; 20\text{cm}\} = \min \{22,8\text{cm}; 20\text{cm}\} = 20\text{cm}$$

$$\rho_{min} = 0,0011(C30/37)$$

$$\max \text{razmak} : s \leq \frac{m \cdot A_{sw}}{\rho_{min} \cdot b_w} = \frac{2 \cdot 0,79}{0,0011 \cdot 55} = 26,11 \text{ cm} \rightarrow \Phi 10$$

Nosivost vilica za maksimalni razmak (20cm)

$$f_{ywd} = \frac{f_{yk}}{\gamma_s} = \frac{500}{1,15} = 434,8 \text{ Mpa}$$

$$V_{Rd} = V_{Rd,S} = \frac{A_{sw}}{s} \cdot z \cdot f_{ywd} \cdot m \cdot ctg \Theta$$

$$V_{Rd} = V_{Rd,S} = \frac{0,79}{20} \cdot (0,9 \cdot 76) \cdot 43,48 \cdot 2 \cdot 1 = 234,9 \text{ kN}$$

$$V_{Ed} = 1785,75 \text{ kN} > V_{Rd} = 234,9 \text{ kN}$$

Kontroliramo nosivost betona:

$$V_{Rd,max} = \frac{\alpha_{cw} \cdot b_w \cdot z \cdot \nu_1 \cdot f_{cd}}{\tan \theta + ctg \theta} = \frac{1,0 \cdot 550 \cdot (0,9 \cdot 760) \cdot 0,6 \cdot 30}{\tan 45 + ctg 45} = 3385,8 \text{ kN}$$

$$V_{Rd,max} = 3385,8 \text{ kN} > V_{Ed,max} = 1785,75 \text{ kN}$$

Potrebni razmak spona za preuzimanje računске poprečne sile:

$$s_{pot} \leq \frac{m \cdot A_{sw} \cdot f_{ywd} \cdot z}{V_{Ed}} = \frac{4 \cdot 0,79 \cdot 43,48 \cdot (0,9 \cdot 76)}{1785,75} = 5,26 \text{ cm}$$

Odabrane spona $\Phi 10/5$ cm, $m=4$, $A_{sw}=0,79\text{cm}^2$, armatura B 500

	Kratke konzole	
	šipke	spona
površina	10,16	27,28
odabrano	6Ø18	Ø10/5

10. PRORAČUN MEĐUETAŽNE KONSTRUKCIJE (monolitne ploče)

10.1 Proračun ploče pozicija 102 – granično stanje nosivosti

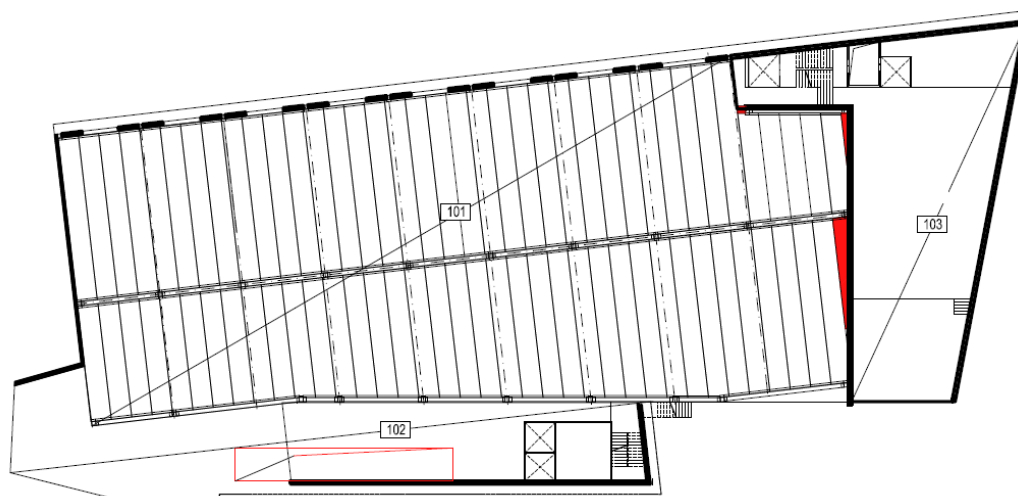

Slika 22: Prikaz pozicija 100

Relativne deformacije armature i betona:

$$\mu_{ed} = 0.159; \quad \zeta \approx 0.892 \quad \varepsilon_c / \varepsilon_s = 3.5/10.0$$

Momenti nosivosti betona i armature (prikazani u tablicama u nastavku):

$$M_{Ed,c,lim} = \mu_{Ed,lim} \cdot b \cdot d^2 \cdot f_{cd} = 0.159 \cdot b \cdot d^2 \cdot f_{cd}$$

$$M_{Ed,s,lims} = A_s \cdot \zeta \cdot d \cdot f_{yd}$$

Mjerodavna granična nosivost armiranobetonskog presjeka je manja od spomenutih vrijednosti.

Dimenzije poprečnog presjeka ploče (m):

$$b=100 \text{ cm} \quad h=25 \text{ cm}; \quad d=22 \text{ cm}$$

Minimalna i maksimalna površina armature:

$$A_{s1,min} = 0.1\% b h = 0.001 \cdot 100 \cdot 25 = 2,5 \text{ cm}^2$$

$$A_{s1,max} = 2.0\% b h = 0.020 \cdot 100 \cdot 25 = 50 \text{ cm}^2$$

Rezultati proračuna unutarnjih sila:

Prikazane su anvelope minimalnih i maksimalnih vrijednosti momenata savijanja od mjerodavnijih kombinacija za pojedini smjer.

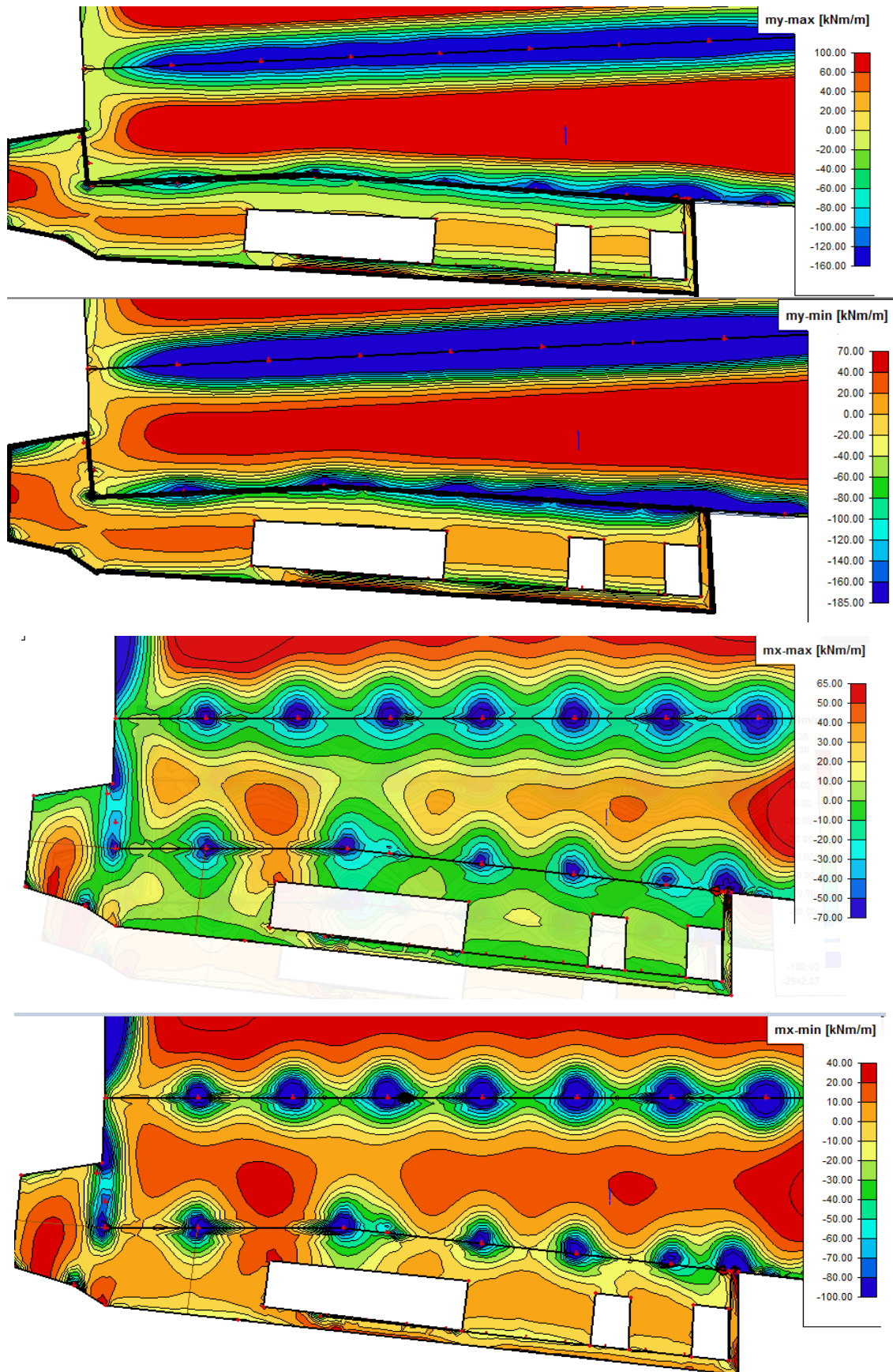

Slika 23: Prikaz minimalnih i maksimalnih momenata savijanja

Dimenzioniranje:

Donja zona (pozitivni moment savijanja) $\rightarrow M_{Ed,max} = 54,42kNm$

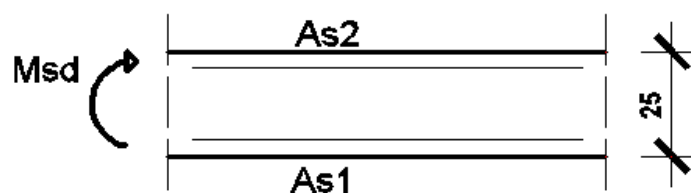

Slika 24: Skica položaja armature u donjoj zoni ploče

$$C\ 30/37 \quad f_{cd} = \frac{f_{ck}}{\gamma_c} = \frac{30}{1.5} = 20.0\ \text{MPa}; \quad f_{cd} = 2.0\ \text{kN/cm}^2$$

$$B\ 500 \quad f_{yd} = \frac{f_{yk}}{\gamma_s} = \frac{500}{1.15} = 435\ \text{MPa}; \quad f_{yd} = 43.5\ \text{kN/cm}^2$$

Mreža	Površina	Moment nosivosti čelika	Moment nosivosti betona	Postotak armiranosti presjeka
	cm ² /m'	M _{Ed,s,lim} kNm	M _{Ed,c,lim} kNm	
R-257	2,57	21,93	153,91	0,10
R-283	2,83	24,15	153,91	0,11
R-335	3,35	28,58	153,91	0,13
R-385	3,85	32,85	153,91	0,15
R-424	4,24	36,18	153,91	0,17
R-503	5,03	42,92	153,91	0,20
R-524	5,24	44,71	153,91	0,21
R-636	6,36	54,27	153,91	0,25
R-785	7,85	66,98	153,91	0,31

Tablica 2: Momenti nosivosti za odabranu mrežastu armaturu i betonski presjek

-odabrana mreža R – 785 ($A_s = 7,85\text{cm}^2$)

Zbog preraspodjele kod dugotrajnih efekata armatura u polju uvijek se uzima veća od izračunate, a armatura na ležajevima u skladu s izračunatom. R mreže postaviti na dijelu ploče koji dominantno nosi u y smjeru, dok je krajnji (zapadni) dio ploče 102 potrebno armirati Q mrežom zbog kvadratne geometrije.

Gornja zona (negativni moment savijanja) $\rightarrow M_{Ed,min} = 185,50kNm$

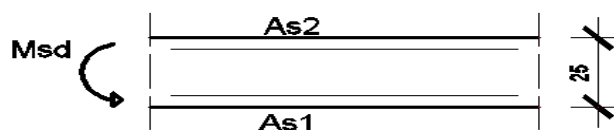

Slika 25: Skica položaja armature u gornjoj zoni ploče

Šipke	Mreža	Površina cm ² /m'	Moment nosivosti čelika	Moment nosivosti betona	Postotak armirano sti
			MRd,s,lim kNm	MRd,c,lim kNm	
φ 20/20	R-257	18,28	155,97	153,91	0,61
φ 20/20	R-283	18,54	158,19	153,91	0,62
φ 20/20	R-335	19,06	162,63	153,91	0,64
φ 20/20	R-385	19,56	166,90	153,91	0,65
φ 20/20	R-424	19,95	170,22	153,91	0,67
φ 20/20	R-503	20,74	176,96	153,91	0,69
φ 20/20	R-524	20,95	178,76	153,91	0,70
φ 20/20	R-636	22,07	188,31	153,91	0,74
φ 20/20	R-785	23,56	201,03	153,91	0,79

Tablica 3: Momenti nosivosti za odabranu mrežastu armaturu i betonski presjek

-odabrane mreže:

R – 785 + Φ20/20 ($A_s = 7,85 + 15,71 \text{ cm}^2$)- za područje momenata savijanja na spoju polumontažnog dijela ploče $M = 200 \text{ kNm}$.

Betonski dio ploče na spoju je deblji za visinu montažnog nosača (grede) na kojeg se s jedne strane oslanjaju šuplje ploče, a s druge promtrana monolitna ploča.

Armaturu je potrebno po pripadnim tablicama smanjivati.

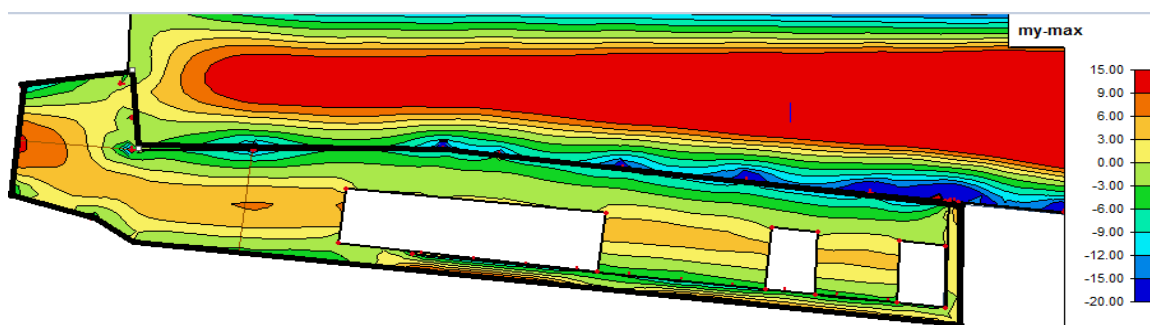

Slika 26: Armatura My max

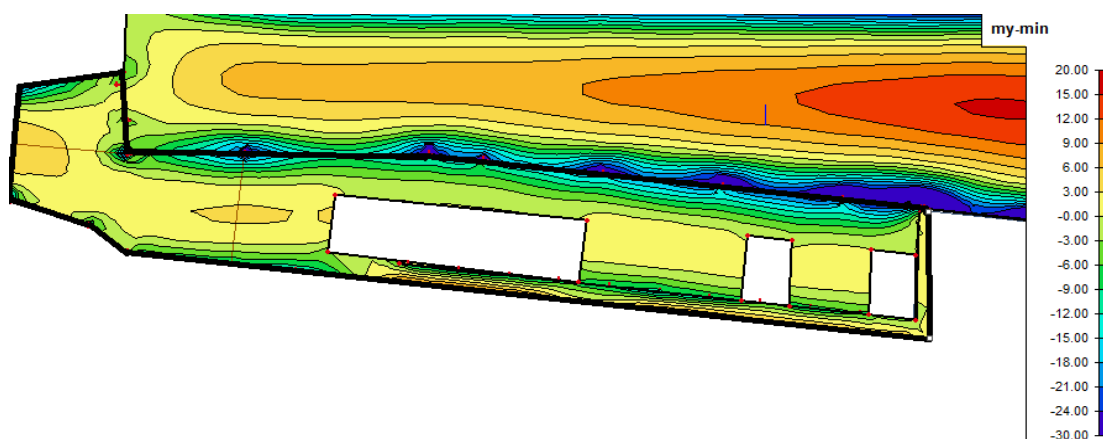

Slika 27: Armatura My min

10.1.1.1 Kontrola pukotina u polju pozicija 102

Mjerodavni momenti u ploči su dobiveni kroz numerički model. Koriste se rezultati od kratkotrajnog djelovanja i radne kombinacije opterećenja ($e = 1.0 \cdot g + 1.0 \cdot \Delta g + 1.0 \cdot q$).

Granična vrijednost širine pukotine: $w_g = 0.3 \text{ mm}$ (EC-2 – uobičajena sredina)

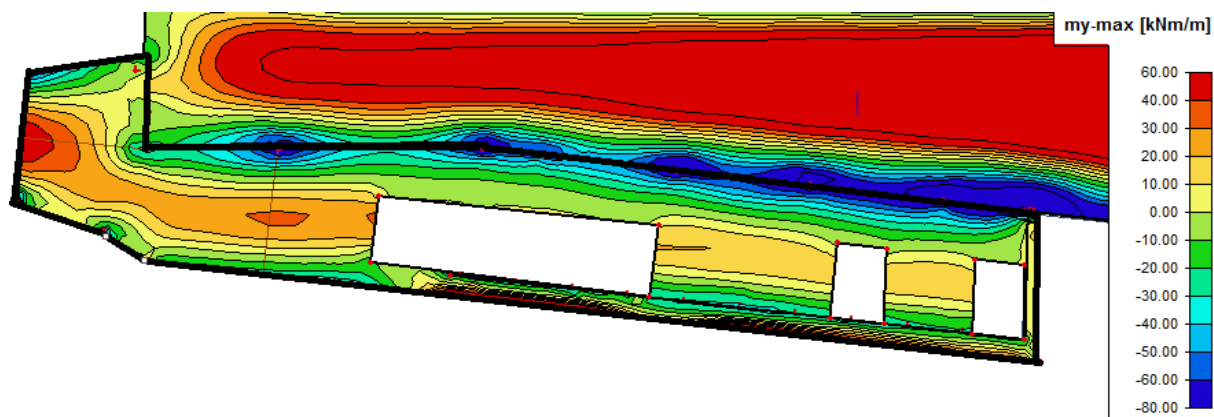

Slika 28: $M_y \text{ max}$ za kombinaciju GSU

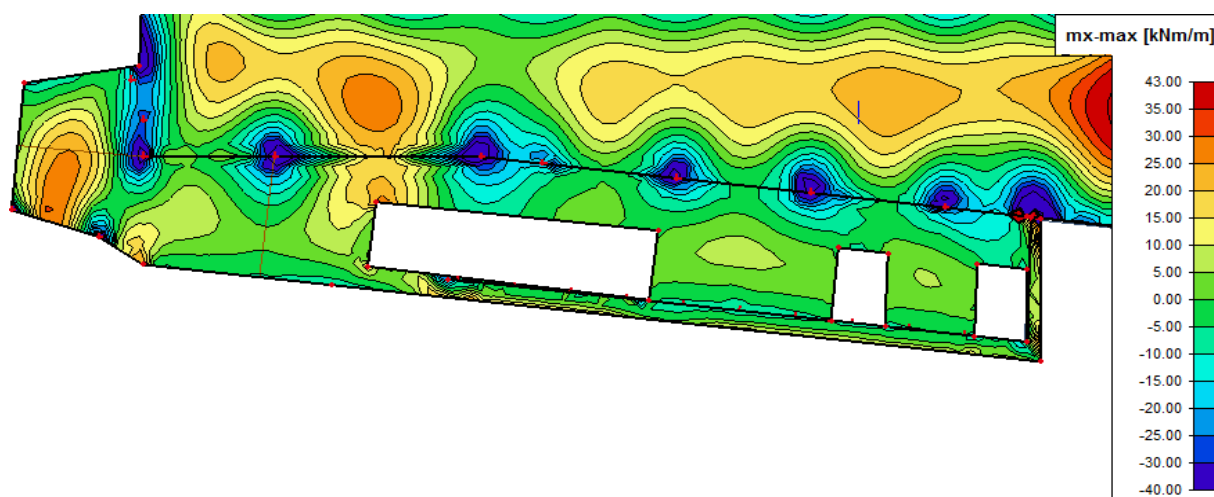

Slika 29: $M_x \text{ max}$ za kombinaciju GSU

Proračunska vrijednost širine pukotine: (EC-2): $w_k = \beta \cdot s_{rm} \cdot \varepsilon_{sm} \leq w_g$

Maksimalni eksploatacijski (radni) moment u polju: $M_{sd} = 45,9 \text{ kNm/m}$

Armatura ploče donja zona: R – 785 ($A_s = 7,85 \text{ cm}^2$)

$A_{s1} = 7,85 \text{ cm}^2 / \text{m}$ $b = 100 \text{ (cm)}$; $h = 25 \text{ (cm)}$; $d_1 = 3 \text{ (cm)}$; $d = 22 \text{ (cm)}$

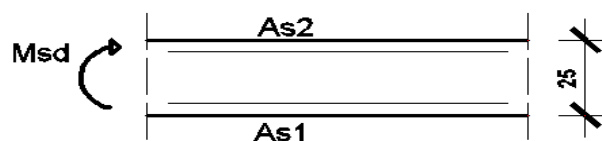

Slika 30: Skica armature u polju

Prognoza širine pukotina:

$$w_k = s_{r \max} \cdot (\varepsilon_{sm} - \varepsilon_{cm})$$

Proračun srednje deformacije armature:

$$\varepsilon_{sm} - \varepsilon_{cm} = \frac{\sigma_s - k_t \frac{f_{ct,eff}}{\rho_{p,eff}} (1 + \alpha_e \cdot \rho_{p,eff})}{E_s} \geq 0,6 \frac{\sigma_s}{E_s}$$

$$\alpha_e = \frac{E_s}{E_{cm}} = \frac{200}{32} = 6,25 \quad \text{- Odnos modula elastičnosti}$$

$$x = \xi_{lim} \cdot d = 22 \cdot 0,259 = 5,698 \quad \text{- Položaj neutralne osi}$$

$$x = \frac{\alpha_{el} \cdot A_{s1}}{b} \cdot \left(-1 + \sqrt{1 + \frac{2 \cdot b \cdot d}{\alpha_{el} \cdot A_{s1}}} \right) = \frac{6,25 \cdot 7,85}{100} \cdot \left(-1 + \sqrt{1 + \frac{2 \cdot 100 \cdot 22}{6,25 \cdot 7,85}} \right) = 4,18 \text{ (cm)}$$

$$\sigma_s = \frac{M_{Ed}}{z \cdot A_s} \approx \frac{M_{Ed}}{\left(d - \frac{x}{3} \right) \cdot A_s} = \frac{45,9 \cdot 100}{\left(22 - \frac{4,18}{3} \right) \cdot 7,85} = 28,37 \left(\frac{kN}{cm^2} \right) = 283,7 \text{ (MPa)}$$

$k_t = 0.4$ – Dugotrajno opterećenje

$E_s = 200.0$ GPa- modul elastičnosti armature

$E_{cm} = 32.80$ GPa- modul elastičnosti betona

Za C 30/37 $\rightarrow f_{ct,eff} = f_{ctm} = 2.9$ MPa

$$\rho_{p,eff} = \frac{A_s}{A_{c,eff}} = \frac{7,85}{100 \cdot 5,94} = 0,0132 \text{ - Djelotvorni koeficijent armiranja glavnom vlačnom}$$

armaturom

$$\varepsilon_{sm} - \varepsilon_{cm} = \frac{283,7 - 0,4 \frac{2,9}{0,0132} (1 + 6,25 \cdot 0,0132)}{200000} \geq 0,6 \frac{283,7}{200000}$$

$$\frac{188,57}{200000} > \frac{170,22}{200000}$$

$$\varepsilon_{sm} - \varepsilon_{cm} = \frac{188,57}{200000} = 0,00093$$

Srednji razmak pukotina

$$s_{r \max} = k_3 \cdot c + k_1 \cdot k_2 \cdot k_4 \cdot \frac{\phi}{\rho_{p,eff}} \quad \text{(mm)}$$

$\Phi = 10$ mm – Promjer najdeblje šipke

$c = 30$ mm – Zaštitni sloj uzdužne armature

$k_1 = 0.8$ – Rebrasta armatura

$k_2 = 0,5$ – Savijanje

$k_3 = 3,4$

$k_4 = 0,425$

$$s_{r_{\max}} = 3,4 \cdot 30 + 0,8 \cdot 0,5 \cdot 0,425 \cdot \frac{10}{0,0132} = 230,78 \text{ (mm)}$$

$$w_k = s_{r_{\max}} \cdot (\varepsilon_{sm} - \varepsilon_{cm}) = 230,78 \cdot 0,00093 = 0,21 \text{ mm} < 0,30 \text{ mm}$$

Odabrana armatura zadovoljava u pogledu širine pukotina!

10.1.1.2 Kontrola pukotina na ležaju pozicija 102

Mjerodavni momenti u ploči su dobiveni kroz numerički model. Koriste se rezultati od kratkotrajnog djelovanja i radne kombinacije opterećenja ($e = 1,0 \cdot g + 1,0 \cdot \Delta g + 1,0 \cdot q$).

Granična vrijednost širine pukotine: $w_g = 0,3 \text{ mm}$ (EC-2 – uobičajena sredina)

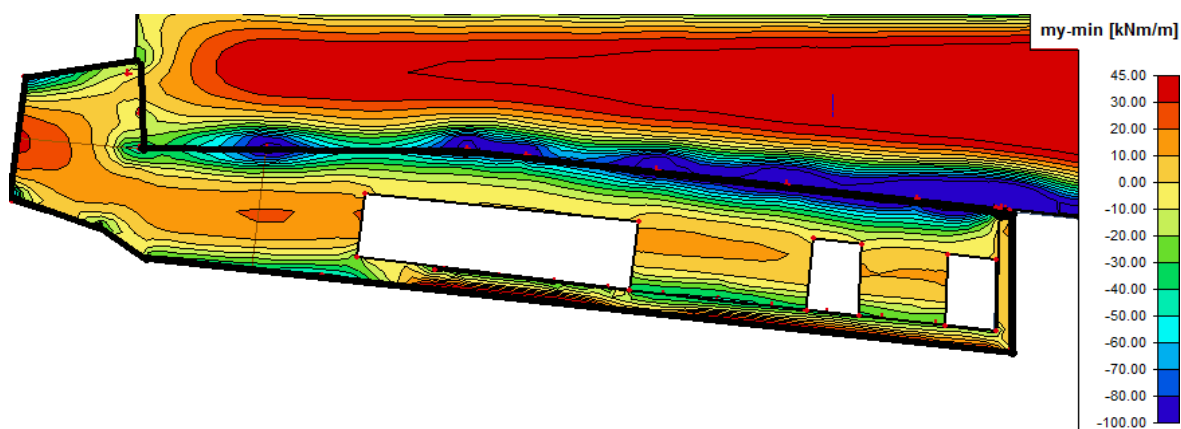

Slika 31: $M_y \text{ min}$ za kombinaciju GSU

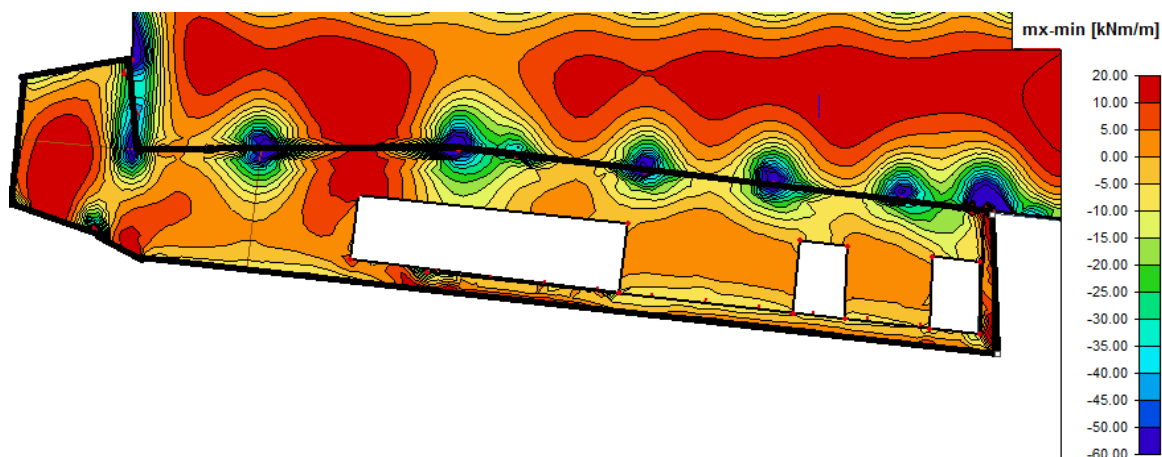

Slika 32: $M_x \text{ min}$ za kombinaciju GSU

Proračunska vrijednost širine pukotine: (EC-2): $w_k = \beta \cdot s_{rm} \cdot \varepsilon_{sm} \leq w_g$

Maksimalni eksploatacijski (radni) moment na ležaju: $M_{sd} = 102,5 \text{ kNm} / m$

Armatura ploče gornja zona: R – 785 + $\Phi 20/20$ ($A_s = 7,85 + 15,71 \text{ cm}^2$)-

$A_{s1} = 23,56 \text{ cm}^2 / m$ $b = 100$ (cm); $h = 25$ (cm); $d_1 = 3$ (cm); $d = 22$ (cm)

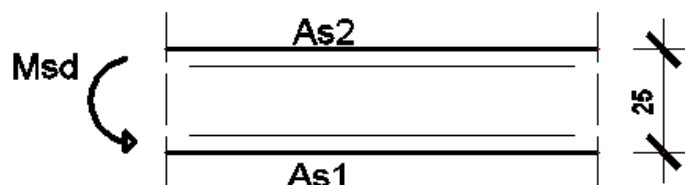

Slika 33: Skica armature u polju

Prognoza širine pukotina:

$$w_k = s_{r \max} \cdot (\varepsilon_{sm} - \varepsilon_{cm})$$

Proračun srednje deformacije armature:

$$\varepsilon_{sm} - \varepsilon_{cm} = \frac{\sigma_s - k_t \frac{f_{ct,eff}}{\rho_{p,eff}} (1 + \alpha_e \cdot \rho_{p,eff})}{E_s} \geq 0,6 \frac{\sigma_s}{E_s}$$

$$\alpha_e = \frac{E_s}{E_{cm}} = \frac{200}{32} = 6,25 \quad \text{- Odnos modula elastičnosti}$$

$$x = \xi_{lim} \cdot d = 22 \cdot 0,259 = 5,698 \quad \text{- Položaj neutralne osi}$$

$$x = \frac{\alpha_{el} \cdot A_{s1}}{b} \cdot \left(-1 + \sqrt{1 + \frac{2 \cdot b \cdot d}{\alpha_{el} \cdot A_{s1}}} \right) = \frac{6,25 \cdot 23,56}{100} \cdot \left(-1 + \sqrt{1 + \frac{2 \cdot 100 \cdot 22}{6,25 \cdot 23,56}} \right) = 6,71 \text{ (cm)}$$

$$\sigma_s = \frac{M_{Ed}}{z \cdot A_s} \approx \frac{M_{Ed}}{\left(d - \frac{x}{3} \right) \cdot A_s} = \frac{102,5 \cdot 100}{\left(22 - \frac{6,73}{3} \right) \cdot 23,56} = 22,02 \left(\frac{\text{kN}}{\text{cm}^2} \right) = 220,2 \text{ (MPa)}$$

$k_t = 0.4$ – Dugotrajno opterećenje

$E_s = 200.0$ GPa- modul elastičnosti armature

$E_{cm} = 32.80$ GPa- modul elastičnosti betona

Za C 30/37 $\rightarrow f_{ct,eff} = f_{ctm} = 2.9$ MPa

$$\rho_{p,eff} = \frac{A_s}{A_{c,eff}} = \frac{23,56}{100 \cdot 5,09} = 0,0463 - \text{Djelotvorni koeficijent armiranja glavnom vlačnom}$$

armaturom

$$\varepsilon_{sm} - \varepsilon_{cm} = \frac{220,2 - 0,4 \cdot \frac{2,9}{0,0463} (1 + 6,25 \cdot 0,0463)}{200000} \geq 0,6 \frac{220,2}{200000}$$

$$\frac{187,9}{200000} > \frac{132,12}{200000}$$

$$\varepsilon_{sm} - \varepsilon_{cm} = \frac{187,9}{200000} = 0,0009395$$

Srednji razmak pukotina

$$s_{r,max} = k_3 \cdot c + k_1 \cdot k_2 \cdot k_4 \cdot \frac{\phi}{\rho_{p,eff}} \quad (mm)$$

$\Phi = 20$ mm – Promjer najdeblje šipke

$c = 30$ mm – Zaštitni sloj uzdužne armature

$k_1 = 0,8$ – Rebrasta armatura

$k_2 = 0,5$ – Savijanje

$k_3 = 3,4$

$k_4 = 0,425$

$$s_{r,max} = 3,4 \cdot 30 + 0,8 \cdot 0,5 \cdot 0,425 \cdot \frac{20}{0,0463} = 175,43 (mm)$$

$$w_k = s_{r,max} \cdot (\varepsilon_{sm} - \varepsilon_{cm}) = 175,43 \cdot 0,0009395 = 0,16 mm < 0,30 mm$$

Odabrana armatura zadovoljava u pogledu širine pukotina!

10.1.1.3 Kontrola progiba pozicija 102

Progibi ploča su također dobiveni kroz numerički model. Također se koriste rezultati od kratkotrajnog djelovanja i radne kombinacije opterećenja ($q = 1,0 \cdot g + 1,0 \cdot p$).

U nastavku je izdvojen jedan dio ploče s najvećim pomacima.

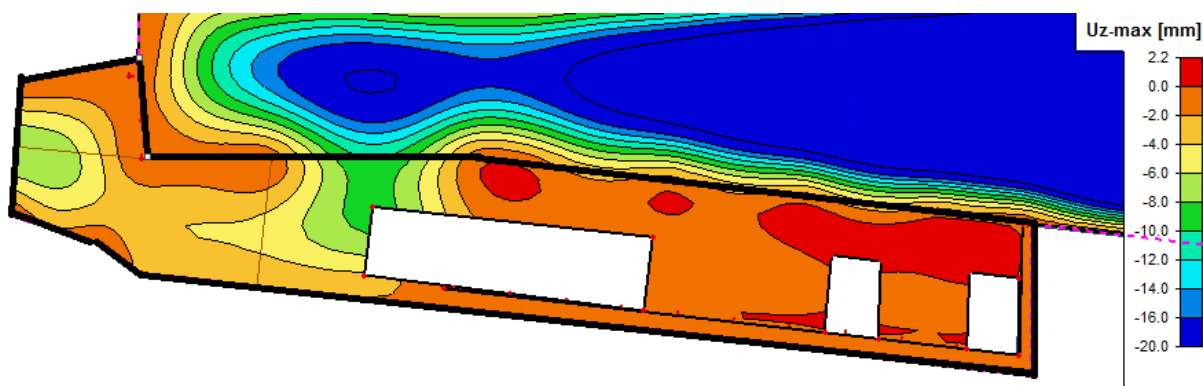

Slika 34: Progib [mm]

Maksimalan progib očekuje se u lijevom polju uz otvor:

$M_{1-1}=0\text{kNm}$ kombinacija za GSU

$M_{2-2}=45,9\text{kNm}$

$M_{3-3}=-102,5\text{kNm}$

odabrana mreža Q – 785 ($A_s=7,85\text{cm}^2$)

$A_{s1} = 7,85 \text{ cm}^2$

Progib bez utjecaja puzanja!

Granični progib:

$$v_{\text{lim}} = \frac{L}{250} = \frac{800}{250} = 3,2 \text{ cm}$$

Beton: C 30/37; $f_{ck}=30.0 \text{ MPa}$

$$E_{cm} = 9500 \cdot \sqrt[3]{f_{ck} + 8} = 9500 \cdot \sqrt[3]{30 + 8} \approx 31940 \text{ MPa}$$

$$f_{ct,m} = 0.3 \cdot (f_{ck})^{2/3} = 0.3 \cdot (30.0)^{2/3} = 2,89 \text{ MPa}$$

Čelik: B500B; $E_s=200.0 \text{ GPa}$

$$\alpha_{el} = \frac{E_s}{E_{cm}} = \frac{200,0}{32,0} = 6,25$$

$$v_{\text{tot}} = k \cdot L^2 \cdot \frac{1}{r_{\text{tot}}}$$

$$\beta = |M_{1-1} + M_{3-3}| / |M_{2-2}| = |0 + 102,5| / |45,9| = 2,23$$

$$k = \frac{5}{48} \cdot (1 - 0,1 \cdot \beta) = 0,104 \cdot (1 - 0,1 \cdot 2,23) = 0,0808$$

Srednja zakrivljenost u neraspucalom stanju:

$$\begin{aligned} I_I &= \frac{bh^3}{12} + \alpha_{el} \cdot \left[A_{s1} \cdot \left(\frac{h}{2} - d_2 \right)^2 + A_{s2} \cdot \left(\frac{h}{2} - d_1 \right)^2 \right] \\ &= \frac{100 \cdot 25^3}{12} + 6,25 \cdot \left[7,85 \cdot \left(\frac{25}{2} - 3 \right)^2 + 0 \right] = \\ &= 130208 + 4427,89 = 134635,89 \text{ cm}^4 \end{aligned}$$

$$M_{Ed} = M_{2-2} = 45,9 \text{ kNm}$$

$$E_{c,eff} = E_{cm} = 32,0 \text{ GN/m}^2 = 3200,0 \text{ kN/cm}^2$$

$$\frac{1}{r_I} = \frac{M_{Ed}}{E_{c,eff} \cdot I_I} = \frac{45,9 \cdot 100}{3200,0 \cdot 134635,89} = 0,0000107 \frac{1}{\text{cm}}$$

$$x = \frac{\alpha_{el} \cdot A_{s1}}{b} \cdot \left(-1 + \sqrt{1 + \frac{2 \cdot b \cdot d}{\alpha_{el} \cdot A_{s1}}} \right) = \frac{6,25 \cdot 7,85}{100} \cdot \left(-1 + \sqrt{1 + \frac{2 \cdot 100 \cdot 22}{6,25 \cdot 7,85}} \right) = 4,18 \text{ (cm)}$$

Srednja zakrivljenost u raspucalom stanju:

$$\begin{aligned} I_{II} &= \frac{bx^3}{12} + bx \cdot \left(\frac{x}{2} \right)^2 + \alpha_{el} \cdot \left[A_{s1} \cdot (d - x)^2 + A_{s2} \cdot (x - d_2)^2 \right] \\ &= \frac{100 \cdot 4,18^3}{12} + (100 \cdot 4,18) \cdot \left(\frac{4,18}{2} \right)^2 + 6,25 \cdot \left[7,85 \cdot (22 - 4,18)^2 \right] \\ &= 2334,49 + 15579,91 = 17914,4 \text{ cm}^4 \end{aligned}$$

$$\frac{1}{r_{II}} = \frac{M_{Ed}}{E_{c,eff} \cdot I_{II}} = \frac{45,9 \cdot 100}{3200 \cdot 17914,4} = 0,00008006 \frac{1}{\text{cm}}$$

$$\sigma_{sr} = \frac{M_{cr}}{z \cdot A_s} \quad ; \quad M_{cr} = f_{ctm} \cdot \frac{b \cdot h^2}{6} \quad ; \quad f_{ctm} \approx 0,3 \cdot (f_{ck})^{2/3} \quad ; \quad f_{ck} = 30,0 \text{ MPa}$$

$$f_{ctm} = 0,3 \cdot (f_{ck})^{2/3} = 0,3 \cdot (30,0)^{2/3} = 2,9 \text{ MPa}$$

$$M_{cr} = 0,29 \cdot \frac{100 \cdot 25^2}{6} = 3020,83 \text{ kNcm} = 30,2 \text{ kNm}$$

$$\sigma_{sr} = \frac{M_{cr}}{z \cdot A_s} \approx \frac{M_{cr}}{\left(d - \frac{x}{3} \right) \cdot A_s} = \frac{3020}{\left(22 - \frac{4,18}{3} \right) \cdot 7,85} = 18,66 \frac{\text{kN}}{\text{cm}^2} = 186,6 \text{ MPa}$$

$$\sigma_{s1} = \frac{M_{Ed}}{z \cdot A_{s1}} \approx \frac{M_{Ed}}{\left(d - \frac{x}{3} \right) \cdot A_{s1}} = \frac{45,9 \cdot 100}{\left(22 - \frac{4,18}{3} \right) \cdot 7,85} = 28,37 \frac{\text{kN}}{\text{cm}^2} = 283,7 \text{ MPa}$$

$$\frac{1}{r_I} = 0,0000107 \frac{1}{cm}$$

$$\frac{1}{r_{II}} = 0,00008006 \frac{1}{cm}$$

$$\zeta = 1 - \beta \cdot \left(\frac{\sigma_{sr}}{\sigma_s} \right)^2 = 1 - 0,5 \cdot \left(\frac{186,6}{283,7} \right)^2 = 0,76 - \text{koeficjent raspodjele}$$

$$\frac{1}{r_m} = \zeta \cdot \frac{1}{r_I} + (1 - \zeta) \cdot \frac{1}{r_{II}} = 0,76 \cdot 0,0000107 + (1 - 0,76) \cdot 0,00008006 = 0,0000273 \frac{1}{cm}$$

$$k = 0,0808$$

$$L = 800 \text{ cm}$$

$$v_{tot,t=0} = k \cdot L^2 \cdot \frac{1}{r_{tot}} = 0,0808 \cdot 800^2 \cdot 0,0000273 = 1,41 \text{ cm} < v_{lim} = 3,4 \text{ cm}$$

Odabrane dimezije ploče i armatura zadovoljavaju u pogledu progiba!

Ovakav proračun progiba je na strani sigurnosti. Iz estetskih razloga pri izradi dati nadvišenje ploče od 1.0 cm u sredini.

10.1.2 Proračun ploče pozicija 103 – granično stanje nosivosti

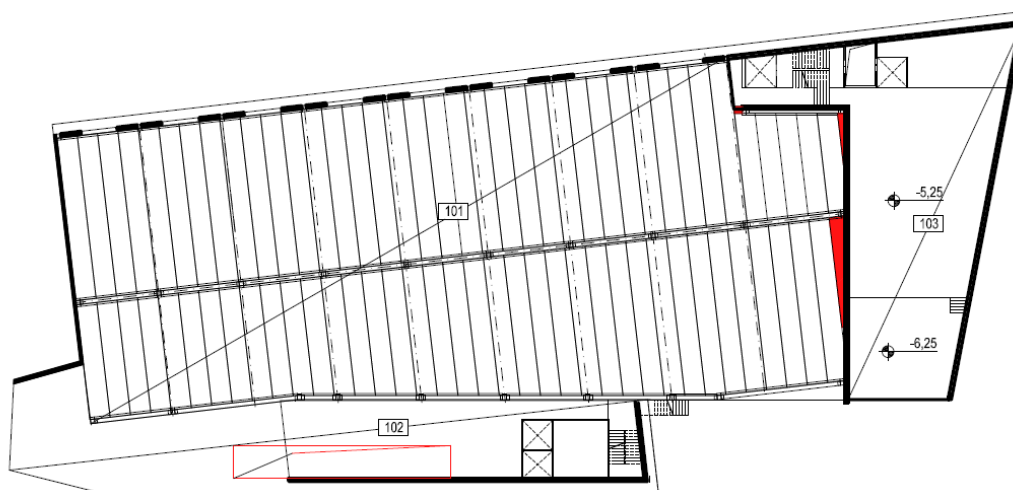

Slika 35: Prikaz pozicija 100

Relativne deformacije armature i betona:

$$\mu_{ed} = 0.159; \quad \zeta \approx 0.892 \quad \varepsilon_c / \varepsilon_s = 3.5/10.0$$

Momenti nosivosti betona i armature (prikazani u tablicama u nastavku):

$$M_{Ed,c,lim} = \mu_{Ed,lim} \cdot b_i \cdot d^2 \cdot f_{cd} = 0.159 \cdot b_i \cdot d^2 \cdot f_{cd}$$

$$M_{Ed,s,lims} = A_s \cdot \zeta \cdot d \cdot f_{yd}$$

Mjerodavna granična nosivost armiranobetonskog presjeka je manja od spomenutih vrijednosti.

Dimenzije poprečnog presjeka ploče (m'):

$$h_{ukupno} = 70 \text{ cm}; \quad d_{grede} = 63 \text{ cm}; \quad b = 30 \text{ cm}; \quad h_f = 20 \text{ cm}$$

Minimalna i maksimalna površina ramature:

$$A_{s1,min} = 0,1\% \cdot b \cdot h = 0,001 \cdot 20 \cdot 70 = 1,4 \text{ cm}^2$$

$$A_{s1,max} = 2,0\% \cdot b \cdot h = 0,020 \cdot 20 \cdot 70 = 28 \text{ cm}^2$$

Rezultati proračuna unutarnjih sila:

Prikazane su anvelope minimalnih i maksimalnih vrijednosti momenata savijanja od mjerodavnijih kombinacija za pojedini smjer.

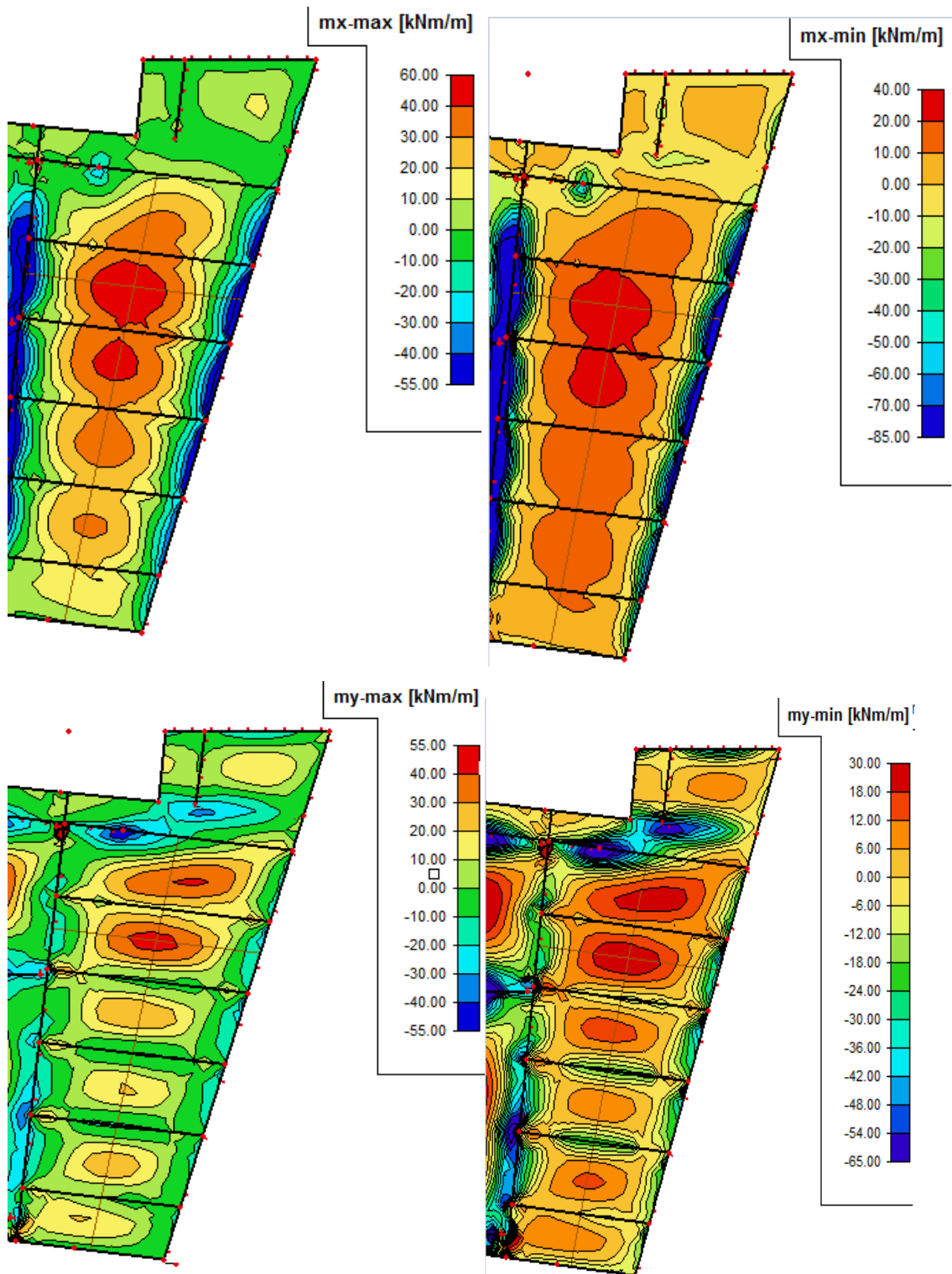

Slika 36: Prikaz maksimalnih i minimalnih momenata savijanja pozicije 103

Dimenzioniranje:

Donja zona (pozitivni moment savijanja) $\rightarrow M_{Ed,max} = 46,97 kNm$

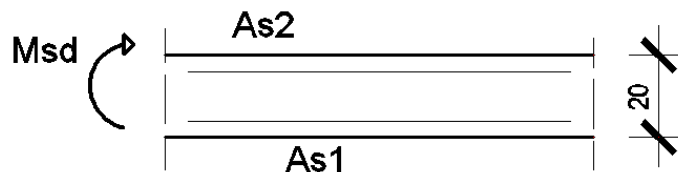

Slika 37: Skica položaja armature u donjoj zoni ploče poz 103

$$C\ 30/37 \quad f_{cd} = \frac{f_{ck}}{\gamma_c} = \frac{30}{1.5} = 20.0\ \text{MPa}; \quad f_{cd} = 2.0\ \text{kN/cm}^2$$

$$B\ 500 \quad f_{yd} = \frac{f_{yk}}{\gamma_s} = \frac{500}{1.15} = 435\ \text{MPa}; \quad f_{yd} = 43.5\ \text{kN/cm}^2$$

Mreža	Površina cm ² /m'	Moment nosivosti čelika	Moment nosivosti betona	Postotak armiranosti presjeka
		M _{Ed,s,lim} kNm	M _{Ed,c,lim} kNm	
Q-257	2,57	16,94	91,90	0,13
Q-283	2,83	18,66	91,90	0,14
Q-335	3,35	22,09	91,90	0,17
Q-385	3,85	25,38	91,90	0,19
Q-424	4,24	27,96	91,90	0,21
Q-503	5,03	33,16	91,90	0,25
Q-524	5,24	34,55	91,90	0,26
Q-636	6,36	41,93	91,90	0,32
Q-785	7,85	51,76	91,90	0,39

Tablica 4: Momenti nosivosti za odabranu mrežastu armaturu i betonski presjek

-odabrana mreža Q - 785 ($A_{s2} = 7,85\ \text{cm}^2$)

Zbog preraspodjele kod dugotrajnih efekata armatura u polju uvijek se uzima veća od izračunate.

Gornja zona (negativni moment savijanja) $\rightarrow M_{Ed,min} = 85,00 kNm$

Šipke	Mreža	Površina cm ² /m'	Moment nosivosti čelika	Moment nosivosti betona	Postotak armiranosti presjeka
			M _{Rd,s,lim} kNm	M _{Rd,c,lim} kNm	
0	R-785	7,85	51,76	91,90	0,39
1φ 16	R-785	9,86	65,01	91,90	0,49
2φ 16	R-785	11,87	78,26	91,90	0,59
3φ 16	R-785	13,88	91,52	91,90	0,69

Tablica 5: Momenti nosivosti za odabranu mrežastu armaturu i betonski presjek

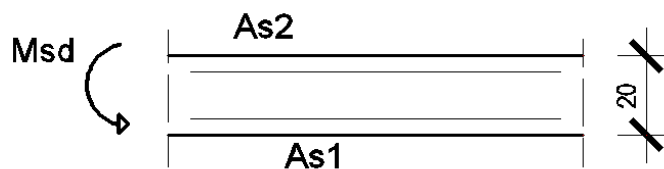

Slika 38: Skica položaja armature u gornjoj zoni ploče poz 103
-odabrana mreža R – 785 + 3Φ16 ($A_{s3} = 7,85 + 6,03 \text{ cm}^2$)

Napomena: Armaturu je potrebno po pripadnim tablicama smanjivati.

Prikaz potrebne površine armature:

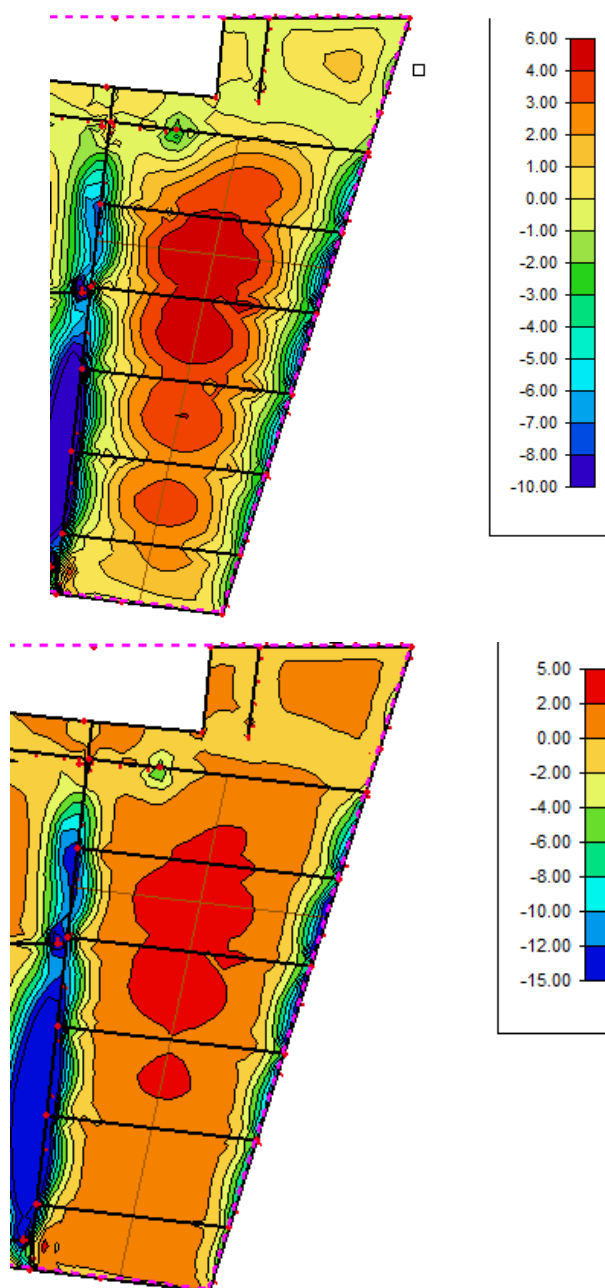

Slika 39: Armatura M_x max i min za poziciju 103

10.1.2.1 Kontrola pukotina u polju pozicija 103

Mjerodavni momenti u ploči su dobiveni kroz numerički model. Koriste se rezultati od kratkotrajnog djelovanja i radne kombinacije opterećenja ($e = 1.0 \cdot g + 1.0 \cdot \Delta g + 1.0 \cdot q$).

Granična vrijednost širine pukotine: $w_g = 0.3 \text{ mm}$ (EC-2 – uobičajena sredina)

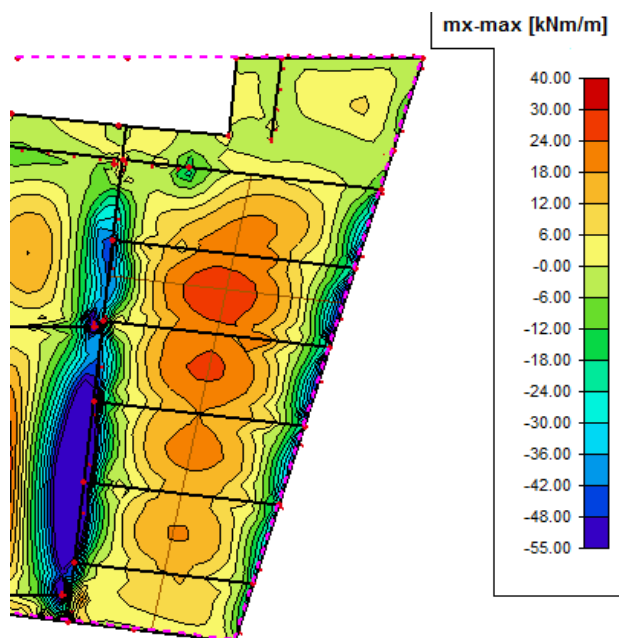

Slika 40: M_x max za kombinaciju GSU

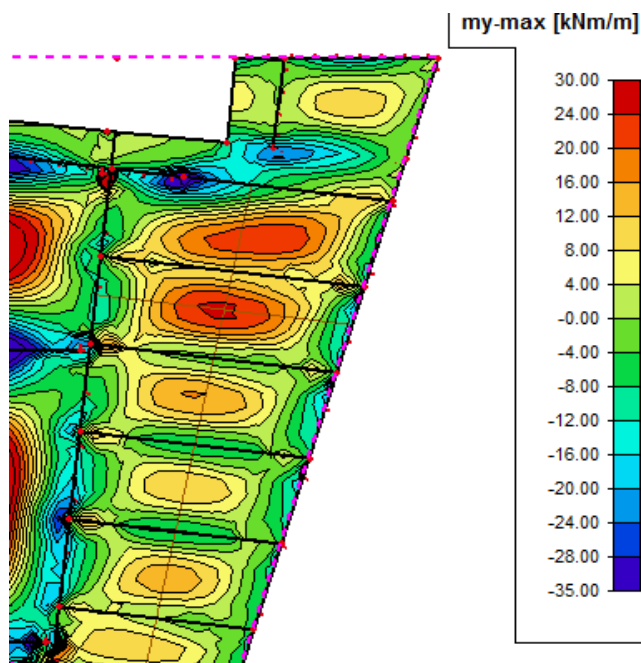

Slika 41: Maksimalni momenti za kombinaciju GSU

Proračunska vrijednost širine pukotine: (EC-2): $w_k = \beta \cdot s_{rm} \cdot \varepsilon_{sm} \leq w_g$

Maksimalni eksploatacijski (radni) moment u polju: $M_{Ed,max} = 27,67 \text{ kNm}$

Armatura ploče donja zona: Q - 785 ($A_s = 7,85 \text{ cm}^2$)

$A_{s1} = 7,85 \text{ cm}^2 / \text{m}$ $b=100 \text{ (cm)}$; $h=20 \text{ (cm)}$; $d_1=3 \text{ (cm)}$; $d=17 \text{ (cm)}$

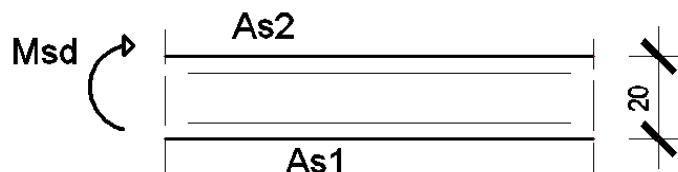

Slika 42: Skica armature u polju

Prognoza širine pukotina:

$$w_k = s_{r,max} \cdot (\varepsilon_{sm} - \varepsilon_{cm})$$

Proračun srednje deformacije armature:

$$\varepsilon_{sm} - \varepsilon_{cm} = \frac{\sigma_s - k_t \frac{f_{ct,eff}}{\rho_{p,eff}} (1 + \alpha_e \cdot \rho_{p,eff})}{E_s} \geq 0,6 \frac{\sigma_s}{E_s}$$

$$\alpha_e = \frac{E_s}{E_{cm}} = \frac{200}{32} = 6,25 \quad \text{- Odnos modula elastičnosti}$$

$$x = \xi \cdot d = 17 \cdot 0,259 = 4,403 \quad \text{- Položaj neutralne osi}$$

$$x = \frac{\alpha_{el} \cdot A_{s1}}{b} \cdot \left(-1 + \sqrt{1 + \frac{2 \cdot b \cdot d}{\alpha_{el} \cdot A_{s1}}} \right) = \frac{6,25 \cdot 7,85}{100} \cdot \left(-1 + \sqrt{1 + \frac{2 \cdot 100 \cdot 17}{6,25 \cdot 7,85}} \right) = 3,62 \text{ (cm)}$$

$$\sigma_s = \frac{M_{Ed}}{z \cdot A_s} \approx \frac{M_{Ed}}{\left(d - \frac{x}{3} \right) \cdot A_s} = \frac{27,67 \cdot 100}{\left(17 - \frac{3,62}{3} \right) \cdot 7,85} = 22,32 \left(\frac{\text{kN}}{\text{cm}^2} \right) = 223,2 \text{ (MPa)}$$

$k_t = 0,4$ – Dugotrajno opterećenje

$E_s = 200,0 \text{ GPa}$ - modul elastičnosti armature

$E_{cm} = 32,80 \text{ GPa}$ - modul elastičnosti betona

Za C 30/37 $\rightarrow f_{ct,eff} = f_{ctm} = 2,9 \text{ MPa}$

$$\rho_{p,eff} = \frac{A_s}{A_{c,eff}} = \frac{7,85}{100 \cdot 5,46} = 0,014 \quad \text{- Djelotvorni koeficijent armiranja glavnom vlačnom}$$

armaturom

$$\varepsilon_{sm} - \varepsilon_{cm} = \frac{223,2 - 0,4 \cdot \frac{2,9}{0,014} (1 + 6,25 \cdot 0,014)}{200000} \geq 0,6 \frac{223,2}{200000}$$

$$\frac{133,09}{200000} < \frac{133,92}{200000}$$

$$\varepsilon_{sm} - \varepsilon_{cm} = \frac{133,92}{200000} = 0,0006696$$

Srednji razmak pukotina

$$s_{r\max} = k_3 \cdot c + k_1 \cdot k_2 \cdot k_4 \cdot \frac{\phi}{\rho_{p,eff}} \quad (mm)$$

$\Phi = 10 \text{ mm}$ – Promjer najdeblje šipke

$c = 30 \text{ mm}$ – Zaštitni sloj uzdužne armature

$k_1 = 0.8$ – Rebrasta armatura

$k_2 = 0,5$ – Savijanje

$k_3 = 3.4$

$k_4 = 0.425$

$$s_{r\max} = 3,4 \cdot 30 + 0,8 \cdot 0,5 \cdot 0,425 \cdot \frac{10}{0,014} = 223,43 (mm)$$

$$w_k = s_{r\max} \cdot (\varepsilon_{sm} - \varepsilon_{cm}) = 223,43 \cdot 0,0006696 = 0,149 mm < 0,30 mm$$

Odobrana armatura zadovoljava u pogledu širine pukotina!

10.1.2.2 Kontrola pukotina na ležaju pozicija 103

Mjerodavni momenti u ploči su dobiveni kroz numerički model. Koriste se rezultati od kratkotrajnog djelovanja i radne kombinacije opterećenja ($e = 1.0 \cdot g + 1.0 \cdot \Delta g + 1.0 \cdot q$).

Granična vrijednost širine pukotine: $w_g = 0.3 \text{ mm}$ (EC-2 – uobičajena sredina)

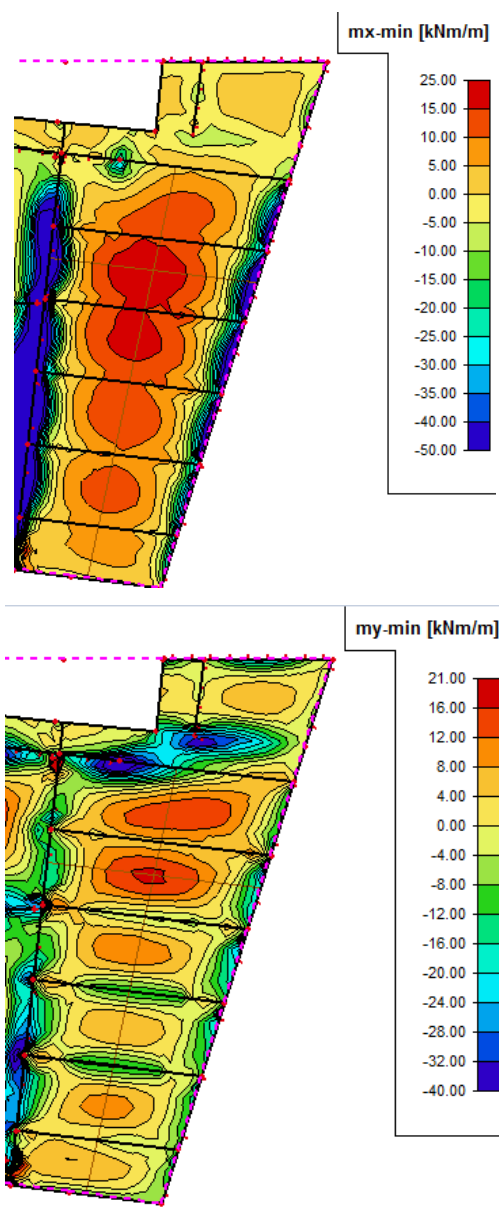

Slika 43: Minimalni momenti na poziciji 103 za GSU

Proračunska vrijednost širine pukotine: (EC-2): $w_k = \beta \cdot s_{rm} \cdot \varepsilon_{sm} \leq w_g$

Maksimalni eksploatacijski (radni) moment na ležaju: $Msd = 53,00 \text{ kNm/m}$

Armatura ploče gornja zona R – 785 + 3Φ16 ($A_{s3} = 7,85 + 6,03 \text{ cm}^2$)

$A_{s1} = 13,88 \text{ cm}^2 / \text{m}$ $b = 100 \text{ (cm)}$; $h = 20 \text{ (cm)}$; $d_1 = 3 \text{ (cm)}$; $d = 17 \text{ (cm)}$

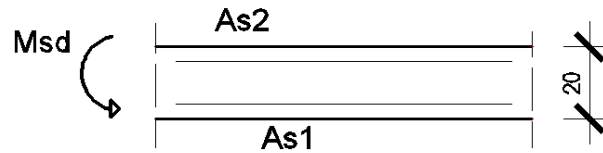

Slika 44: Skica armature na ležaju

Prognoza širine pukotina:

$$w_k = s_{r \max} \cdot (\varepsilon_{sm} - \varepsilon_{cm})$$

Proračun srednje deformacije armature:

$$\varepsilon_{sm} - \varepsilon_{cm} = \frac{\sigma_s - k_t \frac{f_{ct,eff}}{\rho_{p,eff}} (1 + \alpha_e \cdot \rho_{p,eff})}{E_s} \geq 0,6 \frac{\sigma_s}{E_s}$$

$$\alpha_e = \frac{E_s}{E_{cm}} = \frac{200}{32} = 6,25 \quad \text{- Odnos modula elastičnosti}$$

$$x = \xi \cdot d = 17 \cdot 0,259 = 4,403 \quad \text{- Položaj neutralne osi}$$

$$x = \frac{\alpha_{el} \cdot A_{s1}}{b} \cdot \left(-1 + \sqrt{1 + \frac{2 \cdot b \cdot d}{\alpha_{el} \cdot A_{s1}}} \right) = \frac{6,25 \cdot 13,88}{100} \cdot \left(-1 + \sqrt{1 + \frac{2 \cdot 100 \cdot 17}{6,25 \cdot 13,88}} \right) = 4,63 \text{ (cm)}$$

$$\sigma_s = \frac{M_{Ed}}{z \cdot A_s} \approx \frac{M_{Ed}}{\left(d - \frac{x}{3} \right) \cdot A_s} = \frac{53,00 \cdot 100}{\left(17 - \frac{4,63}{3} \right) \cdot 13,88} = 24,7 \left(\frac{kN}{cm^2} \right) = 247 \text{ (MPa)}$$

$k_t = 0,4$ – Dugotrajno opterećenje

$E_s = 200,0$ GPa- modul elastičnosti armature

$E_{cm} = 32,80$ GPa- modul elastičnosti betona

Za C 30/37 $\rightarrow f_{ct,eff} = f_{ctm} = 2,9$ MPa

$$\rho_{p,eff} = \frac{A_s}{A_{c,eff}} = \frac{13,88}{100 \cdot 5,12} = 0,027 \quad \text{- Djelotvorni koeficijent armiranja glavnom vlačnom}$$

armaturom

$$\varepsilon_{sm} - \varepsilon_{cm} = \frac{247 - 0,4 \frac{2,9}{0,027} (1 + 6,25 \cdot 0,027)}{200000} \geq 0,6 \frac{247}{200000}$$

$$\frac{196,79}{200000} > \frac{148,2}{200000}$$

$$\varepsilon_{sm} - \varepsilon_{cm} = \frac{196,79}{200000} = 0,000984$$

Srednji razmak pukotina

$$s_{r_{\max}} = k_3 \cdot c + k_1 \cdot k_2 \cdot k_4 \cdot \frac{\phi}{\rho_{p,eff}} \quad (mm)$$

$\Phi = 16 \text{ mm}$ – Promjer najdeblje šipke

$c = 30 \text{ mm}$ – Zaštitni sloj uzdužne armature

$k_1 = 0.8$ – Rebrasta armatura

$k_2 = 0.5$ – Savijanje

$k_3 = 3.4$

$k_4 = 0.425$

$$s_{r_{\max}} = 3,4 \cdot 30 + 0,8 \cdot 0,5 \cdot 0,425 \cdot \frac{16}{0,027} = 202,74 (mm)$$

$$w_k = s_{r_{\max}} \cdot (\varepsilon_{sm} - \varepsilon_{cm}) = 202,74 \cdot 0,000984 = 0,199 mm < 0,30 mm$$

Odabrana armatura zadovoljava u pogledu širine pukotina!

10.1.2.3 Kontrola progiba pozicija 103

Progibi ploča su također dobiveni kroz numerički model. Također se koriste rezultati od kratkotrajnog djelovanja i radne kombinacije opterećenja ($q = 1.0 \cdot g + 1.0 \cdot p$).

U nastavku je izdvojen jedan dio ploče s najvećim pomacima.

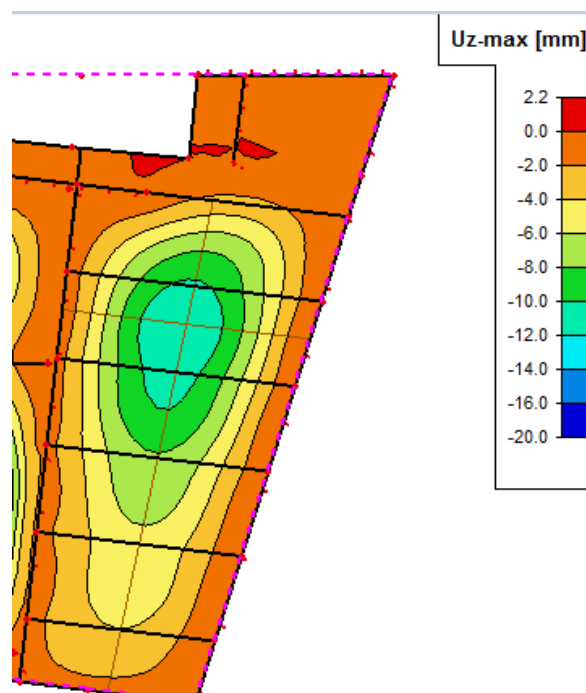

Slika 45: Progib [mm]

Maksimalan progib očekuje se u lijevom polju uz otvor:

$$M_{1-1} = -53,00 \text{ kNm} \quad \text{kombinacija za GSU}$$

$$M_{2-2} = 26,67 \text{ kNm}$$

$$M_{3-3} = -40,00 \text{ kNm}$$

odabrana mreža R – 785 + 3Φ16 ($A_{s3} = 7,85 + 6,03 \text{ cm}^2$)

$$A_{s1} = 13,88 \text{ cm}^2$$

Progib bez utjecaja puzanja!

Granični progib:

$$v_{\text{lim}} = \frac{L}{250} = \frac{1500}{250} = 6 \text{ cm}$$

Beton: C 30/37; $f_{ck} = 30,0 \text{ MPa}$

$$E_{cm} = 9500 \cdot \sqrt[3]{f_{ck} + 8} = 9500 \cdot \sqrt[3]{30 + 8} \approx 31940 \text{ MPa}$$

$$f_{ct,m} = 0,3 \cdot (f_{ck})^{2/3} = 0,3 \cdot (30,0)^{2/3} = 2,89 \text{ MPa}$$

Čelik: B500B; $E_s = 200,0 \text{ GPa}$

$$\alpha_{el} = \frac{E_s}{E_{cm}} = \frac{200,0}{32,0} = 6,25$$

$$v_{\text{tot}} = k \cdot L^2 \cdot \frac{1}{r_{\text{tot}}}$$

$$\beta = |M_{1-1} + M_{3-3}| / |M_{2-2}| = |53,00 + 40,00| / |26,67| = 3,49$$

$$k = \frac{5}{48} \cdot (1 - 0,1 \cdot \beta) = 0,104 \cdot (1 - 0,1 \cdot 3,49) = 0,068$$

Srednja zakrivljenost u neraspucalom stanju:

$$\begin{aligned}
 I_I &= \frac{bh^3}{12} + \alpha_{el} \cdot \left[A_{s1} \cdot \left(\frac{h}{2} - d_2 \right)^2 + A_{s2} \cdot \left(\frac{h}{2} - d_1 \right)^2 \right] \\
 &= \frac{100 \cdot 20^3}{12} + 6,25 \cdot \left[13,88 \cdot \left(\frac{20}{2} - 3 \right)^2 + 0 \right] = \\
 &= 70917,42 \text{ cm}^4
 \end{aligned}$$

$$M_{Ed} = M_{2-2} = 26,67 \text{ kNm}$$

$$E_{c,eff} = E_{cm} = 32,0 \text{ GN/m}^2 = 3200,0 \text{ kN/cm}^2$$

$$\frac{1}{r_I} = \frac{M_{Ed}}{E_{c,eff} \cdot I_I} = \frac{26,67 \cdot 100}{3200,0 \cdot 70917,42} = 0,0000118 \frac{1}{\text{cm}}$$

$$x = \frac{\alpha_{el} \cdot A_{s1}}{b} \cdot \left(-1 + \sqrt{1 + \frac{2 \cdot b \cdot d}{\alpha_{el} \cdot A_{s1}}} \right) = \frac{6,25 \cdot 13,88}{100} \cdot \left(-1 + \sqrt{1 + \frac{2 \cdot 100 \cdot 17}{6,25 \cdot 13,88}} \right) = 4,63 \text{ (cm)}$$

Srednja zakrivljenost u raspucalom stanju:

$$\begin{aligned}
 I_{II} &= \frac{bx^3}{12} + bx \cdot \left(\frac{x}{2} \right)^2 + \alpha_{el} \cdot \left[A_{s1} \cdot (d - x)^2 + A_{s2} \cdot (x - d_2)^2 \right] \\
 &= \frac{100 \cdot 4,63^3}{12} + (100 \cdot 4,63) \cdot \left(\frac{4,63}{2} \right)^2 + 6,25 \cdot \left[13,88 \cdot (17 - 4,63)^2 \right] \\
 &= 16582,64 \text{ cm}^4
 \end{aligned}$$

$$\frac{1}{r_{II}} = \frac{M_{Ed}}{E_{c,eff} \cdot I_{II}} = \frac{26,67 \cdot 100}{3200 \cdot 16582,64} = 0,0000502 \frac{1}{\text{cm}}$$

$$\sigma_{sr} = \frac{M_{cr}}{z \cdot A_s} \quad ; \quad M_{cr} = f_{ctm} \cdot \frac{b \cdot h^2}{6} \quad ; \quad f_{ctm} \approx 0,3 \cdot (f_{ck})^{2/3} \quad ; \quad f_{ck} = 30,0 \text{ MPa}$$

$$f_{ctm} = 0,3 \cdot (f_{ck})^{2/3} = 0,3 \cdot (30,0)^{2/3} = 2,9 \text{ MPa}$$

$$M_{cr} = 0,29 \cdot \frac{100 \cdot 20^2}{6} = 1933,33 \text{ kNcm} = 19,33 \text{ kNm}$$

$$\sigma_{sr} = \frac{M_{cr}}{z \cdot A_s} \approx \frac{M_{cr}}{\left(d - \frac{x}{3} \right) \cdot A_s} = \frac{1933}{\left(17 - \frac{4,63}{3} \right) \cdot 13,88} = 9,01 \frac{\text{kN}}{\text{cm}^2} = 90,1 \text{ MPa}$$

$$\sigma_{s1} = \frac{M_{Ed}}{z \cdot A_{s1}} \approx \frac{M_{Ed}}{\left(d - \frac{x}{3} \right) \cdot A_{s1}} = \frac{26,67 \cdot 100}{\left(17 - \frac{4,63}{3} \right) \cdot 13,88} = 12,43 \frac{\text{kN}}{\text{cm}^2} = 124,3 \text{ MPa}$$

$$\frac{1}{r_I} = 0,0000118 \frac{1}{cm}$$

$$\frac{1}{r_{II}} = 0,0000502 \frac{1}{cm}$$

$$\zeta = 1 - \beta \cdot \left(\frac{\sigma_{sr}}{\sigma_s} \right)^2 = 1 - 0,5 \cdot \left(\frac{90,1}{124,3} \right)^2 = 0,74 - \text{koeficijent raspodjele}$$

$$\frac{1}{r_m} = \zeta \cdot \frac{1}{r_I} + (1 - \zeta) \cdot \frac{1}{r_{II}} = 0,74 \cdot 0,0000118 + (1 - 0,74) \cdot 0,0000502 = 0,0000218 \frac{1}{cm}$$

$$k = 0,068$$

$$L = 1500 \text{ cm}$$

$$v_{tot,t=0} = k \cdot L^2 \cdot \frac{1}{r_{tot}} = 0,068 \cdot 1500^2 \cdot 0,0000218 = 3,34 \text{ cm} < v_{lim} = 6 \text{ cm}$$

Odabrane dimezije ploče i armatura zadovoljavaju u pogledu progiba!

Ovakav proračun progiba je na strani sigurnosti. Iz estetskih razloga pri izradi ploče predvidjeti nadvišenje od 2.0 cm u sredini.

10.1.2.4 Moment u gredi – pozicija 106

Donja zona (moment savijanja) $\rightarrow M_{Ed,min} = 716,14 \text{ kNm}$

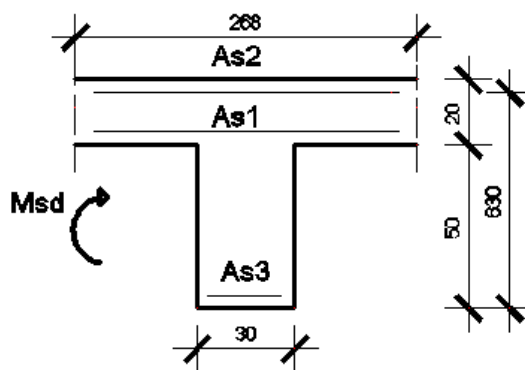

Slika 46: Skica armature pozicije 106

$$h_{uk} = 70 \text{ cm}; \quad d = 63 \text{ cm}; \quad b = 30 \text{ cm}; \quad h_f = 20 \text{ cm}; \quad b_{eff} = 268 \text{ cm}$$

$$b_{eff} = b_0 + \frac{l_0}{5} \leq e \Rightarrow b_{eff} = 30 + \frac{0,85 \cdot 1400}{5} = 268 \text{ cm} < 500 \text{ cm}$$

$$\mu_{sd} = \frac{M_{Ed}}{b_{eff} \cdot d^2 \cdot f_{cd}} = \frac{71614}{268 \cdot 67^2 \cdot 2,0} = 0,0297$$

$$\text{Očitano: } \varepsilon_{s1} = 10,0\text{‰} \quad \varepsilon_{c2} = 1,0\text{‰} \quad \xi = 0,091 \quad \zeta = 0,968$$

$$x = \xi \cdot d = 0,091 \cdot 67 = 6,097 \text{ cm} < h_{pl}$$

$$A_{s3} = \frac{M_{Ed}}{\zeta \cdot d \cdot f_{yd}} = \frac{71614}{0,968 \cdot 67 \cdot 43,5} = 25,3 \text{ cm}^2$$

Odabrano 7Ø22 ($A_{s3}=26,61 \text{ cm}^2$)

Šipke	Površina	Moment nosivosti čelika	Moment nosivosti betona	Postotak armirano sti
	cm ² /m'	MRd,s,lim	MRd,c,lim	
		kNm	kNm	
5φ 22	19,01	493,98	1427,50	0,91
6φ 22	22,81	592,73	1427,50	1,09
7φ 22	26,61	691,47	1427,50	1,27

Tablica 6: Momenti nosivosti za odabrani betonski presjek i armaturu

10.1.2.5 Dimenzioniranje na poprečnu silu

Presjek - ležaj

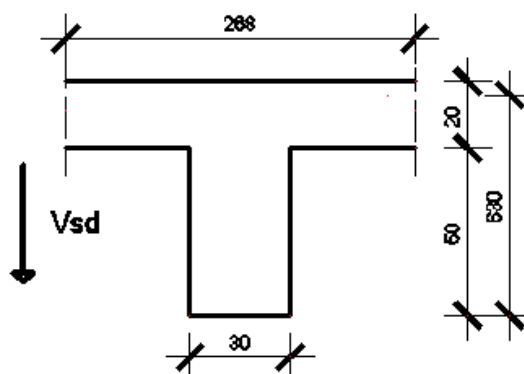

Slika 47: Poprečni presjek pozicije 106

$$V_{Ed} = -481,84 \text{ kN}$$

$$A_s = 7\phi 22 + (7,85/100) \cdot 30 + ((7,85 + 6,03)/100) \cdot 30 = 33,13 \text{ cm}^2$$

Dio poprečne sile koju preuzima beton i uzdužna armatura:

$$V_{Rd,C} = \left[C_{Rd,C} \cdot k \cdot (100 \cdot \rho_l \cdot f_{ck})^{1/3} + k_1 \cdot \sigma_{cp} \right] \cdot b_w \cdot d$$

$$k = 1,0 + \sqrt{\frac{200}{d}} = 1,0 + \sqrt{\frac{200}{670}} = 1,55 \leq 2,0$$

$$k_1 = 0,15$$

$$\sigma_{cp} = N_{sd} / A_c = 0,0$$

$$C_{Rd,C} = 0,18 / \gamma_c = 0,18 / 1,5 = 0,12$$

$$\sum A_s \approx 25,53 \text{ cm}^2 \quad \rho_l = \frac{\sum A_s}{A_c} = \frac{33,13}{70 \cdot 30} = 0,016$$

$$V_{Rd,C} = \left[0,12 \cdot 1,55 \cdot (100 \cdot 0,016 \cdot 30)^{1/3} + 0,15 \cdot 0,0 \right] \cdot 300 \cdot 670 = 135869,74 \text{ N} = 135,87 \text{ kN}$$

$$V_{Rd,C(\min)} = \left[v_{\min} + k_1 \cdot \sigma_{cp} \right] \cdot b_w \cdot d = \left[0,302 + 0,15 \cdot 0 \right] \cdot 300 \cdot 670 = 60702 \text{ N} = 60,702 \text{ kN}$$

$$v_{\min} = 0,035 \cdot k^{3/2} \cdot f_{cd}^{1/2} = 0,035 \cdot 1,55^{3/2} \cdot 20^{1/2} = 0,302$$

$$V_{Ed} > V_{Rd,C}$$

$$V_{Rd,\max} = 0,5 \cdot v \cdot b_w \cdot d \cdot f_{cd} = 0,5 \cdot 0,528 \cdot 300 \cdot 670 \cdot 20 = 1061280 \text{ N} = 1061,3 \text{ kN} > V_{Ed}$$

$$v = 0,6 \left[1 - \frac{f_{ck}}{250} \right] = 0,6 \left[1 - \frac{30}{250} \right] = 0,528$$

Potrebna računaska poprečna armatura

$$V_{Ed} / V_{Rd,\max} = 481,84 / 1061,28 \approx 0,45 \Rightarrow V_{Ed} = 0,45 V_{Rd2}$$

$$s_{w,\max} = \min \{ 0,6 \cdot d; 30,0 \text{ cm} \} = \min \{ 0,6 \cdot 67 = 40,2; 30,0 \} \Rightarrow s_{w,\max} = 30,0 \text{ cm}$$

$$\rho_{\min} = 0,0011 \quad (C30/37)$$

$$A_{sw,\min} = \frac{\rho_{\min} \cdot s_w \cdot b_w}{m} = \frac{0,0011 \cdot 30 \cdot 30}{2} = 0,495 \text{ cm}^2$$

Odabrane spone $\varnothing 10$ ($A_{sw} = 0,79 \text{ cm}^2$):

$$s_{w,pot} \leq \frac{m \cdot A_{sw,\min}}{\rho_{\min} \cdot b_w} = \frac{2 \cdot 0,79}{0,0011 \cdot 30} = 47,88 \text{ cm}$$

Odabrane spone $\varnothing 10/30$, $m=2$

Ukupna nosivost betona i odabrane poprečne armature:

$$V_{Rd} = V_{Rd,s} = \frac{A_{sw}}{S} \cdot z \cdot f_{ywd} \cdot m \cdot ctg \Theta = \frac{0,79}{30} \cdot (0,9 \cdot 70) \cdot 43,48 \cdot 2 \cdot 1 = 144,26 \text{ kN}$$

$$V_{Ed} > V_{Rd}$$

Kontroliramo nosivost betona:

$$V_{Rd,max} = \frac{\alpha_{cw} \cdot b_w \cdot z \cdot v_1 \cdot f_{cd}}{\tan \Theta + ctg \Theta} = \frac{1,0 \cdot 300 \cdot 60,3 \cdot 0,6 \cdot 20}{1+1} = 1085,4 kN > V_{Ed}$$

Na mjestu maksimalne poprečne sile:

$$S_{pot} \leq \frac{m \cdot A_{sw} \cdot f_{yw,d} \cdot z}{V_{Ed}} = \frac{2 \cdot 0,79 \cdot 43,5 \cdot 60,3}{481,84} = 8,6 cm$$

odabrane spona na mjestu velike poprečne sile $\varnothing 10/8$ ($A_{sw}=0,79 cm^2$)

10.1.3 Kontrola pukotina gređa pozicija 100

Granična širina pukotina prema EC-2 za uobičajenu sredinu iznosi $w_g=0.3$ mm. Odabrana vlačna armatura za polje je $7\Phi 22$ ($A_s=26,61$ cm²).

$M_{Ed,2-2}=415,2$ kNm - za granično stanje uporabljivosti

$b=30$ (cm); $h=70$ (cm); $d_1=3$ (cm); $d=67$ (cm)

Prognoza širine pukotina:

$$w_k = s_{r,max} \cdot (\varepsilon_{sm} - \varepsilon_{cm})$$

Proračun srednje deformacije armature:

$$\varepsilon_{sm} - \varepsilon_{cm} = \frac{\sigma_s - k_t \frac{f_{ct,eff}}{\rho_{p,eff}} (1 + \alpha_e \cdot \rho_{p,eff})}{E_s} \geq 0,6 \frac{\sigma_s}{E_s}$$

$$x = \frac{\alpha_{el} \cdot A_{s1}}{b} \cdot \left(-1 + \sqrt{1 + \frac{2 \cdot b \cdot d}{\alpha_{el} \cdot A_{s1}}} \right) = \frac{6,25 \cdot 26,61}{30} \cdot \left(-1 + \sqrt{1 + \frac{2 \cdot 30 \cdot 67}{6,25 \cdot 26,61}} \right) = 22,27 (cm)$$

$$\sigma_s = \frac{M_{Ed}}{z \cdot A_s} \approx \frac{M_{Ed}}{\left(d - \frac{x}{3} \right) \cdot A_s} = \frac{415,2 \cdot 100}{\left(67 - \frac{22,27}{3} \right) \cdot 26,61} = 26,19 \left(\frac{kN}{cm^2} \right) = 261,9 (MPa)$$

$k_t = 0.4$ – Dugotrajno opterećenje

$E_s = 200.0$ GPa- modul elastičnosti armature

$E_{cm} = 32.80$ GPa- modul elastičnosti betona

Za C 30/37 $\rightarrow f_{ct,eff} = f_{ctm} = 2.9 \text{ MPa}$

$$\alpha_e = \frac{E_s}{E_{cm}} = \frac{200}{32} = 6,25 \quad \text{- Odnos modula elastičnosti}$$

$$\rho_{p,eff} = \frac{A_s}{A_{c,eff}} = \frac{26,61}{30 \cdot 13} = 0,068 \quad \text{- Djelotvorni koeficijent armiranja glavnom vlačnom}$$

armaturom

$$\varepsilon_{sm} - \varepsilon_{cm} = \frac{261,9 - 0,4 \cdot \frac{2,9}{0,68} (1 + 6,25 \cdot 0,068)}{200000} \geq 0,6 \frac{216,9}{200000}$$

$$\frac{259,47}{200000} \geq \frac{130,14}{200000}$$

$$\varepsilon_{sm} - \varepsilon_{cm} = \frac{259,47}{200000} = 0,0013$$

Srednji razmak pukotina

$$s_{r,max} = k_3 \cdot c + k_1 \cdot k_2 \cdot k_4 \cdot \frac{\phi}{\rho_{p,eff}} \quad (mm)$$

$\Phi = 22 \text{ mm}$ – Promjer najdeblje šipke

$c = 30 \text{ mm}$ – Zaštitni sloj uzdužne armature

$k_1 = 0.8$ – Rebrasta armatura

$k_2 = 0,5$ – Savijanje

$k_3 = 3.4$

$k_4 = 0.425$

$$s_{r,max} = 3,4 \cdot 30 + 0,8 \cdot 0,5 \cdot 0,425 \cdot \frac{22}{0,068} = 157 (mm)$$

$$w_k = s_{r,max} \cdot (\varepsilon_{sm} - \varepsilon_{cm}) = 157 \cdot 0,0013 = 0,203 mm < 0,30 mm$$

Odabrana armatura zadovoljava u pogledu širine pukotina

10.1.4 Kontrola progiba grede pozicija 106

Maksimalan progib očekuje se u vanjskim poljima:

$$M_{1-1} = -320,08 \text{ kNm}$$

$$M_{2-2} = 415,2 \text{ kNm} \quad \text{kombinacija za GSU}$$

$$M_{3-3} = -334,83 \text{ kNm}$$

$$A_{s1} = Q - 785 = 7,85 \text{ cm}^2/\text{m}' = 2,36 \text{ cm}^2$$

$$A_{s2} = Q - 785 + 3\varnothing 16 = 7,85 + 6,03 = 13,88 \text{ cm}^2/\text{m}' = 4,14 \text{ cm}^2$$

$$A_{s2} = 7\varnothing 22 = 26,61 \text{ cm}^2$$

Progib bez utjecaja puzanja!

Granični progib:

$$v_{\text{lim}} = \frac{L}{250} = \frac{1400}{250} = 5,6 \text{ cm}$$

Beton: C 30/37; $f_{ck} = 30,0 \text{ MPa}$

$$E_{cm} = 9500 \cdot \sqrt[3]{f_{ck} + 8} = 9500 \cdot \sqrt[3]{30 + 8} \approx 31940 \text{ MPa}$$

$$f_{ct,m} = 0,3 \cdot (f_{ck})^{2/3} = 0,3 \cdot (30,0)^{2/3} = 2,89 \text{ MPa}$$

Čelik: B500B; $E_s = 200,0 \text{ GPa}$

$$\alpha_{el} = \frac{E_s}{E_{cm}} = \frac{200,0}{32,0} = 6,25$$

$$v_{\text{tot}} = k \cdot L^2 \cdot \frac{1}{r_{\text{tot}}}$$

$$\beta = |M_{1-1} + M_{3-3}| / |M_{2-2}| = |320,08 + 334,83| / |415,2| = 1,58$$

$$k = \frac{5}{48} \cdot (1 - 0,1 \cdot \beta) = 0,104 \cdot (1 - 0,1 \cdot 1,58) = 0,088$$

Srednja zakrivljenost u neraspucalom stanju:

$$\begin{aligned}
 I_I &= \frac{bh^3}{12} + \alpha_{el} \cdot \left[A_{s1} \cdot \left(\frac{h}{2} - d_2 \right)^2 + A_{s2} \cdot \left(\frac{h}{2} - d_1 \right)^2 \right] \\
 &= \frac{30 \cdot 70^3}{12} + 6,25 \cdot \left[2,36 \cdot \left(\frac{70}{2} - 5 \right)^2 + 26,61 \cdot \left(\frac{70}{2} - 3 \right)^2 \right] = \\
 &= 857500 + 183579 = 1041079 \text{ cm}^4
 \end{aligned}$$

$$M_{Ed} = M_{2-2} = 415,2 \text{ kNm}$$

$$E_{c,eff} = E_{cm} = 32,0 \text{ GN/m}^2 = 3200,0 \text{ kN/cm}^2$$

$$\frac{1}{r_I} = \frac{M_{Ed}}{E_{c,eff} \cdot I_I} = \frac{415,2 \cdot 100}{3200,0 \cdot 1041079} = 0,0000126 \frac{1}{\text{cm}}$$

$$x = \frac{\alpha_{el} \cdot A_{s1}}{b} \cdot \left(-1 + \sqrt{1 + \frac{2 \cdot b \cdot d}{\alpha_{el} \cdot A_{s1}}} \right) = \frac{6,25 \cdot 2,36}{30} \cdot \left(-1 + \sqrt{1 + \frac{2 \cdot 30 \cdot 67}{6,25 \cdot 2,36}} \right) = 7,64 \text{ (cm)}$$

Srednja zakrivljenost u raspucalom stanju:

$$\begin{aligned}
 I_{II} &= \frac{bx^3}{12} + bx \cdot \left(\frac{x}{2} \right)^2 + \alpha_{el} \cdot \left[A_{s1} \cdot (d - x)^2 + A_{s2} \cdot (x - d_2)^2 \right] \\
 &= \frac{30 \cdot 7,64^3}{12} + (30 \cdot 7,64) \cdot \left(\frac{7,64}{2} \right)^2 + 6,25 \cdot \left[2,36 \cdot (67 - 7,64)^2 + 26,61 \cdot (7,64 - 5)^2 \right] \\
 &= 4459,44 + 53132,37 = 57591,81 \text{ cm}^4
 \end{aligned}$$

$$\frac{1}{r_{II}} = \frac{M_{Ed}}{E_{c,eff} \cdot I_{II}} = \frac{415,2 \cdot 100}{3200 \cdot 57591,81} = 0,000225 \frac{1}{\text{cm}}$$

$$\sigma_{sr} = \frac{M_{cr}}{z \cdot A_s} ; \quad M_{cr} = f_{ctm} \cdot \frac{b \cdot h^2}{6} ; \quad f_{ctm} \approx 0,3 \cdot (f_{ck})^{2/3} ; \quad f_{ck} = 30,0 \text{ MPa}$$

$$f_{ctm} = 0,3 \cdot (f_{ck})^{2/3} = 0,3 \cdot (30,0)^{2/3} = 2,9 \text{ MPa}$$

$$M_{cr} = 0,29 \cdot \frac{30 \cdot 70^2}{6} = 7105 \text{ kNcm} = 71,05 \text{ kNm}$$

$$\sigma_{sr} = \frac{M_{cr}}{z \cdot A_s} \approx \frac{M_{cr}}{\left(d - \frac{x}{3} \right) \cdot A_s} = \frac{7105}{\left(67 - \frac{7,64}{3} \right) \cdot 26,61} = 4,14 \frac{\text{kN}}{\text{cm}^2} = 41,4 \text{ MPa}$$

$$\sigma_{s1} = \frac{M_{Ed}}{z \cdot A_{s1}} \approx \frac{M_{Ed}}{\left(d - \frac{x}{3} \right) \cdot A_{s1}} = \frac{415,2 \cdot 100}{\left(67 - \frac{7,64}{3} \right) \cdot 26,61} = 24,21 \frac{\text{kN}}{\text{cm}^2} = 242,1 \text{ MPa}$$

$$\frac{1}{r_I} = 0,0000126 \frac{1}{cm}$$

$$\frac{1}{r_{II}} = 0,000225 \frac{1}{cm}$$

$$\zeta = 1 - \beta_1 \cdot \beta_2 \cdot \left(\frac{\sigma_{sr}}{\sigma_s} \right)^2 = 1 - 1,0 \cdot 0,5 \cdot \left(\frac{41,4}{242,1} \right)^2 = 0,99 - \text{koeficijent raspodjele}$$

$$\frac{1}{r_m} = \zeta \cdot \frac{1}{r_I} + (1 - \zeta) \cdot \frac{1}{r_{II}} = 0,99 \cdot 0,0000126 + (1 - 0,99) \cdot 0,000225 = 0,0000147 \frac{1}{cm}$$

$$k = 0,088$$

$$L = 1400,0 \text{ cm}$$

$$v_{tot,t=0} = k \cdot L^2 \cdot \frac{1}{r_{tot}} = 0,088 \cdot 1400^2 \cdot 0,0000147 = 2,54 \text{ cm} < v_{lim} = 5,6 \text{ cm}$$

Odabrane dimezije grede i armatura zadovoljavaju u pogledu progiba!

10.1.5 Proračun ploče pozicija 201 – granično stanje nosivosti

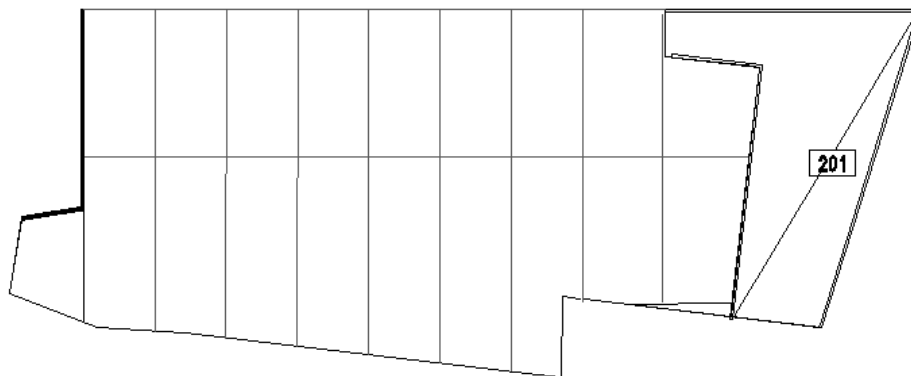

Slika 48: Prikaz pozicija 200

Relativne deformacije armature i betona:

$$\mu_{ed} = 0,159; \quad \zeta \approx 0,892 \quad \varepsilon_c / \varepsilon_s = 3,5 / 10,0$$

Momenti nosivosti betona i armature (prikazani u tablicama u nastavku):

$$M_{Ed,c,lim} = \mu_{Ed,lim} \cdot b \cdot d^2 \cdot f_{cd} = 0,159 \cdot b \cdot d^2 \cdot f_{cd}$$

$$M_{Ed,s,lims} = A_s \cdot \zeta \cdot d \cdot f_{yd}$$

Mjerodavna granična nosivost armiranobetonskog presjeka je manja od spomenutih vrijednosti.

Dimenzije poprečnog presjeka ploče (m²):

$$b=100 \text{ cm} \quad h=20 \text{ cm}; \quad d=17 \text{ cm}$$

Minimalna i maksimalna površina armature:

$$A_{s1,\min} = 0,1\% b h = 0,001 \cdot 100 \cdot 20 = 2 \text{ cm}^2$$

$$A_{s1,\max} = 2,0\% b h = 0,020 \cdot 100 \cdot 20 = 40,0 \text{ cm}^2$$

Rezultati proračuna unutarnjih sila:

Prikazane su anvelope minimalnih i maksimalnih vrijednosti momenata savijanja od mjerodavnijih kombinacija za pojedini smjer.

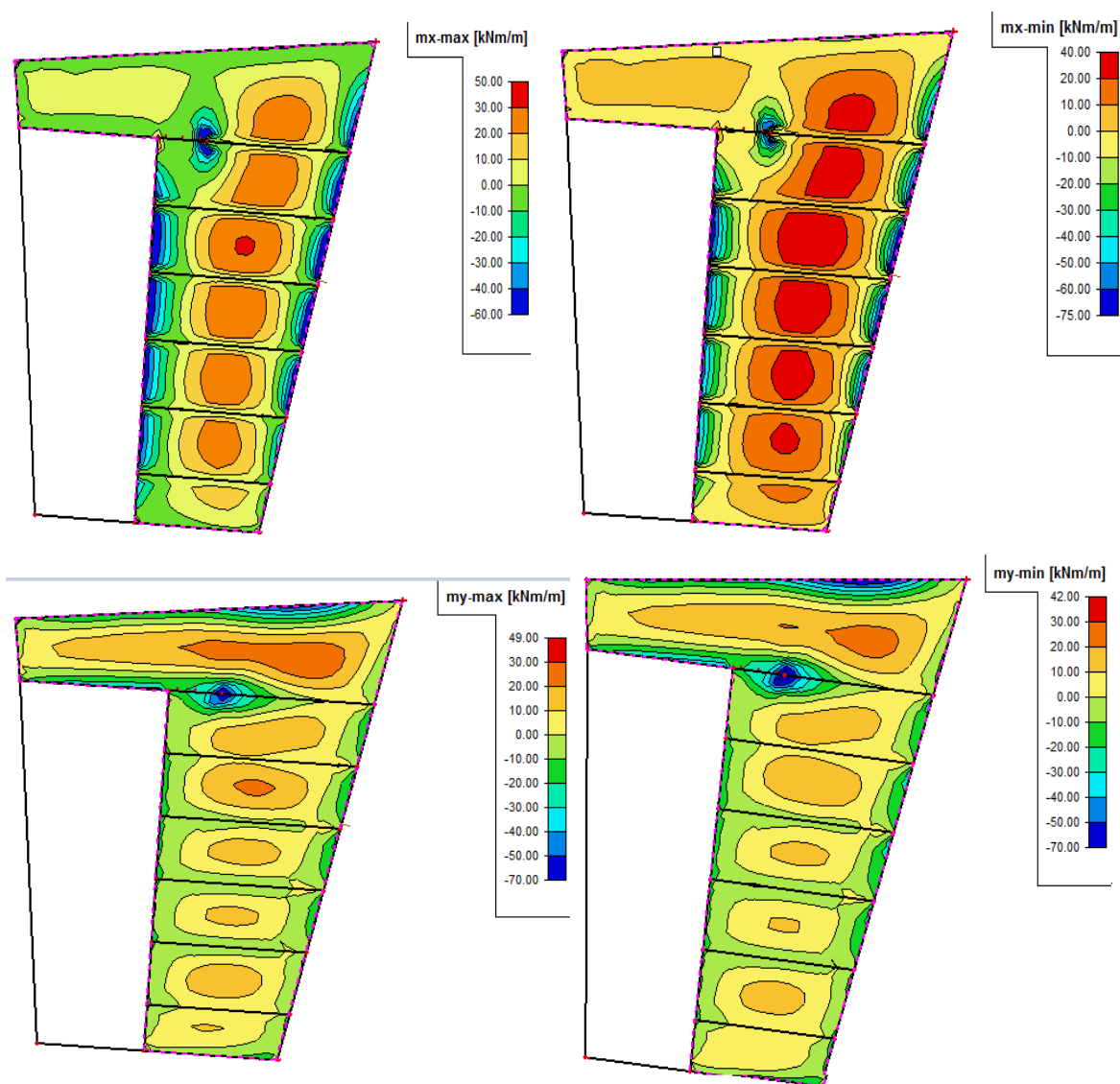

Slika 49: Prikaz minimalnih i maksimalnih momenata savijanja pozicije 201

Dimenzioniranje ploče:

Donja zona (pozitivni moment savijanja) $\rightarrow M_{Ed,max} = 50,00kNm$

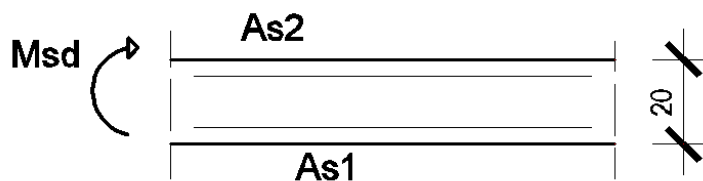

Slika 50: Skica položaja armature u donjoj zoni ploče

$$C\ 30/37 \quad f_{cd} = \frac{f_{ck}}{\gamma_c} = \frac{30}{1.5} = 20.0\ \text{MPa}; \quad f_{cd} = 2.0\ \text{kN/cm}^2$$

$$B\ 500 \quad f_{yd} = \frac{f_{yk}}{\gamma_s} = \frac{500}{1.15} = 435\ \text{MPa}; \quad f_{yd} = 43.5\ \text{kN/cm}^2$$

Mreža	Površina	Moment nosivosti čelika	Moment nosivosti betona	Postotak armiranosti presjeka
	cm ² /m'	M _{Ed,s,lim} kNm	M _{Ed,c,lim} kNm	
Q-257	2,57	16,94	91,90	0,13
Q-283	2,83	18,66	91,90	0,14
Q-335	3,35	22,09	91,90	0,17
Q-385	3,85	25,38	91,90	0,19
Q-424	4,24	27,96	91,90	0,21
Q-503	5,03	33,16	91,90	0,25
Q-524	5,24	34,55	91,90	0,26
Q-636	6,36	41,93	91,90	0,32
Q-785	7,85	51,76	91,90	0,39

Tablica 7: Momenti nosivosti za odabranu mrežastu armaturu i betonski presjek

-odabrana mreža Q – 785 ($A_s=7,85\ \text{cm}^2$)

Zbog preraspodjele kod dugotrajnih efekata armatura u polju uvijek se uzima veća od izračunate, a armatura na ležajevima u skladu s izračunatom.

Gornja zona (negativni moment savijanja) $\rightarrow M_{Ed,min} = 75,0kNm$

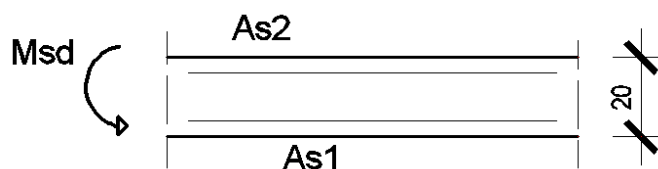

Slika 51: Skica položaja armature u gornjoj zoni ploče

Šipke	Mreža	Površina cm ² /m'	Moment nosivosti čelika	Moment nosivosti betona	Postotak armirano sti
			MRd,s,lim kNm	MRd,c,lim kNm	
2Φ 16	Q-503	9,05	59,67	91,90	0,45
2Φ 16	Q-524	9,26	61,05	91,90	0,46
2Φ 16	Q-636	10,38	68,44	91,90	0,52
2Φ 16	Q-785	11,87	78,26	91,90	0,59

Tablica 8: Momenti nosivosti za odabranu mrežastu armaturu i betonski presjek

-odabrane mreže:

Q – 785 + 2Φ16 ($A_s = 7,85 + 4,02\text{cm}^2$)- za područje momenata savijanja 75kNm

Armaturu je potrebno po pripadnim tablicama smanjivati.

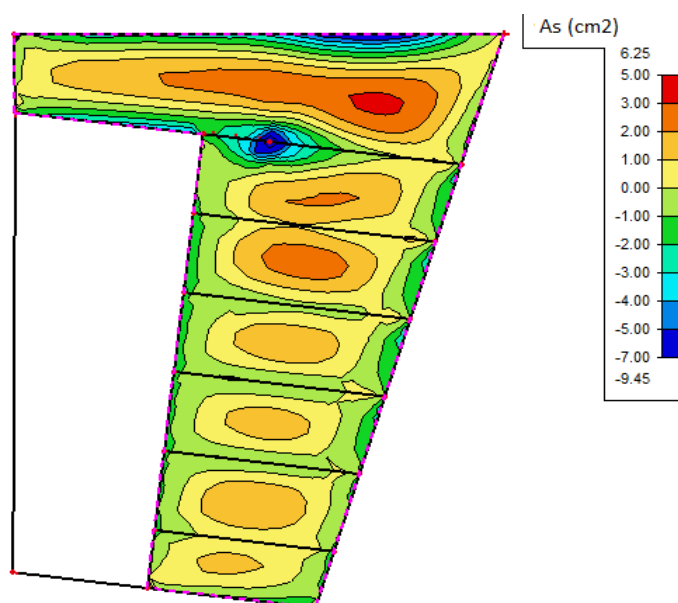

Slika 52: Armatura M_y max

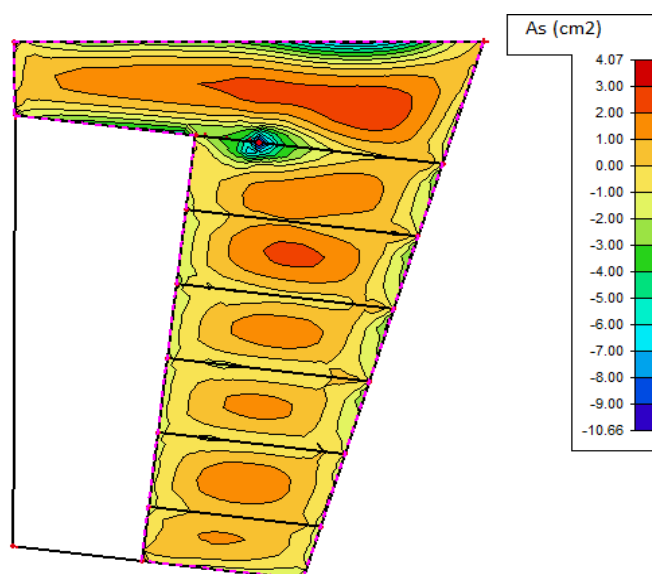

Slika 53: Armatura M_y min

10.1.5.1 Kontrola pukotina u polju

Mjerodavni momenti u ploči su dobiveni kroz numerički model. Koriste se rezultati od kratkotrajnog djelovanja i radne kombinacije opterećenja ($e = 1.0 \cdot g + 1.0 \cdot \Delta g + 1.0 \cdot q$).

Granična vrijednost širine pukotine: $w_g = 0.3 \text{ mm}$ (EC-2 – uobičajena sredina)

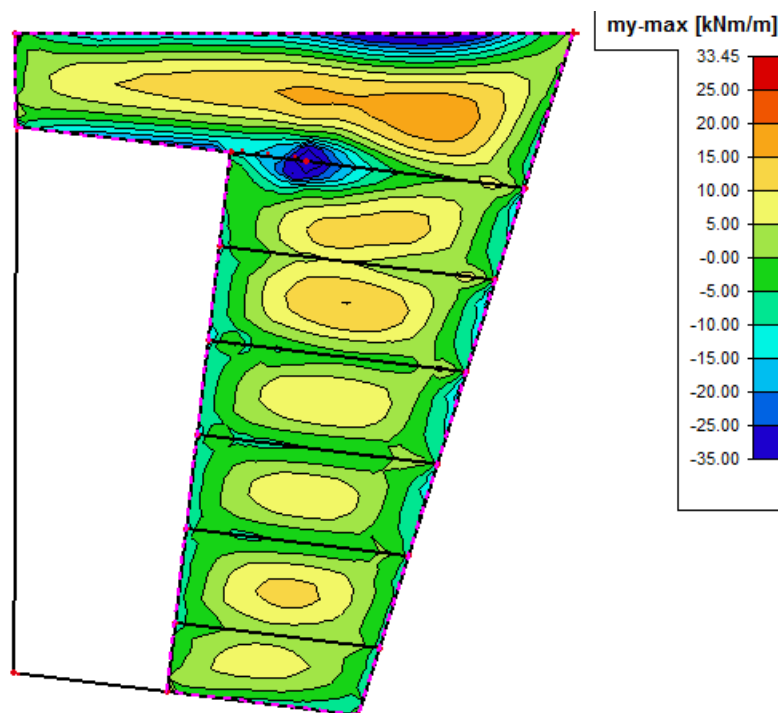

Slika 54: My max za kombinaciju GSU

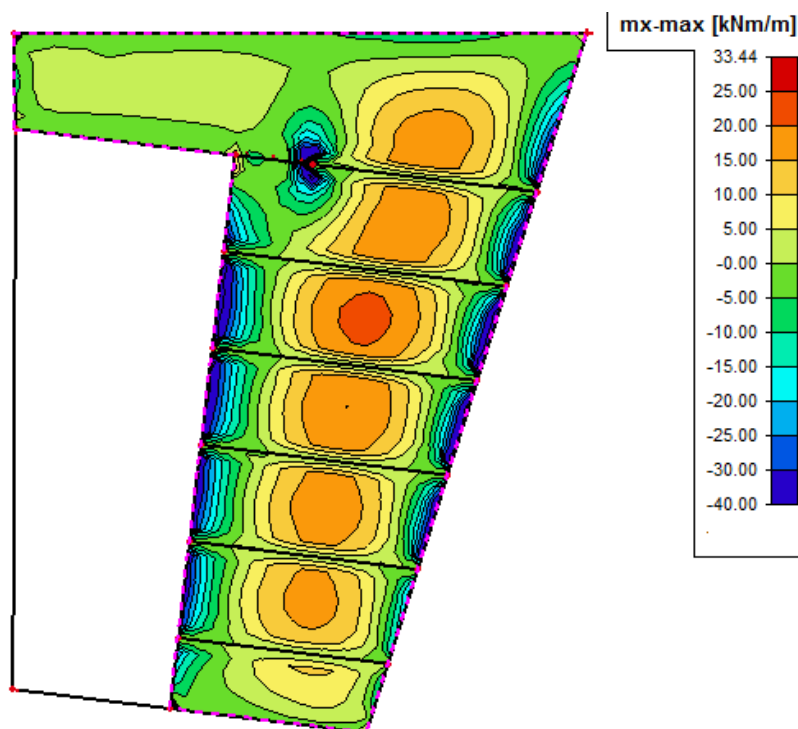

Slika 55: Mx max za kombinaciju GSU

Proračunska vrijednost širine pukotine: (EC-2): $w_k = \beta \cdot s_{rm} \cdot \varepsilon_{sm} \leq w_g$

Maksimalni eksploatacijski (radni) moment u polju: $M_{sd} = 33,45 \text{ kNm/m}$

Armatura ploče donja zona: Q – 785 ($A_s = 7,85 \text{ cm}^2$)

$A_{s1} = 7,85 \text{ cm}^2 / \text{m}$ $b = 100 \text{ (cm)}$; $h = 20 \text{ (cm)}$; $d_1 = 3 \text{ (cm)}$; $d = 17 \text{ (cm)}$

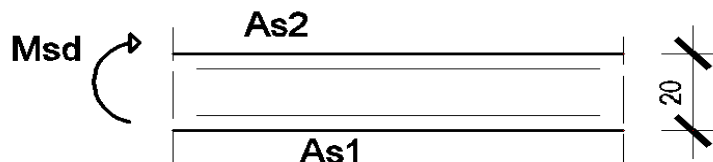

Slika 56: Skica armature u polju

Prognoza širine pukotina:

$$w_k = s_{r \max} \cdot (\varepsilon_{sm} - \varepsilon_{cm})$$

Proračun srednje deformacije armature:

$$\varepsilon_{sm} - \varepsilon_{cm} = \frac{\sigma_s - k_t \frac{f_{ct,eff}}{\rho_{p,eff}} (1 + \alpha_e \cdot \rho_{p,eff})}{E_s} \geq 0,6 \frac{\sigma_s}{E_s}$$

$$\alpha_e = \frac{E_s}{E_{cm}} = \frac{200}{32} = 6,25 \quad \text{- Odnos modula elastičnosti}$$

$$x = \xi_{lim} \cdot d = 17 \cdot 0,259 = 4,4 \quad \text{- Položaj neutralne osi}$$

$$x = \frac{\alpha_{el} \cdot A_{s1}}{b} \cdot \left(-1 + \sqrt{1 + \frac{2 \cdot b \cdot d}{\alpha_{el} \cdot A_{s1}}} \right) = \frac{6,25 \cdot 7,85}{100} \cdot \left(-1 + \sqrt{1 + \frac{2 \cdot 100 \cdot 17}{6,25 \cdot 7,85}} \right) = 3,62 \text{ (cm)}$$

$$\sigma_s = \frac{M_{Ed}}{z \cdot A_s} \approx \frac{M_{Ed}}{\left(d - \frac{x}{3} \right) \cdot A_s} = \frac{33,45 \cdot 100}{\left(17 - \frac{3,62}{3} \right) \cdot 7,85} = 26,98 \left(\frac{\text{kN}}{\text{cm}^2} \right) = 269,8 \text{ (MPa)}$$

$k_t = 0,4$ – Dugotrajno opterećenje

$E_s = 200,0 \text{ GPa}$ - modul elastičnosti armature

$E_{cm} = 32,80 \text{ GPa}$ - modul elastičnosti betona

Za C 30/37 $\rightarrow f_{ct,eff} = f_{ctm} = 2,9 \text{ MPa}$

$$\rho_{p,eff} = \frac{A_s}{A_{c,eff}} = \frac{7,85}{100 \cdot 5,46} = 0,014 \quad \text{- Djelotvorni koeficijent armiranja glavnom vlačnom}$$

armaturom

$$\varepsilon_{sm} - \varepsilon_{cm} = \frac{269,8 - 0,4 \cdot \frac{2,9}{0,014} (1 + 6,25 \cdot 0,014)}{200000} \geq 0,6 \frac{269,8}{200000}$$

$$\frac{179,69}{200000} > \frac{161,88}{200000}$$

$$\varepsilon_{sm} - \varepsilon_{cm} = \frac{179,69}{200000} = 0,000898$$

Srednji razmak pukotina

$$s_{r\max} = k_3 \cdot c + k_1 \cdot k_2 \cdot k_4 \cdot \frac{\phi}{\rho_{p,eff}} \quad (mm)$$

$\Phi = 10$ mm – Promjer najdeblje šipke

$c = 30$ mm – Zaštitni sloj uzdužne armature

$k_1 = 0.8$ – Rebrasta armatura

$k_2 = 0,5$ – Savijanje

$k_3 = 3.4$

$k_4 = 0.425$

$$s_{r\max} = 3,4 \cdot 30 + 0,8 \cdot 0,5 \cdot 0,425 \cdot \frac{10}{0,014} = 223,43 (mm)$$

$$w_k = s_{r\max} \cdot (\varepsilon_{sm} - \varepsilon_{cm}) = 223,43 \cdot 0,000898 = 0,200 mm < 0,30 mm$$

Odabrana armatura zadovoljava u pogledu širine pukotina!

10.1.5.2 Kontrola pukotina na ležaju

Mjerodavni momenti u ploči su dobiveni kroz numerički model. Koriste se rezultati od kratkotrajnog djelovanja i radne kombinacije opterećenja ($e = 1.0 \cdot g + 1.0 \cdot \Delta g + 1.0 \cdot q$).

Granična vrijednost širine pukotine: $w_g = 0.3$ mm (EC-2 – uobičajena sredina)

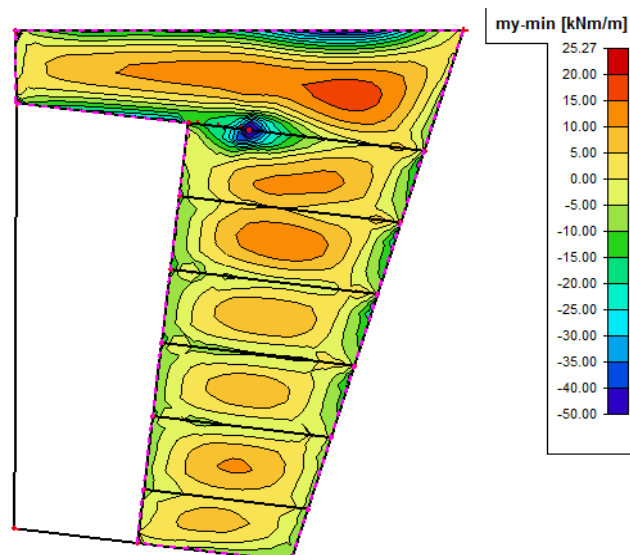

Slika 57: My min za kombinaciju GSU

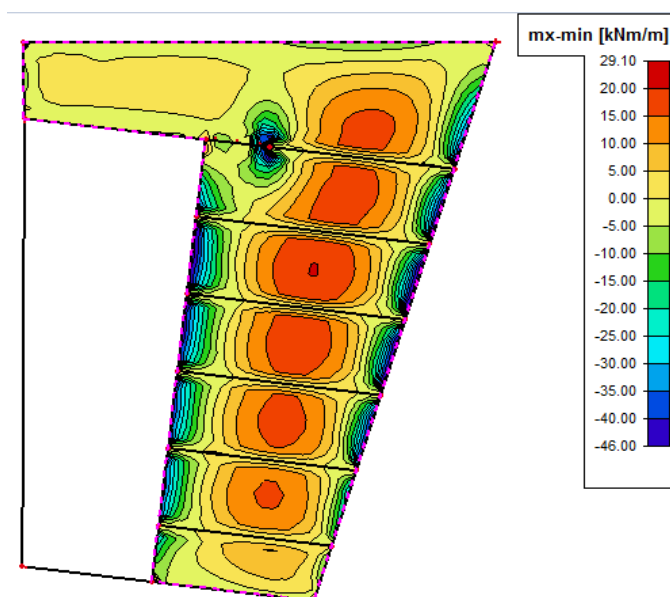

Slika 58: Mx min za kombinaciju GSU

Proračunska vrijednost širine pukotine: (EC-2): $w_k = \beta \cdot s_{rm} \cdot \varepsilon_{sm} \leq w_g$

Maksimalni eksploatacijski (radni) moment na ležaju: $Msd = 50,00 \text{ kNm/m}$

Armatura ploče gornja zona: Q - 785+3 $\Phi 16$ ($A_s = 7,85 + 4,02 \text{ cm}^2$)

$A_{s1} = 11,87 \text{ cm}^2 / \text{m}$ $b = 100 \text{ (cm)}$; $h = 20 \text{ (cm)}$; $d_1 = 3 \text{ (cm)}$; $d = 17 \text{ (cm)}$

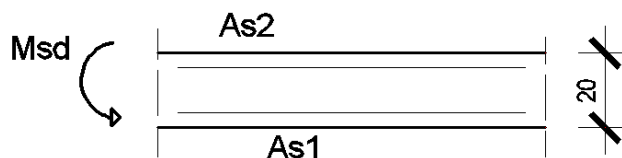

Slika 59: Skica armature u polju

Prognoza širine pukotina:

$$w_k = s_{r \max} \cdot (\varepsilon_{sm} - \varepsilon_{cm})$$

Proračun srednje deformacije armature:

$$\varepsilon_{sm} - \varepsilon_{cm} = \frac{\sigma_s - k_t \frac{f_{ct,eff}}{\rho_{p,eff}} (1 + \alpha_e \cdot \rho_{p,eff})}{E_s} \geq 0,6 \frac{\sigma_s}{E_s}$$

$$\alpha_e = \frac{E_s}{E_{cm}} = \frac{200}{32} = 6,25 \quad \text{- Odnos modula elastičnosti}$$

$$x = \xi_{lim} \cdot d = 17 \cdot 0,259 = 4,4 \quad \text{- Položaj neutralne osi}$$

$$x = \frac{\alpha_{el} \cdot A_{s1}}{b} \cdot \left(-1 + \sqrt{1 + \frac{2 \cdot b \cdot d}{\alpha_{el} \cdot A_{s1}}} \right) = \frac{6,25 \cdot 11,87}{100} \cdot \left(-1 + \sqrt{1 + \frac{2 \cdot 100 \cdot 17}{6,25 \cdot 11,87}} \right) = 4,33 \text{ (cm)}$$

$$\sigma_s = \frac{M_{Ed}}{z \cdot A_s} \approx \frac{M_{Ed}}{\left(d - \frac{x}{3} \right) \cdot A_s} = \frac{50 \cdot 100}{\left(17 - \frac{4,33}{3} \right) \cdot 11,87} = 27,077 \left(\frac{kN}{cm^2} \right) = 270,77 \text{ (MPa)}$$

$k_t = 0,4$ – Dugotrajno opterećenje

$E_s = 200,0$ GPa- modul elastičnosti armature

$E_{cm} = 32,80$ GPa- modul elastičnosti betona

Za C 30/37 $\rightarrow f_{ct,eff} = f_{ctm} = 2,9$ MPa

$$\rho_{p,eff} = \frac{A_s}{A_{c,eff}} = \frac{11,87}{100 \cdot 5,22} = 0,022 \quad \text{- Djelotvorni koeficijent armiranja glavnom vlačnom}$$

armaturom

$$\varepsilon_{sm} - \varepsilon_{cm} = \frac{270,77 - 0,4 \frac{2,9}{0,022} (1 + 6,25 \cdot 0,014)}{200000} \geq 0,6 \frac{270,77}{200000}$$

$$\frac{162,46}{200000} > \frac{162,46}{200000}$$

$$\varepsilon_{sm} - \varepsilon_{cm} = \frac{162,46}{200000} = 0,000812$$

Srednji razmak pukotina

$$s_{r_{\max}} = k_3 \cdot c + k_1 \cdot k_2 \cdot k_4 \cdot \frac{\phi}{\rho_{p,eff}} \quad (mm)$$

$\Phi = 10$ mm – Promjer najdeblje šipke

$c = 30$ mm – Zaštitni sloj uzdužne armature

$k_1 = 0.8$ – Rebrasta armatura

$k_2 = 0.5$ – Savijanje

$k_3 = 3.4$

$k_4 = 0.425$

$$s_{r_{\max}} = 3,4 \cdot 30 + 0,8 \cdot 0,5 \cdot 0,425 \cdot \frac{10}{0,022} = 197,27 \text{ (mm)}$$

$$w_k = s_{r_{\max}} \cdot (\varepsilon_{sm} - \varepsilon_{cm}) = 197,27 \cdot 0,000812 = 0,16 \text{ mm} < 0,30 \text{ mm}$$

Odabrana armatura zadovoljava u pogledu širine pukotina!

10.1.5.3 Kontrola progiba

Progibi ploča su također dobiveni kroz numerički model. Također se koriste rezultati od kratkotrajnog djelovanja i radne kombinacije opterećenja ($q = 1.0 \cdot g + 1.0 \cdot p$).

U nastavku je prikazana ploča sa pomacima.

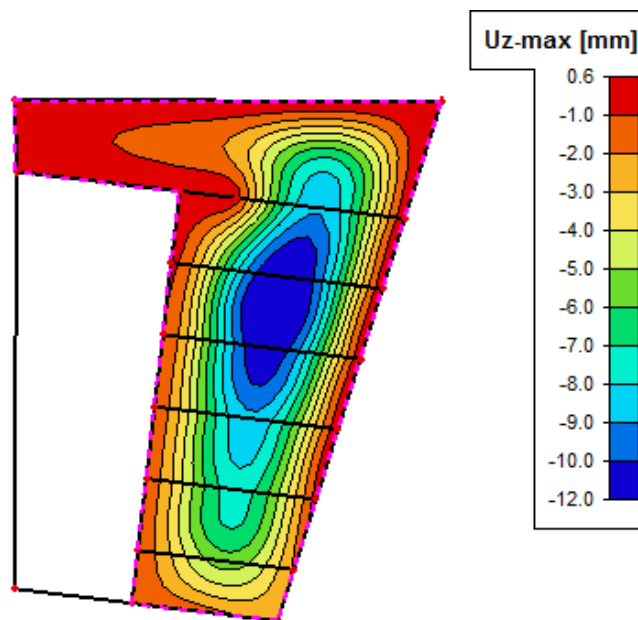

Slika 60: Progib [mm]

Maksimalan progib očekuje se u lijevom polju uz otvor:

$$M_{1-1} = -50,00 \text{ kNm} \quad \text{kombinacija za GSU}$$

$$M_{2-2} = 33,45 \text{ kNm}$$

$$M_{3-3} = -45,21 \text{ kNm}$$

odabrana mreža Q – 785 ($A_s = 7,85 \text{ cm}^2$)

$$A_{s1} = 7,85 \text{ cm}^2$$

Progib bez utjecaja puzanja!

Granični progib:

$$v_{\text{lim}} = \frac{L}{250} = \frac{1500}{250} = 6 \text{ cm}$$

Beton: C 30/37; $f_{ck} = 30,0 \text{ MPa}$

$$E_{cm} = 9500 \cdot \sqrt[3]{f_{ck} + 8} = 9500 \cdot \sqrt[3]{30 + 8} \approx 31940 \text{ MPa}$$

$$f_{ct,m} = 0,3 \cdot (f_{ck})^{2/3} = 0,3 \cdot (30,0)^{2/3} = 2,89 \text{ MPa}$$

Čelik: B500B; $E_s = 200,0 \text{ GPa}$

$$\alpha_{el} = \frac{E_s}{E_{cm}} = \frac{200,0}{32,0} = 6,25$$

$$v_{\text{tot}} = k \cdot L^2 \cdot \frac{1}{r_{\text{tot}}}$$

$$\beta = |M_{1-1} + M_{3-3}| / |M_{2-2}| = |50 + 45,21| / |33,45| = 2,85$$

$$k = \frac{5}{48} \cdot (1 - 0,1 \cdot \beta) = 0,104 \cdot (1 - 0,1 \cdot 2,85) = 0,074$$

Srednja zakrivljenost u neraspucalom stanju:

$$\begin{aligned} I_I &= \frac{bh^3}{12} + \alpha_{el} \cdot \left[A_{s1} \cdot \left(\frac{h}{2} - d_2 \right)^2 + A_{s2} \cdot \left(\frac{h}{2} - d_1 \right)^2 \right] \\ &= \frac{100 \cdot 20^3}{12} + 6,25 \cdot \left[7,85 \cdot \left(\frac{20}{2} - 3 \right)^2 + 0 \right] = \\ &= 66666,66 + 2404,06 = 69070,72 \text{ cm}^4 \end{aligned}$$

$$M_{Ed} = M_{2-2} = 33,45 \text{ kNm}$$

$$E_{c,eff} = E_{cm} = 32,0 \text{ GN/m}^2 = 3200,0 \text{ kN/cm}^2$$

$$\frac{1}{r_I} = \frac{M_{Ed}}{E_{c,eff} \cdot I_I} = \frac{33,45 \cdot 100}{3200,0 \cdot 69070,72} = 0,0000151 \frac{1}{\text{cm}}$$

$$x = \frac{\alpha_{el} \cdot A_{s1}}{b} \cdot \left(-1 + \sqrt{1 + \frac{2 \cdot b \cdot d}{\alpha_{el} \cdot A_{s1}}} \right) = \frac{6,25 \cdot 7,85}{100} \cdot \left(-1 + \sqrt{1 + \frac{2 \cdot 100 \cdot 17}{6,25 \cdot 7,85}} \right) = 3,62 \text{ (cm)}$$

Srednja zakrivljenost u raspucalom stanju:

$$\begin{aligned} I_{II} &= \frac{bx^3}{12} + bx \cdot \left(\frac{x}{2} \right)^2 + \alpha_{el} \cdot \left[A_{s1} \cdot (d-x)^2 + A_{s2} \cdot (x-d_2)^2 \right] \\ &= \frac{100 \cdot 3,62^3}{12} + (100 \cdot 3,62) \cdot \left(\frac{3,62}{2} \right)^2 + 6,25 \cdot \left[7,85 \cdot (17-3,62)^2 \right] \\ &= 1581,26 + 8783,38 = 10364,64 \text{ cm}^4 \end{aligned}$$

$$\frac{1}{r_{II}} = \frac{M_{Ed}}{E_{c,eff} \cdot I_{II}} = \frac{33,45 \cdot 100}{3200 \cdot 10364,64} = 0,0001 \frac{1}{\text{cm}}$$

$$\sigma_{sr} = \frac{M_{cr}}{z \cdot A_s} ; \quad M_{cr} = f_{ctm} \cdot \frac{b \cdot h^2}{6} ; \quad f_{ctm} \approx 0,3 \cdot (f_{ck})^{2/3} ; \quad f_{ck} = 30,0 \text{ MPa}$$

$$f_{ctm} = 0,3 \cdot (f_{ck})^{2/3} = 0,3 \cdot (30,0)^{2/3} = 2,9 \text{ MPa}$$

$$M_{cr} = 0,29 \cdot \frac{100 \cdot 20^2}{6} = 1933,33 \text{ kNcm} = 19,33 \text{ kNm}$$

$$\sigma_{sr} = \frac{M_{cr}}{z \cdot A_s} \approx \frac{M_{cr}}{\left(d - \frac{x}{3} \right) \cdot A_s} = \frac{1933,33}{\left(17 - \frac{3,62}{3} \right) \cdot 7,85} = 15,59 \frac{\text{kN}}{\text{cm}^2} = 155,9 \text{ MPa}$$

$$\sigma_{s1} = \frac{M_{Ed}}{z \cdot A_{s1}} \approx \frac{M_{Ed}}{\left(d - \frac{x}{3} \right) \cdot A_{s1}} = \frac{34,45 \cdot 100}{\left(17 - \frac{3,62}{3} \right) \cdot 7,85} = 27,79 \frac{\text{kN}}{\text{cm}^2} = 277,9 \text{ MPa}$$

$$\frac{1}{r_I} = 0,0000151 \frac{1}{\text{cm}}$$

$$\frac{1}{r_{II}} = 0,0001 \frac{1}{\text{cm}}$$

$$\zeta = 1 - \beta \cdot \left(\frac{\sigma_{sr}}{\sigma_s} \right)^2 = 1 - 0,5 \cdot \left(\frac{155,9}{277,9} \right)^2 = 0,84 - \text{koeficijent raspodjele}$$

$$\frac{1}{r_m} = \zeta \cdot \frac{1}{r_I} + (1 - \zeta) \cdot \frac{1}{r_{II}} = 0,84 \cdot 0,0000151 + (1 - 0,84) \cdot 0,0001 = 0,0000287 \frac{1}{\text{cm}}$$

$$k = 0,074$$

$$L = 1500 \text{ cm}$$

$$v_{tot,t=0} = k \cdot L^2 \cdot \frac{1}{r_{tot}} = 0,074 \cdot 1500^2 \cdot 0,0000287 = 4,77 \text{ cm} < v_{lim} = 6 \text{ cm}$$

Odabrane dimezije ploče i armatura zadovoljavaju u pogledu progiba!

Ovakav proračun progiba je na strani sigurnosti. Iz estetskih razloga pri izradi predvidjeti nadvišenje od 3.0 cm u sredini.

10.1.5.4 Moment u gredi – pozicija 203

Donja zona (moment savijanja) $\rightarrow M_{Ed,min} = 336,07 kNm$

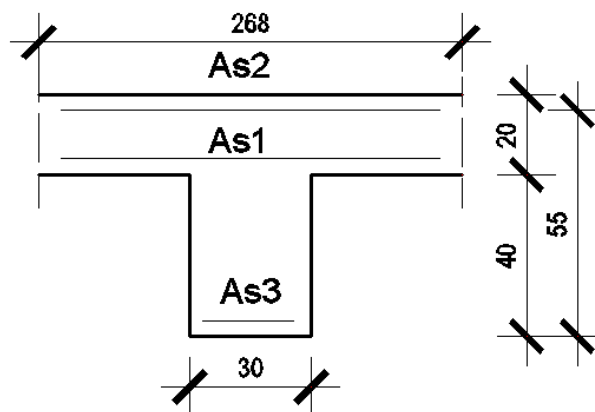

Slika 61: Skica položaja armature za poziciju 203

$h_{uk}=60$ cm; $d=55$ cm; $b=30$ cm; $h_f=20$ cm; $b_{eff}=268$ cm

$$b_{eff} = b_0 + \frac{l_0}{5} \leq e \Rightarrow b_{eff} = 30 + \frac{0,85 \cdot 1400}{5} = 268 \text{ cm} < 500 \text{ cm}$$

$$\mu_{sd} = \frac{M_{Ed}}{b_{eff} \cdot d^2 \cdot f_{cd}} = \frac{33607}{268 \cdot 55^2 \cdot 2,0} = 0,020$$

Očitano: $\varepsilon_{s1} = 10,0$ ‰ $\varepsilon_{c2} = 0,8$ ‰ $\xi = 0,074$ $\zeta = 0,974$

$$x = \xi \cdot d = 0,242 \cdot 55 = 13,31 \text{ cm} < h_{pl}$$

$$A_{s1} = \frac{M_{Ed}}{\zeta \cdot d \cdot f_{yd}} = \frac{33607}{0,974 \cdot 55 \cdot 43,5} = 14,4 \text{ cm}^2$$

Odabrano 4Ø22 ($A_{s1}=15,21 \text{ cm}^2$)

10.1.5.5 Dimenzioniranje na poprečnu silu

Presjek - ležaj

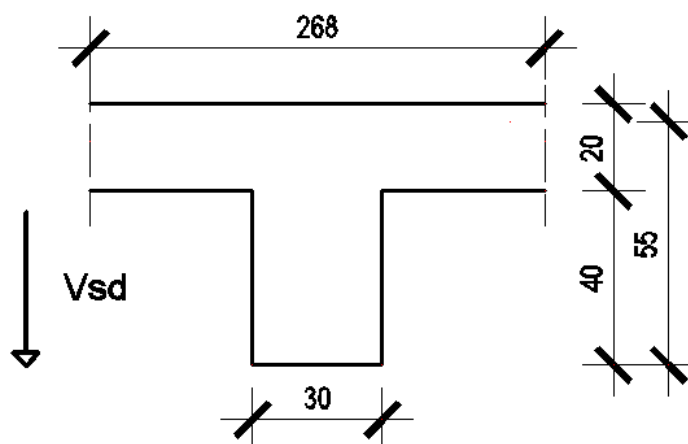

Slika 62: Prikaz poprečnog presjeka pozicije 203

$$V_{Ed} = 278,22 \text{ kN}$$

$$A_s = 4\phi 22 + (7,85/100) \cdot 30 + ((7,85 + 4,02)/100) \cdot 30 = 21,12 \text{ cm}^2$$

Dio poprečne sile koju preuzima beton i uzdužna armatura:

$$V_{Rd,C} = \left[C_{Rd,C} \cdot k \cdot (100 \cdot \rho_l \cdot f_{ck})^{1/3} + k_1 \cdot \sigma_{cp} \right] \cdot b_w \cdot d$$

$$k = 1,0 + \sqrt{\frac{200}{d}} = 1,0 + \sqrt{\frac{200}{550}} = 1,6 \leq 2,0$$

$$k_1 = 0,15$$

$$\sigma_{cp} = N_{sd} / A_c = 0,0$$

$$C_{Rd,C} = 0,18 / \gamma_c = 0,18 / 1,5 = 0,12$$

$$\sum A_s \approx 25,53 \text{ cm}^2 \quad \rho_l = \frac{\sum A_s}{A_c} = \frac{21,12}{60 \cdot 30} = 0,0117$$

$$V_{Rd,C} = \left[0,12 \cdot 1,6 \cdot (100 \cdot 0,0117 \cdot 30)^{1/3} + 0,15 \cdot 0,0 \right] \cdot 300 \cdot 550 = 103725,98 \text{ N} = 103,73 \text{ kN}$$

$$V_{Rd,C(\min)} = \left[v_{\min} + k_1 \cdot \sigma_{cp} \right] \cdot b_w \cdot d = \left[0,302 + 0,15 \cdot 0 \right] \cdot 300 \cdot 550 = 49830 \text{ N} = 49,83 \text{ kN}$$

$$v_{\min} = 0,035 \cdot k^{3/2} \cdot f_{cd}^{1/2} = 0,035 \cdot 1,55^{3/2} \cdot 20^{1/2} = 0,302$$

$$V_{Ed} > V_{Rd,C}$$

$$V_{Rd,max} = 0,5 \cdot v \cdot b_w \cdot d \cdot f_{cd} = 0,5 \cdot 0,528 \cdot 300 \cdot 550 \cdot 20 = 1061280N = 871,2kN > V_{Ed}$$

$$v = 0,6 \left[1 - \frac{f_{ck}}{250} \right] = 0,6 \left[1 - \frac{30}{250} \right] = 0,528$$

Potrebna računaska poprečna armatura

$$V_{Ed}/V_{Rd,max} = 278,22/871,2 \approx 0,31 \Rightarrow V_{Ed} = 0,31V_{Rd2}$$

$$s_{w,max} = \min \{0,6 \cdot d; 30,0\text{ cm}\} = \min \{0,6 \cdot 55 = 33; 30,0\} \Rightarrow s_{w,max} = 30,0\text{ cm}$$

$$\rho_{min} = 0,0011 \quad (C 30/37)$$

$$A_{sw,min} = \frac{\rho_{min} \cdot s_w \cdot b_w}{m} = \frac{0,0011 \cdot 30 \cdot 30}{2} = 0,495\text{ cm}^2$$

Odabrane spone $\varnothing 10$ ($A_{sw}=0,79\text{ cm}^2$):

$$s_{w,pot} \leq \frac{m \cdot A_{sw,min}}{\rho_{min} \cdot b_w} = \frac{2 \cdot 0,79}{0,0011 \cdot 30} = 47,88\text{ cm}$$

Odabrane spone $\varnothing 10/30$, $m=2$

Ukupna nosivost betona i odabrane poprečne armature:

$$V_{Rd} = V_{Rd,s} = \frac{A_{sw}}{S} \cdot z \cdot f_{ywd} \cdot m \cdot ctg\Theta = \frac{0,79}{30} \cdot (0,9 \cdot 60) \cdot 43,48 \cdot 2 \cdot 1 = 123,66\text{ kN}$$

$$V_{Ed} > V_{Rd}$$

Kontroliramo nosivost betona:

$$V_{Rd,max} = \frac{\alpha_{cw} \cdot b_w \cdot z \cdot v_1 \cdot f_{cd}}{\tan\Theta + ctg\Theta} = \frac{1,0 \cdot 300 \cdot 540 \cdot 0,6 \cdot 20}{1+1} = 972\text{ kN} > V_{Ed}$$

Na mjestu maksimalne poprečne sile:

$$S_{pot} \leq \frac{m \cdot A_{sw} \cdot f_{ywd} \cdot z}{V_{Ed}} = \frac{2 \cdot 0,79 \cdot 43,5 \cdot 54}{278,22} = 13,34\text{ cm}$$

$\varnothing 10/13$ ($A_{sw}=0,79\text{ cm}^2$)

10.1.6 Kontrola pukotina greda pozicija 200-krov

Granična širina pukotina prema EC-2 za uobičajenu sredinu iznosi $w_g=0.3$ mm. Odabrana vlačna armatura za polje je $4\text{Ø}22$ ($A_{s1}=15,21\text{cm}^2$)

$M_{Ed,2-2}=235,1$ kNm - za granično stanje uporabljivosti

$b=30$ (cm); $h=60$ (cm); $d_1=5$ (cm); $d=55$ (cm)

Prognoza širine pukotina:

$$w_k = s_{r,max} \cdot (\varepsilon_{sm} - \varepsilon_{cm})$$

Proračun srednje deformacije armature:

$$\varepsilon_{sm} - \varepsilon_{cm} = \frac{\sigma_s - k_t \frac{f_{ct,eff}}{\rho_{p,eff}} (1 + \alpha_e \cdot \rho_{p,eff})}{E_s} \geq 0,6 \frac{\sigma_s}{E_s}$$

$$x = \frac{\alpha_{el} \cdot A_{s1}}{b} \cdot \left(-1 + \sqrt{1 + \frac{2 \cdot b \cdot d}{\alpha_{el} \cdot A_{s1}}} \right) = \frac{6,25 \cdot 15,21}{30} \cdot \left(-1 + \sqrt{1 + \frac{2 \cdot 30 \cdot 55}{6,25 \cdot 15,21}} \right) = 15,76 \text{ (cm)}$$

$$\sigma_s = \frac{M_{Ed}}{z \cdot A_s} \approx \frac{M_{Ed}}{\left(d - \frac{x}{3} \right) \cdot A_s} = \frac{235,11 \cdot 100}{\left(55 - \frac{15,76}{3} \right) \cdot 15,21} = 31,07 \left(\frac{\text{kN}}{\text{cm}^2} \right) = 310,7 \text{ (MPa)}$$

$k=0.4$ – Dugotrajno opterećenje

$E_s = 200.0$ GPa- modul elastičnosti armature

$E_{cm} = 32.80$ GPa- modul elastičnosti betona

Za C 30/37 $\rightarrow f_{ct,eff} = f_{ctm} = 2.9$ MPa

$$\alpha_e = \frac{E_s}{E_{cm}} = \frac{200}{32} = 6,25 \text{ - Odnos modula elastičnosti}$$

$$\rho_{p,eff} = \frac{A_s}{A_{c,eff}} = \frac{15,21}{30 \cdot 14,75} = 0,034 \text{ - Djelotvorni koeficijent armiranja glavnom vlačnom}$$

armaturom

$$\varepsilon_{sm} - \varepsilon_{cm} = \frac{310,7 - 0,4 \frac{2,9}{0,034} (1 + 6,25 \cdot 0,034)}{200000} \geq 0,6 \frac{310,7}{200000}$$

$$\frac{269,33}{200000} \geq \frac{186,42}{200000}$$

$$\varepsilon_{sm} - \varepsilon_{cm} = \frac{269,33}{200000} = 0,00135$$

Srednji razmak pukotina

$$s_{r\max} = k_3 \cdot c + k_1 \cdot k_2 \cdot k_4 \cdot \frac{\phi}{\rho_{p,eff}} \quad (mm)$$

$\Phi = 22$ mm – Promjer najdeblje šipke

$c = 30$ mm – Zaštitni sloj uzdužne armature

$k_1 = 0.8$ – Rebrasta armatura

$k_2 = 0.5$ – Savijanje

$k_3 = 3.4$

$k_4 = 0.425$

$$s_{r\max} = 3,4 \cdot 30 + 0,8 \cdot 0,5 \cdot 0,425 \cdot \frac{22}{0,034} = 212 \text{ (mm)}$$

$$w_k = s_{r\max} \cdot (\varepsilon_{sm} - \varepsilon_{cm}) = 212 \cdot 0,00135 = 0,286 \text{ mm} < 0,30 \text{ mm}$$

Odobrana armatura zadovoljava u pogledu širine pukotina

10.1.7 Kontrola progiba grede pozicija 106

Maksimalan progib očekuje se u vanjskim poljima:

$$M_{1-1} = -325,84 \text{ kNm}$$

$$M_{2-2} = 235,11 \text{ kNm} \quad \text{kombinacija za GSU}$$

$$M_{3-3} = -140,2 \text{ kNm}$$

$$A_{s1} = Q - 785 = 7,85 \text{ cm}^2/\text{m}' = 2,36 \text{ cm}^2$$

$$A_{s2} = Q - 785 + 2\phi 16 = 7,85 + 4,02 = 11,87 \text{ cm}^2/\text{m}' = 3,561 \text{ cm}^2$$

$$A_{s2} = 3\phi 22 = 15,21 \text{ cm}^2$$

Progib bez utjecaja puzanja!

Granični progib:

$$v_{\lim} = \frac{L}{250} = \frac{1400}{250} = 5,6 \text{ cm}$$

Beton: C 30/37; $f_{ck} = 30.0$ MPa

$$E_{cm} = 9500 \cdot \sqrt[3]{f_{ck} + 8} = 9500 \cdot \sqrt[3]{30 + 8} \approx 31940 \text{ MPa}$$

$$f_{ct,m} = 0.3 \cdot (f_{ck})^{2/3} = 0.3 \cdot (30.0)^{2/3} = 2,89 \text{ MPa}$$

Čelik: B500B; $E_s = 200.0$ GPa

$$\alpha_{el} = \frac{E_s}{E_{cm}} = \frac{200,0}{32,0} = 6,25$$

$$v_{tot} = k \cdot L^2 \cdot \frac{1}{r_{tot}}$$

$$\beta = |M_{1-1} + M_{3-3}| / |M_{2-2}| = |325,84 + 140,2| / |235,11| = 1,98$$

$$k = \frac{5}{48} \cdot (1 - 0,1 \cdot \beta) = 0,104 \cdot (1 - 0,1 \cdot 1,98) = 0,083$$

Srednja zakrivljenost u neraspucalom stanju:

$$\begin{aligned} I_I &= \frac{bh^3}{12} + \alpha_{el} \cdot \left[A_{s1} \cdot \left(\frac{h}{2} - d_2 \right)^2 + A_{s2} \cdot \left(\frac{h}{2} - d_1 \right)^2 \right] \\ &= \frac{30 \cdot 60^3}{12} + 6,25 \cdot \left[2,36 \cdot \left(\frac{60}{2} - 5 \right)^2 + 15,21 \cdot \left(\frac{60}{2} - 5 \right)^2 \right] = \\ &= 608632,81 \text{ cm}^4 \end{aligned}$$

$$M_{Ed} = M_{2-2} = 235,11 \text{ kNm}$$

$$E_{c,eff} = E_{cm} = 32,0 \text{ GN/m}^2 = 3200,0 \text{ kN/cm}^2$$

$$\frac{1}{r_I} = \frac{M_{Ed}}{E_{c,eff} \cdot I_I} = \frac{235,11 \cdot 100}{3200,0 \cdot 608632,81} = 0,0000121 \frac{1}{\text{cm}}$$

$$x = \frac{\alpha_{el} \cdot A_{s1}}{b} \cdot \left(-1 + \sqrt{1 + \frac{2 \cdot b \cdot d}{\alpha_{el} \cdot A_{s1}}} \right) = \frac{6,25 \cdot 15,21}{30} \cdot \left(-1 + \sqrt{1 + \frac{2 \cdot 30 \cdot 55}{6,25 \cdot 15,21}} \right) = 15,77 \text{ (cm)}$$

Srednja zakrivljenost u raspucalom stanju:

$$\begin{aligned} I_{II} &= \frac{bx^3}{12} + bx \cdot \left(\frac{x}{2} \right)^2 + \alpha_{el} \cdot \left[A_{s1} \cdot (d - x)^2 + A_{s2} \cdot (x - d_2)^2 \right] \\ &= \frac{30 \cdot 15,77^3}{12} + (30 \cdot 15,77) \cdot \left(\frac{15,77}{2} \right)^2 + 6,25 \cdot \left[2,36 \cdot (55 - 15,77)^2 + 15,21 \cdot (15,77 - 5)^2 \right] \\ &= 39218,87 + 33726,72 = 72945,59 \text{ cm}^4 \end{aligned}$$

$$\frac{1}{r_{II}} = \frac{M_{Ed}}{E_{c,eff} \cdot I_{II}} = \frac{235,11 \cdot 100}{3200 \cdot 72945,59} = 0,000101 \frac{1}{\text{cm}}$$

$$\sigma_{sr} = \frac{M_{cr}}{z \cdot A_s} ; M_{cr} = f_{ctm} \cdot \frac{b \cdot h^2}{6} ; f_{ctm} \approx 0,3 \cdot (f_{ck})^{2/3} ; f_{ck} = 30,0 \text{ MPa}$$

$$f_{ctm} = 0,3 \cdot (f_{ck})^{2/3} = 0,3 \cdot (30,0)^{2/3} = 2,9 \text{ MPa}$$

$$M_{cr} = 0,29 \cdot \frac{30 \cdot 60^2}{6} = 5220 \text{ kNcm} = 52,2 \text{ kNm}$$

$$\sigma_{sr} = \frac{M_{cr}}{z \cdot A_s} \approx \frac{M_{cr}}{\left(d - \frac{x}{3}\right) \cdot A_s} = \frac{5220}{\left(55 - \frac{15,77}{3}\right) \cdot 15,21} = 6,9 \frac{\text{kN}}{\text{cm}^2} = 69 \text{ MPa}$$

$$\sigma_{s1} = \frac{M_{Ed}}{z \cdot A_{s1}} \approx \frac{M_{Ed}}{\left(d - \frac{x}{3}\right) \cdot A_{s1}} = \frac{235,11 \cdot 100}{\left(55 - \frac{15,77}{3}\right) \cdot 15,21} = 31,07 \frac{\text{kN}}{\text{cm}^2} = 310,7 \text{ MPa}$$

$$\frac{1}{r_I} = 0,0000121 \frac{1}{\text{cm}}$$

$$\frac{1}{r_{II}} = 0,000101 \frac{1}{\text{cm}}$$

$$\zeta = 1 - \beta_1 \cdot \beta_2 \cdot \left(\frac{\sigma_{sr}}{\sigma_s}\right)^2 = 1 - 1,0 \cdot 0,5 \cdot \left(\frac{69}{310,7}\right)^2 = 0,98 - \text{koeficijent raspodjele}$$

$$\frac{1}{r_m} = \zeta \cdot \frac{1}{r_I} + (1 - \zeta) \cdot \frac{1}{r_{II}} = 0,98 \cdot 0,0000121 + (1 - 0,98) \cdot 0,000101 = 0,0000139 \frac{1}{\text{cm}}$$

$$k = 0,083$$

$$L = 1400,0 \text{ cm}$$

$$v_{tot,t=0} = k \cdot L^2 \cdot \frac{1}{r_{tot}} = 0,083 \cdot 1400^2 \cdot 0,0000139 = 2,26 \text{ cm} < v_{lim} = 5,6 \text{ cm}$$

Odabrane dimezije grede i armatura zadovoljavaju u pogledu progiba!

11. DIMENZIONIRANJE VERTIKALNIH ELEMENATA

Vertikalni elementi konstrukcije objekta su armiranobetonski zidovi i armiranobetonski stupovi koji preuzimaju opterećenja od vertikalnih i horizontalnih sila. Konstrukcija se sastoji od prizemlja i podzemne garaže.

Potresne sile proračunate su metodom spektralne analize prema EC-8 pomoću računalnog programa koristeći prostorni model konstrukcije. Građevina se nalazi u blizini Trogira i smještena je u zonu gdje poredbeno vršno ubrzanje temeljnog tla iznosi $\alpha=0.222g$ prema važećoj seizmičkoj karti (povratni period 475 godina za GSN).

U podzemnoj garaži se nalaze stupovi unutar objekta i zidovi koji su smješteni po obodu građevine. Armiranobetonski zidovi u podzemnoj garaži preuzimaju skoro cijeli dio horizontalne sile od potresa. Oni spadaju u kratke zidove koje karakterizira velika krutost, dominantni utjecaj poprečnih sila na nosivost i deformiranje.

Vrijednost horizontalnih sila uslijed djelovanja potresa koje preuzimaju predmetni zidovi iznosom su mali, tako da isti nisu značajnije opterećeni poprečnom silom, niti momentom savijanja, pa je za njih uglavnom usvojena minimalna armatura koje je propisana važećim propisima. Treba obratiti pozornost da je građevina velikim dijelom ukopana te na neke zidove djeluje i horizontalna sila uslijed opterećenja zasipom tla i vode te korisnog opterećenja na tlo koje se manifestira kao dio horizontalnog opterećenja u tlu. Na tim mjestima ne vrijedi minimalna, nego proračunska armatura koje je dobivena uslijed navedenih opterećenja u tlu.

Dominantno opterećenje na armiranobetonske zidove je potres i snijeg, dok je utjecaj opterećenja vjetrom zanemariv, pa se stoga se u nastavku analizira isključivo potresno djelovanje na konstrukciju i djelovanje snijega. Za stupove u najvećem broju slučajeva mjerodavane su sile iz osnovnih kombinacija djelovanja. Vrijednosti pomaka uslijed opterećenja horizontalnim sila vjetra i potresa su male tj. gotovo zanemarive.

Proračunom je obuhvaćeno prvih 100 vlastitih oblika. Prema EC-8 zadovoljen je uvjet da suma svih upotrebljenih vlastitih oblika u proračunu mora aktivirati najmanje 90% ukupne mase.

Rezultati modalne analize:

Sum of masses

[kg]	X	Y	Z
Combination of mass groups 1	7691608.26	7691608.26	7691608.26

Modal participation factors

Mode	Omega [rad/s]	Period [s]	Freq. [Hz]	Wxi / Wxtot	Wyi / Wytot	Wzi / Wztot	Wxi_R / Wxtot_R	Wyi_R / Wytot_R	Wzi_R / Spectral	Damp ratio
1	6.2404	1.0069	0.9932	0.0035	0.0000	0.0000	0.0000	0.0001	0.0000	0.0080
2	24.3056	0.2585	3.8684	0.0028	0.0000	0.0000	0.0000	0.0000	0.0004	0.0079
3	29.4706	0.2132	4.6904	0.0000	0.0000	0.0114	0.0000	0.0149	0.0000	0.0079
4	38.3997	0.1636	6.1115	0.0000	0.0000	0.0007	0.0039	0.0006	0.0000	0.0079
5	41.8239	0.1502	6.6565	0.0000	0.0023	0.0000	0.0001	0.0000	0.0002	0.0080
6	49.4928	0.1270	7.8770	0.0000	0.0000	0.0027	0.0003	0.0034	0.0000	0.0079
7	59.0948	0.1063	9.4052	0.0002	0.0000	0.0000	0.0000	0.0000	0.0000	0.0079
8	63.8878	0.0983	10.1681	0.0000	0.0000	0.0000	0.0017	0.0001	0.0000	0.0079
9	70.9414	0.0886	11.2907	0.0056	0.0001	0.0000	0.0000	0.0000	0.0000	0.0080
10	73.5232	0.0855	11.7016	0.0001	0.0000	0.0000	0.0000	0.0000	0.0001	0.0079
11	73.9932	0.0849	11.7764	0.0000	0.0000	0.0001	0.0002	0.0004	0.0000	0.0079
12	81.3269	0.0773	12.9436	0.0000	0.0063	0.0000	0.0001	0.0000	0.0003	0.0080
13	82.1664	0.0765	13.0772	0.0009	0.5931	0.0001	0.0133	0.0001	0.0712	0.0090
14	82.1851	0.0765	13.0802	0.0000	0.0000	0.0011	0.0000	0.0013	0.0000	0.0079
15	84.0941	0.0747	13.3840	0.0000	0.0001	0.0000	0.0000	0.0000	0.0002	0.0079
16	91.6072	0.0686	14.5797	0.0000	0.0000	0.0001	0.0001	0.0002	0.0000	0.0079
17	95.3783	0.0659	15.1799	0.0077	0.0002	0.0000	0.0000	0.0000	0.0055	0.0080
18	97.8711	0.0642	15.5767	0.0000	0.0000	0.0004	0.0012	0.0011	0.0000	0.0079
19	100.1382	0.0627	15.9375	0.0142	0.0001	0.0000	0.0001	0.0001	0.0000	0.0080
20	105.1466	0.0598	16.7346	0.0036	0.0002	0.0000	0.0000	0.0000	0.0000	0.0078
21	108.1862	0.0581	17.2184	0.0000	0.0000	0.0004	0.0004	0.0005	0.0000	0.0079
22	112.5329	0.0558	17.9102	0.3667	0.1629	0.0000	0.0003	0.0022	0.0536	0.0081
23	112.6905	0.0558	17.9352	0.0000	0.0000	0.0002	0.0001	0.0004	0.0000	0.0079
24	118.3976	0.0531	18.8436	0.0126	0.0000	0.0000	0.0000	0.0000	0.0067	0.0080
25	119.1024	0.0528	18.9557	0.0000	0.0000	0.0037	0.0042	0.0043	0.0000	0.0079
26	121.4312	0.0517	19.3264	0.0626	0.0003	0.0000	0.0002	0.0002	0.0292	0.0080
27	122.9018	0.0511	19.5604	0.0000	0.0000	0.0000	0.0003	0.0002	0.0000	0.0079
28	128.8730	0.0488	20.5108	0.3041	0.0818	0.0001	0.0001	0.0006	0.1647	0.0083
29	133.6253	0.0470	21.2671	0.0003	0.0001	0.0000	0.0000	0.0000	0.0005	0.0079
30	133.7542	0.0470	21.2876	0.0001	0.0003	0.0000	0.0003	0.0000	0.0051	0.0079
31	134.0748	0.0469	21.3387	0.0000	0.0000	0.0004	0.0001	0.0004	0.0000	0.0079
32	136.6084	0.0460	21.7419	0.0257	0.0165	0.0001	0.0005	0.0001	0.0022	0.0080
33	136.7796	0.0459	21.7691	0.0000	0.0000	0.0000	0.0007	0.0001	0.0000	0.0079
34	138.6844	0.0453	22.0723	0.0102	0.0136	0.0000	0.0026	0.0003	0.0289	0.0081
35	145.1140	0.0433	23.0956	0.0000	0.0000	0.0006	0.0000	0.0010	0.0001	0.0079
36	145.3991	0.0432	23.1410	0.0052	0.0031	0.0000	0.0019	0.0008	0.1899	0.0082
37	148.5891	0.0423	23.6487	0.0000	0.0000	0.0008	0.0002	0.0005	0.0000	0.0079
38	148.8171	0.0422	23.6850	0.0011	0.0005	0.0000	0.0003	0.0001	0.0056	0.0079
39	150.2030	0.0418	23.9056	0.0184	0.0080	0.0007	0.0024	0.0023	0.0283	0.0081
40	150.7096	0.0417	23.9862	0.0021	0.0005	0.0002	0.0000	0.0005	0.0001	0.0080
41	151.6223	0.0414	24.1314	0.0140	0.0093	0.0003	0.0045	0.0012	0.0683	0.0083
42	154.8054	0.0406	24.6380	0.0004	0.0001	0.0004	0.0000	0.0011	0.0039	0.0080
43	155.3001	0.0405	24.7168	0.0000	0.0000	0.0005	0.0001	0.0007	0.0000	0.0079
44	158.7471	0.0396	25.2654	0.0102	0.0162	0.0036	0.0173	0.0052	0.1022	0.0084
45	160.7601	0.0391	25.5858	0.0003	0.0002	0.0001	0.0001	0.0001	0.0001	0.0078
46	165.3521	0.0380	26.3166	0.0000	0.0000	0.0000	0.0000	0.0000	0.0000	0.0079

47	166.7879	0.0377	26.5451	0.0000	0.0001	0.0001	0.0004	0.0000	0.0050	0.0080
48	168.5279	0.0373	26.8220	0.0000	0.0001	0.0000	0.0000	0.0000	0.0018	0.0079
49	169.3961	0.0371	26.9602	0.0000	0.0000	0.0000	0.0000	0.0000	0.0001	0.0079
50	169.9477	0.0370	27.0480	0.0005	0.0002	0.0002	0.0012	0.0000	0.0228	0.0080
51	171.9386	0.0365	27.3649	0.0000	0.0000	0.0000	0.0008	0.0000	0.0000	0.0079
52	173.2554	0.0363	27.5745	0.0002	0.0000	0.0000	0.0000	0.0000	0.0001	0.0079
53	177.8705	0.0353	28.3090	0.0000	0.0000	0.0161	0.0000	0.0009	0.0000	0.0080
54	178.5976	0.0352	28.4247	0.0000	0.0000	0.0000	0.0002	0.0000	0.0000	0.0079
55	186.0902	0.0338	29.6172	0.0000	0.0000	0.0017	0.0003	0.0010	0.0001	0.0078
56	186.3915	0.0337	29.6651	0.0006	0.0000	0.0002	0.0000	0.0004	0.0101	0.0080
57	189.1774	0.0332	30.1085	0.0007	0.0000	0.0000	0.0000	0.0000	0.0000	0.0079
58	189.3393	0.0332	30.1343	0.0000	0.0000	0.0002	0.0000	0.0001	0.0001	0.0080
59	191.1156	0.0329	30.4170	0.0004	0.0002	0.0327	0.0004	0.0161	0.0024	0.0110
60	191.1645	0.0329	30.4248	0.0001	0.0000	0.0015	0.0000	0.0001	0.0003	0.0080
61	191.5737	0.0328	30.4899	0.0017	0.0001	0.1746	0.0042	0.0827	0.0003	0.0278
62	192.9826	0.0326	30.7141	0.0002	0.0001	0.0004	0.0001	0.0001	0.0040	0.0079
63	194.3440	0.0323	30.9308	0.0125	0.0000	0.0008	0.0000	0.0003	0.0023	0.0080
64	195.9570	0.0321	31.1875	0.0001	0.0000	0.0002	0.0000	0.0000	0.0013	0.0079
65	197.8544	0.0318	31.4895	0.0000	0.0001	0.0000	0.0000	0.0000	0.0016	0.0079
66	200.2907	0.0314	31.8772	0.0001	0.0004	0.0007	0.0008	0.0000	0.0109	0.0079
67	200.4898	0.0313	31.9089	0.0001	0.0001	0.0001	0.0001	0.0000	0.0010	0.0079
68	202.2046	0.0311	32.1819	0.0000	0.0000	0.0001	0.0005	0.0000	0.0000	0.0079
69	202.7354	0.0310	32.2663	0.0003	0.0000	0.0000	0.0000	0.0000	0.0000	0.0079
70	203.8288	0.0308	32.4404	0.0002	0.0002	0.0000	0.0000	0.0000	0.0020	0.0079
71	205.3188	0.0306	32.6775	0.0000	0.0000	0.0027	0.0063	0.0024	0.0000	0.0082
72	205.8158	0.0305	32.7566	0.0019	0.0000	0.0000	0.0000	0.0000	0.0007	0.0079
73	206.5092	0.0304	32.8670	0.0003	0.0002	0.0001	0.0002	0.0000	0.0026	0.0079
74	206.5629	0.0304	32.8755	0.0000	0.0000	0.0000	0.0000	0.0000	0.0000	0.0079
75	206.8935	0.0304	32.9281	0.0000	0.0000	0.0000	0.0043	0.0037	0.0000	0.0087
76	210.7220	0.0298	33.5374	0.0000	0.0003	0.0000	0.0001	0.0000	0.0006	0.0077
77	212.3616	0.0296	33.7984	0.0000	0.0000	0.0000	0.0000	0.0000	0.0000	0.0079
78	213.8443	0.0294	34.0344	0.0000	0.0000	0.0000	0.0000	0.0000	0.0000	0.0079
79	214.5587	0.0293	34.1481	0.0000	0.0000	0.0000	0.0000	0.0000	0.0002	0.0088
80	216.2327	0.0291	34.4145	0.0011	0.0000	0.0003	0.0002	0.0001	0.0000	0.0079
81	216.8101	0.0290	34.5064	0.0000	0.0000	0.0000	0.0002	0.0001	0.0000	0.0079
82	216.8799	0.0290	34.5175	0.0005	0.0000	0.0000	0.0000	0.0000	0.0000	0.0079
83	218.9709	0.0287	34.8503	0.0005	0.0003	0.0000	0.0000	0.0000	0.0027	0.0079
84	227.1717	0.0277	36.1555	0.0047	0.0004	0.0009	0.0007	0.0009	0.0030	0.0079
85	228.6671	0.0275	36.3935	0.0000	0.0000	0.0003	0.0000	0.0004	0.0000	0.0079
86	233.1147	0.0270	37.1014	0.0000	0.0000	0.0000	0.0000	0.0000	0.0000	0.0079
87	233.4723	0.0269	37.1583	0.0000	0.0000	0.0001	0.0001	0.0001	0.0000	0.0079
88	236.0822	0.0266	37.5736	0.0253	0.0050	0.0180	0.0141	0.0122	0.0263	0.0079
89	237.4866	0.0265	37.7972	0.0021	0.0006	0.0024	0.0018	0.0015	0.0033	0.0079
90	241.6850	0.0260	38.4654	0.0000	0.0000	0.0000	0.0001	0.0000	0.0000	0.0079
				0.9271	0.9245	0.2834	0.0955	0.1684	0.8730	

11.1 Zidovi u smjeru x

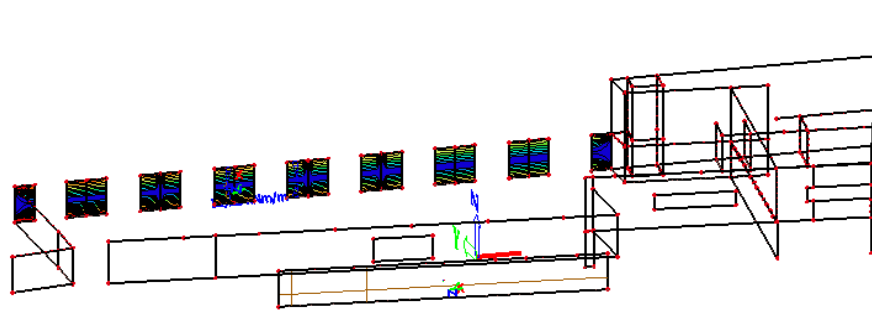

Slika 63: Prikaz položaja promatranih zidova u smjeru x na razini podzemne garaže

$$H_w = 4,10\text{m}$$

$$b = 25\text{cm}$$

$$L_w = 2,0\text{m}$$

$$H_w / L_w = 4,10 / 2,00 = 2,05 > 2 \rightarrow \text{zid je vitak}$$

$$a_1 = d \cdot \cot \theta$$

Klasa duktilnosti: M

$$DCM - 1 \leq \text{ctg} \theta \leq 2,5$$

$$d = 0,9 \cdot l_w = 0,9 \cdot 2 = 1,8$$

$$a_1 = d \cdot \cot \theta = 1,8 \cdot 1 = 1,8$$

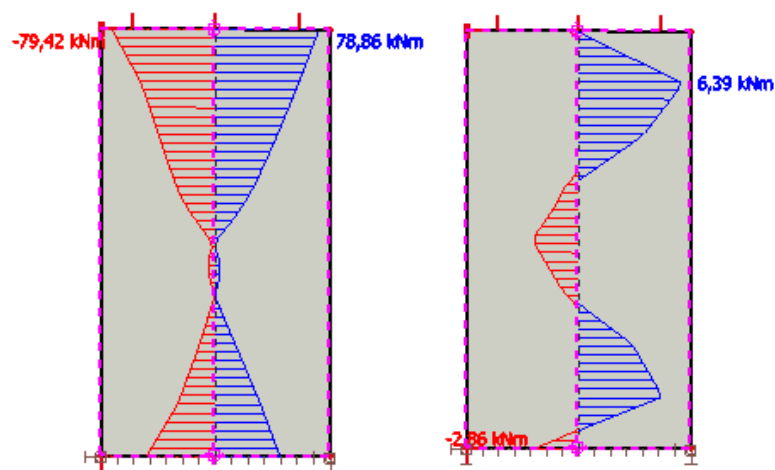

Slika 64: Vrijednosti momenata savijanja za kombinaciju Potres x i GSN Snijeg

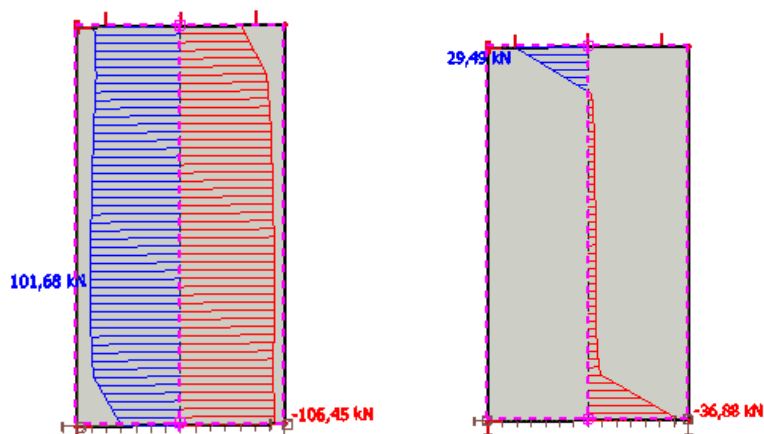

Slika 65: Vrijednosti poprečnih sila za kombinaciju Potres x i GSN Snijeg

Uzdužne sile:

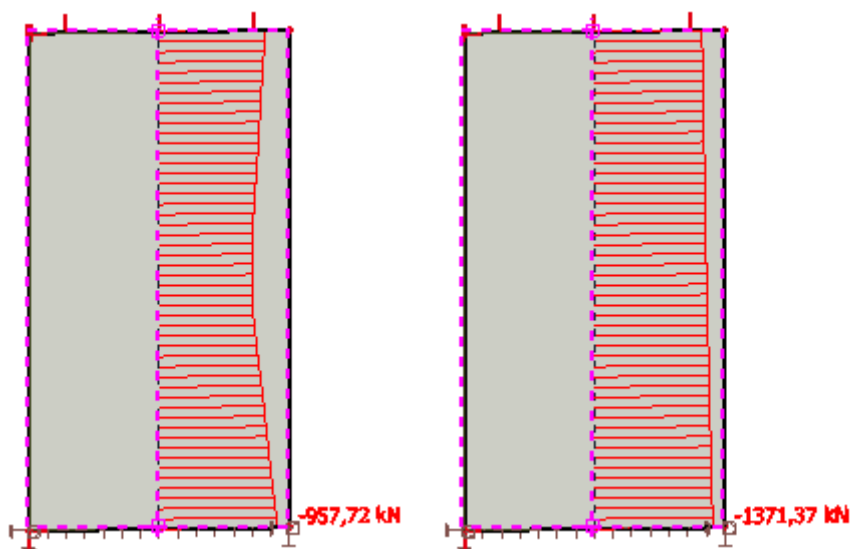

Slika 66: Vrijednosti uzdužnih sila za kombinaciju Potres x i GSN Snijeg

Provjera efekata drugog reda nije izvršena. Predmetna građevina je vrlo kruta, pa su vrijednosti međukatnog pomaka male. Na temelju toga utjecaje pomaka na povećanje reznih sila možemo zanemariti.

11.1.1 Proračun zida u smjeru x – dimenzioniranje promatranog zida

- geometrijske karakteristike zida

Duljina: $l_w=200$ cm

Širina: $b=25$ cm

-statička visina presjeka u x i y smjeru:

(debljina zaštitnog sloja iznosi 3 cm)

$d_x=17$ cm

$d_y=200-(3+1+1+15)=180$ cm

Dimenzioniranje na moment savijanja i uzdužnu silu

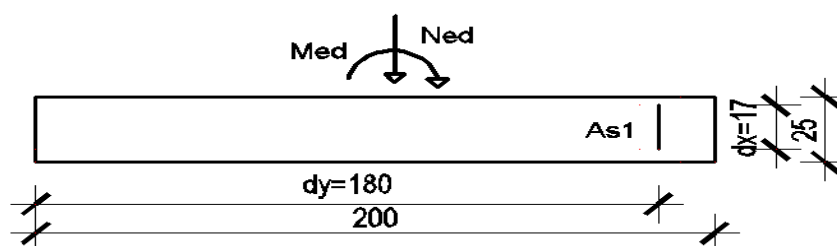

Slika 67: Skica poprečnog presjeka zida

Rezne slie:

$$M_{Ed} = 79,42 \text{ kNm}$$

$$N_{Ed} = 957,72 \text{ kN}$$

$$M_{Ed,s} = M_{Ed} + N_{Ed} \cdot \left(d_y - \frac{h}{2} \right) = 79,42 + 957,72 \cdot \left(1,80 - \frac{2,00}{2} \right) = 845,59 \text{ kNm}$$

$$M_{Rd,lim} = \mu_{Rd,lim} \cdot b \cdot d^2 \cdot f_{cd} = 0,159 \cdot 25 \cdot 180^2 \cdot 2 = 257580 \text{ kNcm} = 2575,8 \text{ kNm}$$

$$A_{s,pot} \approx \frac{M_{Ed,s}}{0,8 \cdot d \cdot f_{yd}} - \frac{N_{Ed,s}}{f_{yd}} = \frac{845,59}{0,8 \cdot 180 \cdot 2} - \frac{957,72}{43,48} = -19,09 \text{ cm}^2$$

Minimalna i maksimalna površina armature rubnih elemenata zida:

$$A_{s,min} \approx \frac{0,1}{100} \cdot 200 \cdot 25 = 5 \text{ cm}^2$$

$$A_{s,max} \approx \frac{4}{100} \cdot 200 \cdot 25 = 200 \text{ cm}^2$$

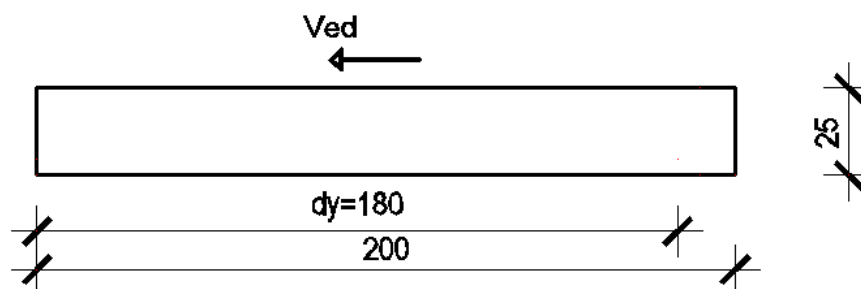
Dimenzioniranje na poprečnu silu

Slika 68: Skica poprečnog presjeka zida

Maksimalna poprečna sila u podnožju zida: $V_{Ed}=106,45$ kN

$$A_{s,\min} = 0,2\% \cdot 25 \cdot 100 = \frac{0,2}{100} \cdot 25 \cdot 100 = 5 \text{ cm}^2 / \text{m}$$

Odabrano: Q – 257 ($A_s = 2,57 \text{ cm}^2$) obe strane zida – $A_{s1} = 5,14 \text{ cm}^2$

Nosivost zidova na poprečne sile (s minimalnom armaturom):

- Slom tlačne dijagonale (tlačni slom hrpta zida zbog posmika)

Izvan kritičnog područja (prema EC2):

$$V_{sd} \leq V_{Rd,\max} = \frac{\alpha_{cw} \cdot b_{w0} \cdot v_1 \cdot z \cdot f_{cd}}{\text{ctg}\theta + \text{tg}\theta}$$

$$\alpha_{cw} = 1, \text{ctg}\theta = 1, \text{tg}\theta = 1$$

$$v_1 = 0,6 \cdot \left(1 - \frac{f_{ck}}{250}\right) = 0,6 \cdot \left(1 - \frac{30}{250}\right) = 0,53$$

$$V_{Rd,\max} = \frac{1 \cdot 25 \cdot 0,53 \cdot 0,8 \cdot 180 \cdot 2}{1+1} = 1908 \text{ kN} > V_{Ed} = 106,45 \text{ kN}$$

U kritičnom području:

$$V_{Ed} \leq 0,4 \cdot V_{Rd,\max}$$

$$106,45 \text{ kN} \leq 0,4 \cdot 1908 = 763,2 \text{ kN}$$

Slom vlačne dijagonale (vlačni slom hrpta zbog posmika)

Napomena: U nastavku je prikazan dokaz nosivosti za armaturnu mrežu

Postupak ovisi o koeficijentu α_s

$$\alpha_s = \frac{M_{Ed}}{V_{sd} \cdot l_w} = \frac{79,42}{106,45 \cdot 2,0} = 0,37$$

$$\text{Ako je: } \alpha_s = \frac{M_{Ed}}{V_{sd} \cdot l_w} < 2$$

Horizontalne šipke u hrptu trebaju zadovoljiti:

$$V_{Rd,s} = V_{Rd,c} + 0,75 \cdot \rho_H \cdot f_{yd,h} \cdot b_{w0} \cdot \alpha_s \cdot l_w$$

ρ_h – omjer armiranja hrpta horizontalnim šipkama ($\rho_h = \frac{A_{s,h}}{A_c}$)

$f_{yd,h}$ – proračunska vrijednost granice popuštanja horizontalne armature hrpta

$V_{Rd,c}$ - proračunska vrijednost posmične otpornosti elementa bez posmične armature u skladu s normom EN 1992-1-1:2004.

Mreža Q-257 ($A_s=2,57 \text{ cm}^2/\text{m}$) – obostrano

$$\rho_h = \rho_v = \frac{A_{s,h}}{A_c} = \frac{2 \cdot 2,57}{25 \cdot 100} = 0,0021$$

$$f_{yd,h} = \frac{f_{y,k}}{\gamma_s} = \frac{500}{1,15} = 434,8 \text{ MPa}$$

$$b_w = 25 \text{ cm}$$

$$\alpha_s = 0,37 \text{ m}$$

$$l_w = 200 \text{ cm}$$

$$V_{Rd,c} = \left[C_{Rdc} \cdot k \cdot (100 \cdot \rho_1 \cdot f_{ck})^{\frac{1}{3}} + k_1 \cdot \sigma_{cp} \right] \cdot b_w \cdot d$$

$$C_{Rdc} = \frac{0,18}{\gamma_c} = \frac{0,18}{1,5} = 0,12$$

$$k = 1,0 + \sqrt{\frac{200}{d}} = 1,0 + \sqrt{\frac{200}{1800}} = 1,333 < 2$$

$$\rho_1 = \rho_H = 0,0021$$

$$f_{ck} = 30 \text{ MPa}$$

$$k_1 = 0,15$$

$$\sigma_{cp} = \frac{N_{Ed}}{A_c} \leq 0,2 \cdot f_{cd}$$

$$\sigma_{cp} = \frac{957,72 \cdot 1000}{250 \cdot 2000} = 1,92 \leq 0,2 \cdot f_{cd} = 4 \text{ MPa}$$

$$V_{Rd,c} = \left[0,12 \cdot 1,33 \cdot (100 \cdot 0,0021 \cdot 30)^{\frac{1}{3}} + 0,15 \cdot 1,92 \right] \cdot 250 \cdot 1800 = 262245,4 N = 262,25 kN$$

$$V_{Rd,s} = V_{Rd,c} + 0,75 \cdot \rho_H \cdot f_{yd,h} \cdot b_{w0} \cdot \alpha_s \cdot l_w$$

$$V_{Rd,s} = 262,25 + 0,75 \cdot 0,0021 \cdot 43,48 \cdot 25 \cdot 0,37 \cdot 180 = 376,27 kN > 106,45 kN$$

Vertikalne šipke u hrptu, usidrene i preklapljene po visini zida u skladu s normom EN 1992 – 1-1:2004 trebaju zadovoljiti:

$$\rho_h \cdot f_{yd,h} \cdot b_{w0} \cdot z \leq \rho_v \cdot f_{yd,v} \cdot b_{w0} \cdot z + \min N_{Ed}$$

$$\rho_v - \text{omjer armiranja vertikalnih šipki u hrptu} \left(\rho_v = \frac{A_{s,v}}{A_c} \right)$$

$f_{d,v}$ – proračunska vrijednost granice popuštanja vertikalne armature hrpta

Mreža Q-257 ($A_s=2,57 \text{ cm}^2/\text{m}$) – obostrano

$$\rho_h = \rho_v = \frac{A_{s,h}}{A_c} = \frac{2 \cdot 2,57}{25 \cdot 100} = 0,0021$$

$$\rho_v \cdot f_{yd,v} \cdot b_{w0} \cdot z + \min N_{Ed} = 0,0021 \cdot 43,48 \cdot 25 \cdot 0,8 \cdot 180 + 957,72 = 1286,42 kN$$

$$\rho_h \cdot f_{yd,h} \cdot b_{w0} \cdot z = 0,0021 \cdot 43,48 \cdot 25 \cdot 0,8 \cdot 180 = 328,7 kN$$

$$328,7 kN < 1286,42 kN$$

Posmični slom klizanjem.

Za klasu DCM nije potrebna provjera na posmični slom klizanjem.

Detaljiranje lokalne duktilnosti zida

Visina kritičnog područja

$$h_{cr} \leq \{2l_w; h_s\} \leq \{400; 405\}$$

$$h_{cr} = 400 \text{ cm}$$

Ovijena armatura (vilice):

DCM

$$\phi_{\min} \geq 6 \text{ mm}$$

Odabrano: 6 mm

-vertikalni razmak vilica:

$$s_w \leq \left\{ 8 \cdot d_{bL}; \frac{b_0}{2}; 175 \text{ mm} \right\}$$

$$s_w \leq \left\{ 8 \cdot 29; \frac{170}{2}; 175 \text{mm} \right\}$$

$$s_w \leq \{232; 85; 175 \text{mm}\}$$

Odabrane vilice: $\Phi 6 \text{mm}/8 \text{ cm}$, $m=2$

-duljina rubnog serklaža:

$$a) l_c = \min \{0,15l_w; 1,5b_w\} = \min \{30; 37,5\} = 30 \text{cm}$$

b) Duljina rubnog elementa zida (l_c) mora biti veća od duljine na kojoj je $\varepsilon_c=3,5\%$

$$l_c = x_u \cdot \left(1 - \frac{\varepsilon_{cu2}}{\varepsilon_{cu2,c}} \right)$$

$$x_u = (v_d + \omega_v) \cdot \frac{l_w \cdot b_c}{b_0}$$

$$v_d = \frac{N_{Ed}}{A_c \cdot f_{cd}} = \frac{957,72}{25 \cdot 200 \cdot 2} = 0,096$$

$$\omega_v = \frac{\rho_v \cdot f_{yd,v}}{f_{cd}} = \frac{0,0021 \cdot 43,48}{2} = 0,048$$

$$x_u = (v_d + \omega_v) \cdot \frac{l_w \cdot b_c}{b_0} = (0,096 + 0,048) \cdot \frac{200 \cdot 25}{17} = 42,35 \text{cm}$$

$$\varepsilon_{cu2} = 0,0035$$

$$\varepsilon_{cu2,c} = 0,0035 + 0,1 \cdot \alpha \cdot \omega_{wd}$$

$$\alpha \cdot \omega_{wd} \geq 30 \cdot \mu_\phi \cdot (v_d + \omega_v) \cdot \varepsilon_{sy,d} \cdot \frac{b_c}{b_0} - 0,035$$

$$T_1 = 0,21 \text{ (s)}$$

$$T_c = 0,5 \text{ (s)} \quad \rightarrow \quad T_c > T_1 \rightarrow \mu_\phi = 1 + 2 \cdot (q_0 - 1) \cdot \left(\frac{T_c}{T_1} \right)$$

$$\mu_\phi = 1 + 2 \cdot (q_0 - 1) \cdot \left(\frac{T_c}{T_1} \right)$$

$$q_0 = q \cdot \frac{M_{Ed}}{M_{Rd}}$$

$$M_{Rd,lim} = \begin{cases} M_{Rd,lim,c} = \mu_{Rd,lim} \cdot b \cdot d^2 \cdot f_{cd} = 0,159 \cdot 25 \cdot 180^2 \cdot 2 = 257580 \text{ (kNcm)} = 2575,8 \text{ (kNm)} \\ M_{Rd,lim,s} = A_{s1} \cdot f_{yd} \cdot 0,8 \cdot d = 12,32 \cdot 43,48 \cdot 0,8 \cdot 180 = 77136,99 \text{ (kNcm)} = 771,36 \text{ (kNm)} \end{cases}$$

$$q_0 = 3 \cdot \frac{79,42}{771,36} = 0,31$$

$$\mu_\phi = 1 + 2 \cdot (0,31 - 1) \cdot \left(\frac{0,5}{0,21} \right) = -2,28$$

$$\varepsilon_{sy,d} = \frac{f_{yd}}{E_s} = \frac{434,8}{200000} = 0,00217$$

$$\alpha \cdot \omega_{wd} \geq 30 \cdot (-2,28) \cdot (0,096 + 0,048) \cdot 0,00217 \cdot \frac{25}{17} - 0,035$$

$$\alpha \cdot \omega_{wd} \geq -0,066$$

Negativna vrijednost u prethodnom izrazu ukazuje da je daljnji proračun pod točkom b) nepotreban. Usvaja se minimalna duljina rubnog elementa koja iznosi 30 cm.

Kontrola tlačnih naprezanja:

-bezdimezionalna vrijednost uzdužne sile (DCM):

$$v_d = \frac{N_{Ed}}{A_c \cdot f_{cd}} < 0,4$$

$$v_d = \frac{N_{Ed}}{A_c \cdot f_{cd}} = \frac{957,72}{25 \cdot 200 \cdot 2} = 0,096$$

-mehanički koeficijent armiranja (DCM):

$$\omega_v = \frac{\rho_v \cdot f_{yd,v}}{f_{cd}} = \frac{0,0021 \cdot 43,48}{2} = 0,048$$

$$\omega_{wd} = \frac{\text{obujam ovijenih vilica} \cdot f_{yd}}{\text{volumen betonske jezgre} \cdot f_{cd}}$$

$$\omega_{wd} = \frac{0,28 \cdot \frac{405}{8} \cdot (2 \cdot 30 + 2 \cdot 17)}{17 \cdot 405 \cdot 30} \cdot \frac{43,48}{2,0} = 0,14$$

$$\mu_\phi = -2,28$$

$$v_d = 0,096$$

$$b_c = 25 \text{ cm}$$

$$b_0 = 17 \text{ cm}$$

$$h_0 = 30 \text{ cm}$$

$$\varepsilon_{sy,d} = \frac{f_{yd}}{E_s} = \frac{434,8}{200000} = 0,00217$$

$$\alpha = \alpha_n \cdot \alpha_s$$

$$\alpha_n = 1 - \frac{\sum b_i^2}{(6 \cdot b_0 \cdot h_0)} = 1 - \frac{2 \cdot 17^2 + 2 \cdot 30^2}{(6 \cdot 17 \cdot 30)} = 0,22$$

$$\alpha_s = \left(1 - \frac{s}{2 \cdot b_0}\right) \cdot \left(1 - \frac{s}{2 \cdot h_0}\right) = \left(1 - \frac{8}{2 \cdot 17}\right) \cdot \left(1 - \frac{8}{2 \cdot 30}\right) = 0,66$$

$$\alpha = 0,22 \cdot 0,66 = 0,145$$

$$\alpha \cdot \omega_{wd} \geq 30 \cdot (-2,28) \cdot (0,096 + 0,048) \cdot 0,00217 \cdot \frac{25}{17} - 0,035$$

$$\alpha \cdot \omega_{wd} = 0,145 \cdot 0,14 = 0,02 \geq -0,066 - \text{odabrana armatura zadovoljava!}$$

Poprečni presjek zida u kritičnom području:

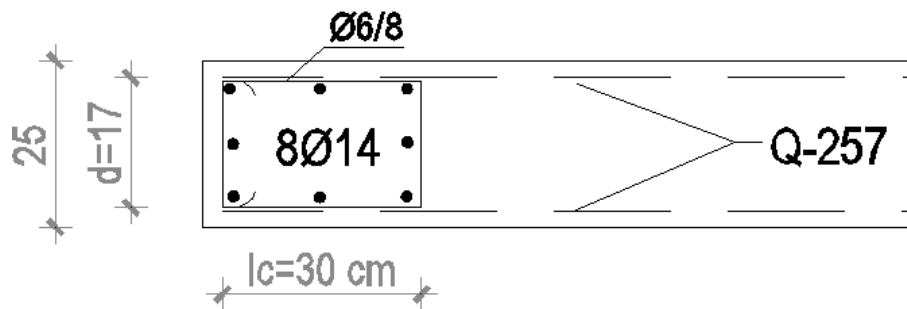

Slika 69: Armatura zida u kritičnom području

11.2 Zid u smjeru x

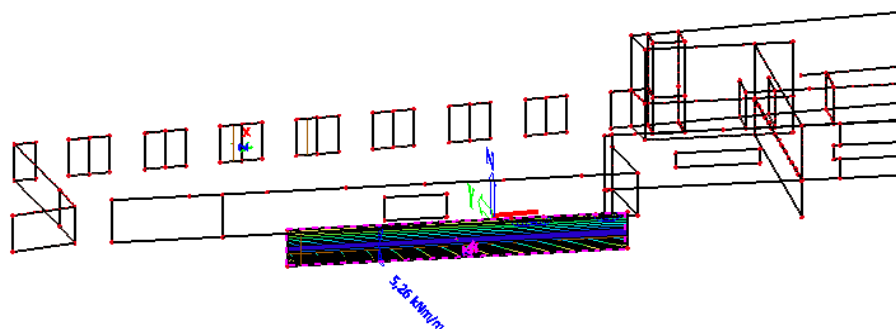

Slika 70: Prikaz položaja promatranog zida u smjeru x na razini podzemne garaže

$$H_w = 4,20\text{m}$$

$$b_w = 25\text{cm}$$

$L_w = 35,20\text{m}$ – Zid se proračunava sa duljinom radne reške koje su na krajevima armirane i povezane armaturom. Duljina radne reške je $l = 5\text{m}$. U modelu su sile integrirane u duljini 5 m, kritični „Integration strip“ (najveće rezne sile) je uzet kao mjerodavan za cijeli zid.

Budući da je zid ovim proračunom odijeljen na sekcije od 5 m, predviđene su kanelure na kraju svake sekcije u dubini od 2 cm koje su ispunjene elastičnom smjesom.

$$H_w / L_w = 4,20 / 35,20 = 0,119 < 2 \rightarrow \text{zid nije vitak}$$

$$\text{Dužina rubnog serklaža: } l_{c0} = \min \{0,15l_w; 1,50b_w\} = 37,5\text{cm}$$

$$a_1 = d \cdot \cot \theta$$

Klasa duktilnosti: M

$$DCM - 1 \leq \cot \theta \leq 2,5$$

$$d = 0,9 \cdot l_w = 0,9 \cdot 5 = 4,5$$

$$a_1 = d \cdot \cot \theta = 4,5 \cdot 1 = 4,5$$

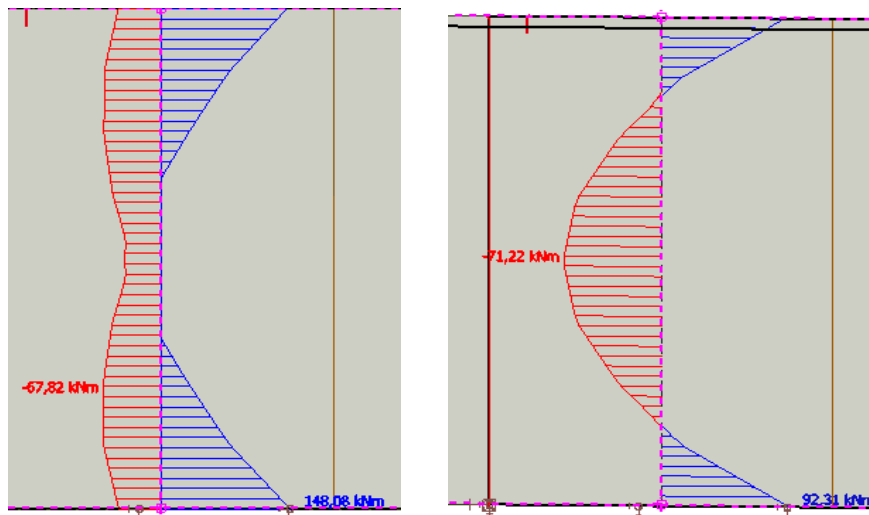

Slika 71: Vrijednosti momenata savijanja za kombinaciju Potres x i GSN Snijeg

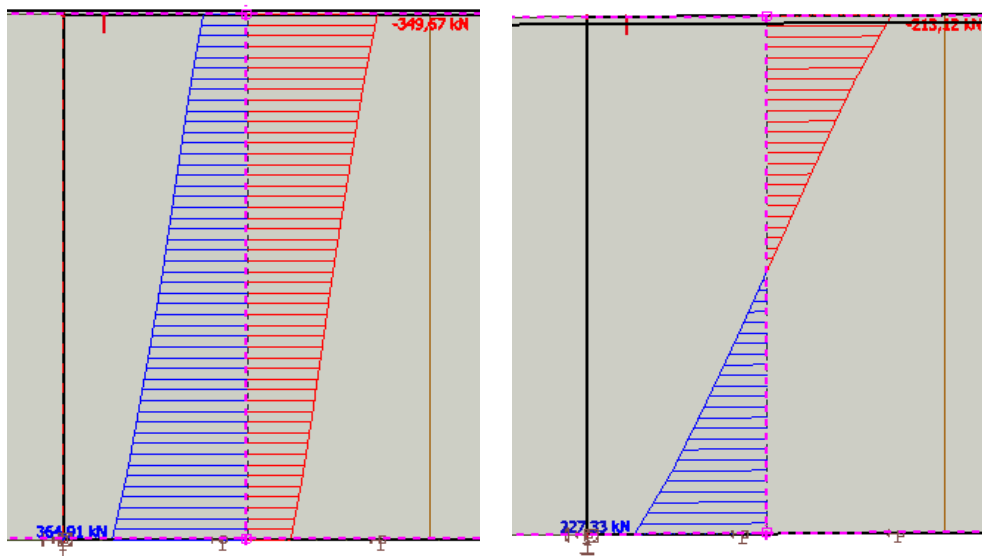

Slika 72: Vrijednosti poprečnih sila za kombinaciju Potres x i GSN Snijeg

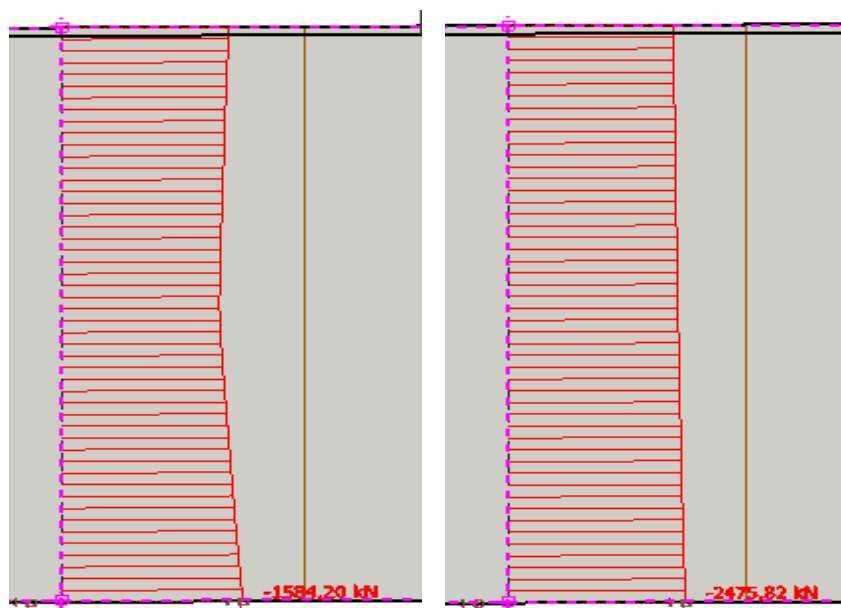

Slika 73: Vrijednosti uzdužnih sila za kombinaciju Potres x i GSN Snijeg

Provjera efekata drugog reda nije izvršena. Predmetna građevina je vrlo kruta, pa su vrijednosti međukatnog pomaka male. Na temelju toga utjecaje pomaka na povećanje reznih sila možemo zanemariti.

11.2.1 Proračun zida u smjeru x – dimenzioniranje promatranog zida

- geometrijske karakteristike zida

Duljina: $l_w=500$ cm

Širina: $b=25$ cm

-statička visina presjeka u x i y smjeru:

(debljina zaštitnog sloja iznosi 3 cm)

$d_x=17$ cm

$d_y=500-(3+1+1+25)=470$ cm

Dimenzioniranje na moment savijanja i uzdužnu silu

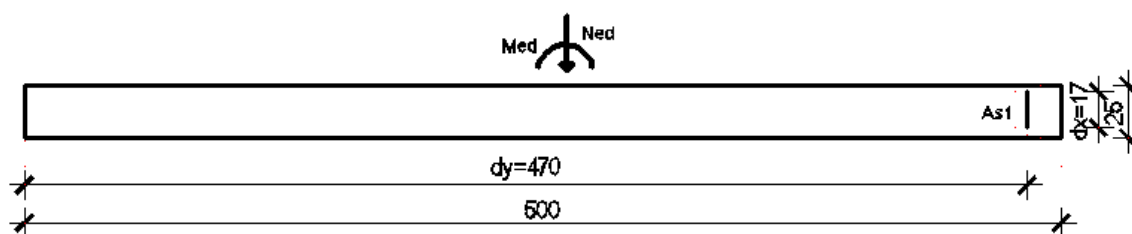

Slika 74: Skica poprečnog presjeka zida

Rezne slie:

$$M_{Ed} = 148,08 \text{ kNm}$$

$$N_{Ed} = 1584,2 \text{ kN}$$

$$M_{Ed,s} = M_{Ed} + N_{Ed} \cdot \left(d_y - \frac{h}{2} \right) = 148,08 + 1584,2 \cdot \left(4,70 - \frac{5,00}{2} \right) = 3633,32 \text{ kNm}$$

$$M_{Rd,lim} = \mu_{Rd,lim} \cdot b \cdot d^2 \cdot f_{cd} = 0,159 \cdot 25 \cdot 470^2 \cdot 2 = 1754155 \text{ kNcm} = 17561,55 \text{ kNm}$$

$$A_{s,pot} \approx \frac{M_{Ed,s}}{0,8 \cdot d \cdot f_{yd}} - \frac{N_{Ed,s}}{f_{yd}} = \frac{3633,32}{0,8 \cdot 180 \cdot 2} - \frac{1584,2}{43,48} = -23,82 \text{ cm}^2$$

Minimalna i maksimalna površina armature rubnih elemenata zida:

$$A_{s,min} \approx \frac{0,1}{100} \cdot 500 \cdot 25 = 12,5 \text{ cm}^2$$

$$A_{s,max} \approx \frac{4}{100} \cdot 500 \cdot 25 = 500 \text{ cm}^2$$

Dimenzioniranje na poprečnu silu

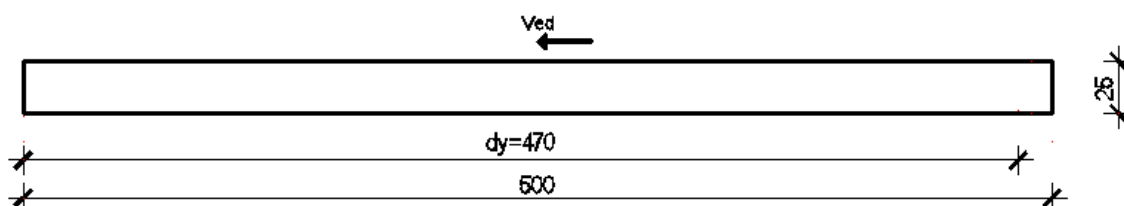

Slika 75: Skica poprečnog presjeka zida

Maksimalna poprečna sila u podnožju zida: $V_{Ed} = 364,91 \text{ kN}$

$$A_{s,min} = 0,2\% \cdot 25 \cdot 100 = \frac{0,2}{100} \cdot 25 \cdot 100 = 5 \text{ cm}^2 / \text{m}$$

Odabrano: Q – 257 ($A_s = 2,57 \text{ cm}^2$) obe strane zida – $A_{s1} = 5,14 \text{ cm}^2$

Nosivost zidova na poprečne sile (s minimalnom armaturom):

- Slom tlačne dijagonale (tlačni slom hrpta zida zbog posmika)

Izvan kritičnog područja (prema EC2):

$$V_{sd} \leq V_{Rd,max} = \frac{\alpha_{cw} \cdot b_{w0} \cdot v_1 \cdot z \cdot f_{cd}}{\text{ctg}\theta + \text{tg}\theta}$$

$$\alpha_{cw} = 1, ctg\theta = 1, tg\theta = 1$$

$$v_1 = 0,6 \cdot \left(1 - \frac{f_{ck}}{250}\right) = 0,6 \cdot \left(1 - \frac{30}{250}\right) = 0,53$$

$$V_{Rd,max} = \frac{1 \cdot 25 \cdot 0,53 \cdot 0,8 \cdot 470 \cdot 2}{1+1} = 4982kN > V_{Ed} = 364,91kN$$

U kritičnom području:

$$V_{Ed} \leq 0,4 \cdot V_{Rd,max}$$

$$364,91kN \leq 0,4 \cdot 4982 = 1992,8kN$$

Slom vlačne dijagonale (vlačni slom hrpta zbog posmika)

Napomena: U nastavku je prikazan dokaz nosivosti armaturne mreže

Postupak ovisi o koeficijentu α_s

$$\alpha_s = \frac{M_{Ed}}{V_{Sd} \cdot l_w} = \frac{148,08}{364,91 \cdot 5,0} = 0,08$$

$$\text{Ako je: } \alpha_s = \frac{M_{Ed}}{V_{Sd} \cdot l_w} < 2$$

Horizontalne šipke u hrptu trebaju zadovoljiti:

$$V_{Rd,s} = V_{Rd,c} + 0,75 \cdot \rho_H \cdot f_{yd,h} \cdot b_{w0} \cdot \alpha_s \cdot l_w$$

$$\rho_h - \text{omjer armiranja hrpta horizontalnim šipkama } \left(\rho_h = \frac{A_{s,h}}{A_c}\right)$$

$f_{yd,h}$ – proračunska vrijednost granice popuštanja horizontalne armature hrpta

$V_{Rd,c}$ - proračunska vrijednost posmične otpornosti elementa bez posmične armature u skladu s normom EN 1992-1-1:2004.

Mreža Q-257 ($A_s=2,57 \text{ cm}^2/\text{m}$) – obostrano

$$\rho_h = \rho_v = \frac{A_{s,h}}{A_c} = \frac{2 \cdot 2,57}{25 \cdot 100} = 0,0021$$

$$f_{yd,h} = \frac{f_{y,k}}{\gamma_s} = \frac{500}{1,15} = 434,8MPa$$

$$b_w = 25cm$$

$$\alpha_s = 0,08m$$

$$l_w = 500 \text{ cm}$$

$$V_{Rd,c} = \left[C_{Rdc} \cdot k \cdot (100 \cdot \rho_1 \cdot f_{ck})^{\frac{1}{3}} + k_1 \cdot \sigma_{cp} \right] \cdot b_w \cdot d$$

$$C_{Rdc} = \frac{0,18}{\gamma_c} = \frac{0,18}{1,5} = 0,12$$

$$k = 1,0 + \sqrt{\frac{200}{d}} = 1,0 + \sqrt{\frac{200}{2400}} = 1,29 < 2$$

$$\rho_1 = \rho_H = 0,0021$$

$$f_{ck} = 30 \text{ MPa}$$

$$k_1 = 0,15$$

$$\sigma_{cp} = \frac{N_{Ed}}{A_c} \leq 0,2 \cdot f_{cd}$$

$$\sigma_{cp} = \frac{1584,2 \cdot 1000}{250 \cdot 5000} = 1,27 \leq 0,2 \cdot f_{cd} = 4 \text{ MPa}$$

$$V_{Rd,c} = \left[0,12 \cdot 1,29 \cdot (100 \cdot 0,0021 \cdot 30)^{\frac{1}{3}} + 0,15 \cdot 1,27 \right] \cdot 250 \cdot 4700 = 559772,8 \text{ N} = 559,77 \text{ kN}$$

$$V_{Rd,s} = V_{Rd,c} + 0,75 \cdot \rho_H \cdot f_{yd,h} \cdot b_{w0} \cdot \alpha_s \cdot l_w$$

$$V_{Rd,s} = 559,77 + 0,75 \cdot 0,0021 \cdot 43,48 \cdot 25 \cdot 0,08 \cdot 500 = 628,3 \text{ kN} > 364,91 \text{ kN}$$

Vertikalne šipke u hrptu, usidrene i preklapljene po visini zida u skladu s normom EN 1992 – 1-1:2004 trebaju zadovoljiti:

$$\rho_h \cdot f_{yd,h} \cdot b_{w0} \cdot z \leq \rho_v \cdot f_{yd,v} \cdot b_{w0} \cdot z + \min N_{Ed}$$

$$\rho_v - \text{omjer armiranja vertikalnih šipki u hrptu} \left(\rho_v = \frac{A_{s,v}}{A_c} \right)$$

$f_{d,v}$ – proračunska vrijednost granice popuštanja vertikalne armature hrpta

Mreža Q-257 ($A_s=2,57 \text{ cm}^2/\text{m}$) – obostrano

$$\rho_h = \rho_v = \frac{A_{s,h}}{A_c} = \frac{2 \cdot 2,57}{25 \cdot 100} = 0,0021$$

$$\rho_v \cdot f_{yd,v} \cdot b_{w0} \cdot z + \min N_{Ed} = 0,0021 \cdot 43,48 \cdot 25 \cdot 0,8 \cdot 470 + 1584,2 = 2442,5 \text{ kN}$$

$$\rho_h \cdot f_{yd,h} \cdot b_{w0} \cdot z = 0,0021 \cdot 43,48 \cdot 25 \cdot 0,8 \cdot 470 = 858,3 \text{ kN}$$

$$858,3 \text{ kN} < 2442,5 \text{ kN}$$

Posmični slom klizanjem.

Za klasu DCM nije potrebna provjera na posmični slom klizanjem.

Detaljiranje lokalne duktilnosti zida

Visina kritičnog područja

$$h_{cr} = h_s = 4,20m$$

$$h_{cr} = 420cm$$

Ovijena armatura (vilice):

DCM

$$\phi_{min} \geq 6mm$$

Odabrano: 6 mm

-vertikalni razmak vilica:

$$s_w \leq \left\{ 8 \cdot d_{bL}; \frac{b_0}{2}; 175mm \right\}$$

$$s_w \leq \left\{ 8 \cdot 29; \frac{170}{2}; 175mm \right\}$$

$$s_w \leq \{232; 85; 175mm\}$$

Odabrane vilice: $\Phi 6mm/8cm$, $m=2$

-duljina rubnog serklaža:

$$a) l_c = \min \{0,15l_w; 1,5b_w\} = \min \{75; 37,5\} = 37,5cm$$

b) Duljina rubnog elementa zida (l_c) mora biti veća od duljine na kojoj je $\epsilon_c=3,5\%$

$$l_c = x_u \cdot \left(1 - \frac{\epsilon_{cu2}}{\epsilon_{cu2,c}} \right)$$

$$x_u = (v_d + \omega_v) \cdot \frac{l_w \cdot b_c}{b_0}$$

$$v_d = \frac{N_{Ed}}{A_c \cdot f_{cd}} = \frac{1584,2}{25 \cdot 500 \cdot 2} = 0,06$$

$$\omega_v = \frac{\rho_v \cdot f_{yd,v}}{f_{cd}} = \frac{0,0021 \cdot 43,48}{2} = 0,048$$

$$x_u = (v_d + \omega_v) \cdot \frac{l_w \cdot b_c}{b_0} = (0,06 + 0,048) \cdot \frac{500 \cdot 25}{17} = 79,4 \text{ cm}$$

$$\varepsilon_{cu2} = 0,0035$$

$$\varepsilon_{cu2,c} = 0,0035 + 0,1 \cdot \alpha \cdot \omega_{wd}$$

$$\alpha \cdot \omega_{wd} \geq 30 \cdot \mu_\phi \cdot (v_d + \omega_v) \cdot \varepsilon_{sy,d} \cdot \frac{b_c}{b_0} - 0,035$$

$$T_1 = 1,0 \text{ (s)}$$

$$T_c = 0,5 \text{ (s)} \quad \rightarrow \quad T_1 > T_c \rightarrow \mu_\phi = 2 \cdot (q_0 - 1)$$

$$\mu_\phi = 2 \cdot (q_0 - 1)$$

$$q_0 = q \cdot \frac{M_{Ed}}{M_{Rd}}$$

$$M_{Rd,lim} = \begin{cases} M_{Rd,lim,c} = \mu_{Rd,lim} \cdot b \cdot d^2 \cdot f_{cd} = 0,159 \cdot 25 \cdot 470^2 \cdot 2 = 1756155 \text{ (kNcm)} = 17561,55 \text{ (kNm)} \\ M_{Rd,lim,s} = A_{s1} \cdot f_{yd} \cdot 0,8 \cdot d = 12,32 \cdot 43,48 \cdot 0,8 \cdot 470 = 201413,27 \text{ (kNcm)} = 2014,13 \text{ (kNm)} \end{cases}$$

$$q_0 = 3 \cdot \frac{148,08}{2014,13} = 0,22$$

$$\mu_\phi = 2 \cdot (q_0 - 1) = 2 \cdot (0,22 - 1) = -1,56$$

$$\varepsilon_{sy,d} = \frac{f_{yd}}{E_s} = \frac{434,8}{200000} = 0,00217$$

$$\alpha \cdot \omega_{wd} \geq 30 \cdot (-1,56) \cdot (0,06 + 0,048) \cdot 0,00217 \cdot \frac{25}{17} - 0,035$$

$$\alpha \cdot \omega_{wd} \geq -0,05$$

Negativna vrijednost u prethodnom izrazu ukazuje da je daljnji proračun pod točkom b) nepotreban. Usvaja se minimalna duljina rubnog elementa koja iznosi 37,5 cm.

Kontrola tlačnih naprezanja:

-bezdimenzionalna vrijednost uzdužne sile (DCM):

$$v_d = \frac{N_{Ed}}{A_c \cdot f_{cd}} < 0,4$$

$$v_d = \frac{N_{Ed}}{A_c \cdot f_{cd}} = \frac{1584,2}{25 \cdot 500 \cdot 2} = 0,06$$

-mehanički koeficijent armiranja (DCM):

$$\omega_v = \frac{\rho_v \cdot f_{yd,v}}{f_{cd}} = \frac{0,0021 \cdot 43,48}{2} = 0,048$$

$$\omega_{wd} = \frac{\text{obujam ovijenih vilica} \cdot f_{yd}}{\text{volumen betonske jezgre} \cdot f_{cd}}$$

$$\omega_{wd} = \frac{0,28 \cdot \frac{420}{8} \cdot (2 \cdot 37,5 + 2 \cdot 17)}{17 \cdot 420 \cdot 37,5} \cdot \frac{43,48}{2,0} = 0,13$$

$$\mu_\phi = -1,56$$

$$\nu_d = 0,06$$

$$b_c = 25 \text{ cm}$$

$$b_0 = 17 \text{ cm}$$

$$h_0 = 37,5 \text{ cm}$$

$$\varepsilon_{sy,d} = \frac{f_{yd}}{E_s} = \frac{434,8}{200000} = 0,00217$$

$$\alpha = \alpha_n \cdot \alpha_s$$

$$\alpha_n = 1 - \frac{\sum b_i^2}{(6 \cdot b_0 \cdot h_0)} = 1 - \frac{2 \cdot 17^2 + 2 \cdot 37,5^2}{(6 \cdot 37,5 \cdot 17)} = 0,11$$

$$\alpha_s = \left(1 - \frac{s}{2 \cdot b_0}\right) \cdot \left(1 - \frac{s}{2 \cdot h_0}\right) = \left(1 - \frac{8}{2 \cdot 17}\right) \cdot \left(1 - \frac{8}{2 \cdot 37,5}\right) = 0,68$$

$$\alpha = 0,11 \cdot 0,68 = 0,075$$

$$\alpha \cdot \omega_{wd} \geq -0,05$$

$$\alpha \cdot \omega_{wd} = 0,075 \cdot 0,13 = 0,00975 \geq -0,05 \text{ -odabrana armatura zadovoljava!}$$

Poprečni presjek zida u kritičnom području:

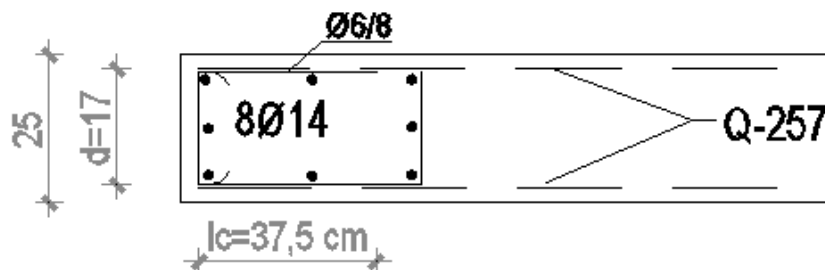

Slika 76: Armatura zida u kritičnom području

11.3 Zidni nosač u smjeru x

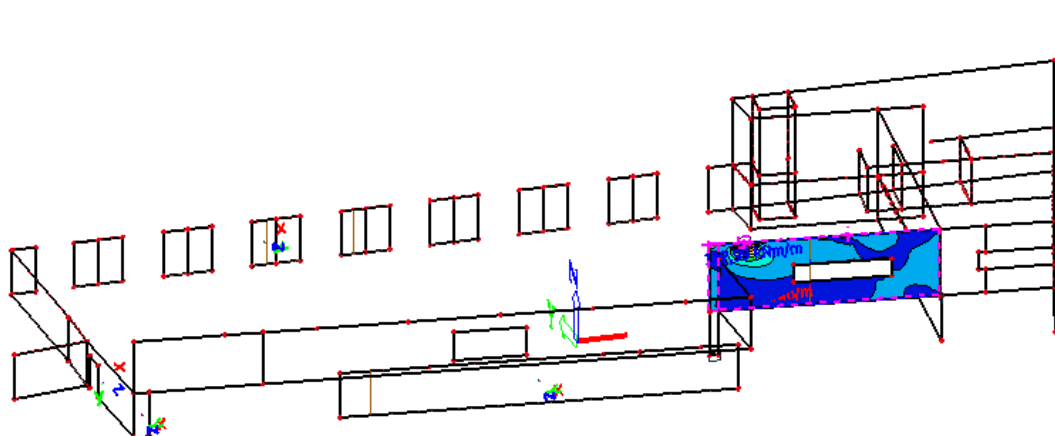

Slika 77: Prikaz položaja promatranog zida u smjeru x na razini prizemlja

$$H_w = 6,20\text{m}$$

$$b_w = 20\text{cm}$$

$$L_w = 20\text{m}$$

Nosač se proračunava na više utjecaja koji mu zadaju opterećenje u njegovoj ravnini i okomito na ravninu. Na vrhu nosača na dva mjesta se oslanja krovna rešetka - koncentrirane sile koje uzrokuju lokalno gnječenje i pomake u y smjeru GKS.

-Pomaci u smjeru y za kombinaciju GSU - „Vjetar 0°“ $1,35 \cdot (g + \Delta g) + 1,5 \cdot w_0$

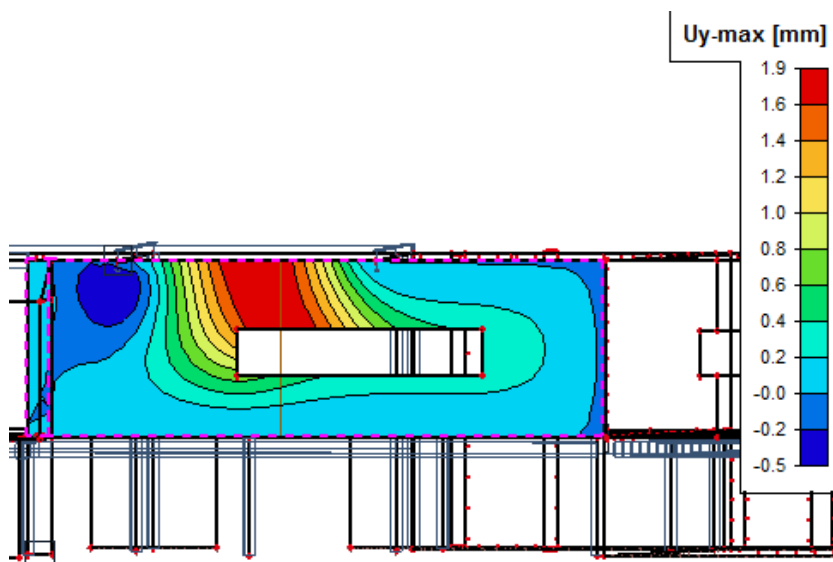

Slika 78: Prikaz max pomaka u smjeru y (okomito na ravninu nosača)

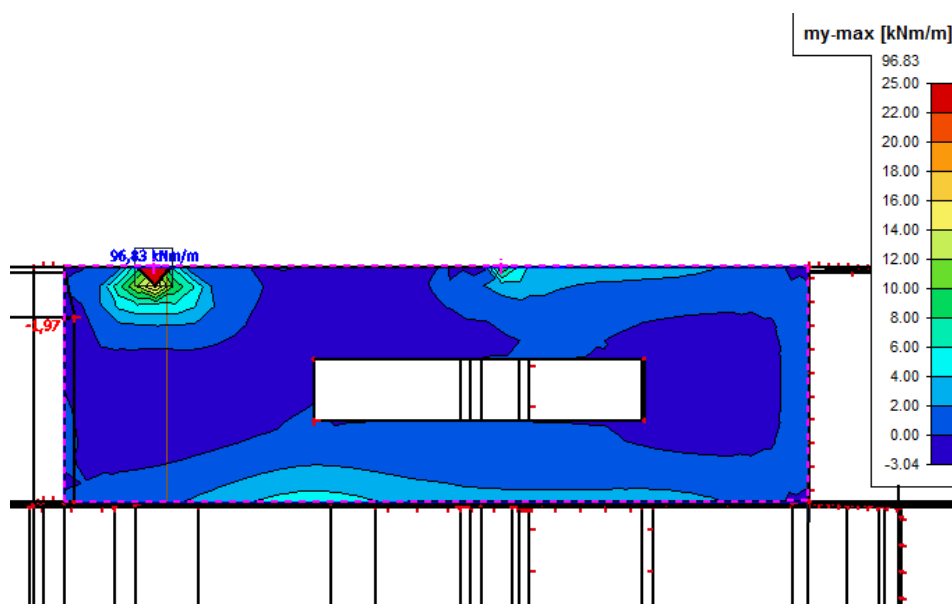

Slika 79: Prikaz max momenata savijanja oko osi y (LCS) za Vjetar 0

Moment savijanja:

$$M_{sd} = 3,04 \text{ kNm} / \text{m}$$

$$\mu_{s1} = \frac{M_{sd}}{b \cdot d^2 \cdot f_{cd}} = \frac{3,04 \cdot 100}{100 \cdot 15^2 \cdot 2} = 0,007 \text{ cm}^2 / \text{m}$$

$$A_{s1} = \frac{M_{sd}}{0,984 \cdot d \cdot f_{yd}} = \frac{3,04 \cdot 100}{0,984 \cdot 15 \cdot 43,48} = 0,47 \text{ cm}^2 / \text{m}$$

Moment na štapnom elementu geometrijskih karakteristika promatranog nosača:

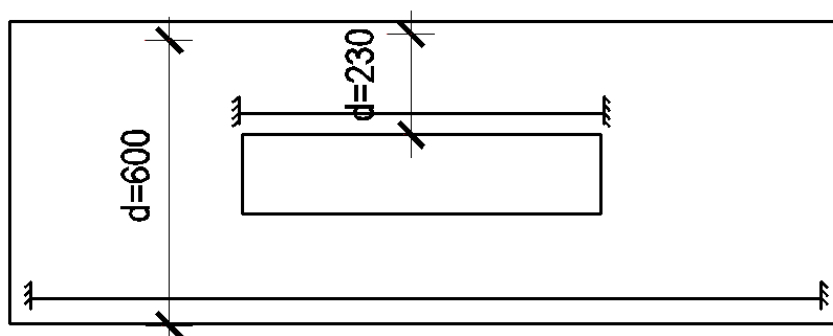

Slika 80: Usvojeni linijski elementi

-greda 1

$$M_{sd} = 699,6 \text{ kNm}$$

$$\mu_{s1} = \frac{M_{sd}}{b \cdot d^2 \cdot f_{cd}} = \frac{699,6 \cdot 100}{20 \cdot 230^2 \cdot 2} = 0,03$$

$$A_{s1} = \frac{M_{sd}}{0,968 \cdot d \cdot f_{yd}} = \frac{699,6 \cdot 100}{0,971 \cdot 230 \cdot 43,48} = 7,2 \text{ cm}^2$$

Odabrana armatura 3Ø20 $A_s=9,42 \text{ cm}^2$

-greda 2

$$M_{sd} = 504,42 \text{ kNm}$$

$$\mu_{s1} = \frac{M_{sd}}{b \cdot d^2 \cdot f_{cd}} = \frac{504,42 \cdot 100}{20 \cdot 600^2 \cdot 2} = 0,0035$$

$$A_{s1} = \frac{M_{sd}}{0,965 \cdot d \cdot f_{yd}} = \frac{504,42 \cdot 100}{0,965 \cdot 600 \cdot 43,48} = 2 \text{ cm}^2$$

Odabrana armatura 2Ø14 $A_s=3,08 \text{ cm}^2$

-greda 2' (opterećenje od pozicije 100 ispod otvora)

$$M_{sd} = 618,84 \text{ kNm}$$

$$\mu_{s1} = \frac{M_{sd}}{b \cdot d^2 \cdot f_{cd}} = \frac{618,84 \cdot 100}{20 \cdot 165^2 \cdot 2} = 0,05$$

$$A_{s1} = \frac{M_{sd}}{0,987 \cdot d \cdot f_{yd}} = \frac{618,84 \cdot 100}{0,987 \cdot 600 \cdot 43,48} = 8,73 \text{ cm}^2$$

Odabrana armatura 3Ø20 $A_s=9,42 \text{ cm}^2$

Proračun na poprečnu silu h=2,4m

$$V_{Ed} = -55,72 \text{ kN}$$

$$A_s=6,42 \text{ cm}^2$$

Dio poprečne sile koju preuzima beton i uzdužna armatura:

$$V_{Rd,C} = \left[C_{Rd,C} \cdot k \cdot (100 \cdot \rho_l \cdot f_{ck})^{1/3} + k_1 \cdot \sigma_{cp} \right] \cdot b_w \cdot d$$

$$k = 1,0 + \sqrt{\frac{200}{d}} = 1,0 + \sqrt{\frac{200}{2300}} = 1,29 \leq 2,0$$

$$k_1 = 0,15$$

$$\sigma_{cp} = N_{sd} / A_c = 0,0$$

$$C_{Rd,C} = 0,18 / \gamma_c = 0,18 / 1,5 = 0,12$$

$$\sum A_s \approx 6,42 \text{ cm}^2 \quad \rho_l = \frac{\sum A_s}{A_c} = \frac{6,42}{240 \cdot 20} = 0,0013$$

$$V_{Rd,C} = \left[0,12 \cdot 1,29 \cdot (100 \cdot 0,0013 \cdot 30)^{1/3} + 0,15 \cdot 0,0 \right] \cdot 200 \cdot 2300 = 116959,0 \text{ N} = 116,95 \text{ kN}$$

$$V_{Rd,C(\min)} = [\nu_{\min} + k_1 \cdot \sigma_{cp}] \cdot b_w \cdot d = [0,302 + 0,15 \cdot 0] \cdot 200 \cdot 2300 = 138920N = 138,92kN$$

$$\nu_{\min} = 0,035 \cdot k^{3/2} \cdot f_{cd}^{1/2} = 0,035 \cdot 1,55^{3/2} \cdot 20^{1/2} = 0,302$$

$$V_{Ed} < V_{Rd,C}$$

$$V_{Rd,\max} = 0,5 \cdot \nu \cdot b_w \cdot d \cdot f_{cd} = 0,5 \cdot 0,528 \cdot 200 \cdot 2300 \cdot 20 = 2428800N = 2428,8kN$$

$$\nu = 0,6 \left[1 - \frac{f_{ck}}{250} \right] = 0,6 \left[1 - \frac{30}{250} \right] = 0,528$$

Potrebna računaska poprečna armatura

$$V_{Ed}/V_{Rd,\max} = 55,72/2428,8 \approx 0,022 \Rightarrow V_{Ed} = 0,022 V_{Rd2}$$

$$s_{w,\max} = \min \{0,8 \cdot d; 30,0 \text{ cm}\} = \min \{0,8 \cdot 230 = 192; 30,0\} \Rightarrow s_{w,\max} = 30,0 \text{ cm}$$

$$\rho_{\min} = 0,0011 \quad (C 30/37)$$

$$A_{sw,\min} = \frac{\rho_{\min} \cdot s_w \cdot b_w}{m} = \frac{0,0011 \cdot 30 \cdot 20}{2} = 0,33 \text{ cm}^2$$

Odabrane spone $\varnothing 10$ ($A_{sw}=0,79 \text{ cm}^2$):

$$s_{w,pot} \leq \frac{m \cdot A_{sw,\min}}{\rho_{\min} \cdot b_w} = \frac{2 \cdot 0,79}{0,0011 \cdot 20} = 71,81 \text{ cm}$$

Odabrane spone $\varnothing 10/30$, $m=2$

Ukupna nosivost betona i odabrane poprečne armature:

$$V_{Rd} = V_{Rd,s} = \frac{A_{sw}}{S} \cdot z \cdot f_{ywd} \cdot m \cdot ctg \Theta = \frac{0,79}{30} \cdot (0,9 \cdot 230) \cdot 43,48 \cdot 2 \cdot 1 = 474,01 \text{ kN}$$

$$V_{Ed} < V_{Rd}$$

Kontroliramo nosivost betona:

$$V_{Rd,\max} = \frac{\alpha_{cw} \cdot b_w \cdot z \cdot \nu_1 \cdot f_{cd}}{\tan \Theta + ctg \Theta} = \frac{1,0 \cdot 200 \cdot 0,9 \cdot 2300 \cdot 0,6 \cdot 20}{1+1} = 248400 \text{ kN} > V_{Ed}$$

11.3.1 Proračun na poprečnu silu h=6,15m

$$V_{Ed} = 200kN$$

$$A_s = 6,42cm^2$$

Dio poprečne sile koju preuzima beton i uzdužna armatura:

$$V_{Rd,C} = \left[C_{Rd,C} \cdot k \cdot (100 \cdot \rho_l \cdot f_{ck})^{1/3} + k_1 \cdot \sigma_{cp} \right] \cdot b_w \cdot d$$

$$k = 1,0 + \sqrt{\frac{200}{d}} = 1,0 + \sqrt{\frac{200}{6000}} = 1,18 \leq 2,0$$

$$k_1 = 0,15$$

$$\sigma_{cp} = N_{sd} / A_c = 0,0$$

$$C_{Rd,C} = 0,18 / \gamma_c = 0,18 / 1,5 = 0,12$$

$$\sum A_s \approx 6,42cm^2 \quad \rho_l = \frac{\sum A_s}{A_c} = \frac{6,42}{6150 \cdot 20} = 0,00005$$

$$V_{Rd,C} = \left[0,12 \cdot 1,18 \cdot (100 \cdot 0,00005 \cdot 30)^{1/3} + 0,15 \cdot 0,0 \right] \cdot 200 \cdot 6000 = 92540,56 N = 92,5kN$$

$$V_{Rd,C(\min)} = \left[v_{\min} + k_1 \cdot \sigma_{cp} \right] \cdot b_w \cdot d = \left[0,302 + 0,15 \cdot 0 \right] \cdot 200 \cdot 6000 = 371460 N = 371,46kN$$

$$v_{\min} = 0,035 \cdot k^{3/2} \cdot f_{cd}^{1/2} = 0,035 \cdot 1,55^{3/2} \cdot 20^{1/2} = 0,302$$

$$V_{Ed} < V_{Rd,C}$$

$$V_{Rd,\max} = 0,5 \cdot v \cdot b_w \cdot d \cdot f_{cd} = 0,5 \cdot 0,528 \cdot 200 \cdot 6000 \cdot 20 = 6494400 N = 6494,4kN$$

$$v = 0,6 \left[1 - \frac{f_{ck}}{250} \right] = 0,6 \left[1 - \frac{30}{250} \right] = 0,528$$

Potrebna računaska poprečna armatura

$$V_{Ed} / V_{Rd,\max} = 200 / 6494,4 \approx 0,031 \Rightarrow V_{Ed} = 0,031 V_{Rd2}$$

$$s_{w,\max} = \min \{ 0,8 \cdot d; 30,0 cm \} = \min \{ 0,8 \cdot 600 = 480; 30,0 \} \Rightarrow s_{w,\max} = 30,0 cm$$

$$\rho_{\min} = 0,0011 \quad (C 30 / 37)$$

$$A_{s_{w,\min}} = \frac{\rho_{\min} \cdot s_w \cdot b_w}{m} = \frac{0,0011 \cdot 30 \cdot 20}{2} = 0,33cm^2$$

Odabrane spone $\varnothing 10$ ($A_{sw} = 0,79 cm^2$):

$$s_{w,pot} \leq \frac{m \cdot A_{s_{w,\min}}}{\rho_{\min} \cdot b_w} = \frac{2 \cdot 0,79}{0,0011 \cdot 20} = 71,81cm$$

Odabrane spone $\varnothing 10/30$, $m=2$

Ukupna nosivost betona i odabrane poprečne armature:

$$V_{Rd} = V_{Rd,s} = \frac{A_{sw}}{S} \cdot z \cdot f_{ywd} \cdot m \cdot ctg\Theta = \frac{0,79}{30} \cdot (0,9 \cdot 600) \cdot 43,48 \cdot 2 \cdot 1 = 1236,57 kN$$

$$V_{Ed} < V_{Rd}$$

Kontroliramo nosivost betona:

$$V_{Rd,max} = \frac{\alpha_{cw} \cdot b_w \cdot z \cdot v_1 \cdot f_{cd}}{\tan\Theta + ctg\Theta} = \frac{1,0 \cdot 200 \cdot 0,9 \cdot 6000 \cdot 0,6 \cdot 20}{1+1} = 648000 kN > V_{Ed}$$

Nosač 1	Iznos (kNm/kN)	Pripadna armatura	Površina armature (cm ²)
My (okomito na ravninu)	3,04	Q-283	0,47/m'
My (linijski element 1)	699,6	3Ø20	9,42
My (linijski element 2)	504,42	2Ø14	3,08
Poprečna sila „z“	55,72	Ø10/30	-
Poprečna sila „x“	200,00	Ø10/30	

11.4 Zid u smjeru x

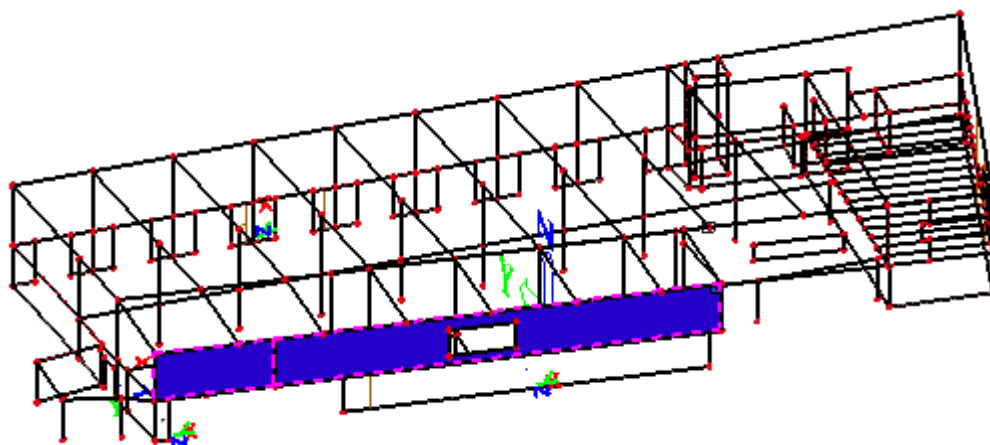

Slika 81: Prikaz položaja promatranog zida u smjeru x na razini prizemlja

$H_w = 4,80\text{m}$

$b_w = 20\text{cm}$

$L_w = 16,8\text{m}$

$l_w = 5,3\text{m}$ – Zid se proračunava sa duljinom radne reške koje su na krajevima armirane i povezane armaturom. Duljina radne reške je $l = 5,3\text{m}$. U modelu su sile integrirane u duljini $5,3\text{m}$, kritični „Integration strip“ (najveće rezne sile) je uzet kao mjerodavan za cijeli zid. Budući da je zid ovim proračunom odijeljen na sekcije od $5,3\text{m}$, predviđene su kanelure na kraju svake sekcije u dubini od 2cm koje su ispunjene elastičnom smjesom.

Zid se sastoji iz tri djela, krajnji lijevi dio i dva desna dijela koja djeli otvor omeđen gredama s gornje i donje strane. Proračun se vrši za srednji dio jer on ima maksimalne rezne sile.

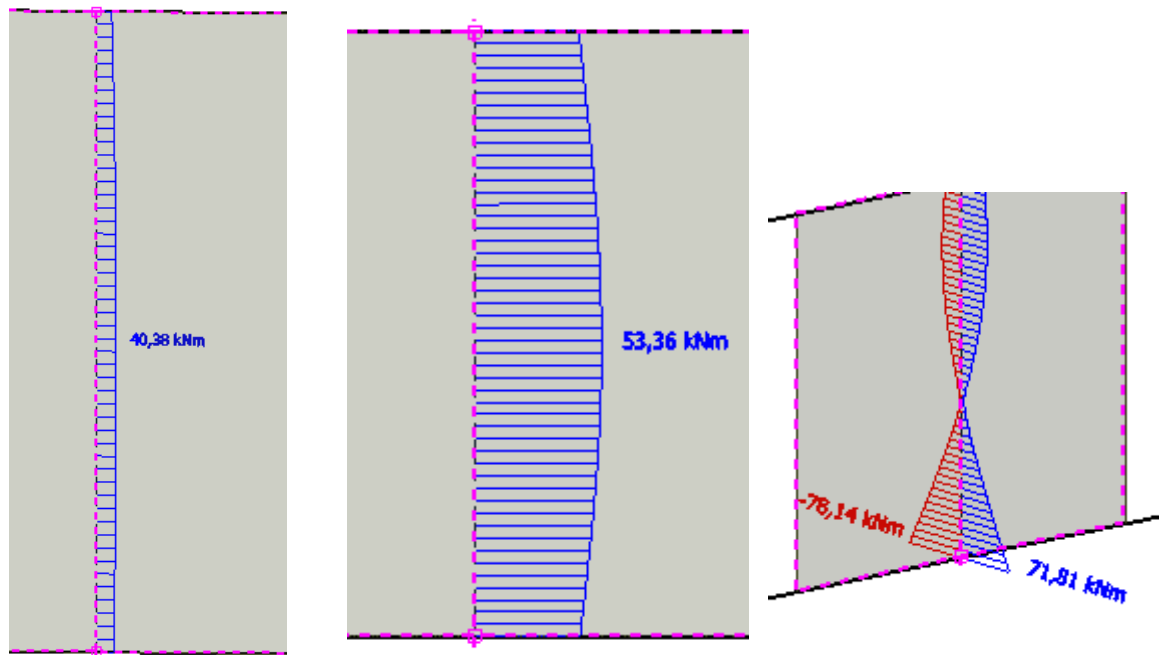

Slika 82: Prikaz max momenta savijanja za kombinaciju Potres y i GSN Snijeg i moment M_y



Slika 83: Prikaz max uzdužne sile za kombinaciju Potres y i GSN Snijeg

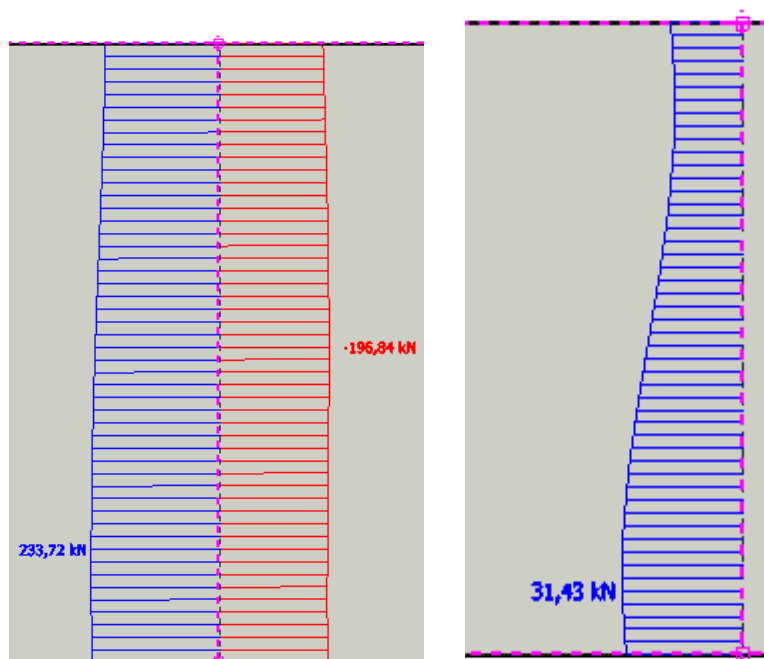

Slika 84: Prikaz max poprečne sile za kombinaciju Potres y

$$a_1 = d \cdot \cot \theta$$

Klasa duktilnosti: M

$$DCM -1 \leq \text{ctg} \theta \leq 2,5$$

$$d = 0,9 \cdot l_w = 0,9 \cdot 5,3 = 4,77$$

$$a_1 = d \cdot \cot \theta = 4,77 \cdot 1 = 4,77$$

Provjera efekata drugog reda nije izvršena. Predmetna građevina je vrlo kruta, pa su vrijednosti međukatnog pomaka male. Na temelju toga utjecaje pomaka na povećanje reznih sila možemo zanemariti.

11.4.1 Proračun zida u smjeru x – dimenzioniranje promatranog zida

- geometrijske karakteristike zida

Duljina: $l_w = 530$ cm

Širina: $b = 20$ cm

-statička visina presjeka u x i y smjeru:

(debljina zaštitnog sloja iznosi 3 cm)

$$d_x = 13,5 \text{ cm}$$

$$d_y = 530 - (3 + 1 + 1 + 25) = 500 \text{ cm}$$

Dimenzioniranje na moment savijanja i uzdužnu silu

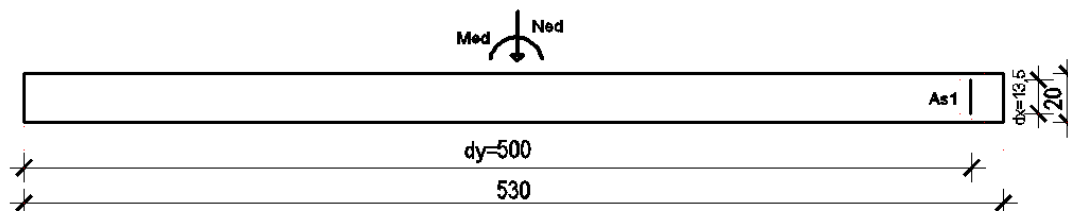

Slika 85: Skica poprečnog presjeka zida

Rezne slie:

$$M_{Ed} = 40,38 \text{ kNm}$$

$$N_{Ed} = 547,69 \text{ kN}$$

$$M_{Ed,s} = M_{Ed} + N_{Ed} \cdot \left(d_y - \frac{h}{2} \right) = 40,38 + 547,69 \cdot \left(5,00 - \frac{5,30}{2} \right) = 1327,45 \text{ kNm}$$

$$M_{Rd,lim} = \mu_{Rd,lim} \cdot b \cdot d^2 \cdot f_{cd} = 0,159 \cdot 20 \cdot 500^2 \cdot 2 = 1590000 \text{ kNcm} = 1590 \text{ kNm}$$

$$A_{s,pot} \approx \frac{M_{Ed,s}}{0,8 \cdot d \cdot f_{yd}} - \frac{N_{Ed,s}}{f_{yd}} = \frac{1327,45}{0,8 \cdot 500 \cdot 2} - \frac{547,69}{43,48} = -10,93 \text{ cm}^2$$

Minimalna i maksimalna površina armature rubnih elemenata zida:

$$A_{s,min} \approx \frac{0,1}{100} \cdot 530 \cdot 20 = 10,6 \text{ cm}^2$$

$$A_{s,max} \approx \frac{4}{100} \cdot 530 \cdot 20 = 424 \text{ cm}^2$$

Dimenzioniranje na poprečnu silu

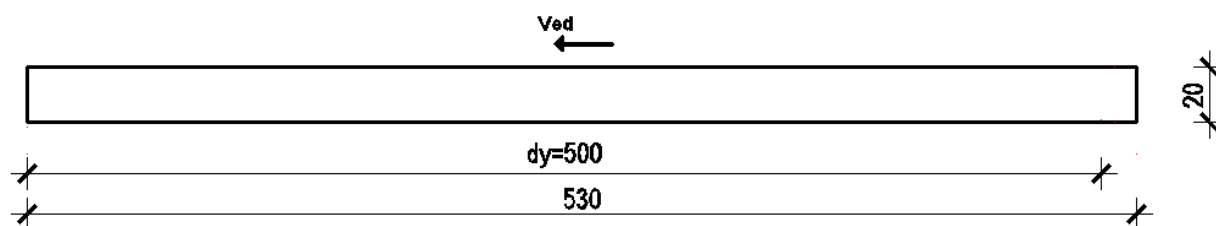

Slika 86: Skica poprečnog presjeka zida

Maksimalna poprečna sila u podnožju zida: $V_{Ed} = 233,72 \text{ kN}$

$$A_{s,min} = 0,2\% \cdot 20 \cdot 100 = \frac{0,2}{100} \cdot 20 \cdot 100 = 4 \text{ cm}^2 / m$$

Odabrano: Q – 226 ($A_s = 2,26\text{cm}^2$) obe strane zida – $A_{s1} = 4,52\text{cm}^2$

Nosivost zidova na poprečne sile (s minimalnom armaturom):

- Slom tlačne dijagonale (tlačni slom hrpta zida zbog posmika)

Izvan kritičnog područja (prema EC2):

$$V_{sd} \leq V_{Rd,max} = \frac{\alpha_{cw} \cdot b_{w0} \cdot v_1 \cdot z \cdot f_{cd}}{ctg\theta + tg\theta}$$

$$\alpha_{cw} = 1, ctg\theta = 1, tg\theta = 1$$

$$v_1 = 0,6 \cdot \left(1 - \frac{f_{ck}}{250}\right) = 0,6 \cdot \left(1 - \frac{30}{250}\right) = 0,53$$

$$V_{Rd,max} = \frac{1 \cdot 20 \cdot 0,53 \cdot 0,8 \cdot 500 \cdot 2}{1+1} = 4240\text{kN} > V_{Ed} = 233,72\text{kN}$$

U kritičnom području:

$$V_{Ed} \leq 0,4 \cdot V_{Rd,max}$$

$$233,72\text{kN} \leq 0,4 \cdot 4240 = 1696\text{kN}$$

Slom vlačne dijagonale (vlačni slom hrpta zbog posmika)

Napomena: U nastavku je prikazan dokaz nosivosti armaturne mreže

Postupak ovisi o koeficijentu α_s

$$\alpha_s = \frac{M_{Ed}}{V_{Sd} \cdot l_w} = \frac{40,38}{233,72 \cdot 5,3} = 0,033$$

$$\text{Ako je: } \alpha_s = \frac{M_{Ed}}{V_{Sd} \cdot l_w} < 2$$

Horizontalne šipke u hrptu trebaju zadovoljiti:

$$V_{Rd,s} = V_{Rd,c} + 0,75 \cdot \rho_H \cdot f_{yd,h} \cdot b_{w0} \cdot \alpha_s \cdot l_w$$

ρ_h – omjer armiranja hrpta horizontalnim šipkama ($\rho_h = \frac{A_{s,h}}{A_c}$)

$f_{yd,h}$ – proračunska vrijednost granice popuštanja horizontalne armature hrpta

$V_{Rd,c}$ - proračunska vrijednost posmične otpornosti elementa bez posmične armature u skladu s normom EN 1992-1-1:2004.

Mreža Q-226 ($A_s=2,26 \text{ cm}^2/\text{m}$) – obostrano

$$\rho_h = \rho_v = \frac{A_{s,h}}{A_c} = \frac{2 \cdot 2,26}{20 \cdot 100} = 0,0022$$

$$f_{yd,h} = \frac{f_{y,k}}{\gamma_s} = \frac{500}{1,15} = 434,8 \text{ MPa}$$

$$b_w = 20 \text{ cm}$$

$$\alpha_s = 0,033 \text{ m}$$

$$l_w = 530 \text{ cm}$$

$$V_{Rd,c} = \left[C_{Rdc} \cdot k \cdot (100 \cdot \rho_1 \cdot f_{ck})^{\frac{1}{3}} + k_1 \cdot \sigma_{cp} \right] \cdot b_w \cdot d$$

$$C_{Rdc} = \frac{0,18}{\gamma_c} = \frac{0,18}{1,5} = 0,12$$

$$k = 1,0 + \sqrt{\frac{200}{d}} = 1,0 + \sqrt{\frac{200}{5000}} = 1,2 < 2$$

$$\rho_1 = \rho_H = 0,0022$$

$$f_{ck} = 30 \text{ MPa}$$

$$k_1 = 0,15$$

$$\sigma_{cp} = \frac{N_{Ed}}{A_c} \leq 0,2 \cdot f_{cd}$$

$$\sigma_{cp} = \frac{547,69 \cdot 1000}{200 \cdot 5300} = 0,52 \leq 0,2 \cdot f_{cd} = 4 \text{ MPa}$$

$$V_{Rd,c} = \left[0,12 \cdot 1,2 \cdot (100 \cdot 0,0022 \cdot 30)^{\frac{1}{3}} + 0,15 \cdot 0,52 \right] \cdot 200 \cdot 5000 = 659938,56 \text{ N} = 659,93 \text{ kN}$$

$$V_{Rd,s} = V_{Rd,c} + 0,75 \cdot \rho_H \cdot f_{yd,h} \cdot b_{w0} \cdot \alpha_s \cdot l_w$$

$$V_{Rd,s} = 659,93 + 0,75 \cdot 0,0022 \cdot 434,8 \cdot 20 \cdot 0,033 \cdot 530 = 685,02 \text{ kN} > 233,72 \text{ kN}$$

Vertikalne šipke u hrptu, usidrene i preklopljene po visini zida u skladu s normom EN 1992 – 1-1:2004 trebaju zadovoljiti:

$$\rho_h \cdot f_{yd,h} \cdot b_{w0} \cdot z \leq \rho_v \cdot f_{yd,v} \cdot b_{w0} \cdot z + \min N_{Ed}$$

ρ_v – omjer armiranja vertikalnih šipki u hrptu ($\rho_v = \frac{A_{s,v}}{A_c}$)

$f_{d,v}$ – proračunska vrijednost granice popuštanja vertikalne armature hrpta

Mreža Q-226 ($A_s=2,26 \text{ cm}^2/\text{m}$) – obostrano

$$\rho_h = \rho_v = \frac{A_{s,h}}{A_c} = \frac{2 \cdot 2,26}{20 \cdot 100} = 0,0022$$

$$\rho_v \cdot f_{yd,v} \cdot b_{w0} \cdot z + \min N_{Ed} = 0,0022 \cdot 43,48 \cdot 20 \cdot 0,8 \cdot 500 + 547,69 = 1312,94 \text{ kN}$$

$$\rho_h \cdot f_{yd,h} \cdot b_{w0} \cdot z = 0,0022 \cdot 43,48 \cdot 20 \cdot 0,8 \cdot 500 = 765,25 \text{ kN}$$

$$765,25 \text{ kN} < 1312,94 \text{ kN}$$

Posmični slom klizanjem.

Za klasu DCM nije potrebna provjera na posmični slom klizanjem.

Detaljiranje lokalne duktilnosti zida

Visina kritičnog područja

$$h_{cr} = h_s = 4,80 \text{ m}$$

$$h_{cr} = 480 \text{ cm}$$

Ovijena armatura (vilice):

DCM

$$\phi_{\min} \geq 6 \text{ mm}$$

Odabrano: 6 mm

-vertikalni razmak vilica:

$$s_w \leq \left\{ 8 \cdot d_{bL}; \frac{b_0}{2}; 175 \text{ mm} \right\}$$

$$s_w \leq \left\{ 8 \cdot 15; \frac{135}{2}; 175 \text{ mm} \right\}$$

$$s_w \leq \{120; 67,5; 175\text{mm}\}$$

Odabrane vilice: $\Phi 6\text{mm}/6\text{ cm}$, $m=2$

-duljina rubnog serklaža:

$$\text{a) } l_c = \min \{0,15l_w; 1,5b_w\} = \min \{79,5; 30\} = 30\text{cm}$$

b) Duljina rubnog elementa zida (l_c) mora biti veća od duljine na kojoj je $\varepsilon_c=3,5\%$

$$l_c = x_u \cdot \left(1 - \frac{\varepsilon_{cu2}}{\varepsilon_{cu2,c}}\right)$$

$$x_u = (v_d + \omega_v) \cdot \frac{l_w \cdot b_c}{b_0}$$

$$v_d = \frac{N_{Ed}}{A_c \cdot f_{cd}} = \frac{547,69}{20 \cdot 530 \cdot 2} = 0,026$$

$$\omega_v = \frac{\rho_v \cdot f_{yd,v}}{f_{cd}} = \frac{0,0022 \cdot 43,48}{2} = 0,048$$

$$x_u = (v_d + \omega_v) \cdot \frac{l_w \cdot b_c}{b_0} = (0,026 + 0,048) \cdot \frac{530 \cdot 20}{13,5} = 58,1\text{cm}$$

$$\varepsilon_{cu2} = 0,0035$$

$$\varepsilon_{cu2,c} = 0,0035 + 0,1 \cdot \alpha \cdot \omega_{wd}$$

$$\alpha \cdot \omega_{wd} \geq 30 \cdot \mu_\phi \cdot (v_d + \omega_v) \cdot \varepsilon_{sy,d} \cdot \frac{b_c}{b_0} - 0,035$$

$$T_1 = 1,0 \text{ (s)}$$

$$T_c = 0,5 \text{ (s)} \quad \rightarrow \quad T_1 > T_c \rightarrow \mu_\phi = 2 \cdot (q_0 - 1)$$

$$\mu_\phi = 2 \cdot (q_0 - 1)$$

$$q_0 = q \cdot \frac{M_{Ed}}{M_{Rd}}$$

$$M_{Rd,lim} = \begin{cases} M_{Rd,lim,c} = \mu_{Rd,lim} \cdot b \cdot d^2 \cdot f_{cd} = 0,159 \cdot 20 \cdot 500^2 \cdot 2 = 1590000 \text{ (kNcm)} = 15900 \text{ (kNm)} \\ M_{Rd,lim,s} = A_{s1} \cdot f_{yd} \cdot 0,8 \cdot d = 12,32 \cdot 43,48 \cdot 0,8 \cdot 500 = 214269,4 \text{ (kNcm)} = 2142,69 \text{ (kNm)} \end{cases}$$

$$q_0 = 3 \cdot \frac{40,38}{2162,69} = 0,056$$

$$\mu_\phi = 2 \cdot (q_0 - 1) = 2 \cdot (0,056 - 1) = -1,88$$

$$\varepsilon_{sy,d} = \frac{f_{yd}}{E_s} = \frac{434,8}{200000} = 0,00217$$

$$\alpha \cdot \omega_{wd} \geq 30 \cdot (-1,88) \cdot (0,026 + 0,048) \cdot 0,00217 \cdot \frac{20}{13,5} - 0,035$$

$$\alpha \cdot \omega_{wd} \geq -0,048$$

Negativna vrijednost u prethodnom izrazu ukazuje da je daljnji proračun pod točkom b) nepotreban. Usvaja se minimalna duljina rubnog elementa koja iznosi 30 cm.

Kontrola tlačnih naprezanja:

-bezdimezionalna vrijednost uzdužne sile (DCM):

$$v_d = \frac{N_{Ed}}{A_c \cdot f_{cd}} < 0,4$$

$$v_d = \frac{N_{Ed}}{A_c \cdot f_{cd}} = \frac{547,69}{20 \cdot 530 \cdot 2} = 0,026$$

-mehanički koeficijent armiranja (DCM):

$$\omega_v = \frac{\rho_v \cdot f_{yd,v}}{f_{cd}} = \frac{0,0022 \cdot 43,48}{2} = 0,048$$

$$\omega_{wd} = \frac{\text{obujam ovijenih vilica} \cdot f_{yd}}{\text{volumen betonske jezgre} \cdot f_{cd}}$$

$$\omega_{wd} = \frac{0,28 \cdot \frac{480}{6} \cdot (2 \cdot 30 + 2 \cdot 13,5)}{30 \cdot 480 \cdot 20} \cdot \frac{43,48}{2,0} = 0,147$$

$$\mu_\phi = -1,88$$

$$v_d = 0,026$$

$$b_c = 20\text{cm}$$

$$b_0 = 13,5\text{cm}$$

$$h_0 = 30\text{cm}$$

$$\varepsilon_{sy,d} = \frac{f_{yd}}{E_s} = \frac{434,8}{200000} = 0,00217$$

$$\alpha = \alpha_n \cdot \alpha_s$$

$$\alpha_n = 1 - \frac{\sum b_i^2}{(6 \cdot b_0 \cdot h_0)} = 1 - \frac{2 \cdot 13,5^2 + 2 \cdot 30^2}{(6 \cdot 30 \cdot 13,5)} = 0,109$$

$$\alpha_s = \left(1 - \frac{s}{2 \cdot b_0}\right) \cdot \left(1 - \frac{s}{2 \cdot h_0}\right) = \left(1 - \frac{6}{2 \cdot 13,5}\right) \cdot \left(1 - \frac{6}{2 \cdot 30}\right) = 0,7$$

$$\alpha = 0,109 \cdot 0,7 = 0,076$$

$$\alpha \cdot \omega_{wd} \geq -0,048$$

$$\alpha \cdot \omega_{wd} = 0,076 \cdot 0,147 = 0,011 \geq -0,048 \text{ - odabrana armatura zadovoljava!}$$

11.5 Zid u smjeru x

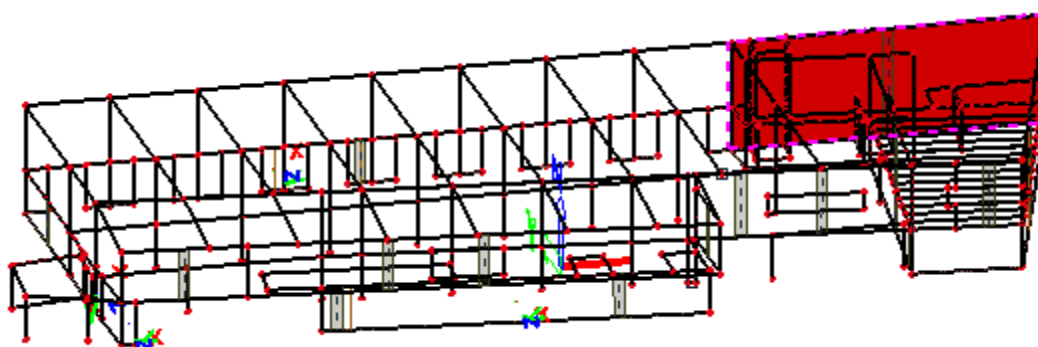

Slika 87: Prikaz položaja promatranog zida u smjeru x

$$H_w = 10,25 \text{ m}$$

$$b_w = 20 \text{ cm}$$

$$L_w = 29,2 \text{ m}$$

$l_w = 7,3 \text{ m}$ - Zid se proračunava sa duljinom radne reške koje su na krajevima armirane i povezane armaturom. Duljina radne reške je $l = 7,3 \text{ m}$. U modelu su sile integrirane u duljini $7,3 \text{ m}$, kritični „Integration strip“ (najveće rezne sile) je uzet kao mjerodavan za cijeli zid. Budući da je zid ovim proračunom odijeljen na sekcije od $7,3 \text{ m}$, predviđene su kanelure na kraju svake sekcije u dubini od 2 cm koje su ispunjene elastičnom smjesom.

Zid se sastoji iz tri djela, krajnji lijevi dio je pod drugim kutem s obzirom na dva desna dijela koja djeli otvor omeđen gredama s gornje i donje strane. Proračun se vrši za srednji dio jer on ima maksimalne rezne sile.

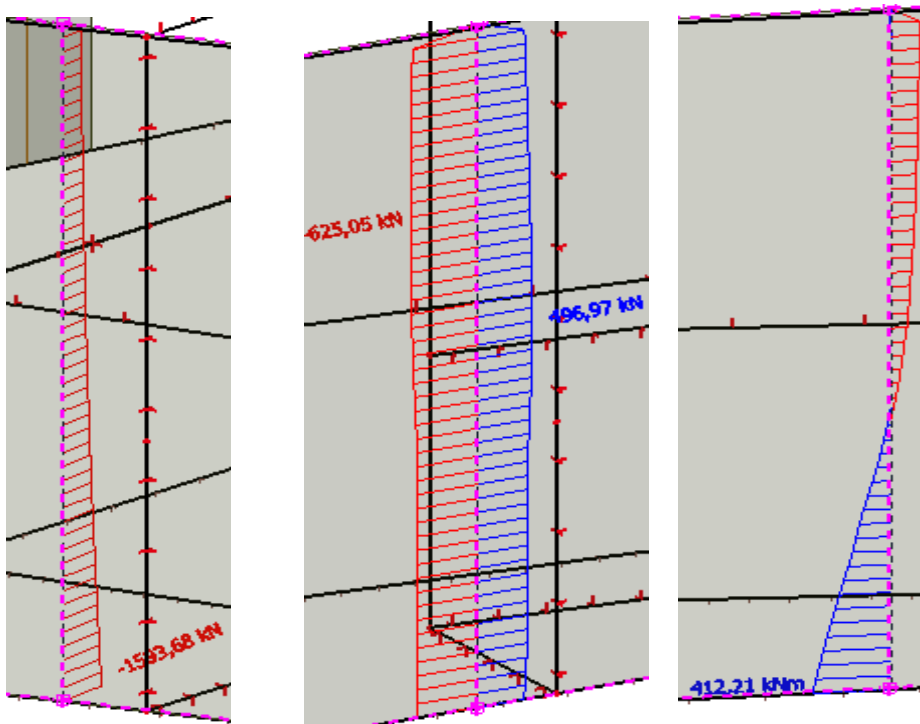
-Rezne sile

Slika 88: Prikaz max uzdužne sile, poprečne sile i momenata savijanja za kombinaciju Potres y

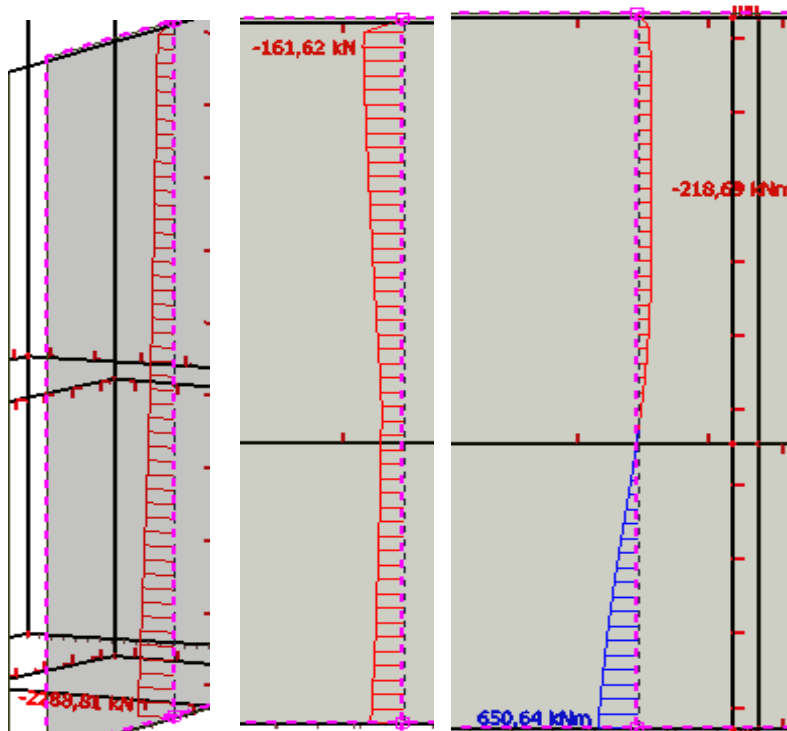

Slika 89: Prikaz max uzdužne sile, poprečne sile i momenata savijanja za kombinaciju GSN Snijeg

$$a_1 = d \cdot \cot \theta$$

Klasa duktilnosti: M

$$DCM -1 \leq \operatorname{ctg} \theta \leq 2,5$$

$$d = 0,9 \cdot l_w = 0,9 \cdot 7,3 = 6,57$$

$$a_1 = d \cdot \cot \theta = 6,57 \cdot 1 = 6,57$$

Provjera efekata drugog reda nije izvršena. Predmetna građevina je vrlo kruta, pa su vrijednosti međukatnog pomaka male. Na temelju toga utjecaje pomaka na povećanje reznih sila možemo zanemariti.

11.5.1 Proračun zida u smjeru x – dimenzioniranje promatranog zida

- geometrijske karakteristike zida

Duljina: $l_w = 730$ m

Širina: $b = 20$ cm

-statička visina presjeka u x i y smjeru:

(debljina zaštitnog sloja iznosi 3 cm)

$d_x = 13,5$ cm

$d_y = 730 - (3 + 1 + 1 + 25) = 700$ cm

Dimenzioniranje na moment savijanja i uzdužnu silu

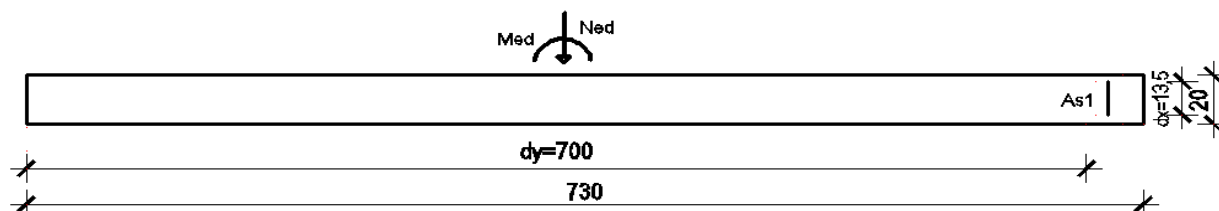

Slika 90: Skica poprečnog presjeka zida

Rezne slie:

$$M_{Ed} = 412,21 \text{ kNm}$$

$$N_{Ed} = 1593,68 \text{ kN}$$

$$M_{Ed,s} = M_{Ed} + N_{Ed} \cdot \left(d_y - \frac{h}{2} \right) = 412,21 + 1593,68 \cdot \left(7,0 - \frac{7,3}{2} \right) = 5751,04 \text{ kNm}$$

$$M_{Rd,lim} = \mu_{Rd,lim} \cdot b \cdot d^2 \cdot f_{cd} = 0,159 \cdot 20 \cdot 700^2 \cdot 2 = 3116400 \text{ kNcm} = 31164 \text{ kNm}$$

$$A_{s,pot} \approx \frac{M_{Ed,s}}{0,8 \cdot d \cdot f_{yd}} - \frac{N_{Ed,s}}{f_{yd}} = \frac{5751,04}{0,8 \cdot 700 \cdot 2} - \frac{1593,68}{43,48} = -31,51 \text{ cm}^2$$

Minimalna i maksimalna površina armature rubnih elemenata zida:

$$A_{s,\min} \approx \frac{0,1}{100} \cdot 700 \cdot 20 = 14 \text{ cm}^2$$

$$A_{s,\max} \approx \frac{4}{100} \cdot 700 \cdot 20 = 424 \text{ cm}^2$$

Dimenzioniranje na poprečnu silu

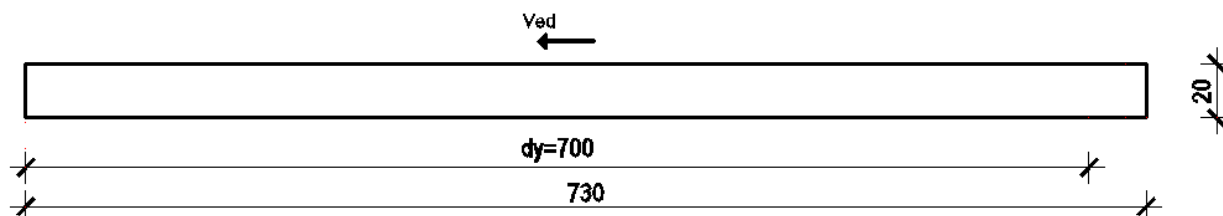

Slika 91: Prikaz poprečnog presjeka zida

Maksimalna poprečna sila u podnožju zida: $V_{Ed}=625,05 \text{ kN}$

$$A_{s,\min} = 0,2\% \cdot 20 \cdot 100 = \frac{0,2}{100} \cdot 20 \cdot 100 = 4 \text{ cm}^2 / m$$

Odabrano: Q – 257 ($A_s = 2,57 \text{ cm}^2$) obe strane zida – $A_{s1} = 5,14 \text{ cm}^2$

Nosivost zidova na poprečne sile (s minimalnom armaturom):

- Slom tlačne dijagonale (tlačni slom hrpta zida zbog posmika)

Izvan kritičnog područja (prema EC2):

$$V_{sd} \leq V_{Rd,\max} = \frac{\alpha_{cw} \cdot b_{w0} \cdot v_1 \cdot z \cdot f_{cd}}{\text{ctg}\theta + \text{tg}\theta}$$

$$\alpha_{cw} = 1, \text{ctg}\theta = 1, \text{tg}\theta = 1$$

$$v_1 = 0,6 \cdot \left(1 - \frac{f_{ck}}{250}\right) = 0,6 \cdot \left(1 - \frac{30}{250}\right) = 0,53$$

$$V_{Rd,\max} = \frac{1 \cdot 20 \cdot 0,53 \cdot 0,8 \cdot 700 \cdot 2}{1+1} = 5936 \text{ kN} > V_{Ed} = 625,05 \text{ kN}$$

U kritičnom području:

$$V_{Ed} \leq 0,4 \cdot V_{Rd,\max}$$

$$625,05 \text{ kN} \leq 0,4 \cdot 5936 = 2374,4 \text{ kN}$$

Slom vlačne dijagonale (vlačni slom hrpta zbog posmika)

Napomena: U nastavku je prikazan dokaz nosivosti armaturne mreže

Postupak ovisi o koeficijentu α_s

$$\alpha_s = \frac{M_{Ed}}{V_{Sd} \cdot l_w} = \frac{412,21}{625,05 \cdot 7,3} = 0,09$$

$$\text{Ako je: } \alpha_s = \frac{M_{Ed}}{V_{Sd} \cdot l_w} < 2$$

Horizontalne šipke u hrptu trebaju zadovoljiti:

$$V_{Rd,s} = V_{Rd,c} + 0,75 \cdot \rho_H \cdot f_{yd,h} \cdot b_{w0} \cdot \alpha_s \cdot l_w$$

$$\rho_h - \text{omjer armiranja hrpta horizontalnim šipkama} \left(\rho_h = \frac{A_{s,h}}{A_c} \right)$$

$f_{yd,h}$ – proračunska vrijednost granice popuštanja horizontalne armature hrpta

$V_{Rd,c}$ - proračunska vrijednost posmične otpornosti elementa bez posmične armature u skladu s normom EN 1992-1-1:2004.

Mreža Q-257 ($A_s=2,57 \text{ cm}^2/\text{m}$) – obostrano

$$\rho_h = \rho_v = \frac{A_{s,h}}{A_c} = \frac{2 \cdot 2,57}{20 \cdot 100} = 0,0026$$

$$f_{yd,h} = \frac{f_{y,k}}{\gamma_s} = \frac{500}{1,15} = 434,8 \text{ MPa}$$

$$b_w = 20 \text{ cm}$$

$$\alpha_s = 0,09 \text{ m}$$

$$l_w = 730 \text{ cm}$$

$$V_{Rd,c} = \left[C_{Rdc} \cdot k \cdot (100 \cdot \rho_1 \cdot f_{ck})^{\frac{1}{3}} + k_1 \cdot \sigma_{cp} \right] \cdot b_w \cdot d$$

$$C_{Rdc} = \frac{0,18}{\gamma_c} = \frac{0,18}{1,5} = 0,12$$

$$k = 1,0 + \sqrt{\frac{200}{d}} = 1,0 + \sqrt{\frac{200}{7000}} = 1,17 < 2$$

$$\rho_1 = \rho_H = 0,0026$$

$$f_{ck} = 30\text{MPa}$$

$$k_1 = 0,15$$

$$\sigma_{cp} = \frac{N_{Ed}}{A_c} \leq 0,2 \cdot f_{cd}$$

$$\sigma_{cp} = \frac{1593,68 \cdot 1000}{200 \cdot 7300} = 1,09 \leq 0,2 \cdot f_{cd} = 4\text{MPa}$$

$$V_{Rd,c} = \left[0,12 \cdot 1,17 \cdot (100 \cdot 0,0026 \cdot 30)^{\frac{1}{3}} + 0,15 \cdot 1,09 \right] \cdot 200 \cdot 7000 = 618716,3\text{N} = 618,72\text{kN}$$

$$V_{Rd,s} = V_{Rd,c} + 0,75 \cdot \rho_H \cdot f_{yd,h} \cdot b_{w0} \cdot \alpha_s \cdot l_w$$

$$V_{Rd,s} = 618,72 + 0,75 \cdot 0,0026 \cdot 43,48 \cdot 20 \cdot 0,09 \cdot 730 = 730,13\text{kN} > 625,05\text{kN}$$

Vertikalne šipke u hrptu, usidrene i preklapljene po visini zida u skladu s normom EN 1992 – 1-1:2004 trebaju zadovoljiti:

$$\rho_h \cdot f_{yd,h} \cdot b_{w0} \cdot z \leq \rho_v \cdot f_{yd,v} \cdot b_{w0} \cdot z + \min N_{Ed}$$

$$\rho_v - \text{omjer armiranja vertikalnih šipki u hrptu} \left(\rho_v = \frac{A_{s,v}}{A_c} \right)$$

$f_{d,v}$ – proračunska vrijednost granice popuštanja vertikalne armature hrpta

Mreža Q-257 ($A_s=2,57 \text{ cm}^2/\text{m}$) – obostrano

$$\rho_h = \rho_v = \frac{A_{s,h}}{A_c} = \frac{2 \cdot 2,57}{20 \cdot 100} = 0,0026$$

$$\rho_v \cdot f_{yd,v} \cdot b_{w0} \cdot z + \min N_{Ed} = 0,0026 \cdot 43,48 \cdot 20 \cdot 0,8 \cdot 700 + 1593,68 = 2665,03\text{kN}$$

$$\rho_h \cdot f_{yd,h} \cdot b_{w0} \cdot z = 0,0026 \cdot 43,48 \cdot 20 \cdot 0,8 \cdot 700 = 1071,34\text{kN}$$

$$1071,34\text{kN} < 2665,03\text{kN}$$

Posmični slom klizanjem.

Za klasu DCM nije potrebna provjera na posmični slom klizanjem.

Detaljiranje lokalne duktilnosti zida

Visina kritičnog područja

$$h_{cr} = h_s = 4,10m$$

$$h_{cr} = 410cm$$

Ovijena armatura (vilice):

DCM

$$\phi_{min} \geq 6mm$$

Odabrano: 6 mm

-vertikalni razmak vilica:

$$s_w \leq \left\{ 8 \cdot d_{bL}; \frac{b_0}{2}; 175mm \right\}$$

$$s_w \leq \left\{ 8 \cdot 15; \frac{135}{2}; 175mm \right\}$$

$$s_w \leq \{120; 67,5; 175mm\}$$

Odabrane vilice: $\Phi 6mm/6$ cm, $m=2$

-duljina rubnog serklaža:

$$a) l_c = \min \{0,15l_w; 1,5b_w\} = \min \{109,5; 30\} = 30cm$$

b) Duljina rubnog elementa zida (l_c) mora biti veća od duljine na kojoj je $\epsilon_c=3,5\%$

$$l_c = x_u \cdot \left(1 - \frac{\epsilon_{cu2}}{\epsilon_{cu2,c}} \right)$$

$$x_u = (v_d + \omega_v) \cdot \frac{l_w \cdot b_c}{b_0}$$

$$v_d = \frac{N_{Ed}}{A_c \cdot f_{cd}} = \frac{1593,68}{20 \cdot 730 \cdot 2} = 0,055$$

$$\omega_v = \frac{\rho_v \cdot f_{yd,v}}{f_{cd}} = \frac{0,0026 \cdot 43,48}{2} = 0,057$$

$$x_u = (v_d + \omega_v) \cdot \frac{l_w \cdot b_c}{b_0} = (0,055 + 0,057) \cdot \frac{730 \cdot 20}{13,5} = 121,12 \text{ cm}$$

$$\varepsilon_{cu2} = 0,0035$$

$$\varepsilon_{cu2,c} = 0,0035 + 0,1 \cdot \alpha \cdot \omega_{wd}$$

$$\alpha \cdot \omega_{wd} \geq 30 \cdot \mu_\phi \cdot (v_d + \omega_v) \cdot \varepsilon_{sy,d} \cdot \frac{b_c}{b_0} - 0,035$$

$$T_1 = 1,0 \text{ (s)}$$

$$T_c = 0,5 \text{ (s)} \quad \rightarrow \quad T_1 > T_c \rightarrow \mu_\phi = 2 \cdot (q_0 - 1)$$

$$\mu_\phi = 2 \cdot (q_0 - 1)$$

$$q_0 = q \cdot \frac{M_{Ed}}{M_{Rd}}$$

$$M_{Rd,lim} = \begin{cases} M_{Rd,lim,c} = \mu_{Rd,lim} \cdot b \cdot d^2 \cdot f_{cd} = 0,159 \cdot 20 \cdot 700^2 \cdot 2 = 3116400 \text{ (kNcm)} = 31164 \text{ (kNm)} \\ M_{Rd,lim,s} = A_{s1} \cdot f_{yd} \cdot 0,8 \cdot d = 12,32 \cdot 43,48 \cdot 0,8 \cdot 700 = 299977,22 \text{ (kNcm)} = 2999,77 \text{ (kNm)} \end{cases}$$

$$q_0 = 3 \cdot \frac{412,21}{2999,77} = 0,41$$

$$\mu_\phi = 2 \cdot (q_0 - 1) = 2 \cdot (0,41 - 1) = -1,18$$

$$\varepsilon_{sy,d} = \frac{f_{yd}}{E_s} = \frac{434,8}{200000} = 0,00217$$

$$\alpha \cdot \omega_{wd} \geq 30 \cdot (-1,18) \cdot (0,055 + 0,057) \cdot 0,00217 \cdot \frac{20}{13,5} - 0,035$$

$$\alpha \cdot \omega_{wd} \geq -0,048$$

Negativna vrijednost u prethodnom izrazu ukazuje da je daljnji proračun pod točkom b) nepotreban. Usvaja se minimalna duljina rubnog elementa koja iznosi 30 cm.

Kontrola tlačnih naprezanja:

-bezdimezionalna vrijednost uzdužne sile (DCM):

$$v_d = \frac{N_{Ed}}{A_c \cdot f_{cd}} < 0,4$$

$$v_d = \frac{N_{Ed}}{A_c \cdot f_{cd}} = \frac{1593,68}{20 \cdot 730 \cdot 2} = 0,055$$

-mehanički koeficijent armiranja (DCM):

$$\omega_v = \frac{\rho_v \cdot f_{yd,v}}{f_{cd}} = \frac{0,0026 \cdot 43,48}{2} = 0,057$$

$$\omega_{wd} = \frac{\text{obujam ovijenih vilica} \cdot f_{yd}}{\text{volumen betonske jezgre} \cdot f_{cd}}$$

$$\omega_{wd} = \frac{0,28 \cdot \frac{1025}{6} \cdot (2 \cdot 30 + 2 \cdot 13,5)}{30 \cdot 1025 \cdot 20} \cdot \frac{43,48}{2,0} = 0,13$$

$$\mu_\phi = -1,18$$

$$\nu_d = 0,055$$

$$b_c = 20\text{cm}$$

$$b_0 = 13,5\text{cm}$$

$$h_0 = 30\text{cm}$$

$$\varepsilon_{sy,d} = \frac{f_{yd}}{E_s} = \frac{434,8}{200000} = 0,00217$$

$$\alpha = \alpha_n \cdot \alpha_s$$

$$\alpha_n = 1 - \frac{\sum b_i^2}{(6 \cdot b_0 \cdot h_0)} = 1 - \frac{2 \cdot 13,5^2 + 2 \cdot 30^2}{(6 \cdot 30 \cdot 13,5)} = 0,109$$

$$\alpha_s = \left(1 - \frac{s}{2 \cdot b_0}\right) \cdot \left(1 - \frac{s}{2 \cdot h_0}\right) = \left(1 - \frac{6}{2 \cdot 13,5}\right) \cdot \left(1 - \frac{6}{2 \cdot 30}\right) = 0,7$$

$$\alpha = 0,109 \cdot 0,7 = 0,076$$

$$\alpha \cdot \omega_{wd} \geq -0,048$$

$$\alpha \cdot \omega_{wd} = 0,076 \cdot 0,13 = 0,0098 \geq -0,048 \text{ -odabrana armatura zadovoljava!}$$

Poprečni presjek zida u kritičnom području:

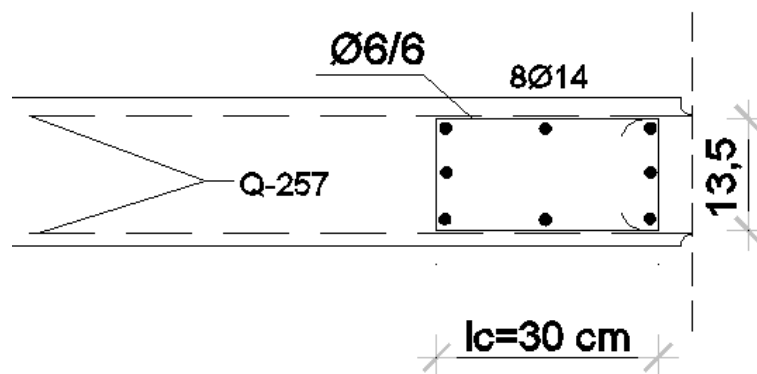

Slika 92: Armatura zida u kritičnom području

11.6 Zid u smjeru y

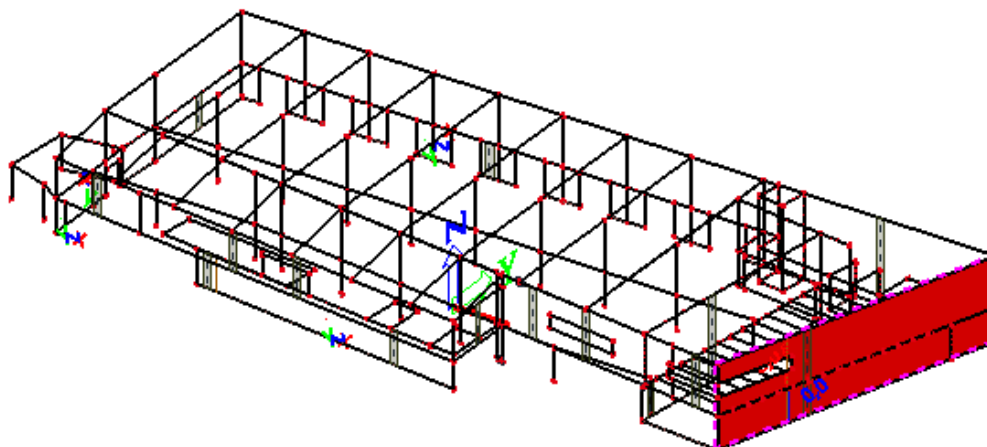

Slika 93: Prikaz položaja promatranog zida u smjeru y

$$H_w = 10,25\text{m}$$

$$b_w = 20\text{cm}$$

$$L_w = 37,38\text{m}$$

$l_w = 7,5\text{m}$ – Zid se proračunava sa duljinom radne reške koje su na krajevima armirane i povezane armaturom. Duljina radne reške je $l = 7,5\text{m}$. U modelu su sile integrirane u duljini 7,5 m, kritični „Integration strip“ (najveće rezne sile) je uzet kao mjerodavan za cijeli zid. Budući da je zid ovim proračunom odijeljen na sekcije od 7,5 m, predviđene su kanelure na kraju svake sekcije u dubini od 2 cm koje su ispunjene elastičnom smjesom.

Zid se sastoji iz tri djela, krajnji lijevi dio je pod drugim kutem s obzirom na dva desna dijela koja djeli otvor omeđen gredama s gornje i donje strane. Proračun se vrši za srednji dio jer on ima maksimalne rezne sile.

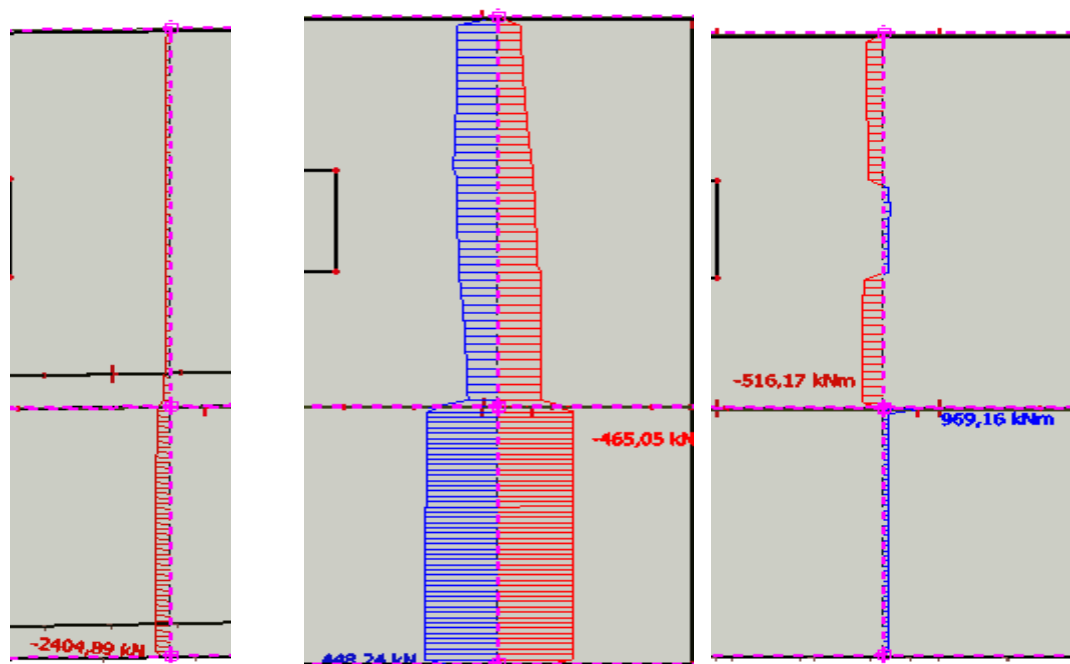
-Rezne sile

Slika 94: Prikaz max uzdužne sile, poprečne sile i momenata savijanja za kombinaciju Potres y

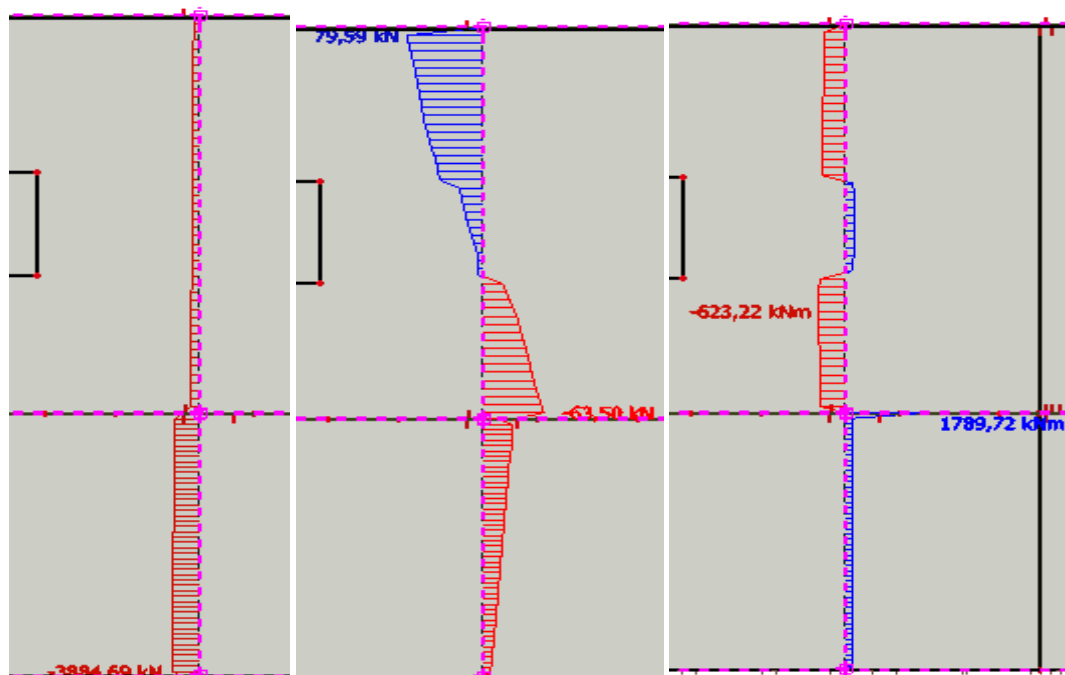

Slika 95: Prikaz max uzdužne sile, poprečne sile i momenata savijanja za kombinaciju GSN Snijeg

$$a_1 = d \cdot \cot \theta$$

Klasa duktilnosti: M

$$DCM -1 \leq \text{ctg} \theta \leq 2,5$$

$$d = 0,9 \cdot l_w = 0,9 \cdot 7,5 = 6,75$$

$$a_1 = d \cdot \cot \theta = 6,75 \cdot 1 = 6,75$$

Provjera efekata drugog reda nije izvršena. Predmetna građevina je vrlo kruta, pa su vrijednosti međukatnog pomaka male. Na temelju toga utjecaje pomaka na povećanje reznih sila možemo zanemariti.

11.6.1 Proračun zida u smjeru x – dimenzioniranje promatranog zida

- geometrijske karakteristike zida

Duljina: $l_w = 750$ m

Širina: $b = 20$ cm

-statička visina presjeka u x i y smjeru:

(debljina zaštitnog sloja iznosi 3 cm)

$$d_x = 13,5 \text{ cm}$$

$$d_y = 750 - (3 + 1 + 1 + 25) = 720 \text{ cm}$$

Dimenzioniranje na moment savijanja i uzdužnu silu

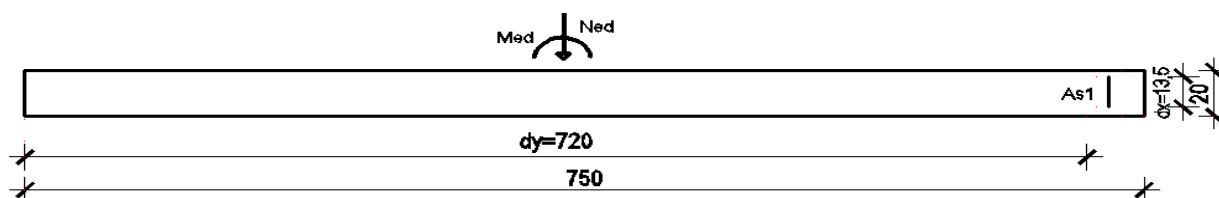

Slika 96: Skica poprečnog presjeka zida

Rezne sile:

$$M_{Ed} = 969,16 \text{ kNm}$$

$$N_{Ed} = 2404,89 \text{ kN}$$

$$M_{Ed,s} = M_{Ed} + N_{Ed} \cdot \left(d_y - \frac{h}{2} \right) = 969,16 + 2404,89 \cdot \left(7,2 - \frac{7,5}{2} \right) = 9266,03 \text{ kNm}$$

$$M_{Rd,lim} = \mu_{Rd,lim} \cdot b \cdot d^2 \cdot f_{cd} = 0,159 \cdot 20 \cdot 720^2 \cdot 2 = 3389244 \text{ kNcm} = 33892,4 \text{ kNm}$$

$$A_{s,pot} \approx \frac{M_{Ed,s}}{0,8 \cdot d \cdot f_{yd}} - \frac{N_{Ed,s}}{f_{yd}} = \frac{9266,03}{0,8 \cdot 730 \cdot 2} - \frac{2404,89}{43,48} = -47,37 \text{ cm}^2$$

Minimalna i maksimalna površina armature rubnih elemenata zida:

$$A_{s,min} \approx \frac{0,1}{100} \cdot 750 \cdot 20 = 15 \text{ cm}^2$$

$$A_{s,max} \approx \frac{4}{100} \cdot 750 \cdot 20 = 600 \text{ cm}^2$$

Dimenzioniranje na poprečnu silu

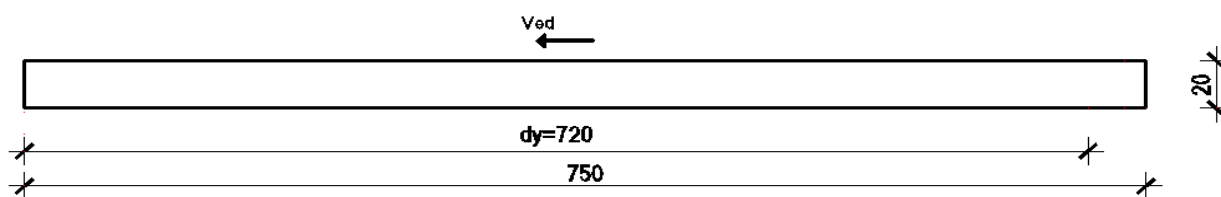

Slika 97: Skica poprečnog presjeka zida

Maksimalna poprečna sila u podnožju zida: $V_{Ed}=448,24 \text{ kN}$

$$A_{s,min} = 0,2\% \cdot 20 \cdot 100 = \frac{0,2}{100} \cdot 20 \cdot 100 = 4 \text{ cm}^2 / \text{m}$$

Odabrano: Q – 226 ($A_s = 2,26 \text{ cm}^2$) obe strane zida – $A_{s1} = 4,52 \text{ cm}^2$

Nosivost zidova na poprečne sile (s minimalnom armaturom):

- Slom tlačne dijagonale (tlačni slom hrpta zida zbog posmika)

Izvan kritičnog područja (prema EC2):

$$V_{sd} \leq V_{Rd,max} = \frac{\alpha_{cw} \cdot b_{w0} \cdot v_1 \cdot z \cdot f_{cd}}{\text{ctg}\theta + \text{tg}\theta}$$

$$\alpha_{cw} = 1, \text{ctg}\theta = 1, \text{tg}\theta = 1$$

$$v_1 = 0,6 \cdot \left(1 - \frac{f_{ck}}{250}\right) = 0,6 \cdot \left(1 - \frac{30}{250}\right) = 0,53$$

$$V_{Rd,max} = \frac{1 \cdot 20 \cdot 0,53 \cdot 0,8 \cdot 720 \cdot 2}{1 + 1} = 6190,4 \text{ kN} > V_{Ed} = 448,24 \text{ kN}$$

U kritičnom području:

$$V_{Ed} \leq 0,4 \cdot V_{Rd,max}$$

$$448,24kN \leq 0,4 \cdot 6190,4 = 2476,16kN$$

Slom vlačne dijagonale (vlačni slom hrpta zbog posmika)

Napomena: U nastavku je prikazan dokaz nosivosti armaturne mreže

Postupak ovisi o koeficijentu α_s

$$\alpha_s = \frac{M_{Ed}}{V_{Sd} \cdot l_w} = \frac{969,16}{448,24 \cdot 7,5} = 0,3$$

$$\text{Ako je: } \alpha_s = \frac{M_{Ed}}{V_{Sd} \cdot l_w} < 2$$

Horizontalne šipke u hrptu trebaju zadovoljiti:

$$V_{Rd,s} = V_{Rd,c} + 0,75 \cdot \rho_H \cdot f_{yd,h} \cdot b_{w0} \cdot \alpha_s \cdot l_w$$

$$\rho_h - \text{omjer armiranja hrpta horizontalnim šipkama} \left(\rho_h = \frac{A_{s,h}}{A_c} \right)$$

$f_{yd,h}$ – proračunska vrijednost granice popuštanja horizontalne armature hrpta

$V_{Rd,c}$ - proračunska vrijednost posmične otpornosti elementa bez posmične armature u skladu s normom EN 1992-1-1:2004.

Mreža Q-226 ($A_s=2,26 \text{ cm}^2/\text{m}$) – obostrano

$$\rho_h = \rho_v = \frac{A_{s,h}}{A_c} = \frac{2 \cdot 2,26}{20 \cdot 100} = 0,0022$$

$$f_{yd,h} = \frac{f_{y,k}}{\gamma_s} = \frac{500}{1,15} = 434,8MPa$$

$$b_w = 20cm$$

$$\alpha_s = 0,3m$$

$$l_w = 750cm$$

$$V_{Rd,c} = \left[C_{Rdc} \cdot k \cdot (100 \cdot \rho_1 \cdot f_{ck})^{\frac{1}{3}} + k_1 \cdot \sigma_{cp} \right] \cdot b_w \cdot d$$

$$C_{Rdc} = \frac{0,18}{\gamma_c} = \frac{0,18}{1,5} = 0,12$$

$$k = 1,0 + \sqrt{\frac{200}{d}} = 1,0 + \sqrt{\frac{200}{7200}} = 1,17 < 2$$

$$\rho_1 = \rho_H = 0,0022$$

$$f_{ck} = 30 \text{ MPa}$$

$$k_1 = 0,15$$

$$\sigma_{cp} = \frac{N_{Ed}}{A_c} \leq 0,2 \cdot f_{cd}$$

$$\sigma_{cp} = \frac{2404,89 \cdot 1000}{200 \cdot 7500} = 1,6 \leq 0,2 \cdot f_{cd} = 4 \text{ MPa}$$

$$V_{Rd,c} = \left[0,12 \cdot 1,17 \cdot (100 \cdot 0,0022 \cdot 30)^{\frac{1}{3}} + 0,15 \cdot 1,6 \right] \cdot 200 \cdot 7200 = 724837,18 \text{ N} = 724,83 \text{ kN}$$

$$V_{Rd,s} = V_{Rd,c} + 0,75 \cdot \rho_H \cdot f_{yd,h} \cdot b_{w0} \cdot \alpha_s \cdot l_w$$

$$V_{Rd,s} = 724,83 + 0,75 \cdot 0,0022 \cdot 43,48 \cdot 20 \cdot 0,03 \cdot 750 = 757,11 \text{ kN} > 448,24 \text{ kN}$$

Vertikalne šipke u hrptu, usidrene i preklapljene po visini zida u skladu s normom EN 1992 – 1-1:2004 trebaju zadovoljiti:

$$\rho_h \cdot f_{yd,h} \cdot b_{w0} \cdot z \leq \rho_v \cdot f_{yd,v} \cdot b_{w0} \cdot z + \min N_{Ed}$$

$$\rho_v - \text{omjer armiranja vertikalnih šipki u hrptu} \left(\rho_v = \frac{A_{s,v}}{A_c} \right)$$

$f_{d,v}$ – proračunska vrijednost granice popuštanja vertikalne armature hrpta

Mreža Q-226 ($A_s=2,26 \text{ cm}^2/\text{m}$) – obostrano

$$\rho_h = \rho_v = \frac{A_{s,h}}{A_c} = \frac{2 \cdot 2,26}{20 \cdot 100} = 0,0022$$

$$\rho_v \cdot f_{yd,v} \cdot b_{w0} \cdot z + \min N_{Ed} = 0,0022 \cdot 43,48 \cdot 20 \cdot 0,8 \cdot 720 + 2404,89 = 3522,16 \text{ kN}$$

$$\rho_h \cdot f_{yd,h} \cdot b_{w0} \cdot z = 0,0022 \cdot 43,48 \cdot 20 \cdot 0,8 \cdot 720 = 1117,26 \text{ kN}$$

$$1117,26 \text{ kN} < 3522,16 \text{ kN}$$

Posmični slom klizanjem.

Za klasu DCM nije potrebna provjera na posmični slom klizanjem.

Detaljiranje lokalne duktilnosti zida

Visina kritičnog područja

$$h_{cr} = h_s = 4,10\text{m}$$

$$h_{cr} = 410\text{cm}$$

Ovijena armatura (vilice):

DCM

$$\phi_{\min} \geq 6\text{mm}$$

Odabrano: 6 mm

-vertikalni razmak vilica:

$$s_w \leq \left\{ 8 \cdot d_{bL}; \frac{b_0}{2}; 175\text{mm} \right\}$$

$$s_w \leq \left\{ 8 \cdot 15; \frac{135}{2}; 175\text{mm} \right\}$$

$$s_w \leq \{120; 67,5; 175\text{mm}\}$$

Odabrane vilice: $\Phi 6\text{mm}/6\text{ cm}$, $m=2$

-duljina rubnog serklaža:

$$a) l_c = \min \{0,15l_w; 1,5b_w\} = \min \{112,5; 30\} = 30\text{cm}$$

b) Duljina rubnog elementa zida (l_c) mora biti veća od duljine na kojoj je $\varepsilon_c=3,5\%$

$$l_c = x_u \cdot \left(1 - \frac{\varepsilon_{cu2}}{\varepsilon_{cu2,c}} \right)$$

$$x_u = (v_d + \omega_v) \cdot \frac{l_w \cdot b_c}{b_0}$$

$$v_d = \frac{N_{Ed}}{A_c \cdot f_{cd}} = \frac{2404,89}{20 \cdot 750 \cdot 2} = 0,08$$

$$\omega_v = \frac{\rho_v \cdot f_{yd,v}}{f_{cd}} = \frac{0,0022 \cdot 43,48}{2} = 0,048$$

$$x_u = (v_d + \omega_v) \cdot \frac{l_w \cdot b_c}{b_0} = (0,08 + 0,048) \cdot \frac{750 \cdot 20}{13,5} = 142,22\text{cm}$$

$$\varepsilon_{cu2} = 0,0035$$

$$\varepsilon_{cu2,c} = 0,0035 + 0,1 \cdot \alpha \cdot \omega_{wd}$$

$$\alpha \cdot \omega_{wd} \geq 30 \cdot \mu_{\phi} \cdot (v_d + \omega_v) \cdot \varepsilon_{sy,d} \cdot \frac{b_c}{b_0} - 0,035$$

$$T_1 = 1,0 \text{ (s)}$$

$$T_c = 0,5 \text{ (s)} \quad \rightarrow \quad T_1 > T_c \rightarrow \mu_{\phi} = 2 \cdot (q_0 - 1)$$

$$\mu_{\phi} = 2 \cdot (q_0 - 1)$$

$$q_0 = q \cdot \frac{M_{Ed}}{M_{Rd}}$$

$$M_{Rd,lim} = \begin{cases} M_{Rd,lim,c} = \mu_{Rd,lim} \cdot b \cdot d^2 \cdot f_{cd} = 0,159 \cdot 20 \cdot 720^2 \cdot 2 = 3297024 \text{ (kNcm)} = 32970,24 \text{ (kNm)} \\ M_{Rd,lim,s} = A_{s1} \cdot f_{yd} \cdot 0,8 \cdot d = 12,32 \cdot 43,48 \cdot 0,8 \cdot 720 = 308547,99 \text{ (kNcm)} = 3085,5 \text{ (kNm)} \end{cases}$$

$$q_0 = 3 \cdot \frac{969,16}{3085,5} = 0,94$$

$$\mu_{\phi} = 2 \cdot (q_0 - 1) = 2 \cdot (0,94 - 1) = -0,12$$

$$\varepsilon_{sy,d} = \frac{f_{yd}}{E_s} = \frac{434,8}{200000} = 0,00217$$

$$\alpha \cdot \omega_{wd} \geq 30 \cdot (-0,12) \cdot (0,08 + 0,048) \cdot 0,00217 \cdot \frac{20}{13,5} - 0,035$$

$$\alpha \cdot \omega_{wd} \geq -0,036$$

Negativna vrijednost u prethodnom izrazu ukazuje da je daljnji proračun pod točkom b) nepotreban. Usvaja se minimalna duljina rubnog elementa koja iznosi 30 cm.

Kontrola tlačnih naprezanja:

-bezdimenzionalna vrijednost uzdužne sile (DCM):

$$v_d = \frac{N_{Ed}}{A_c \cdot f_{cd}} < 0,4$$

$$v_d = \frac{N_{Ed}}{A_c \cdot f_{cd}} = \frac{2404,89}{20 \cdot 750 \cdot 2} = 0,08$$

-mehanički koeficijent armiranja (DCM):

$$\omega_v = \frac{\rho_v \cdot f_{yd,v}}{f_{cd}} = \frac{0,0022 \cdot 43,48}{2} = 0,048$$

$$\omega_{wd} = \frac{\text{obujam ovijenih vilica}}{\text{volumen betonske jezgre}} \cdot \frac{f_{yd}}{f_{cd}}$$

$$\omega_{wd} = \frac{0,28 \cdot \frac{1025}{6} \cdot (2 \cdot 30 + 2 \cdot 13,5)}{30 \cdot 1025 \cdot 20} \cdot \frac{43,48}{2,0} = 0,13$$

$$\mu_{\phi} = -0,12$$

$$\nu_d = 0,08$$

$$b_c = 20\text{cm}$$

$$b_0 = 13,5\text{cm}$$

$$h_0 = 30\text{cm}$$

$$\varepsilon_{sy,d} = \frac{f_{yd}}{E_s} = \frac{434,8}{200000} = 0,00217$$

$$\alpha = \alpha_n \cdot \alpha_s$$

$$\alpha_n = 1 - \frac{\sum b_i^2}{(6 \cdot b_0 \cdot h_0)} = 1 - \frac{2 \cdot 13,5^2 + 2 \cdot 30^2}{(6 \cdot 30 \cdot 13,5)} = 0,109$$

$$\alpha_s = \left(1 - \frac{s}{2 \cdot b_0}\right) \cdot \left(1 - \frac{s}{2 \cdot h_0}\right) = \left(1 - \frac{6}{2 \cdot 13,5}\right) \cdot \left(1 - \frac{6}{2 \cdot 30}\right) = 0,7$$

$$\alpha = 0,109 \cdot 0,7 = 0,076$$

$$\alpha \cdot \omega_{wd} \geq -0,036$$

$$\alpha \cdot \omega_{wd} = 0,076 \cdot 0,13 = 0,0098 \geq -0,036 - \text{odabrana armatura zadovoljava!}$$

Poprečni presjek zida u kritičnom području:

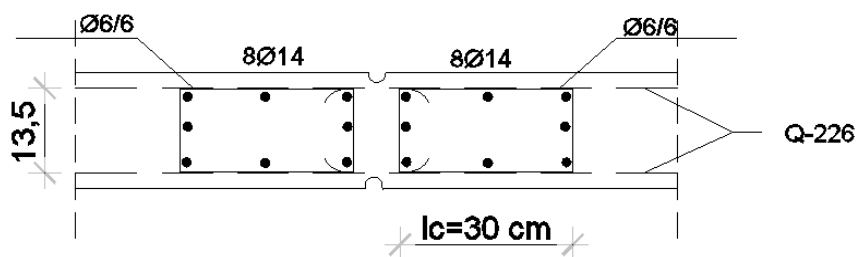

Slika 98: Armatura zida u kritičnom području - spoj dva segmenta

Raspored armature po etažama			
	armatura rubnog elementa zida		armatura hrpta zida
	šipke	vilice	mreža
Podrum	6Ø14	Ø6/8	Q-275
Prizemlje	6Ø14	Ø6/6	Q-226

12. PRORAČUN STUPOVA

Stupovi objekta su armirano-betonski elementi kvadratnih poprečnih presjeka, nalaze se unutar objekta dok su po rubovima postavljeni zidovi. Neki stupovi su predviđeni kao monolitni elementi a dio kao montažni elementi ovisno o položaju i konstruktivnim elementima koji se oslanjaju na njih. Stupovi koji nose međуетažne nosače i šuplje ploče imaju kratke konzole (proračun u poglavlju „Međуетažni nosači“).

Proračunom je obuhvaćeno prvih 100 vlastitih oblika. Prema EC-8 zadovoljen je uvjet da suma svih upotrebljenih vlastitih oblika u proračunu mora aktivirati najmanje 90% ukupne mase.

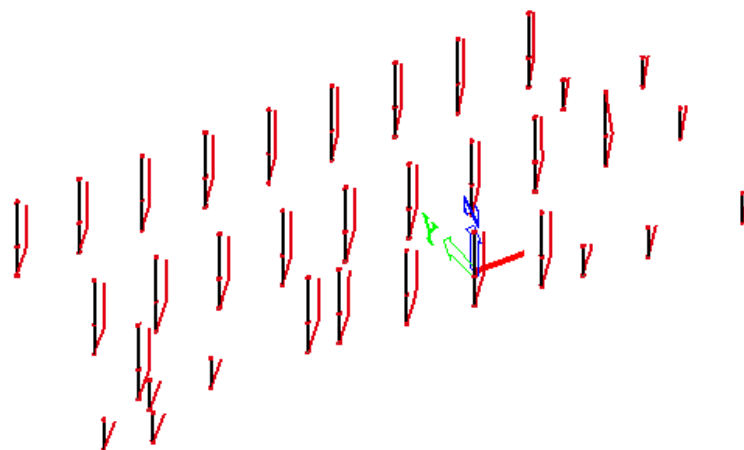

Slika 99: Prvi vlastiti vektor

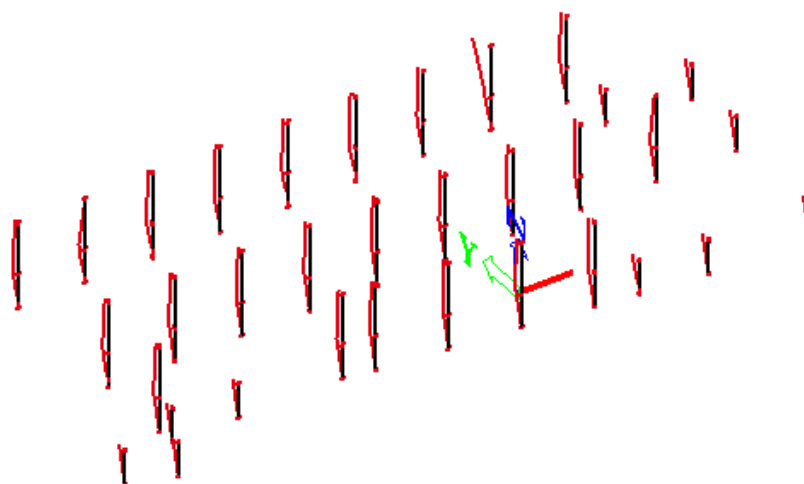

Slika 100: Drugi vlastiti vektor

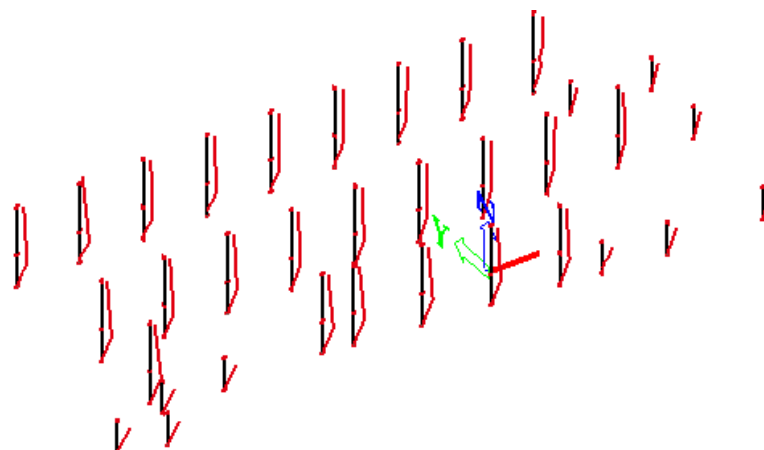

Slika 101: Treći vlastiti vektor

Rezne sile u svim stupovima:

-Stupovi koji prelaze visinu $h=4,2$ m

STUPOVI U OSI 5 (S1 i S2)								
	Osnovna kombinacija				Potresna kombinacija			
	My,max	N,prip	My,prip	N,max	My,max	N,prip	My,prip	N,max
	kNm	kN	kNm	kN	kNm	kN	kNm	kN
GR	164,35	-537,64	164,35	-537,64	64,01	-123,69	64,01	-123,69
PR	250,82	-305,15	177,77	-559,38	150,95	-178,19	84,49	-319,9

STUPOVI U OSI 4 (S5 i S6)								
	Osnovna kombinacija				Potresna kombinacija			
	My,max	N,prip	My,prip	N,max	My,max	N,prip	My,pri	N,max
	kNm	kN	kNm	kN	kNm	kN	kNm	kN
GR	453,22	-2574,9	77,48	-2768,64	215,59	-1313,26	13,24	-1407,41
PR	273,11	-193,84	11,18	-1417,33	26,99	-828,71	26,99	-828,71

STUPOVI U OSI 3 (S10 i S8)								
	Osnovna kombinacija				Potresna kombinacija			
	My,max	N,prip	My,prip	N,max	My,max	N,prip	My,pri	N,max
	kNm	kN	kNm	kN	kNm	kN	kNm	kN
GR	464,91	-2183,8	219,78	-2412,3	86,41	-988,93	85,72	-1274,2
PR	290,74	-537,56	37,17	-1318,13	222,0	-1154,5	18,36	-792,8

STUP U OSI 4 (S4)								
	Osnovna kombinacija				Potresna kombinacija			
	My,max	N,prip	My,prip	N,max	My,max	N,prip	My,pri	N,max
	kNm	kN	kNm	kN	kNm	kN	kNm	kN
GR	296,38	-3198,2	126,45	-3219,94	126,49	1658,61	126,49	1658,61
PR	218,29	-472,3	218,29	-472,3	108,3	302,85	108,3	302,85

-Stupovi visine do $h= 4,2$ m

STUPOVI (S3, S7, S9, S11 i S12)								
	Osnovna kombinacija				Potresna kombinacija			
	My,max	N,prp	My,prp	N,max	My,max	N,prp	My,prp	N,max
	kNm	kN	kNm	kN	kNm	kN	kNm	kN
GR	631,36	-2374,4	631,36	-2374,41	603,14	-1225,8	299,04	-1241,9

GR-na visini garaže

PR-prizemlje

Za proračun vitkosti korišten je pojednostavljeni postupak pronalaženja duljine izvijanja stupa pomoću Jacksonova i Morelandova nomograma.

Proračun je proveden zasebno za stupove u prizemlju i stupove u garaži, zbog toga što imaju različite visine i različite uvjete pridržanja na krajevima elementa. Sukladno navedenom, gornji dio konstrukcije je klasificiran kao horizontalno pomični, što znači da je za isti potrebno koristiti nomogram za horizontalno pomične okvire. Gornji dio konstrukcije, za razliku od donjeg dijela ima i veće duljine izvijanja, a samim time veće vrijednosti vitkosti stupa koje za sve gornje stupove prelaze granične vrijednosti vitkosti pa je nužno provesti proračun po teoriji II.reda, što rezultira većim momentima savijanja od momenata savijanja po teoriji I.reda. Posljedica navedenog je veća količina savojne armature u vitkim stupovima. Unatoč navedenom, kako razlika savojne armature nije velika, radi malog broja stupova izvan dvoetažnog dijela konstrukcije, te pojednostavljenije izvođenja konstrukcije usvojena je ista armatura za sve stupove istih dimenzija. Radi navedenog, prikazan je proračun vitkosti samo za stupove u prizemlju.

$$l_0 = l_{col} \cdot \beta \rightarrow \text{duljina izvijanja stupa}$$

$$l_{col} = 620\text{cm} \rightarrow \text{duljina stupa između čvorova za stupove u prizemlju}$$

$$l_{col} = 410\text{ cm}$$

\rightarrow duljina stupa između čvorova za stupove u garaži

β - koeficijent koji se očitava iz nomograma pomoću koeficijenata k_A i k_B koji opisuju

stupanj upetosti na krajevima štapa

$$k_A = k_B = 0 \rightarrow \text{za upete čvorove}$$

$k_A = \infty \rightarrow$ za slobodni vrh (vrh konzole)

$$k_A = \frac{\sum E_{cm} \cdot I_{col}}{\sum E_{cm} \cdot \alpha \cdot I_b} \rightarrow \text{za sve ostale slućajeve}$$

$$E_{cm} = 32800 \text{ MPa} \rightarrow \text{beton C30/37}$$

$I_{col} \rightarrow$ moment tromosti poprećnog presjeka stupa

(krutost stupova se izraćunava za betonski presjek bez uzimanja u obzir armature i pukotina u vlačnoj zoni)

$$l_{b,x} = 800 \text{ cm} \rightarrow \text{duljina rešetke u smjeru x}$$

$$l_{b,y} = 1600 \text{ cm} \rightarrow \text{duljina rešetke u smjeru y}$$

$$I_{rešetke} = I_{ekv,prof} = 273420 \text{ cm}^2$$

$\alpha \rightarrow$ koeficijent oslanjanja suprotnog kraja grede

$\alpha = 1,0 \rightarrow$ suprotni kraj je elastićno ili kruto upet

$\alpha = 0,5 \rightarrow$ suprotni kraj je zglobno oslonjen

$\alpha = 0,0 \rightarrow$ suprotni kraj je prepušten

$$\lambda = \frac{l_0}{i_{min}} \rightarrow \text{minimalni moment inercije pp-a stupa}$$

$A_{col} \rightarrow$ minimalni moment inercije poprećnog presjeka stup

$$\text{Granićna vitkost stupa} \rightarrow \lambda_{min} = \frac{20 \cdot A \cdot B \cdot C}{\sqrt{n}}$$

$$A = 0,7; B = 1,1; C = 0,7$$

$$n = \frac{N_{Ed,max}}{A_{col} \cdot f_{cd}}$$

Uvjeti:

$\lambda > \lambda_{lim} \rightarrow$ potreban je proraćun po teoriji II.reda

$\lambda < \lambda_{lim} \rightarrow$ nije potreban je proraćun po teoriji II.reda

12.1 Proračun stupova – kvadratni stupovi

$$I_{cool} = I_z = I_y = \frac{b \cdot h^3}{12} = \frac{40 \cdot 40^3}{12} = 213333,3 \text{ cm}^4$$

$$A_{cool} = b \cdot h = 40^2 = 1600 \text{ cm}^2$$

-mjerodavan je stup sa maksimalnom uzdužnom silom iz osnovne kombinacije

$$N_{max} = -479,32 \text{ kN}$$

$k_b=0 \rightarrow$ upeti čvor na spoju stup-greda-ploča

$$k_A = \frac{\frac{\sum E_{cm} \cdot I_{col}}{l_{col}}}{\frac{\sum E_{cm} \cdot \alpha \cdot I_b}{l_b}} = \frac{\frac{213333,3}{620}}{\frac{1 \cdot 273420}{800}} = 1,006$$

-očitano iz nomograma $\beta = 1,13$

$$i_{min} = \sqrt{\frac{I_{col,min}}{A_{col}}} = \sqrt{\frac{213333,3}{1600}} = 11,55$$

$$\lambda = \frac{l_0}{i_{min}} = \frac{620}{11,55} = 53,67$$

$$\lambda_{min} = \frac{20 \cdot A \cdot B \cdot C}{\sqrt{n}} = \frac{20 \cdot 0,7 \cdot 1,1 \cdot 0,7}{\sqrt{0,15}} = 27,83$$

$$A=0,7; B=1,1; C=0,7$$

$$n = \frac{N_{Ed,max}}{A_{col} \cdot f_{cd}} = \frac{479,32}{1600 \cdot 2} = 0,15$$

$$\lambda_{min} = 27,83 < \lambda = 53,67 \text{ -potreban je proračun po teoriji II reda}$$

Proračun graničnog stanja nosivosti na moment savijanja proveden je pomoću računalnog programa „Aspalathos Section Design“. Za stupove kojima vitkost prelazi graničnu vrijednost vitkosti mora se uzeti u obzir utjecaj deformiranja na povećanje momenata savijanja. To se postiže množenjem vrijednosti početne vrijednosti momenta savijanja s koeficijentom ψ . Navedeni postupak je dio ACI propisa.

Postupak povećanja početnog momenta savijanja

-povećani moment savijanja $M_{Ed}^{II} = \psi \cdot M_{Ed}^I$

-koeficijent uvećanja $\psi = \frac{C_m}{1 - \frac{\gamma \cdot N}{N_e}}$ - usvojeno $C_m=1,0$

-Eulerova kritična sila:

$$N_e = \pi^2 \cdot \frac{E_\varphi \cdot I}{l_i^2} = \pi^2 \cdot \frac{9647,05 \cdot 100 \cdot 213333,3}{620^2} = 5284081,98N = 5284,08kN$$

- $l_i \rightarrow$ duljina izvijanja stupa (izračunato kod proračuna vitkosti stupova)

- $I^{II} \rightarrow$ moment tromosti poprečnog presjeka stupa

$$E_\varphi = \frac{E}{1 + \varphi} = \frac{32800}{1 + 2,4} = 9647,05MPa$$

φ -koeficijent puzanja betona (pretpostavljeno 2,4)

$$\psi = \frac{C_m}{1 - \frac{\gamma \cdot N}{N_e}} = \frac{1,0}{1 - \frac{1,5 \cdot 479,32}{5284,08}} = 1,16$$

12.2 Stupovi S1 i S2

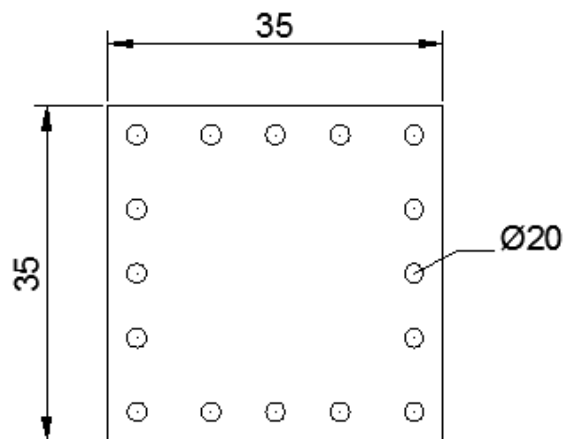

Slika 198: Skica armature u stupu SP 1

STUPOVI U OSI 1								
	Osnovna kombinacija				Potresna kombinacija			
	My,max	N,prip	My,prip	N,max	My,max	N,prip	My,prip	N,max
	kNm	kN	kNm	kN	kNm	kN	kNm	kN
GR	164,35	-537,64	164,35	-537,64	64,01	-123,69	64,01	-123,69
PR	250,82	-305,15	177,77	-559,38	150,95	-178,19	84,49	-319,9

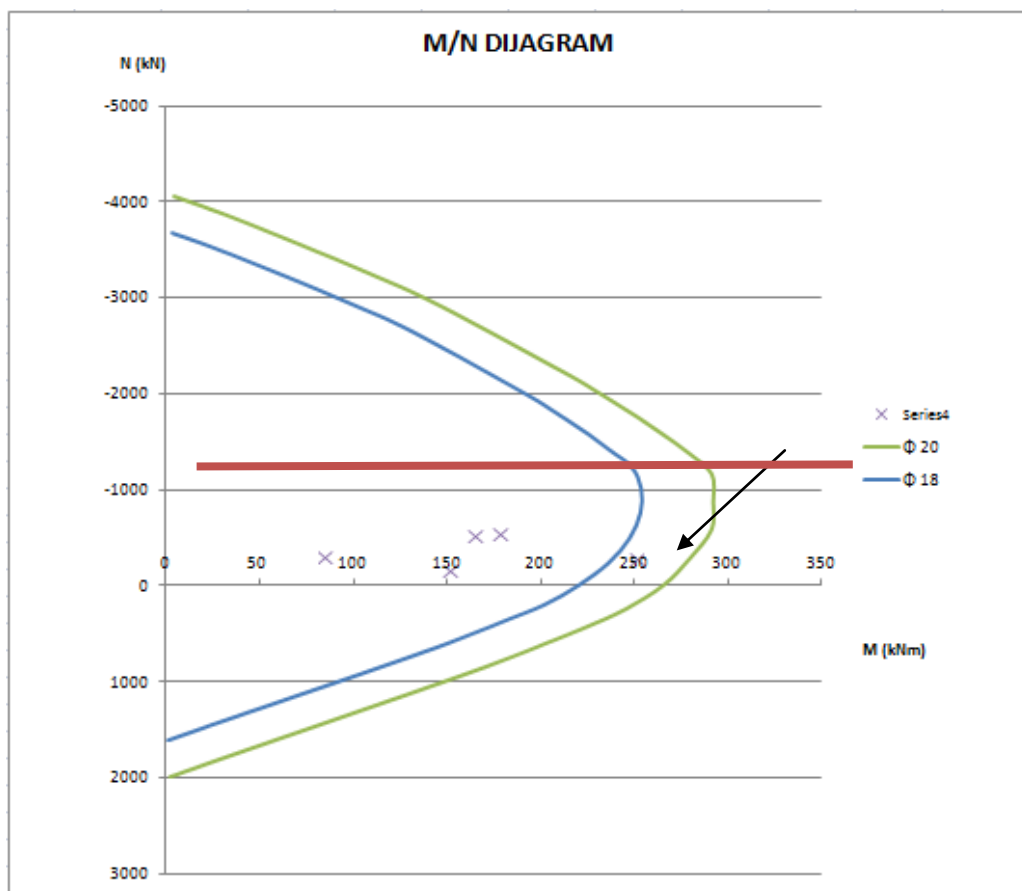

Slika 199: Dijagram stupa SP 1

12.2.1 Proračun na poprečnu silu

$$V_{Ed} = 77,64 \text{ kN}$$

$$A_s = 16 \cdot \emptyset 20 = 50,24 \text{ cm}^2$$

Dio poprečne sile koju preuzima beton i uzdužna armatura:

$$V_{Rd,C} = \left[C_{Rd,C} \cdot k \cdot (100 \cdot \rho_l \cdot f_{ck})^{1/3} + k_1 \cdot \sigma_{cp} \right] \cdot b_w \cdot d$$

$$k = 1,0 + \sqrt{\frac{200}{d}} = 1,0 + \sqrt{\frac{200}{300}} = 1,82 \leq 2,0$$

$$k_1 = 0,15$$

$$\sigma_{cp} = N_{sd} / A_c = 183,75 / 35^2 = 0,15$$

$$C_{Rd,C} = 0,18 / \gamma_c = 0,18 / 1,5 = 0,12$$

$$\sum A_s \approx 50,24 \text{ cm}^2 \quad \rho_l = \frac{\sum A_s}{A_c} = \frac{50,24}{35 \cdot 35} = 0,041$$

$$V_{Rd,C} = \left[0,12 \cdot 1,82 \cdot (100 \cdot 0,041 \cdot 30)^{1/3} + 0,15 \cdot 0,15 \right] \cdot 300 \cdot 350 = 116407,7 \text{ N} = 116,4 \text{ kN}$$

$$V_{Rd,max} = 0,5 \cdot v \cdot b_w \cdot d \cdot f_{cd} = 0,5 \cdot 0,528 \cdot 350 \cdot 300 \cdot 20 = 554400 \text{ N} = 554,4 \text{ kN} > V_{Ed}$$

$$v = 0,6 \left[1 - \frac{f_{ck}}{250} \right] = 0,6 \left[1 - \frac{30}{250} \right] = 0,528$$

Potrebna računaska poprečna armatura

$$V_{Ed} / V_{Rd,max} = 77,64 / 554,4 \approx 0,14 \Rightarrow V_{Ed} = 0,14 V_{Rd,2}$$

$$s_{w,max} = \min \{ 0,8 \cdot d; 30,0 \text{ cm} \} = \min \{ 0,8 \cdot 30 = 24; 30,0 \} \Rightarrow s_{w,max} = 24,0 \text{ cm}$$

$$\rho_{min} = 0,0011 \quad (C 30 / 37)$$

$$A_{sw,min} = \frac{\rho_{min} \cdot s_w \cdot b_w}{m} = \frac{0,0011 \cdot 24 \cdot 35}{2} = 0,46 \text{ cm}^2$$

Odabrane spone $\emptyset 10$ ($A_{sw} = 0,79 \text{ cm}^2$):

$$s_{w,pot} \leq \frac{m \cdot A_{sw,min}}{\rho_{min} \cdot b_w} = \frac{2 \cdot 0,79}{0,0011 \cdot 35} = 41,04 \text{ cm}$$

Odabrane spone $\emptyset 10/20$, $m=2$

Ukupna nosivost betona i odabrane poprečne armature:

$$V_{Rd} = V_{Rd,s} = \frac{A_{sw}}{S} \cdot z \cdot f_{ywd} \cdot m \cdot ctg \Theta = \frac{0,79}{20} \cdot (0,9 \cdot 30) \cdot 43,48 \cdot 2 \cdot 1 = 92,74 \text{ kN}$$

$$V_{Ed} < V_{Rd}$$

12.3 Stupovi S5 i S6

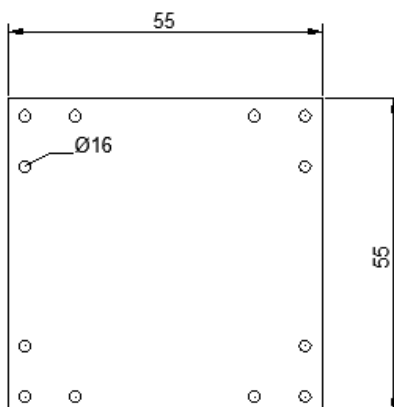

Slika 200: Skica armature u stupu SP2

STUPOVI U OSI 2								
	Osnovna kombinacija				Potresna kombinacija			
	My,max	N,prip	My,prip	N,max	My,max	N,prip	My,pri	N,max
	kNm	kN	kNm	kN	kNm	kN	kNm	kN
GR	453,22	-2574,9	77,48	-2768,64	215,59	-1313,26	13,24	-1407,41
PR	273,11	-193,84	11,18	-1417,33	26,99	-828,71	26,99	-828,71

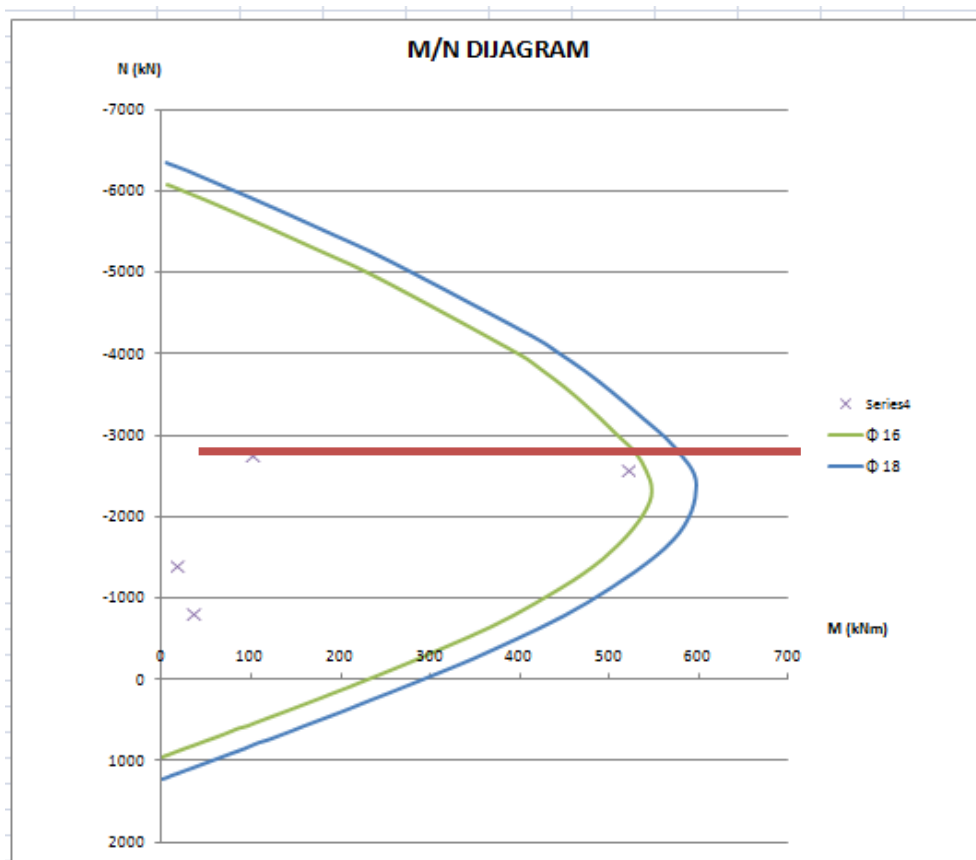

Slika 201: Dijagram stupa SP2

Napomena: Veličina betonskog presjeka uvjetovana je maksimalnom tlačnom silom koje je za manje dimenzije prelaila nosivost betona

12.3.1 Proračun na poprečnu silu

$$V_{Ed} = 168,29 \text{ kN}$$

$$A_s = 12 \cdot \emptyset 16 = 24,13 \text{ cm}^2$$

Dio poprečne sile koju preuzima beton i uzdužna armatura:

$$V_{Rd,C} = \left[C_{Rd,C} \cdot k \cdot (100 \cdot \rho_l \cdot f_{ck})^{1/3} + k_1 \cdot \sigma_{cp} \right] \cdot b_w \cdot d$$

$$k = 1,0 + \sqrt{\frac{200}{d}} = 1,0 + \sqrt{\frac{200}{500}} = 1,63 \leq 2,0$$

$$k_1 = 0,15$$

$$\sigma_{cp} = N_{sd} / A_c = 2574,94 / 55^2 = 0,85$$

$$C_{Rd,C} = 0,18 / \gamma_c = 0,18 / 1,5 = 0,12$$

$$\sum A_s \approx 24,13 \text{ cm}^2 \quad \rho_l = \frac{\sum A_s}{A_c} = \frac{24,13}{55^2} = 0,008$$

$$V_{Rd,C} = \left[0,12 \cdot 1,63 \cdot (100 \cdot 0,008 \cdot 30)^{1/3} + 0,15 \cdot 0,85 \right] \cdot 500 \cdot 550 = 190219,7 \text{ N} = 190,2 \text{ kN}$$

$$V_{Rd,max} = 0,5 \cdot \nu \cdot b_w \cdot d \cdot f_{cd} = 0,5 \cdot 0,528 \cdot 550 \cdot 500 \cdot 20 = 1452000 \text{ N} = 1452 \text{ kN} > V_{Ed}$$

$$\nu = 0,6 \left[1 - \frac{f_{ck}}{250} \right] = 0,6 \left[1 - \frac{30}{250} \right] = 0,528$$

Potrebna računaska poprečna armatura

$$V_{Ed} / V_{Rd,max} = 168,29 / 1452 \approx 0,12 \Rightarrow V_{Ed} = 0,12 V_{Rd2}$$

$$s_{w,max} = \min \{ 0,8 \cdot d; 30,0 \text{ cm} \} = \min \{ 0,8 \cdot 50 = 40; 30,0 \} \Rightarrow s_{w,max} = 30,0 \text{ cm}$$

$$\rho_{min} = 0,0011 \quad (C 30 / 37)$$

$$A_{sw,min} = \frac{\rho_{min} \cdot s_w \cdot b_w}{m} = \frac{0,0011 \cdot 30 \cdot 55}{2} = 0,91 \text{ cm}^2$$

Odabrane spone $\emptyset 12$ ($A_{sw} = 1,13 \text{ cm}^2$):

$$s_{w,pot} \leq \frac{m \cdot A_{sw,min}}{\rho_{min} \cdot b_w} = \frac{2 \cdot 1,13}{0,0011 \cdot 55} = 37,36 \text{ cm}$$

Odabrane spone $\emptyset 12 / 30$, $m=2$

Ukupna nosivost betona i odabrane poprečne armature:

$$V_{Rd} = V_{Rd,s} = \frac{A_{sw}}{S} \cdot z \cdot f_{ywd} \cdot m \cdot ctg \Theta = \frac{1,13}{30} \cdot (0,9 \cdot 50) \cdot 43,48 \cdot 2 \cdot 1 = 147,39 \text{ kN} - V_{Ed} > V_{Rd}$$

Kontroliramo nosivost betona:

$$V_{Rd,max} = \frac{\alpha_{cw} \cdot b_w \cdot z \cdot V_1 \cdot f_{cd}}{\tan \Theta + ctg \Theta} = \frac{1,0 \cdot 550 \cdot 500 \cdot 0,6 \cdot 20}{1+1} = 1650 \text{ kN} > V_{Ed}$$

Na mjestu maksimalne poprečne sile:

$$S_{pot} \leq \frac{m \cdot A_{sw} \cdot f_{yw,d} \cdot z}{V_{Ed}} = \frac{2 \cdot 1,13 \cdot 43,5 \cdot 0,9 \cdot 50}{168,29} = 26,2 \text{ cm}$$

Ø12/26 ($A_{sw}=1,13 \text{ cm}^2$) – provučeno kroz cijeli stup

12.4 Stupovi S8 i S10

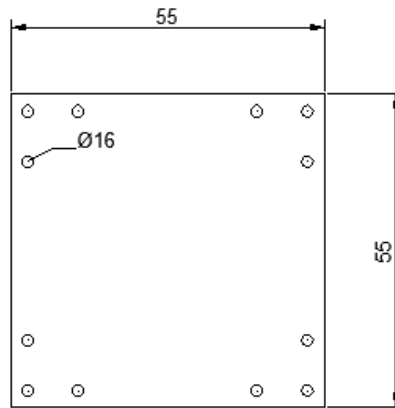

Slika 202: Skica armature u stupu SP3

STUPOVI U OSI 3								
	Osnovna kombinacija				Potresna kombinacija			
	My,max kNm	N,prip kN	My,prip kNm	N,max kN	My,max kNm	N,prip kN	My,pri kNm	N,max kN
GR	464,91	-2183,8	219,78	-2412,3	86,41	-988,93	85,72	-1274,2
PR	290,74	-537,56	37,17	-1318,13	222,0	-1154,5	18,36	-792,8

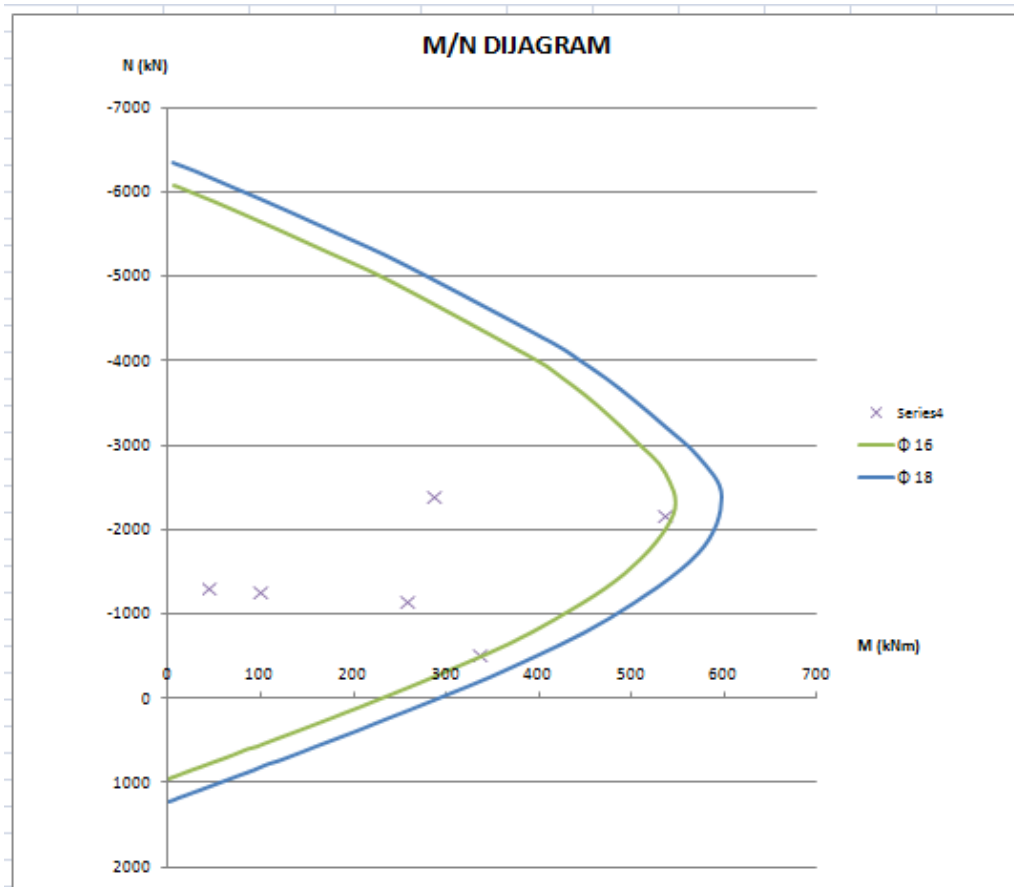

Slika 203: Dijagram stupa SP3

Napomena: Veličina betonskog presjeka uvjetovana je maksimalnom tlačnom silom.

12.4.1 Proračun na poprečnu silu

$$V_{Ed} = 171,76 \text{ kN}$$

$$A_s = 12 \cdot \emptyset 16 = 24,13 \text{ cm}^2$$

Dio poprečne sile koju preuzima beton i uzdužna armatura:

$$V_{Rd,C} = \left[C_{Rd,C} \cdot k \cdot (100 \cdot \rho_l \cdot f_{ck})^{1/3} + k_1 \cdot \sigma_{cp} \right] \cdot b_w \cdot d$$

$$k = 1,0 + \sqrt{\frac{200}{d}} = 1,0 + \sqrt{\frac{200}{500}} = 1,63 \leq 2,0$$

$$k_1 = 0,15$$

$$\sigma_{cp} = N_{sd} / A_c = 2205,59 / 55^2 = 0,73$$

$$C_{Rd,C} = 0,18 / \gamma_c = 0,18 / 1,5 = 0,12$$

$$\sum A_s \approx 24,13 \text{ cm}^2 \quad \rho_l = \frac{\sum A_s}{A_c} = \frac{24,13}{55^2} = 0,008$$

$$V_{Rd,C} = \left[0,12 \cdot 1,63 \cdot (100 \cdot 0,008 \cdot 30)^{1/3} + 0,15 \cdot 0,73 \right] \cdot 500 \cdot 550 = 185269,7 \text{ N} = 185,3 \text{ kN}$$

$$V_{Rd,max} = 0,5 \cdot \nu \cdot b_w \cdot d \cdot f_{cd} = 0,5 \cdot 0,528 \cdot 550 \cdot 500 \cdot 20 = 1452000 \text{ N} = 1452 \text{ kN} > V_{Ed}$$

$$\nu = 0,6 \left[1 - \frac{f_{ck}}{250} \right] = 0,6 \left[1 - \frac{30}{250} \right] = 0,528$$

Potrebna računaska poprečna armatura

$$V_{Ed} / V_{Rd,max} = 171,76 / 1452 \approx 0,11 \Rightarrow V_{Ed} = 0,11 V_{Rd,2}$$

$$s_{w,max} = \min \{ 0,8 \cdot d; 30,0 \text{ cm} \} = \min \{ 0,8 \cdot 50 = 40; 30,0 \} \Rightarrow s_{w,max} = 30,0 \text{ cm}$$

$$\rho_{min} = 0,0011 \quad (C 30 / 37)$$

$$A_{sw,min} = \frac{\rho_{min} \cdot s_w \cdot b_w}{m} = \frac{0,0011 \cdot 30 \cdot 55}{2} = 0,91 \text{ cm}^2$$

Odabrane spone $\emptyset 12$ ($A_{sw} = 1,13 \text{ cm}^2$):

$$s_{w,pot} \leq \frac{m \cdot A_{sw,min}}{\rho_{min} \cdot b_w} = \frac{2 \cdot 1,13}{0,0011 \cdot 55} = 37,36 \text{ cm}$$

Odabrane spone $\emptyset 12 / 30$, $m=2$

Ukupna nosivost betona i odabrane poprečne armature:

$$V_{Rd} = V_{Rd,s} = \frac{A_{sw}}{S} \cdot z \cdot f_{ywd} \cdot m \cdot ctg \Theta = \frac{1,13}{30} \cdot (0,9 \cdot 50) \cdot 43,48 \cdot 2 \cdot 1 = 147,39 \text{ kN} - V_{Ed} > V_{Rd}$$

Kontroliramo nosivost betona:

$$V_{Rd,max} = \frac{\alpha_{cw} \cdot b_w \cdot z \cdot v_1 \cdot f_{cd}}{\tan \Theta + ctg \Theta} = \frac{1,0 \cdot 550 \cdot 500 \cdot 0,6 \cdot 20}{1+1} = 1650 kN > V_{Ed}$$

Na mjestu maksimalne poprečne sile:

$$S_{pot} \leq \frac{m \cdot A_{sw} \cdot f_{yw,d} \cdot z}{V_{Ed}} = \frac{2 \cdot 1,13 \cdot 43,5 \cdot 0,9 \cdot 50}{257,94} = 17,2 cm$$

Ø12/17 ($A_{sw}=1,13 cm^2$)

12.5 Stup S4

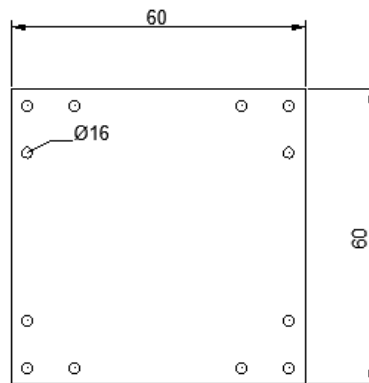

Slika 204: Skica armature u stupu SP4

STUP U OSI 2								
	Osnovna kombinacija				Potresna kombinacija			
	My,max	N,prip	My,prip	N,max	My,max	N,prip	My,pri	N,max
	kNm	kN	kNm	kN	kNm	kN	kNm	kN
GR	296,38	-3198,2	126,45	-3219,94	126,49	1658,61	126,49	1658,61
PR	218,29	-472,3	218,29	-472,3	108,3	302,85	108,3	302,85

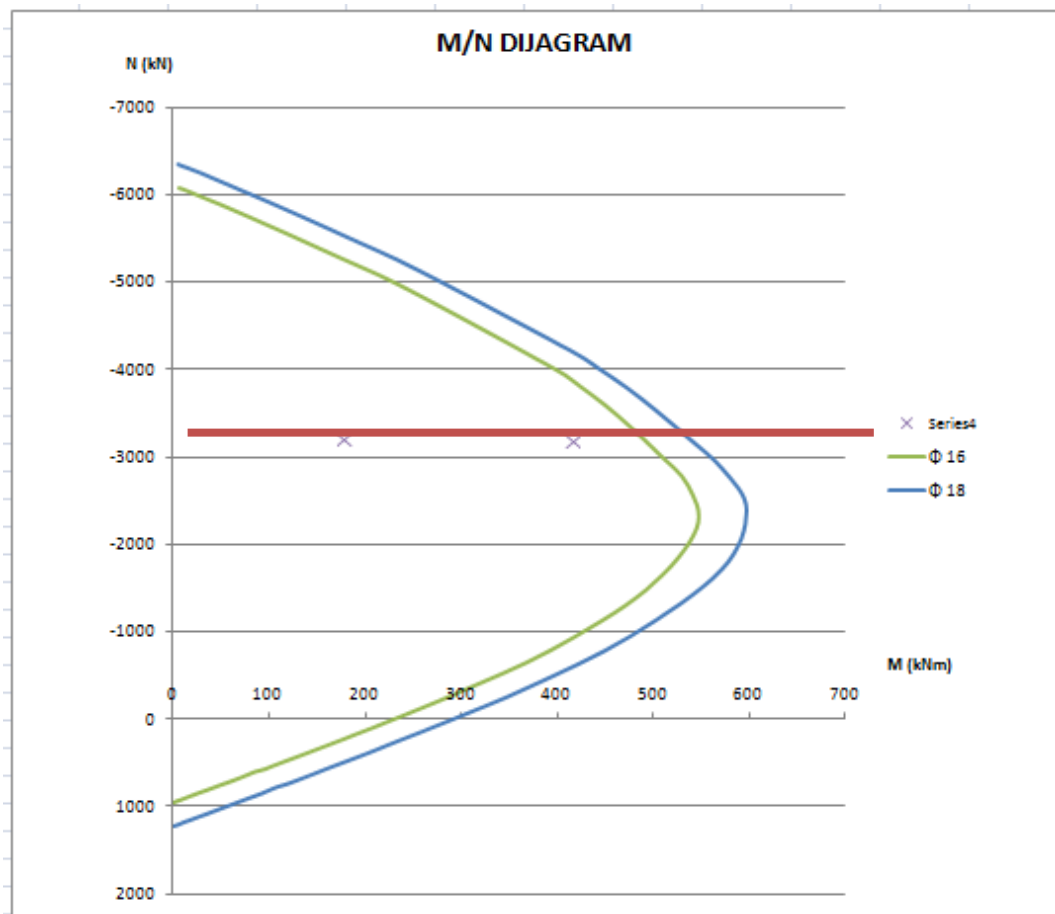

Slika 205: Dijagram stupa SP4

Napomena: Veličina betonskog presjeka uvjetovana je maksimalnom tlačnom silom

12.5.1 Proračun na poprečnu silu

$$V_{Ed} = 96,54 \text{ kN}$$

$$A_s = 12 \cdot \emptyset 16 = 24,13 \text{ cm}^2$$

Dio poprečne sile koju preuzima beton i uzdužna armatura:

$$V_{Rd,C} = \left[C_{Rd,C} \cdot k \cdot (100 \cdot \rho_l \cdot f_{ck})^{1/3} + k_1 \cdot \sigma_{cp} \right] \cdot b_w \cdot d$$

$$k = 1,0 + \sqrt{\frac{200}{d}} = 1,0 + \sqrt{\frac{200}{550}} = 1,6 \leq 2,0$$

$$k_1 = 0,15$$

$$\sigma_{cp} = N_{sd} / A_c = 3319,94 / 60^2 = 0,92$$

$$C_{Rd,C} = 0,18 / \gamma_c = 0,18 / 1,5 = 0,12$$

$$\sum A_s \approx 24,13 \text{ cm}^2 \quad \rho_l = \frac{\sum A_s}{A_c} = \frac{24,13}{60^2} = 0,007$$

$$V_{Rd,C} = \left[0,12 \cdot 1,6 \cdot (100 \cdot 0,007 \cdot 30)^{1/3} + 0,15 \cdot 0,92 \right] \cdot 600 \cdot 550 = 220345 \text{ N} = 220 \text{ kN}$$

$$V_{Rd,max} = 0,5 \cdot \nu \cdot b_w \cdot d \cdot f_{cd} = 0,5 \cdot 0,528 \cdot 600 \cdot 550 \cdot 20 = 1742400 \text{ N} = 1742,4 \text{ kN} > V_{Ed}$$

$$\nu = 0,6 \left[1 - \frac{f_{ck}}{250} \right] = 0,6 \left[1 - \frac{30}{250} \right] = 0,528$$

Nije potrebna računaska poprečna armatura

$$V_{Ed} / V_{Rd,max} = 96,54 / 1742 \approx 0,055 \Rightarrow V_{Ed} = 0,055 V_{Rd,2}$$

$$s_{w,max} = \min \{ 0,8 \cdot d; 30,0 \text{ cm} \} = \min \{ 0,8 \cdot 55 = 44; 30,0 \} \Rightarrow s_{w,max} = 30,0 \text{ cm}$$

$$\rho_{min} = 0,0011 \quad (C 30 / 37)$$

$$A_{sw,min} = \frac{\rho_{min} \cdot s_w \cdot b_w}{m} = \frac{0,0011 \cdot 30 \cdot 60}{2} = 0,99 \text{ cm}^2$$

Odabrane spone $\emptyset 12$ ($A_{sw} = 1,13 \text{ cm}^2$):

$$s_{w,pot} \leq \frac{m \cdot A_{sw,min}}{\rho_{min} \cdot b_w} = \frac{2 \cdot 1,13}{0,0011 \cdot 60} = 34,2 \text{ cm}$$

Odabrane spone $\emptyset 12/30$, $m=2$

Ukupna nosivost betona i odabrane poprečne armature:

$$V_{Rd} = V_{Rd,s} = \frac{A_{sw}}{S} \cdot z \cdot f_{ywd} \cdot m \cdot ctg \Theta = \frac{1,13}{30} \cdot (0,9 \cdot 55) \cdot 43,48 \cdot 2 \cdot 1 = 162,13 \text{ kN} \quad V_{Ed} < V_{Rd}$$

12.6 Stupovi S (3,7,9,11,12) (kratki)

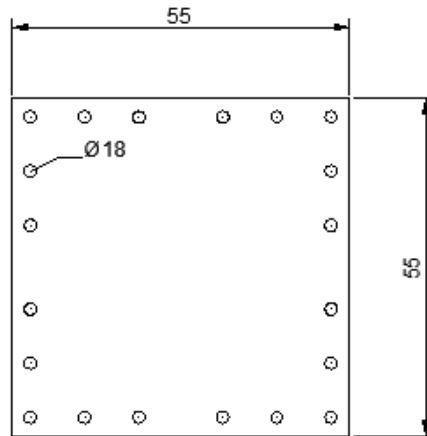

Slika 206: Skica armature u stupu SP5

STUPOVI h < 4,20m								
	Osnovna kombinacija				Potresna kombinacija			
	My,max	N,prip	My,prip	N,max	My,max	N,prip	My,prip	N,max
	kNm	kN	kNm	kN	kNm	kN	kNm	kN
GR	631,36	-2374,4	631,36	-2374,41	603,14	-1225,8	299,04	-1241,9

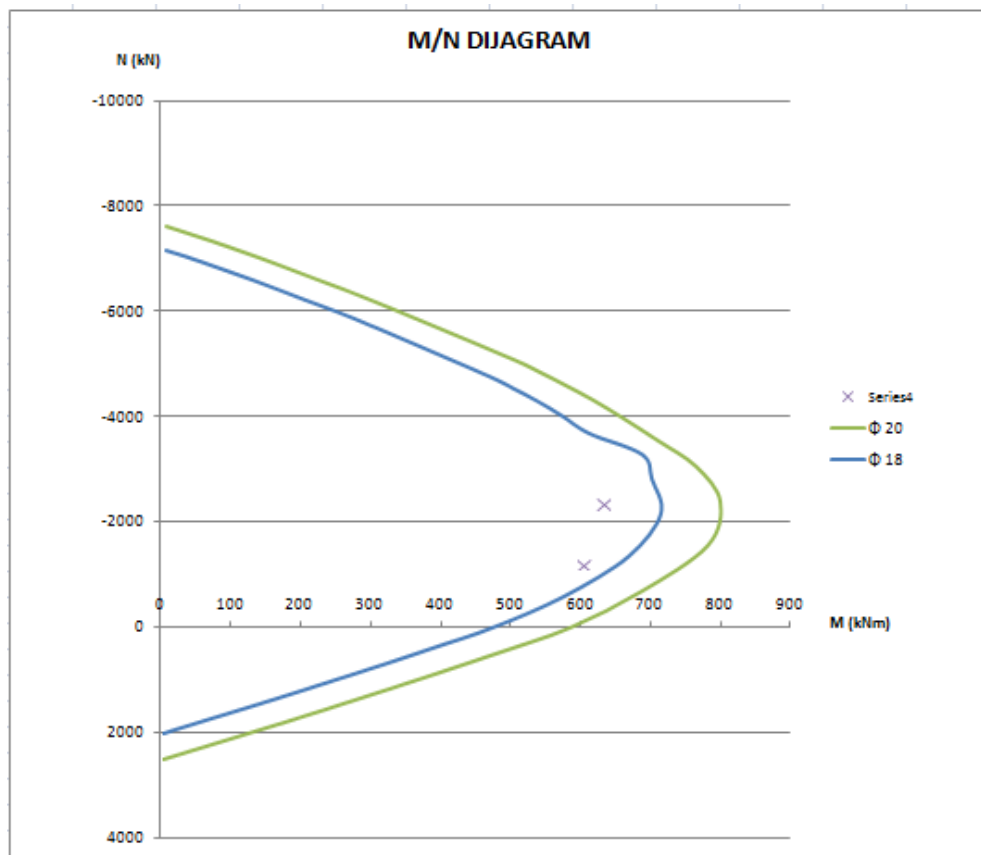

Slika 207: Dijagram stupova SP5

12.6.1 Proračun na poprečnu silu

$$V_{Ed} = 464,47 \text{ kN}$$

$$A_s = 20 \cdot \emptyset 18 = 50,8 \text{ cm}^2$$

Dio poprečne sile koju preuzima beton i uzdužna armatura:

$$V_{Rd,C} = \left[C_{Rd,C} \cdot k \cdot (100 \cdot \rho_l \cdot f_{ck})^{1/3} + k_1 \cdot \sigma_{cp} \right] \cdot b_w \cdot d$$

$$k = 1,0 + \sqrt{\frac{200}{d}} = 1,0 + \sqrt{\frac{200}{500}} = 1,63 \leq 2,0$$

$$k_1 = 0,15$$

$$\sigma_{cp} = N_{sd} / A_c = 2374,4 / 55^2 = 0,78$$

$$C_{Rd,C} = 0,18 / \gamma_c = 0,18 / 1,5 = 0,12$$

$$\sum A_s \approx 50,8 \text{ cm}^2 \quad \rho_l = \frac{\sum A_s}{A_c} = \frac{50,8}{55^2} = 0,017$$

$$V_{Rd,C} = \left[0,12 \cdot 1,63 \cdot (100 \cdot 0,017 \cdot 30)^{1/3} + 0,15 \cdot 0,78 \right] \cdot 500 \cdot 550 = 231651,43 \text{ N} = 231,65 \text{ kN}$$

$$V_{Rd,max} = 0,5 \cdot v \cdot b_w \cdot d \cdot f_{cd} = 0,5 \cdot 0,528 \cdot 550 \cdot 500 \cdot 20 = 1452000 \text{ N} = 1452 \text{ kN} > V_{Ed}$$

$$v = 0,6 \left[1 - \frac{f_{ck}}{250} \right] = 0,6 \left[1 - \frac{30}{250} \right] = 0,528$$

Potrebna računaska poprečna armatura

$$V_{Ed} / V_{Rd,max} = 464,67 / 1452 \approx 0,32 \Rightarrow V_{Ed} = 0,32 V_{Rd,2}$$

$$s_{w,max} = \min \{ 0,6 \cdot d; 30,0 \text{ cm} \} = \min \{ 0,6 \cdot 50 = 30; 30,0 \} \Rightarrow s_{w,max} = 30,0 \text{ cm}$$

$$\rho_{min} = 0,0011 \quad (C 30 / 37)$$

$$A_{sw,min} = \frac{\rho_{min} \cdot s_w \cdot b_w}{m} = \frac{0,0011 \cdot 30 \cdot 55}{2} = 0,91 \text{ cm}^2$$

Odabrane spone $\emptyset 12$ ($A_{sw} = 1,13 \text{ cm}^2$):

$$s_{w,pot} \leq \frac{m \cdot A_{sw,min}}{\rho_{min} \cdot b_w} = \frac{2 \cdot 1,13}{0,0011 \cdot 55} = 37,36 \text{ cm}$$

Odabrane spone $\emptyset 12/30$, $m=2$

Ukupna nosivost betona i odabrane poprečne armature:

$$V_{Rd} = V_{Rd,s} = \frac{A_{sw}}{S} \cdot z \cdot f_{ywd} \cdot m \cdot ctg \Theta = \frac{1,13}{30} \cdot (0,9 \cdot 50) \cdot 43,48 \cdot 2 \cdot 1 = 147,39 \text{ kN} - V_{Ed} > V_{Rd}$$

Kontroliramo nosivost betona:

$$V_{Rd,max} = \frac{\alpha_{cw} \cdot b_w \cdot z \cdot v_1 \cdot f_{cd}}{\tan \Theta + ctg \Theta} = \frac{1,0 \cdot 550 \cdot 500 \cdot 0,6 \cdot 20}{1+1} = 1650 \text{ kN} > V_{Ed}$$

Na mjestu maksimalne poprečne sile:

$$S_{pot} \leq \frac{m \cdot A_{sw} \cdot f_{yw,d} \cdot z}{V_{Ed}} = \frac{2 \cdot 1,13 \cdot 43,5 \cdot 0,9 \cdot 50}{464,67} = 9,5 \text{ cm}$$

Ø12/9 ($A_{sw}=1,13 \text{ cm}^2$)

13. PRORAČUN STUBIŠTA

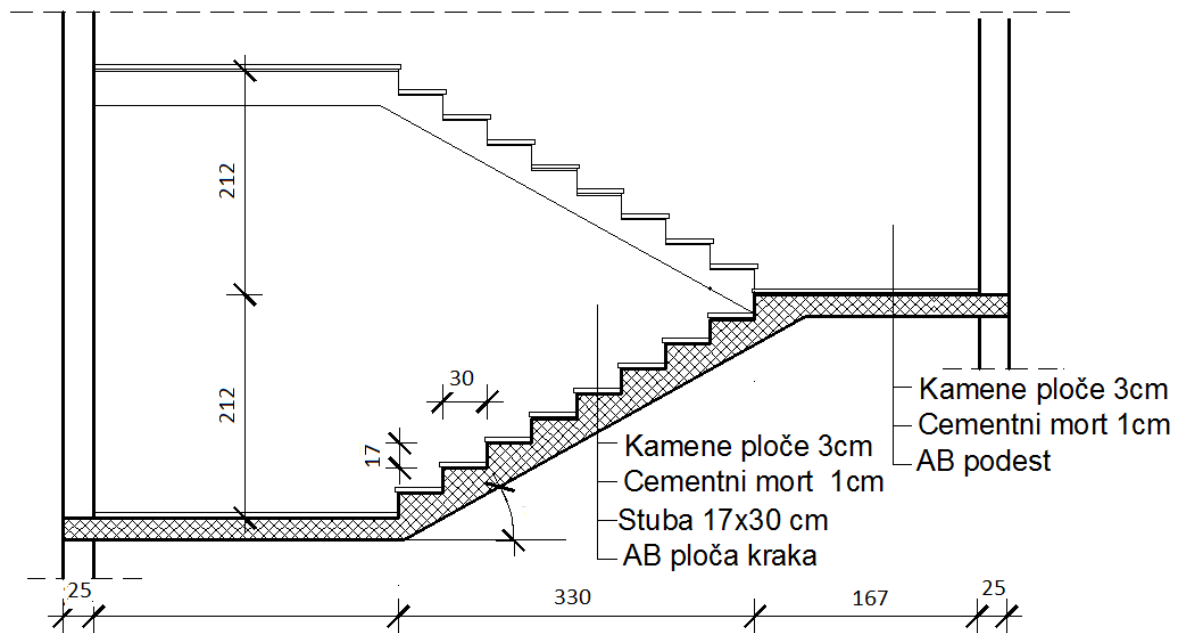

Slika 208: Presjek stubišta kroz podest i krak

Opterećenja:

- stalno opterećenje- vlastita težina stubišnog kraka

$$g = 0,17 \cdot \left(\frac{1}{\cos 32,7^\circ} \right) \cdot 25 = 5,05 \text{ cm}$$

Napomena: Iako je vlastita težina podesta nešto manja od vlastite težine stubišnog kraka, za potrebe proračuna usvojena je vlastita težina stubišnog kraka na cijeloj duljini statičkog sustava.

- dodatno stalno opterećenje: $\Delta g = 3,0 \text{ kN/m}^2$

- korisno opterećenje $q = 5,0 \text{ kN/m}^2$

Statički sustav:

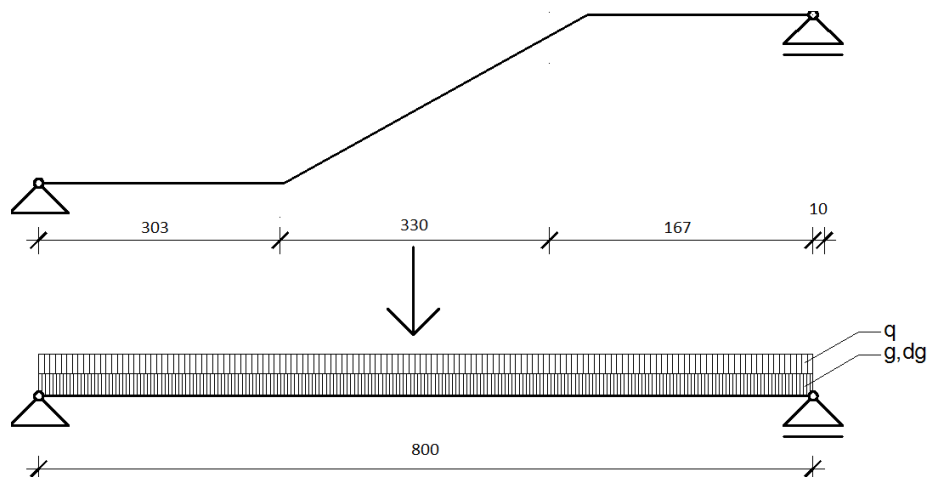

Slika 209: Prikaz statičkog sustava

$$M_g = \frac{(g + \Delta g) \cdot l^2}{8} = \frac{(5,05 + 3) \cdot 8,0^2}{8} = 64,4 \text{ kN} / \text{m}'$$

$$M_q = \frac{q \cdot l^2}{8} = \frac{5,0 \cdot 8^2}{8} = 40 \text{ kN} / \text{m}'$$

$$M_{Ed, \max} = 1,35 \cdot M_g + 1,35 \cdot M_q = 1,35 \cdot 64,4 + 1,5 \cdot 40 = 147,21 \text{ kNm}$$

Dimenzioniranje na moment savijanja:

h=18 cm; b= 100cm; d₁=3,0 cm; d=18-2=16,0cm

$$\mu_{Ed} = \frac{M_{Ed}}{b_w \cdot d^2 \cdot f_{cd}} = \frac{147,21 \cdot 100}{100 \cdot 16^2 \cdot 2} = 0,24$$

$$z_a \quad \varepsilon_{s1} = 5\text{‰}, \quad \varepsilon_{c2} = 3,5\text{‰}, \quad \zeta = 0,829$$

$$\xi = 0,412$$

$$A_{s1} = \frac{M_{sd}}{\zeta \cdot d \cdot f_{yd}} = \frac{147,21 \cdot 100}{0,829 \cdot 16 \cdot 43,48} = 21,31 \text{ cm}^2$$

$$A_{s1, \min} = \begin{cases} 0,26 \cdot \frac{f_{cm}}{f_{yk}} \cdot b_w \cdot d = 0,26 \cdot \frac{0,29}{43,48} \cdot 100 \cdot 16 = 2,77 \text{ cm}^2 / \text{m}' \\ 0,0013 \cdot b_w \cdot d = 0,0013 \cdot 100 \cdot 16 = 2,08 \text{ cm}^2 / \text{m}' \end{cases}$$

$$A_{s1, \min} = 2,08 \text{ cm}^2 / \text{m}'$$

$$A_{s1, \max} = 0,0022 \cdot b \cdot h = \frac{2,2}{100} \cdot 100 \cdot 16 = 32,5 \text{ cm}^2 / \text{m}'$$

Odabrana armatura: 6Φ22 (A_s=22,81 cm²)

14. PRORAČUN TEMELJA

Proračun temelja je proveden klasičnom metodom dopuštenih naprezanja. Dopuštena naprezanja ispod objekta iznose 500kPa.

$$\sigma_{1,2} = \frac{N_{Ed,max}}{A} \pm \frac{M_{Ed,max}}{W}$$

Mjerodavne rezne sile za dokaz nosivosti nisu uvećane faktorima, jer to nije potrebno za provedbu dokaza nosivosti pomoću metode dopuštenih naprezanja.

Za sve temelje koristi se isti materijal:

Beton C30/37: $f_{cd}=20\text{Mpa}$

Armatura: B500B: $f_{yd}=434,8\text{Mpa}$

Zaštitni sloj betona je 5 cm.

Minimalna armatura temelja:

$$A_{s1,min} = \begin{cases} 0,26 \cdot \frac{f_{cm}}{f_{yk}} \cdot b_w \cdot d \\ 0,0013 \cdot b_w \cdot d \end{cases}$$

Maksimalna armatura temelja:

$$A_{s1,max} = 0,0022 \cdot b \cdot h$$

14.1 Proračun trakastih temelja vanjskih i unutarnjih zidova:

Armirano betonske trake su predviđene ispod svih zidova zgrade. Temeljene trake imaju različite širine zbog ujednačenja dodirnog pritiska temelj-tlo. Time se značajno utječe na sprječavanje negativnog utjecaja diferencijalnog slijeganja. U proračunskom modelu konstrukcije nije uzimano opterećenje vlastitom težinom tla i utjecaji tla, za dimenzioniranje temelja ti utjecaji uzeti su u obzir na način da se njihove sile i momenti savijanja zbroje ili oduzmu od sila dobivenih proračunom iz osnovne i potresne kombinacije.

14.1.1 Unutarnje temeljne trake:

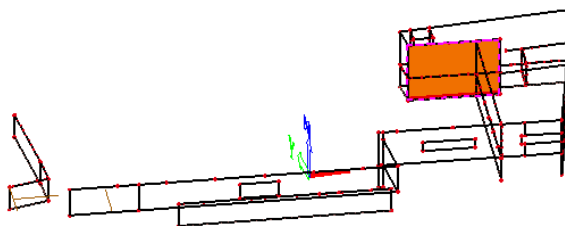

Slika 210: Prikaz položaja zida za kojeg se računa temeljna traka

Dimenzije temeljne trake:

$$B=1,6\text{m}; h=0,5\text{m}; L=1,00\text{m}$$

Težina temelja:

$$W = B \cdot L \cdot h \cdot \gamma_{bet} = 1,6 \cdot 1,0 \cdot 0,5 \cdot 25 = 20\text{kN}$$

Težina nadsloja iznad temelja:

$$H=1,5\text{ m}; d_{zid}=20\text{ cm}; \gamma_{tla}=20\text{Kn/m}^3$$

$$W = \left[H \cdot \left(\frac{B}{2} - \frac{d_{zid}}{2} \right) \cdot 1,0 \right] \cdot \gamma_{tla} = \left[1,5 \cdot \left(\frac{1,6}{2} - \frac{0,2}{2} \right) \cdot 1,0 \right] \cdot 20 = 20,25\text{kN}$$

$$N_{Ed,max} = N_{Ed} + W_{tem} + W_{tla}$$

$$M_{Ed,max} = M_{Ed,max} - W_{tla} \cdot a$$

$$a = \frac{\left(\frac{B}{2} - \frac{d_{zid}}{2} \right)}{2} + \frac{d_{zid}}{2} = \frac{\left(\frac{1,6}{2} - \frac{0,20}{2} \right)}{2} + \frac{0,20}{2} = 0,46\text{m}$$

$$M_{Ed,max} = M_{Ed,max} - W_{tla} \cdot a$$

Osnovna kombinacija		Potresna kombinacija	
N_{max}	M_x	N_{max}	M_x
(kN/m')	(kNm/m')	(kN/m')	(kNm/m')
636,46	20,4	349,43	64,59

Dokaz naprezanja na kontaktu temelj-tlo:

-Dokaz naprezanja za osnovnu kombinaciju

$$\sigma_{1,2} = \frac{636,46}{1,6} \pm \frac{20,4}{0,43}$$

$$\sigma_1 = \frac{636,46}{1,6} + \frac{20,4}{0,43} = 445,23 \text{ kPa} < \sigma_{dop}$$

$$\sigma_2 = \frac{636,46}{1,6} - \frac{20,4}{0,43} = 350,34 \text{ kPa} < \sigma_{dop}$$

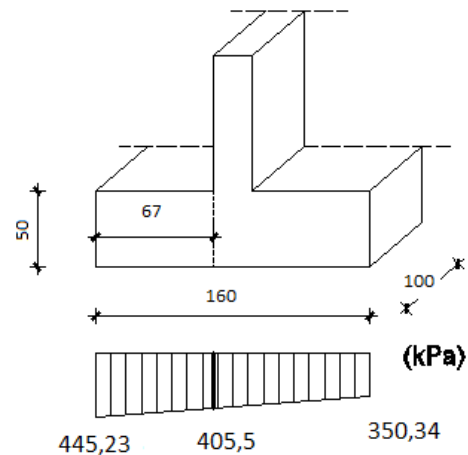

Dimenzioniranje temelja

Vrijednosti momenata savijanja u kritičnom presjeku:

$$M_{Ed} = \left((445,23 - 405,5) \cdot 0,67 \cdot \frac{1}{2} \right) \cdot \frac{2}{3} \cdot 0,67 + (405,5 \cdot 0,67) \cdot \frac{1}{2} \cdot 0,67 = 96,96 \text{ kNm} / \text{m}'$$

B=1,6m; h=0,5m; L=1,00m; d=50-7=43cm

$$\mu_{Ed} = \frac{M_{Ed}}{b_w \cdot d^2 \cdot f_{cd}} = \frac{96,96 \cdot 100}{160 \cdot 43^2 \cdot 2} = 0,016$$

$$za \quad \varepsilon_{s1} = 10\text{‰}, \quad \varepsilon_{c2} = 0,7\text{‰}, \quad \zeta = 0,977$$

$$\xi = 0,065$$

$$A_{s1} = \frac{M_{sd}}{\zeta \cdot d \cdot f_{yd}} = \frac{96,96 \cdot 100}{0,977 \cdot 43 \cdot 43,48} = 5,3 \text{ cm}^2$$

$$A_{s1, \min} = 5,59 \text{ cm}^2$$

$$A_{s1, \max} = 11,0 \text{ cm}^2$$

Odabrana armatura: 3Φ16 ($A_s=6,03 \text{ cm}^2$)

→5Φ12 ($A_s=5,65 \text{ cm}^2$)

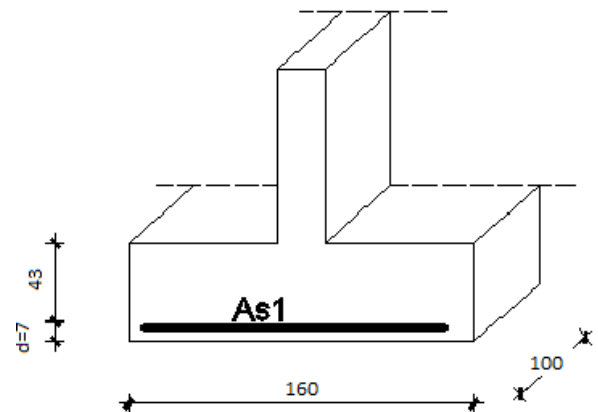

14.1.2 Unutarnje temeljne trake:

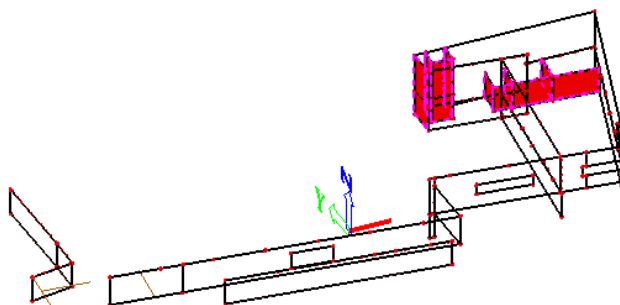

Slika 211: Prikaz položaja zida za kojeg se računa temeljna traka

Dimenzije temeljne trake:

$$B=1,4\text{m}; h=0,5\text{m}; L=1,00\text{m}$$

Težina temelja:

$$W = B \cdot L \cdot h \cdot \gamma_{bet} = 1,4 \cdot 1,0 \cdot 0,5 \cdot 25 = 17,5\text{kN}$$

Težina nadsloja iznad temelja:

$$H=1,5\text{ m}; d_{zid}=20\text{ cm}; \gamma_{tla}=20\text{Kn/m}^3$$

$$W = \left[H \cdot \left(\frac{B}{2} - \frac{d_{zid}}{2} \right) \cdot 1,0 \right] \cdot \gamma_{tla} = \left[1,5 \cdot \left(\frac{1,4}{2} - \frac{0,20}{2} \right) \cdot 1,0 \right] \cdot 20 = 17,25\text{kN}$$

$$N_{Ed,max} = N_{Ed} + W_{tem} + W_{tla}$$

$$M_{Ed,max} = M_{Ed,max} - W_{tla} \cdot a$$

$$a = \frac{\left(\frac{B}{2} - \frac{d_{zid}}{2} \right)}{2} + \frac{d_{zid}}{2} = \frac{\left(\frac{1,4}{2} - \frac{0,20}{2} \right)}{2} + \frac{0,20}{2} = 0,41\text{m}$$

$$M_{Ed,max} = M_{Ed,max} - W_{tla} \cdot a$$

Osnovna kombinacija		Potresna kombinacija	
N_{max}	M_x	N_{max}	M_x
(kN/m')	(kNm/m')	(kN/m')	(kNm/m')
566,3	20,59	515,79	5,75

Dokaz naprezanja na kontaktu temelj-tlo:

-Dokaz naprezanja za osnovnu kombinaciju

$$\sigma_{1,2} = \frac{566,3}{1,4} \pm \frac{20,59}{0,33}$$

$$\sigma_1 = \frac{566,3}{1,4} + \frac{20,59}{0,33} = 466,89 \text{ kPa} < \sigma_{dop}$$

$$\sigma_2 = \frac{566,6}{1,4} - \frac{20,59}{0,33} = 342,1 \text{ kPa} < \sigma_{dop}$$

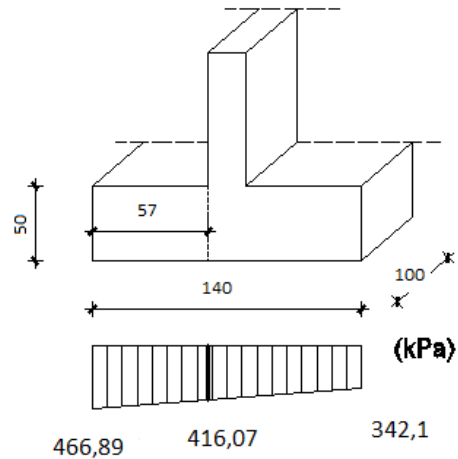

Dimenzioniranje temelja

Vrijednosti momenata savijanja u kritičnom presjeku:

$$M_{Ed} = \left((466,89 - 416,07) \cdot 0,57 \cdot \frac{1}{2} \right) \cdot \frac{2}{3} \cdot 0,57 + (416,07 \cdot 0,57) \cdot \frac{1}{2} \cdot 0,57 = 73,09 \text{ kNm} / \text{m}'$$

B=1,4m; h=0,5m; L=1,00m; d=50-7=43cm

$$\mu_{Ed} = \frac{M_{Ed}}{b_w \cdot d^2 \cdot f_{cd}} = \frac{73,09 \cdot 100}{140 \cdot 43^2 \cdot 2} = 0,141$$

za $\varepsilon_{s1} = 10\text{‰}$, $\varepsilon_{c2} = 2,0\text{‰}$, $\zeta = 0,893$

$$\xi = 0,286$$

$$A_{s1} = \frac{M_{sd}}{\zeta \cdot d \cdot f_{yd}} = \frac{73,09 \cdot 100}{0,893 \cdot 43 \cdot 43,48} = 4,37 \text{ cm}^2$$

$$A_{s1,\min} = 5,59 \text{ cm}^2$$

$$A_{s1,\max} = 11,0 \text{ cm}^2$$

Odabrana armatura: $3\Phi 16$ ($A_s = 6,03 \text{ cm}^2$)

$\rightarrow 5\Phi 12$ ($A_s = 5,65 \text{ cm}^2$)

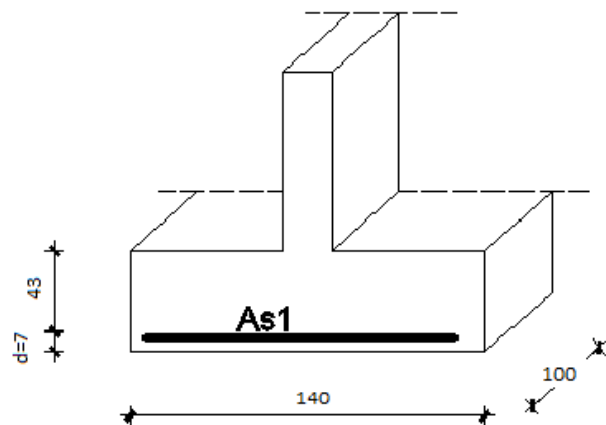

14.1.3 Vanjske temeljne trake:

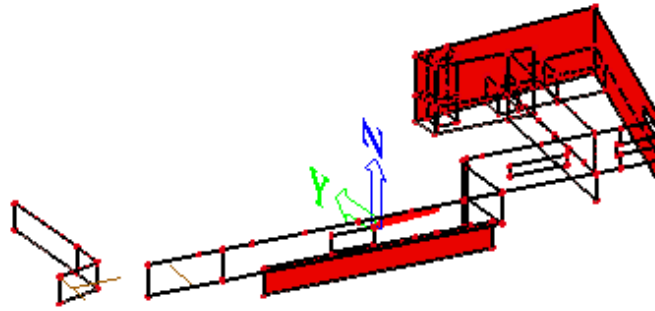

Slika 212: Prikaz položaja zida za kojeg se računa temeljna traka

Dimenzije temeljne trake:

$$B=1,2 \text{ m}; h=0,5\text{m}; L=1,00\text{m}$$

Težina temelja:

$$W = B \cdot L \cdot h \cdot \gamma_{bet} = 1,2 \cdot 1,0 \cdot 0,5 \cdot 25 = 15 \text{ kN}$$

Težina nadsloja iznad temelja:

$$H=1,5 \text{ m}; d_{zid}=25 \text{ cm}; \gamma_{tla}=20 \text{ kN/m}^3$$

$$W = \left[H \cdot \left(\frac{B}{2} - \frac{d_{zid}}{2} \right) \cdot 1,0 \right] \cdot \gamma_{tla} = \left[1,5 \cdot \left(\frac{1,2}{2} - \frac{0,25}{2} \right) \cdot 1,0 \right] \cdot 20 = 14,25 \text{ kN}$$

$$N_{Ed,max} = N_{Ed} + W_{tem} + W_{tla}$$

$$M_{Ed,max} = M_{Ed,max} - W_{tla} \cdot a$$

$$a = \frac{\left(\frac{B}{2} - \frac{d_{zid}}{2} \right)}{2} + \frac{d_{zid}}{2} = \frac{\left(\frac{1,2}{2} - \frac{0,25}{2} \right)}{2} + \frac{0,25}{2} = 0,36 \text{ m}$$

$$M_{Ed,max} = M_{Ed,max} - W_{tla} \cdot a$$

Osnovna kombinacija		Potresna kombinacija	
N_{max}	M_x	N_{max}	M_x
(kN/m')	(kNm/m')	(kN/m')	(kNm/m')
341,35	15,86	459,81	14,98

Dokaz naprezanja na kontaktu temelj-tlo:

-Dokaz naprezanja za osnovnu kombinaciju

$$\sigma_{1,2} = \frac{459,81}{1,2} \pm \frac{14,98}{0,24}$$

$$\sigma_1 = \frac{459,81}{1,2} + \frac{14,98}{0,24} = 445,59 \text{ kPa} < \sigma_{dop}$$

$$\sigma_2 = \frac{459,81}{1,2} - \frac{14,98}{0,24} = 320,75 \text{ kPa} < \sigma_{dop}$$

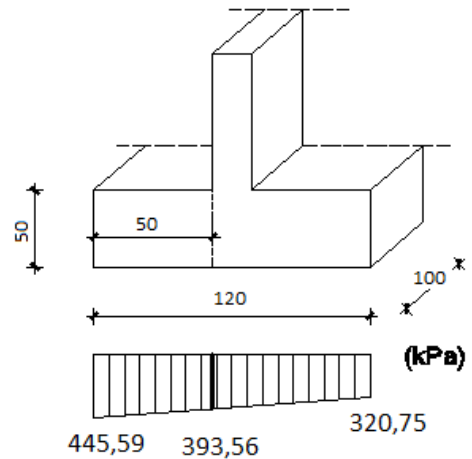

Dimenzioniranje temelja

Vrijednosti momenata savijanja u kritičnom presjeku:

$$M_{Ed} = \left((445,59 - 393,56) \cdot 0,5 \cdot \frac{1}{2} \right) \cdot \frac{2}{3} \cdot 0,5 + (393,56 \cdot 0,5) \cdot \frac{1}{2} \cdot 0,5 = 53,53 \text{ kNm / m'}$$

B=1,2m; h=0,5m; L=1,00m; d=50-7=43cm

$$A_{s1} = \frac{M_{sd}}{\zeta \cdot d \cdot f_{yd}} = \frac{53,53 \cdot 100}{0,9 \cdot 43 \cdot 43,48} = 3,18 \text{ cm}^2$$

$$A_{s1,\min} = 5,59 \text{ cm}^2$$

$$A_{s1,\max} = 11,0 \text{ cm}^2$$

Odabrana armatura: 3Φ16 ($A_s=6,03 \text{ cm}^2$)

→ 5Φ12 ($A_s=5,65 \text{ cm}^2$)

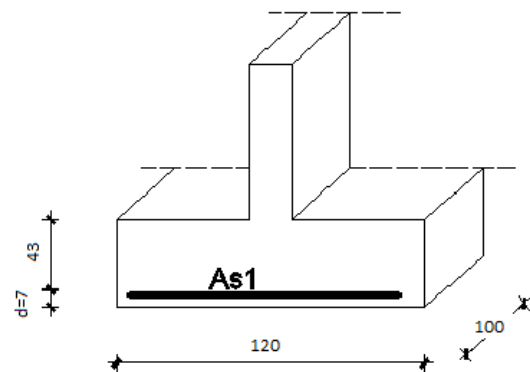

14.1.4 Vanjske temeljne trake:

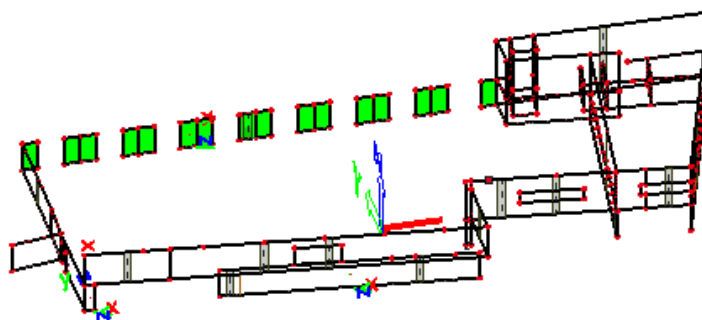

Slika 213: Prikaz položaja zida za kojeg se računa temeljna traka

Dimenzije temeljne trake:

$$B=2,2\text{m}; h=0,50\text{m}; L=1,00\text{m}$$

Težina temelja:

$$W = B \cdot L \cdot h \cdot \gamma_{bet} = 2,2 \cdot 1,0 \cdot 0,5 \cdot 25 = 27,5\text{kN}$$

Težina nadsloja iznad temelja:

$$H=1,5\text{ m}; d_{zid}=25\text{ cm}; \gamma_{tla}=20\text{Kn/m}^3$$

$$W = \left[H \cdot \left(\frac{B}{2} - \frac{d_{zid}}{2} \right) \cdot 1,0 \right] \cdot \gamma_{tla} = \left[1,5 \cdot \left(\frac{2,2}{2} - \frac{0,25}{2} \right) \cdot 1,0 \right] \cdot 20 = 29,25\text{kN}$$

$$N_{Ed,max} = N_{Ed} + W_{tem} + W_{tla}$$

$$M_{Ed,max} = M_{Ed,max} - W_{tla} \cdot a$$

$$a = \frac{\left(\frac{B}{2} - \frac{d_{zid}}{2} \right)}{2} + \frac{d_{zid}}{2} = \frac{\left(\frac{2,2}{2} - \frac{0,25}{2} \right)}{2} + \frac{0,25}{2} = 0,61\text{m}$$

$$M_{Ed,max} = M_{Ed,max} - W_{tla} \cdot a$$

Osnovna kombinacija		Potresna kombinacija	
N_{max}	M_x	N_{max}	M_x
(kN/m')	(kNm/m')	(kN/m')	(kNm/m')
701,1	129,52	569,39	18,00

Dokaz naprezanja na kontaktu temelj-tlo:

-Dokaz naprezanja za osnovnu kombinaciju

$$\sigma_{1,2} = \frac{701,1}{2,2} \pm \frac{129,52}{0,80}$$

$$\sigma_1 = \frac{701,1}{2,2} + \frac{129,52}{0,80} = 479,24 \text{ kPa} < \sigma_{dop}$$

$$\sigma_2 = \frac{701,1}{2,2} - \frac{129,52}{0,80} = 157,2 \text{ kPa} < \sigma_{dop}$$

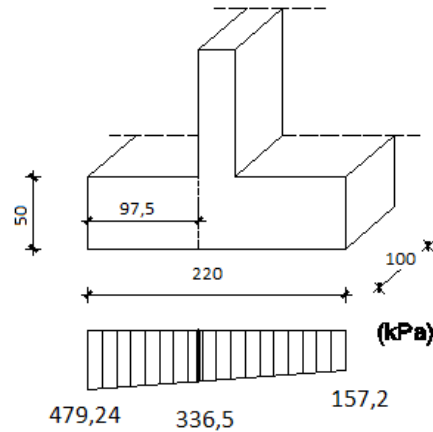

Dimenzioniranje temelja

Vrijednosti momenata savijanja u kritičnom presjeku:

$$M_{Ed} = \left((479,24 - 336,5) \cdot 0,975 \cdot \frac{1}{2} \right) \cdot \frac{2}{3} \cdot 0,975 + (336,5 \cdot 0,975) \cdot \frac{1}{2} \cdot 0,975 = 205,17 \text{ kNm} / m'$$

B=2,2m; h=0,50m; L=1,00m; d=50-7=43cm

$$A_{s1} = \frac{M_{sd}}{\zeta \cdot d \cdot f_{yd}} = \frac{205,17 \cdot 100}{0,9 \cdot 43 \cdot 43,48} = 12,19 \text{ cm}^2$$

$$A_{s1, \min} = 5,59 \text{ cm}^2$$

$$A_{s1, \max} = 11,0 \text{ cm}^2$$

Odabrana armatura: 6Φ16 ($A_s=12,06 \text{ cm}^2$)

→ 12Φ12 ($A_s=13,57 \text{ cm}^2$)

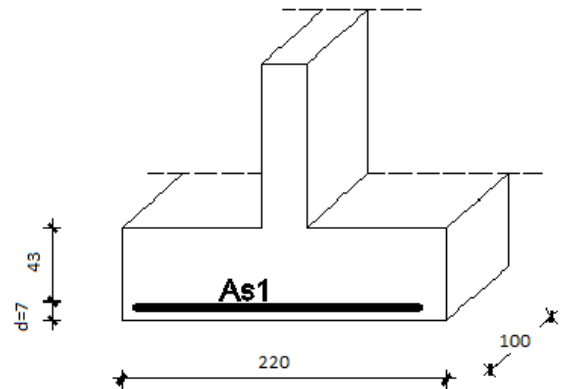

14.2 Proračun temelja samca

14.2.1 Temelji stupova S1 i S2

Dimenzije temelja samca:

$$B=1,8m; h=0,5m$$

Težina temelja:

$$W = B^2 \cdot h \cdot \gamma_{bet} \text{ (kN)}$$

Opterećenja za dokaz nosivosti tla:

Osnovna kombinacija		Potresna kombinacija	
N_{max}	M_x	N_{max}	M_x
(kN/m')	(kNm/m')	(kN/m')	(kNm/m')
527,95	308,1	569,39	18,58

Dokaz naprezanja na kontaktu temelj-temeljno tlo

-Dokaz naprezanja za maksimalnu kombinaciju kombinaciju

$$\sigma_{1,2} = \frac{527,95}{3,24} \pm \frac{308,1}{0,972}$$

$$\sigma_1 = \frac{527,95}{3,24} + \frac{308,1}{0,972} = 480,25kPa < \sigma_{dop}$$

$$\sigma_2 = \frac{527,95}{3,24} - \frac{308,1}{0,972} = -154,35kPa(\text{vlak}) < \sigma_{dop}$$

$$e_y = \frac{M_{Ed,max,y}}{N_{Ed,max}} = \frac{308,1}{527,95} = 0,5 > \frac{B}{6} = \frac{1,8}{6} = 0,3m$$

Potrebna je redukcija temeljne stope:

$$B' = 3 \cdot \left(\frac{B}{2} - e_y \right) = 3 \cdot \left(\frac{1,8}{2} - 0,5 \right) = 1,2m$$

Dokaz naprezanja za reduciranu površinu temeljne stope:

$$\sigma_{max} = \frac{2 \cdot N_{Ed,max}}{B \cdot B'} = \frac{2 \cdot 527,95}{1,8 \cdot 1,2} = 487,96kPa < \sigma_{dop}$$

Dimenzioniranje temelja:

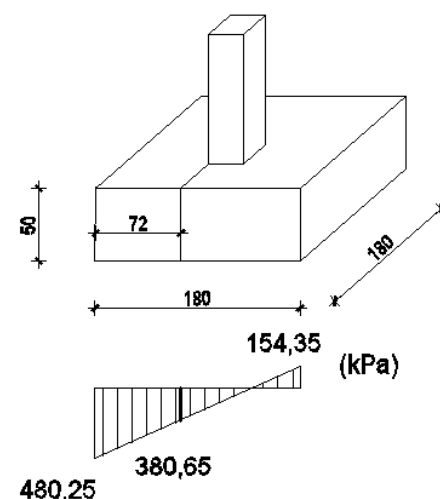

Vrijednosti momenta savijanja u kritičnom presjeku:

$$M_{Ed} = \left((480,25 - 380,65) \cdot 0,72 \cdot \frac{1}{2} \right) \cdot \frac{2}{3} \cdot 0,72 + (380,65 \cdot 0,72) \cdot \frac{1}{2} \cdot 0,72 = 115,88 \text{ kNm} / \text{m}'$$

B=1,8m; h=0,5m: d=43cm

$$A_{s1} = \frac{M_{sd}}{\zeta \cdot d \cdot f_{yd}} = \frac{115,88 \cdot 100}{0,9 \cdot 43 \cdot 43,48} = 6,88 \text{ cm}^2$$

$$A_{s1,\min} = 10,06 \text{ cm}^2$$

Odabrana armatura: 5Φ16 ($A_s=10,05 \text{ cm}^2$) cijeli temelj

→ 9Φ12 ($A_s=10,18 \text{ cm}^2$)

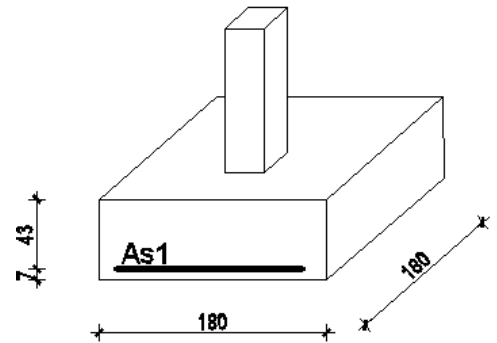

14.2.1.1 Dokaz nosivosti na proboj temelja

BETON

C 30/37

$\tau_{rd} = 0,34 \text{ N/mm}^2$

ARMATURA

B 500/550

$f_{yk} = 500 \text{ N/mm}^2$

$\gamma_s = 1,15$

$\phi_x = 2 \%$

$\phi_y = 2 \%$

SILA

$V_{sd} = 527,95 \text{ kN}$

$\beta_p = 1$

$\alpha = 90^\circ$

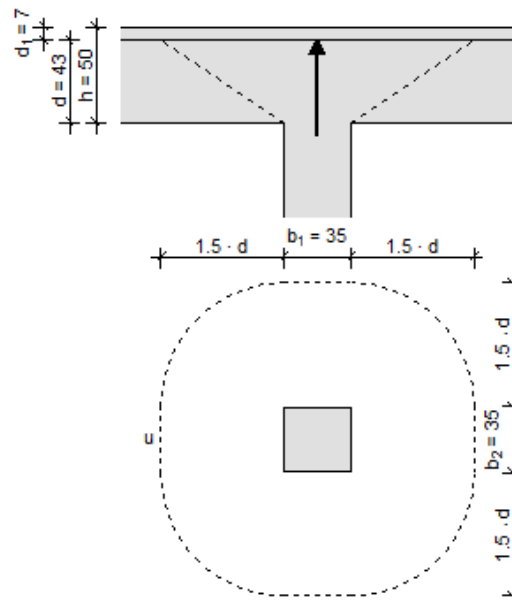

PRORAČUN

$$2 \cdot b_1 + 2 \cdot b_2 = 140 \text{ cm} \leq 11 \cdot d = 473 \text{ cm}$$

$$b_1/b_2 = 1$$

$$0.5 < b_1/b_2 < 2.0$$

$$u_{cr} = 2 \cdot (d_1 + d_2) + 2 \cdot (1.5 \cdot d) \cdot \pi = 545,3 \text{ cm}$$

$$v_{Sd} = V_{Sd} \cdot \frac{\beta_p}{u_{cr}} = \mathbf{0,97 \text{ kN/cm}}$$

$$k = 1.6 - d \geq 1 = 1,17$$

$$\rho_e = \sqrt{\rho_x \cdot \rho_y} = 2 \%$$

$$0.5\% \leq \rho_e \leq 1.5\% \Rightarrow \rho_e = 1,5 \%$$

$$v_{Rd1} = \tau_{Rd} \cdot k \cdot (1.2 + 40 \cdot \rho_e) \cdot d = \mathbf{3,08 \text{ kN/cm}}$$

$$v_{Sd} \leq v_{Rd1}$$

⇒ NIJE POTREBNA JE DODATNA ARMATURA

14.2.2 Temelji stupova S5 i S6

Dimenzije temelja samca:

$$B=2,5\text{m}; h=0,5\text{m}$$

Težina temelja:

$$W = B^2 \cdot h \cdot \gamma_{bet} \text{ (kN)}$$

Opterećenja za dokaz nosivosti tla:

Osnovna kombinacija		Potresna kombinacija	
N_{max}	M_x	N_{max}	M_x
(kN/m')	(kNm/m')	(kN/m')	(kNm/m')
2768,64	28,13	1313,26	17,7

Dokaz naprezanja na kontaktu temelj-temeljno tlo

-Dokaz naprezanja za maksimalnu kombinaciju

kombinaciju

$$\sigma_{1,2} = \frac{2768,64}{6,25} \pm \frac{28,13}{2,6}$$

$$\sigma_1 = \frac{2768,64}{6,25} + \frac{28,13}{2,6} = 453,8 \text{ kPa} < \sigma_{dop}$$

$$\sigma_2 = \frac{2768,64}{6,25} - \frac{28,13}{2,6} = 432,16 \text{ kPa} < \sigma_{dop}$$

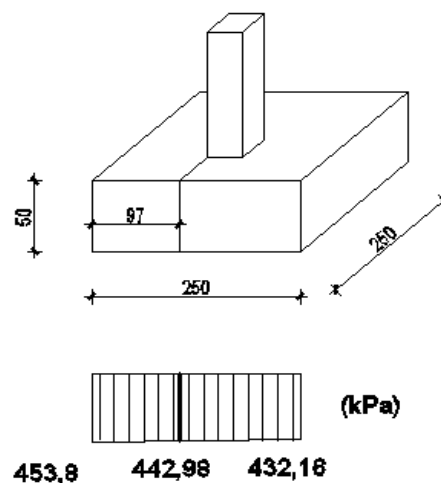

Dimenzioniranje temelja:

Vrijednosti momenta savijanja u kritičnom presjeku:

$$M_{Ed} = \left((453,8 - 442,98) \cdot 0,97 \cdot \frac{1}{2} \right) \cdot \frac{2}{3} \cdot 0,97 + (442,98 \cdot 0,97) \cdot \frac{1}{2} \cdot 0,97 = 211,79 \text{ kNm} / \text{m}'$$

B=2,5m; h=0,5m: d=43cm

$$A_{s1} = \frac{M_{sd}}{\zeta \cdot d \cdot f_{yd}} = \frac{211,79 \cdot 100}{0,9 \cdot 43 \cdot 43,48} = 12,58 \text{ cm}^2$$

$$A_{s1,\min} = 13,97 \text{ cm}^2$$

14.2.2.1 Dokaz nosivosti na proboj temelja

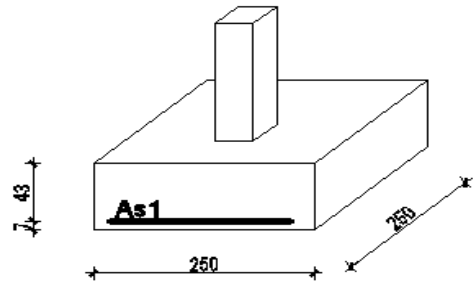

BETON
C 30/37
 $\tau_{rd} = 0,34 \text{ N/mm}^2$

ARMATURA
B 500/550
 $f_{yk} = 500 \text{ N/mm}^2$
 $\gamma_s = 1,15$
 $\phi_x = 2 \%$
 $\phi_y = 2 \%$

SILA
 $V_{sd} = 2768 \text{ kN}$
 $\beta_p = 1$
 $\alpha = 90^\circ$

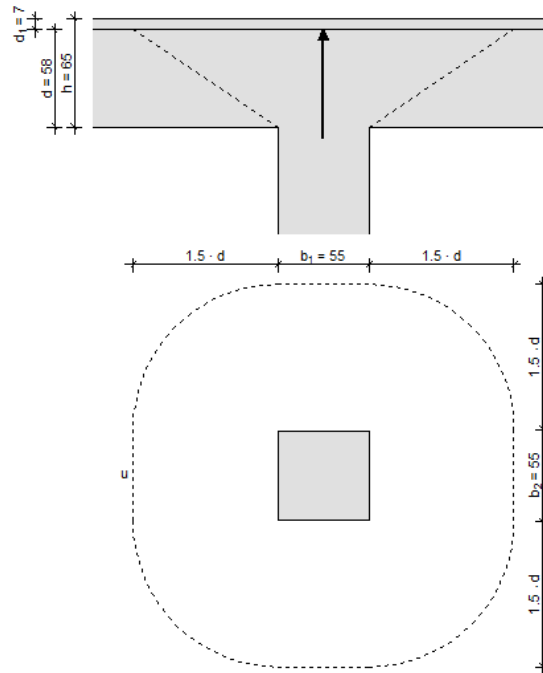

PRORAČUN

$$2 \cdot b_1 + 2 \cdot b_2 = 220 \text{ cm} \leq 11 \cdot d = 638 \text{ cm}$$

$$b_1/b_2 = 1$$

$$0.5 < b_1/b_2 < 2.0$$

$$u_{cr} = 2 \cdot (d_1 + d_2) + 2 \cdot (1.5 \cdot d) \cdot \pi = 766,6 \text{ cm}$$

$$V_{Sd} = V_{Sd} \cdot \frac{\beta_p}{u_{cr}} = \mathbf{3,61 \text{ kN/cm}}$$

$$k = 1.6 - d \geq 1 = 1,02$$

$$\rho_e = \sqrt{\rho_x \cdot \rho_y} = 2 \%$$

$$0.5\% \leq \rho_e \leq 1.5\% \Rightarrow \rho_e = 1,5 \%$$

$$V_{Rd1} = \tau_{Rd} \cdot k \cdot (1.2 + 40 \cdot \rho_e) \cdot d = \mathbf{3,62 \text{ kN/cm}}$$

$$V_{Sd} \leq V_{Rd1}$$

⇒ NIJE POTREBNA JE DODATNA ARMATURA

Visina temelja je povećana: $h=65 \text{ cm}$

Odabrana armatura: $16\Phi 12$ ($A_s=18,09\text{cm}^2$) cijeli temelj

14.2.3 Temelji stupova S10 i S8

Dimenzije temelja samca:

$$B=2,5\text{m}; h=0,5\text{m}$$

Težina temelja:

$$W = B^2 \cdot h \cdot \gamma_{bet} \text{ (kN)}$$

Opterećenja za dokaz nosivosti tla:

Osnovna kombinacija		Potresna kombinacija	
N_{max}	M_x	N_{max}	M_x
(kN/m')	(kNm/m')	(kN/m')	(kNm/m')
2411,19	218,18	1274,2	85,3

Dokaz naprezanja na kontaktu temelj-temeljno tlo

-Dokaz naprezanja za maksimalnu kombinaciju

kombinaciju

$$\sigma_{1,2} = \frac{2411,19}{6,25} \pm \frac{218,18}{2,6}$$

$$\sigma_1 = \frac{2411,19}{6,25} + \frac{218,18}{2,6} = 469,7 \text{ kPa} < \sigma_{dop}$$

$$\sigma_2 = \frac{2411,19}{6,25} - \frac{218,18}{2,6} = 301,8 \text{ kPa} < \sigma_{dop}$$

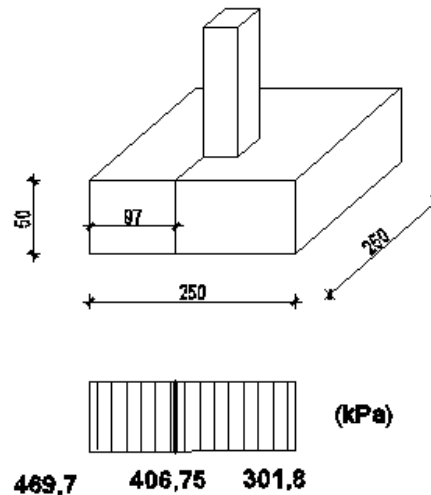

Dimenzioniranje temelja:

Vrijednosti momenta savijanja u kritičnom presjeku:

$$M_{Ed} = \left((469,7 - 406,75) \cdot 0,97 \cdot \frac{1}{2} \right) \cdot \frac{2}{3} \cdot 0,97 + (406,75 \cdot 0,97) \cdot \frac{1}{2} \cdot 0,97 = 211,09 \text{ kNm} / \text{m}'$$

B=2,5m; h=0,5m: d=43cm

$$A_{s1} = \frac{M_{sd}}{\zeta \cdot d \cdot f_{yd}} = \frac{211,09 \cdot 100}{0,9 \cdot 43 \cdot 43,48} = 12,48 \text{ cm}^2$$

$$A_{s1,\min} = 13,98 \text{ cm}^2$$

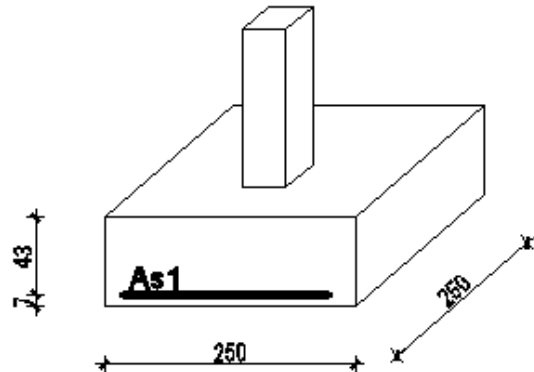

14.2.3.1 Dokaz nosivosti na proboj temelja

BETON

C 30/37

$\tau_{rd} = 0,34 \text{ N/mm}^2$

ARMATURA

B 500/550

$f_{yk} = 500 \text{ N/mm}^2$

$\gamma_s = 1,15$

$\phi_x = 2 \%$

$\phi_y = 2 \%$

SILA

$V_{sd} = 2411 \text{ kN}$

$\beta_p = 1$

$\alpha = 90^\circ$

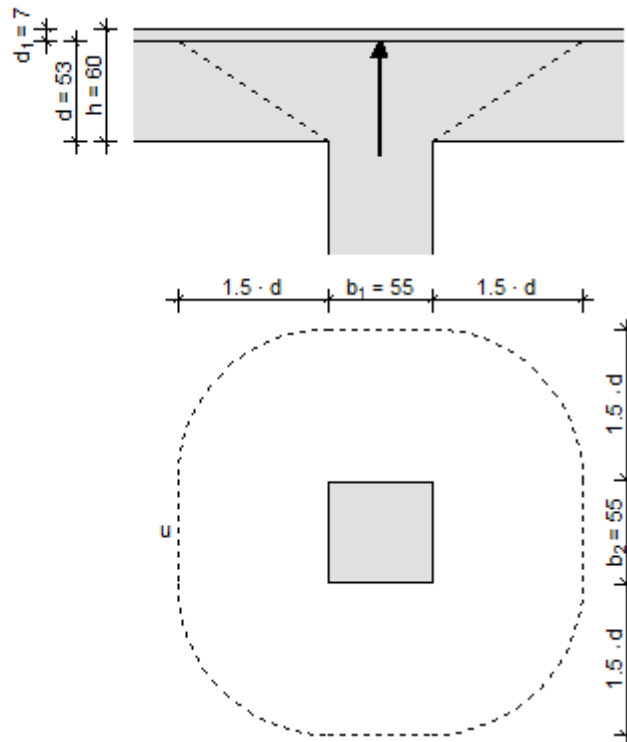

PRORAČUN

$$2 \cdot b_1 + 2 \cdot b_2 = 220 \text{ cm} \leq 11 \cdot d = 583 \text{ cm}$$

$$b_1/b_2 = 1$$

$$0.5 < b_1/b_2 < 2.0$$

$$u_{cr} = 2 \cdot (d_1 + d_2) + 2 \cdot (1.5 \cdot d) \cdot \pi = 719,5 \text{ cm}$$

$$v_{sd} = V_{sd} \cdot \frac{\beta_p}{u_{cr}} = \mathbf{3,35 \text{ kN/cm}}$$

$$k = 1.6 - d \geq 1 = 1,07$$

$$\rho_e = \sqrt{\rho_x \cdot \rho_y} = 2 \%$$

$$0.5\% \leq \rho_e \leq 1.5\% \Rightarrow \rho_e = 1,5 \%$$

$$v_{Rd1} = \tau_{Rd} \cdot k \cdot (1.2 + 40 \cdot \rho_e) \cdot d = \mathbf{3,47 \text{ kN/cm}}$$

$$v_{sd} \leq v_{Rd1}$$

\Rightarrow NIJE POTREBNA JE DODATNA ARMATURA

$$A_{s1,min} = 17,22 \text{ cm}^2$$

Visina temelja je povećana: $h=60 \text{ cm}$

Odabrana armatura: $16\Phi 12$ ($A_s=18,09 \text{ cm}^2$) cijeli temelj

14.2.4 Temelj stupa SP 4

Dimenzije temelja samca:

$$B=2,8\text{m}; h=0,5\text{m}$$

Težina temelja:

$$W = B^2 \cdot h \cdot \gamma_{bet} \text{ (kN)}$$

Opterećenja za dokaz nosivosti tla:

Osnovna kombinacija		Potresna kombinacija	
N_{\max}	M_x	N_{\max}	M_x
(kN/m')	(kNm/m')	(kN/m')	(kNm/m')
3198,2	296,38	1658	126,4

Dokaz naprezanja na kontaktu temelj-temeljno tlo

-Dokaz naprezanja za maksimalnu kombinaciju

kombinaciju

$$\sigma_{1,2} = \frac{3198,2}{7,84} \pm \frac{296,38}{3,65}$$

$$\sigma_1 = \frac{3198,2}{7,84} + \frac{296,38}{3,65} = 489,13 \text{ kPa} < \sigma_{dop}$$

$$\sigma_2 = \frac{3198,2}{7,84} - \frac{296,38}{3,65} = 326,73 \text{ kPa} < \sigma_{dop}$$

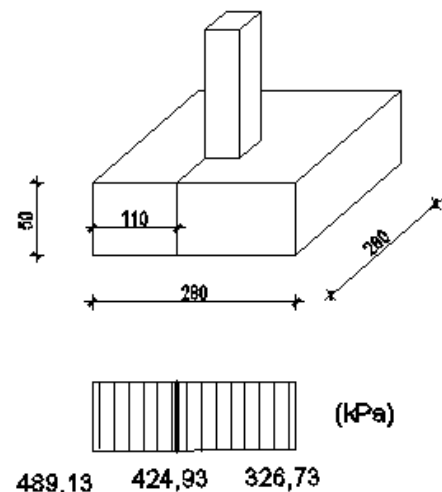

Dimenzioniranje temelja:

Vrijednosti momenta savijanja u kritičnom presjeku:

$$M_{Ed} = \left((489,13 - 424,93) \cdot 1,1 \cdot \frac{1}{2} \right) \cdot \frac{2}{3} \cdot 1,1 + (424,93 \cdot 1,1) \cdot \frac{1}{2} \cdot 1,1 = 282,97 \text{ kNm} / \text{m}'$$

$$B=2,8\text{m}; h=0,5\text{m}; d=43\text{cm}$$

$$A_{s1} = \frac{M_{sd}}{\zeta \cdot d \cdot f_{yd}} = \frac{282,97 \cdot 100}{0,9 \cdot 43 \cdot 43,48} = 16,82 \text{ cm}^2$$

$$A_{s1,\min} = 15,65 \text{ cm}^2$$

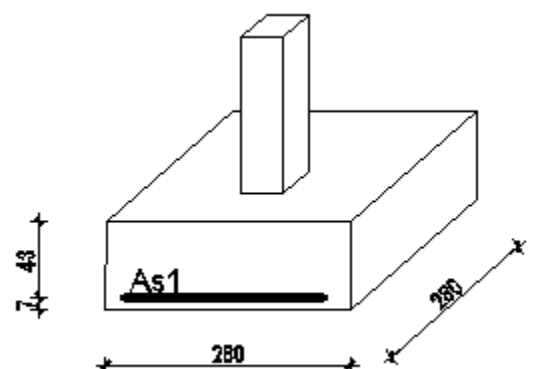

14.2.4.1 Dokaz nosivosti na proboj temelja

BETON

C 30/37

 $\tau_{rd} = 0,34 \text{ N/mm}^2$

ARMATURA

B 500/550

 $f_{yk} = 500 \text{ N/mm}^2$ $\gamma_s = 1,15$ $\phi_x = 2 \%$ $\phi_y = 2 \%$

SILA

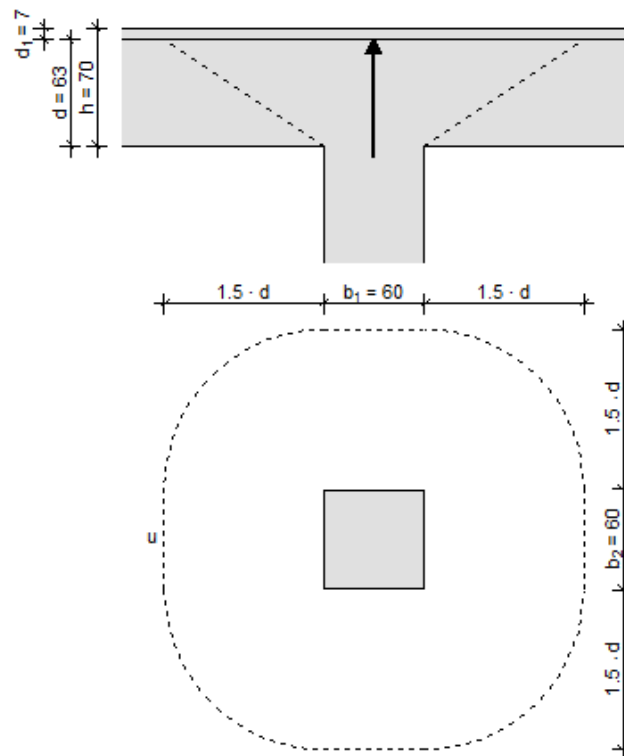
 $V_{sd} = 3198,2 \text{ kN}$ $\beta_p = 1$ $\alpha = 90^\circ$ 

PRORAČUN

$$2 \cdot b_1 + 2 \cdot b_2 = 240 \text{ cm} \leq 11 \cdot d = 693 \text{ cm}$$

$$b_1/b_2 = 1$$

$$0.5 < b_1/b_2 < 2.0$$

$$u_{cr} = 2 \cdot (d_1 + d_2) + 2 \cdot (1.5 \cdot d) \cdot \pi = 833,8 \text{ cm}$$

$$v_{Sd} = V_{Sd} \cdot \frac{\beta_p}{u_{cr}} = \mathbf{3,84 \text{ kN/cm}}$$

$$k = 1.6 - d \geq 1 = 1,00$$

$$\rho_e = \sqrt{\rho_x \cdot \rho_y} = 2 \%$$

$$0.5\% \leq \rho_e \leq 1.5\% \Rightarrow \rho_e = 1,5 \%$$

$$v_{Rd1} = \tau_{Rd} \cdot k \cdot (1.2 + 40 \cdot \rho_e) \cdot d = \mathbf{3,86 \text{ kN/cm}}$$

$$v_{Sd} \leq v_{Rd1}$$

\Rightarrow NIJE POTREBNA JE DODATNA ARMATURA

Visina temelja je povećana na $h=70\text{cm}$.

$$A_{s1,\min} = 25,48 \text{ cm}^2$$

Odabrana armatura: $23\Phi 12$ ($A_s=26,01\text{cm}^2$)

14.2.5 Temelji stupova S3, S7, S9, S11 i S12

Dimenzije temelja samca:

$$B=2,8\text{m}; h=0,5\text{m}$$

Težina temelja:

$$W = B^2 \cdot h \cdot \gamma_{bet} \text{ (kN)}$$

Opterećenja za dokaz nosivosti tla:

Osnovna kombinacija		Potresna kombinacija	
N_{\max}	M_x	N_{\max}	M_x
(kN/m')	(kNm/m')	(kN/m')	(kNm/m')
2374,4	613,36	1225,8	603,14

Dokaz naprezanja na kontaktu temelj-temeljno tlo

-Dokaz naprezanja za maksimalnu kombinaciju

$$\sigma_{1,2} = \frac{2374,4}{7,84} \pm \frac{613,36}{3,65}$$

$$\sigma_1 = \frac{2374,4}{7,84} + \frac{603,36}{3,65} = 470,88 \text{ kPa} < \sigma_{dop}$$

$$\sigma_2 = \frac{2374,4}{7,84} - \frac{613,36}{3,65} = 134,83 \text{ kPa} < \sigma_{dop}$$

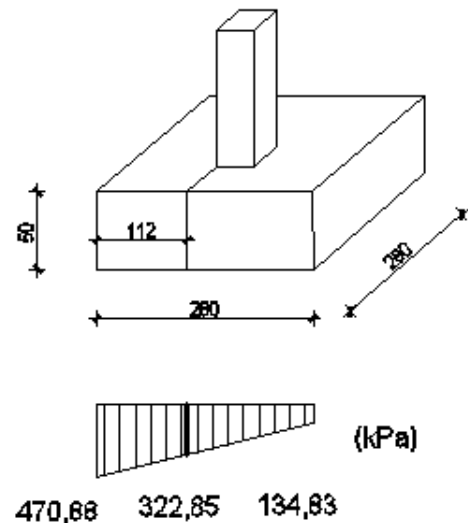

Dimenzioniranje temelja:

Vrijednosti momenta savijanja u kritičnom presjeku:

$$M_{Ed} = \left((470,88 - 322,85) \cdot 1,12 \cdot \frac{1}{2} \right) \cdot \frac{2}{3} \cdot 1,12 + (322,85 \cdot 1,12) \cdot \frac{1}{2} \cdot 1,12 = 264,4 \text{ kNm/m'}$$

$$B=2,8\text{m}; h=0,5\text{m}; d=43\text{cm}$$

$$A_{s1} = \frac{M_{sd}}{\zeta \cdot d \cdot f_{yd}} = \frac{264,4 \cdot 100}{0,9 \cdot 43 \cdot 43,48} = 15,7 \text{ cm}^2$$

$$A_{s1,\min} = 15,65 \text{ cm}^2$$

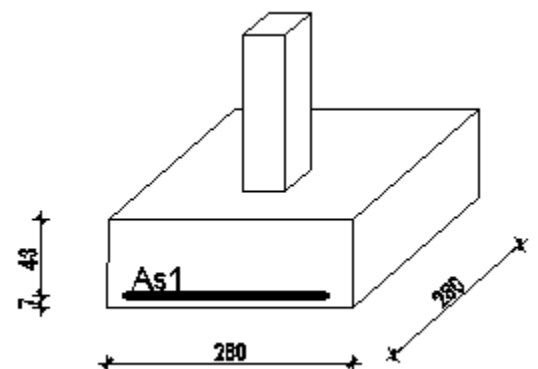

14.2.5.1 Dokaz nosivosti na proboj temelja

BETON

C 30/37

$$\tau_{rd} = 0,34 \text{ N/mm}^2$$

ARMATURA

B 500/550

$$f_{yk} = 500 \text{ N/mm}^2$$

$$\gamma_s = 1,15$$

$$\phi_x = 2 \%$$

$$\phi_y = 2 \%$$

SILA

$$V_{sd} = 2374,4 \text{ kN}$$

$$\beta_p = 1$$

$$\alpha = 90^\circ$$

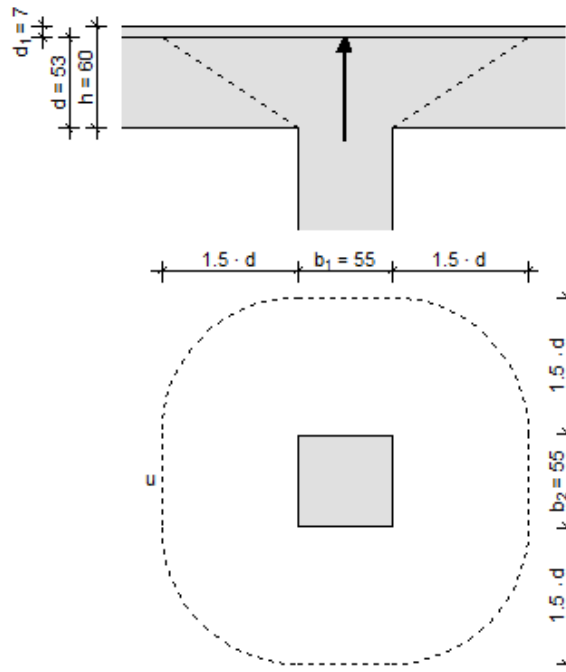

PRORAČUN

$$2 \cdot b_1 + 2 \cdot b_2 = 220 \text{ cm} \leq 11 \cdot d = 583 \text{ cm}$$

$$b_1/b_2 = 1$$

$$0.5 < b_1/b_2 < 2.0$$

$$u_{cr} = 2 \cdot (d_1 + d_2) + 2 \cdot (1.5 \cdot d) \cdot \pi = 719,5 \text{ cm}$$

$$V_{Sd} = V_{Sd} \cdot \frac{\beta_p}{u_{cr}} = 3,3 \text{ kN/cm}$$

$$k = 1.6 - d \geq 1 = 1,07$$

$$\rho_e = \sqrt{\rho_x \cdot \rho_y} = 2 \%$$

$$0.5\% \leq \rho_e \leq 1.5\% \Rightarrow \rho_e = 1,5 \%$$

$$V_{Rd1} = \tau_{Rd} \cdot k \cdot (1.2 + 40 \cdot \rho_e) \cdot d = 3,47 \text{ kN/cm}$$

$$V_{Sd} \leq V_{Rd1}$$

⇒ NIJE POTREBNA JE DODATNA ARMATURA

Visina temelja je povećana na $h=60\text{cm}$.

$$A_{s1,\min} = 21,84 \text{ cm}^2$$

Odabrana armatura: $20\Phi 12$ ($A_s=22,61\text{cm}^2$) $\rightarrow 7 \Phi 12/\text{m}'$

15. GRAFIČKI PRILOZI

LITERATURA:

- [1] J. Radić i suradnici: Betonske konstrukcije-priručnik.
- [2] Radnić J., Harapin A. OSNOVE BETONSKIH KONSTRUKCIJA-Interna skripta, Split, 2007.
- [3] Tomičić, I. BETONSKE KONSTRUKCIJE, treće izmijenjeno i dopunjeno izdanje, Zagreb, 1996.
- [4] Harapin, A. DIMENZIONIRANJE BETONSKIH KONSTRUKCIJA PREMA TPBK (EC2)
- [5] EN 1992 Eurokod 2, Proračun betonskih konstrukcija, CEN-Belgija 2004.
- [6] EN 1998 Eurokod 8, Projektiranje konstrukcija na potresno opterećenje, CEN-Belgija, 2004.

PRESEK A-A - od osovina

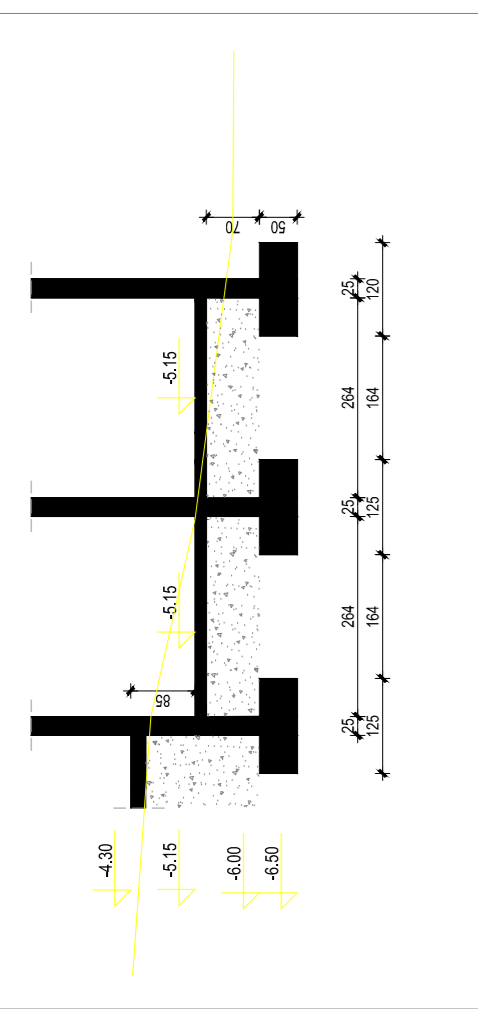

PRESEK B-B

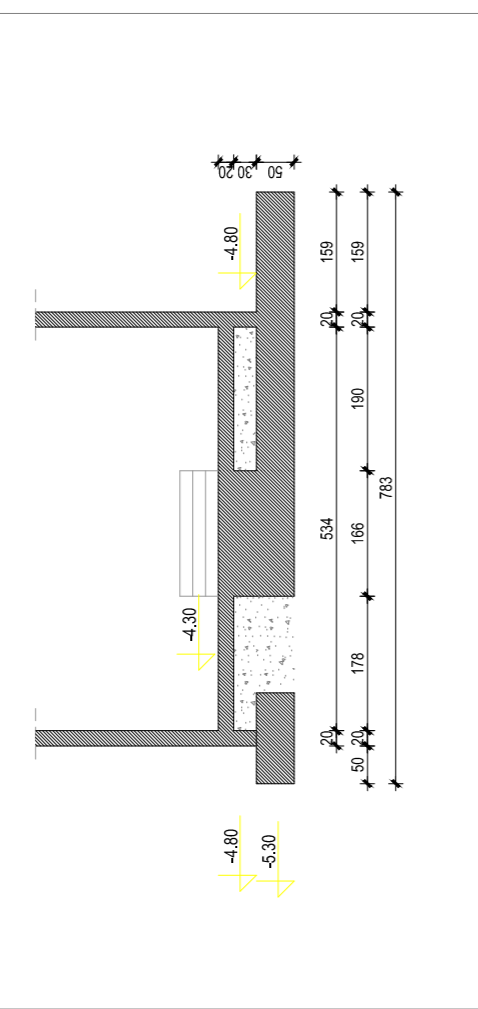

PRESEK C-C

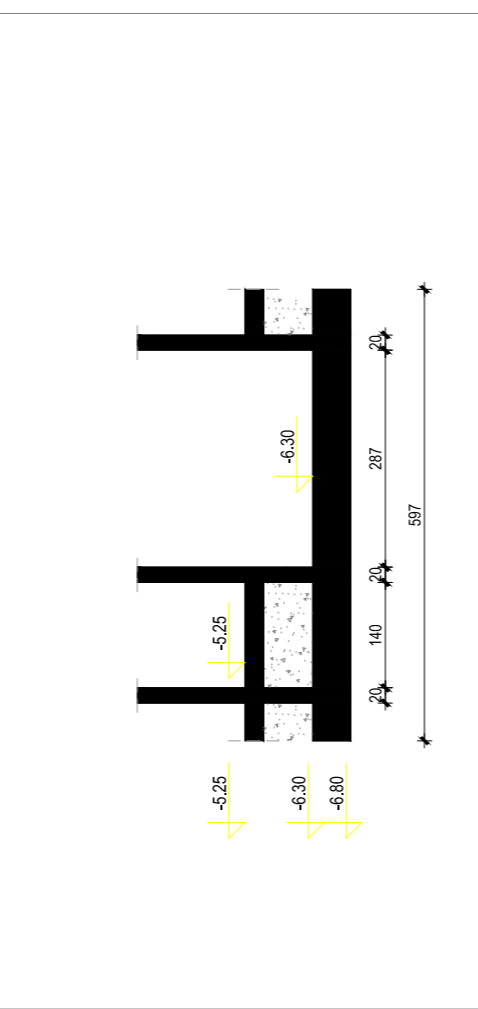

PRESEK D-D

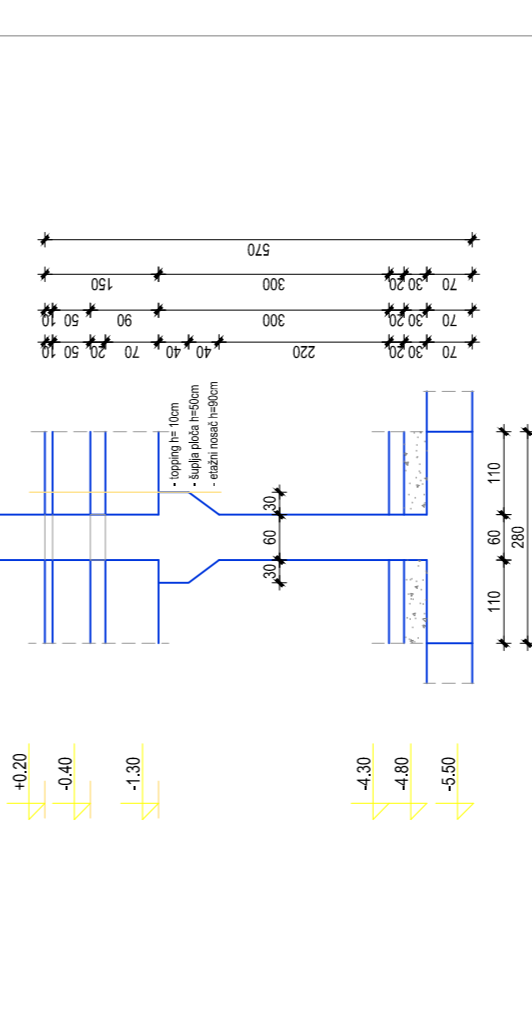

DIPLOMSKI RAD

GRAĐEVINA: **Trgovački centar u Trogiru**

VRSTA PROJEKTA: **Projekt konstrukcije**

REDAKCIJSKI PROJEKAT: **Glavni projekt**

SADRŽAJ: **PLAN POZICIJA 00**

PROJEKTANT: **Gabrijele Grozdanic**

MENTOR: **Prof. dr. sc. Alen Harapin**

BRUIR/PROJEKTA: **15.1**

STADIJUM: **1:100**

DATA: **rijanj 2016.**

OSNOVNA DOKUMENTACIJA: **TC_gradwg**

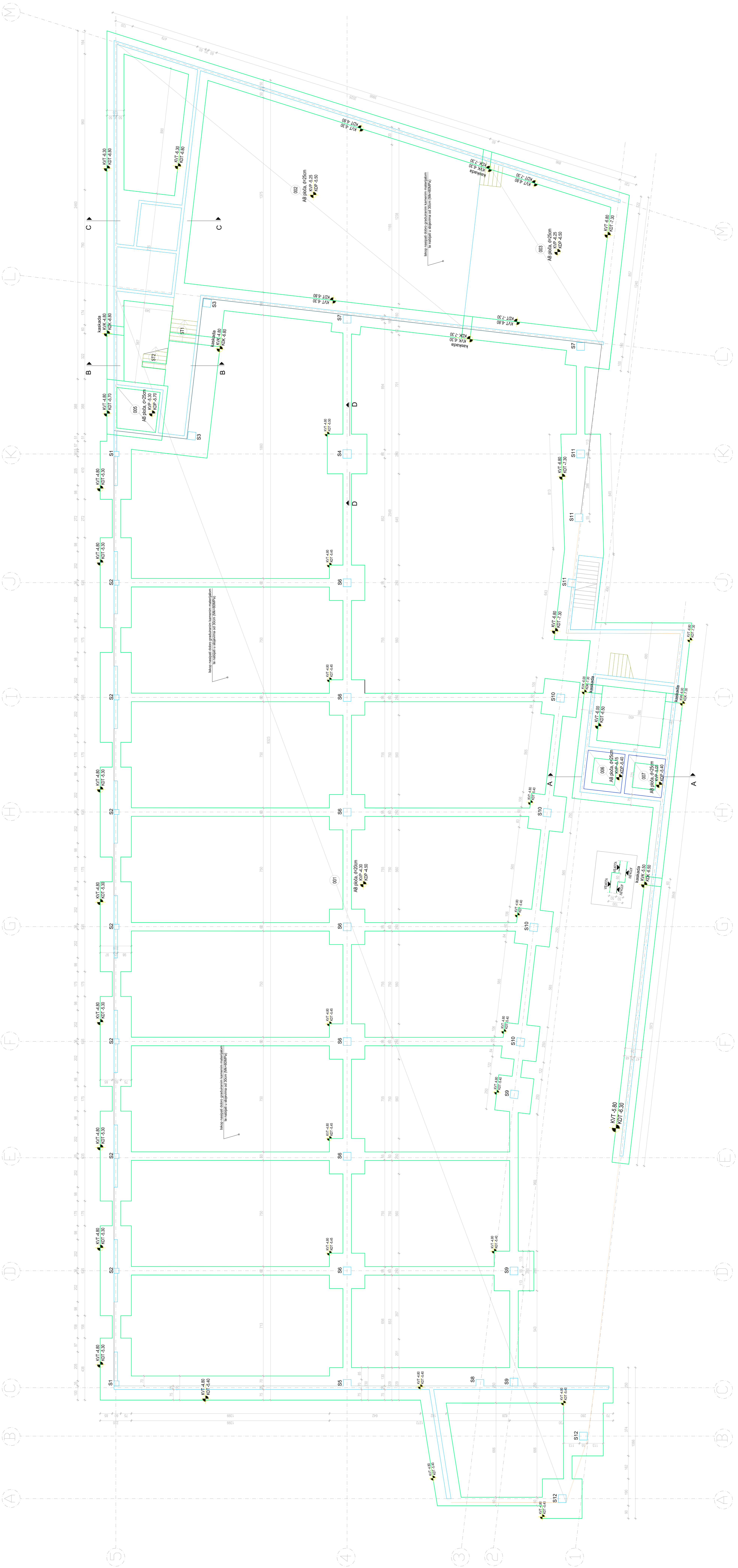

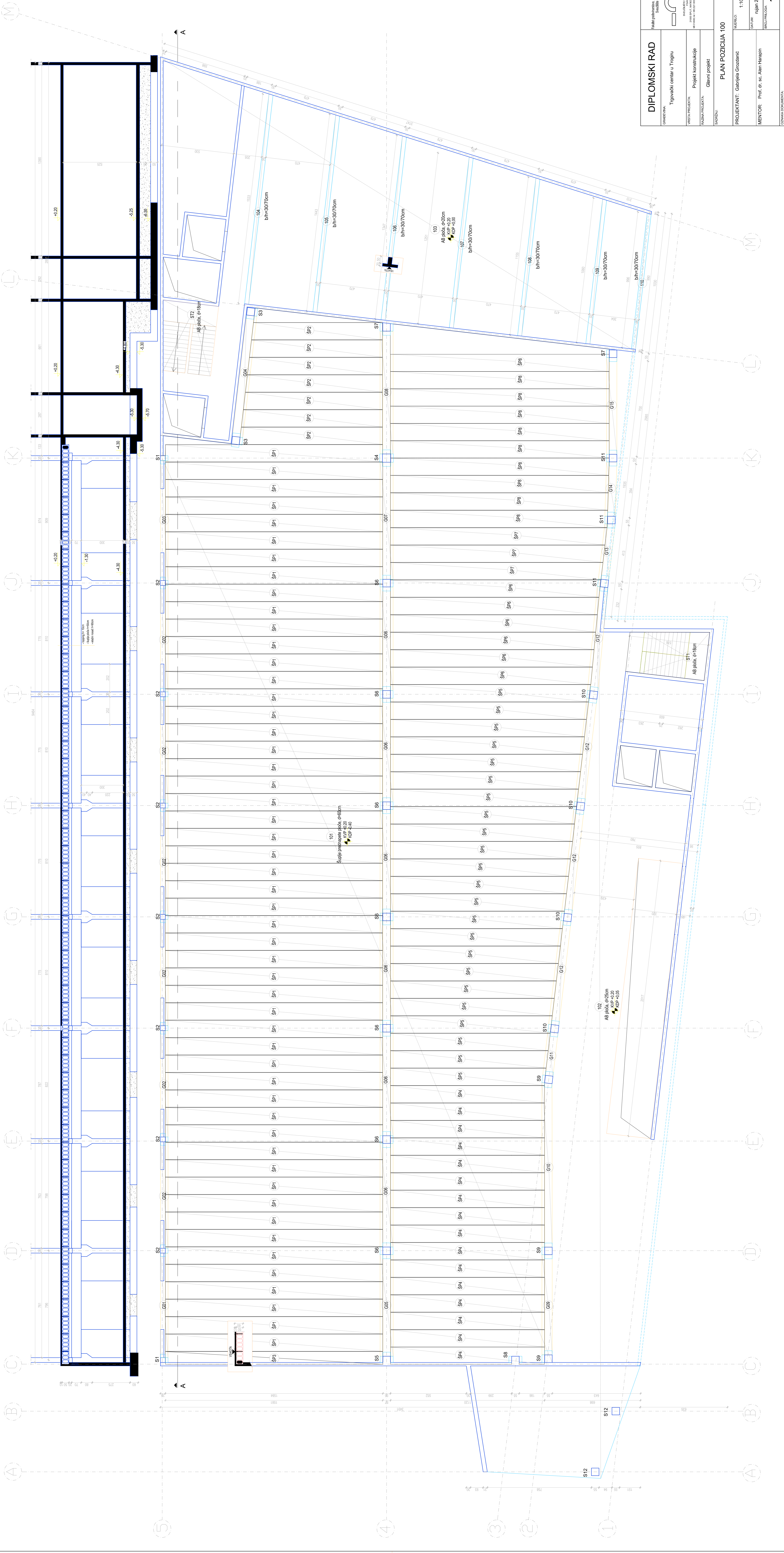

DIPLOMSKI RAD
 GRAĐEVINA: Trgovski centar u Trojgu
 VRSTA PROJEKTA: Projekt konstrukcije
 RAZINA PROJEKTA: Glavni projekt





PROJEKTANT: Gabrijela Grozdanić
 MENTOR: Prof. dr. sc. Alen Harežin

BRZINA PLOŠTA: 1:100
 DATUM: rujin 2016.
 BRZINA PLOŠTA: 15.2

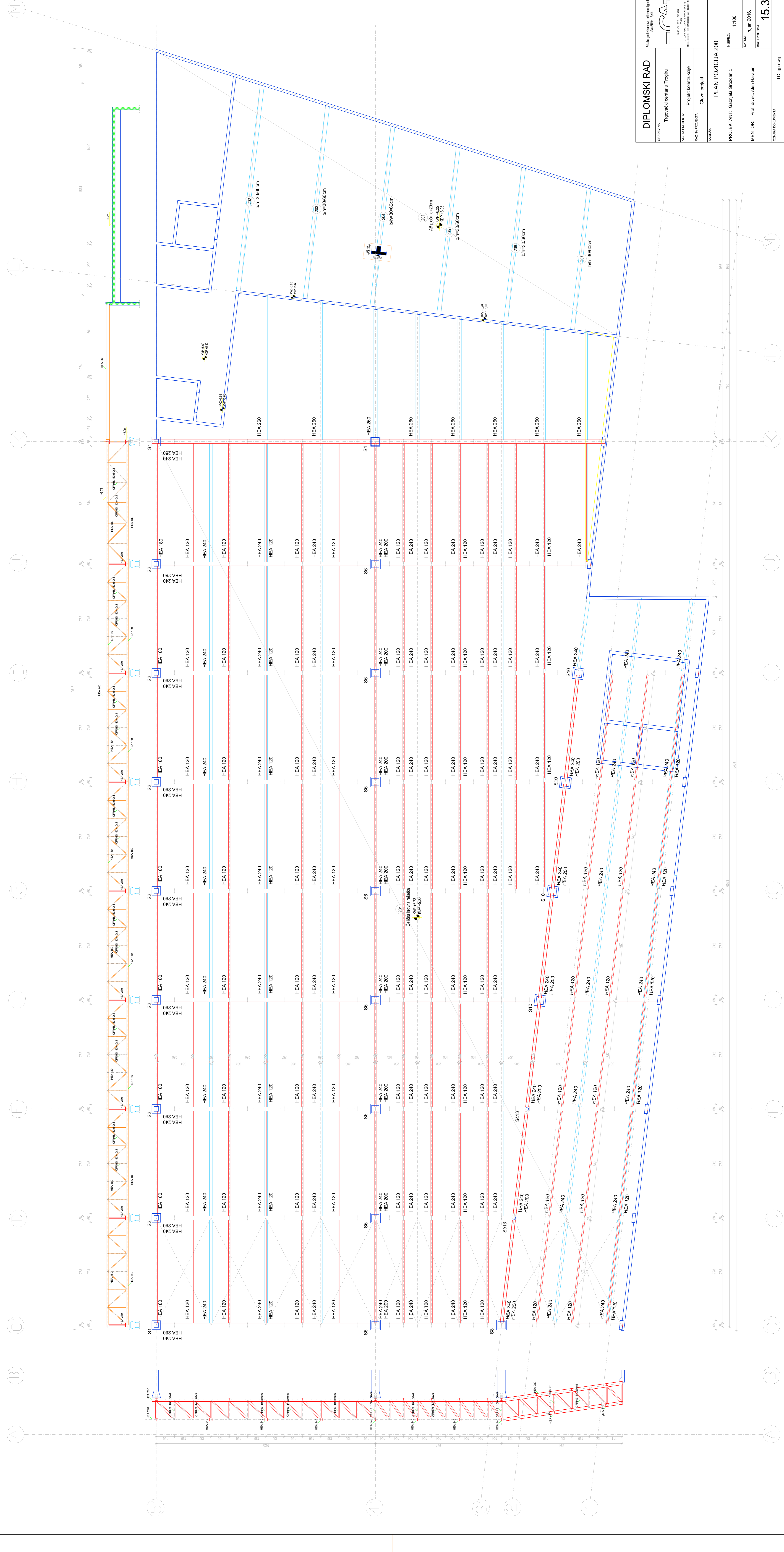
PLAN POZICIJA 100

TC_grd.dwg



DIPLOMSKI RAD		Plan građevine u sklopu projekta Sadržaj: 158	
GRAĐEVINA Trgovski centar u Trojnu			
VJEŠTA PROJEKTA Projekt konstrukcije			
NAZIV PROJEKTA Glavni projekt			
SADRŽAJ PLAN POZICIJA 200			
PROJEKTANT: Gabrijela Gvozdenić		Mjerna: 1:100	
MENTOR: Prof. dr. sc. Alan Haračin		Datum: rujin 2016.	
Crtana dokumenta		Broj ploha: 15.3	
		TC_gpr.dwg	

Tlocrt objekta
M 1:400

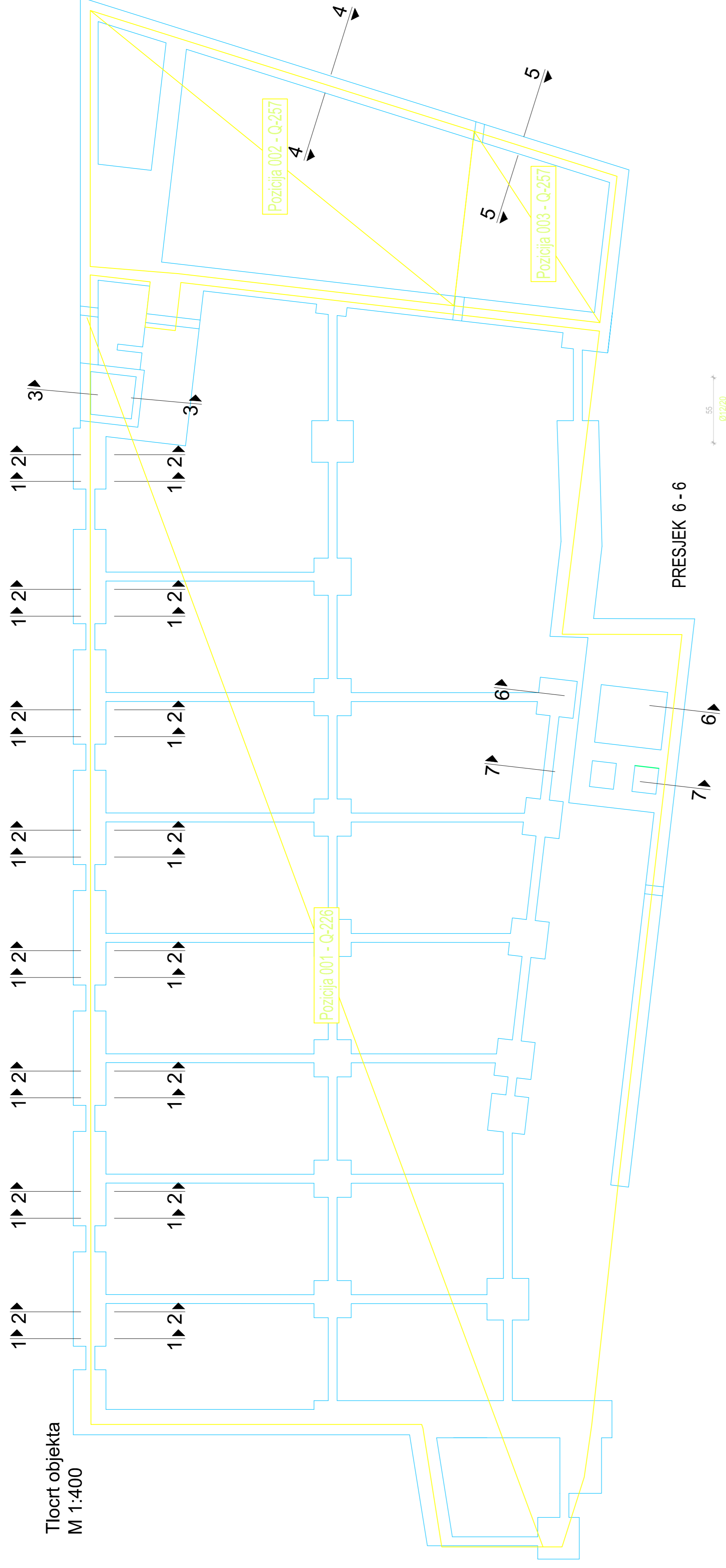

PRESJEK 1 - 1

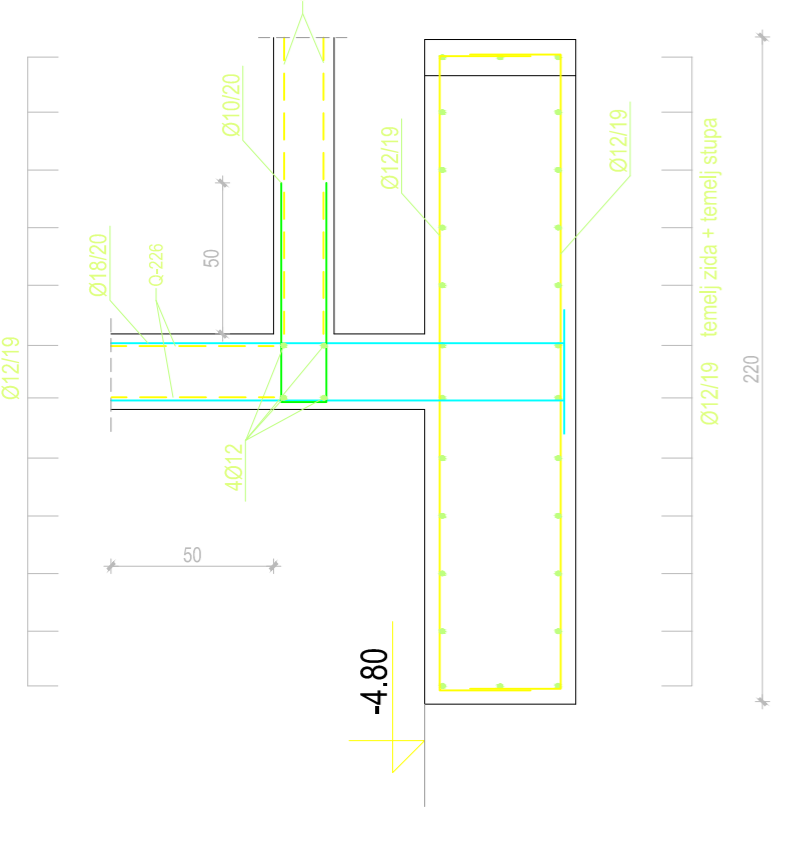

PRESJEK 2 - 2

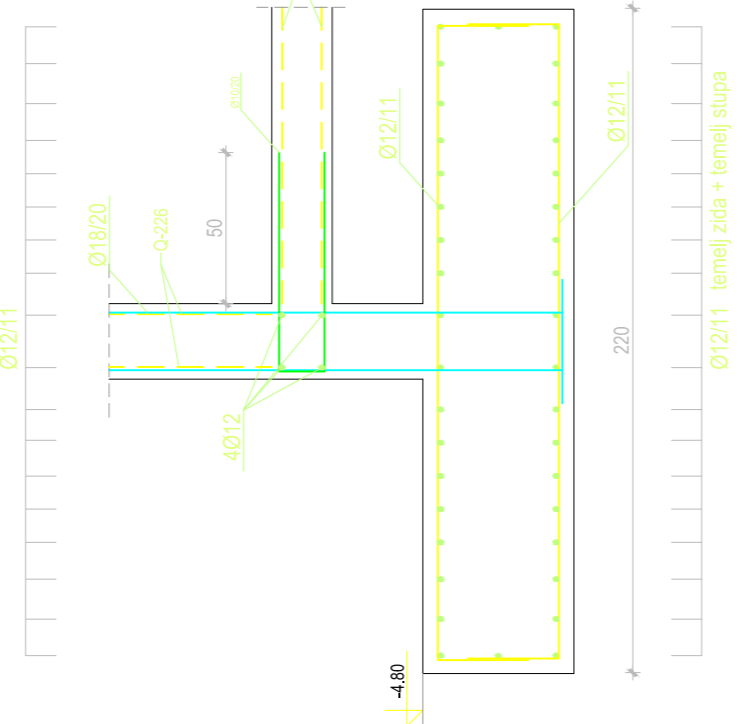

PRESJEK 6 - 6

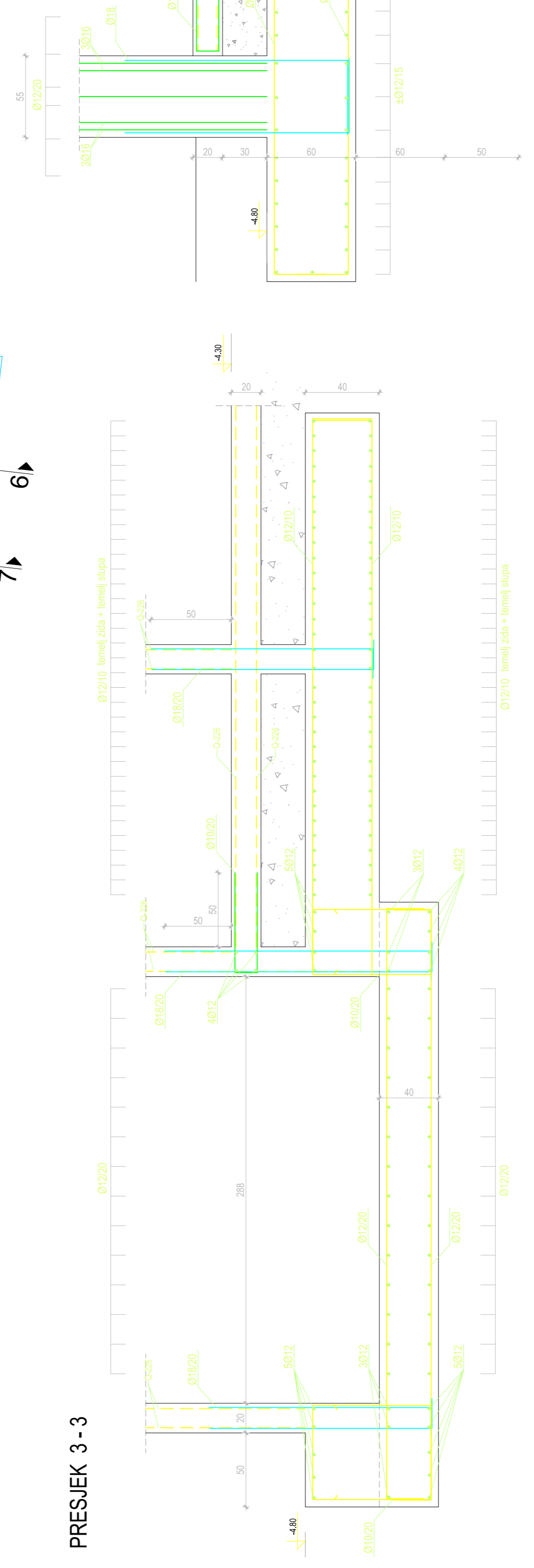

PRESJEK 3 - 3

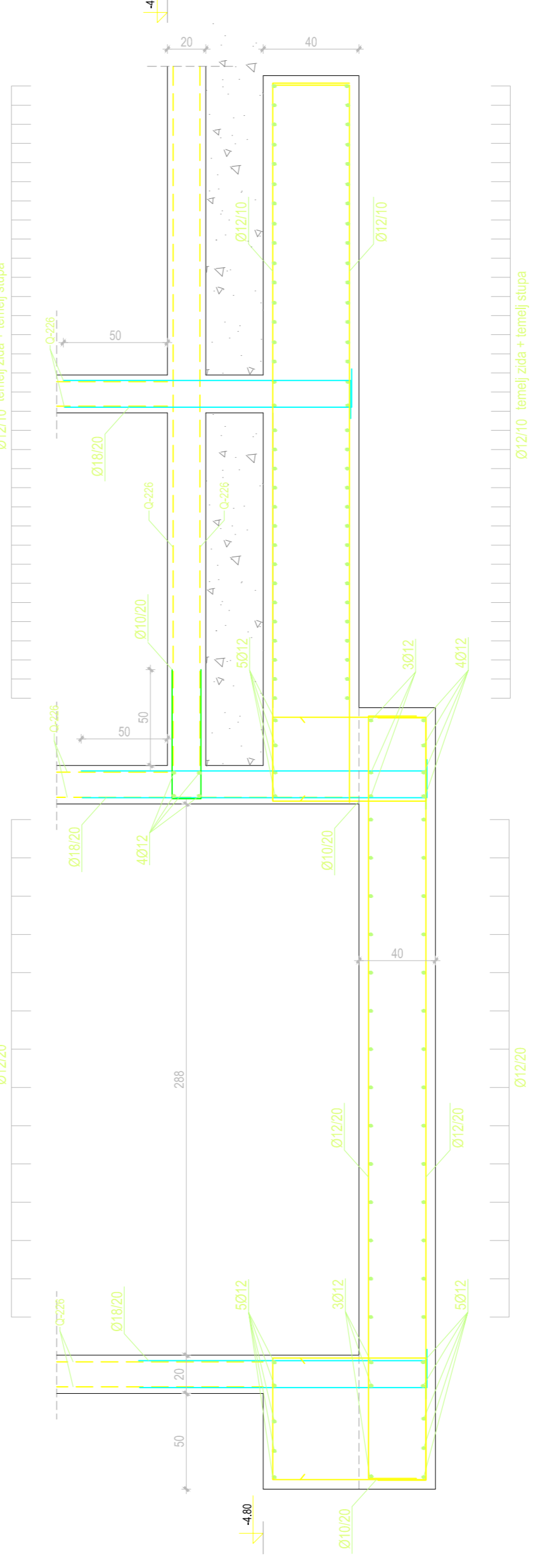

PRESJEK 7 - 7

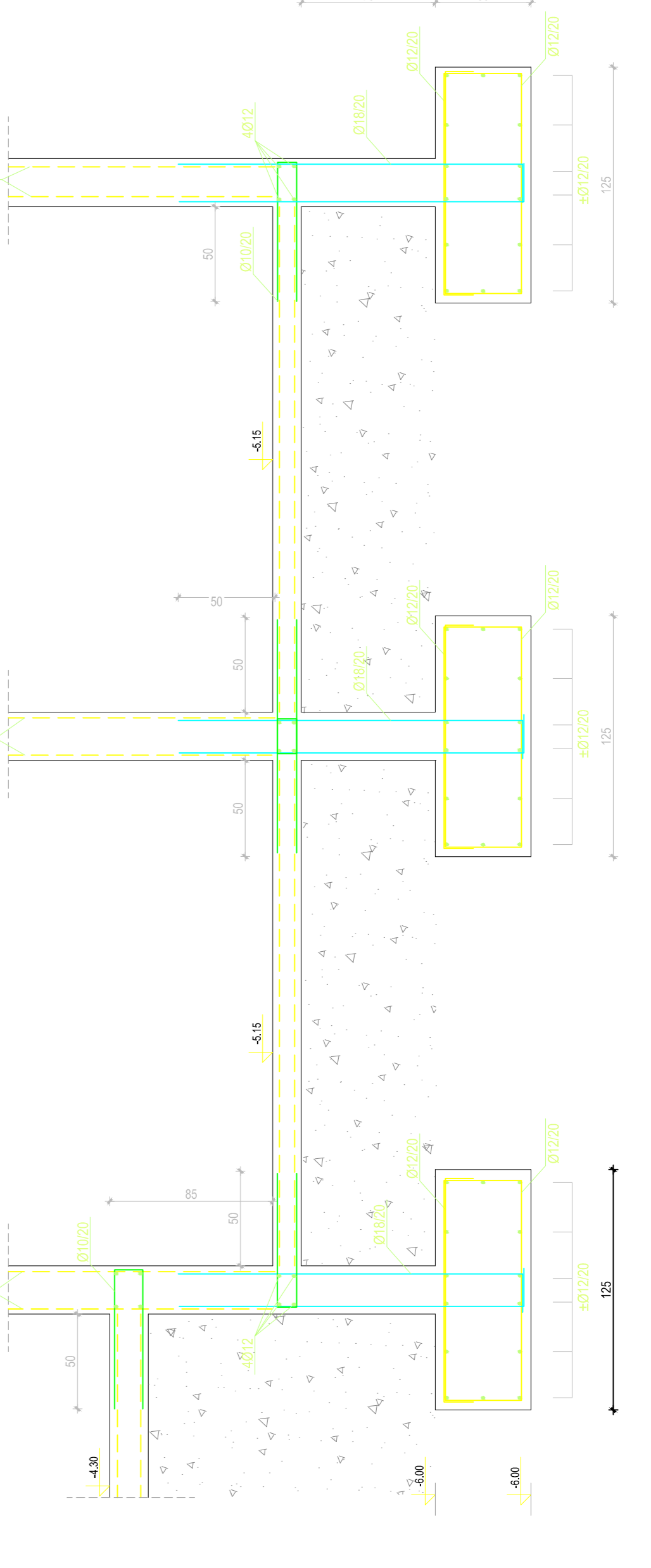

PRESJEK 5 - 5

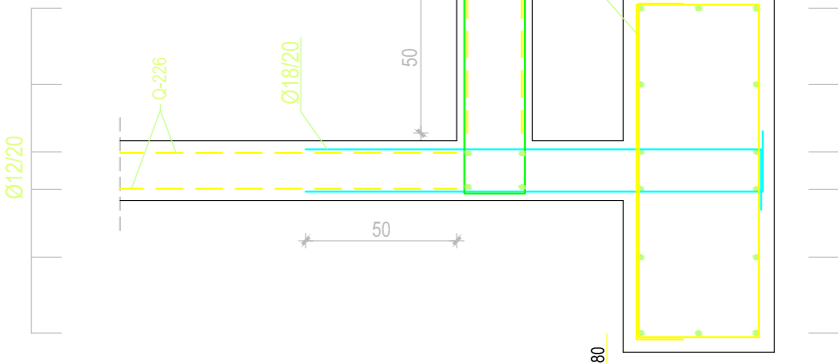

PRESJEK 4 - 4

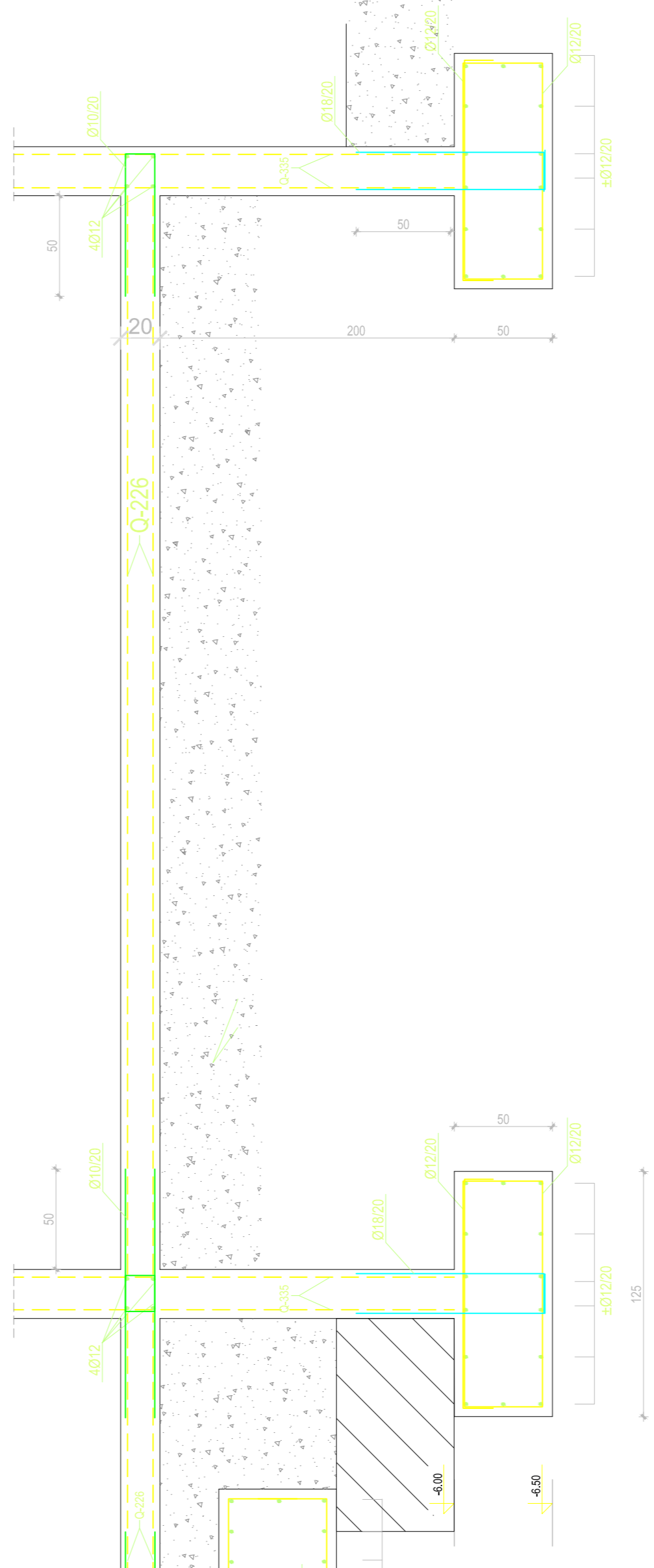
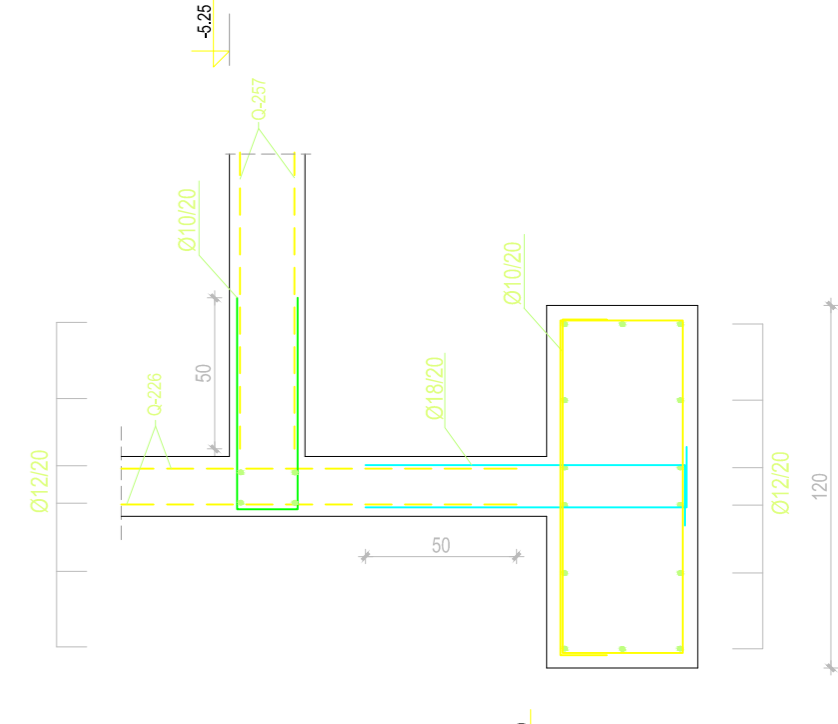

NAPOМЕНЕ:
- beton C30/37
- armatura B500B
- zaštita od korozije c=5 cm

DIPLOMSKI RAD

GRAĐEVINA: Trgovački centar u Trogiru

VRESTA PROJEKTA: Projekt konstrukcije

RAZINA PROJEKTA: Glavni projekt

SARUŽAJ: ARMATURA TEMELJA I PODNE PLOČE

PROJEKTANT: Gabrijela Grozdanić

MENTOR: Prof. dr. sc. Alan Harapin

MJERILO: 1:25

DATUM: rujan 2016.

BROJ PLOČICA: 15.4

OSNAKKA DOKUMENTA: TC_gp.dwg

Fakultet građevinarstva, arhitekture i geodezije
Sveučilište u Splitu



Školski list iz područja
ARHITEKTURA I
GRAĐEVINARSTVO
MESTO ZAŠTITE IZ OBLASTI GRAĐEVINARSTVA I
ARHITEKTURE

Tloort objekta
M 1:400

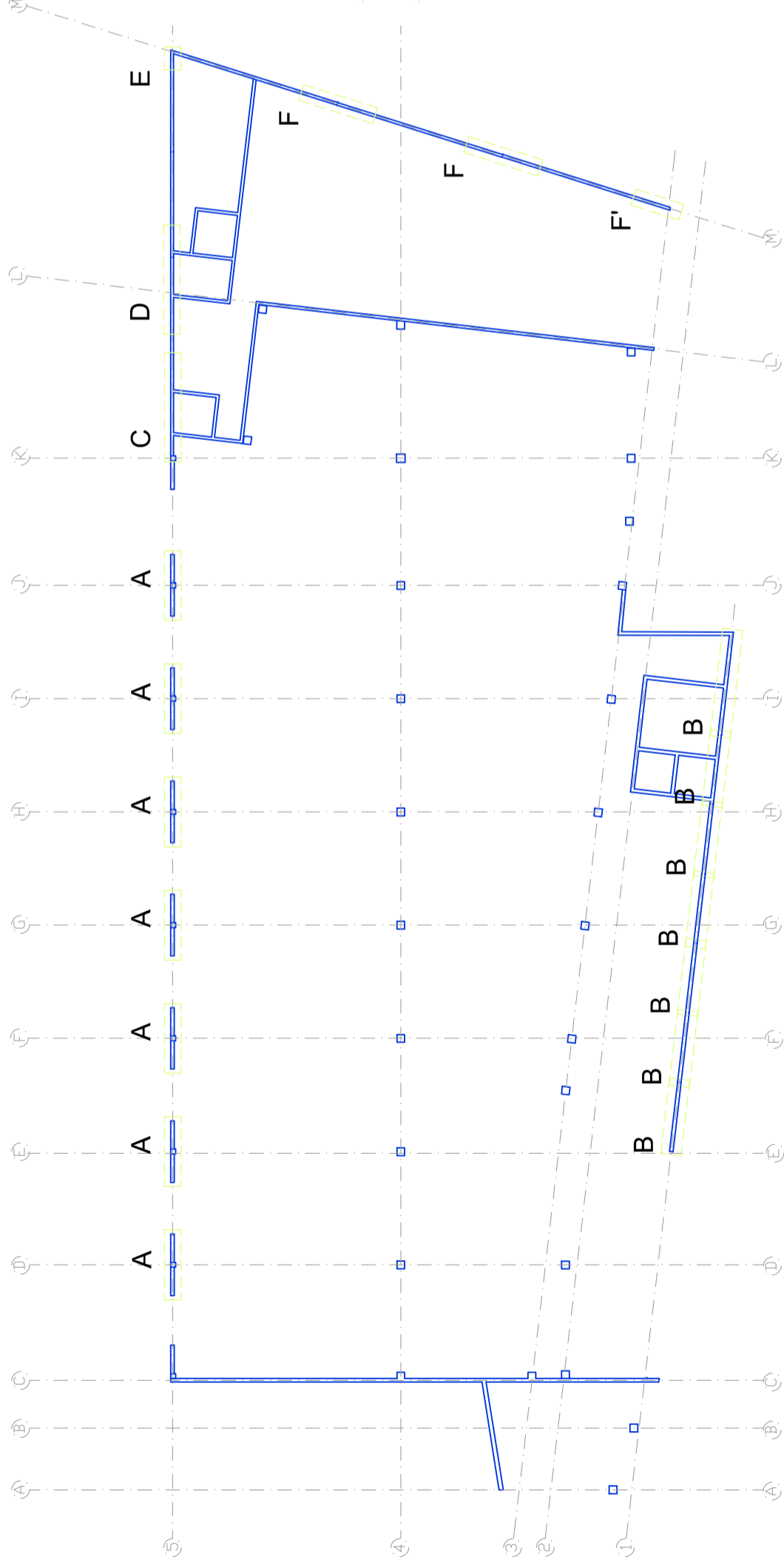

Zid u osi 5 - detalj A
M 1:25

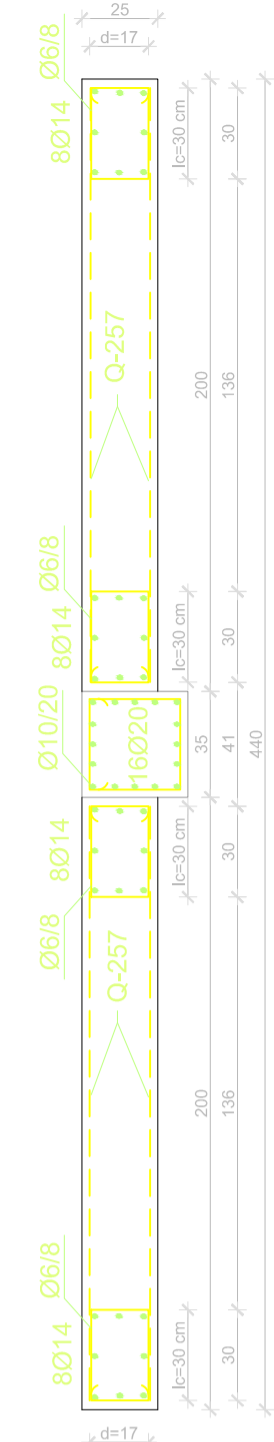

Zid u osi 1 - detalj B
M 1:25

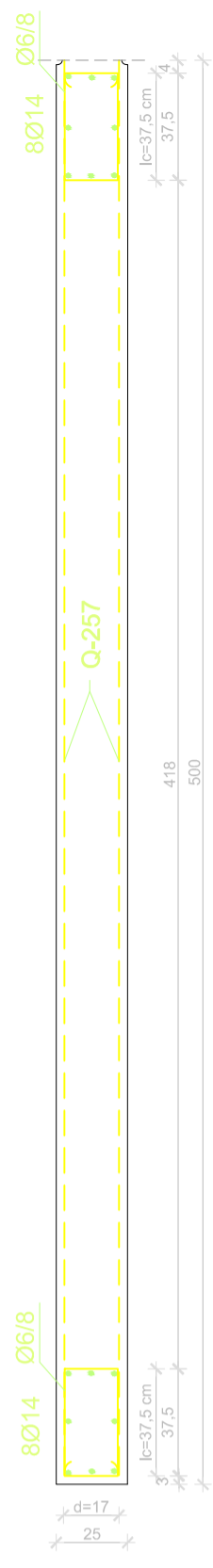

Zid u osi 5 - detalj E
M 1:25

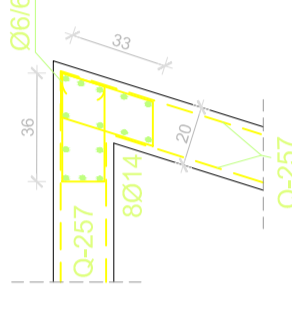

Zid u osi M - detalj F
M 1:25

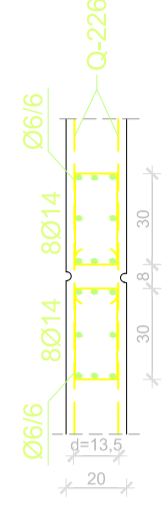

NAPOMENE:
-beton C 30/37
-armatura B500B
-zaštitni sloj zida c=3 cm

Zid u osi 5 - detalj C
M 1:25

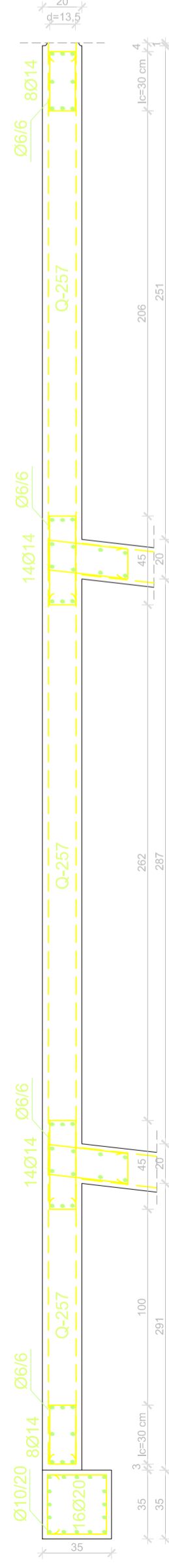

Zid u osi 5 - detalj D
M 1:25

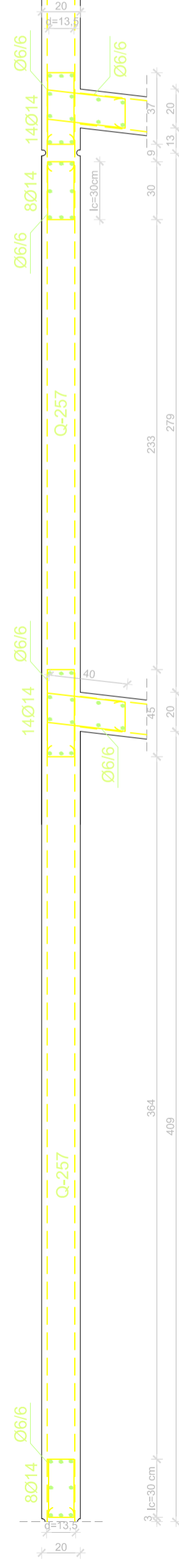

DIPLOMSKI RAD

GRADEVINA:

Trgovački centar u Trogiru

VRSTA PROJEKTA:

Projekt konstrukcije

RAZINA PROJEKTA:

Glavni projekt

SADRŽAJ:

ARMATURA ZIDOVA - DETALJI

PROJEKTANT: Gabrijeła Grozdanić

MJERILO:
1:400
1:25

MENTOR: Prof. dr. sc. Alen Harapin

DATUM:
rujan 2016.

BROJ PRILOGA:

15.5

OZNAKA DOKUMENTA:

TC_gp.dwg

Fakultet građevinarstva, arhitekture i geodezije
Sveučilište u Splitu



SVEUČILIŠTE U SPLITU:
FAG

21000 SPLIT, MATIĆE HRVATSKE 15
MB 3146463; tel.: +385 (0)21 333333; fax: +385 (0)21 465117

Plan oplate M 1:50

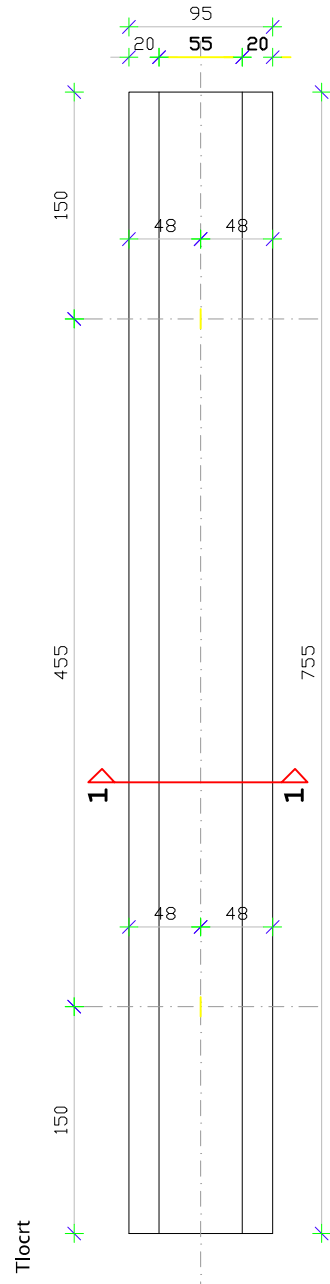
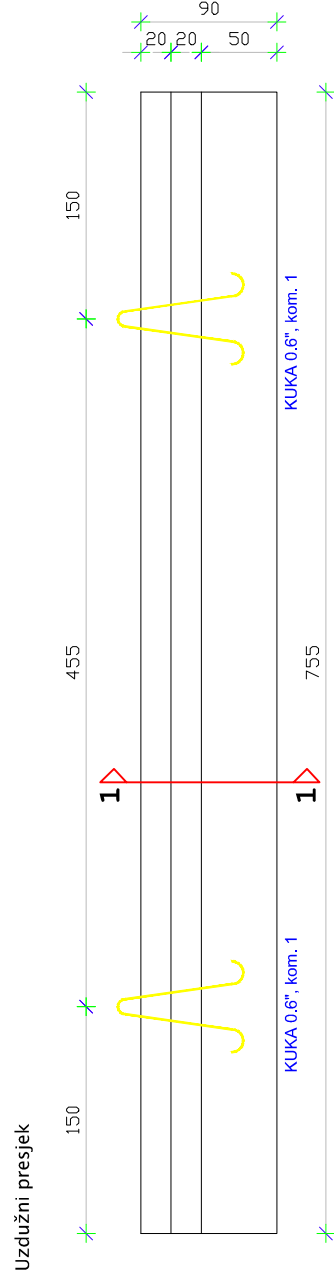

Nacrtna armature M 1:50

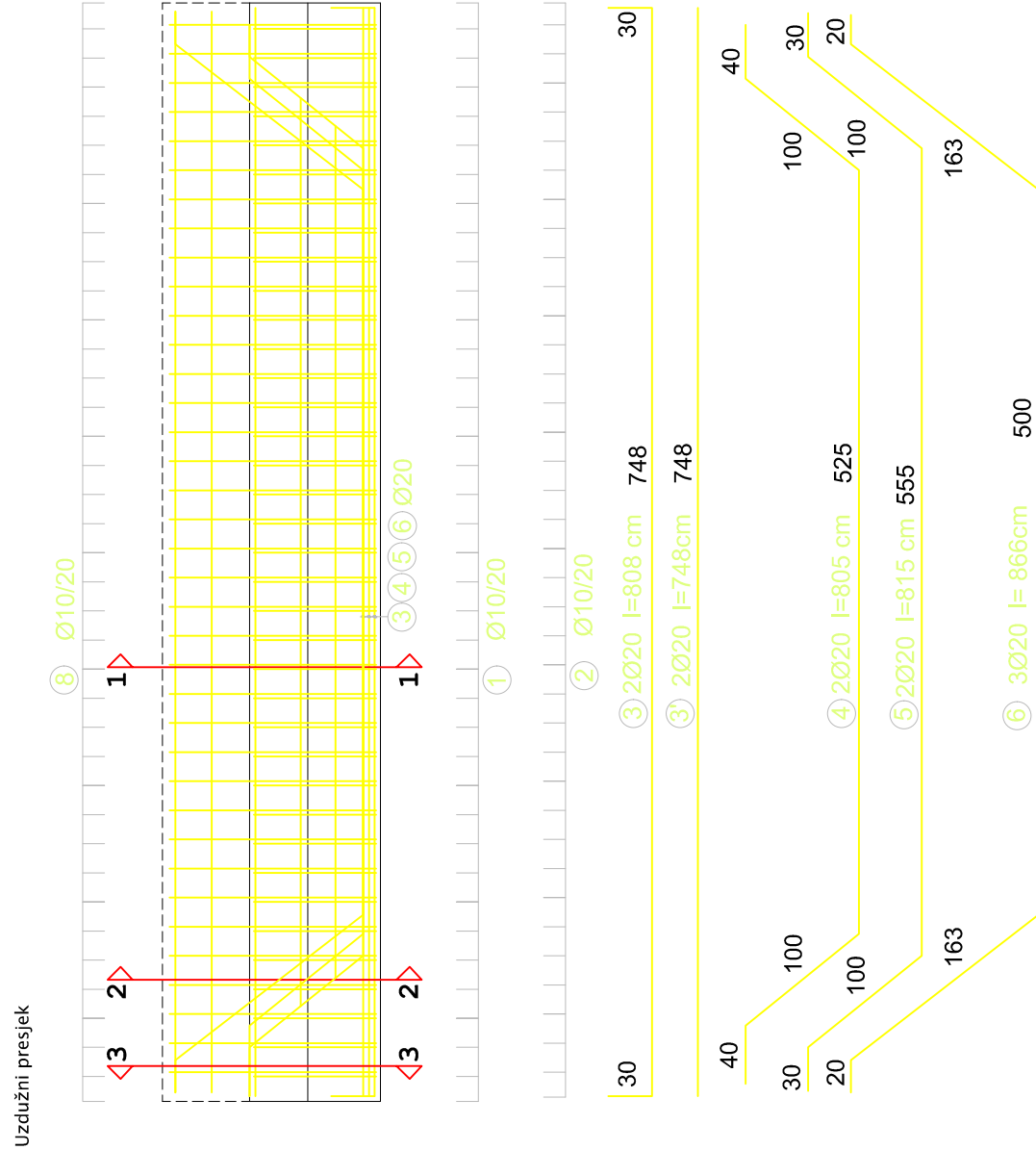

Presjek 1 - 1
M 1:25

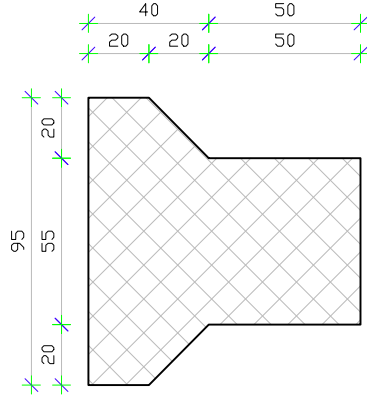

KUKA
kabel 0,6", l=2,05m
kom.2

Presjek 1 - 1
M 1:25

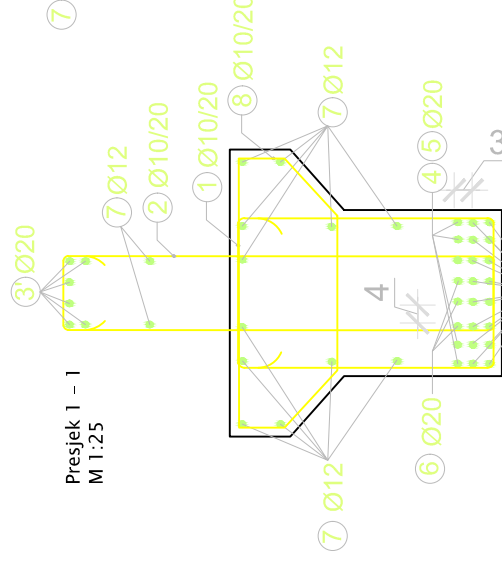

Presjek 2 - 2
M 1:25

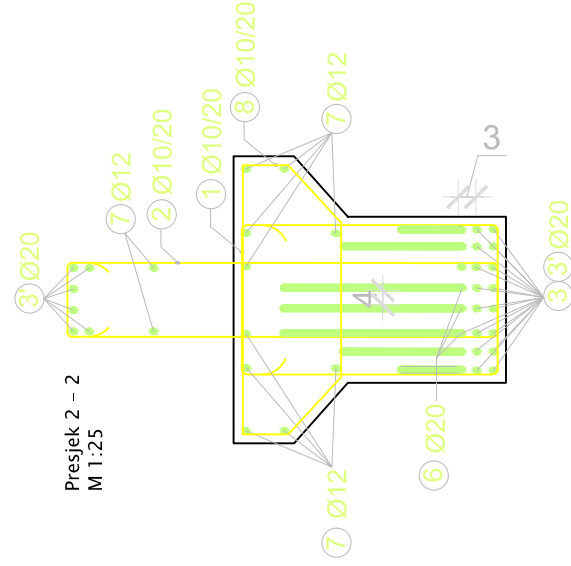

Presjek 3 - 3
M 1:25

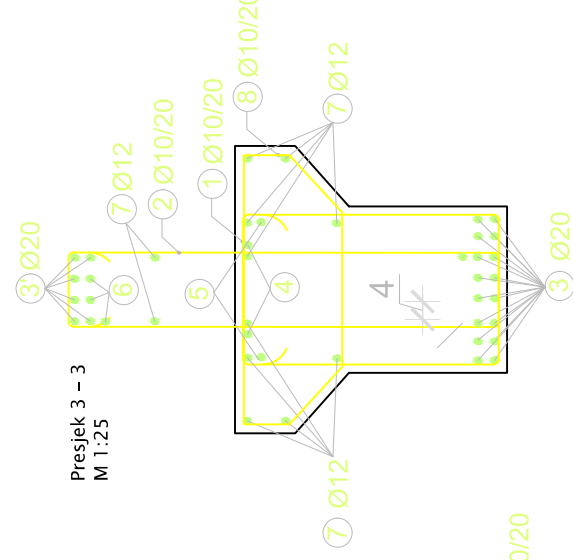

NAPOMENE:

- beton C 50/67
- armatura B500B
- zaštitni sloj c = 3cm
- ukupno betona za 1 element V=4,9 m³
- masa elementa G=13,5 T

Količina:

- greda G5 - 1kom
- greda G6 - 6kom
- greda G7 - 1kom
- greda G8 - 1kom

DIPLOMSKI RAD

GRADEVINA:

Trgovački centar u Trogiru

VRSTA PROJEKTA:

Projekt konstrukcije

RAZINA PROJEKTA:

Glavni projekt

SADRŽAJ:

ARMATURA GREDA G5, G6, G7 i G8

PROJEKTANT: Gabrijela Grozdanić

MJERILO:

1:50
1:25

MENTOR: Prof. dr. sc. Alen Harapin

DATUM:

rujan 2016.

BROJ PRILOGA:

15.6

OZNAKA DOKUMENTA:

TC_gp.dwg

Fakultet građevinarstva, arhitekture i geodezije
Sveučilište u Splitu



SVEUČILIŠTE U SPLITU,
FGAG

21000 SPLIT, MATICE HRVATSKE 15

MB 3149463; tel: + 385 (0)21 303333; fax: + 385 (0)21 465117

Plan oplate M 1:50

Uzdužni presjek

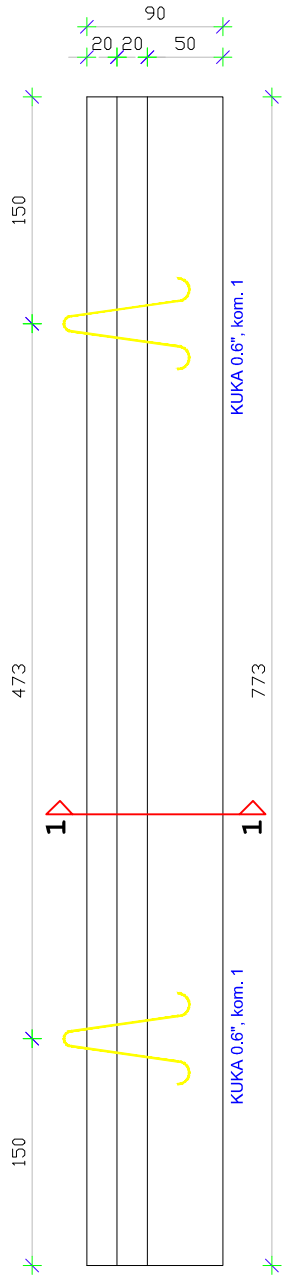

Tlocrt

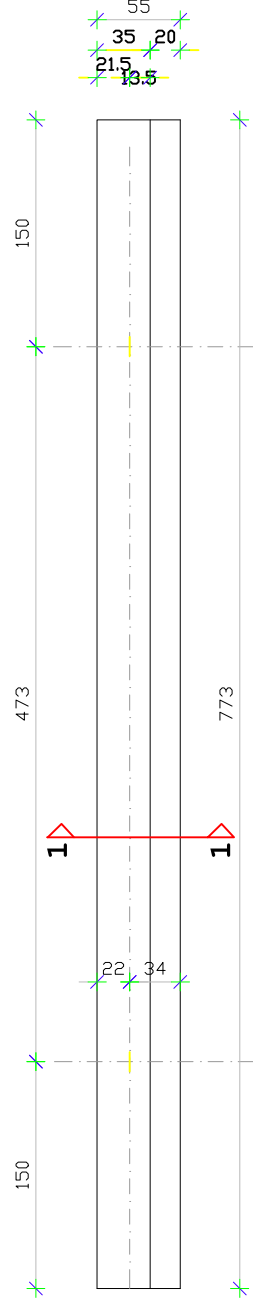

Nacrt armature M 1:50

Uzdužni presjek

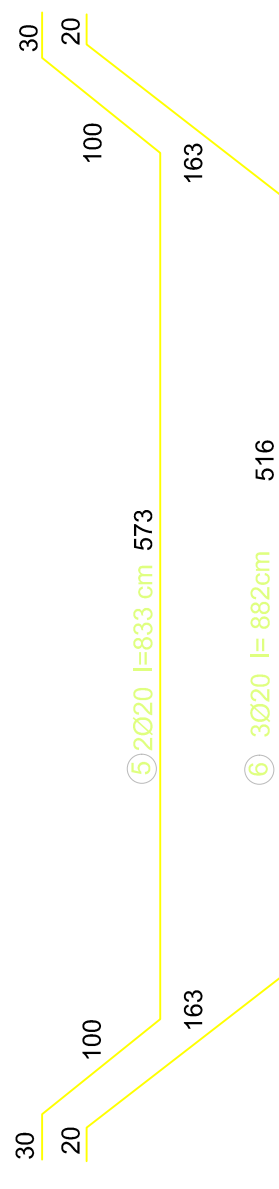
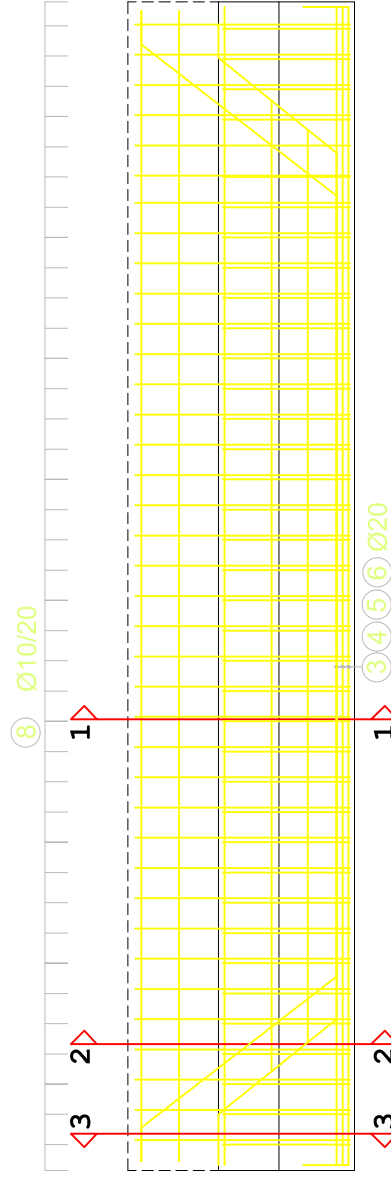

Presjek 1 - 1
M 1:25

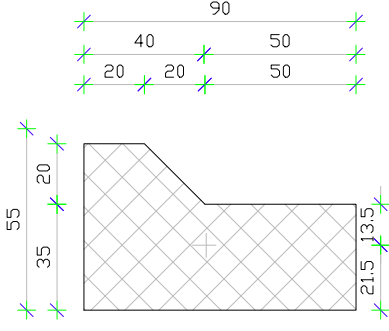

KUKA
kabel 0,6", l=2,05m
kom.2

Presjek 1 - 1
M 1:25

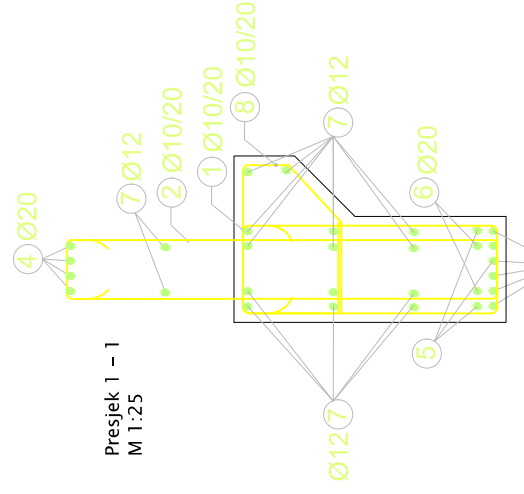

Presjek 2 - 2
M 1:25

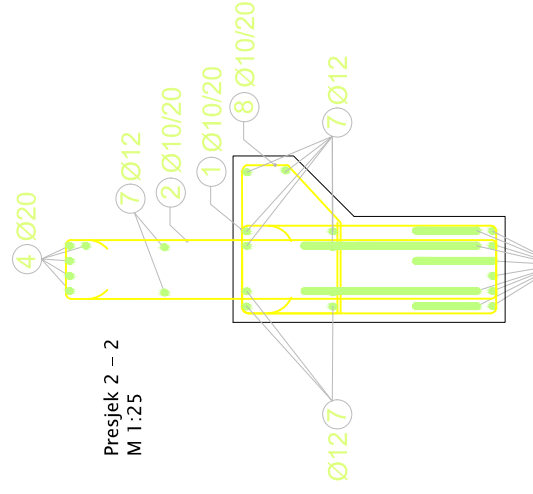

Presjek 3 - 3
M 1:25

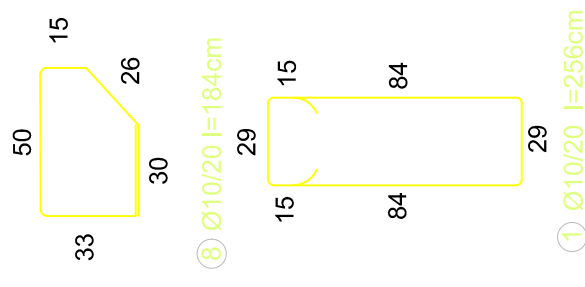
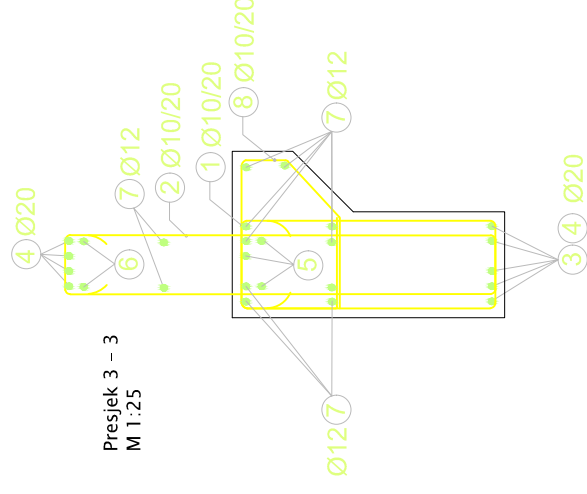

NAPOMENE:

- beton C 50/67
- armatura B500B
- zaštitni sloj c = 3cm
- ukupno betona za 1 element V=3 m³
- masa elementa G=8 T

Količina:

- greda G1 - 1kom
- greda G2 - 6kom
- greda G3 - 1kom

DIPLOMSKI RAD

GRADEVINA:

Trgovački centar u Trogiru

VRSTA PROJEKTA:

Projekt konstrukcije

RAZINA PROJEKTA:

Glavni projekt

SADRŽAJ:

ARMATURA GREDA G1, G2 i G3

PROJEKTANT: Gabrijela Grozdanić

MJERILO:

1:50
1:25

MENTOR: Prof. dr. sc. Alen Harapin

DATUM:

rujan 2016.

BROJ PRILOGA:

15.7

OZNAKA DOKUMENTA:

TC_gp.dwg

Fakultet građevinarstva, arhitekture i geodezije
Sveučilište u Splitu



SVEUČILIŠTE U SPLITU,
FGAG
21000 SPLIT, MATICE HRVATSKE 15
MB 3149463; tel + 385 (0)21 303333; fax + 385 (0)21 465117

Presjek A - A
M 1:100

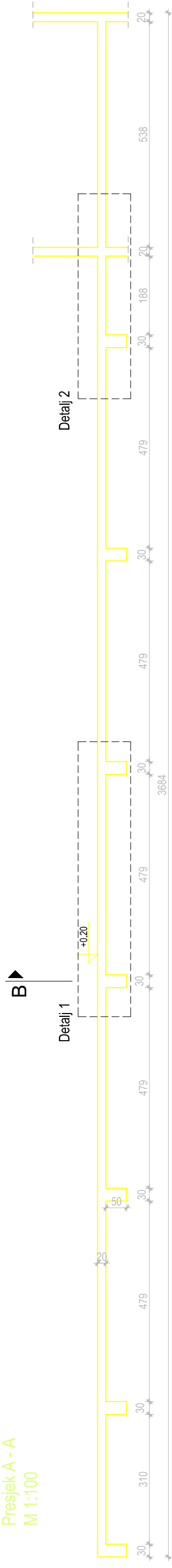

Tlocrt objekta
M 1:200

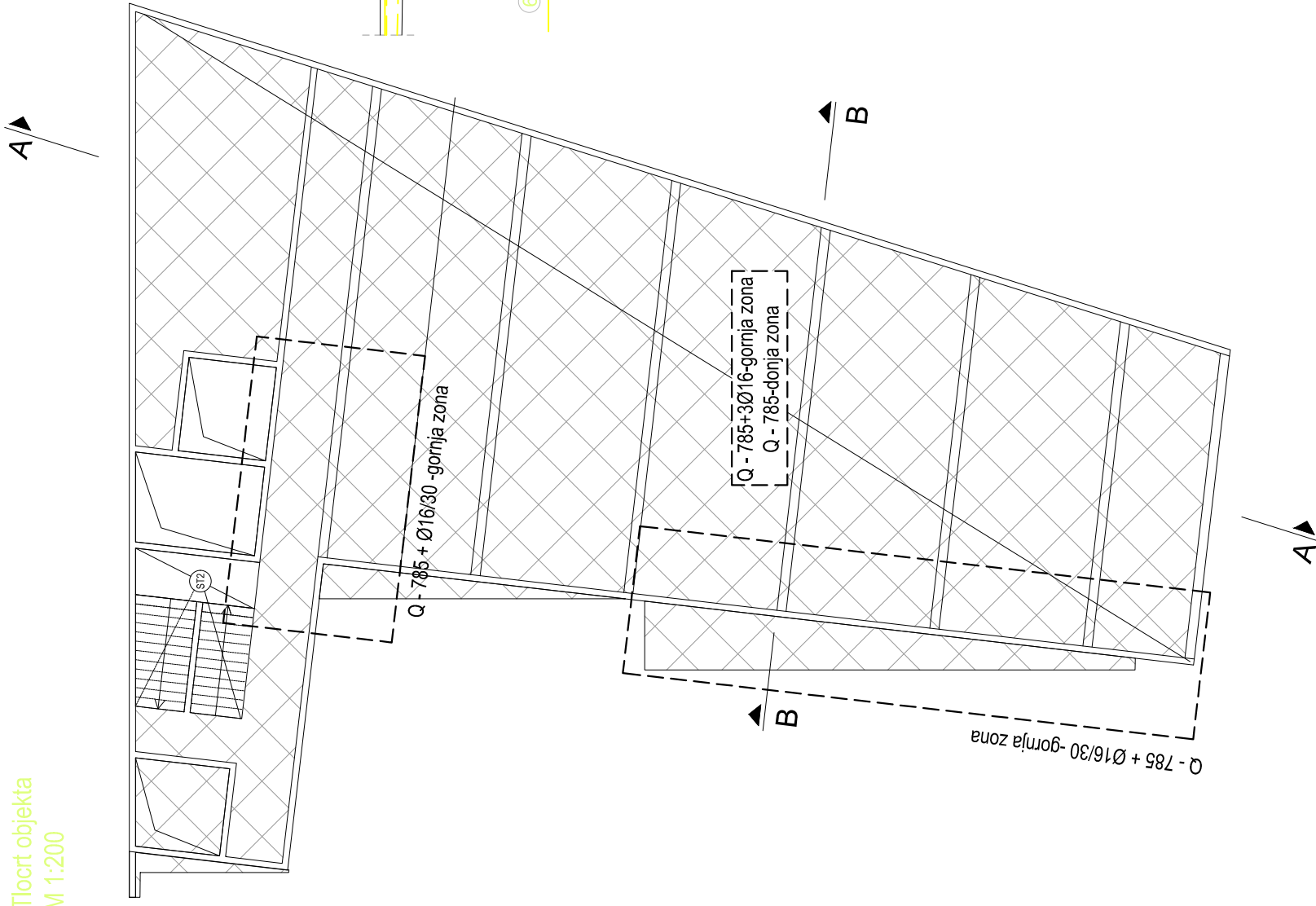

Detalj 1
M 1:50

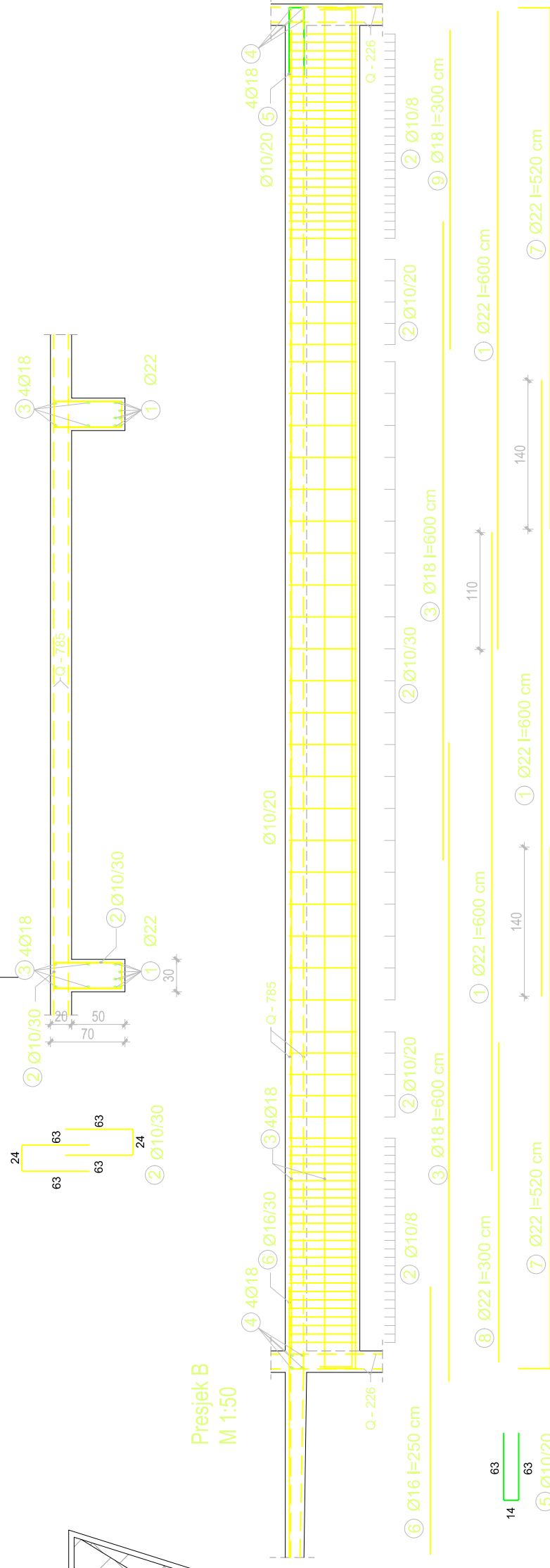

Presjek B
M 1:50

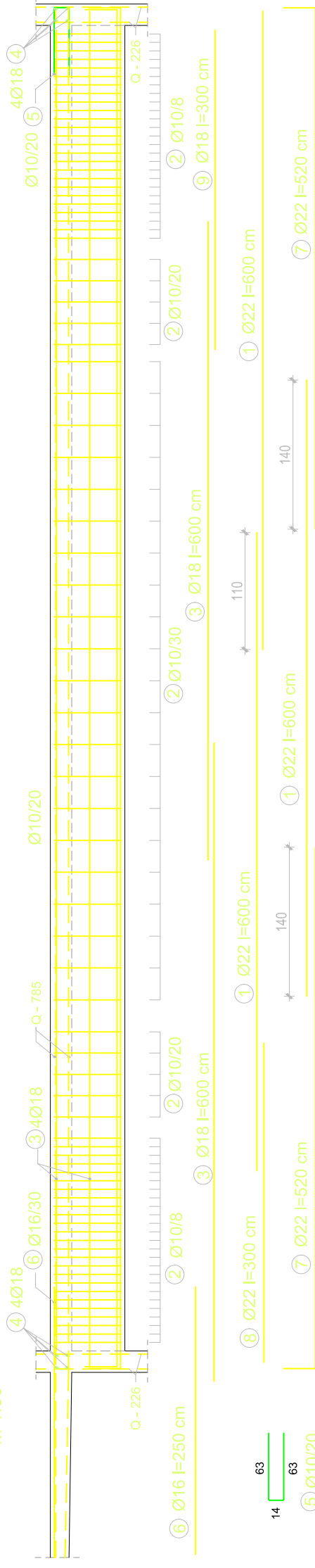

Detalj 2
M 1:50

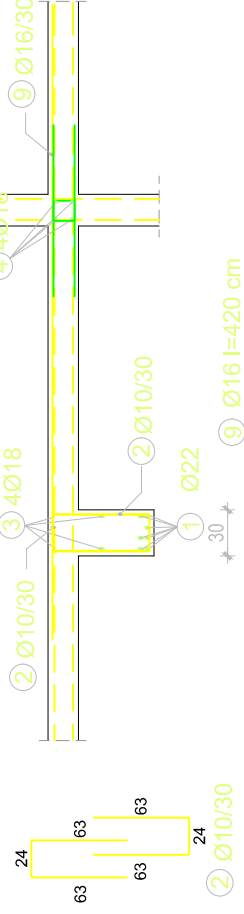

NAPOMENE:

- beton C30/37
- armatura B500B
- zaštitni sloj ploče c=3 cm
- na svim rubovima ploče postaviti U vilice Ø10/20
- preklopi mreže minimalno 40 cm
- na označenim mjestima u gornju zonu dodati Ø16/30 ili povećati preklap

DIPLOMSKI RAD

GRADEVINA:	Trgovački centar u Trogiru
VRSTA PROJEKTA:	Projekt konstrukcije
RAZINA PROJEKTA:	Glavni projekt
SADRŽAJ:	ARMATURA PLOČE 103

PROJEKTANT:	Gabrijela Grozdanić	MJERILO:	1:200 1:50
MENTOR:	Prof. dr. sc. Alen Harapin	DATUM:	rujan 2016.
OZNAKA DOKUMENTA:	TC_gp.dwg	BROJ PRILOGA:	15.8

Fakultet građevinarstva, arhitekture i geodetizije
Sveučilište u Šplitu



SVEUČILIŠTE U ŠPLITU,
FGAG
21000 ŠPLIT, MATICE HRVATSKE 15
MB 3149483; tel.: 385 (0)21 303333; fax: +385 (0)21 465117

Konzola K1
M 1:25

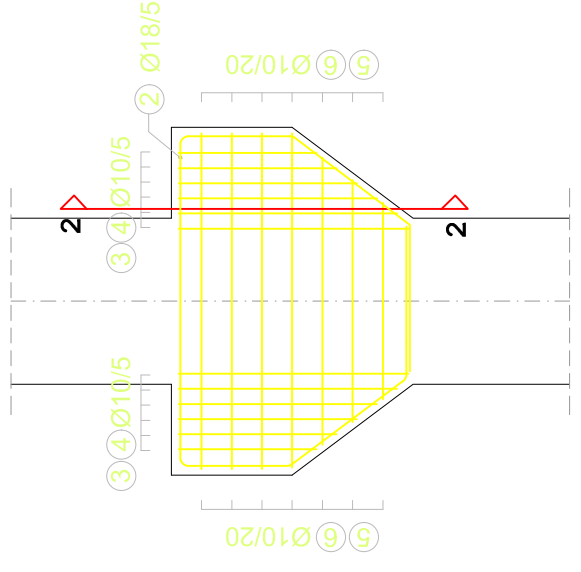

Presjek 2 - 2
M 1:25

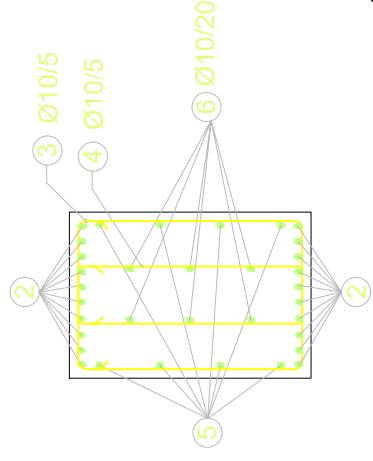

109
36
44
44
49

b=76cm
b=72cm
b=65cm
b=59cm
b=52cm
b=45cm

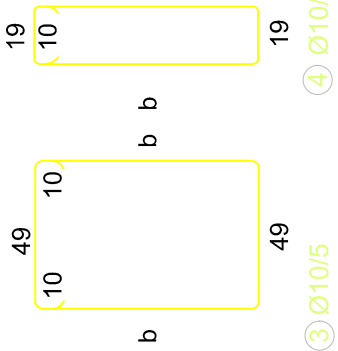

NAPOMENE:

- beton C 50/67
- armatura B500B
- zaštitni sloj c = 3cm
- ukupno betona za 1 element V=3 m³
- masa elementa G=7,5 T

Količina:

- slup S6 - 7kom
- slup S5 - 1kom

Konzola K2
M 1:25

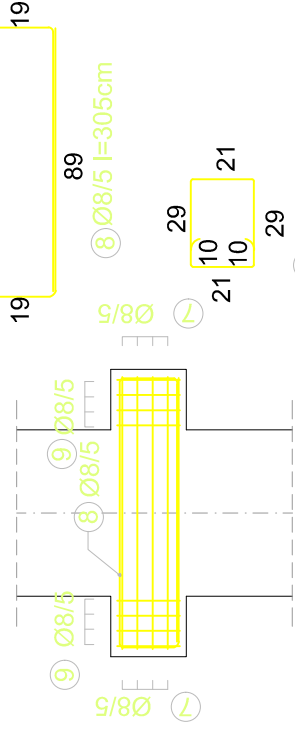

b=100cm
b=87cm
b=62cm

b=100cm
b=75cm

Presjek 1 - 1
M 1:25

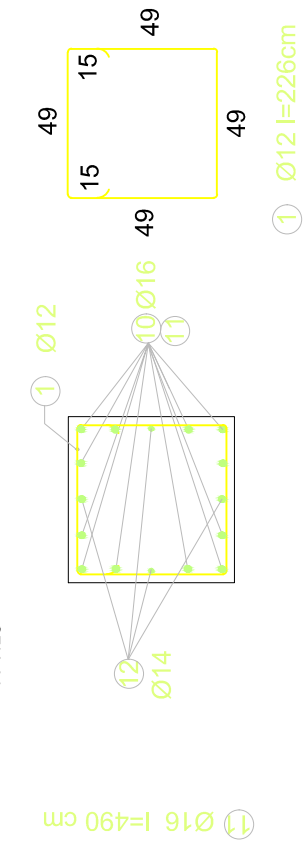

Detalj vrha stupa
M 1:25

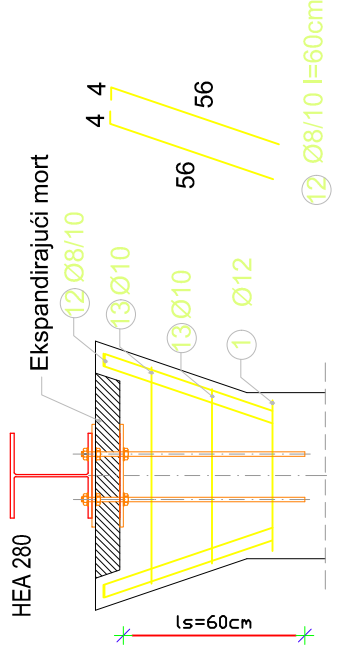

b=71cm
b=57cm

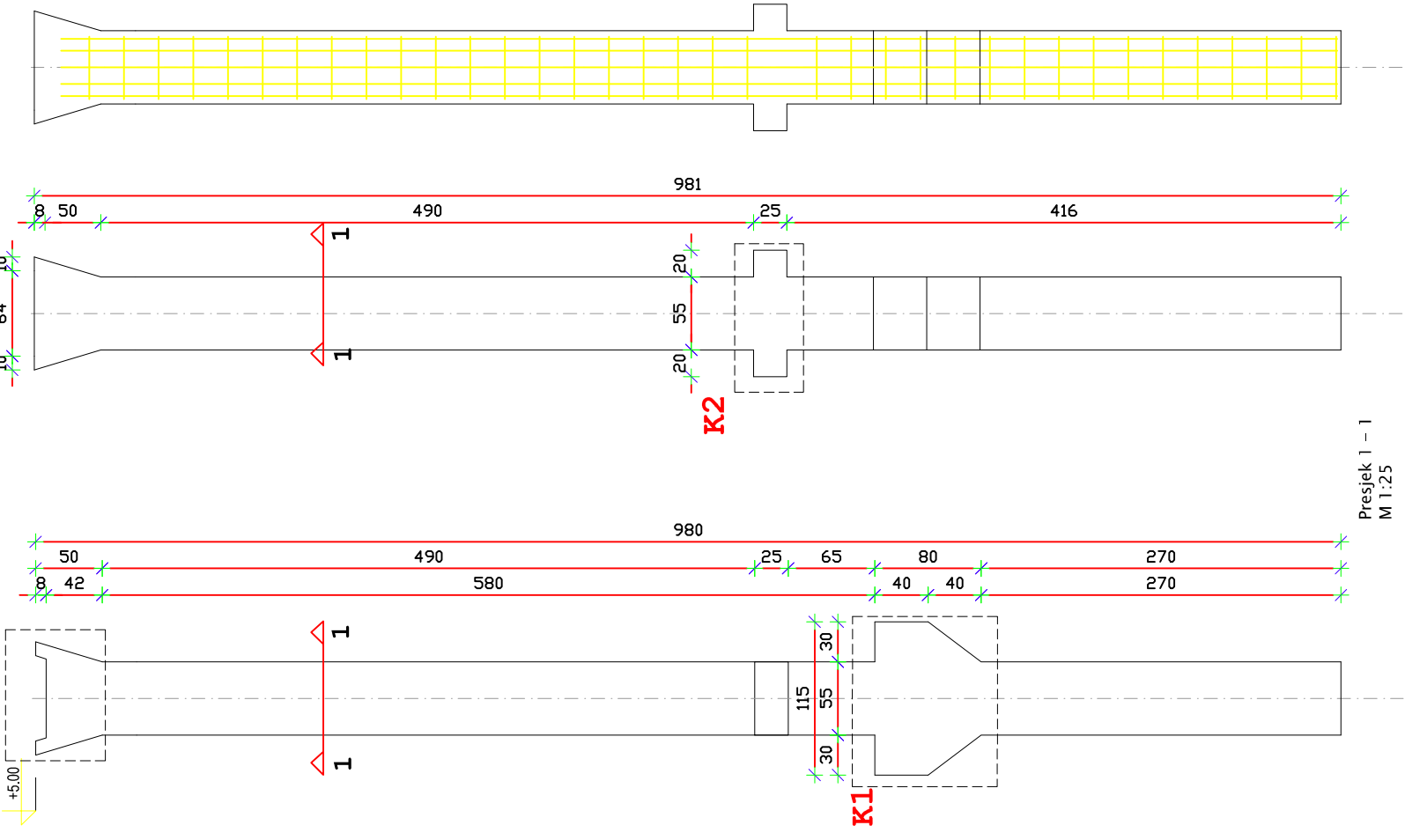

DIPLOMSKI RAD

Fakultet građevinarstva, arhitekture i geodezije
Sveučilište u Splitu



GRADEVINA: Trgovački centar u Trogiru

VRSTA PROJEKTA: Projekt konstrukcije

RAZINA PROJEKTA: Glavni projekt

ARMATURA STUPA S5 i S6

PROJEKTANT: Gabrijela Grozdanić

MENTOR: Prof. dr. sc. Alen Harapin

15.11

TC_gp.dwg

OZNAKA DOKUMENTA:

MJERILO: 1:50
1:25

DATUM: rujan 2016.

BROJ PRILOGA:

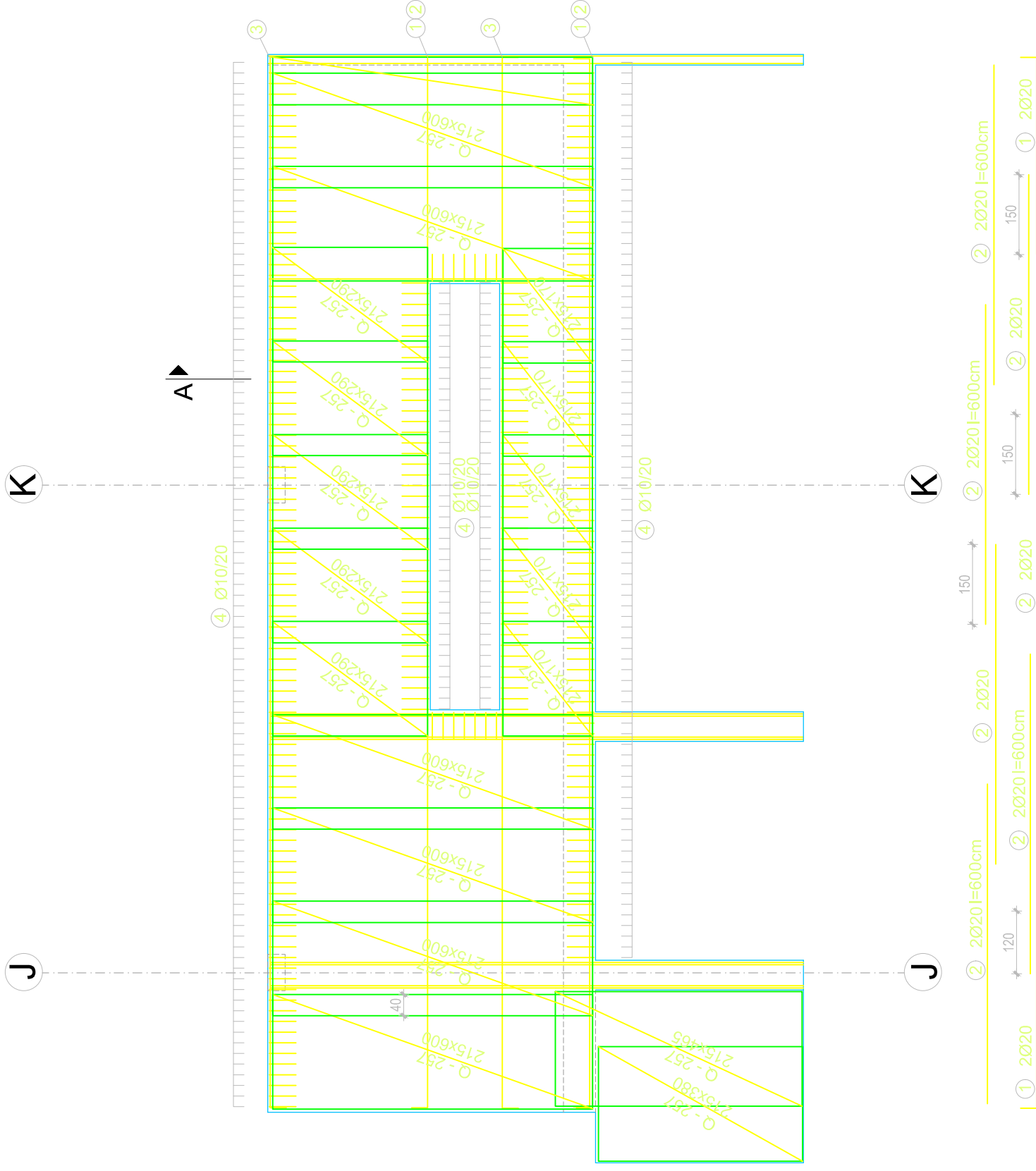

Presjek A - A
M 1:100

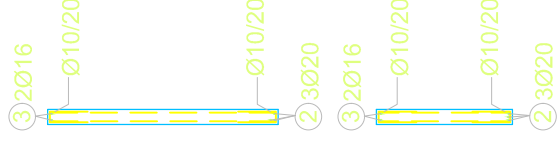

DIPLOMSKI RAD

GRADEVINA:

Trgovački centar u Trogiru

VRSTA PROJEKTA:

Projekt konstrukcije

RAZINA PROJEKTA:

Glavni projekt

SADRŽAJ:

ARMATURA NOSAČA

PROJEKTANT: Gabrijela Grozdanić

MJERILO:

1:100

MENTOR: Prof. dr. sc. Alen Harapin

DATUM:

rujan 2016.

BROJ PRILOGA:

15.12

Fakultet građevinarstva, arhitekture i geodezije
Sveučilište u Splitu



SVEUČILIŠTE U SPLITU,
FGAG
21000 SPLIT, MATICE HRVATSKE 15
MB 3149463; tel: + 385 (0)21 303333; fax: + 385 (0)21 465117

OZNAKA DOKUMENTA:

TC_gp.dwg