

# Transformacija punte Zenta

---

**Grubišić, Hrvoje**

**Supplement / Prilog**

*Publication year / Godina izdavanja:* **2015**

*Permanent link / Trajna poveznica:* <https://urn.nsk.hr/urn:nbn:hr:123:771122>

*Rights / Prava:* [In copyright](#)/[Zaštićeno autorskim pravom.](#)

*Download date / Datum preuzimanja:* **2025-01-11**



*Repository / Repozitorij:*

[FCEAG Repository - Repository of the Faculty of Civil Engineering, Architecture and Geodesy, University of Split](#)



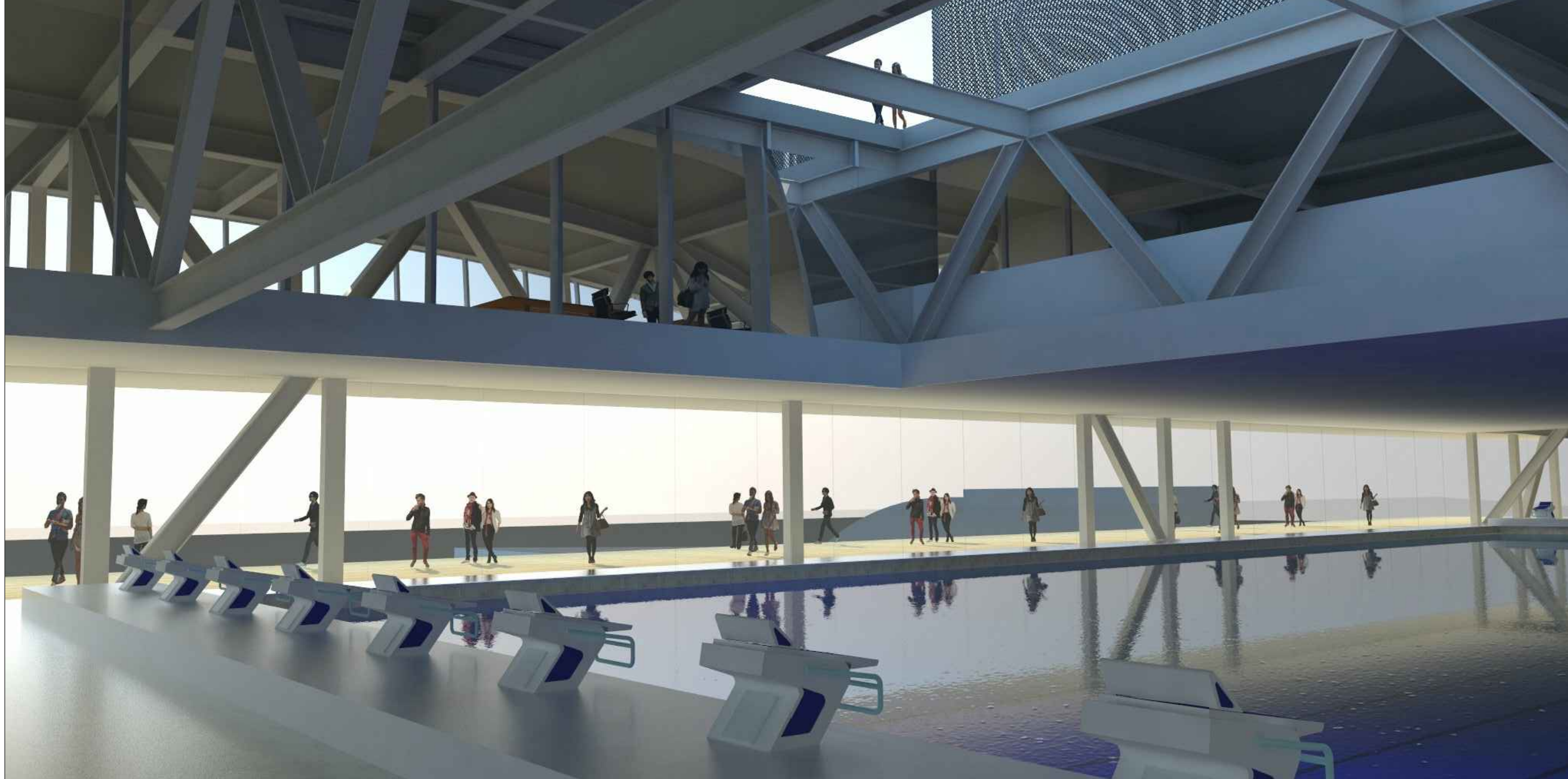

aksonometrija

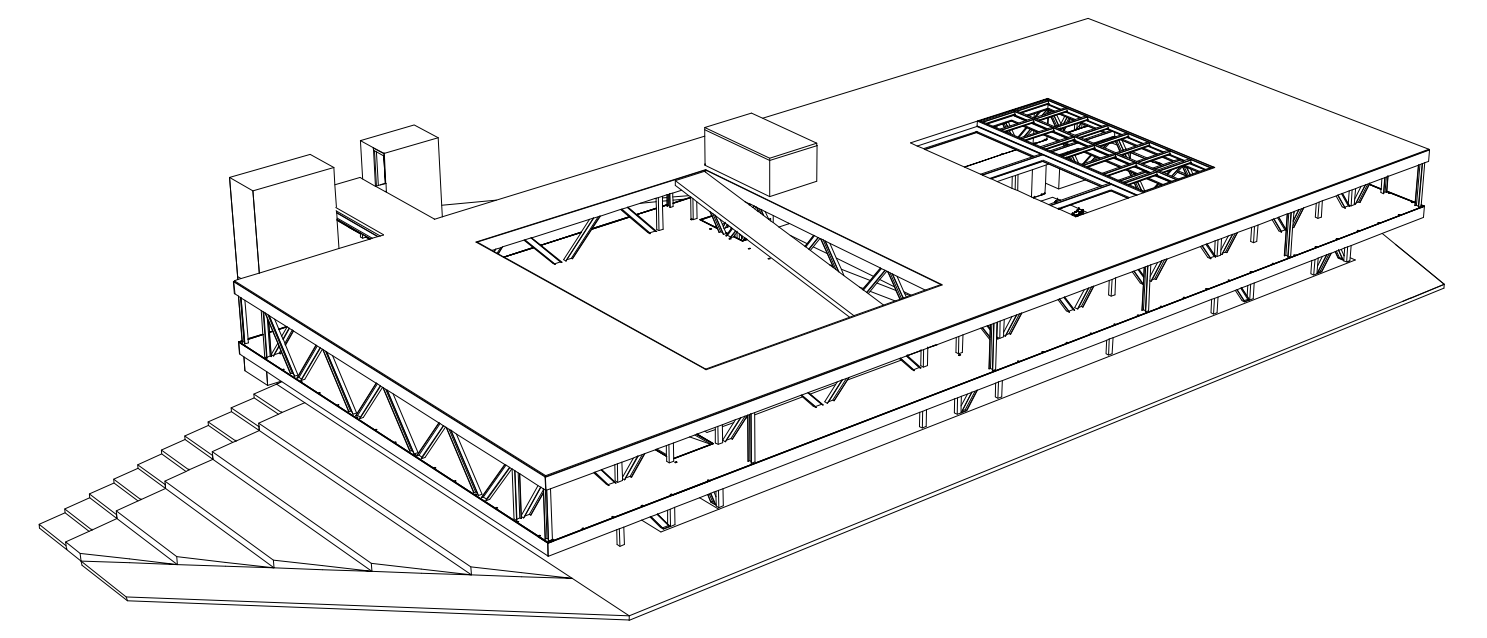

nosiva etažna konstrukcija

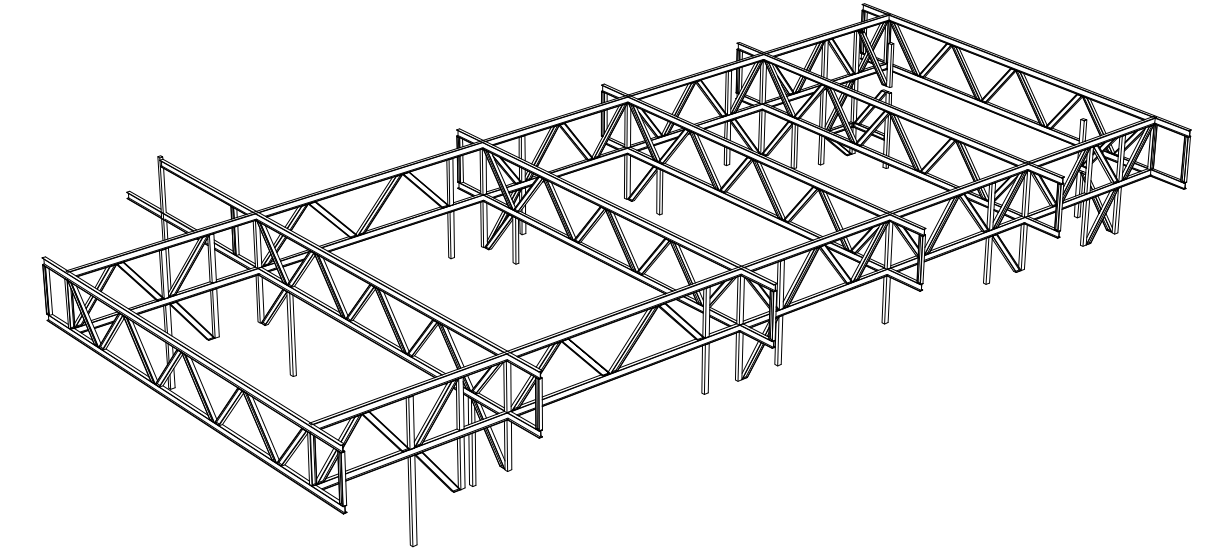

javna pješačka paluba

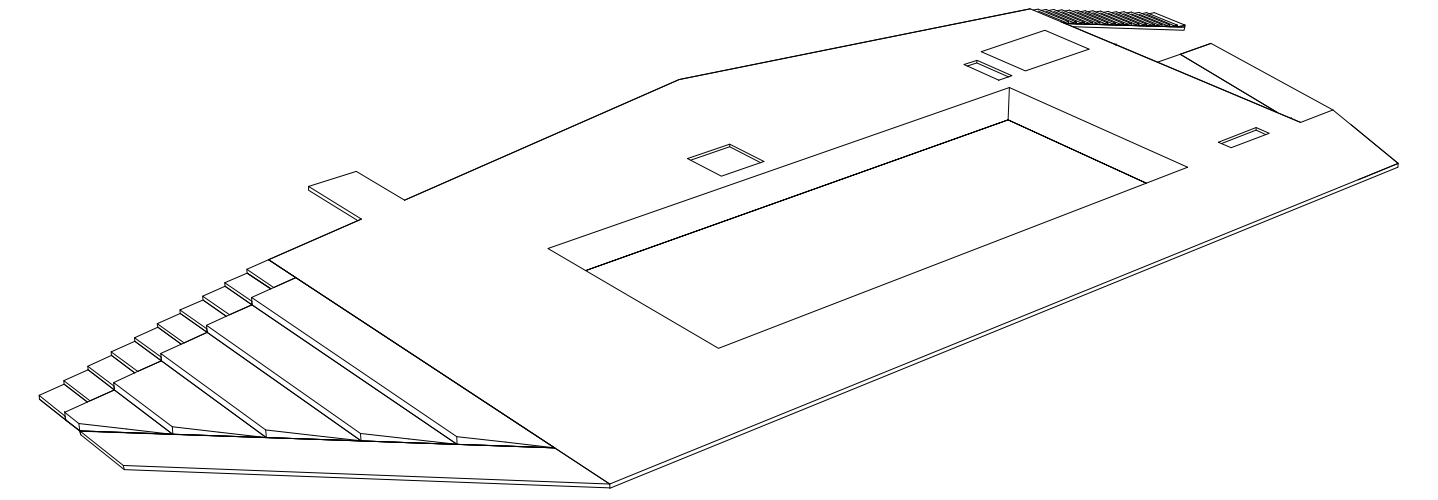

garaža i servisni sadržaj bazena

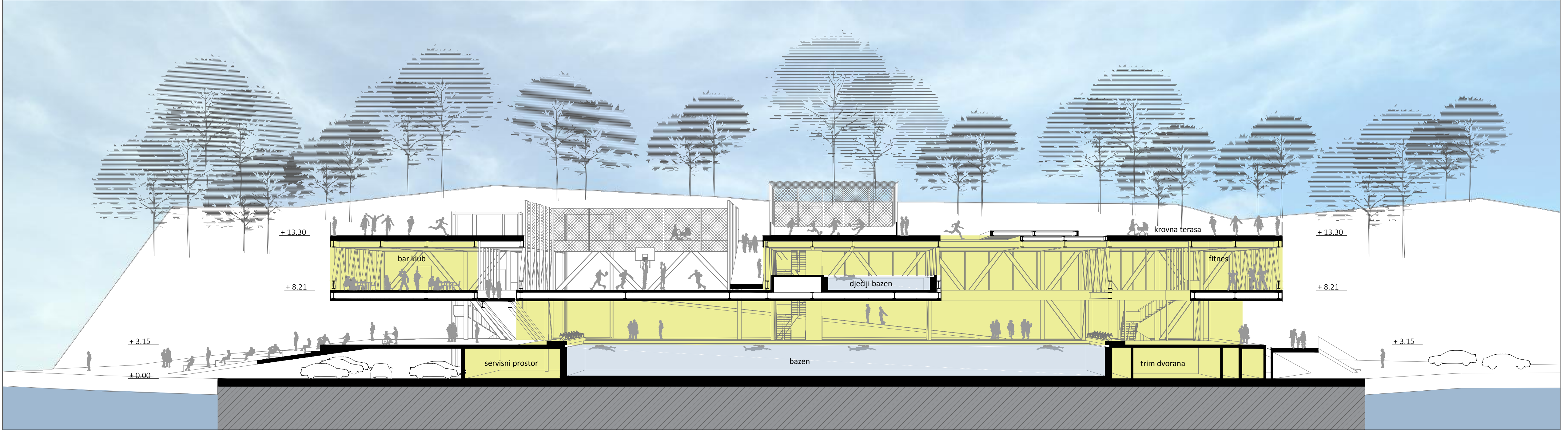
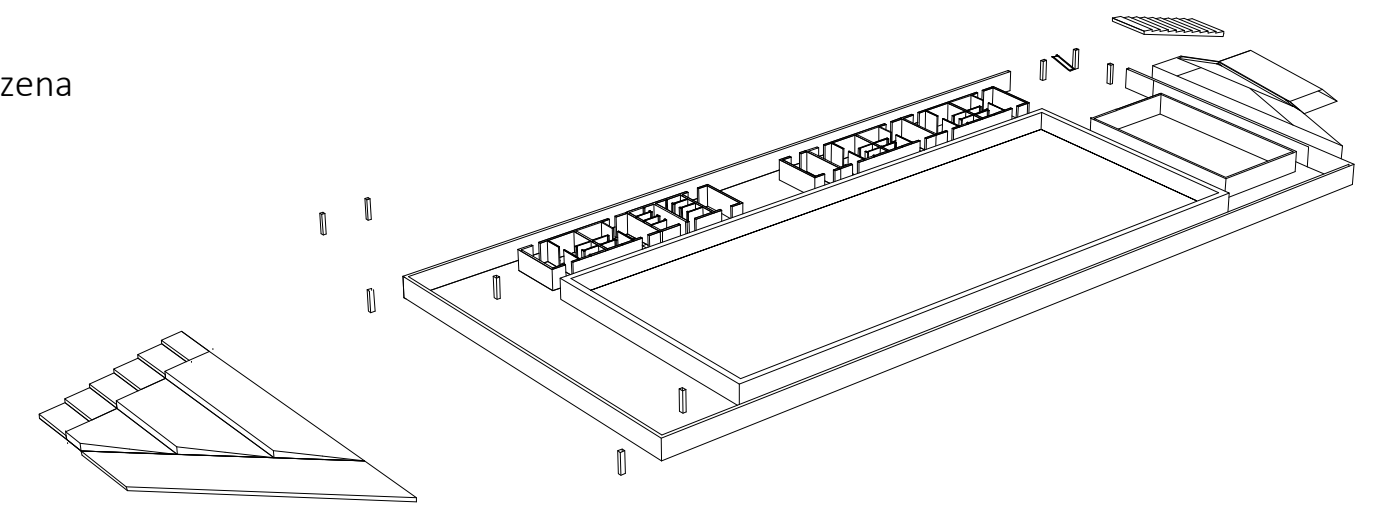

Košarka - terasa O Hara

O Hara koncert na otvorenom

O Hara caffe bar

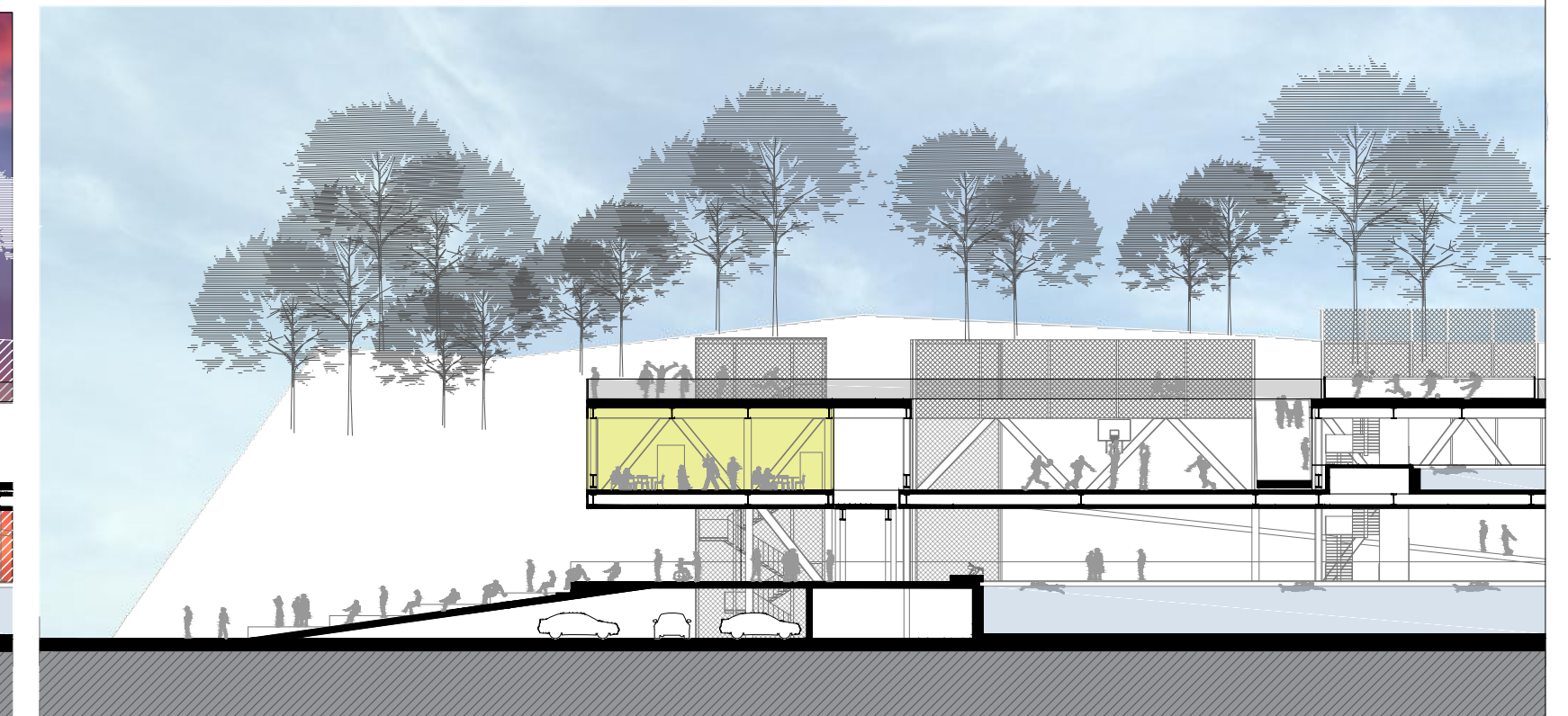
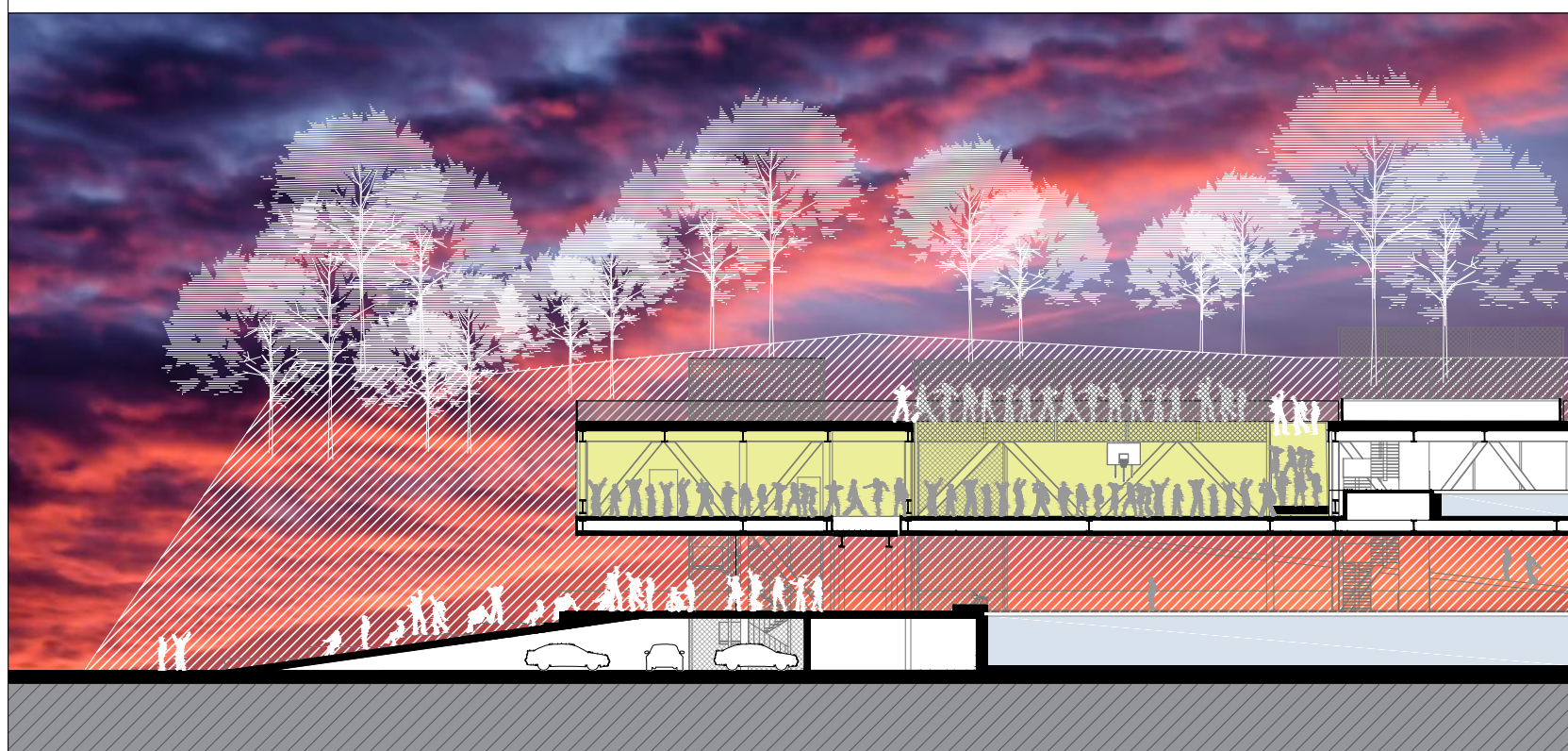

IME I PREZIME

HRVOJE GRUBIŠIĆ

NASLOV DIPLOMSKOG RADA

TRANSFORMACIJA PUNTE ZENTA

AKADEMSKA GODINA

2014 / 2015

MENTOR

Red. prof. ANTE KUZMANIĆ

KOMENTOR

Doc. SNJEŽANA PEROJEVIĆ

Punta Zenta je spoj raznih načina korištenja i sadržaja pa je tim i vrlo značajna lokacija grada Splita. S obzirom na svoj smještaj i prostorne mogućnosti može udomiti veliku količinu ljudi, sadržaja i događanja. To je mjesto koje ima duboku sentimentalnu važnost za građane Splita, kako za starije tako i za mlađe generacije. Transformacija punte Zenta predstavlja transformaciju starog sadržaja u novi i konstantne transformacije novoga sadržaja tijekom dana, tjedna, mjeseca i godine.

