

# Glavni projekt konstrukcije Sportsko-rekreacijskog centra Zenta

---

**Baleta, Marijan**

**Master's thesis / Diplomski rad**

**2019**

*Degree Grantor / Ustanova koja je dodijelila akademski / stručni stupanj:*

**University of Split, Faculty of Civil Engineering, Architecture and Geodesy / Sveučilište u Splitu, Fakultet građevinarstva, arhitekture i geodezije**

*Permanent link / Trajna poveznica:* <https://um.nsk.hr/um:nbn:hr:123:730882>

*Rights / Prava:* [In copyright](#)/[Zaštićeno autorskim pravom.](#)

*Download date / Datum preuzimanja:* **2024-11-24**



*Repository / Repozitorij:*

[FCEAG Repository - Repository of the Faculty of Civil Engineering, Architecture and Geodesy, University of Split](#)



UNIVERSITY OF SPLIT



DIGITALNI AKADEMSKI ARHIVI I REPOZITORIJI

**SVEUČILIŠTE U SPLITU  
FAKULTET GRAĐEVINARSTVA ARHITEKTURE I GEODEZIJE**

# **DIPLOMSKI RAD**

**Marijan Baleta**

**Split, 2019.**

**SVEUČILIŠTE U SPLITU  
FAKULTET GRAĐEVINARSTVA ARHITEKTURE I GEODEZIJE**

**Marijan Baleta**

**Glavni projekt konstrukcije Sportsko-rekreacijskog  
centra Zenta**

**Diplomski rad**

**Split,2019.**

*Zahvaljujem se mentoru Dr. sc. Vladimiru Diviću  
na pomoći pri izradi ovog rada i ugodnoj suradnji.  
Hvala roditeljima i prijateljima koji su mi bili potpora  
kroz cijelo moje školovanje.*

**SVEUČILIŠTE U SPLITU  
FAKULTET GRAĐEVINARSTVA, ARHITEKTURE I GEODEZIJE**

STUDIJ: **DIPLOMSKI SVEUČILIŠNI STUDIJ GRAĐEVINARSTVA**  
KANDIDAT: **Marijan Baleta**  
BROJ INDEKSA: **674**  
KATEDRA: **Katedra za metalne i drvene konstrukcije**  
PREDMET: **Spregnute konstrukcije**

**ZADATAK ZA DIPLOMSKI RAD**

Tema: Glavni projekt konstrukcije Sportsko-rekreacijskog centra Zenta

Opis zadatka:

Zadatak diplomskog rada je izraditi glavni projekt čelične konstrukcije Sportsko rekreacijskog centra Zenta smještenog u Splitu. Gabariti konstrukcije su 87,80 m x 39,07 m. Visina konstrukcije je 10,15 m. Konstrukcija se izvodi kao spregnuta betonsko – čelična. Potrebno je definirati opterećenja na konstrukciju, izraditi model konstrukcije te izvršiti proračun i dimenzioniranje elemenata konstrukcije u skladu s HRN EN 1992, HRN EN 1993 i HRN EN 1994. Pored standardnih dijelova glavnog projekta, potrebno je dokumentaciju proširiti dijelovima izvedbenog projekta (proračun spojeva konstrukcije).

U Splitu, 04.03.2019.

Voditelj Diplomskog rada:

doc.dr.sc. Vladimir Divić



Predsjednik Povjerenstva  
za završne i diplomske ispite:

doc. dr. sc. Ivo Andrić

# **Glavni projekt konstrukcije Sportsko-rekreacijskog centra Zenta**

## ***Sažetak:***

Imajući kao predložak idejno rješenje Sportskog-rekreacijskog centra Zenta izrađen je projekt konstrukcije. Napravljen je numerički model na kojem je izvršeno dimenzioniranje elemenata konstrukcije u skladu s HRN EN 1992, HRN EN 1993 i HRN EN 1994. U finalnoj fazi su proračunati spojevi te izrađeni nacrti konstrukcije.

## ***Ključne riječi:***

Sportsko-rekreacijski centar Zenta, čelik, spojevi, numerički model

# **Main construction project of the Sports and recreation center Zenta**

## ***Abstract:***

Considering the conceptual design of the Sports and recreation center Zenta as a template, a construction project was created. A numerical model was made for proper dimensioning of the structural elements in accordance with HRN EN 1992, HRN EN 1993 and HRN EN 1994. In the final phase the compounds are calculated and constructed to fit the newly made design drawings.

## ***Keywords:***

Sports and recreation center Zenta, steel, compounds, numerical model

## Sadržaj

1. TEHNIČKI OPIS.....	8
1.1. Opis konstrukcije .....	8
1.2. O proračunu konstrukcije.....	9
1.3. Materijal za izradu konstrukcije .....	10
1.4. Opis montaže konstrukcije.....	10
1.5. Primijenjeni propisi.....	11
1.6. Antikorozivna zaštita.....	11
1.7. Protupožarna zaštita.....	13
2. NUMERIČKI MODEL KONSTRUKCIJE .....	14
3. ANALIZA OPTEREĆENJA.....	18
3.1. Stalno opterećenje .....	18
3.2. Dodatno stalno opterećenje .....	18
3.3. Promjenjivo (pokretno) opterećenje .....	24
3.4. Opterećenje snijegom .....	26
3.5. Opterećenje vjetrom .....	29
3.6. Opterećenje vjetrom trenjem na krovu .....	44
3.7. Temperaturno opterećenje .....	45
3.8. Opterećenje potresom.....	48
4. KOMBINACIJE DJELOVANJA.....	54
4.1. Granično stanje uporabe (GSU) .....	54
4.2. Granično stanje nosivosti (GSN).....	56
5. DIMENZIONIRANJE ELEMENATA KONSTRUKCIJE .....	59
5.1. Spregnuta krovna konstrukcija .....	59
5.2. Stupovi kata.....	70
5.3. Dijagonale kata.....	77

5.4. Spregnuta rampa (kat-krov).....	84
5.5. Stupovi rampe (kat-krov) .....	95
5.6. Spregnuta konstrukcija kata .....	101
5.7. Spregnuta rampa (prizemlje-kat).....	112
5.8. Stupovi rampe (prizemlje-kat).....	123
5.9. Dijagonale prizemlja .....	129
5.10. Stupovi prizemlja(spregnuti) .....	136
6. PRORAČUN SPOJEVA .....	142
6.1. Spoj stup-temelj.....	142
6.2. Spoj stup rampe-temelj.....	145
6.3. Spoj glavnih nosača krova.....	152
6.4. Spoj glavnih nosača sa dijagonalama .....	158
7. DIMENZIONIRANJE TEMELJA .....	164
8. LITERATURA .....	166
9. NACRTI .....	167



# 1. TEHNIČKI OPIS

## 1.1. Opis konstrukcije

Predmet ovog projekta je čelično spregnuta konstrukcija sportsko-rekreacijskog centra Zenta na području Splita. Parcela predviđena za izgradnju objekta nalazi se u gradskom predjelu Firule na ravnom terenu, a postavljena je u smjeru istok – zapad. Pristupni put za vozila smješten je na istočnoj strani parcele. Dio slobodne neizgrađene površine služiti će za pješačku komunikaciju, a sa južne strane objekta osmišljena mala lučica za vez brodova. Također okolni teren prikladno će se hortikulturalno urediti. Svi infrastrukturni priključci izvest će se prema posebnim zahtjevima komunalnih i javnih poduzeća ili stručnih službi grada i županije.

Objekt je planiran kao katna konstrukcija sa višenamjenskim sadržajem koji uključuje: fitness centar, bar club, sanitarne čvorove, urede, teretana, košarkaški teren, stazu za trčanje i ostali sadržaji za sport i rekreaciju.

Vertikalnu nosivu konstrukciju čine spregnuti stupovi čelik-beton kvadratnog poprečnog presjeka(prizemlje) i čelični stupovi oblika poprečnog presjeka „I“ (kat).

Katna i krovna konstrukcija se sastoji od čeličnih greda koje su spregnute sa betonskom pločom. Krovna konstrukcija predviđena je kao prohodni krov namijenjen za rekreaciju i sport. Na dijelu krova predviđeni su krovni prozori kao dodatno osvjetljenje kata objekta. Vertikalna komunikacija je ostvarena liftom te sa spregnutim rampama čelik beton oslonjena na čelične stupove oblika poprečnog presjeka „I“.

Temelji su armirano betonski, izvedeni kao temelji samci i trakasti temelji.

Ukupna širina objekta je cca 39,07 metara, dok duljina iznosi cca 87,8 m. Ukupna površina krovne plohe je cca 3400 m<sup>2</sup>, a visina objekta je 9,65 m.

## 1.2. O proračunu konstrukcije

Proračun konstrukcije izveden je uz korištenje programskog paketa Scia Engineer 2016. Proračun reznih sila, te dimenzioniranje konstruktivnih elemenata, provedeno je korištenjem programa Scia Engineer 2016, dok je za grafički dio projekta korišten program AutoCAD 2016.

Proračun reznih sila izvršen je po linearnoj teoriji elastičnosti prvog reda. Proračunom su obuhvaćena sva djelovanja na konstrukciju, a to su vlastita težina, dodatno stalno opterećenje, pokretno opterećenje, opterećenje snijegom kao i opterećenje vjetrom. S obzirom na lokaciju objekta napravljena je analiza opterećenja koja obuhvaća djelovanje snijega i vjetra. Objekt se nalazi na području Splita, gradski predjel Firule te prema karti snijega za Republiku Hrvatsku ova građevina upada u 1. Područje – priobalje i otoci, što daje karakterističnu vrijednost opterećenja snijegom na tlu. U obzir je uzeta i nadmorska visina na kojoj se nalazi objekt. Za opterećenje vjetrom uzeta je zona III, kategorija zemljišta 0, te je u obzir uzeta visina objekta i njegova zaštićenost.

Pošto je vjetar dominantno opterećenje za ovakav tip objekta, posvećena mu je velika pažnja. Za stupove je također izvršena analiza opterećenja vjetrom, a opterećenje je zadano preko load panela kao površinsko opterećenje koje se prenosi na stupove kao kontinuirano opterećenje po duljini stupa.

Za svaki element konstrukcije određena je mjerodavna kombinacija opterećenja za provjeru krajnjeg graničnog stanja i graničnog stanja uporabljivosti. Za svaku granično stanje napravljene su posebne kombinacije uz poštivanje parcijalnih faktora sigurnosti prema EN 1991.

Rezultati prikazani u grafičkom dijelu ovog projekta uključuju rezne sile i pomake određenih dijelova konstrukcije. Rezne sile su dane u jedinicama kN za poprečne i uzdužne sile, kNm za momente, te u mm za pomake konstrukcije. Uzete su sve mjerodavne kombinacije opterećenja u obzir, te je svaki element dimenzioniran sukladno njegovim reznim silama.

### 1.3. Materijal za izradu konstrukcije

Materijal za izradu glavne nosive konstrukcije, kao i stupova je čelik S 355.

Konstruktivni elementi će međusobno biti vezani vijčanim spojevima. Vijci korišteni za izvedbu ove konstrukcije su M 22, M27, M30 i M48, kvalitete 8.8 i 10.9 . Spojevi i nastavci elemenata konstrukcije uključuju dodatne ploče i ukrute, također iste kvalitete čelika.

Za oblogu objekta predviđeni su paneli od pleksiglasa, koji imaju malu vlastitu težinu i omogućuju prolazak dnevnog svjetla. Za spregnutu konstrukciju korišten je beton klase C30/37. Temelji su armirano betonski, klasa betona C 30/37, armatura je B 500 B.

### 1.4. Opis montaže konstrukcije

Izvedba konstrukcije je montažna. Svi elementi konstrukcije predgotovljeni stižu na gradilište te se međusobno vežu vijcima.

Nulta faza montaže, nakon izvedenih svih prethodno potrebnih radova je montaža stupova.

Prvo se postavlja pripadna armatura stupova, a zatim armatura se zatvara čeličnim profilima koji ujedno služe kao izgubljena oplata. Čelični profili postavljaju se na ankere koji su postavljeni u temelje, stup se pridržaje dizalicom dok se ne postigne vertikalnost pomoću vijaka. Nakon provjere vertikalnosti, vrši se ispunjenje prostora ispod spojne ploče i temelja ekspandirajućim mortom. Nakon što očvrzne ekspandirajući mort čelični profili se zapunjavaju betonom.

Nakon toga se na stupove vežu glavni nosači koji tvore etažu konstrukcije. Na stupove prizemlja postavljaju se čelični stupovi kata. Postavljanjem moždanika (zavarivanjem) i čeličnog lima ploča je spremna za betoniranje te nakon što beton očvrzne ploča tvori spregnutu konstrukciju.

Postavljanjem glavnih nosača kata na isti način se izvodi sprezanje ploče krova.

Svi elementi konstrukcije se dovodu na gradilište duljine do 12 m zbog transporta. Na gradilištu se podižu dizalicom na predviđenu poziciju te vijčano spajaju na ostatak konstrukcije.

## 1.5. Primijenjeni propisi

Proračun i dimenzioniranje svih elemenata čelične konstrukcije provedeni su u skladu sa EUROCODE 3, a analiza djelovanja na konstrukciju napravljena je u skladu sa EUROCODE 1. Proračun i dimenzioniranje betonskih elemenata konstrukcije te spregnute konstrukcije provedeno je u skladu sa EUROCODE 2 i EUROCODE 4.

## 1.6. Antikorozivna zaštita

Kod čelika pod korozijom se podrazumijeva oksidacija željeza pri djelovanju vlage i raznih nečistoća. Agensi koji ubrzavaju hrđanje su zagađena atmosfera, industrijsko područje zagađeno sumporom, sol itd.

Zaštita čeličnih konstrukcija od hrđanja vrši se:

- premazima
- zaštita cinkom
- metalizacijom
- uporabom specijalnih čelika
- katodnom zaštitom

Zaštita premazima obavlja se u svrhu spriječavanja da kisik i vlaga dođu u dodir s čelikom.

Premazivanje se obično vrši bojanjem u dva sloja: osnovni premaz i zaštitni premaz. Osnovni premaz neposredno štiti čelik, a potrebno je da bude izrađen od tvari koje nisu štetne po ljudsko zdravlje. Zaštitni sloj služi za zaštitu osnovog premaza.

Prerano propadanje konstrukcije najčešće nastaje usljed loših detalja u konstrukciji (nepristupačna mjesta za bojenje, mjesta gdje se zadržava voda, oštri bridovi gdje se nemože nanijeti zahtjevana debljina premaza i sl.) koje treba nastojati izbjegavati.

Sistem zaštite bojenjem sastoji se iz:

- Priprema površine – trajnost premaza ovisi o prionjivosti boje za metalnu površinu, što ovisi o čistoći površine prije bojanja. Čišćenje se vrši četkama, pijeskarenjem, plamenikom ili kemijskim sredstvima.

- Nanošenje boje – bojenje se vrši četkom , valjkom ili prskanjem. Treba paziti na ograničenja za pojedine boje. Broj slojeva premaza obično se sastoji od dva, a specifično od četiri ili više slojeva. Novi premaz može se vršiti tek kad je prethodni potpuno suh. Debljini premaza potrebno je posvetiti posebnu pažnju. Općenito, deblji premaz povećava trajnost zaštite. Ukupna debljina suhih premaza treba se kretati između 0,1-0,4 mm.

Dobro izvedeni premazi traju:

- do 30 godina u zatvorenoj prostoriji
- do 20 godina kod konstrukcija zaštićenih od kiše
- do 10 godina u prirodi
- 2-3 godine u zagađenom okolišu

Zaštita pocinčavanjem podrazumijeva vrste zaštite koje se ostvaruju nanošenjem prevlake cinka i po toplom postupku. Mase i debljine prevlaka cinka za pojedine elemente određene su prema Pravilniku o tehničkim mjerama i uvjetima za zaštitu čeličnih konstrukcija od korozije i ne mogu biti manje od 500g/m<sup>2</sup> elementa debljine 5 mm. Sve čelične konstrukcije prethodno treba odmastiti, očistiti razblaženom otopinom klorovodične kiseline te isprati hladnom vodom. Neposredno prije pocinčavanja čelična konstrukcija se stavlja u taljevinu ili otopinu za flusiranje.

Toplo pocinčavanje se izvodi stavljanjem tekućine u rastopljeni cink. Cink mora biti kvaliteta Zn 97,5 do Zn 99,5 prema HRN EN ISO 14713:2001. Prevlaka cinka dobivena toplim postupkom mora biti homogena i mora prekrivati osnovicu. Prevlaka cinka mora čvrsto prianjati za čeličnu površinu i ne smije se ljuštiti niti pucati pri uporabi. Prije montaže potrebno je izvršiti kontrolu prevlake cinka prema HRN C.A1. 558, odnosno mase prevlake cinka prema HRN A6.021.

**1.7. Protupožarna zaštita**

Pri izvedbi osigurat će se provedba svih propisa o zaštiti od požara. Pristup i intervencija vatrogasnog vozila omogućit će se sa istočne i zapadne strane parcele. Zahtijevana vatrootpornost elemenata čelične konstrukcije F30. Osiguranje vatrootpornosti osiguravamo specijalnim ekspandirajućim premazima.

## 2. NUMERIČKI MODEL KONSTRUKCIJE

Numerički 3D render modela konstrukcije je izrađen u Scia Engineer 2016.

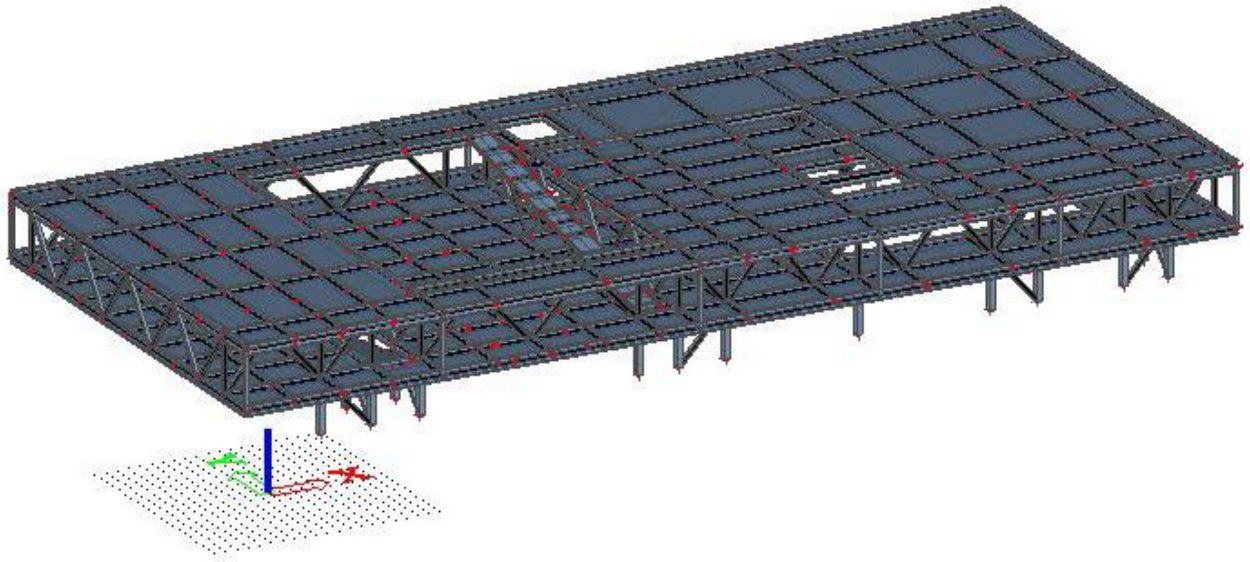

*Slika 2.1. Izometrijski prikaz 3D modela*

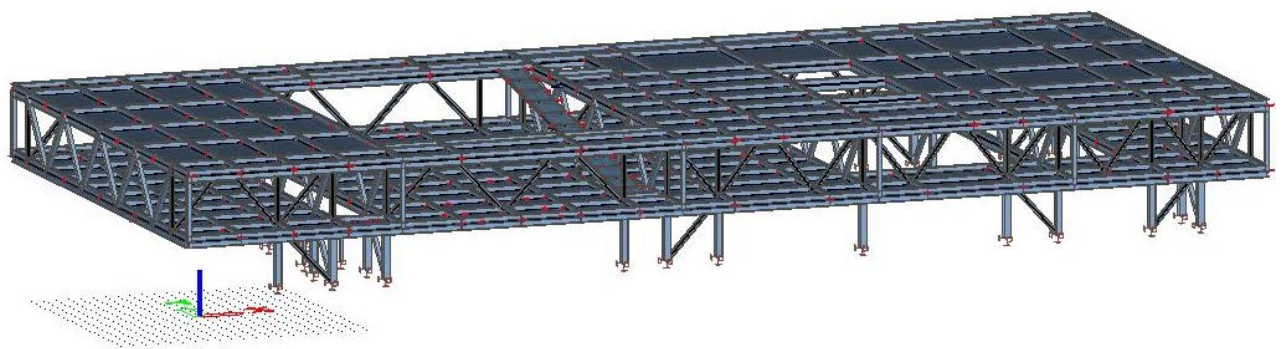

*Slika 2.2. Izometrijski prikaz 3D modela*

Tlocrt krova konstrukcije

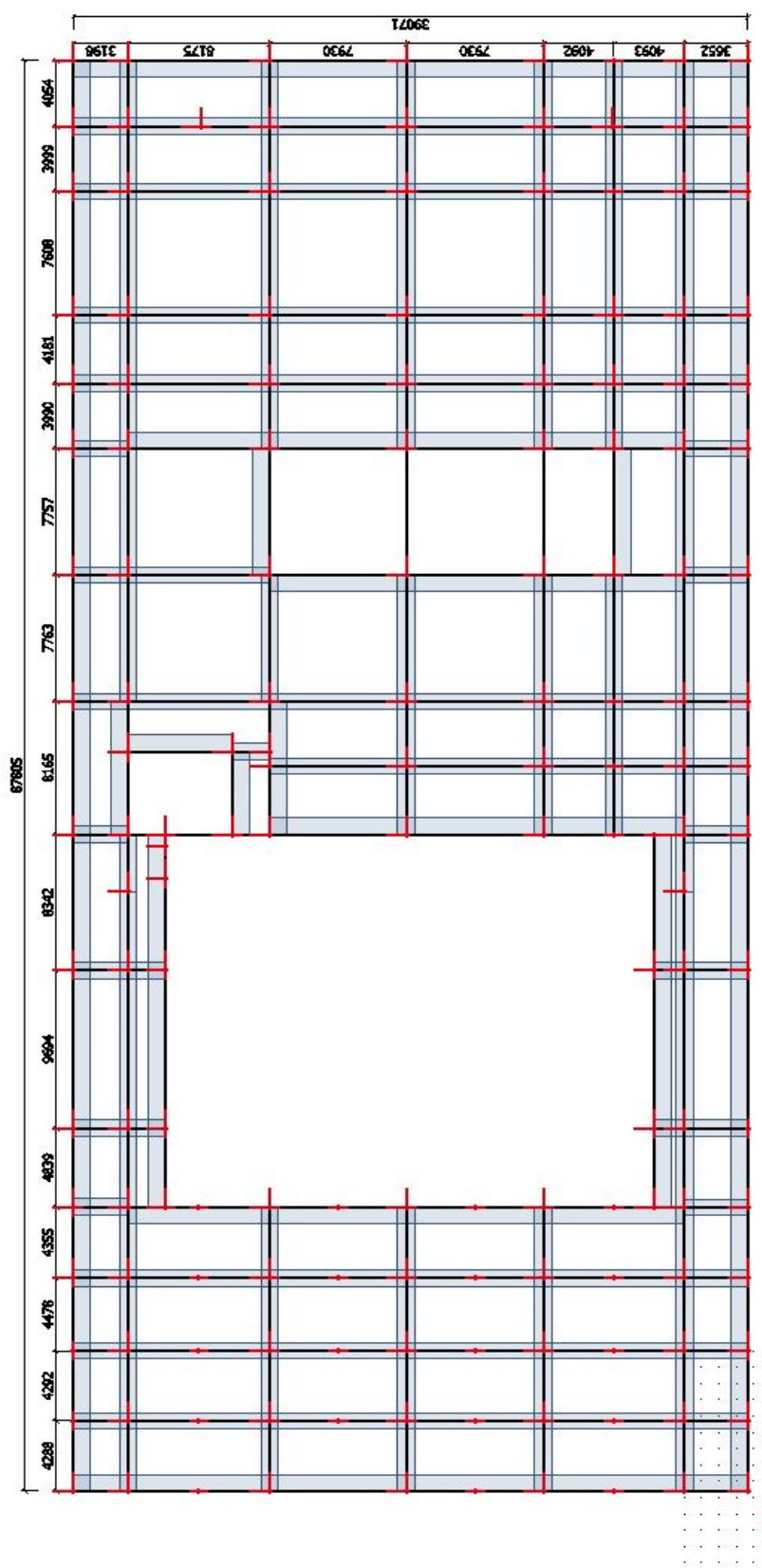

Slika 2.3. Tlocrtni prikaz rastera u numeričkom modelu



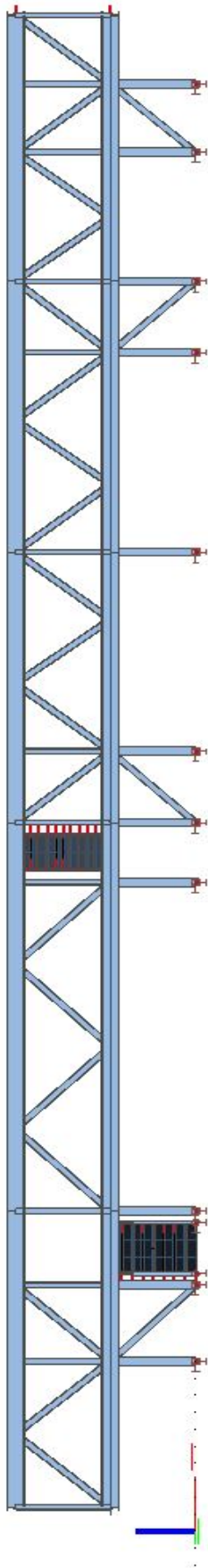

*Slika 2.4. Prikaz južnog pročelja*

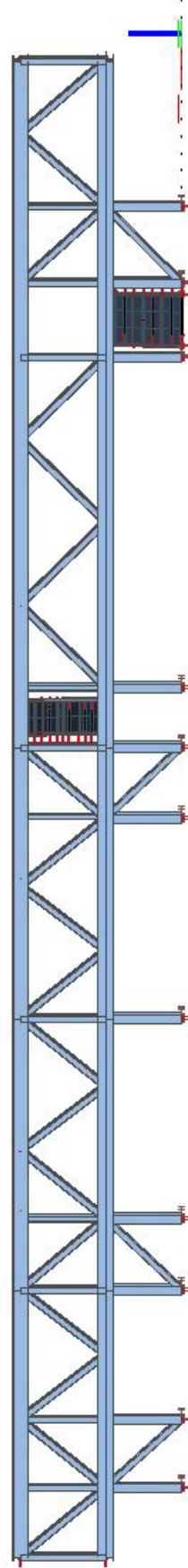

*Slika 2.5. Prikaz sjevernog pročelja*

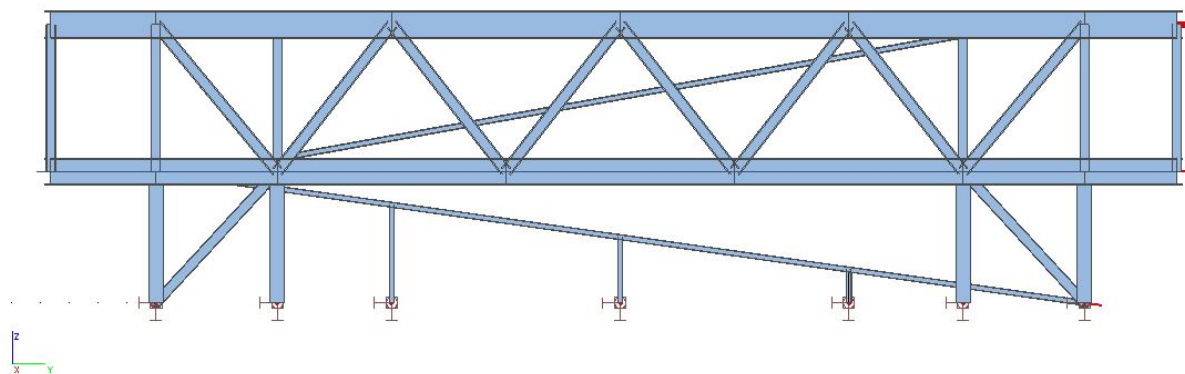

*Slika 2.6. Prikaz istočnog pročelja*

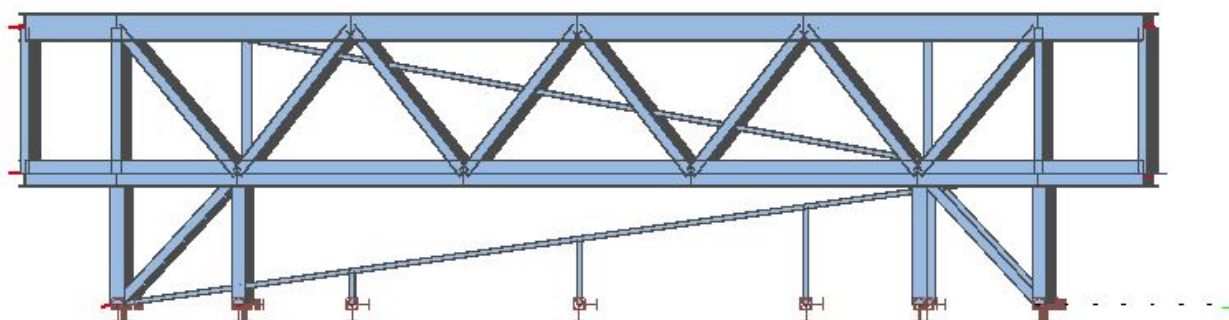

*Slika 2.7. Prikaz zapadnog pročelja*

### 3. ANALIZA OPTEREĆENJA

#### 3.1. Stalno opterećenje

Stalno opterećenje uključeno je kroz numerički model.

#### 3.2. Dodatno stalno opterećenje

a) Slojevi ravnog krova

Pod dodatnim stalnim opterećenjem podrazumijevamo slojeve krovne konstrukcije.

Naravno, ovdje nije uključena težina ab ploče jer je ona zadana u numeričkom modelu.

Slojevi krovne konstrukcije	d (m)	$\gamma$ (kN/m <sup>3</sup> )	d · $\gamma$ (kN/m <sup>2</sup> )
Spušteni strop, knauf (požarne ploče EI30)	0,025	10,0	0,25
Instalacije			0,10
Toplinska izolacija ( fibran XPS 400-L)	0,08	0,30	0,024
Hidroizolacija + parna brana	0,01	20,0	0,20
Zaštita hidroizolacije (estrih)	0,10	25,0	2,50
Tartan	0,015	7,60	0,114
Namještaj			0,40

Ukupno dodatno stalno opterećenje: 3,588 kN/m<sup>2</sup>

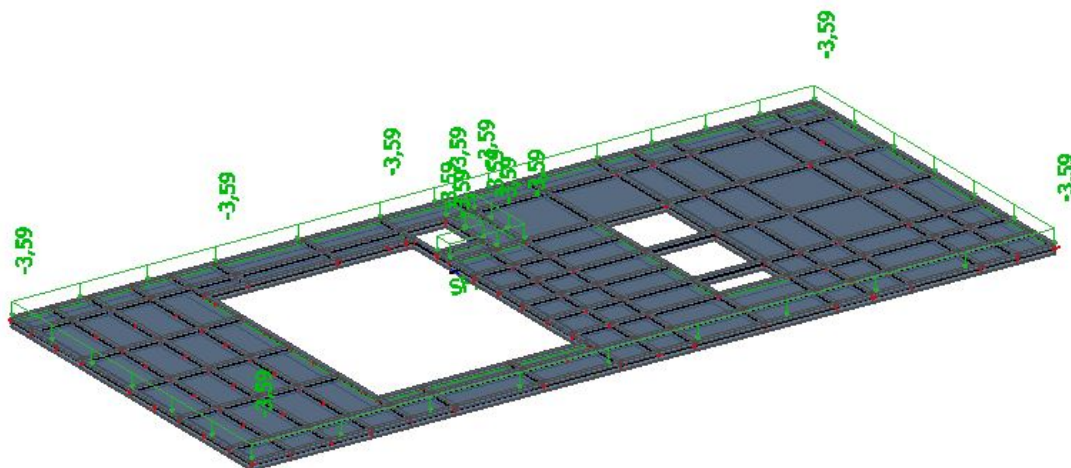

Slika 3.1. Prikaz raspodjele dodatnog stalnog opterećenja-ravni krov

## b) Ravni krov- krovni prozor

Pod dodatnim stalnim opterećenjem podrazumijevamo slojeve krovne konstrukcije.

Težina čelične konstrukcije nije uračunata jer je ona zadana u numeričkom modelu.

Slojevi krovne konstrukcije	d (m)	$\gamma$ (kN/m <sup>3</sup> )	d · $\gamma$ (kN/m <sup>2</sup> )
Krovni prozor + sekundarna konstrukcija			2,00

Ukupno dodatno stalno opterećenje: 2,00 kN/m<sup>2</sup>

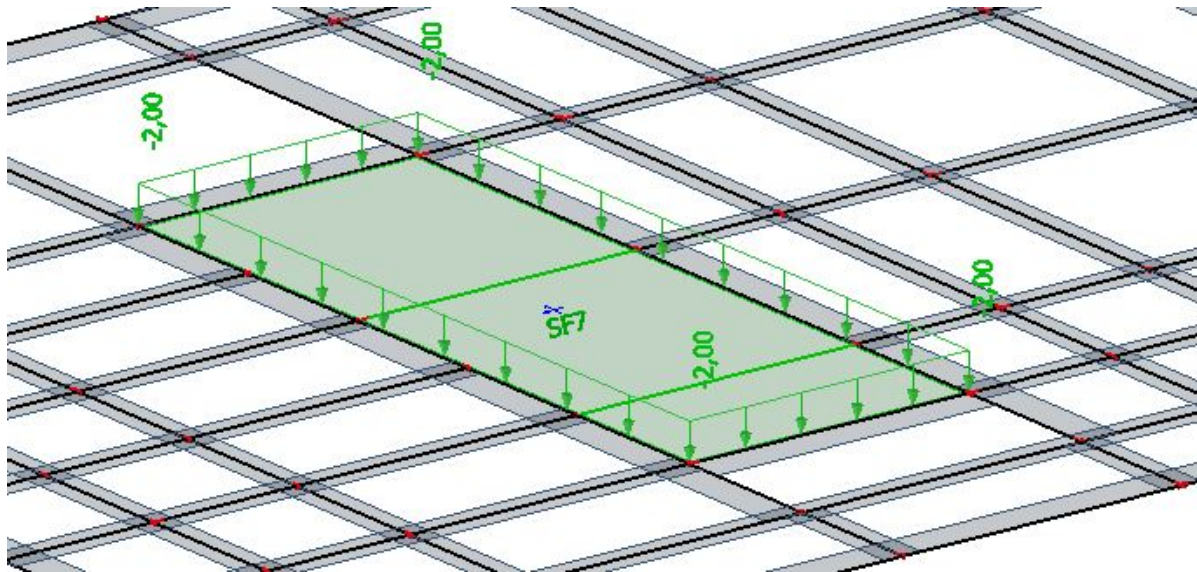

Slika 3.2. Prikaz raspodjele dodatnog stalnog opterećenja-krovni prozori

## c) Slojevi kata ( kupaonice,wc)

Pod dodatnim stalnim opterećenjem podrazumijevamo slojeve krovne konstrukcije.

Naravno, ovdje nije uključena težina ab ploče jer je ona zadana u numeričkom modelu.

Slojevi krovne konstrukcije	d (m)	$\gamma$ (kN/m <sup>3</sup> )	$d \cdot \gamma$ (kN/m <sup>2</sup> )
Spušteni strop, knauf (požarne ploče EI30)	0,025	10,0	0,25
Instalacije			0,10
Toplinska izolacija ( fibran XPS 400-L)	0,08	0,30	0,024
PE folija	0,005	20,0	0,10
Estrih	0,08	25,0	2,00
Hidroizolacija (plastivo 180)	0,005	20,0	0,10
Keramičke pločice	0,015	24,0	0,36
Pregrade			1,00

Ukupno dodatno stalno opterećenje: 3,934 kN/m<sup>2</sup>

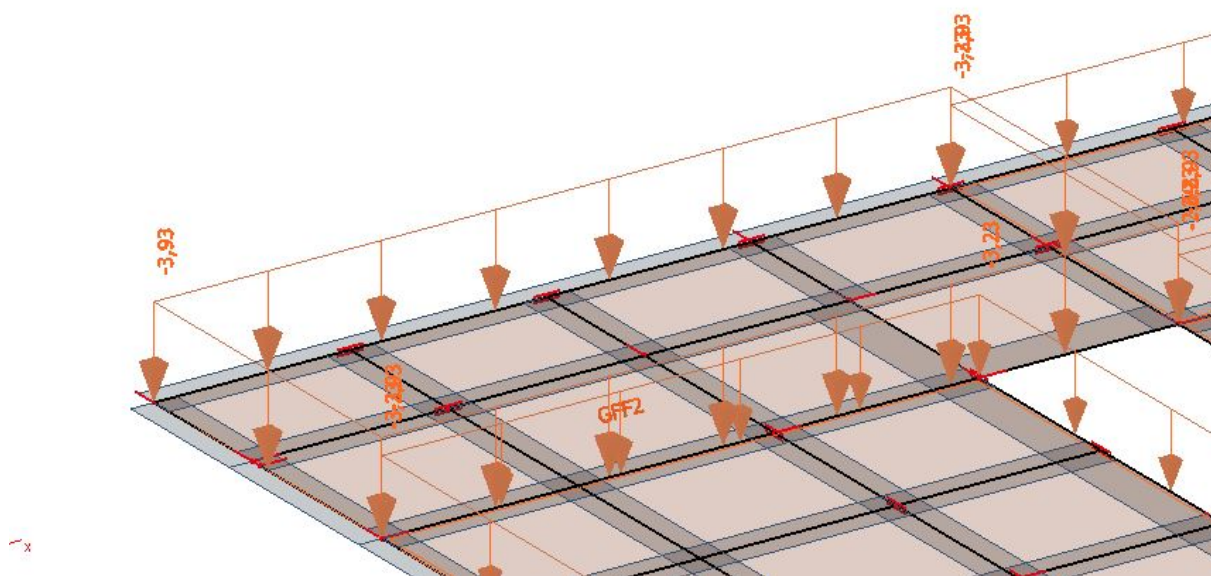

*Slika 3.3. Prikaz raspodjele dodatnog stalnog opterećenja- kat (kupaonice,wc)*

d) Slojevi kata ( teretana, bar klub, uredi)

Pod dodatnim stalnim opterećenjem podrazumijevamo slojeve krovne konstrukcije.

Naravno, ovdje nije uključena težina ab ploče jer je ona zadana u numeričkom modelu.

Slojevi krovne konstrukcije	d (m)	$\gamma$ (kN/m <sup>3</sup> )	$d \cdot \gamma$ (kN/m <sup>2</sup> )
Spušteni strop, knauf (požarne ploče EI30)	0,025	10,0	0,25
Instalacije			0,10
Toplinska izolacija ( fibran XPS 400-L)	0,08	0,30	0,024
PE folija	0,005	20,0	0,10
Estrih	0,08	25,0	2,00
Keramičke pločice	0,015	24,0	0,36
Namještaj			0,40

Ukupno dodatno stalno opterećenje: 3,234 kN/m<sup>2</sup>

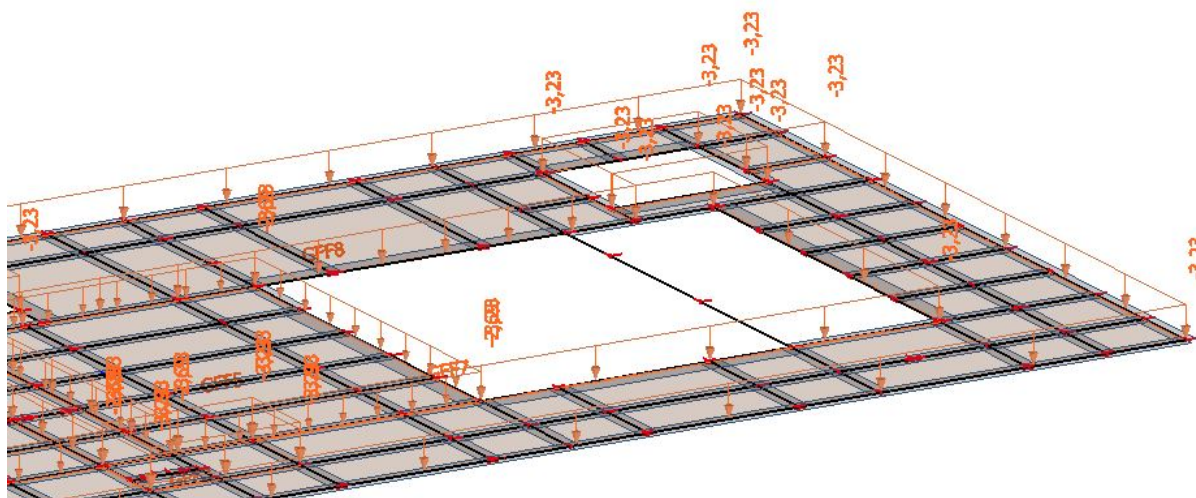

*Slika 3.4. Prikaz raspodjele dodatnog stalnog opterećenja- kat (teretana, bar klub, uredi)*

e) Slojevi kata ( košarkaški teren)

Pod dodatnim stalnim opterećenjem podrazumijevamo slojeve krovne konstrukcije.

Naravno, ovdje nije uključena težina ab ploče jer je ona zadana u numeričkom modelu.

Slojevi krovne konstrukcije	d (m)	$\gamma$ (kN/m <sup>3</sup> )	$d \cdot \gamma$ (kN/m <sup>2</sup> )
Spušteni strop, knauf (požarne ploče EI30)	0,025	10,0	0,25
Instalacije			0,10
Toplinska izolacija ( fibran XPS 400-L)	0,08	0,30	0,024
Hidroizolacija + parna brana	0,01	20,0	0,20
Zaštita hidroizolacije (estrih)	0,08	25,0	2,00
Tartan	0,015	7,60	0,114

Ukupno dodatno stalno opterećenje: 2,688 kN/m<sup>2</sup>

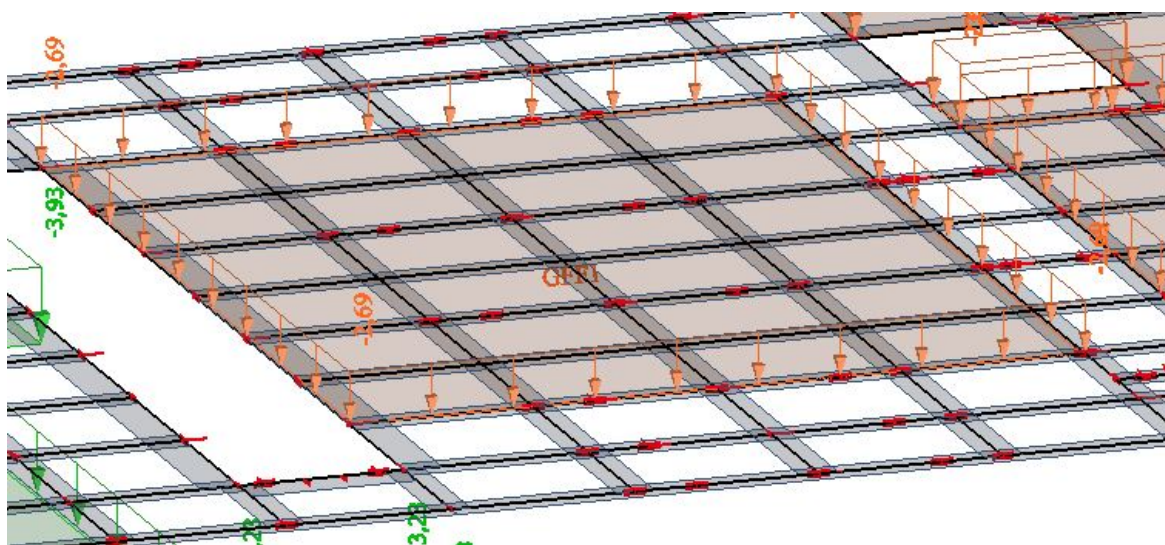

*Slika 3.5. Prikaz raspodjele dodatnog stalnog opterećenja- kat (košarkaški teren)*

## f) Pješačke rampe

Pod dodatnim stalnim opterećenjem podrazumijevamo slojeve krovne konstrukcije.

Naravno, ovdje nije uključena težina ab ploče jer je ona zadana u numeričkom modelu.

Slojevi krovne konstrukcije	d (m)	$\gamma$ (kN/m <sup>3</sup> )	d · $\gamma$ (kN/m <sup>2</sup> )
Hidroizolacija	0,01	20,0	0,20
Zaštita hidroizolacije (estrih-zaglađeni)	0,06	25,0	1,50

Ukupno dodatno stalno opterećenje: 1,70 kN/m<sup>2</sup>

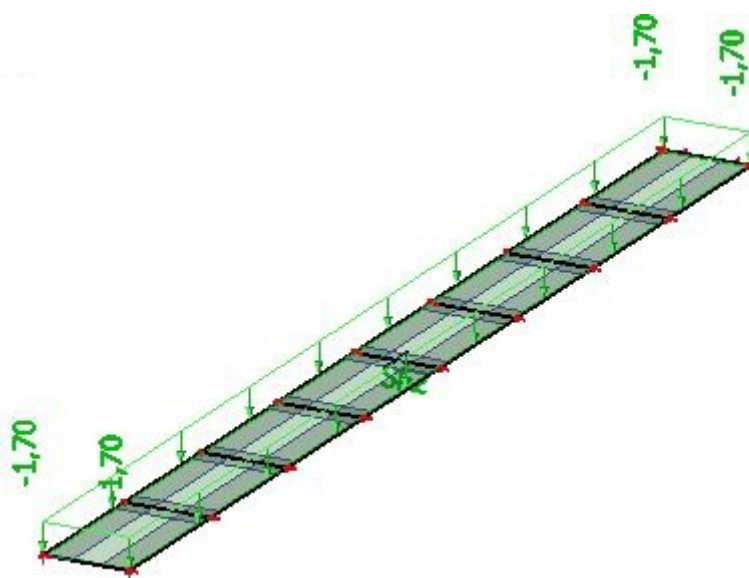

*Slika 3.6. Prikaz raspodjele dodatnog stalnog opterećenja- pješačke rampe*



### 3.3. Promjenjivo (pokretno) opterećenje

#### a) Ravni prohodni krov

-prostorije bez prepreka za kretanje ljudi, izložbeni prostori, pristupi javnim i državnim zgradama - 5 kN/m<sup>2</sup>

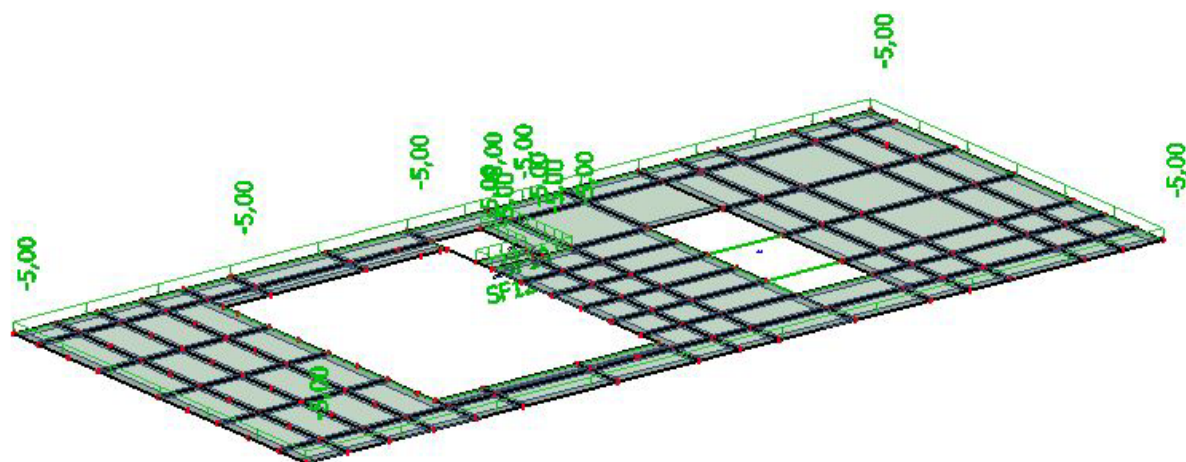

*Slika 3.7. Prikaz raspodjele pokretnog opterećenja- ravni krov*

#### b) Kat objekta

- prostorije bez prepreka za kretanje ljudi, izložbeni prostori, pristupi javnim i državnim zgradama - 5 kN/m<sup>2</sup>

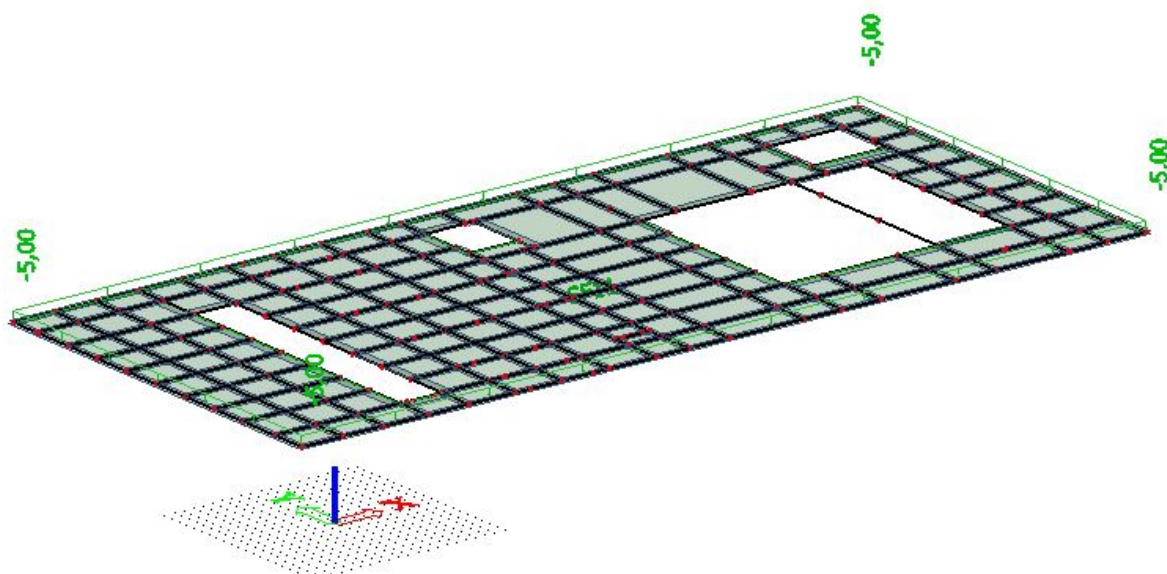

*Slika 3.8. Prikaz raspodjele pokretnog opterećenja- kat objekta*

## c) Pješačke rampe

- prostorije bez prepreka za kretanje ljudi, izložbeni prostori, pristupi javnim i državnim zgradama - 5 kN/m<sup>2</sup>

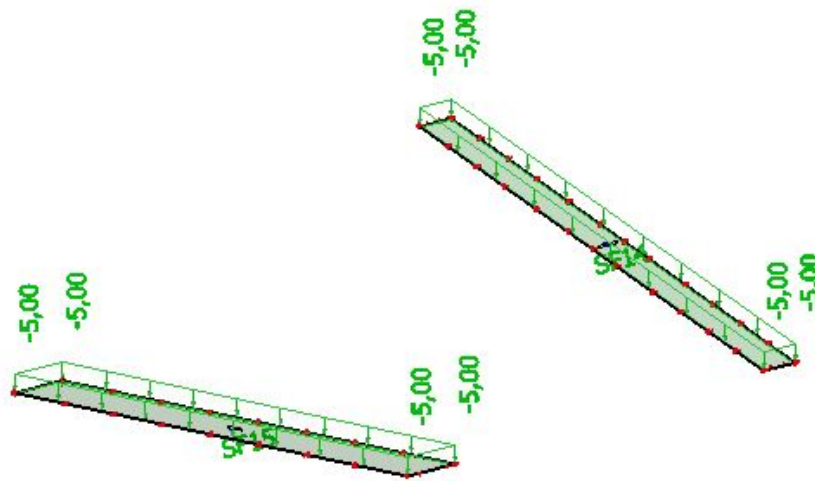

*Slika 3.9. Prikaz raspodjele pokretnog opterećenja- pješačke rampe*

### 3.4. Opterećenje snijegom

Opterećenje snijegom na krov

$$s = \mu_1 \cdot C_e \cdot C_t \cdot s_k \text{ [kN/m}^2\text{]}$$

- $\mu_1$  - koeficijent oblika opterećenja snijegom (ovisi o obliku krova)
- $C_e$  - koeficijent izloženosti (obično se usvaja vrijednost 1,0)
- $C_t$  - toplinski koeficijent (obično se usvaja vrijednost 1,0)
- $s_k$  - karakteristična vrijednost opterećenja snijegom na tlu (kN/m<sup>2</sup>)

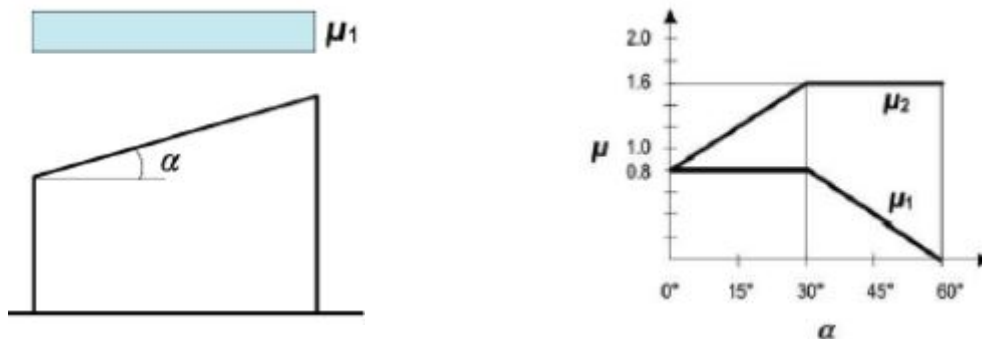

Slika 3.10. Koeficijent oblika opterećenja snijegom

Kut nagiba krova $\alpha$	$0^\circ \leq \alpha \leq 30^\circ$	$30^\circ < \alpha < 60^\circ$	$\alpha \geq 60^\circ$
$\mu_1$	0,8	$0,8 (60 - \alpha) / 30$	0,0
$\mu_2$	$0,8 + 0,8 \alpha / 30$	1,6	-

-za krov nagiba  $\alpha = 0^\circ$  očitana vrijednost  $\mu_1 = 0,8$

Prema karti snijega za Republiku Hrvatsku ova građevina upada u 1. Područje – priobalje i otoci te prema nadmorskoj visini do 100 m očitana je vrijednost  $s_k$  (karakteristična vrijednost opterećenja snijegom na tlu )  $\longrightarrow s_k = 0,50 \text{ kN/m}^2$



Slika 3.11. Karta snijega za Republiku Hrvatsku

Nadmorska visina do [m]	1. područje – priobalje i otoci [kN/m <sup>2</sup> ]	2. područje – zaleđe Dalmacije, Primorja i Istre [kN/m <sup>2</sup> ]	3. područje – kontinentalna Hrvatska [kN/m <sup>2</sup> ]	4. područje – gorska Hrvatska [kN/m <sup>2</sup> ]
100	0,50	0,75	1,00	1,25
200	0,50	0,75	1,25	1,50
300	0,50	0,75	1,50	1,75
400	0,50	1,00	1,75	2,00
500	0,50	1,25	2,00	2,50
600	0,50	1,50	2,25	3,00
700	0,50	2,00	2,50	3,50
800	0,50	2,50	2,75	4,00
900	1,00	3,00	3,00	4,50
1 000	2,00	4,00	3,50	5,00
1 100	3,00	5,00	4,00	5,50
1 200	4,00	6,00	4,50	6,00
1 300	5,00	7,00		7,00
1 400	6,00	8,00		8,00
1 500		9,00		9,00
1 600		10,00		10,00
1 700		11,00		11,00
1 800		12,00		

Tablica 3.1. Karakteristične vrijednosti opterećenja snijegom za pojedina područja i nadmorske visine

$$s = \mu_1 \cdot C_e \cdot C_t \cdot s_k \text{ [kN/m}^2\text{]}$$

$$- \mu_1 = 0,8$$

$$- C_e = 1,0$$

$$- C_t = 1,0$$

$$- s_k = 0,5 \text{ kN/m}^2$$

$$\Rightarrow s_1 = 0,8 \cdot 1,0 \cdot 1,0 \cdot 0,5 = 0,4 \text{ [kN / m}^2\text{]}$$

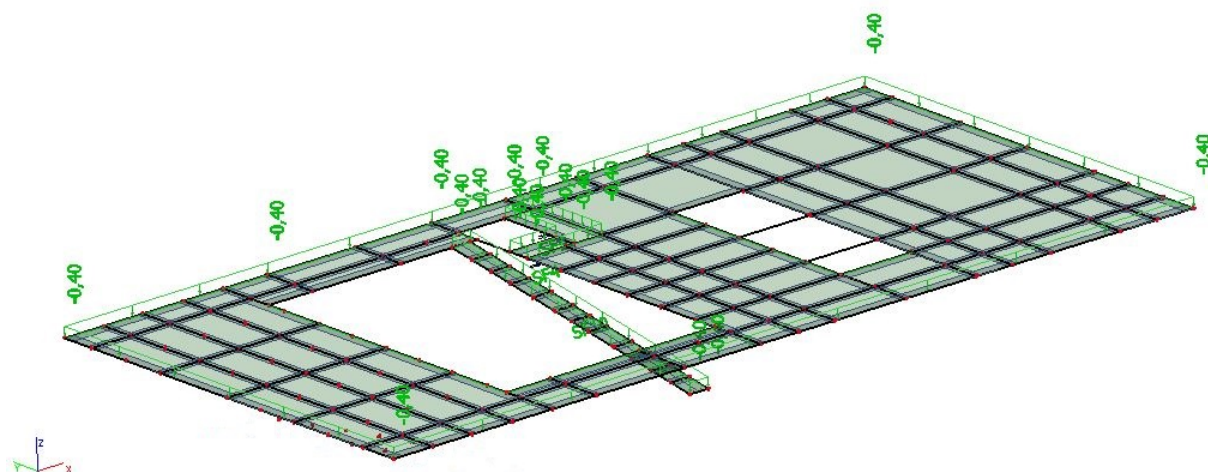

*Slika 3.12. Prikaz raspodjele opterećenja snijegom-ravni krov*

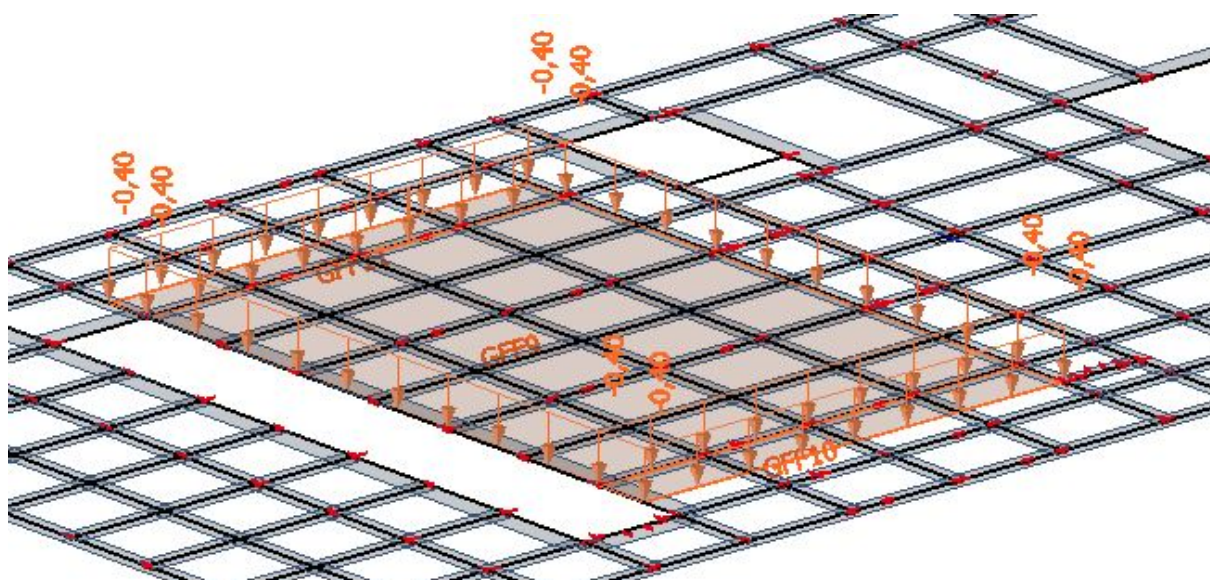

*Slika 3.13. Prikaz raspodjele opterećenja snijegom-otvoreni dio kata (košarkaški teren)*

### 3.5. Opterećenje vjetrom

Opterećenjem vjetrom (okomito na površinu) definira se prema izrazu:

- pritisak vjetra na vanjske površine:  $w_e = q_p |z_e| \cdot c_{pe}$  [kN/m<sup>2</sup>]

- pritisak vjetra na unutarnje površine:  $w_i = q_p |z_i| \cdot c_{pi}$  [kN/m<sup>2</sup>]

gdje je:

$q_p |z_{e(i)}|$  – pritisak brzine vjetra pri udaru,

$z_{e(i)}$  – referentna visina za vanjski (unutarnji) pritisak

$c_{pe}$  – koeficijent pritiska za vanjski vjetar

$c_{pi}$  – koeficijent pritiska za unutarnji vjetar

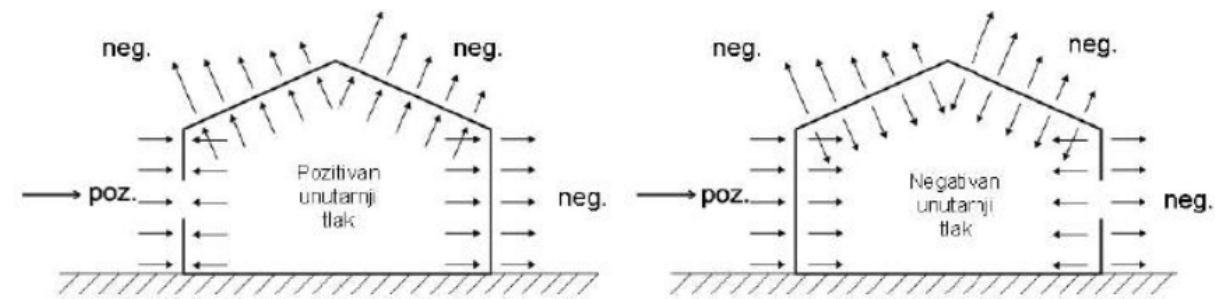

Slika 3.14. Pozitivni i negativni koeficijent pritiska vjetra

Određivanje pritiska vjetra pri udaru

-osnovni pritisak vjetra  $q_b$  određuje se prema formuli

$$q_b = \frac{1}{2} \cdot \rho \cdot v_b^2 \text{ [kN/m}^2\text{]}$$

gdje je:

$v_b$  – osnovna brzina vjetra

$\rho$  – gustoća zraka (usvaja se vrijednosti iz propisa  $\rho=1,25 \text{ kg/m}^3$ )

Osnovna brzina vjetra  $v_b$  računa se dalje prema izrazu:

$$v_b = c_{dir} \cdot c_{season} \cdot v_{b0} \text{ [m/s]}$$

gdje je:

$v_{b,0}$  – fundamentalna vrijednost osnovne brzine vjetra (očitava se iz karte )

$c_{dir}$  – koeficijent smjera vjetra (obično uzima vrijednost 1,0)

$c_{season}$  – koeficijent ovisan o godišnjem dobu (obično uzima vrijednost 1,0)

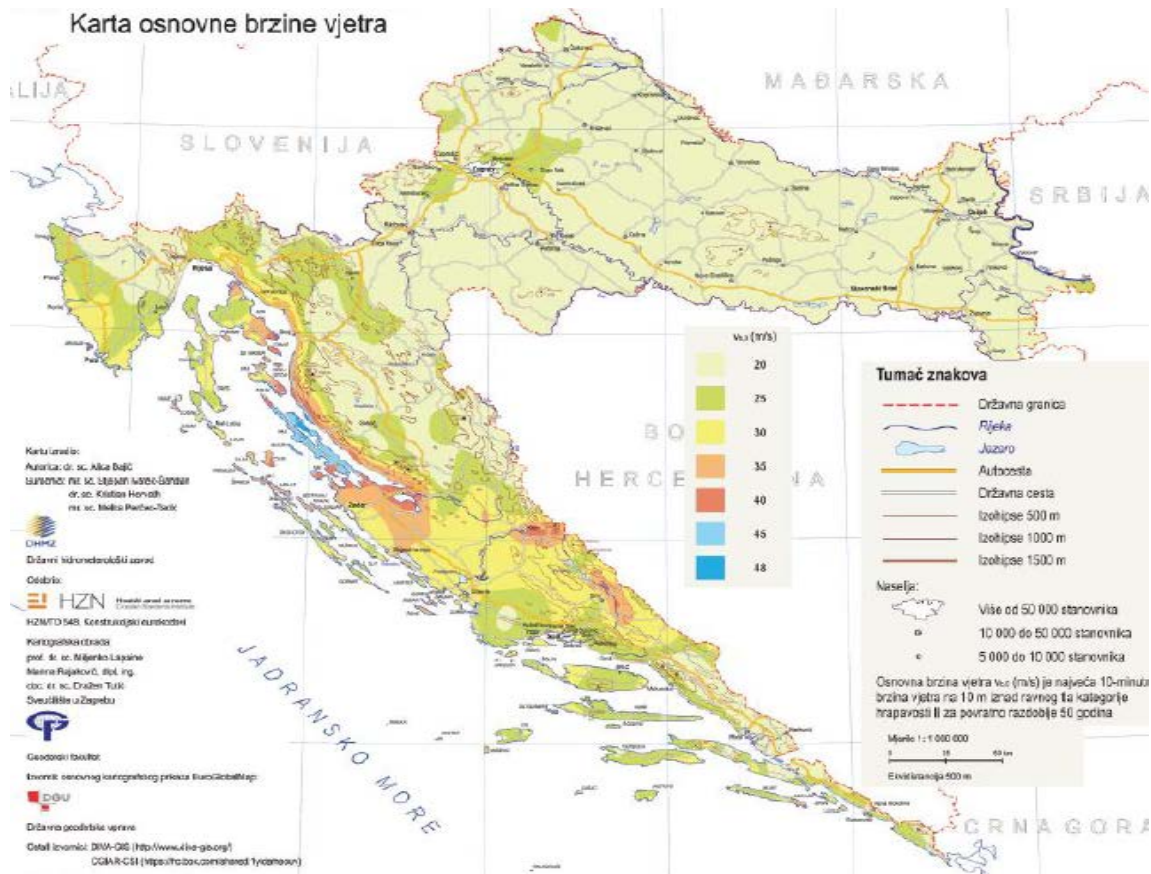

Slika 3.15. Zemljovid područja opterećenja vjetrom

Osnovni pritisak vjetra:

$v_{b,0} = 30 \text{ m/s}$  - očitano sa zemljovida za područje opterećenja vjetrom-Split (Zenta)

$$c_{dir} = c_{season} = 1,0$$

$$v_b = v_{b,0} \cdot c_{dir} \cdot c_{season} = 30 \cdot 1,0 \cdot 1,0 = 30,0 \text{ m/s}$$

$$\rho = 1,25 \text{ kg/m}^3$$

$$q_b = \frac{1}{2} \cdot \rho \cdot v_b^2 = \frac{1}{2} \cdot 1,25 \cdot 30,0^2 = 0,56 \text{ kN/m}^2$$

$$q_p |z_e| = c_e(z) \cdot q_b$$

$c_e(z)$  - faktor izloženosti, očitano iz dijagrama za  $z = 10, 15 \text{ m}$  i 0 kategoriju zemljišta:

Kategorija terena		$z_0$ [m]	$z_{min}$ [m]
0	More ili priobalna područja izložena otvorenom moru	0,003	1
I	Jezeru ili ravna i horizontalno položena područja sa zanemarivom vegetacijom i bez prepreka	0,01	1
II	Područja s niskom vegetacijom, npr. travom, i izoliranim preprekama (drveće, zgrade) s razmakom najmanje 20 visina prepreke	0,05	2
III	Područja sa stalnim pokrovom od vegetacije ili zgrade ili područja s izoliranim preprekama s razmakom najviše 20 visina prepreke (npr. sela, predgrađa, stalna šuma)	0,3	5
IV	Područja s najmanje 15 % površine pokrivena zgradama čija prosječna visina premašuje 15 m	1,0	10

Tablica 3.2. Vrijednosti  $z_0$  i  $z_{min}$  za različite kategorije terena

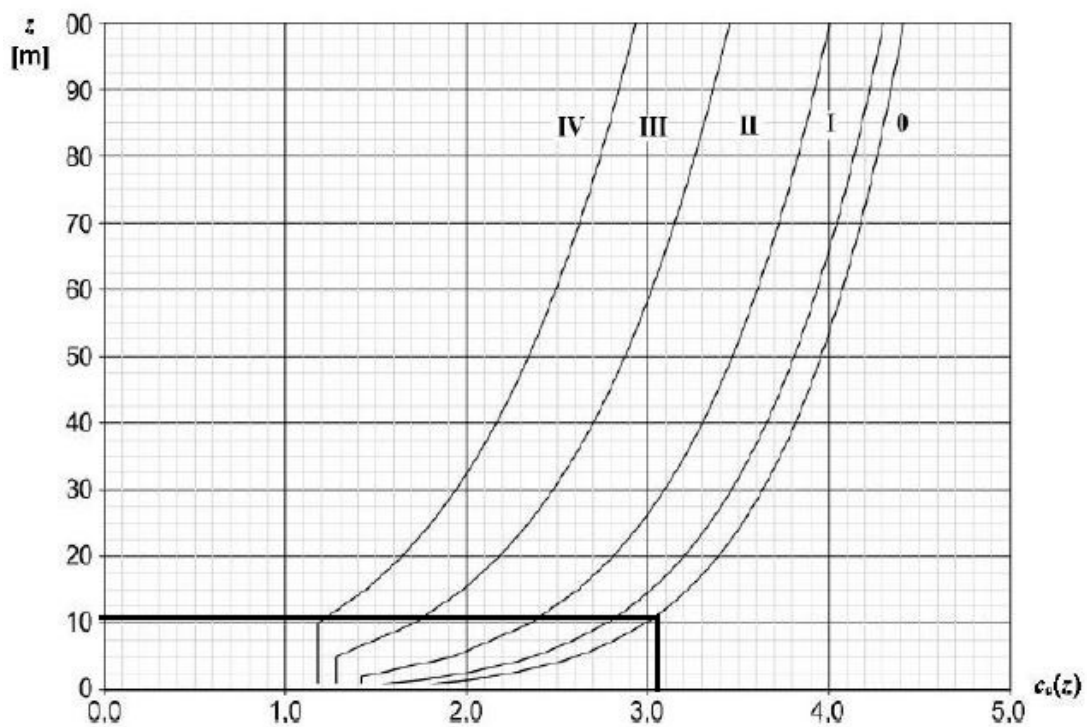

Slika 3.16. Grafički prikaz faktora izloženosti

$C_{e(z)}=3,05$  -očitan faktor izloženosti sa slike 3.16.

Pritisak brzine vanjskog vjetra pri udaru:

$$q_p |z_e| = 3,05 \cdot 0,56 = 1,71 \text{ kN/m}^2$$



**Određivanje koeficijenta vanjskog pritiska vjetra**-vjetar iz smjera y

Za ravne krovove koeficijenti vanjskog pritiska određuju se tako da se krovna površina podijeli na zone, dok se referentna visina  $z_e$  uzima kao ukupna visina građevine.

Koeficijenti tlaka za svako područje ovise o veličini površine opterećene zone građevine.

Dopušta se linearna interpolacija između kutova nagiba krovova (osim kad je kut između  $-5^\circ$  i  $+5^\circ$ , tada se koriste podaci za ravne krovove).

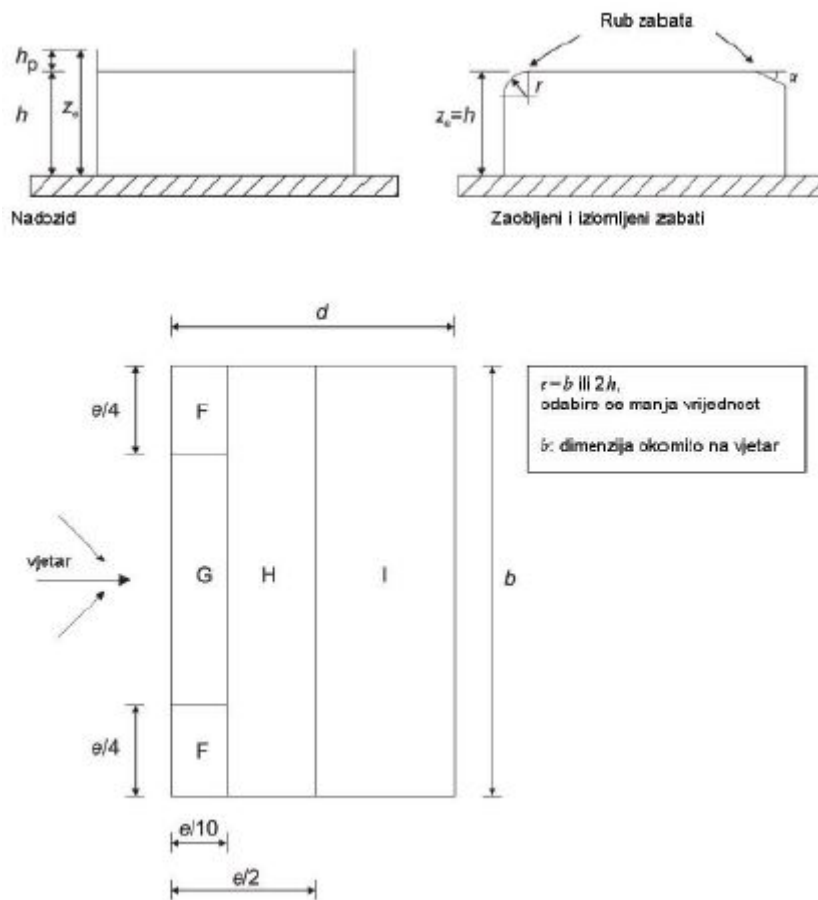

Slika 3.17. Prikaz područja vjetra za ravne krovove

$$e = \min (b \text{ ili } 2h) \rightarrow e = [87,8\text{m} , 2 \cdot h = 2 \cdot 10,15 = 20,3\text{m}] = 20,3 \text{ m}$$

$$e/2 = 20,3/2 = 10,15\text{m} \quad e/4 = 20,3/4 = 5,08\text{m} \quad e/10 = 20,3/10 = 2,03\text{m}$$

Vrsta krova		Područje						I	
		F		G		H		c <sub>pe,10</sub>	c <sub>pe,1</sub>
		c <sub>pe,10</sub>	c <sub>pe,1</sub>	c <sub>pe,10</sub>	c <sub>pe,1</sub>	c <sub>pe,10</sub>	c <sub>pe,1</sub>		
Oširi zabati		-1,8	-2,5	-1,2	-2,0	-0,7	-1,2	+0,2	-0,2
S nadocidima	λ <sub>p</sub> /λ <sub>s</sub> = 0,025	-1,8	-2,2	-1,1	-1,8	-0,7	-1,2	+0,2	-0,2
	λ <sub>p</sub> /λ <sub>s</sub> = 0,05	-1,4	-2,0	-0,9	-1,6	-0,7	-1,2	+0,2	-0,2
	λ <sub>p</sub> /λ <sub>s</sub> = 0,10	-1,2	-1,8	-0,8	-1,4	-0,7	-1,2	+0,2	-0,2
Zaobljeni zabati	r/k = 0,05	-1,0	-1,5	-1,2	-1,8	-0,4	-0,3	+0,2	-0,2
	r/k = 0,10	-0,7	-1,2	-0,8	-1,4	-0,3	-0,3	+0,2	-0,2
	r/k = 0,20	-0,5	-0,8	-0,5	-0,8	-0,3	-0,3	+0,2	-0,2
Izlomljeni zabati	α = 30°	-1,0	-1,5	-1,0	-1,5	-0,3	-0,4	+0,2	-0,2
	α = 45°	-1,2	-1,8	-1,3	-1,9	-0,4	-0,4	+0,2	-0,2
	α = 60°	-1,3	-1,9	-1,3	-1,9	-0,5	-0,5	+0,2	-0,2

NAPOMENA 1: Za krovove s nadocidima ili zaobljenim zabatima, smije se upotrebljavati linearna interpolacija za međuvrijednosti λ<sub>p</sub>/λ<sub>s</sub> i r/k.  
 NAPOMENA 2: Za krovove s izlomljenim zabatima, smije se upotrebljavati linearna interpolacija između α = 30°, 45° i α = 60°. Za α > 60° smije se upotrebljavati linearna interpolacija između vrijednosti za α = 60° i vrijednosti za ravne krovove s oštrim (izlomljenim) zabatima.  
 NAPOMENA 3: U području I, gdje su dane i negativne vrijednosti, u obzir treba uzeti obje vrijednosti.  
 NAPOMENA 4: Za sami izlomljeni zabat, koeficijent vanjskog tlaka dani su u tablici 7.4a „Koeficijenti vanjskog tlaka za dvodimenzionalne krovove; smjer vjetrova 0°“, područje F i G, ovisno o nagibu izlomljenog zabata.  
 NAPOMENA 5: Za sami zaobljeni zabat, koeficijenti vanjskog tlaka dani su linearnom interpolacijom duž linije, između vrijednosti na zidu i na krovu.  
 NAPOMENA 6: Za mansardne strene čije su horizontalne dimenzije manje od 1/10 treća uzeti vrijednosti za oštre strehe. Za definiciju ε vidjeti sliku 7.6 (b).

Tablica 3.3. Vrijednosti koeficijenata vanjskog tlaka za ravne krovove

PODRUČJE	c <sub>pe,10</sub> (+)	c <sub>pe,10</sub> (-)
F	/	-1,8
G	/	-1,2
H	/	-0,7
I	+0,2	-0,2

Tablica 3.4. Očitane vrijednosti koeficijenata vanjskog tlaka za ravne krovove

Pritisak vjetra na unutarnje površine:

$$w_i = q_p(z_i) \cdot c_{pi} \quad [\text{kN/m}^2]$$

q<sub>p</sub>(z<sub>e(i)</sub>) – pritisak brzine vjetra pri udaru,

z<sub>e(i)</sub> – referentna visina za vanjski (unutarnji) pritisak

c<sub>pi</sub> – koeficijent pritiska za unutarnji vjetar

Pritisak brzine unutarnjeg vjetra pri udaru:

$$q_p(z_i) = 3,05 \cdot 0,56 = 1,71 \text{ kN/m}^2$$

Koeficijenti unutarnjeg pritiska c<sub>pi</sub>:

Tamo gdje za neki određeni slučaj nije moguća procjena vrijednosti koeficijenta  $\mu$  ili se smatra neopravdanom, za  $c_{pi}$  odabiremo nepovoljniju vrijednost između  $+0.2$  i  $-0.3$ .

**PRITISAK VJETRA NA UNUTARNJE POVRŠINE:**

$$w_{i,1} = q_p |z_i| \cdot c_{pi} = 1,71 \cdot (+0.2) = +0,340 \text{ kN/m}^2$$

$$w_{i,2} = q_p |z_i| \cdot c_{pi} = 1,71 \cdot (-0.3) = -0,513 \text{ kN/m}^2$$

**PRITISAK VJETRA NA VANJSKE POVRŠINE:**

$$w_e = q_p |z_e| \cdot c_{pe} = 1,71 \cdot c_{pe} \text{ [kN/m}^2\text{]}$$

PODRUČJE		F	G	H	I
$C_{pe,10}$		-1,8	-1,2	-0,7	-0,2
		/	/	/	+0,2
$w_{e1}$	[kN/m <sup>2</sup> ]	-3,080	-2,050	-1,200	-0,340
$w_{e2}$		/	/	/	+0,340
$w_{i1}$		+0,340	+0,340	+0,340	+0,340
$w_{i2}$		-0,513	-0,513	-0,513	-0,513
<b>w<sub>1</sub></b>		-3,42	-2,39	-1,54	-0,68
<b>w<sub>2</sub></b>		-2,56	-1,54	-0,69	+0,17
<b>w<sub>3</sub></b>		-0,34	-0,34	-0,34	0,00
<b>w<sub>4</sub></b>		+0,513	+0,513	+0,513	+0,85

*Tablica 3.5. Rezultirajuće djelovanje vjetra*

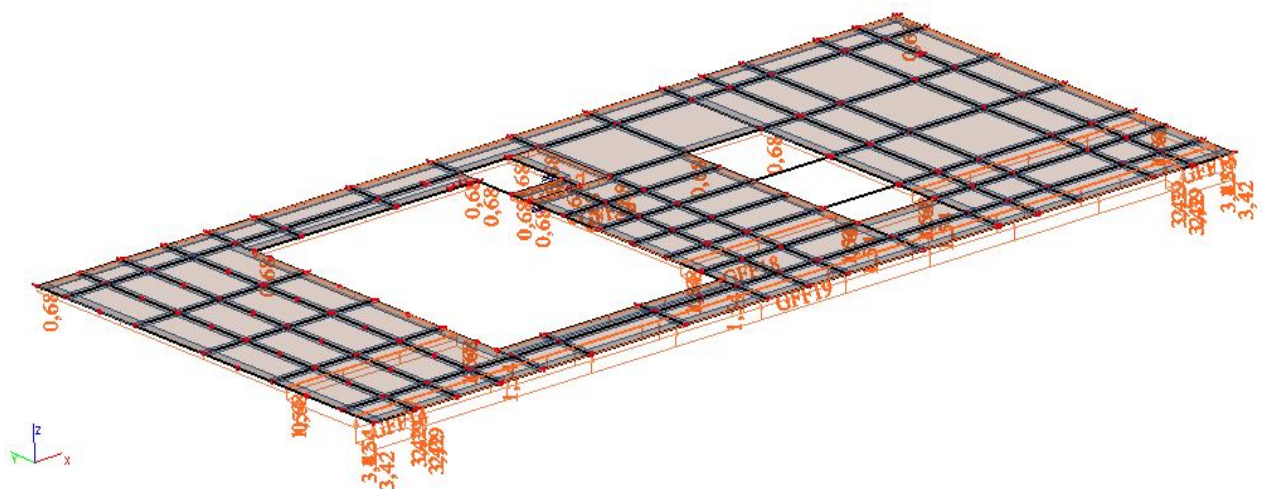

*Slika 3.18. Prikaz raspodjele opterećenjem vjetrom iz smjera y ( $w_1$ ) -područje F,G,H i I*

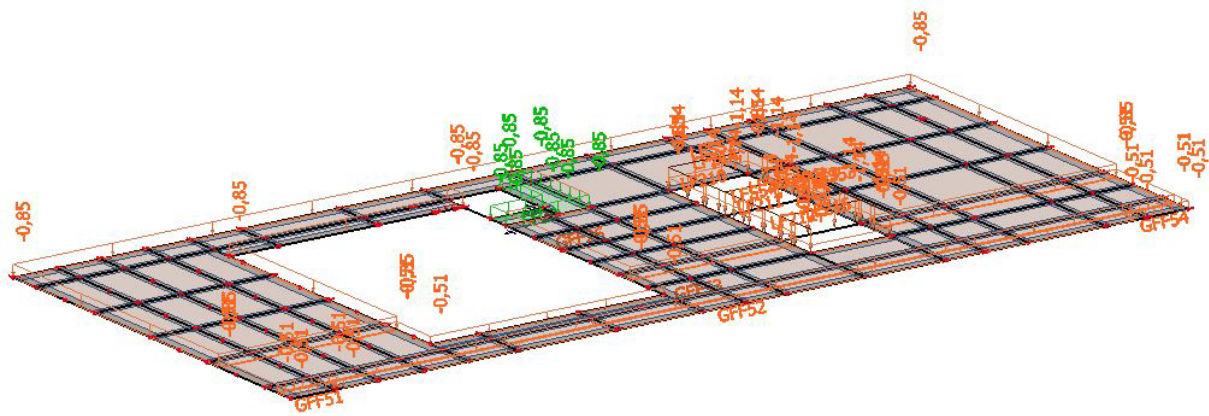

Slika 3.19. Prikaz raspodjele opterećenjem vjetrom iz smjera y ( $w_4$ ) -područje F,G,H i I

Određivanje vjetra za vertikalne zidove

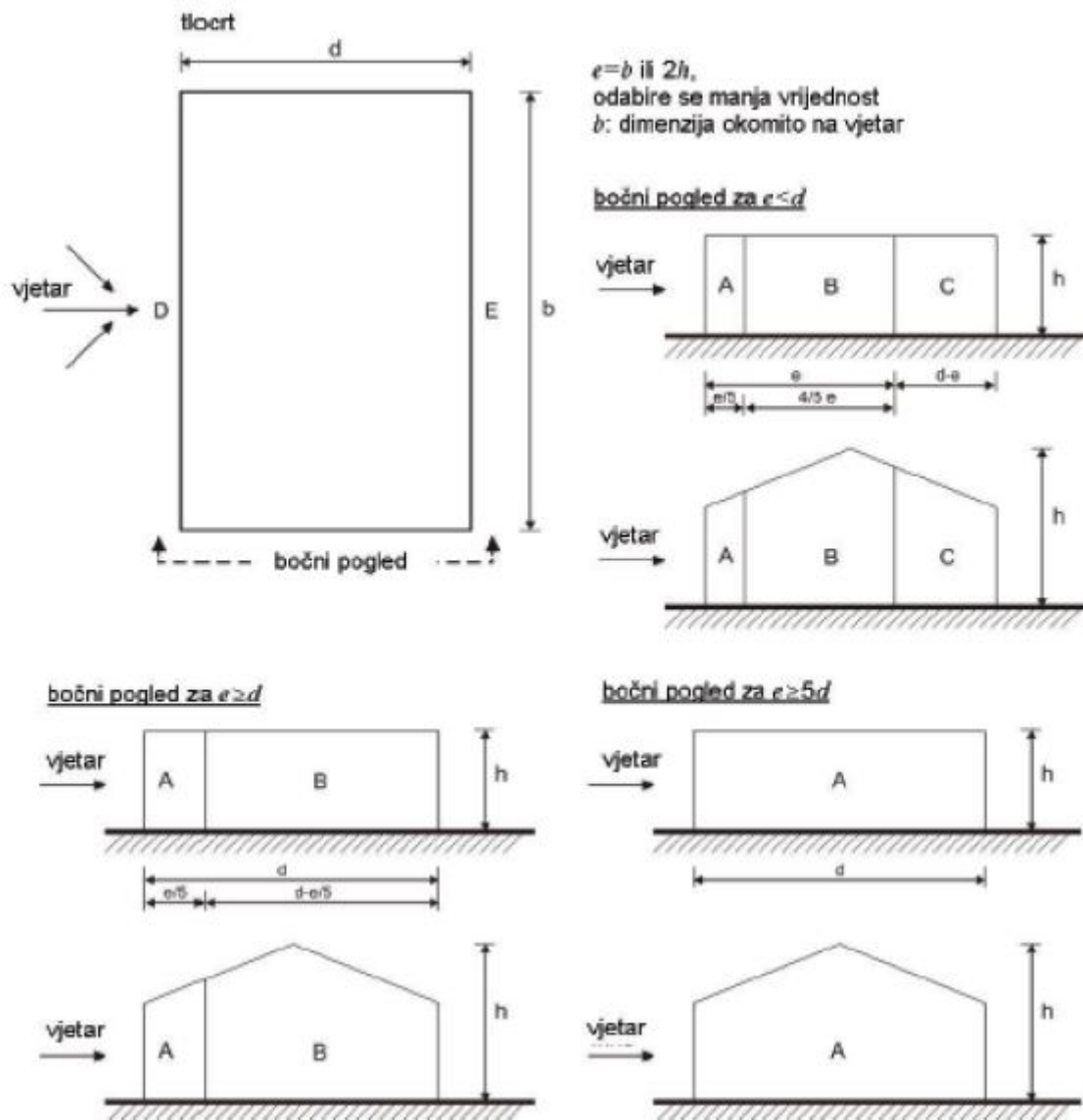

Slika 3.20. Prikaz područja vjetra za vertikalne zidove

$$e < d \quad e = \min (b \text{ ili } 2h) \rightarrow e = [87,8\text{m} , 2 \cdot h = 2 \cdot 10,15 = 20,3\text{m}] = 20,3 \text{ m}$$

$$e/5 = 20,3/2 = 4,06 \text{ m} \quad 4/5e = 20,3/4 = 16,24 \text{ m} \quad d - e = 39,07 - 20,3 = 18,77 \text{ m}$$

$$- \text{ za } h/d = 10,15/39,07 = 0,26$$

Pritisak vanjskog vjetra:

$$w_e = q_p |z_e| \cdot c_{pe} = 1,71 \cdot c_{pe} \text{ [kN/m}^2\text{]}$$

Pritisak unutarnjeg vjetra:

$$w_{i,1} = q_p |z_i| \cdot c_{pi} = 1,71 \cdot (+0.2) = +0,342 \text{ kN/m}^2$$

$$w_{i,2} = q_p |z_i| \cdot c_{pi} = 1,71 \cdot (-0.3) = -0,513 \text{ kN/m}^2$$

Područje	A		B		C		D		E	
<i>h/d</i>	<i>c<sub>pe,10</sub></i>	<i>c<sub>pe,1</sub></i>	<i>c<sub>pi,10</sub></i>	<i>c<sub>pi,1</sub></i>	<i>c<sub>pe,10</sub></i>	<i>c<sub>pe,1</sub></i>	<i>c<sub>pe,10</sub></i>	<i>c<sub>pe,1</sub></i>	<i>c<sub>pi,10</sub></i>	<i>c<sub>pi,1</sub></i>
5	-1,2	-1,4	-0,8	-1,1	-0,5		+0,8	+1,0	-0,7	
1	-1,2	-1,4	-0,8	-1,1	-0,5		+0,8	+1,0	-0,5	
≤ 0,25	-1,2	-1,4	-0,8	-1,1	-0,5		+0,7	+1,0	-0,3	

**Tablica 3.6.** Vrijednosti koeficijena vanjskog pritiska za vertikalne zidove

PODRUČJE	A	B	C	D	E	
<i>C<sub>pe,10</sub></i>	-1,2	-0,8	-0,5	+0,71	-0,31	
<i>w<sub>e1</sub></i>	[kN/m <sup>2</sup> ]	-2,052	-1,368	-0,855	+1,214	-0,53
<i>w<sub>i1</sub></i>		+0,342	+0,342	+0,342	+0,342	+0,342
<i>w<sub>i2</sub></i>		-0,513	-0,513	-0,513	-0,513	-0,513
<b>We</b>		-2,565	-1,881	-1,368	+1,727	-0,872

**Tablica 3.7.** Rezultirajuće djelovanje vjetra

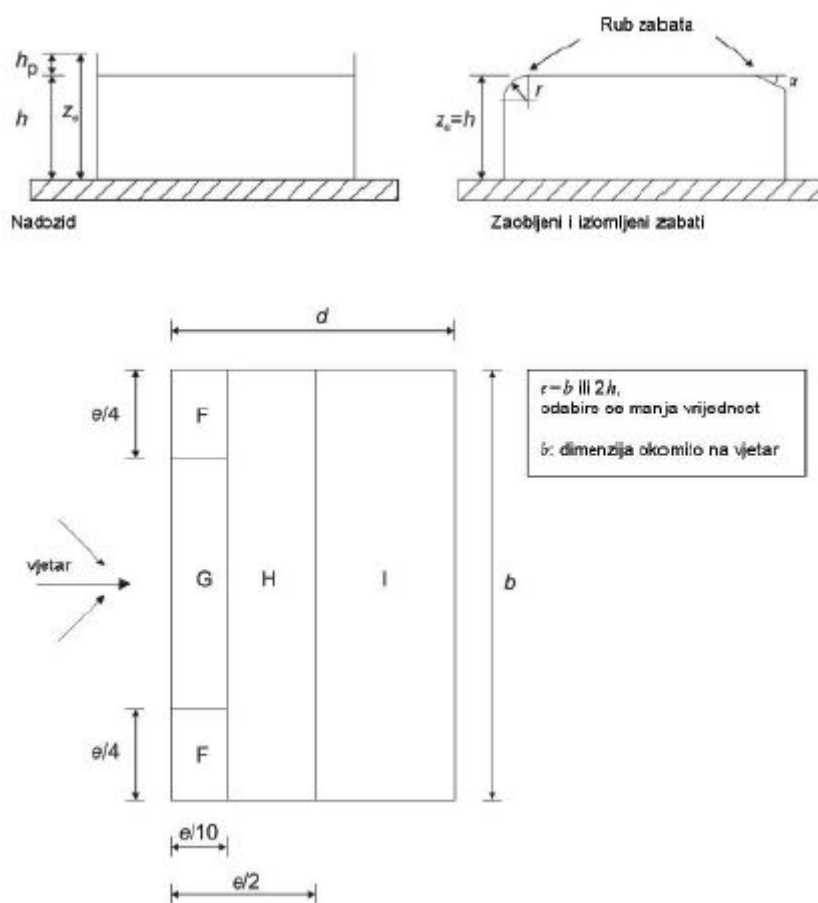

**Određivanje koeficijenta vanjskog pritiska vjetra**-vjetar iz smjera x

Slika 3.23. Prikaz područja vjetra za ravne krovove

$$e = \min(b \text{ ili } 2h) \rightarrow e = [39,07\text{m} , 2 \cdot h = 2 \cdot 10,15 = 20,3\text{m}] = 20,3 \text{ m}$$

$$e/2 = 20,3/2 = 10,15\text{m} \quad e/4 = 20,3/4 = 5,08\text{m} \quad e/10 = 20,3/10 = 2,03\text{m}$$

Vrsta krova		Područje						I	
		F		G		H		c <sub>pe,10</sub>	c <sub>pe,1</sub>
		c <sub>pe,10</sub>	c <sub>pe,1</sub>	c <sub>pe,10</sub>	c <sub>pe,1</sub>	c <sub>pe,10</sub>	c <sub>pe,1</sub>		
Oširi zabati		-1,8	-2,5	-1,2	-2,0	-0,7	-1,2	+0,2	-0,2
S nadocidima	h <sub>p</sub> /h = 0,025	-1,8	-2,2	-1,1	-1,8	-0,7	-1,2	+0,2	-0,2
	h <sub>p</sub> /h = 0,05	-1,4	-2,0	-0,9	-1,6	-0,7	-1,2	+0,2	-0,2
	h <sub>p</sub> /h = 0,10	-1,2	-1,8	-0,8	-1,4	-0,7	-1,2	+0,2	-0,2
Zaobljeni zabati	r/h = 0,05	-1,0	-1,5	-1,2	-1,8	-0,4	-0,3	+0,2	-0,2
	r/h = 0,10	-0,7	-1,2	-0,8	-1,4	-0,3	-0,3	+0,2	-0,2
	r/h = 0,20	-0,5	-0,8	-0,5	-0,8	-0,3	-0,3	+0,2	-0,2
Izlomljeni zabati	α = 30°	-1,0	-1,5	-1,0	-1,5	-0,3	-0,3	+0,2	-0,2
	α = 45°	-1,2	-1,8	-1,3	-1,9	-0,4	-0,4	+0,2	-0,2
	α = 60°	-1,3	-1,9	-1,3	-1,9	-0,5	-0,5	+0,2	-0,2

NAPOMENA 1: Za krovove s nadocidima ili zaobljenim zabatima, smije se upotrebljavati linearna interpolacija za međuvrijednosti h<sub>p</sub>/h i r/h.  
 NAPOMENA 2: Za krovove s izlomljenim zabatima, smije se upotrebljavati linearna interpolacija između α = 30°, 45° i α = 60°. Za α > 60° smije se upotrebljavati linearna interpolacija između vrijednosti za α = 60° i vrijednosti za ravne krovove s oštrim (izlomljenim) zabatima.  
 NAPOMENA 3: U području I, gdje su dane i negativne vrijednosti, u obzir treba uzeti obje vrijednosti.  
 NAPOMENA 4: Za sami izlomljeni zabat, koeficijent vanjskog tlaka dani su u tablici 7.4a. Koeficijenti vanjskog tlaka za dvodirne krovove; smjer vjetrova 0°, područje F i G, ovisno o nagibu izlomljenog zabata.  
 NAPOMENA 5: Za sami zaobljeni zabat, koeficijenti vanjskog tlaka dani su linearnom interpolacijom duž linije, između vrijednosti na zidu i na krovu.  
 NAPOMENA 6: Za mansardne strene čije su horizontalne dimenzije manje od 1/10 treća uzeti vrijednosti za oštre strehe. Za definiciju ε vidi sliku 7.6 (b).

Tablica 3.8. Vrijednosti koeficijenata vanjskog tlaka za ravne krovove

PODRUČJE	c <sub>pe,10</sub> (+)	c <sub>pe,10</sub> (-)
F	/	-1,8
G	/	-1,2
H	/	-0,7
I	+0,2	-0,2

Tablica 3.9. Očitane vrijednosti koeficijenata vanjskog tlaka za ravne krovove

Pritisak vjetra na unutarnje površine:

$$w_i = q_p(z_i) \cdot c_{pi} \quad [\text{kN/m}^2]$$

q<sub>p</sub>(z<sub>e(i)</sub>) – pritisak brzine vjetra pri udaru,

z<sub>e(i)</sub> – referentna visina za vanjski (unutarnji) pritisak

c<sub>pi</sub> – koeficijent pritiska za unutarnji vjetar

Pritisak brzine unutarnjeg vjetra pri udaru:

$$q_p(z_i) = 3,05 \cdot 0,56 = 1,71 \text{ kN/m}^2$$

Koeficijenti unutarnjeg pritiska c<sub>pi</sub>:



Tamo gdje za neki određeni slučaj nije moguća procjena vrijednosti koeficijenta  $\mu$  ili se smatra neopravdanom, za  $c_{pi}$  odabiremo nepovoljniju vrijednost između  $+0.2$  i  $-0.3$ .

**PRITISAK VJETRA NA UNUTARNJE POVRŠINE:**

$$w_{i,1} = q_p |z_i| \cdot c_{pi} = 1,71 \cdot (+0.2) = +0,340 \text{ kN/m}^2$$

$$w_{i,2} = q_p |z_i| \cdot c_{pi} = 1,71 \cdot (-0.3) = -0,513 \text{ kN/m}^2$$

**PRITISAK VJETRA NA VANJSKE POVRŠINE:**

$$w_e = q_p |z_e| \cdot c_{pe} = 1,71 \cdot c_{pe} \text{ [kN/m}^2\text{]}$$

PODRUČJE		F	G	H	I
$C_{pe,10}$		-1,8	-1,2	-0,7	-0,2
		/	/	/	+0,2
$w_{e1}$	[kN/m <sup>2</sup> ]	-3,080	-2,050	-1,200	-0,340
$w_{e2}$		/	/	/	+0,340
$w_{i1}$		+0,340	+0,340	+0,340	+0,340
$w_{i2}$		-0,513	-0,513	-0,513	-0,513
<b>w<sub>1</sub></b>		-3,42	-2,39	-1,54	-0,68
<b>w<sub>2</sub></b>		-2,56	-1,54	-0,69	+0,17
<b>w<sub>3</sub></b>		-0,34	-0,34	-0,34	0,00
<b>w<sub>4</sub></b>		+0,513	+0,513	+0,513	+0,85

Tablica 3.10. Rezultirajuće djelovanje vjetra

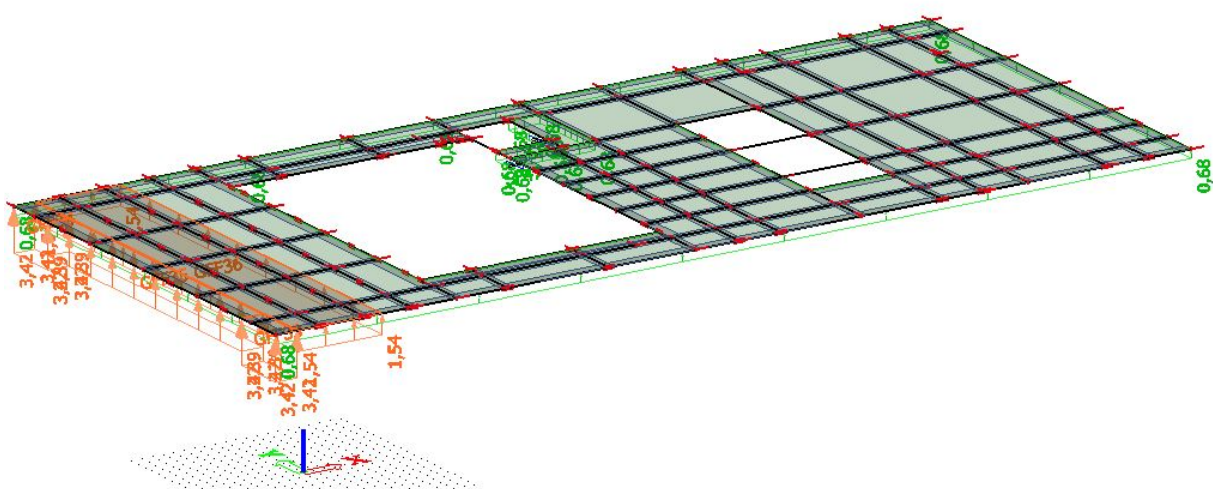

Slika 3.24. Prikaz raspodjele opterećenjem vjetrom iz smjera x ( $w_1$ ) -područje F,G,H i I

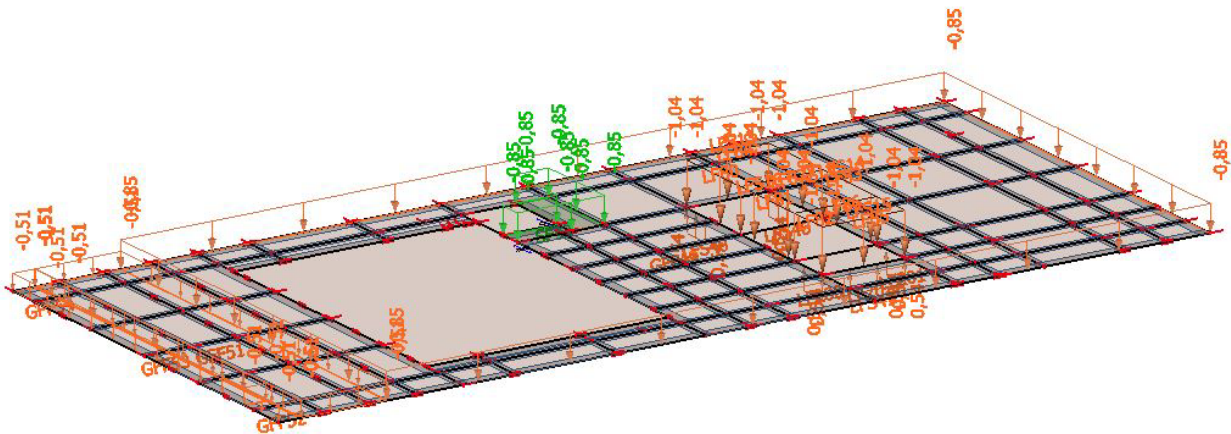

Slika 3.25. Prikaz raspodjele opterećenjem vjetrom iz smjera x ( $w_4$ )-područje F,G,H i I

Određivanje vjetra za vertikalne zidove

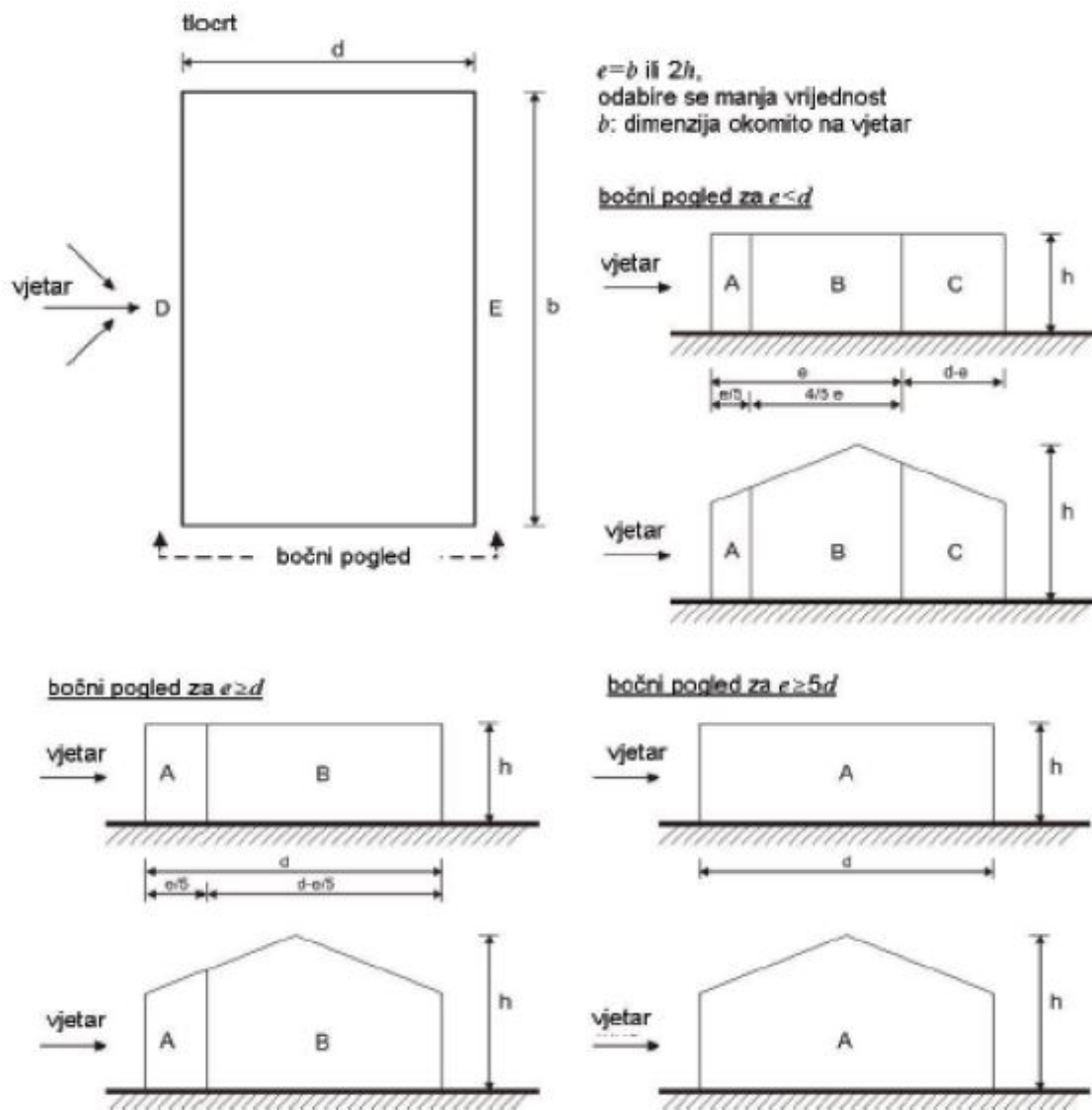

Slika 3.26. Prikaz područja vjetra za vertikalne zidove

$$e < d \quad e = \min(b \text{ ili } 2h) \rightarrow e = [39,07 \text{ m}, 2 \cdot h = 2 \cdot 10,15 = 20,3 \text{ m}] = 20,3 \text{ m}$$

$$e/5 = 20,3/5 = 4,06 \text{ m} \quad 4/5e = 20,3/4 = 16,24 \text{ m} \quad d - e = 39,07 - 20,3 = 18,77 \text{ m}$$

$$\text{- za } h/d = 10,15/87,8 = 0,12$$

#### Pritisak vanjskog vjetra:

$$w_e = q_p |z_e| \cdot c_{pe} = 1,71 \cdot c_{pe} \quad [\text{kN/m}^2]$$

#### Pritisak unutarnjeg vjetra:

$$w_{i,1} = q_p |z_i| \cdot c_{pi} = 1,71 \cdot (+0,2) = +0,342 \quad \text{kN/m}^2$$

$$w_{i,2} = q_p |z_i| \cdot c_{pi} = 1,71 \cdot (-0,3) = -0,513 \quad \text{kN/m}^2$$

Područje	A		B		C		D		E	
	$c_{pe,10}$	$c_{pe,1}$	$c_{pe,10}$	$c_{pe,1}$	$c_{pe,10}$	$c_{pe,1}$	$c_{pe,10}$	$c_{pe,1}$	$c_{pe,10}$	$c_{pe,1}$
5	-1,2	-1,4	-0,8	-1,1	-0,5		+0,8	+1,0	-0,7	
1	-1,2	-1,4	-0,8	-1,1	-0,5		+0,8	+1,0	-0,5	
$\leq 0,25$	-1,2	-1,4	-0,8	-1,1	-0,5		+0,7	+1,0	-0,3	

**Tablica 3.11.** Vrijednosti koeficijenata vanjskog pritiska za vertikalne zidove

PODRUČJE	A	B	C	D	E	
$c_{pe,10}$	-1,2	-0,8	-0,5	+0,71	-0,31	
$w_{e1}$	[kN/m <sup>2</sup> ]	-2,052	-1,368	-0,855	+1,214	-0,53
$w_{i1}$		+0,342	+0,342	+0,342	+0,342	+0,342
$w_{i2}$		-0,513	-0,513	-0,513	-0,513	-0,513
<b>We</b>		-2,565	-1,881	-1,368	+1,727	-0,872

**Tablica 3.12.** Rezultirajuće djelovanje vjetra

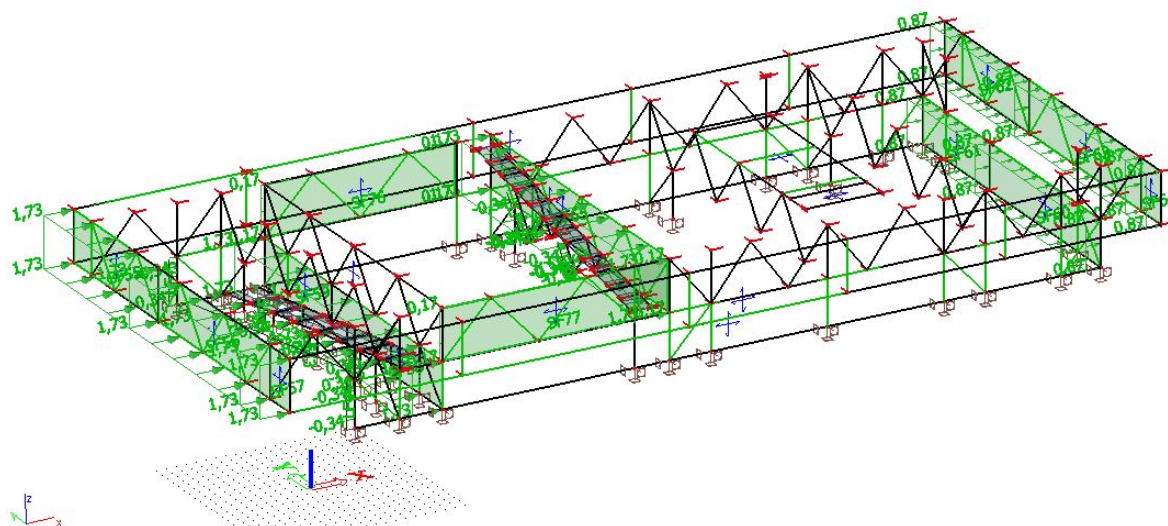

*Slika 3.27. Prikaz raspodjele opterećenjem vjetrom iz smjera x -područje D i E*

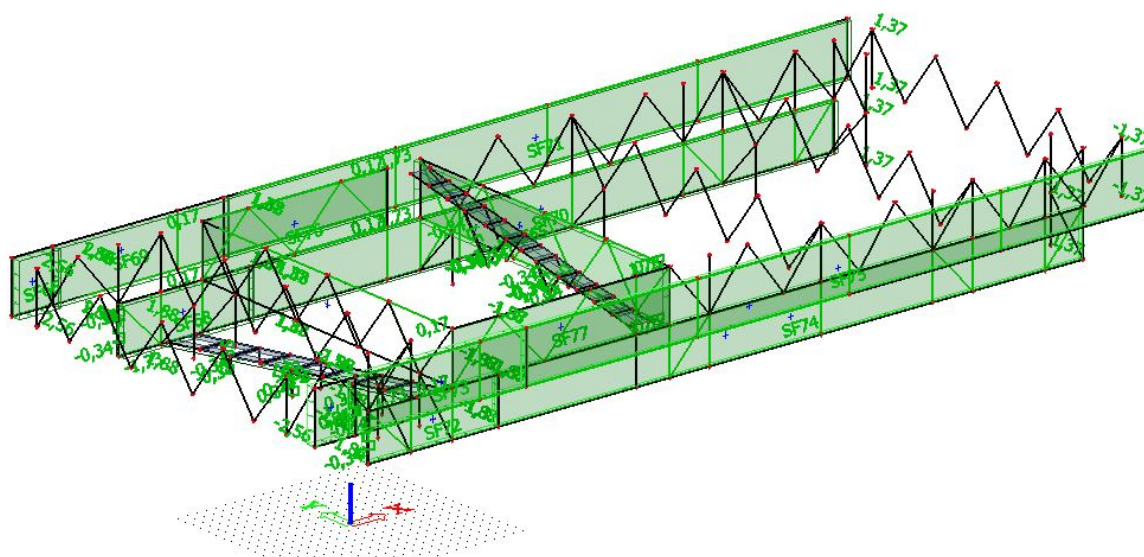

*Slika 3.28. Prikaz raspodjele opterećenjem vjetrom iz smjera x -područje A,B i C*

### 3.6. Opterećenje vjetrom trenjem na krovu

$$F_{fr} = c_{fr} \cdot q_p(z) \cdot A_{fr} \text{ - sila trenja}$$

$c_{fr} = 0,02$ - koef. trenja obloge krova (tartan)

$$q_p(z) = c_e(z) \cdot q_{ref} \text{ - tlak "vršne" (referentne) brzine}$$

$C_e(z)=3,05$ - koef. izloženosti

$q_{ref}$  - poredbeni tlak pri srednjoj brzini vjetra

$A_{fr}$  - površina usporedno sa smjerom vjetra

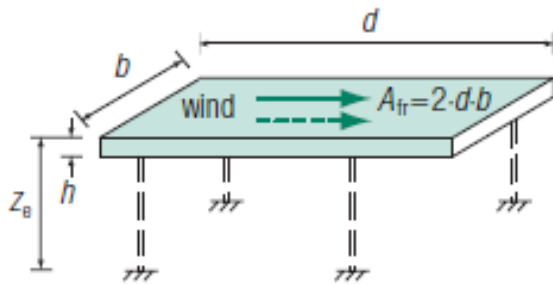

Referentna površina:

$$A_{fr} = b \cdot d = 87,8 \cdot 39,07 \text{ m} = 3430,35 \text{ m}^2$$

$$F_{fr} = 0,02 \cdot 3,05 \cdot 0,56 \cdot 3430,35 = 117,18 \text{ kN}$$

$$f_{fr} = 0,02 \cdot 3,05 \cdot 0,56 = 0,034 \text{ kN/m}^2$$

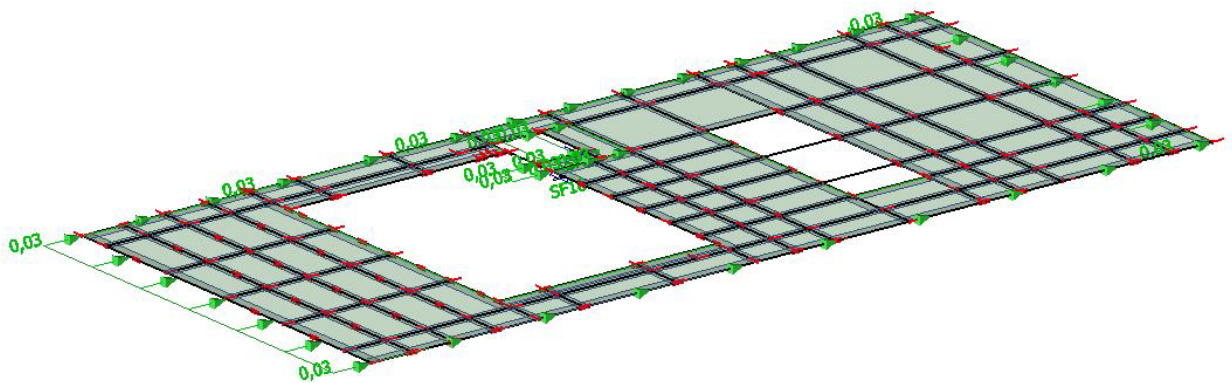

Slika 3.29. Prikaz raspodjele opterećenja-trenje u smjeru x

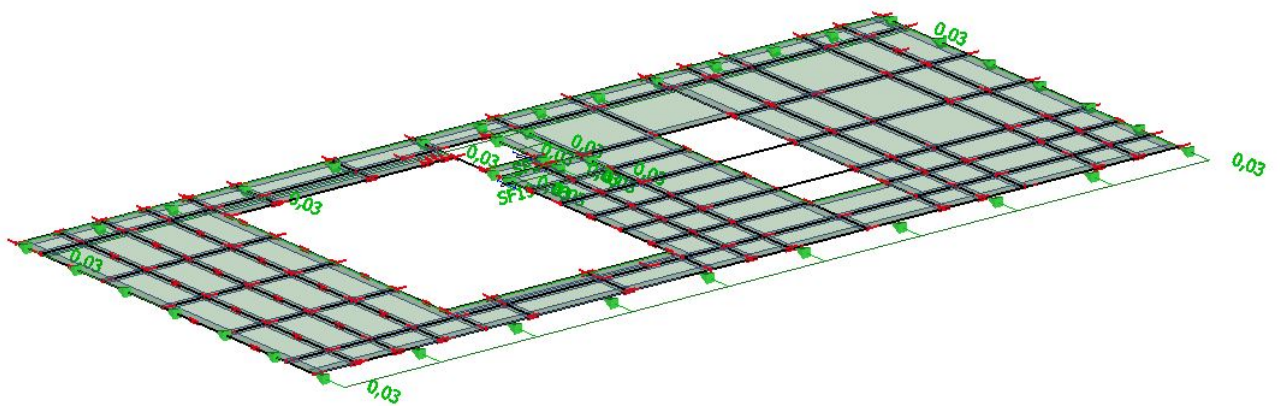

Slika 3.30. Prikaz raspodjele opterećenja-trenje u smjeru y

### 3.7. Temperaturno opterećenje

#### Opterećenje jednolikom temperaturom

- karakteristična max. i min. vanjska temperatura zraka, određena iz karte najviših i najnižih temperatura u hladu, prema područjima u ovisnosti o nadmorskoj visini.



Slika 3.31. Karta za  $T_{max}$

Nadmorska visina do [m]	I. područje [°C]	II. područje [°C]	III. područje [°C]	IV. područje [°C]
100	39	38	42	39
400	36	36	39	39
800	33	34	36	39
1200	30	32	34	--
1600	28	30	31	--

Tablica 3.13. Najviše temperature zraka u hladu u ovisnosti o nadmorskoj visini

$T_{max} = 39\text{ °C}$  Područje IV, nadmorska visina do 100 m

 Slika 3.32. Karta za  $T_{min}$ 

Nadmorska visina do [m]	I. područje [°C]	II. područje [°C]	III. područje [°C]	IV. područje [°C]	V. područje [°C]
100	-26	-26	-17	-10	-16
400	-23	-26	-19	-13	-18
800	-20	-26	-21	-17	-19
1200	-17	-26	-23	-20	-21
1600	—	-26	-24	-24	-23
>1600	—	-26	—	-26	-24

Tablica 3.14. Najniže temperature zraka u hladu u ovisnosti o nadmorskoj visini

$T_{min} = -10\text{ °C}$  Područje IV, nadmorska visina do 100 m

$$T_{\max} = 39\text{ }^{\circ}\text{C}$$

$$T_{\min} = -10\text{ }^{\circ}\text{C}$$

$T_0=10\text{ }^{\circ}\text{C}$  Pretpostavljena temperatura prilikom gradnje tj. montaže konstrukcije

$$\Delta T_{\text{pos}} = T_{\max} - T_0 = 39 - 10 = 29\text{ }^{\circ}\text{C} \quad \text{- zagrijavanje konstrukcije}$$

$$\Delta T_{\text{neg}} = T_{\min} - T_0 = -10 - 10 = -20\text{ }^{\circ}\text{C} \quad \text{- hlađenje konstrukcije}$$

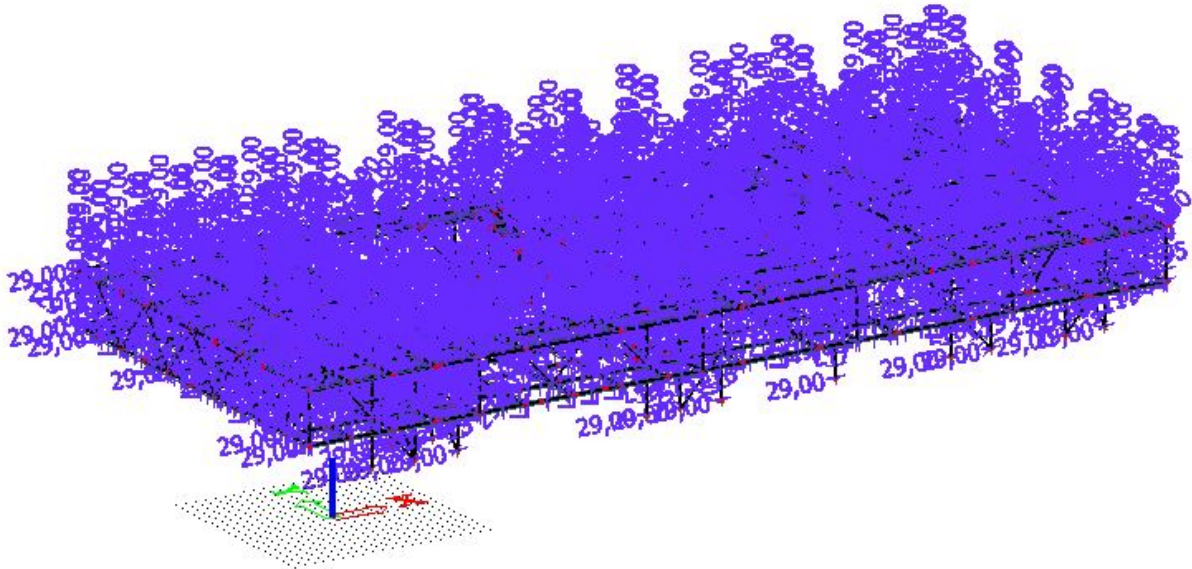

*Slika 3.33. Opterećenje jednolikom temperaturom  $\Delta T=29\text{ }^{\circ}\text{C}$*

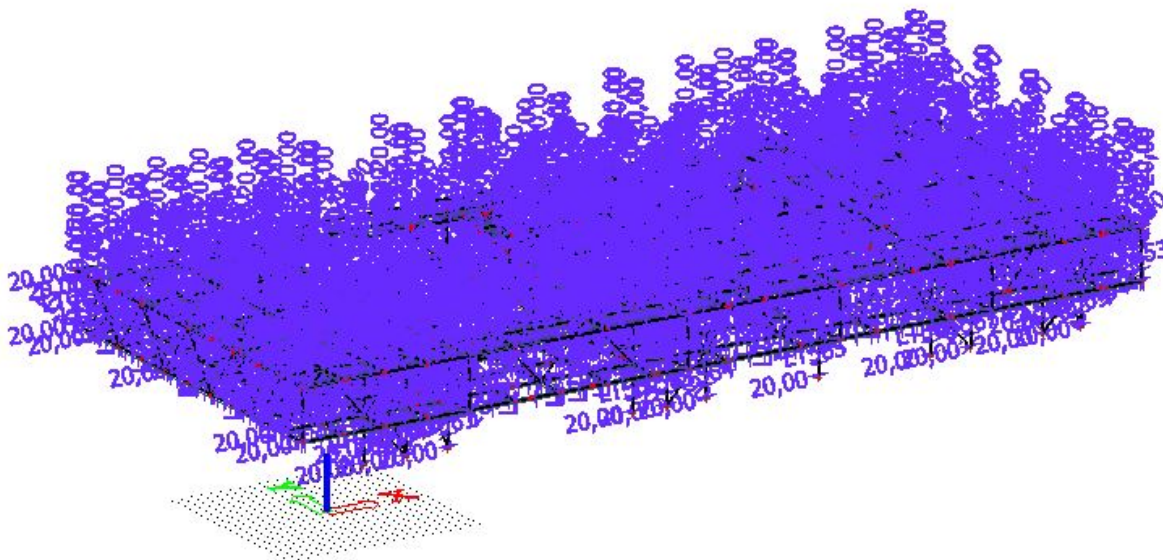

*Slika 3.34. Opterećenje jednolikom temperaturom  $\Delta T=20\text{ }^{\circ}\text{C}$*



### 3.8. Opterećenje potresom

Potresne sile proračunate su pojednostavljenim postupkom. Za proračun potresnog opterećenja korištena je višemodalna spektralna analiza. Građevina je smještena u Splitu, u VIII. potresnoj zoni prema važećoj seizmičkoj karti Republike Hrvatske.

Karte s tumačem su sastavni dio nacionalnog dodatka za niz normi HRN EN 1998-1:2011/NA:2011, Eurokod 8: Projektiranje potresne otpornosti konstrukcija - 1.dio: Opća pravila, potresna djelovanja i pravila za zgrade.

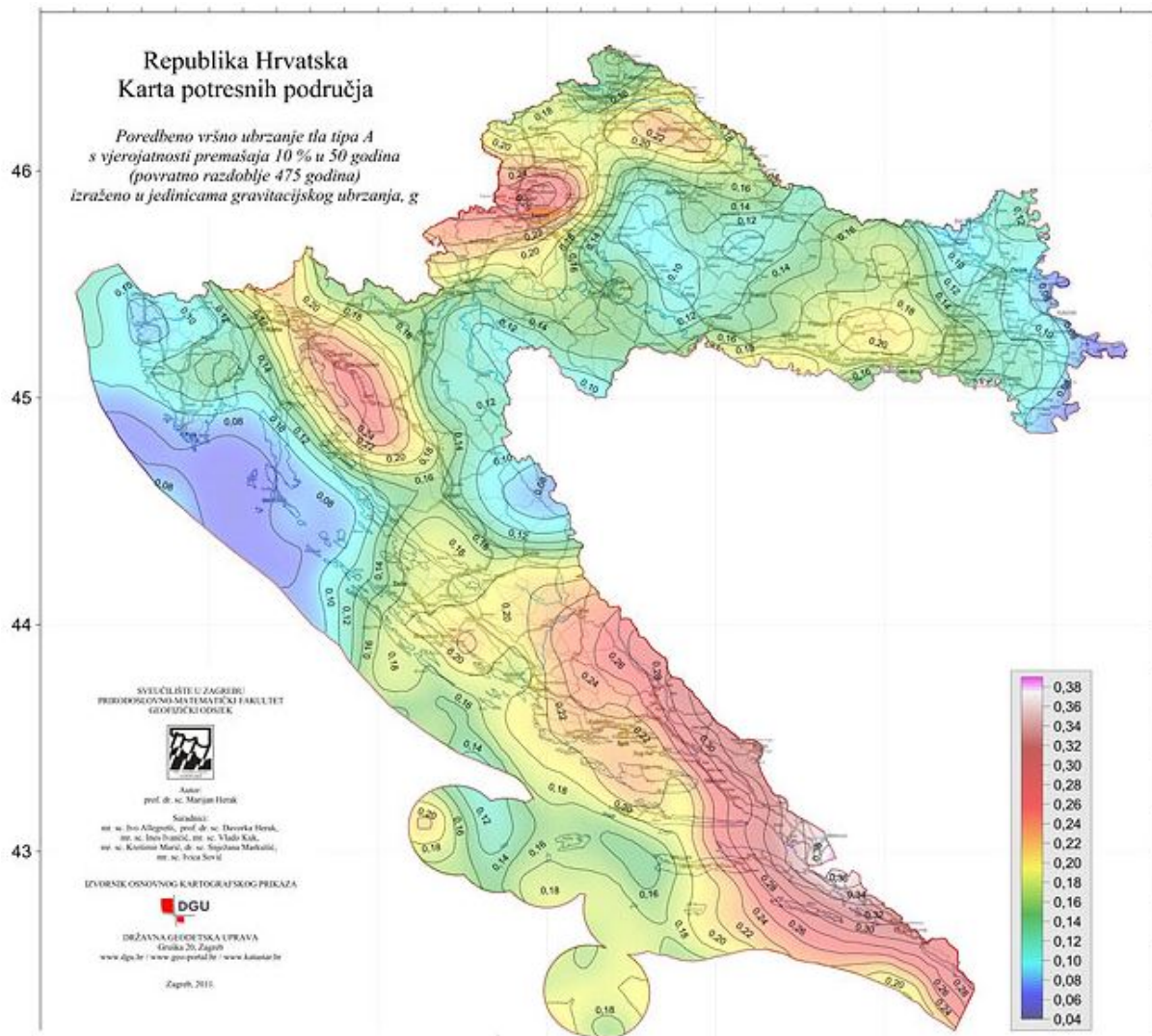

Slika 3.35. Seizmička karta Republike Hrvatske

Usvojeno projektirano ubrzanje tla iznosi  $a = 0,22\text{-g}$  za povratni period od 475 godina. Građevina je temeljena na tlu koje pripada kategoriji A, prema parametrima danim u Geotehničkom elaboratu. Pretpostavlja se srednja klasa ponašanja - DCM (medium ductility).

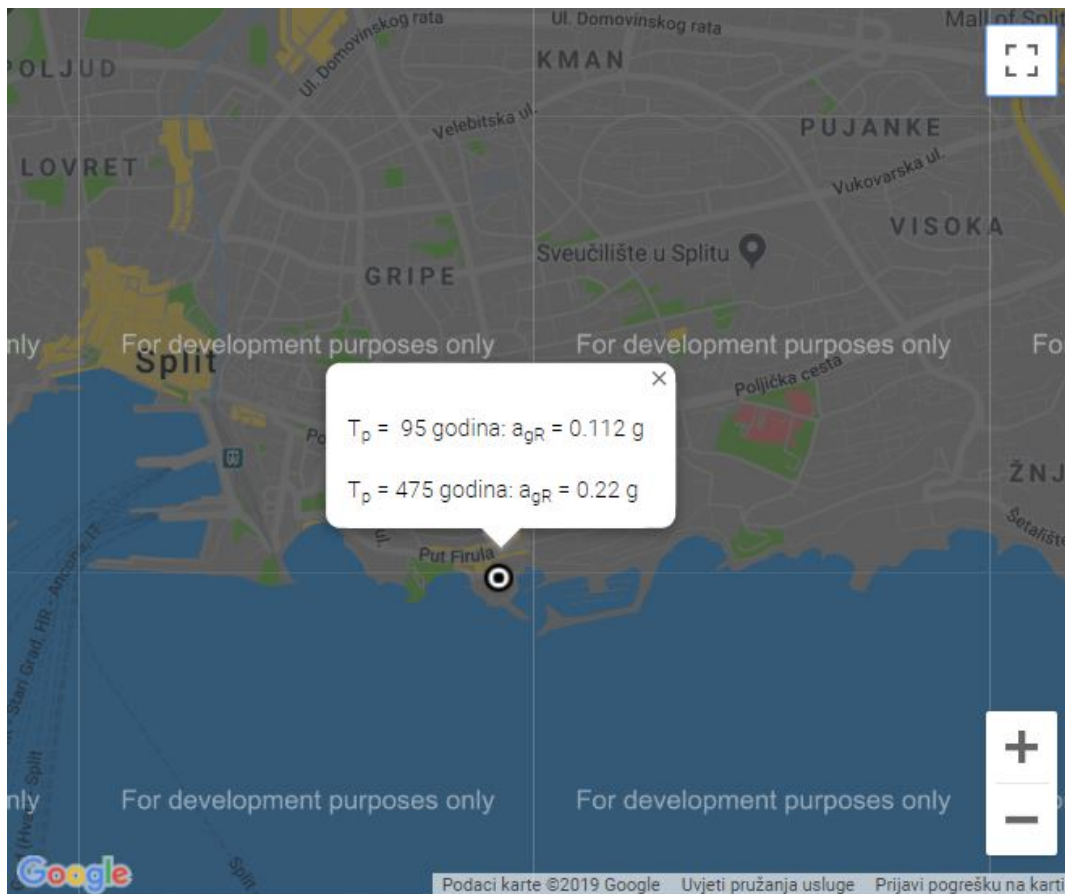

*Slika 3.36. Prikaz parametara za predmetnu lokaciju*

Potresno djelovanje u nekoj točki na površini općenito se prikazuje elastičnim spektrom odziva tla koji se naziva “elastični spektar odziva”. Postoje dva “elastična spektra odziva”, koji se odabiru u skladu s očekivanom magnitudom površinskih poprečnih valova  $M_s$ . Ovisno o tipu tla imamo različite parametre za pojedini tip elastičnog spektra odziva.

Ground type	$S$	$T_B$ (s)	$T_C$ (s)	$T_D$ (s)
A	1,0	0,15	0,4	2,0
B	1,2	0,15	0,5	2,0
C	1,15	0,20	0,6	2,0
D	1,35	0,20	0,8	2,0
E	1,4	0,15	0,5	2,0

*Tablica 3.15. Preporučene vrijednosti parametara za tip 1 elastičnog spektra odziva*

Kapacitet konstrukcijskog sustava koji preuzima potresno djelovanje u nelinearnome području općenito dopušta proračun na djelovanje sila koje su manje od onih koje odgovaraju linearnom elastičnom odzivu. Da bi se u proračunu izbjegao nelinearni proračun, uzima se u obzir kapacitet trošenja energije u konstrukciji putem uglavnom duktilnog ponašanja njezinih elemenata i/ili drugih mehanizama te se provodi linearni proračun utemeljen na spektru odziva umanjenom u odnosu na elastični spektar. Taj se spektar naziva "proračunski spektar".

To se umanjene postiže uvođenjem faktora ponašanja  $q$ . Faktor ponašanja  $q$  približno je omjer potresnih sila kojima bi građevina bila izložena kad bi njezin odziv bio u cijelosti elastičan uz 5 % - tno viskozno prigušenje i stvarnih potresnih sila koje bi se pojavile na promatranom sustavu. Faktori ponašanja konstrukcije ovise o tipu konstrukcije. Načelno, veći faktor pokazuje duktilnije ponašanje i smanjuje ukupne seizmičke sile na konstrukciju.

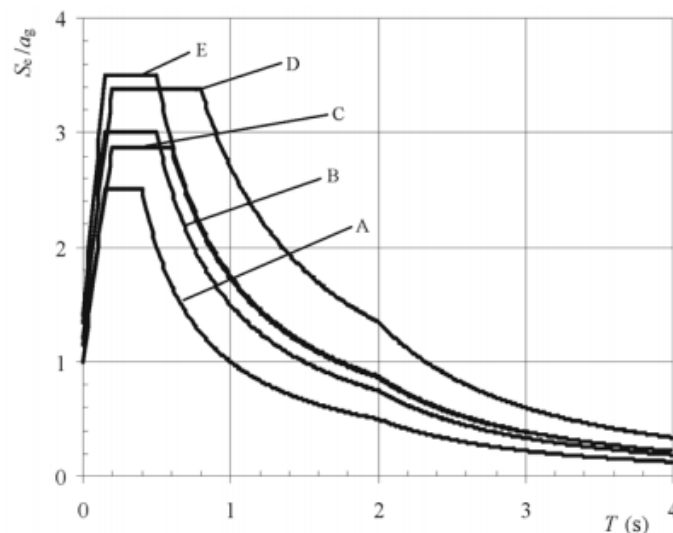

**Slika 3.38.** Tip 1 elastičnog spektra odziva za tla od A do E s prigušenjem od 5%

Seizmički uvjeti za nosivo tlo:	klasa tla A
Seizmičko područje:	VIII. zona
Računsko ubrzanje tla:	$a_{gR} = 0.22 \cdot g$
Faktor ponašanja:	$q=1,5$
Faktor tla:	$S = 1.0$
Maksimalna normirana vrijednost spektra odziva:	$\beta_0 = 2.5$
Granični periodi osciliranja:	$T_B = 0.15$ s,
	$T_C = 0.40$ s,
	$T_D = 2.0$ s

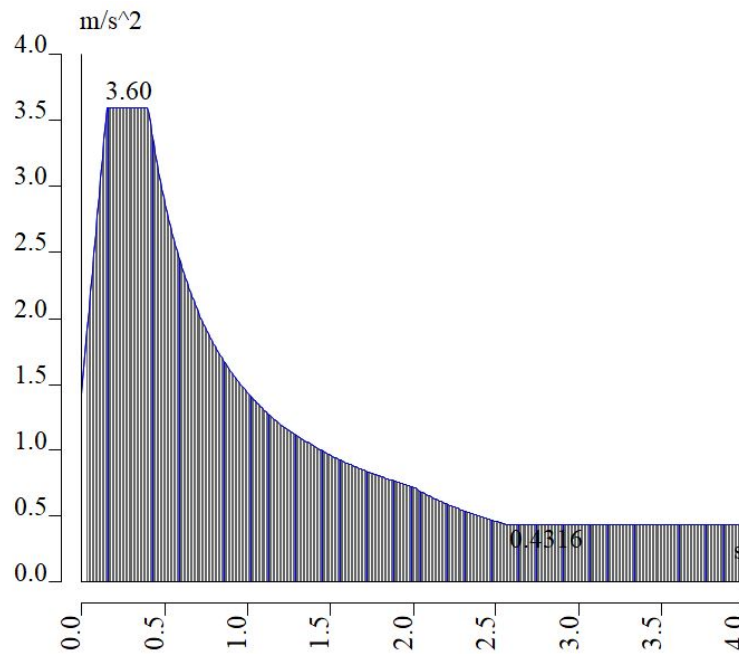

Slika 3.39. Normirani računski spektar odgovora

Za proračun seizmičkog opterećenja korištena je višemodalna spektralna analiza. Pri izračunu masa korištena je kombinacija stalnog opterećenja (težina konstrukcije i dodatno stalno opterećenje) i 50 % pokretnog opterećenja. Broj oblika (modova) osciliranja za predmetnu građevinu iznosi 30.

Suma djelotvornih modalnih masa u X smjeru iznosi 95,5%, a u Y smjeru 98,1% ukupne mase konstrukcije.

### Modalna analiza

#### Calculation protocol

##### Solution of Free vibration

Number of 2D elements	7070
Number of 1D elements	3320
Number of mesh nodes	7141
Number of equations	42046
Combination of mass groups	MC1 CM1
Number of frequencies	30
Method	Lanczos
Bending theory	Mindlin
Type of analysis model	Standard
Start of calculation	19.06.2019 14:44
End of calculation	19.06.2019 14:46

##### Sum of masses

	X [kg]	Y [kg]	Z [kg]
1	4936821,6	4937083,5	4936821,6

Relative modal masses

Mode	$\omega$ [rad/s]	Period [s]	Freq. [Hz]	$W_{xi}/W_{xtot}$	$W_{yi}/W_{ytot}$	$W_{zi}/W_{ztot}$	$N_{xi\_R}/W_{xtot\_E}$	$W_{yi\_R}/W_{ytot\_E}$	$N_{zi\_R}/W_{ztot\_E}$
1	23.2002	0,27	3,69	2.88655e-05	0.000934446	0.0736073	2.00431e-05	0.0142642	2.91938e-05
2	25.5615	0,25	4,07	0.0466502	1.01658e-05	0.100871	4.14489e-05	0.236952	0.000215433
3	26.7587	0,23	4,26	1.62037e-05	0.042576	0.0276315	8.41073e-06	0.00549494	0.000562339
4	27.6378	0,23	4,40	0.0046795	0.0714778	0.00716361	0.000184383	4.89441e-05	0.000474134
5	28.123	0,22	4,48	0.000258961	0.768985	0.000745117	0.00208871	0.00117596	0.00744073
6	30.5656	0,21	4,86	0.00230801	0.0669833	0.0388236	8.12261e-06	0.00344215	0.00537729
7	32.3097	0,19	5,14	0.000165944	0.00174843	0.0598894	8.44251e-05	0.113141	0.0158799
8	33.0991	0,19	5,27	0.00303588	0.00162571	0.018127	0.0101002	0.000451385	0.0648111
9	33.7741	0,19	5,38	0.0199716	0.00807093	0.000372057	0.00182784	4.75622e-05	0.783548
10	34.9428	0,18	5,56	0.054343	0.00510693	0.0424222	0.000958909	0.0361876	0.0158302
11	35.0685	0,18	5,58	0.0394888	0.000184638	0.0133562	0.00698771	0.000549457	0.0145829
12	36.2064	0,17	5,76	0.688399	0.000117006	1.73301e-05	0.000143699	0.00831611	0.0513503
13	37.6055	0,17	5,99	3.22537e-06	0.00013485	1.04406e-05	1.45583e-05	6.39671e-06	0.000597378
14	37.9509	0,17	6,04	0.00539209	2.45168e-05	0.00483389	0.00701333	0.00267501	0.000438583
15	40.4911	0,16	6,44	0.00207591	0.000106716	9.39074e-05	0.00724914	2.71918e-05	0.000321506
16	40.8137	0,15	6,50	1.03373e-07	0.000728665	0.00619028	0.00443059	0.00125299	6.47015e-05
17	42.8237	0,15	6,87	0.0582589	0.000193859	0.000656274	0.000175509	0.00189929	0.000419383
18	44.1069	0,14	7,02	2.81941e-05	0.000232353	0.000101227	1.33925e-06	4.94518e-05	0.000566728
19	45.0147	0,14	7,16	0.000345045	0.000891747	0.0047988	0.00571784	0.0029248	0.000293955
20	47.3523	0,13	7,54	0.000519186	0.000103148	0.00150786	0.00108025	0.000806236	0.000182174
21	48.4815	0,13	7,72	4.23206e-05	0.00189471	0.00216031	1.96164e-06	3.03987e-07	6.70711e-05
22	48.7157	0,13	7,75	0.000801192	0.00205619	0.00130901	0.00657934	0.000538216	0.00285968
23	49.1559	0,13	7,82	0.000234383	0.000517129	2.62773e-05	0.019527	0.000755587	0.00592407
24	50.525	0,12	8,04	0.00814191	5.49972e-05	0.00847747	0.00232287	0.0268719	5.83376e-05
25	50.7581	0,12	8,08	2.09378e-05	1.65749e-05	6.55148e-05	0.000136159	5.55655e-06	2.60224e-05
26	51.5657	0,12	8,21	0.000659801	0.00177124	0.00239364	0.0192594	4.99418e-07	0.000155034
27	51.7242	0,12	8,23	0.00182843	1.75265e-05	5.39439e-05	0.0636781	0.00896391	0.000146792
28	52.5622	0,12	8,37	0.00177161	0.000144746	0.000102499	0.00741635	0.0039951	0.000631237
29	54.6346	0,12	8,70	0.0155471	0.000364478	0.000411834	0.00589388	0.00373711	0.000164539
30	55.0775	0,11	8,77	5.60026e-06	0.00380659	0.0120028	0.0171923	0.000415901	0.0019883
				0.955022	0.980875	0.428222	0.190152	0.474997	0.975007

Na sljedećim grafičkim priložima prikazano je nekoliko karakterističnih vlastitih oblika (modova), nastavih uslijed djelovanja potresa.

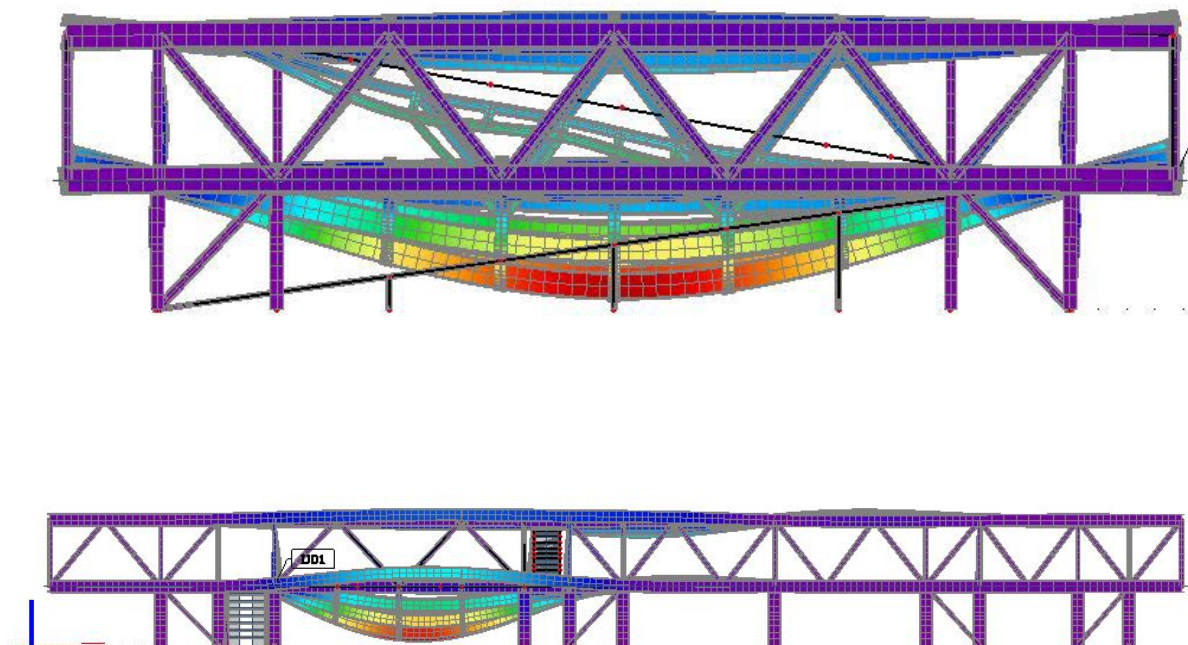

Slika 3.40. Prvi vlastiti vektor od djelovanja potresa na konstrukciju

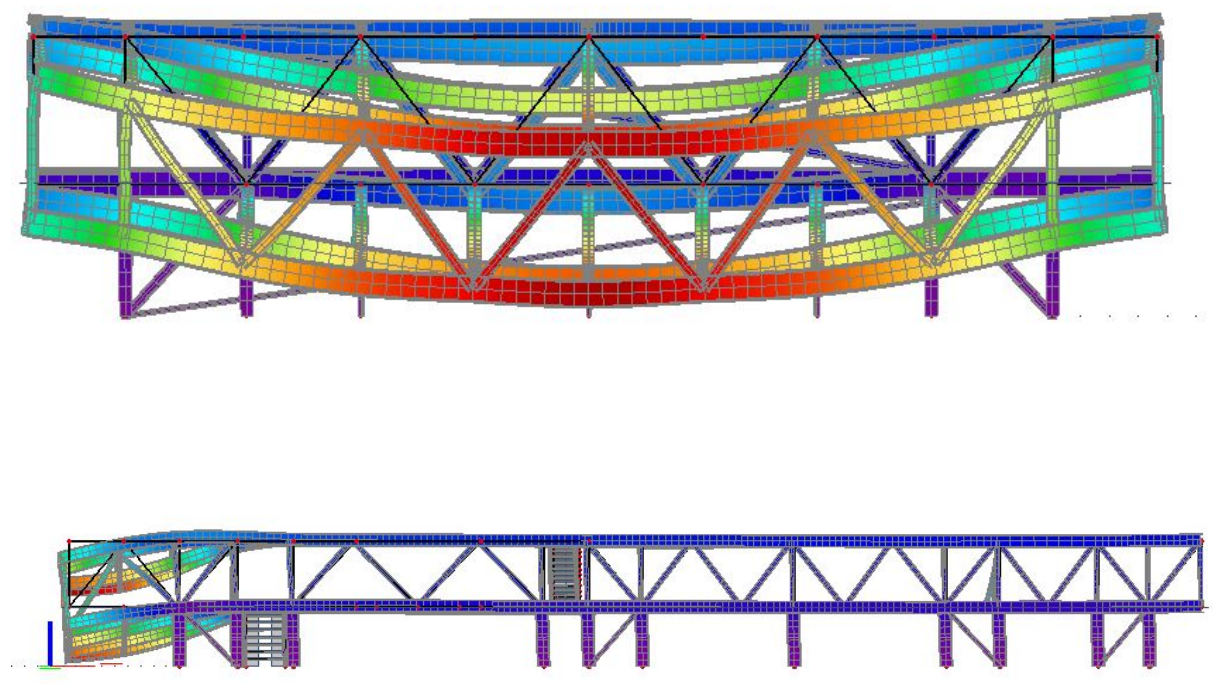

*Slika 3.41. Drugi vlastiti vektor od djelovanja potresa na konstrukciju*

## 4. KOMBINACIJE DJELOVANJA

### 4.1. Granično stanje uporabe (GSU)

Prikaz kombinacija za granično stanje uporabe.

#### Combinations

Name	Type	Load cases	Coeff. [ ]
GSU1	Envelope - ultimate	vlastita težina Dodatno stalno	1,00 1,00
GSU2	Envelope - ultimate	vlastita težina Dodatno stalno Pokretno	1,00 1,00 1,00
GSU3	Envelope - ultimate	vlastita težina Snijeg Dodatno stalno	1,00 1,00 1,00
GSU4	Envelope - ultimate	vlastita težina Dodatno stalno trenje y vjeter krov y1 vjeter bočni y 1,2	1,00 1,00 1,00 1,00 1,00
GSU5	Envelope - ultimate	vlastita težina Dodatno stalno trenje y vjeter krov y2 vjeter bočni y 1,2	1,00 1,00 1,00 1,00 1,00
GSU6	Envelope - ultimate	vlastita težina Dodatno stalno vjeter krov x1 vjeter bočni x1 x2	1,00 1,00 1,00 1,00
GSU7	Envelope - ultimate	vlastita težina Dodatno stalno vjeter krov x2 vjeter bočni x1 x2	1,00 1,00 1,00 1,00
GSU8	Envelope - ultimate	vlastita težina Snijeg Dodatno stalno Pokretno	1,00 1,00 1,00 1,00
GSU9	Envelope - ultimate	vlastita težina Dodatno stalno Pokretno trenje y vjeter krov y1 vjeter bočni y 1,2	1,00 1,00 1,00 1,00 1,00 1,00
GSU10	Envelope - ultimate	vlastita težina Dodatno stalno Pokretno trenje y vjeter krov y2 vjeter bočni y 1,2	1,00 1,00 1,00 1,00 1,00 1,00
GSU11	Envelope - ultimate	vlastita težina Dodatno stalno Pokretno trenje x vjeter krov x1 vjeter bočni x1 x2	1,00 1,00 1,00 1,00 1,00 1,00
GSU12	Envelope - ultimate	vlastita težina Dodatno stalno Pokretno trenje x vjeter krov x2 vjeter bočni x1 x2	1,00 1,00 1,00 1,00 1,00 1,00
GSU13	Envelope - ultimate	vlastita težina Dodatno stalno Pokretno trenje y vjeter krov y1 vjeter bočni y 1,2 temperatura jednolika +	1,00 1,00 1,00 1,00 1,00 1,00 1,00
GSU14	Envelope -	vlastita težina	1,00

Name	Type	Load cases	Coeff. [-]
GSU14	Envelope - ultimate	Dodatno stalno Pokretno trenje y vjetar krov y2 vjetar bočni y 1,2 temperatura jednolika +	1,00 1,00 1,00 1,00 1,00 1,00
GSU15	Envelope - ultimate	vlastita težina Dodatno stalno Pokretno trenje x vjetar krov x1 vjetar bočni x1 x2 temperatura jednolika +	1,00 1,00 1,00 1,00 1,00 1,00 1,00
GSU16	Envelope - ultimate	vlastita težina Dodatno stalno Pokretno trenje x vjetar krov x2 vjetar bočni x1 x2 temperatura jednolika +	1,00 1,00 1,00 1,00 1,00 1,00 1,00
GSU17	Envelope - ultimate	vlastita težina Snijeg Dodatno stalno Pokretno trenje x vjetar krov x1 vjetar bočni x1 x2 temperatura jednolika -	1,00 1,00 1,00 1,00 1,00 1,00 1,00 1,00
GSU18	Envelope - ultimate	vlastita težina Snijeg Dodatno stalno Pokretno trenje x vjetar krov x2 vjetar bočni x1 x2 temperatura jednolika -	1,00 1,00 1,00 1,00 1,00 1,00 1,00 1,00
GSU19	Envelope - ultimate	vlastita težina Snijeg Dodatno stalno Pokretno trenje y vjetar krov y1 vjetar bočni y 1,2 temperatura jednolika -	1,00 1,00 1,00 1,00 1,00 1,00 1,00 1,00
GSU20	Envelope - ultimate	vlastita težina Snijeg Dodatno stalno Pokretno trenje y vjetar krov y2 vjetar bočni y 1,2 temperatura jednolika -	1,00 1,00 1,00 1,00 1,00 1,00 1,00 1,00



## 4.2. Granično stanje nosivosti (GSN)

Prikaz kombinacija za granično stanje nosivosti.

### Combinations

Name	Type	Load cases	Coeff. [-]
GSN 1	Envelope - ultimate	vlastita težina vlastita težina_dry concrete - dry concrete self weight for vlastita težina Dodatno stalno Pokretno	1,35 1,35 1,35 1,80
GSN 2	Envelope - ultimate	vlastita težina vlastita težina_dry concrete - dry concrete self weight for vlastita težina Snijeg Dodatno stalno Pokretno	1,35 1,35 1,35 1,35 1,62
GSN 3	Envelope - ultimate	vlastita težina vlastita težina_dry concrete - dry concrete self weight for vlastita težina Snijeg Dodatno stalno	1,35 1,35 1,50 1,35
GSN 4	Envelope - ultimate	vlastita težina vlastita težina_dry concrete - dry concrete self weight for vlastita težina Dodatno stalno terije x vjetar krov x1 vjetar bočni x1 x2	1,35 1,35 1,35 1,35 1,35 1,35
GSN 5	Envelope - ultimate	vlastita težina vlastita težina_dry concrete - dry concrete self weight for vlastita težina Dodatno stalno terije x vjetar krov x2 vjetar bočni x1 x2	1,35 1,35 1,35 1,35 1,35 1,35
GSN 6	Envelope - ultimate	vlastita težina vlastita težina_dry concrete - dry concrete self weight for vlastita težina Dodatno stalno terije y vjetar krov y1 vjetar bočni y 1,2	1,35 1,35 1,35 1,35 1,35 1,35
GSN 7	Envelope - ultimate	vlastita težina vlastita težina_dry concrete - dry concrete self weight for vlastita težina Dodatno stalno terije y vjetar krov y2 vjetar bočni y 1,2	1,35 1,35 1,35 1,35 1,35 1,35
GSN 8	Envelope - ultimate	vlastita težina vlastita težina_dry concrete - dry concrete self weight for vlastita težina Snijeg Dodatno stalno terije x vjetar krov x1 vjetar bočni x1 x2	1,35 1,35 1,35 1,35 1,35 1,35 1,35
GSN 9	Envelope - ultimate	vlastita težina vlastita težina_dry concrete - dry concrete self weight for vlastita težina Snijeg Dodatno stalno terije x vjetar krov x2 vjetar bočni x1 x2	1,35 1,35 1,35 1,35 1,35 1,35 1,35
GSN 10	Envelope - ultimate	vlastita težina vlastita težina_dry concrete - dry concrete self weight for vlastita težina Snijeg Dodatno stalno terije y vjetar krov y1 vjetar bočni y 1,2	1,35 1,35 1,35 1,35 1,35 1,35 1,35
GSN 11	Envelope -	vlastita težina vlastita težina_dry concrete - dry concrete self weight for vlastita težina Snijeg Dodatno stalno	1,35 1,35 1,35 1,35

Name	Type	Load cases	Coeff. [-]
GSN 11	Envelope -	terje y vjetar krov y2 vjetar bočni y 1,2	1,35 1,35 1,35
GSN 12	Envelope - ultimate	vlastita težina vlastita težina dry concrete - dry concrete self weight for vlastita težina Dodatno stalno Pokretno terje x vjetar krov x1 vjetar bočni x1 x2	1,35 1,35 1,35 1,62 1,35 1,35 1,35
GSN 13	Envelope - ultimate	vlastita težina vlastita težina dry concrete - dry concrete self weight for vlastita težina Dodatno stalno Pokretno terje x vjetar krov x2 vjetar bočni x1 x2	1,35 1,35 1,35 1,62 1,35 1,35 1,35
GSN 14	Envelope - ultimate	vlastita težina vlastita težina dry concrete - dry concrete self weight for vlastita težina Dodatno stalno Pokretno terje y vjetar krov y1 vjetar bočni y 1,2	1,35 1,35 1,35 1,62 1,35 1,35 1,35
GSN 15	Envelope - ultimate	vlastita težina vlastita težina dry concrete - dry concrete self weight for vlastita težina Dodatno stalno Pokretno terje y vjetar krov y2 vjetar bočni y 1,2	1,35 1,35 1,35 1,62 1,35 1,35 1,35
GSN 16	Envelope - ultimate	vlastita težina vlastita težina dry concrete - dry concrete self weight for vlastita težina Dodatno stalno Pokretno terje x vjetar krov x1 vjetar bočni x1 x2 temperatura jednolika +	1,35 1,35 1,35 1,62 1,35 1,35 1,35 1,35
GSN 17	Envelope - ultimate	vlastita težina vlastita težina dry concrete - dry concrete self weight for vlastita težina Dodatno stalno Pokretno terje x vjetar krov x2 vjetar bočni x1 x2 temperatura jednolika +	1,35 1,35 1,35 1,62 1,35 1,35 1,35 1,35
GSN 18	Envelope - ultimate	vlastita težina vlastita težina dry concrete - dry concrete self weight for vlastita težina Dodatno stalno Pokretno terje y vjetar krov y1 vjetar bočni y 1,2 temperatura jednolika +	1,35 1,35 1,35 1,62 1,35 1,35 1,35 1,35
GSN 19	Envelope - ultimate	vlastita težina vlastita težina dry concrete - dry concrete self weight for vlastita težina Dodatno stalno Pokretno terje y vjetar krov y2 vjetar bočni y 1,2 temperatura jednolika +	1,35 1,35 1,35 1,62 1,35 1,35 1,35 1,35

Name	Type	Load cases	Coeff. [-]
GSN 20	Envelope - ultimate	vlastita težina	1,35
		vlastita težina dry concrete - dry concrete self weight for vlastita težina	1,35
		Snijeg	1,35
		Dodatno stalno	1,35
		Pokretno	1,62
		trenje x	1,35
		vjetar krov x1	1,35
		vjetar bočni x1 x2	1,35
		temperatura jednolika -	1,35
GSN 21	Envelope - ultimate	vlastita težina	1,35
		vlastita težina dry concrete - dry concrete self weight for vlastita težina	1,35
		Snijeg	1,35
		Dodatno stalno	1,35
		Pokretno	1,62
		trenje x	1,35
		vjetar krov x2	1,35
		vjetar bočni x1 x2	1,35
		temperatura jednolika -	1,35
GSN 22	Envelope - ultimate	vlastita težina	1,35
		vlastita težina dry concrete - dry concrete self weight for vlastita težina	1,35
		Snijeg	1,35
		Dodatno stalno	1,35
		Pokretno	1,62
		trenje y	1,35
		vjetar krov y1	1,35
		vjetar bočni y 1,2	1,35
		temperatura jednolika -	1,35
GSN 23	Envelope - ultimate	vlastita težina	1,35
		vlastita težina dry concrete - dry concrete self weight for vlastita težina	1,35
		Snijeg	1,35
		Dodatno stalno	1,35
		Pokretno	1,62
		trenje y	1,35
		vjetar krov y2	1,35
		vjetar bočni y 1,2	1,35
		temperatura jednolika -	1,35
potres x	Envelope - ultimate	vlastita težina	1,00
		vlastita težina dry concrete - dry concrete self weight for vlastita težina	1,00
		Dodatno stalno	1,00
		Pokretno	0,50
potres y	Envelope - ultimate	potres x	1,00
		vlastita težina	1,00
		vlastita težina dry concrete - dry concrete self weight for vlastita težina	1,00
		Dodatno stalno	1,00
		Pokretno	0,50
		potres y	1,00

- parcijalni faktor za stalna opterećenja – 1,35
- parcijalni faktor za promjenjiva opterećenja – 1,5
- parcijalni faktor za promjenjivo (pokretno) opterećenje –  $1,5 \times 1,2 = 1,80$  (nije vršena kombinacija opterećenja tj. postavljanje pokretnog opterećenja u najkritičnije položaje, već je pokretno opterećenje uvećano za 20%)
- parcijalni faktor za istodobno djelovanje više promjenjivih opterećenja –  $0,9 \times 1,5 = 1,35$

## 5. DIMENZIONIRANJE ELEMENATA KONSTRUKCIJE

### 5.1. Spregnuta krovna konstrukcija

Pomaci spregnute konstrukcije

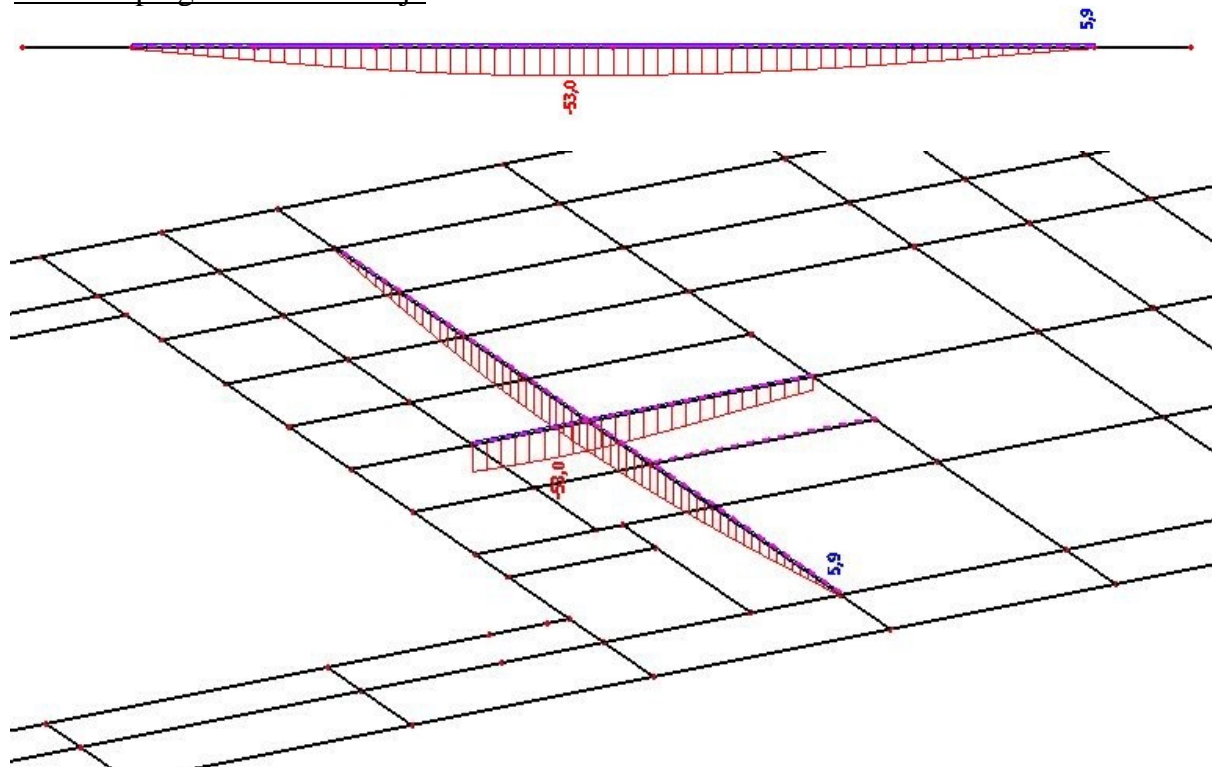

Slika 5.1. Prikaz vertikalnog pomaka grednog nosača

Dopušteni vertikalni pomak (progib):

$$u_{dop} = \frac{l}{300} = \frac{15,93}{300} = 53,2 \text{ mm}$$

$$u_z = 53,0 \text{ mm} < u_{dop} = 53,2 \text{ mm} \quad \text{-zadovoljava}$$

$$\text{-iskoristivost na GSU} = 53,6 \text{ mm} / 53,8 \text{ mm} = 0,996 = 99\%$$

Rezne sile grednih nosača

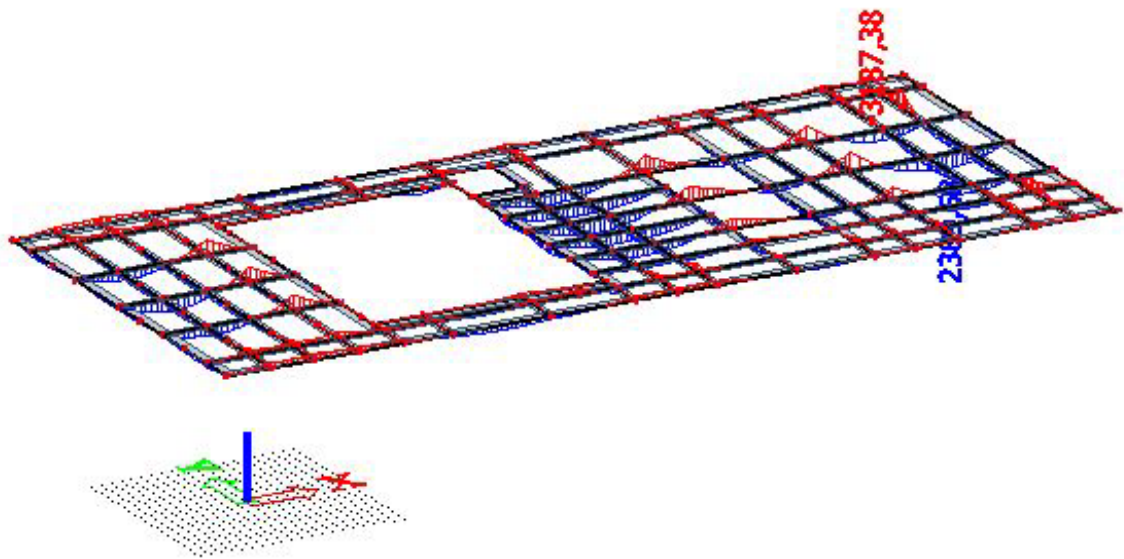

*Slika 5.2. Rezne sile- $M_y$*

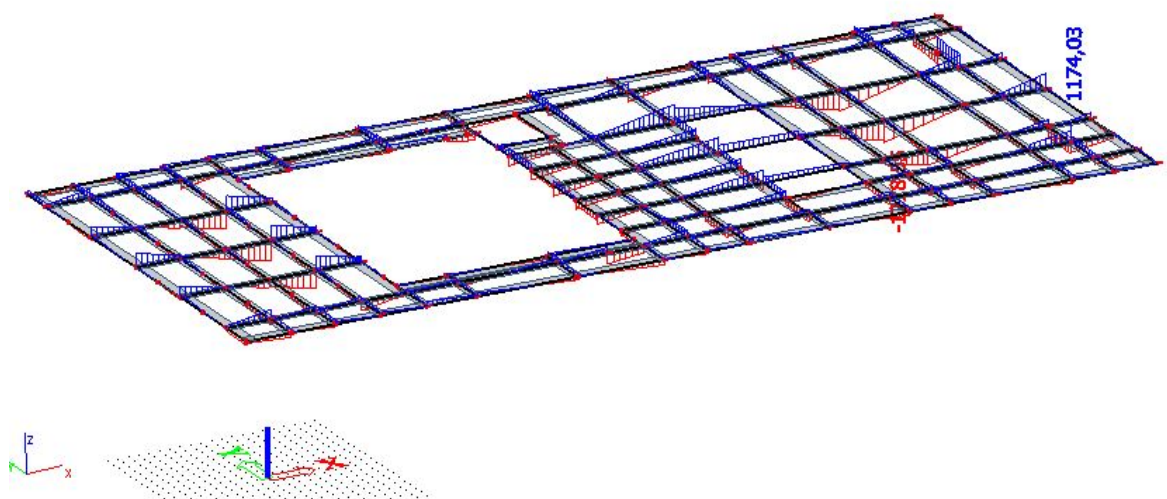

*Slika 5.3. Rezne sile- $V_z$*

Poprečni presjek nosača

Name	Krov kata	
Type	HL920x449	
Source description	ArcelorMittal / Sabs Programme / Version 2012-1	
Item material	S 355	
Fabrication	rolled	
Flexural buckling y-y	b	
Flexural buckling z-z	c	
Lateral torsional buckling	Default	
Use 2D FEM analysis	x	

A [m <sup>2</sup> ]	5,7140e-02	
A <sub>y, z</sub> [m <sup>2</sup> ]	3,5219e-02	2,2683e-02
I <sub>y, z</sub> [m <sup>4</sup> ]	8,7470e-03	5,3970e-04
I <sub>w</sub> [m <sup>6</sup> ], I <sub>t</sub> [m <sup>4</sup> ]	1,1060e-04	2,6270e-05
W <sub>el y, z</sub> [m <sup>3</sup> ]	1,8450e-02	2,5520e-03
W <sub>pl y, z</sub> [m <sup>3</sup> ]	2,0950e-02	3,9490e-03
d <sub>y, z</sub> [mm]	0	0
c <sub>YUCS, ZUCS</sub> [mm]	212	474
α [deg]	0,00	
A <sub>L, D</sub> [m <sup>2</sup> /m]	3,5072e+00	3,5072e+00
M <sub>ply +, -</sub> [Nm]	7,44e+06	7,44e+06
M <sub>plz +, -</sub> [Nm]	1,40e+06	1,40e+06

Slika 5.4. Prikaz geometrijskih karakteristika nosača

Dimenzioniranje

Composite Beam - Final stage

Linear calculation  
 Class: GSN  
 Extreme 1D: Global  
 Selection: B365  
 Filter: Cross-section = Krov kata - HL920x449

Composite beam verification

for beam B365 at section 7.61 m, in accordance with EC EN 1994-1-1

1. Geometry data

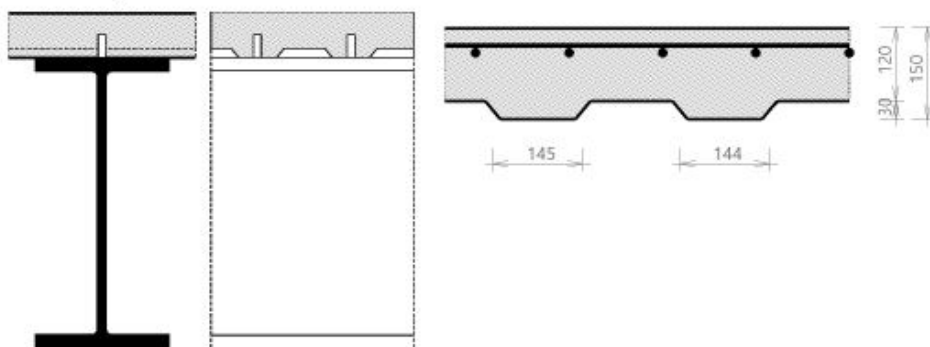

Continuous beam

Length of the current span L = 7.608 m  
 Length of previous span L<sub>previous</sub> = 3.999 m  
 Beam spacing at the left L<sub>left</sub> = 0 m  
 Beam spacing at the right L<sub>right</sub> = 0 m  
 Checked section d<sub>k</sub> = 7.608 m

**2. Cross-section & materials****2.1 Steel section properties****2.1.1 Cross-section**

Cross-section	HL920x449
Height	$h_a = 948 \text{ mm}$
Width	$b = 423 \text{ mm}$
Web thickness	$t_w = 24 \text{ mm}$
Flange thickness	$t_f = 42.7 \text{ mm}$
Radius	$r = 19 \text{ mm}$
Area	$A_a = 57140 \text{ mm}^2$
Moment of inertia	$I_y = 8.75 \cdot 10^9 \text{ mm}^4$
Radius of gyration	$i_z = 97 \text{ mm}$
Plastic section modulus	$W_{pl,y} = 20.95 \cdot 10^6 \text{ mm}^3$

**2.1.2 Material**

Steel grade	S 355
Yield strength	$f_{yb} = 355 \text{ MPa}$
Ultimate strength	$f_{ub} = 490 \text{ MPa}$
E modulus	$E_b = 210000 \text{ MPa}$

**2.1.3 Cross-section classification**

$$\varepsilon = \sqrt{\frac{235}{355}} = 0.814$$

(EN 1993-1-1 §5.6 Tab. 5.2)

**2.1.3.1 Flange in compression**

$$c_f = \frac{b - t_w - 2 \cdot r}{2} = \frac{423 \text{ mm} - 24 \text{ mm} - 2 \cdot 19 \text{ mm}}{2} = 181 \text{ mm}$$

$$\frac{c_f}{t_f} \leq 9 \cdot \varepsilon$$

$$\frac{181 \text{ mm}}{42.7 \text{ mm}} \leq 9 \cdot 0.814$$

$$4.23 \leq 7.32$$

OK

Flange classified as Class 1.

**2.1.3.2 Web in bending**

$$c_w = h_a - 2 \cdot t_f - 2 \cdot r = 948 \text{ mm} - 2 \cdot 42.7 \text{ mm} - 2 \cdot 19 \text{ mm} = 825 \text{ mm}$$

$$\alpha_{cl} = 0.5$$

$$\frac{c_w}{t_w} \leq \frac{36 \cdot \varepsilon}{\alpha_{cl}}$$

$$\frac{825 \text{ mm}}{24 \text{ mm}} \leq \frac{36 \cdot 0.814}{0.5}$$

$$34.4 \leq 58.6$$

OK

Web classified as Class 1.

**Cross-section classified as Class 1**

Cross-section Class OK.

**2.2 Concrete slab with profiled sheeting****2.2.1 Concrete slab****2.2.1.1 Slab**

Total height of the slab	$h_s = 150 \text{ mm}$
--------------------------	------------------------

**2.2.1.2 Material**

Concrete class	C30/37
Characteristic strength	$f_{ck} = 30 \text{ MPa}$
E modulus	$E_{cm} = 32800 \text{ MPa}$

**2.2.2 Profiled steel sheeting**

Sheeting with ribs transverse to the supporting beams

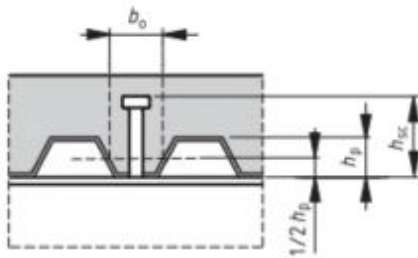

Name	ComFlor 80-0.9
Depth of the ribs	$h_p = 30 \text{ mm}$
Height of full concrete	$h_c = 120 \text{ mm}$
Height of the re-entrant stiffener	$h_d = 0 \text{ mm}$
Spacing of the ribs	$b_s = 300 \text{ mm}$
Top width of the rib	$b_r = 131 \text{ mm}$
Bottom width of the rib	$b_b = 120 \text{ mm}$
Mean width of the ribs	$b_{a,rib} = 144.5 \text{ mm}$
Thickness of the sheeting	$t_p = 2 \text{ mm}$

**2.2.3 Shear connectors****2.2.3.1 Geometry**

Name	SHC1
Diameter	$d_s = 25 \text{ mm}$
Nominal height	$h_{nom} = 80 \text{ mm}$
As-welded height	$h_{sc} = 75 \text{ mm}$
Amount per trough or section	$n_r = 1$

Warning: Condition given by EN 1994-1-1 Art. 6.6.5.8 (1) is not fulfilled.

**2.2.3.2 Material**

Steel grade	S 355
Ultimate strength	$f_{us} = 490 \text{ MPa}$

**2.2.4 Reinforcement****2.2.4.1 Geometry**

Longitudinal bar diameter	$d_l = 16 \text{ mm}$
Longitudinal bar spacing	$s_l = 150 \text{ mm}$
Longitudinal bar cover	$c_l = 30 \text{ mm}$
Transverse bar diameter	$d_t = 16 \text{ mm}$
Transverse bar spacing	$s_t = 150 \text{ mm}$
Transverse bar cover	$c_t = 46 \text{ mm}$

**2.2.4.2 Material**

Material	B 500B
Characteristic yield strength	$f_{ykr} = 500 \text{ MPa}$

**3. Design values of loads**

Load Name : GSN21

Content of combination :  $1.35 \cdot \text{vlastitetežina} + 1.35 \cdot \text{vlastitetežina\_dryconcrete} + 1.35 \cdot \text{Snijeg} + 1.35 \cdot \text{Dodatnostalno} + 1.62 \cdot \text{Pokretno} + 1.35 \cdot \text{trenjex} + 1.35 \cdot \text{vjetarkrovx2}$ 

Bending moment	$M_{Ed,comp} = -3187.380 \text{ kNm}$
Shear force	$V_{Ed,comp} = -1278.520 \text{ kN}$

**4. Partial safety factors**

Steel section	$\gamma_{M0} = 1$
	$\gamma_{M1} = 1$
Shear connectors	$\gamma_V = 1.25$
Concrete	$\gamma_C = 1.5$
Reinforcement	$\gamma_S = 1.15$



## 5. ULS check of the Final stage

### 5.1 Shear connection

#### 5.1.1 Design resistance of shear connectors

##### 5.1.1.1 Shear connector in a solid slab

$$3 \leq \frac{h_{sc}}{d_s} \leq 4$$

$$3 \leq 3 \leq 4$$

$$\alpha = 0.2 \cdot \left( \frac{h_{sc}}{d_s} + 1 \right) = 0.2 \cdot \left( \frac{75 \text{ mm}}{25 \text{ mm}} + 1 \right) = 0.8$$

$$f_{us} = \min(490; 450) \text{ MPa}$$

$$f_{us} = 450 \text{ MPa}$$

$$P_{Rd,solid,1} = \frac{0.8 \cdot f_{us} \cdot \left( \frac{\pi \cdot d_s^2}{4} \right)}{\gamma_v} = \frac{0.8 \cdot 450 \text{ MPa} \cdot \left( \frac{3.14 \cdot 25 \text{ mm}^2}{4} \right)}{1.25} = 141 \text{ kN}$$

$$P_{Rd,solid,2} = \frac{0.29 \cdot \alpha \cdot d_s^2 \cdot \sqrt{f_{ck} \cdot E_{cm}}}{\gamma_v} = \frac{0.29 \cdot 0.8 \cdot 25 \text{ mm}^2 \cdot \sqrt{30 \text{ MPa} \cdot 32800 \text{ MPa}}}{1.25} = 115 \text{ kN}$$

$$P_{Rd,solid} = \min(P_{Rd,solid,1}; P_{Rd,solid,2}) = \min(141 \text{ kN}; 115 \text{ kN}) = 115 \text{ kN}$$

##### 5.1.1.2 Shear connector in profiled sheeting

Sheeting with ribs transverse to the supporting beams

$$k_t = \frac{0.7}{\sqrt{n_r}} \cdot \left( \frac{b_{0,rib}}{h_p} \right) \cdot \left( \frac{h_{sc}}{h_p} - 1 \right) = \frac{0.7}{\sqrt{1}} \cdot \left( \frac{145 \text{ mm}}{30 \text{ mm}} \right) \cdot \left( \frac{75 \text{ mm}}{30 \text{ mm}} - 1 \right) = 5.06$$

$$k_{t,max} = 0.75$$

$$k_t = \max(0; \min(k_t; k_{t,max})) = \max(0; \min(5.06; 0.75)) = 0.75$$

$$P_{Rd} = k_t \cdot P_{Rd,solid} = 0.75 \cdot 115 \text{ kN} = 86.3 \text{ kN}$$

Warning: The conditions given by EN 1994-1-1 Art.6.6.4.2 (3) are not fulfilled.

#### 5.1.2 Degree of shear connection

##### 5.1.2.1 Determination of $b_{eff}$ of the concrete flange and length $L_e$

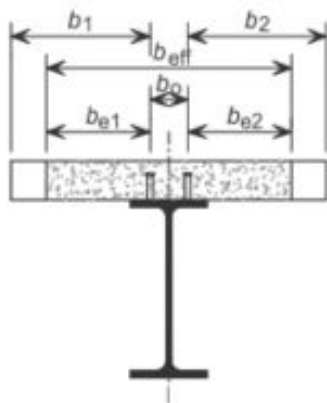

The effective width at the end support

$$L_{e0} = 0.85 \cdot L_2 = 0.85 \cdot 7.61 \text{ m} = 6.47 \text{ m}$$

Left side of the beam

Manual input of effective width on the side.

$$b_{eff,l} = 0.5 \text{ m}$$

**Right side of the beam**

Manual input of effective width on the side.

$$b_{\text{eff},r} = 0.5 \text{ m}$$

**Calculation of  $b_{\text{eff}}$** 

$$b_{\text{eff}} = b_{\text{eff},l} + b_{\text{eff},r} = 1 \text{ m}$$

**Determination of  $L_e$** 

$$L_e = L_{e0} = 6.47 \text{ m}$$

**5.1.2.2 Minimum degree of shear connection**

Warning: Conditions given by EN 1994-1-1 Art. 6.6.1.2 (3) are not fulfilled.

Warning: Conditions given by EN 1994-1-1 Art. 6.6.1.2 (1) are not fulfilled.

$$\eta_{\text{min,calc}} = 1 - \frac{355}{f_{yb}} \cdot (0.75 - 0.03 \cdot L_e)$$

$$\eta_{\text{min,calc}} = 1 - \frac{355}{355} \cdot (0.75 - 0.03 \cdot 6.47 \text{ m}) = 0.44$$

$$\eta_{\text{min}} = \max(\eta_{\text{min,calc}}, 0.4) = \max(0.44; 0.4) = 0.44$$

**5.1.2.3 Degree of shear connection present****5.1.2.3.1 Tension resistance of the reinforcement**

$$A_s = \frac{b_{\text{eff}}}{s_l} \cdot \left( \frac{d_l^2}{4} \right) \cdot \pi = \frac{1 \text{ m}}{150 \text{ mm}} \cdot \left( \frac{16 \text{ mm}^2}{4} \right) \cdot 3.14 = 1340 \text{ mm}^2$$

$$F_s = \frac{A_s \cdot f_{yk,r}}{\gamma_s} = \frac{1.34 \cdot 10^{-3} \cdot 500 \cdot 10^6}{1.15} = 583 \text{ kN}$$

**5.1.2.3.2 Tension resistance of the steel member**

$$N_{pl,s} = f_{yb} \cdot A_s = 355 \text{ MPa} \cdot 1340 \text{ mm}^2 = 20284.70 \text{ kN}$$

$$N_{c,r} = \min(F_s; N_{pl,s}) = \min(583 \text{ kN}; 20284.70 \text{ kN}) = 582.79 \text{ kN}$$

**5.1.2.3.3 Resistance of the shear connectors**Number of full ribs available per length  $L_e$ 

$$n_{\text{rib}} = \frac{L_e}{b_s} = \frac{6.47 \text{ m}}{300 \text{ mm}}$$

$$n_{\text{rib}} = 21$$

$$l_s = b_s \cdot \text{trough} = 300 \text{ mm} \cdot 1 = 300 \text{ mm}$$

Number of shear studs available per length  $L_e/2$ 

$$n_{\text{sp}} = \frac{0.5 \cdot n_{\text{rib}} \cdot n_r}{\text{trough}} = \frac{0.5 \cdot 21 \cdot 1}{1} = 10.5$$

$$N_c = n_{\text{sp}} \cdot P_{Rd} = 10.5 \cdot 86301 = 906.16 \text{ kN}$$

$$\eta = \min\left(\frac{N_c}{N_{c,r}}; 1\right) = \min\left(\frac{906.16 \text{ kN}}{582.79 \text{ kN}}; 1\right) = 1$$

$$\eta \geq \eta_{\text{min}}$$

$$1 \geq 0.44 \quad \text{OK}$$

The shear connection degree is adequate.

Student versio

## 5.2 Cross-sectional resistance of the composite beam

### 5.2.1 Shear buckling

$$h_w = h_a - 2 \cdot t_f = 948 \text{ mm} - 2 \cdot 42.7 \text{ mm} = 863 \text{ mm}$$

$$\eta_{sb} = 1.2$$

$$\frac{h_w}{t_w} \leq \frac{72 \cdot \varepsilon}{\eta_{sb}}$$

$$\frac{863 \text{ mm}}{24 \text{ mm}} \leq \frac{72 \cdot 0.814}{1.2}$$

$$35.9 \leq 48.8$$

OK

The shear buckling resistance of the web does not need to be verified.

### 5.2.2 Vertical shear

The resistance to vertical shear should be taken as the resistance of the structural steel section.

$$A_v = A_b - 2 \cdot b \cdot t_f + (t_w + 2 \cdot r) \cdot t_f$$

$$= 0.0571 - 2 \cdot 0.423 \cdot 0.0427 + (0.024 + 2 \cdot 0.019) \cdot 0.0427 = 23663 \text{ mm}^2$$

$$A_{v,min} = \eta_{sb} \cdot h_w \cdot t_w = 1.2 \cdot 0.863 \cdot 0.024 = 24843 \text{ mm}^2$$

$$A_v \geq A_{v,min}$$

$$23663 \text{ mm}^2 < 24843 \text{ mm}^2$$

$$A_v = A_{v,min} = 24843 \text{ mm}^2 = 24843 \text{ mm}^2$$

$$V_{pl,Rd} = \frac{A_v \cdot f_{y0}}{\sqrt{3} \cdot \gamma_{M0}} = \frac{24843 \text{ mm}^2 \cdot 355 \cdot 10^6}{\sqrt{3} \cdot 1} = 5092 \text{ kN}$$

$$UC_{comp,V} = \frac{abs(V_{Ed,comp})}{V_{pl,Rd}} = \frac{abs(-1278.520 \text{ kN})}{5092 \text{ kN}} = 0.25$$

The shear resistance of the section is adequate.

### 5.2.3 Bending moment

#### 5.2.3.1 Longitudinal reinforcement

##### 5.2.3.1.1 Centre of composite section

For buildings not intended mainly for storage the effects of creep in concrete beams may be taken into account by using an effective E modulus  $E_{c,eff} = E_{cm} / 2$ .

$$E_{c,eff} = \frac{E_{cm}}{2} = \frac{32800 \text{ MPa}}{2} = 16400 \text{ MPa}$$

$$\eta_E = \frac{E_b}{E_{c,eff}} = \frac{210000 \text{ MPa}}{16400 \text{ MPa}} = 12.8$$

$$y_d = \frac{A_a \cdot \left(\frac{h_a}{2}\right) + \left(\frac{1}{\eta_E}\right) \cdot b_{eff} \cdot (h_c - h_d) \cdot \left(h_a + h_s - \frac{h_c - h_d}{2}\right)}{A_a + \left(\frac{1}{\eta_E}\right) \cdot b_{eff} \cdot (h_c - h_d)}$$

$$= \frac{0.0571 \cdot \left(\frac{0.948}{2}\right) + \left(\frac{1}{12.8}\right) \cdot 1 \cdot (0.12 - 0) \cdot \left(0.948 + 0.15 - \frac{0.12 - 0}{2}\right)}{0.0571 + \left(\frac{1}{12.8}\right) \cdot 1 \cdot (0.12 - 0)} = 553 \text{ mm}$$

**5.2.3.1.2 Degree of reinforcement**

$$A_s = \frac{b_{\text{eff}}}{s_l} \left( \frac{d_l^2}{4} \right) \cdot \pi = \frac{1 \text{ m}}{150 \text{ mm}} \cdot \left( \frac{16 \text{ mm}^2}{4} \right) \cdot 3.14 = 1340 \text{ mm}^2$$

$$A_c = b_{\text{eff}} \cdot (h_c - h_d) = 1 \cdot (0.12 - 0) = 120000 \text{ mm}^2$$

$$z_0 = \left( h_a + h_s - \frac{h_c - h_d}{2} \right) - y_d = \left( 0.948 + 0.15 - \frac{0.12 - 0}{2} \right) - 0.553 = 485 \text{ mm}$$

$$k_c = \min \left( \frac{1}{1 + \frac{h_c - h_d}{2 \cdot z_0}} + 0.3; 1 \right) = \min \left( \frac{1}{1 + \frac{0.12 - 0}{2 \cdot 0.485}} + 0.3; 1 \right) = 1$$

$$\rho_s = \delta \cdot \left( \frac{f_{yb}}{235} \right) \cdot \left( \frac{f_{ctm}}{f_{ykr}} \right) \cdot \sqrt{k_c} = 1.1 \cdot \left( \frac{355}{235} \right) \cdot \left( \frac{2.9 \cdot 10^6}{500 \cdot 10^6} \right) \cdot \sqrt{1} = 0.964 \%$$

$$A_s \geq \rho_s \cdot A_c$$

$$1340 \text{ mm}^2 \geq 9.64 \cdot 10^{-3} \cdot 120000 \text{ mm}^2$$

$$1340 \text{ mm}^2 \geq 1157 \text{ mm}^2 \quad \text{OK}$$

The longitudinal reinforcement of the section is adequate.

**5.2.3.2 Moment resistance****Moment resistance of a steel cross-section**

$$M_{pl,Rd,a} = \frac{W_{pl,y} \cdot f_{yb}}{\gamma_{M0}} = \frac{21 \cdot 10^6 \text{ mm}^3 \cdot 355 \text{ MPa}}{1} = 7437 \text{ kNm}$$

**Influence of shear**

$$\frac{V_{pl,Rd}}{2} > \text{abs}(V_{Ed,comp})$$

$$\frac{5092 \text{ kN}}{2} > 1279 \text{ kN}$$

$$2546 \text{ kN} > 1279 \text{ kN} \quad \text{OK}$$

The influence of the vertical shear on the bending moment resistance may be neglected.

$$f_{yb,w} = f_{yb} = 355 \text{ MPa}$$

**Modified tension resistance of the steel member**

$$r = 0 \text{ mm}$$

$$A_a = 2 \cdot t_f \cdot b + t_w \cdot (h_a - 2 \cdot t_f) = 2 \cdot 42.7 \text{ mm} \cdot 423 \text{ mm} + 24 \text{ mm} \cdot (948 \text{ mm} - 2 \cdot 42.7 \text{ mm}) = 56827 \text{ mm}^2$$

$$N_{pl,a} = A_a \cdot f_{yb} = 56827 \text{ mm}^2 \cdot 355 \text{ MPa} = 20173.44 \text{ kN}$$

Note: Roundings of the steel cross-section are neglected in bending resistance calculation.

$$N_{c,r} = \min(F_s; N_{pl,a}) = \min(583 \text{ kN}; 20173.44 \text{ kN}) = 582.79 \text{ kN}$$

**Negative bending moment resistance calculation**

The plastic neutral axis is located within the web of the steel section.

$$N_{at,f} = b \cdot t_f \cdot f_{yb} = 0.423 \cdot 0.0427 \cdot 355 \cdot 10^3 = 6412.05 \text{ kN}$$

$$N_{pl,a} - N_{at,f} - N_{at,w} = F_s + N_{at,f} + N_{at,w}$$

$$x = \frac{(N_{pl,a} - 2 \cdot N_{at,f} - F_s)}{(2 \cdot t_w \cdot f_{yb,w})} = \frac{(20173.44 \text{ kN} - 2 \cdot 6412.05 \text{ kN} - 583 \text{ kN})}{(2 \cdot 24 \text{ mm} \cdot 355 \text{ MPa})} = 397 \text{ mm}$$

Verification of the steel web classification.

$$\alpha_{cl} = \frac{c_w - x}{c_w} = \frac{825 - 397}{825} = 0.518$$

$$\frac{c_w}{t_w} \leq \frac{396 \cdot \epsilon}{13 \cdot \alpha_{cl} - 1}$$

$$\frac{825 \text{ mm}}{24 \text{ mm}} \leq \frac{396 \cdot 0.814}{13 \cdot 0.518 - 1}$$

$$34.4 \leq 56.1$$

OK

Web classified as Class 1.

$$N_{at,w} = t_w \cdot x \cdot f_{yb,w} = 24 \text{ mm} \cdot 397 \text{ mm} \cdot 355 \text{ MPa} = 3383.28 \text{ kN}$$

$$N_{a,c} = N_{pl,a} - N_{at,f} - N_{at,w} = 20173.44 \text{ kN} - 6412.05 \text{ kN} - 3383.28 \text{ kN} = 10378.12 \text{ kN}$$

Leverage arm of the compression part of the steel section calculated to the PNA.

$$h_{cs} = \frac{(t_w \cdot (h_a - 2 \cdot t_f - x)^2 \cdot 0.5 + t_f \cdot b \cdot (h_a - 1.5 \cdot t_f - x))}{t_w \cdot (h_a - 2 \cdot t_f - x) + t_f \cdot b}$$

$$= \frac{(24 \cdot (948 - 2 \cdot 42.7 - 397)^2 \cdot 0.5 + 42.7 \cdot 423 \cdot (948 - 1.5 \cdot 42.7 - 397))}{24 \cdot (948 - 2 \cdot 42.7 - 397) + 42.7 \cdot 423} = 390 \text{ mm}$$

$$h_l = x + t_f + h_s - c_l + \frac{d_l}{2} = 0.397 + 0.0427 + 0.15 - 0.03 + \frac{0.016}{2} = 552 \text{ mm}$$

$l_{eff} = 1 \text{ m}$

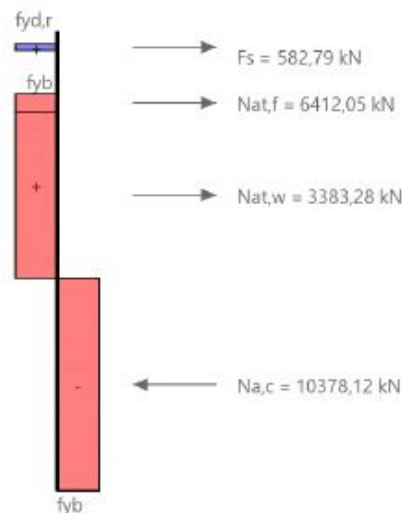
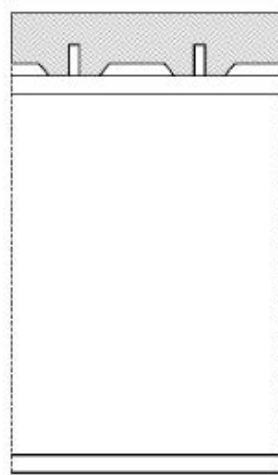

$$M_{pl,Rd} = F_s \cdot h_l + N_{at,f} \cdot \left( \frac{t_f}{2} + x \right) + \frac{N_{at,w} \cdot x}{2} + N_{a,c} \cdot h_{cs}$$

$$= 583 \cdot 552 + 6412.05 \cdot \left( \frac{42.7}{2} + 397 \right) + \frac{3383.28 \cdot 397}{2} + 10378.12 \cdot 390 = 7721 \text{ kNm}$$

Student version

**Design moment resistance according to EN 1994-1-1 Art.6.2.1.2**

$$M_{Rd} = M_{pl,Rd} = 7721 \text{ kNm}$$

$$UC_{comp,M} = \frac{\text{abs}(M_{Ed,comp})}{M_{Rd}} = \frac{\text{abs}(-3187.380 \text{ kNm})}{7721 \text{ kNm}} = 0.41$$

The bending moment resistance of the section is adequate.

**5.3 LTB resistance**

$$F = \left(1 + \frac{t_w \cdot (h_a - t_f)}{4 \cdot b \cdot t_f}\right) \cdot \left(\frac{h_a - t_f}{t_w}\right)^{0.75} \cdot \left(\frac{t_f}{b}\right)^{0.25} = \left(1 + \frac{24 \cdot (948 - 42.7)}{4 \cdot 423 \cdot 42.7}\right) \cdot \left(\frac{948 - 42.7}{24}\right)^{0.75} \cdot \left(\frac{42.7}{423}\right)^{0.25} = 11.2$$

$$F_{lim} = 12.3$$

$$F \leq F_{lim}$$

$$11.2 \leq 12.3$$

OK

The cross-section is qualified for verification of LTB by the simplified method.

$$C_4 = 25$$

$$\lambda_{LT,rel} = 5 \cdot \left(1 + \frac{t_w \cdot (h_a - t_f)}{4 \cdot b \cdot t_f}\right) \cdot \left(\frac{h_a - t_f}{t_w}\right)^{0.75} \cdot \left(\frac{t_f}{b}\right)^{0.25} \cdot \left(\frac{f_{yb}}{E_b \cdot C_4}\right)^{0.5}$$

$$= 5 \cdot \left(1 + \frac{0.024 \cdot (0.948 - 0.0427)}{4 \cdot 0.423 \cdot 0.0427}\right) \cdot \left(\frac{0.948 - 0.0427}{0.024}\right)^{0.75} \cdot \left(\frac{0.0427}{0.423}\right)^{0.25} \cdot \left(\frac{355 \cdot 10^6}{210 \cdot 10^9 \cdot 25}\right)^{0.5} = 0.459$$

$h_a/b > 2$  -> Buckling curve 'b'

$$\alpha_{LT} = 0.34$$

$$\Phi_{LT} = 0.5 \cdot \left(1 + \alpha_{LT} \cdot (\lambda_{LT,rel} - 0.2) + \lambda_{LT,rel}^2\right) = 0.5 \cdot \left(1 + 0.34 \cdot (0.459 - 0.2) + 0.459^2\right) = 0.649$$

$$X_{LT} = \frac{1}{\Phi_{LT} + \sqrt{\Phi_{LT}^2 - \lambda_{LT,rel}^2}} = \frac{1}{0.649 + \sqrt{0.649^2 - 0.459^2}} = 0.902$$

$$X_{LT} = \min(X_{LT}, 1) = \min(0.902, 1) = 0.902$$

$$M_{b,Rd} = X_{LT} \cdot M_{Rd} = 0.902 \cdot 7.72 \cdot 10^6 = 6964.690 \text{ kNm}$$

$$UC_{comp,LTB} = \frac{\text{abs}(M_{Ed,comp})}{M_{b,Rd}} = \frac{\text{abs}(-3187.380 \text{ kNm})}{6964.690 \text{ kNm}} = 0.46$$

The later torsional buckling resistance of the section is adequate.

**5.4 Longitudinal shear**
**5.4.1 Transverse reinforcement**

Design shear flow

$$h_f = h_c = 120 \text{ mm}$$

$$v_{Ed} = \frac{n_r \cdot P_{Rd}}{l_s \cdot h_f} = \frac{1 \cdot 86.3 \text{ kN}}{300 \text{ mm} \cdot 120 \text{ mm}} = 2.4 \text{ MPa}$$

Transverse reinforcement

$$\frac{A_{st} \cdot f_{yk,r}}{(\gamma_s \cdot s_f)} \geq \frac{v_{Ed} \cdot h_f}{\cotg(\theta)}$$

$$A_t = A_{st}/s_f$$

$$A_t = \frac{v_{Ed} \cdot h_f}{\left(\frac{\cotg(\theta) \cdot f_{yk,r}}{\gamma_s}\right)} = \frac{2.4 \cdot 10^6 \cdot 0.12}{\left(\frac{\cotg(26.5) \cdot 500 \cdot 10^6}{1.15}\right)} = 330 \text{ mm}^2/\text{m}$$

$$A_{t,prov} = \frac{1}{s_t} \cdot \left(\frac{d_t^2}{4}\right) \cdot 3.14 = \frac{1}{0.15} \cdot \left(\frac{0.016^2}{4}\right) \cdot 3.14 = 1340 \text{ mm}^2/\text{m}$$

$$A_{t,prov} \geq A_t$$

$$1340 \text{ mm}^2/\text{m} \geq 330 \text{ mm}^2/\text{m} \quad \text{OK}$$

The transverse reinforcement of the section is adequate.

**ULS check of Final stage is OK.**

$$UC_{comp} = \max(0.25; 0.41; 0.46) = 0.46$$

Iskoristivost elemenata za GSN – 46%

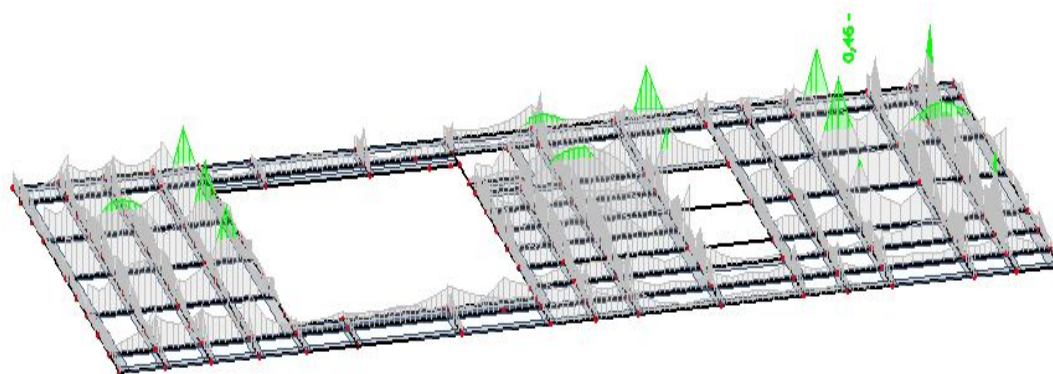

Slika 5.5. Prikaz iskoristivosti grednih nosača

## 5.2. Stupovi kata

Pomaci stupova kata

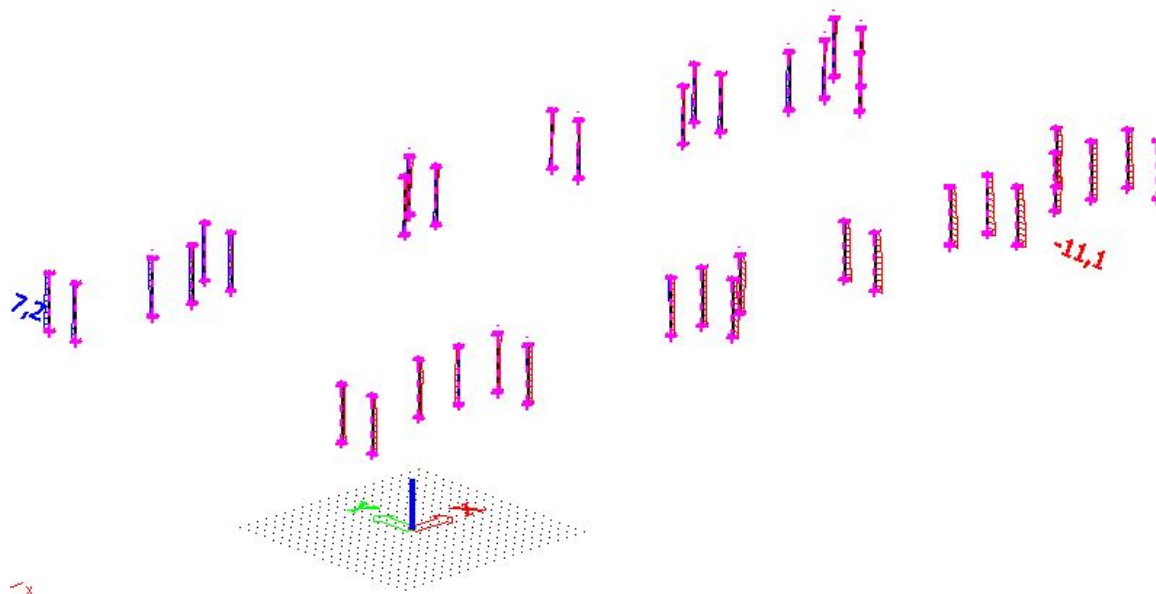

Slika 5.6. Prikaz horizontalnog pomaka stupova kata

Dopušteni horizontalni pomak :

$$u_{dop} = \frac{h}{200} = \frac{5,09}{200} = 25,5 \text{ mm}$$

$$u_z = 11,1 \text{ mm} < u_{dop} = 25,5 \text{ mm} \quad \text{-zadovoljava}$$

-iskoristivost na GSU –  $11,1 \text{ mm} / 25,5 \text{ mm} = 0,44 = 44\%$

Rezne sile stupova kata

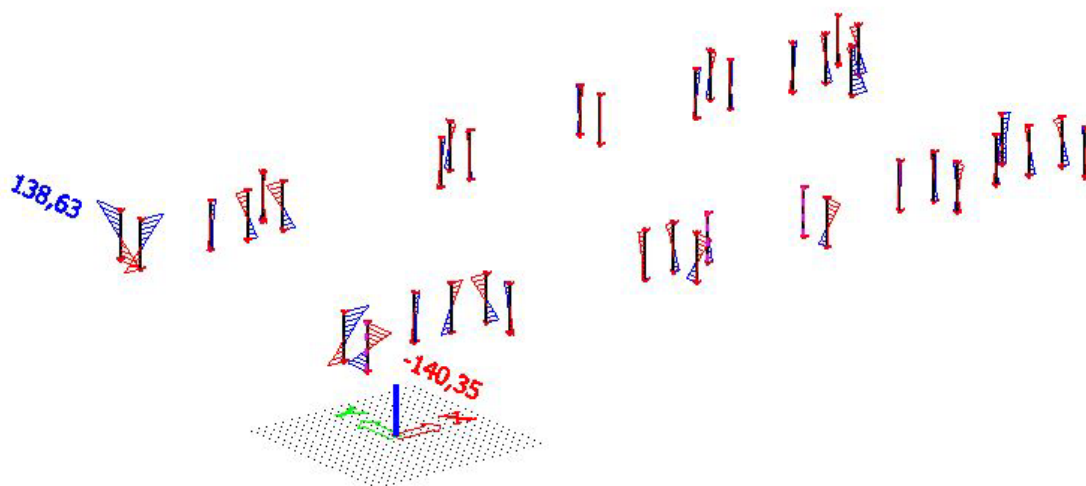

Slika 5.7. Rezne sile-My

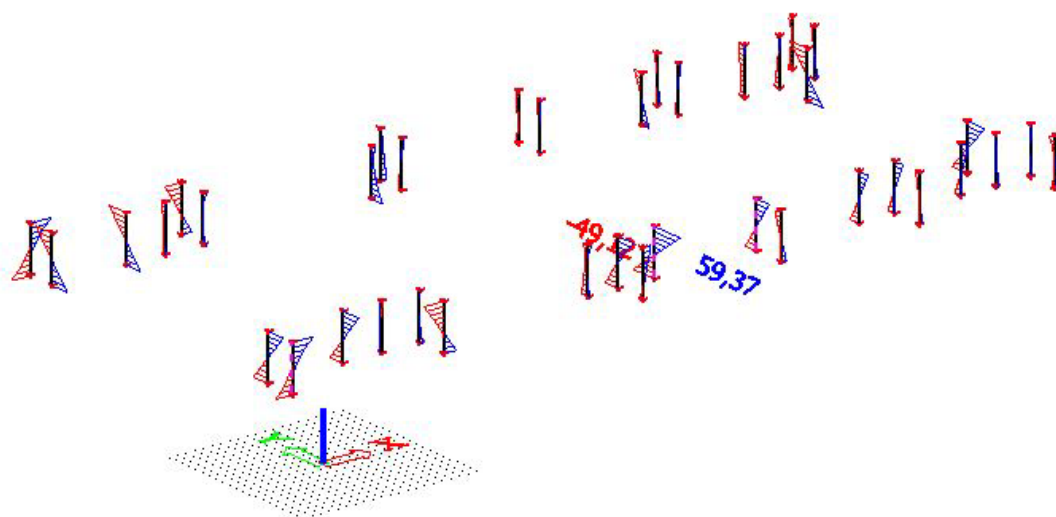

Slika 5.8. Rezne sile-Mz

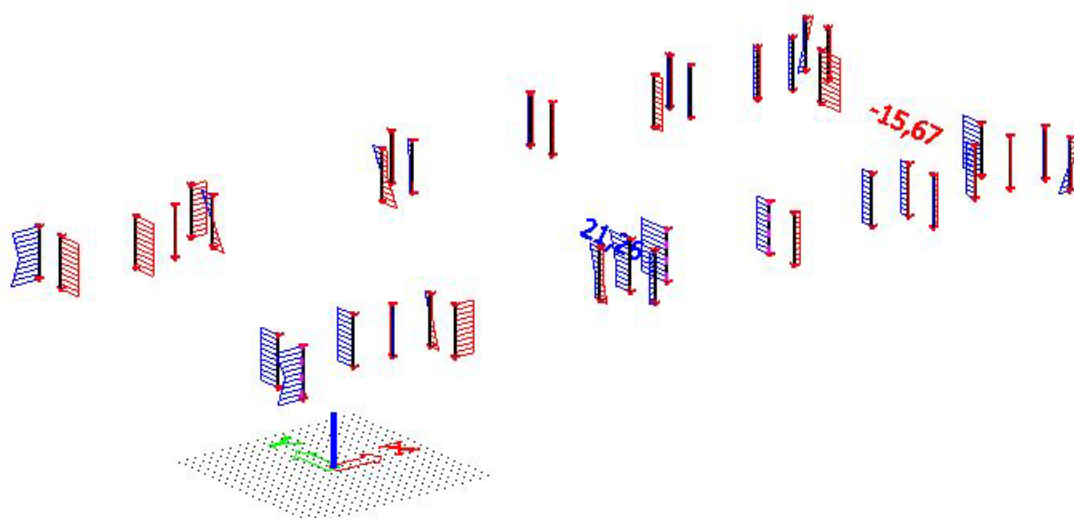

Slika 5.9. Rezne sile-Vy



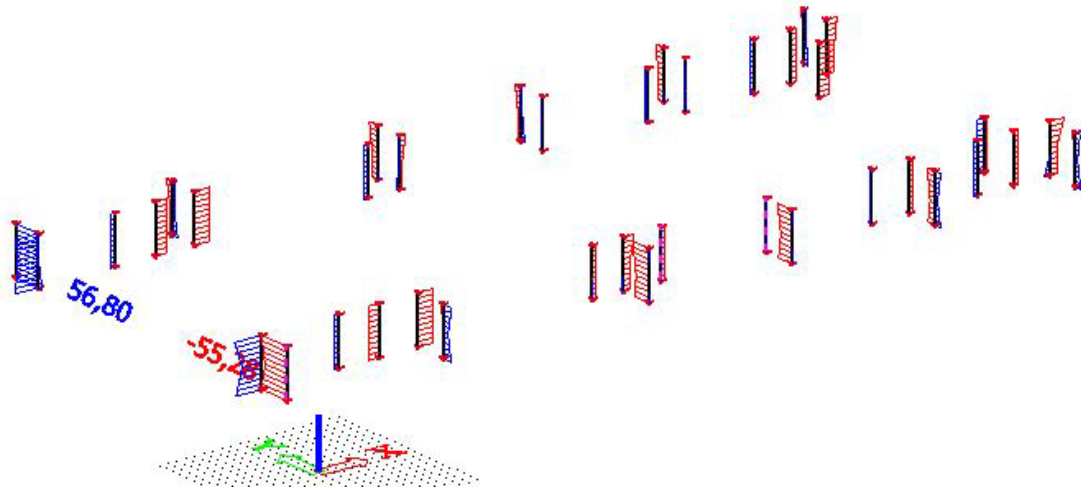

Slika 5.10. Rezne sile-Vz

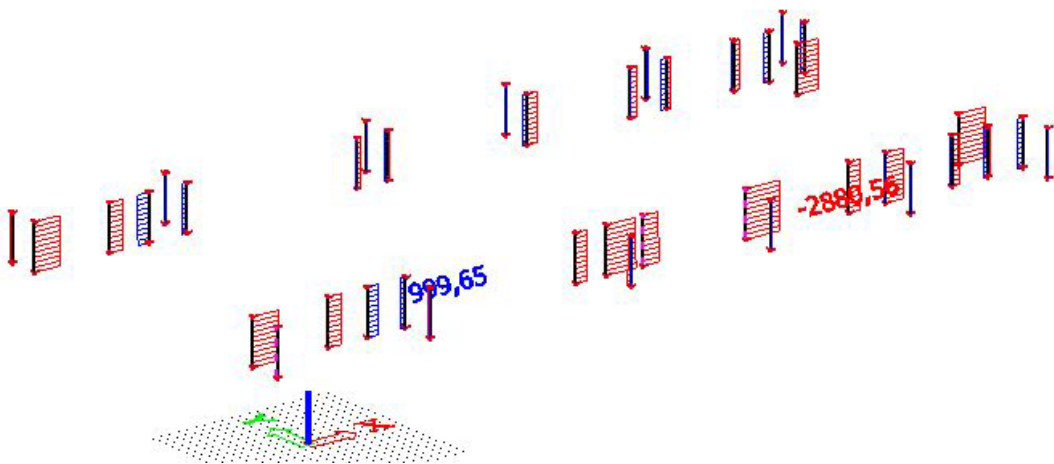

Slika 5.11. Rezne sile-N

Poprečni presjek stupova kata

Name	Stupovi kata	
Type	HEA340	
Source description	Profil Arbed / Structural shapes / Edition Octobre 1995	
Item material	S 355	
Fabrication	rolled	
Flexural buckling y-y	b	
Flexural buckling z-z	c	
Lateral torsional buckling	Default	
Use 2D FEM analysis	x	
A [m <sup>2</sup> ]	1,3400e-02	
A <sub>y</sub> , z [m <sup>2</sup> ]	9,5495e-03	3,3201e-03
I <sub>y</sub> , z [m <sup>4</sup> ]	2,7700e-04	7,4400e-05
I <sub>w</sub> [m <sup>6</sup> ], I <sub>t</sub> [m <sup>4</sup> ]	1,8244e-06	1,2700e-06
W <sub>el</sub> y, z [m <sup>3</sup> ]	1,6800e-03	4,9600e-04
W <sub>pl</sub> y, z [m <sup>3</sup> ]	1,8500e-03	7,5417e-04
d <sub>y</sub> , z [mm]	0	
c <sub>YUCS</sub> , ZUCS [mm]	150	165
α [deg]	0,00	
A <sub>L</sub> , D [m <sup>2</sup> /m]	1,8000e+00	1,7944e+00
M <sub>pl</sub> +, - [Nm]	6,57e+05	6,57e+05
M <sub>plz</sub> +, - [Nm]	2,68e+05	2,68e+05

Slika 5.12. Prikaz geometrijskih karakteristika stupova kata

Dimenzioniranje**Check of steel**

Linear calculation, - Extreme : Global  
 Selection : B72  
 Class : GSN  
 Cross-section : Stupovi kata - HEA340

**EN 1993-1-1 Code Check**

National annex: Standard EN

Member B72	5,090 m	HEA340	S 355	GSN21/1	0,89 -
------------	---------	--------	-------	---------	--------

Partial safety factors	
Gamma M0 for resistance of cross-sections	1,00
Gamma M1 for resistance to instability	1,00
Gamma M2 for resistance of net sections	1,25

Material		
Yield strength fy	355,0	MPa
Ultimate strength fu	490,0	MPa
Fabrication	Rolled	

....SECTION CHECK:....

**Classification for cross-section design**

According to EN 1993-1-1 article 5.5.2

**Classification of Internal Compression parts**

According to EN 1993-1-1 Table 5.2 Sheet 1

Maximum width-to-thickness ratio	25,58
Class 1 Limit	26,85
Class 2 Limit	30,92
Class 3 Limit	34,25

=> Internal Compression parts Class 1

**Classification of Outstand Flanges**

According to EN 1993-1-1 Table 5.2 Sheet 2

Maximum width-to-thickness ratio	7,17
Class 1 Limit	7,32
Class 2 Limit	8,14
Class 3 Limit	11,37

=> Outstand Flanges Class 1

=> Section classified as Class 1 for cross-section design

The critical check is on position **0.000 m**

Internal forces	Calculated	Unit
N,Ed	-2880,50	kN
Vy,Ed	10,86	kN
Vz,Ed	-0,96	kN
T,Ed	0,00	kNm
My,Ed	1,64	kNm
Mz,Ed	-25,66	kNm

**Compression check**

According to EN 1993-1-1 article 6.2.4 and formula (6.9)

A	1,3400e-02	m <sup>2</sup>
Nc,Rd	4757,00	kN
Unity check	0,61	-

**Bending moment check for My**

According to EN 1993-1-1 article 6.2.5 and formula (6.12),(6.13)

Wpl,y	1,8500e-03	m <sup>3</sup>
Mpl,y,Rd	656,75	kNm
Unity check	0,00	-

**Bending moment check for Mz**

According to EN 1993-1-1 article 6.2.5 and formula (6.12),(6.13)

Wpl,z	7,5417e-04	m <sup>3</sup>
Mpl,z,Rd	267,73	kNm
Unity check	0,10	-

**Shear check for Vy**

According to EN 1993-1-1 article 6.2.6 and formula (6.17)

Eta	1,20	
-----	------	--

Av	1,0247e-02	m <sup>2</sup>
Vpl,y,Rd	2100,17	kN
Unity check	0,01	-

**Shear check for Vz**

According to EN 1993-1-1 article 6.2.6 and formula (6.17)

Eta	1,20	
Av	4,5477e-03	m <sup>2</sup>
Vpl,z,Rd	932,10	kN
Unity check	0,00	-

**Torsion check**

According to EN 1993-1-1 article 6.2.7 and formula (6.23)

Tau,t,Ed	0,0	MPa
Tau,Rd	205,0	MPa
Unity check	0,00	-

**Note:** The unity check for torsion is lower than the limit value of 0,05. Therefore torsion is considered as insignificant and is ignored in the combined checks.

**Combined bending, axial force and shear force check**

According to EN 1993-1-1 article 6.2.9.1 and formula (6.41)

MN,y,Rd	297,98	kNm
Alpha	2,00	
MN,z,Rd	209,57	kNm
Beta	3,03	

Unity check (6.41) = 0,00 + 0,00 = 0,00 -

**Note:** Since the shear forces are less than half the plastic shear resistances their effect on the moment resistances is neglected.

The member satisfies the section check.

**....:STABILITY CHECK:....****Classification for member buckling design**

Decisive position for stability classification: 0,000 m

**Classification of Internal Compression parts**

According to EN 1993-1-1 Table 5.2 Sheet 1

Maximum width-to-thickness ratio	25,58
Class 1 Limit	26,85
Class 2 Limit	30,92
Class 3 Limit	34,25

=&gt; Internal Compression parts Class 1

**Classification of Outstand Flanges**

According to EN 1993-1-1 Table 5.2 Sheet 2

Maximum width-to-thickness ratio	7,17
Class 1 Limit	7,32
Class 2 Limit	8,14
Class 3 Limit	11,37

=&gt; Outstand Flanges Class 1

=&gt; Section classified as Class 1 for member buckling design

**Flexural Buckling check**

According to EN 1993-1-1 article 6.3.1.1 and formula (6.46)

Buckling parameters	yy	zz	
Sway type	sway	non-sway	
System length L	5,090	5,090	m
Buckling factor k	1,16	0,51	
Buckling length Lcr	5,912	2,583	m
Critical Euler load Ncr	16424,04	23113,00	kN
Slenderness Lambda	41,12	34,66	
Relative slenderness Lambda,rel	0,54	0,45	
Limit slenderness Lambda,rel,0	0,20	0,20	
Buckling curve	b	c	
Imperfection Alpha	0,34	0,49	
Reduction factor Chi	0,87	0,87	
Buckling resistance Nb,Rd	4123,86	4131,66	kN

Flexural Buckling verification		
Cross-section area A	1,3400e-02	m <sup>2</sup>
Buckling resistance Nb,Rd	4123,86	kN
Unity check	0,70	

**Torsional(-Flexural) Buckling check**

According to EN 1993-1-1 article 6.3.1.1 and formula (6.46)

Torsional buckling length Lcr	5,090	m
Elastic critical load Ncr,T	9477,01	kN
Elastic critical load Ncr,TF	9477,01	kN
Relative slenderness Lambda,rel,T	0,71	
Limit slenderness Lambda,rel,0	0,20	
Buckling curve	c	
Imperfection Alpha	0,49	
Reduction factor Chi	0,72	
Cross-section area A	1,3400e-02	m <sup>2</sup>
Buckling resistance Nb,Rd	3422,32	kN
Unity check	0,84	-

**Lateral Torsional Buckling check**

According to EN 1993-1-1 article 6.3.2.1 & 6.3.2.2 and formula (6.54)

LTB parameters		
Method for LTB curve	General case	
Cross-section plastic modulus Wpl,y	1,8500e-03	m <sup>3</sup>
Elastic critical moment Mcr	2880,12	kNm
Relative slenderness Lambda,rel,LT	0,48	
Limit slenderness Lambda,rel,LT,0	0,20	

**Note:** The slenderness or bending moment is such that Lateral Torsional Buckling effects may be ignored according to EN 1993-1-1 article 6.3.2.2(4).

Mcr parameters		
LTB length L	5,090	m
Influence of load position	no influence	
Correction factor k	1,00	
Correction factor kw	1,00	
LTB moment factor C1	2,37	
LTB moment factor C2	0,00	
LTB moment factor C3	1,00	
Shear center distance d,z	0	mm
Distance of load application z,g	0	mm
Mono-symmetry constant beta,y	0	mm
Mono-symmetry constant z,j	0	mm

**Note:** C parameters are determined according to ECCS 119 2006 / Galea 2002.

**Bending and axial compression check**

According to EN 1993-1-1 article 6.3.3 and formula (6.61),(6.62)

Bending and axial compression check parameters		
Interaction method	alternative method 1	
Cross-section area A	1,3400e-02	m <sup>2</sup>
Cross-section plastic modulus Wpl,y	1,8500e-03	m <sup>3</sup>
Cross-section plastic modulus Wpl,z	7,5417e-04	m <sup>3</sup>
Design compression force N,Ed	2880,50	kN
Design bending moment (maximum) My,Ed	-3,23	kNm
Design bending moment (maximum) Mz,Ed	29,60	kNm
Characteristic compression resistance N,Rk	4757,00	kN
Characteristic moment resistance My,Rk	656,75	kNm
Characteristic moment resistance Mz,Rk	267,73	kNm
Reduction factor Chi,y	0,87	
Reduction factor Chi,z	0,72	
Reduction factor Chi,LT	1,00	
Interaction factor k,yy	0,72	
Interaction factor k,yz	0,28	
Interaction factor k,zy	0,38	
Interaction factor k,zz	0,41	

Maximum moment My,Ed is derived from beam: B72 position 5,090 m.  
Maximum moment Mz,Ed is derived from beam: B72 position 5,090 m.

Interaction method 1 parameters		
Critical Euler load $N_{cr,y}$	16424,04	kN
Critical Euler load $N_{cr,z}$	23113,00	kN
Elastic critical load $N_{cr,T}$	9477,01	kN
Cross-section plastic modulus $W_{pl,y}$	1,8500e-03	m <sup>3</sup>
Cross-section elastic modulus $W_{el,y}$	1,6800e-03	m <sup>3</sup>
Cross-section plastic modulus $W_{pl,z}$	7,5417e-04	m <sup>3</sup>
Cross-section elastic modulus $W_{el,z}$	4,9600e-04	m <sup>3</sup>
Second moment of area $I_y$	2,7700e-04	m <sup>4</sup>
Second moment of area $I_z$	7,4400e-05	m <sup>4</sup>
Torsional constant $I_t$	1,2700e-06	m <sup>4</sup>
Method for equivalent moment factor $C_{my,0}$	Table A.2 Line 1 (Linear)	
Ratio of end moments $\Psi_{i,y}$	-0,51	
Equivalent moment factor $C_{my,0}$	0,63	
Method for equivalent moment factor $C_{mz,0}$	Table A.2 Line 1 (Linear)	
Ratio of end moments $\Psi_{i,z}$	-0,87	
Equivalent moment factor $C_{mz,0}$	0,55	
Factor $\mu_{y,0}$	0,97	
Factor $\mu_{z,0}$	0,98	
Factor $\epsilon_{y,0}$	0,01	
Factor $a_{,LT}$	1,00	
Critical moment for uniform bending $M_{cr,0}$	1216,22	kNm
Relative slenderness $\lambda_{rel,0}$	0,73	
Limit relative slenderness $\lambda_{rel,0,lim}$	0,27	
Equivalent moment factor $C_{my}$	0,66	
Equivalent moment factor $C_{mz}$	0,55	
Equivalent moment factor $C_{mLT}$	1,00	
Factor $b_{,LT}$	0,00	
Factor $c_{,LT}$	0,01	
Factor $d_{,LT}$	0,02	
Factor $e_{,LT}$	0,06	
Factor $w_y$	1,10	
Factor $w_z$	1,50	
Factor $n_{pl}$	0,61	
Maximum relative slenderness $\lambda_{rel,max}$	0,54	
Factor $C_{yy}$	1,09	
Factor $C_{yz}$	1,55	
Factor $C_{zy}$	1,05	
Factor $C_{zz}$	1,50	

Unity check (6.61) = 0,70 + 0,00 + 0,03 = 0,73 -  
 Unity check (6.62) = 0,84 + 0,00 + 0,05 = 0,89 -

**Shear Buckling check**

According to EN 1993-1-5 article 5 & 7.1 and formula (5.10) & (7.1)

Shear Buckling parameters		
Buckling field length $a$	5,090	m
Web	unstiffened	
Web height $h_w$	297	mm
Web thickness $t$	10	mm
Material coefficient $\epsilon$	0,81	
Shear correction factor $\eta$	1,20	

Shear Buckling verification	
Web slenderness $h_w/t$	31,26
Web slenderness limit	48,82

**Note:** The web slenderness is such that Shear Buckling effects may be ignored according to EN 1993-1-5 article 5.1(2).

The member satisfies the stability check.

Student version

Iskoristivost elemenata za GSN – 89%

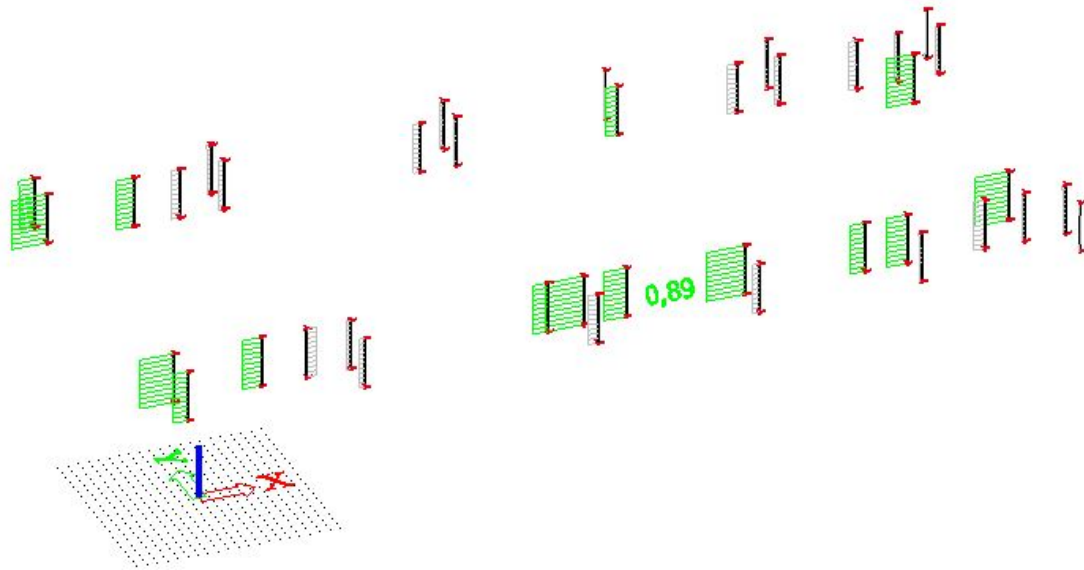

Slika 5.13. Prikaz iskoristivosti stupova kata

### 5.3. Dijagonale kata

Rezne sile dijagonala kata

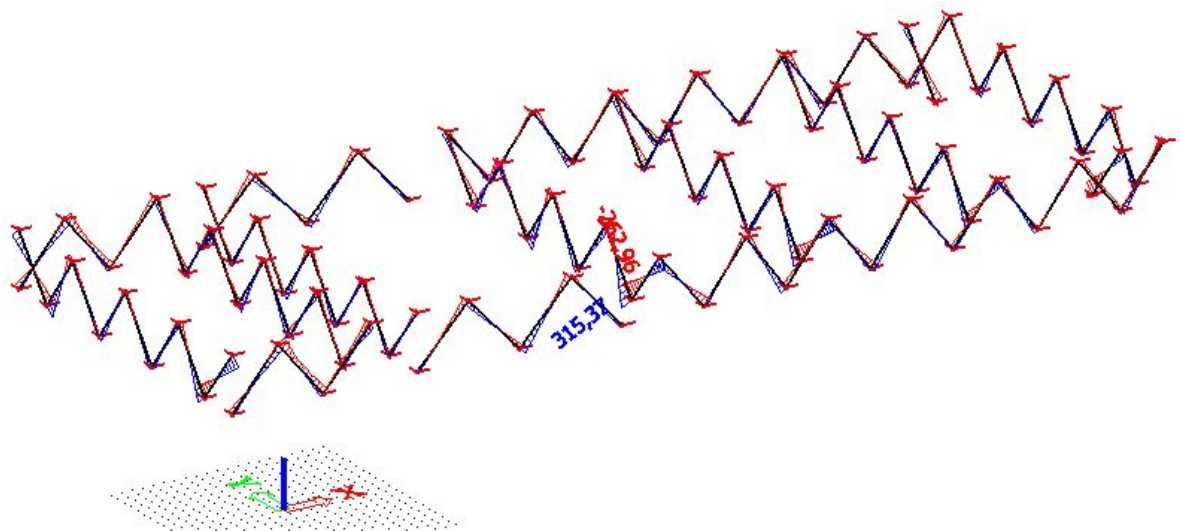

Slika 5.14. Rezne sile-My

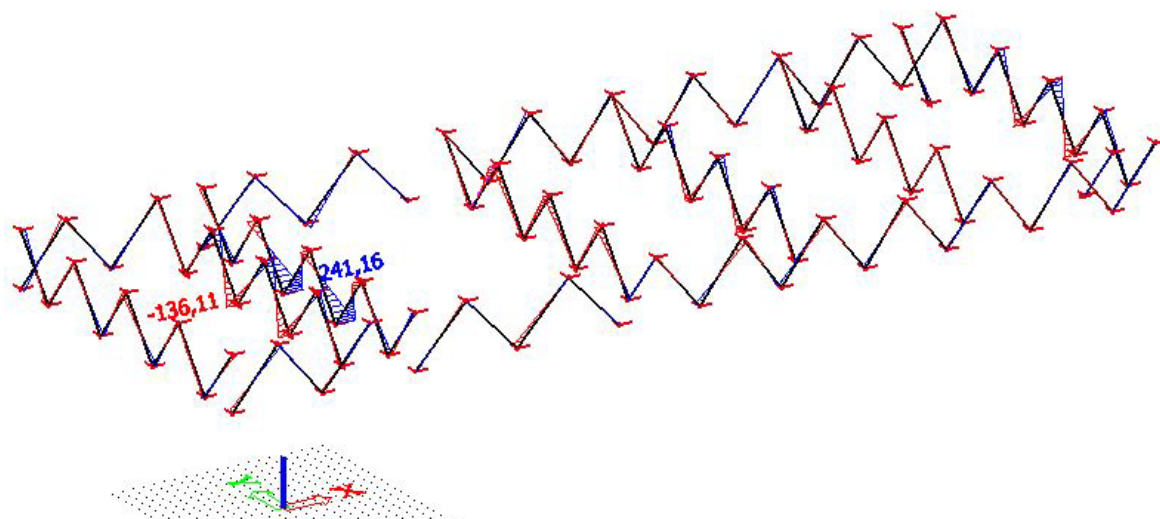

Slika 5.15. Rezne sile-Mz

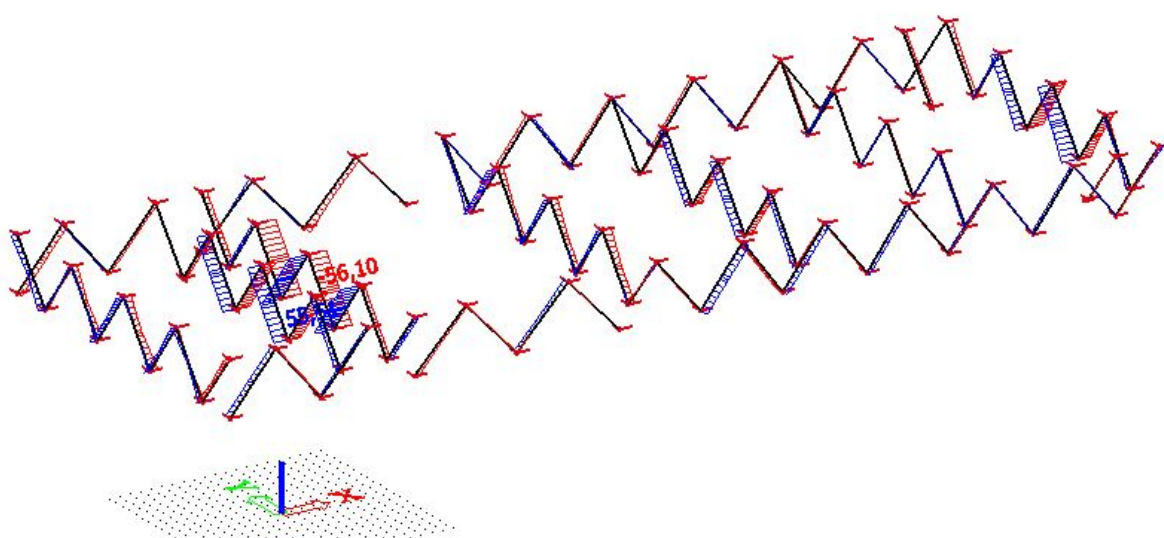

Slika 5.16. Rezne sile-Vy

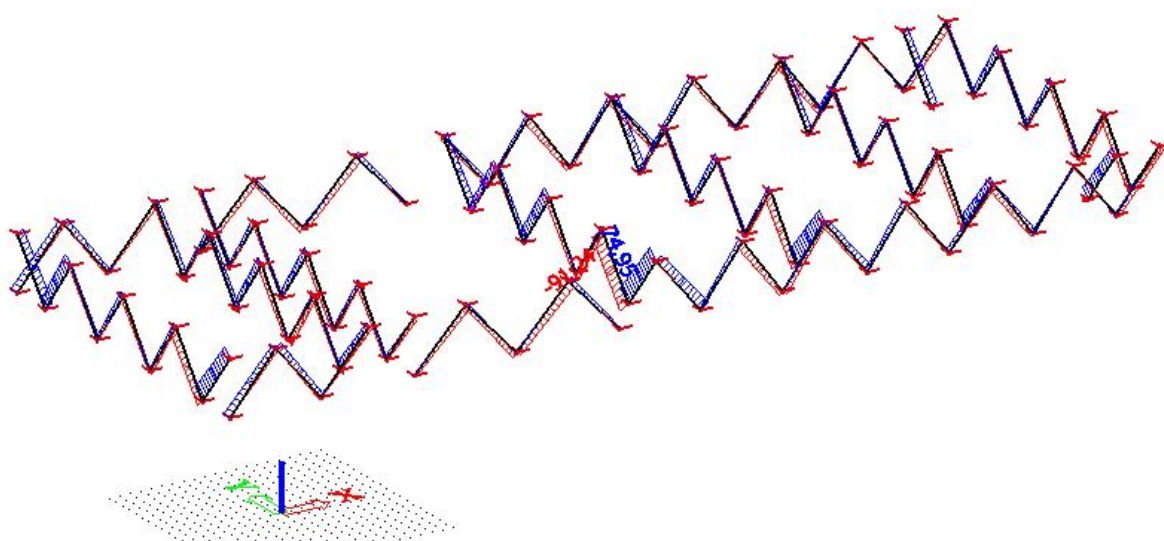

Slika 5.17. Rezne sile-Vz

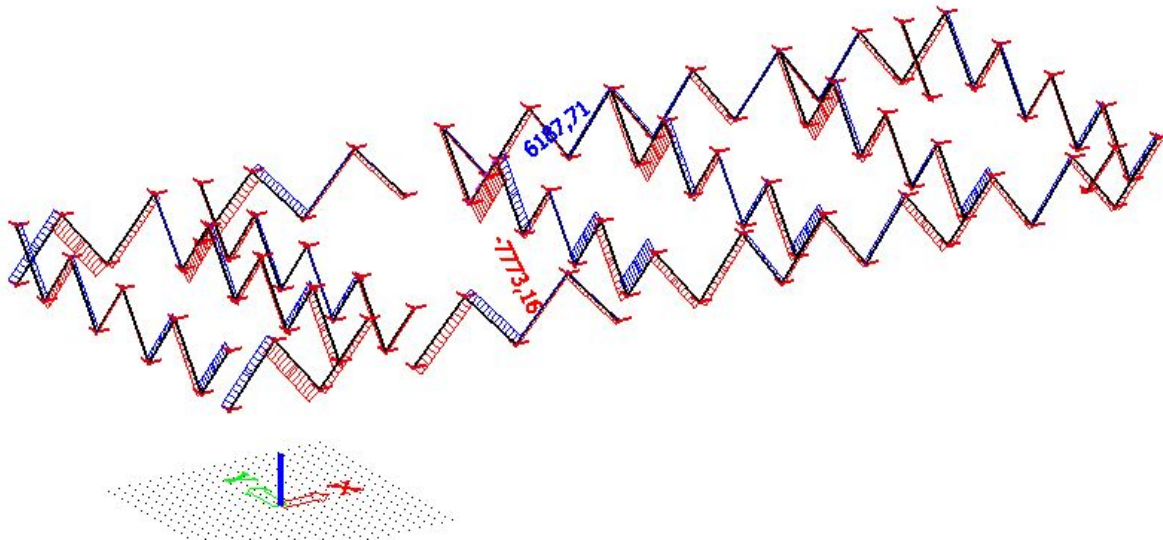

Slika 5.18. Rezne sile-N

Poprečni presjek dijagonala kata

Name	Dijagonale kata	
Type	HEM360	
Source description	Profil Arbed / Structural shapes / Edition Octobre 1995	
Item material	S 355	
Fabrication	rolled	
Flexural buckling y-y	a	
Flexural buckling z-z	b	
Lateral torsional buckling	Default	
Use 2D FEM analysis	*	
A [m <sup>2</sup> ]	3,1880e-02	
A <sub>y, z</sub> [m <sup>2</sup> ]	2,4281e-02	8,6661e-03
I <sub>y, z</sub> [m <sup>4</sup> ]	8,4900e-04	1,9500e-04
I <sub>w</sub> [m <sup>6</sup> ], I <sub>t</sub> [m <sup>4</sup> ]	6,1370e-06	1,5070e-05
W <sub>el y, z</sub> [m <sup>3</sup> ]	4,2570e-05	1,2680e-03
W <sub>pl y, z</sub> [m <sup>3</sup> ]	4,9890e-03	1,9420e-03
d <sub>y, z</sub> [mm]	0	0
c YUCS, ZUCS [mm]	154	197
α [deg]	0,00	
A <sub>L, D</sub> [m <sup>2</sup> /m]	1,9300e+00	1,9334e+00
M <sub>pl y, -</sub> [Nm]	1,77e+06	1,77e+06
M <sub>pl z, -</sub> [Nm]	6,90e+05	6,90e+05

Slika 5.19. Prikaz geometrijskih karakteristika dijagonala kata



Dimenzioniranje**Check of steel**

Linear calculation, Extreme : Global  
 Selection : B67  
 Class : GSN  
 Cross-section : Dijagonale kata - HEM360

**EN 1993-1-1 Code Check**

National annex: Standard EN

<b>Member B67</b>	<b>6,449 m</b>	<b>HEM360</b>	<b>S 355</b>	<b>GSN21/2</b>	<b>0,96 -</b>
-------------------	----------------	---------------	--------------	----------------	---------------

Partial safety factors	
Gamma M0 for resistance of cross-sections	1,00
Gamma M1 for resistance to instability	1,00
Gamma M2 for resistance of net sections	1,25

Material		
Yield strength $f_y$	355,0	MPa
Ultimate strength $f_u$	490,0	MPa
Fabrication	Rolled	

....SECTION CHECK:....

**Classification for cross-section design**

According to EN 1993-1-1 article 5.5.2

**Classification of Internal Compression parts**

According to EN 1993-1-1 Table 5.2 Sheet 1

Maximum width-to-thickness ratio	12,43
Class 1 Limit	26,85
Class 2 Limit	30,92
Class 3 Limit	35,28

=&gt; Internal Compression parts Class 1

**Classification of Outstand Flanges**

According to EN 1993-1-1 Table 5.2 Sheet 2

Maximum width-to-thickness ratio	2,91
Class 1 Limit	7,32
Class 2 Limit	8,14
Class 3 Limit	11,25

=&gt; Outstand Flanges Class 1

=&gt; Section classified as Class 1 for cross-section design

**The critical check is on position 6.449 m**

Internal forces	Calculated	Unit
$N_{Ed}$	-7615,81	kN
$V_{y,Ed}$	12,22	kN
$V_{z,Ed}$	21,20	kN
$T_{Ed}$	0,65	kNm
$M_{y,Ed}$	77,88	kNm
$M_{z,Ed}$	23,12	kNm

**Compression check**

According to EN 1993-1-1 article 6.2.4 and formula (6.9)

A	3,1880e-02	m <sup>2</sup>
$N_{c,Rd}$	11317,40	kN
Unity check	0,67	-

**Bending moment check for  $M_y$** 

According to EN 1993-1-1 article 6.2.5 and formula (6.12),(6.13)

$W_{pl,y}$	4,9890e-03	m <sup>3</sup>
$M_{pl,y,Rd}$	1771,10	kNm
Unity check	0,04	-

**Bending moment check for  $M_z$** 

According to EN 1993-1-1 article 6.2.5 and formula (6.12),(6.13)

$W_{pl,z}$	1,9420e-03	m <sup>3</sup>
$M_{pl,z,Rd}$	689,41	kNm
Unity check	0,03	-

**Shear check for  $V_y$** 

According to EN 1993-1-1 article 6.2.6 and formula (6.17)

Eta	1,20	
-----	------	--

Av	2,5648e-02	m <sup>2</sup>
Vpl,y,Rd	5256,80	kN
Unity check	0,00	-

**Shear check for Vz**

According to EN 1993-1-1 article 6.2.6 and formula (6.17)

Eta	1,20	
Av	1,0240e-02	m <sup>2</sup>
Vpl,z,Rd	2098,78	kN
Unity check	0,01	-

**Torsion check**

According to EN 1993-1-1 article 6.2.7 and formula (6.23)

Tau,t,Ed	1,7	MPa
Tau,Rd	205,0	MPa
Unity check	0,01	-

**Note:** The unity check for torsion is lower than the limit value of 0,05. Therefore torsion is considered as insignificant and is ignored in the combined checks.

**Combined bending, axial force and shear force check**

According to EN 1993-1-1 article 6.2.9.1 and formula (6.41)

MN,y,Rd	653,48	kNm
Alpha	2,00	
MN,z,Rd	460,02	kNm
Beta	3,36	

Unity check (6.41) = 0,01 + 0,00 = 0,01 -

**Note:** Since the shear forces are less than half the plastic shear resistances their effect on the moment resistances is neglected.

The member satisfies the section check.

**....:STABILITY CHECK:....**

**Classification for member buckling design**

Decisive position for stability classification: 0,000 m

**Classification of Internal Compression parts**

According to EN 1993-1-1 Table 5.2 Sheet 1

Maximum width-to-thickness ratio	12,43
Class 1 Limit	26,85
Class 2 Limit	30,92
Class 3 Limit	35,61

=> Internal Compression parts Class 1

**Classification of Outstand Flanges**

According to EN 1993-1-1 Table 5.2 Sheet 2

Maximum width-to-thickness ratio	2,91
Class 1 Limit	7,32
Class 2 Limit	8,14
Class 3 Limit	11,42

=> Outstand Flanges Class 1

=> Section classified as Class 1 for member buckling design

**Flexural Buckling check**

According to EN 1993-1-1 article 6.3.1.1 and formula (6.46)

Buckling parameters	yy	zz	
Sway type	sway	non-sway	
System length L	6,449	6,449	m
Buckling factor k	1,14	0,52	
Buckling length Lcr	7,340	3,352	m
Critical Euler load Ncr	32662,47	35975,03	kN
Slenderness Lambda	44,98	42,86	
Relative slenderness Lambda,rel	0,59	0,56	
Limit slenderness Lambda,rel,0	0,20	0,20	
Buckling curve	a	b	
Imperfection Alpha	0,21	0,34	
Reduction factor Chi	0,89	0,86	
Buckling resistance Nb,Rd	10120,58	9690,10	kN

Flexural Buckling verification		
Cross-section area A	3,1880e-02	m <sup>2</sup>
Buckling resistance Nb,Rd	9690,10	kN
Unity check	0,79	-

**Torsional(-Flexural) Buckling check**

According to EN 1993-1-1 article 6.3.1.1 and formula (6.46)

Torsional buckling length Lcr	6,449	m
Elastic critical load Ncr,T	46507,39	kN
Elastic critical load Ncr,TF	32662,47	kN
Relative slenderness Lambda,rel,T	0,59	
Limit slenderness Lambda,rel,0	0,20	
Buckling curve	b	
Imperfection Alpha	0,34	
Reduction factor Chi	0,84	
Cross-section area A	3,1880e-02	m <sup>2</sup>
Buckling resistance Nb,Rd	9537,40	kN
Unity check	0,80	-

**Lateral Torsional Buckling check**

According to EN 1993-1-1 article 6.3.2.1 &amp; 6.3.2.2 and formula (6.54)

LTB parameters		
Method for LTB curve	General case	
Cross-section plastic modulus Wpl,y	4,9890e-03	m <sup>3</sup>
Elastic critical moment Mcr	10805,61	kNm
Relative slenderness Lambda,rel,LT	0,40	
Limit slenderness Lambda,rel,LT,0	0,20	

**Note:** The slenderness or bending moment is such that Lateral Torsional Buckling effects may be ignored according to EN 1993-1-1 article 6.3.2.2(4).

Mcr parameters		
LTB length L	6,449	m
Influence of load position	no influence	
Correction factor k	1,00	
Correction factor kw	1,00	
LTB moment factor C1	2,81	
LTB moment factor C2	0,10	
LTB moment factor C3	1,00	
Shear center distance d,z	0	mm
Distance of load application z,g	0	mm
Mono-symmetry constant beta,y	0	mm
Mono-symmetry constant z,j	0	mm

**Note:** C parameters are determined according to ECCS 119 2006 / Galea 2002.

**Bending and axial compression check**

According to EN 1993-1-1 article 6.3.3 and formula (6.61),(6.62)

Bending and axial compression check parameters		
Interaction method	alternative method 1	
Cross-section area A	3,1880e-02	m <sup>2</sup>
Cross-section plastic modulus Wpl,y	4,9890e-03	m <sup>3</sup>
Cross-section plastic modulus Wpl,z	1,9420e-03	m <sup>3</sup>
Design compression force N,Ed	7615,81	kN
Design bending moment (maximum) My,Ed	-101,15	kNm
Design bending moment (maximum) Mz,Ed	-105,66	kNm
Characteristic compression resistance N,Rk	11317,40	kN
Characteristic moment resistance My,Rk	1771,10	kNm
Characteristic moment resistance Mz,Rk	689,41	kNm
Reduction factor Chi,y	0,89	
Reduction factor Chi,z	0,84	
Reduction factor Chi,LT	1,00	
Interaction factor k,yy	0,96	
Interaction factor k,yz	0,49	
Interaction factor k,zy	0,55	
Interaction factor k,zz	0,83	

Maximum moment My,Ed is derived from beam: B67 position 0,000 m.  
 Maximum moment Mz,Ed is derived from beam: B67 position 0,000 m.

Interaction method 1 parameters		
Critical Euler load $N_{cr,y}$	32662,47	kN
Critical Euler load $N_{cr,z}$	35975,03	kN
Elastic critical load $N_{cr,T}$	46507,39	kN
Cross section plastic modulus $W_{pl,y}$	4,9890e-03	m <sup>3</sup>
Cross-section elastic modulus $W_{el,y}$	4,2970e-03	m <sup>3</sup>
Cross-section plastic modulus $W_{pl,z}$	1,9420e-03	m <sup>3</sup>
Cross-section elastic modulus $W_{el,z}$	1,2680e-03	m <sup>3</sup>
Second moment of area $I_y$	8,4900e-04	m <sup>4</sup>
Second moment of area $I_z$	1,9500e-04	m <sup>4</sup>
Torsional constant $I_t$	1,5070e-05	m <sup>4</sup>
Method for equivalent moment factor $C_{my,0}$	Table A.2 Line 2 (General)	
Design bending moment (maximum) $M_{y,Ed}$	-101,15	kNm
Maximum relative deflection $\delta_{t,z}$	0,4	mm
Equivalent moment factor $C_{my,0}$	0,80	
Method for equivalent moment factor $C_{mz,0}$	Table A.2 Line 2 (General)	
Design bending moment (maximum) $M_{z,Ed}$	-105,66	kNm
Maximum relative deflection $\delta_{t,y}$	4,3	mm
Equivalent moment factor $C_{mz,0}$	0,87	
Factor $\mu_y$	0,97	
Factor $\mu_z$	0,96	
Factor $\epsilon_{y,T}$	0,10	
Factor $a_{LT}$	0,98	
Critical moment for uniform bending $M_{cr,0}$	3847,03	kNm
Relative slenderness $\lambda_{rel,0}$	0,68	
Limit relative slenderness $\lambda_{rel,0,lim}$	0,30	
Equivalent moment factor $C_{my}$	0,85	
Equivalent moment factor $C_{mz}$	0,87	
Equivalent moment factor $C_{mLT}$	1,00	
Factor $b_{LT}$	0,00	
Factor $c_{LT}$	0,06	
Factor $d_{LT}$	0,08	
Factor $e_{LT}$	0,38	
Factor $w_y$	1,16	
Factor $w_z$	1,50	
Factor $n_{pl}$	0,67	
Maximum relative slenderness $\lambda_{rel,max}$	0,59	
Factor $C_{yy}$	1,12	
Factor $C_{yz}$	1,48	
Factor $C_{zy}$	1,02	
Factor $C_{zz}$	1,29	

Unity check (6.61) =  $0,75 + 0,05 + 0,08 = 0,88$  -

Unity check (6.62) =  $0,80 + 0,03 + 0,13 = 0,96$  -

#### Shear Buckling check

According to EN 1993-1-5 article 5 & 7.1 and formula (5.10) & (7.1)

Shear Buckling parameters		
Buckling field length $a$	6,449	m
Web	unstiffened	
Web height $h_w$	315	mm
Web thickness $t$	21	mm
Material coefficient $\epsilon$	0,81	
Shear correction factor $\eta$	1,20	

#### Shear Buckling verification

Web slenderness $h_w/t$	15,00
Web slenderness limit	48,82

**Note:** The web slenderness is such that Shear Buckling effects may be ignored according to EN 1993-1-5 article 5.1(2).

The member satisfies the stability check.

Student version

Iskoristivost elemenata za GSN – 96%

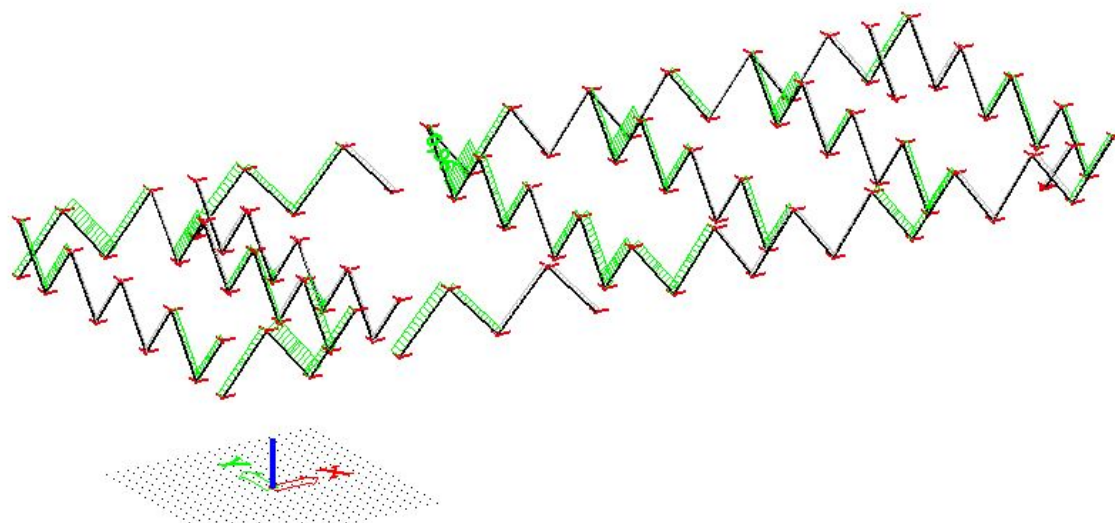

Slika 5.20. Prikaz iskoristivosti dijagonala kata

#### 5.4. Spregnuta rampa (kat-krov)

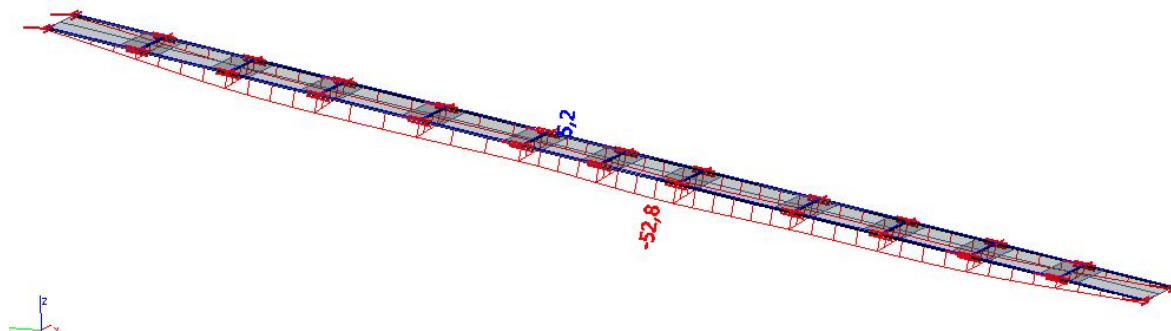

Slika 5.21. Prikaz vertikalnog pomaka grednih nosača

Dopušteni vertikalni pomak (progib):

$$u_{dop} = \frac{l}{300} = \frac{28,71}{300} = 95,7 \text{ mm}$$

$$u_z = 52,8 \text{ mm} < u_{dop} = 95,7 \text{ mm} \quad \text{-zadovoljava}$$

$$\text{-iskoristivost na GSU} - 52,8 \text{ mm} / 95,7 \text{ mm} = 0,55 = 55\%$$

Rezne sile grednih nosača

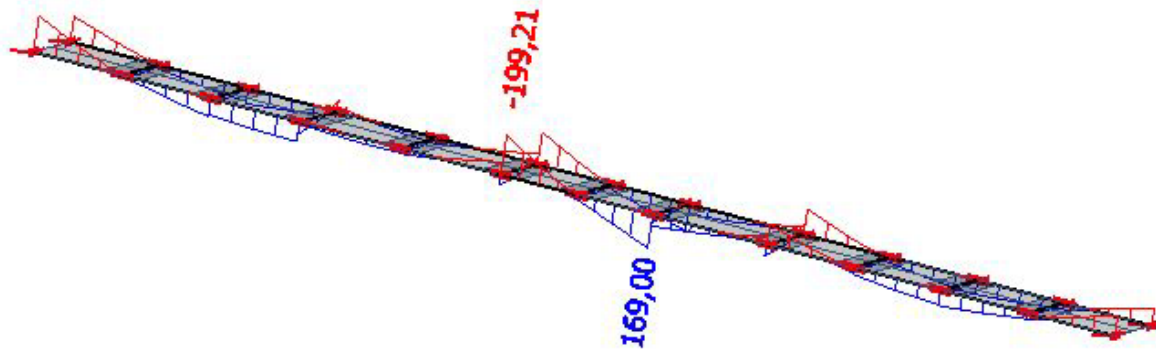

Slika 5.22. Rezene sile My

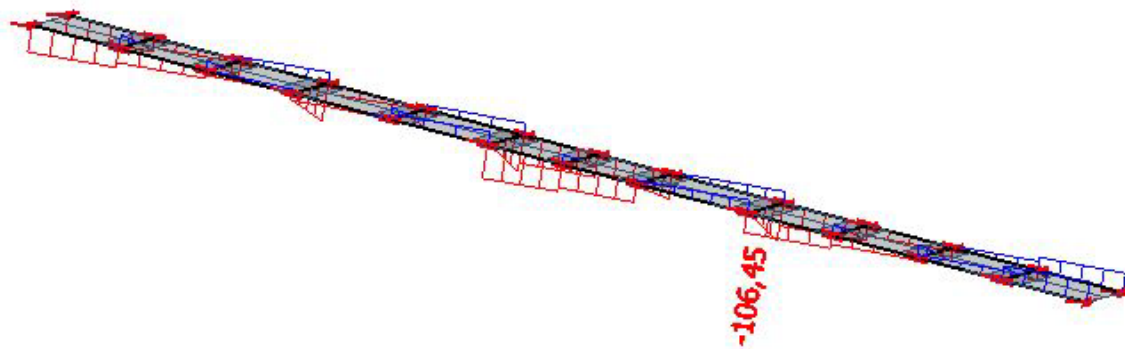

Slika 5.23. Rezene sile Vz

Poprečni presjek grednih nosača

Name	Rampa nosači kata	
Type	HEM180	
Source description	Profil Arbed / Structural shapes / Edition Octobre 1995	
Item material	S 355	
Fabrication	rolled	
Flexural buckling y-y	b	
Flexural buckling z-z	c	
Lateral torsional buckling	Default	
Use 2D FEM analysis	x	
A [m <sup>2</sup> ]	1,1330e-02	
A <sub>y</sub> , z [m <sup>2</sup> ]	8,7965e-03	3,0477e-03
I <sub>y</sub> , z [m <sup>4</sup> ]	7,4900e-05	2,5800e-05
I <sub>w</sub> [m <sup>4</sup> ], I <sub>t</sub> [m <sup>4</sup> ]	1,9933e-07	2,0330e-06
W <sub>el</sub> y, z [m <sup>3</sup> ]	7,4830e-04	2,7740e-04
W <sub>pl</sub> y, z [m <sup>3</sup> ]	8,8340e-04	4,2520e-04
d y, z [mm]	0	0
c YUCS, ZUCS [mm]	93	100
α [deg]	0,00	
A <sub>L</sub> , D [m <sup>2</sup> /m]	1,0900e+00	1,0891e+00
M <sub>ply</sub> +, - [Nm]	3,14e+05	3,14e+05
M <sub>plz</sub> +, - [Nm]	1,51e+05	1,51e+05

Slika 5.24. Prikaz geometrijskih karakteristika grednih nosača rampe

Dimenzioniranje**Composite Beam - Final stage**

Linear calculation  
 Class: GSN  
 Extreme 1D: Global  
 Selection: B681

Filter: Cross-section = Rampa nosači kata - HEM180

**Composite beam verification**

for beam B681 at section 16.3 m, in accordance with EC EN 1994-1-1

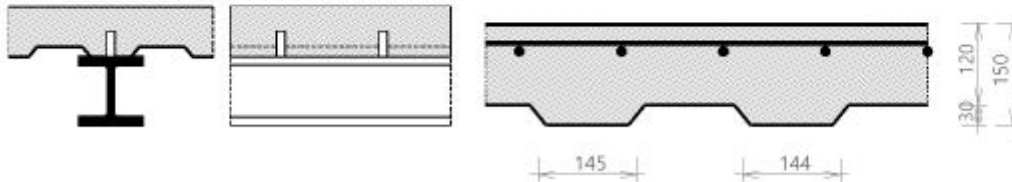
**1. Geometry data****Simply supported beam**

Length of the current span	$L = 28.71 \text{ m}$
Beam spacing at the left	$L_{\text{left}} = 2 \text{ m}$
Distance to the slab edge at the right	$L_{\text{right}} = 7.11 \cdot 10^{-15} \text{ m}$
Checked section	$d_x = 16.31 \text{ m}$

*Warning: For a continuous beam, intermediate buckling supports y-y are ignored in both the calculation of the effective width for the analysis model and the check.*

**2. Cross-section & materials****2.1 Steel section properties****2.1.1 Cross-section**

Cross-section	HEM180
Height	$h_a = 200 \text{ mm}$
Width	$b = 186 \text{ mm}$
Web thickness	$t_w = 15 \text{ mm}$
Flange thickness	$t_f = 24 \text{ mm}$
Radius	$r = 15 \text{ mm}$
Area	$A_a = 11330 \text{ mm}^2$
Moment of inertia	$I_y = 74.9 \cdot 10^6 \text{ mm}^4$
Radius of gyration	$i_z = 48 \text{ mm}$
Plastic section modulus	$W_{\text{ply}} = 883400 \text{ mm}^3$

**2.1.2 Material**

Steel grade	S 355
Yield strength	$f_{yb} = 355 \text{ MPa}$
Ultimate strength	$f_{ub} = 490 \text{ MPa}$
E modulus	$E_s = 210000 \text{ MPa}$

Student version

**2.1.3 Cross-section classification**

$$\epsilon = \sqrt{\frac{235}{355}} = 0.814$$

(EN 1993-1-1 §5.6 Tab. 5.2)

**2.1.3.1 Flange in compression**

$$c_f = \frac{b - t_w - 2 \cdot r}{2} = \frac{186 \text{ mm} - 14.5 \text{ mm} - 2 \cdot 15 \text{ mm}}{2} = 70.8 \text{ mm}$$

$$\frac{c_f}{t_f} \leq 9 \cdot \epsilon$$

$$\frac{70.8 \text{ mm}}{24 \text{ mm}} \leq 9 \cdot 0.814$$

$$2.95 \leq 7.32 \quad \text{OK}$$

Flange classified as Class 1.

**2.1.3.2 Web in bending**

$$c_w = h_a - 2 \cdot t_f - 2 \cdot r = 200 \text{ mm} - 2 \cdot 24 \text{ mm} - 2 \cdot 15 \text{ mm} = 122 \text{ mm}$$

$$\alpha_{cl} = 0.5$$

$$\frac{c_w}{t_w} \leq \frac{36 \cdot \epsilon}{\alpha_{cl}}$$

$$\frac{122 \text{ mm}}{14.5 \text{ mm}} \leq \frac{36 \cdot 0.814}{0.5}$$

$$8.41 \leq 58.6 \quad \text{OK}$$

Web classified as Class 1.

**Cross-section classified as Class 1**

Cross-section Class OK.

**2.2 Concrete slab with profiled sheeting**

**2.2.1 Concrete slab**

**2.2.1.1 Slab**

Total height of the slab  $h_s = 150 \text{ mm}$

**2.2.1.2 Material**

Concrete class	C30/37
Characteristic strength	$f_{ck} = 30 \text{ MPa}$
E modulus	$E_{cm} = 32800 \text{ MPa}$

**2.2.2 Profiled steel sheeting**

Note: The angle between the member and the ribs of profiled steel sheeting is smaller than  $10^\circ$  thus the ribs are considered as parallel to the beam.

Sheeting with ribs parallel to the supporting beams

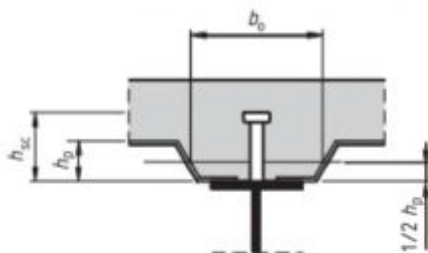

Student version



Name	ComFlor 80-0.9
Depth of the ribs	$h_p = 30 \text{ mm}$
Height of full concrete	$h_c = 120 \text{ mm}$
Height of the re-entrant stiffener	$h_d = 0 \text{ mm}$
Spacing of the ribs	$b_s = 300 \text{ mm}$
Top width of the rib	$b_r = 131 \text{ mm}$
Bottom width of the rib	$b_b = 120 \text{ mm}$
Mean width of the ribs	$b_{0,rib} = 144.5 \text{ mm}$
Thickness of the sheeting	$t_p = 2 \text{ mm}$

### 2.2.3 Shear connectors

#### 2.2.3.1 Geometry

Name	SHC1
Diameter	$d_s = 25 \text{ mm}$
Nominal height	$h_{nom} = 80 \text{ mm}$
As-welded height	$h_{sc} = 75 \text{ mm}$
Amount per trough or section	$n_r = 1$

Warning: Condition given by EN 1994-1-1 Art. 6.6.5.8 (1) is not fulfilled.

#### 2.2.3.2 Material

Steel grade	S 355
Ultimate strength	$f_{us} = 490 \text{ MPa}$

### 2.2.4 Reinforcement

#### 2.2.4.1 Geometry

Longitudinal bar diameter	$d_l = 16 \text{ mm}$
Longitudinal bar spacing	$s_l = 150 \text{ mm}$
Longitudinal bar cover	$c_l = 30 \text{ mm}$
Transverse bar diameter	$d_t = 16 \text{ mm}$
Transverse bar spacing	$s_t = 150 \text{ mm}$
Transverse bar cover	$c_t = 46 \text{ mm}$

#### 2.2.4.2 Material

Material	B 500B
Characteristic yield strength	$f_{ykr} = 500 \text{ MPa}$

### 3. Design values of loads

Load Name : GSN21

Content of combination :  $1.35 \cdot \text{vlastitateZina} + 1.35 \cdot \text{vlastitateZina\_dryconcrete} + 1.35 \cdot \text{Snijeg} +$   
 $1.35 \cdot \text{Dodatnostalno} + 1.62 \cdot \text{Pokretno} + 1.35 \cdot \text{trenjex} + 1.35 \cdot \text{vjetarkrovx2} +$   
 $1.35 \cdot \text{vjetarbocnix1x2} + 1.35 \cdot \text{temperaturajednolika}$

Bending moment	$M_{Ed,comp} = -236.121 \text{ kNm}$
Shear force	$V_{Ed,comp} = -136.406 \text{ kN}$

### 4. Partial safety factors

Steel section	$\gamma_{M0} = 1$ $\gamma_{M1} = 1$
Shear connectors	$\gamma_V = 1.25$
Concrete	$\gamma_C = 1.5$
Reinforcement	$\gamma_S = 1.15$

**5. ULS check of the Final stage**

**5.1 Shear connection**

**5.1.1 Design resistance of shear connectors**

**5.1.1.1 Shear connector in a solid slab**

$$3 \leq \frac{h_{sc}}{d_s} \leq 4$$

$$3 \leq 3 \leq 4$$

$$\alpha = 0.2 \cdot \left( \frac{h_{sc}}{d_s} + 1 \right) = 0.2 \cdot \left( \frac{75 \text{ mm}}{25 \text{ mm}} + 1 \right) = 0.8$$

$$f_{us} = \min(490; 500) \text{ MPa}$$

$$P_{Rd,solid,1} = \frac{0.8 \cdot f_{us} \cdot \left( \frac{\pi \cdot d_s^2}{4} \right)}{\gamma_v} = \frac{0.8 \cdot 490 \text{ MPa} \cdot \left( \frac{3.14 \cdot 25 \text{ mm}^2}{4} \right)}{1.25} = 154 \text{ kN}$$

$$P_{Rd,solid,2} = \frac{0.29 \cdot \alpha \cdot d_s^2 \cdot \sqrt{f_{ck} \cdot F_{cm}}}{\gamma_v} = \frac{0.29 \cdot 0.8 \cdot 25 \text{ mm}^2 \cdot \sqrt{30 \text{ MPa} \cdot 32800 \text{ MPa}}}{1.25} = 115 \text{ kN}$$

$$P_{Rd,solid} = \min(P_{Rd,solid,1}; P_{Rd,solid,2}) = \min(154 \text{ kN}; 115 \text{ kN}) = 115 \text{ kN}$$

**5.1.1.2 Shear connector in profiled sheeting**

Sheeting with ribs parallel to the supporting beams

$$k_1 = \frac{0.6 \cdot b_{0,rib}}{h_p} \cdot \left( \frac{h_{sc}}{h_p} - 1 \right) = \frac{0.6 \cdot 145 \text{ mm}}{30 \text{ mm}} \cdot \left( \frac{75 \text{ mm}}{30 \text{ mm}} - 1 \right) = 4.34$$

$$k_1 = 1$$

$$P_{Rd} = k_1 \cdot P_{Rd,solid} = 1 \cdot 115 \text{ kN} = 115 \text{ kN}$$

**5.1.2 Degree of shear connection**

**5.1.2.1 Determination of  $b_{eff}$  of the concrete flange and length  $L_e$**

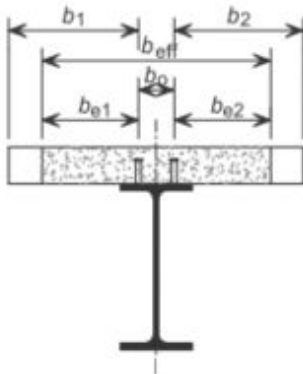

The effective width in the interval <0.25;0.75>

$$L_{e1} = L_1 = 28.7 \text{ m}$$

**Left side of the beam**

Manual input of effective width on the side.

$$b_{eff,l} = 1 \text{ m}$$

**Right side of the beam**

Manual input of effective width on the side.

$$b_{eff,r} = 0 \text{ m}$$

**Calculation of  $b_{eff}$** 

$$b_{eff} = b_{eff,l} + b_{eff,r} = 1 \text{ m}$$

**Determination of  $L_e$** 

$$L_e = L_{e1} = 28.7 \text{ m}$$

**5.1.2.2 Minimum degree of shear connection**

$$\eta_{min} = 1 = 1$$

**5.1.2.3 Degree of shear connection present****5.1.2.3.1 Tension resistance of the reinforcement**

$$A_s = \frac{b_{eff}}{s_l} \cdot \left( \frac{d_l^2}{4} \right) \cdot \pi = \frac{1 \text{ m}}{150 \text{ mm}} \cdot \left( \frac{16 \text{ mm}^2}{4} \right) \cdot 3.14 = 1340 \text{ mm}^2$$

$$F_s = \frac{A_s \cdot f_{yk,r}}{\gamma_s} = \frac{1.34 \cdot 10^{-3} \cdot 500 \cdot 10^6}{1.15} = 583 \text{ kN}$$

**5.1.2.3.2 Tension resistance of the steel member**

$$N_{pl,a} = f_{yb} \cdot A_a = 355 \text{ MPa} \cdot 11330 \text{ mm}^2 = 4022.15 \text{ kN}$$

$$N_{c,r} = \min(F_s; N_{pl,a}) = \min(583 \text{ kN}; 4022.15 \text{ kN}) = 582.79 \text{ kN}$$

**5.1.2.3.3 Resistance of the shear connectors**

$$l_s = \frac{L}{n_{row}} = \frac{28.7}{10} = 2871 \text{ mm}$$

Number of shear studs available per length  $L_e/2$

$$n_{sp} = \frac{0.5 \cdot L_e}{l_s} \cdot n_s$$

$$n_{sp} = 5 \cdot 1 = 5$$

Warning: Condition given by EN 1994-1-1 Art. 6.6.5.5 (3) is not fulfilled.

$$N_c = n_{sp} \cdot P_{Rd} = 5 \cdot 115068 = 575.34 \text{ kN}$$

$$\eta = \min\left(\frac{N_c}{N_{c,r}}; 1\right) = \min\left(\frac{575.34 \text{ kN}}{582.79 \text{ kN}}; 1\right) = 0.99$$

$$\eta \geq \eta_{min}$$

$$1 \geq 1$$

NOT OK

Warning: The shear connection degree is not adequate.

**5.2 Cross-sectional resistance of the composite beam****5.2.1 Shear buckling**

$$h_w = h_a - 2 \cdot t_f = 200 \text{ mm} - 2 \cdot 24 \text{ mm} = 152 \text{ mm}$$

$$\eta_{sb} = 1.2$$

$$\frac{h_w}{t_w} \leq \frac{72 \cdot \epsilon}{\eta_{sb}}$$

$$\frac{152 \text{ mm}}{14.5 \text{ mm}} \leq \frac{72 \cdot 0.814}{1.2}$$

$$10.5 \leq 48.8$$

OK

The shear buckling resistance of the web does not need to be verified.

Student version

### 5.2.2 Vertical shear

The resistance to vertical shear should be taken as the resistance of the structural steel section.

$$A_v = A_a - 2 \cdot b \cdot t_f + (t_w + 2 \cdot r) \cdot t_f \\ = 0.0113 - 2 \cdot 0.186 \cdot 0.024 + (0.0145 + 2 \cdot 0.015) \cdot 0.024 = 3470 \text{ mm}^2$$

$$A_{v,\min} = \eta_{sb} \cdot h_w \cdot t_w = 1.2 \cdot 0.152 \cdot 0.0145 = 2645 \text{ mm}^2$$

$$A_v \geq A_{v,\min}$$

$$3470 \text{ mm}^2 \geq 2645 \text{ mm}^2$$

$$V_{pl,Rd} = \frac{A_v \cdot f_{yb}}{\sqrt{3} \cdot \gamma_{MO}} = \frac{3470 \text{ mm}^2 \cdot 355 \cdot 10^6}{\sqrt{3} \cdot 1} = 711 \text{ kN}$$

$$UC_{\text{comp}_V} = \frac{\text{abs}(V_{Ed,\text{comp}})}{V_{pl,Rd}} = \frac{\text{abs}(-136.406 \text{ kN})}{711 \text{ kN}} = 0.19$$

The shear resistance of the section is adequate.

### 5.2.3 Bending moment

#### 5.2.3.1 Longitudinal reinforcement

##### 5.2.3.1.1 Centre of composite section

For buildings not intended mainly for storage the effects of creep in concrete beams may be taken into account by using an effective E modulus  $E_{c,\text{eff}} = E_{cm} / 2$ .

$$E_{c,\text{eff}} = \frac{E_{cm}}{2} = \frac{32800 \text{ MPa}}{2} = 16400 \text{ MPa}$$

$$\eta_E = \frac{E_b}{E_{c,\text{eff}}} = \frac{210000 \text{ MPa}}{16400 \text{ MPa}} = 12.8$$

$$y_d = \frac{A_a \cdot \left(\frac{h_a}{2}\right) + \left(\frac{1}{\eta_E}\right) \cdot b_{\text{eff}} \cdot (h_c - h_d) \cdot \left(h_a + h_s - \frac{h_c - h_d}{2}\right)}{A_a + \left(\frac{1}{\eta_E}\right) \cdot b_{\text{eff}} \cdot (h_c - h_d)} \\ = \frac{0.0113 \cdot \left(\frac{0.2}{2}\right) + \left(\frac{1}{12.8}\right) \cdot 1 \cdot (0.12 - 0) \cdot \left(0.2 + 0.15 - \frac{0.12 - 0}{2}\right)}{0.0113 + \left(\frac{1}{12.8}\right) \cdot 1 \cdot (0.12 - 0)} = 186 \text{ mm}$$

##### 5.2.3.1.2 Degree of reinforcement

$$A_s = \frac{b_{\text{eff}}}{s_f} \cdot \left(\frac{d_f^2}{4}\right) \cdot \pi = \frac{1 \text{ m}}{150 \text{ mm}} \cdot \left(\frac{16 \text{ mm}^2}{4}\right) \cdot 3.14 = 1340 \text{ mm}^2$$

$$A_c = b_{\text{eff}} \cdot (h_c - h_d) = 1 \cdot (0.12 - 0) = 120000 \text{ mm}^2$$

$$z_0 = \left(h_a + h_s - \frac{h_c - h_d}{2}\right) - y_d = \left(0.2 + 0.15 - \frac{0.12 - 0}{2}\right) - 0.186 = 104 \text{ mm}$$

$$k_c = \min\left(\frac{1}{1 + \frac{h_c - h_d}{2 \cdot z_0}} + 0.3; 1\right) = \min\left(\frac{1}{1 + \frac{0.12 - 0}{2 \cdot 0.104}} + 0.3; 1\right) = 0.934$$

$$\rho_s = \delta \cdot \left(\frac{f_{yb}}{235}\right) \cdot \left(\frac{f_{ctm}}{f_{yk,r}}\right) \cdot \sqrt{k_c} = 1.1 \cdot \left(\frac{355}{235}\right) \cdot \left(\frac{2.9 \cdot 10^6}{500 \cdot 10^6}\right) \cdot \sqrt{0.934} = 0.931 \%$$

$$A_s \geq \rho_s \cdot A_c$$

$$1340 \text{ mm}^2 \geq 9.31 \cdot 10^{-3} \cdot 120000 \text{ mm}^2$$

$$1340 \text{ mm}^2 \geq 1118 \text{ mm}^2 \quad \text{OK}$$

The longitudinal reinforcement of the section is adequate.

**5.2.3.2 Moment resistance****Moment resistance of a steel cross-section**

$$M_{pl,Rd,a} = \frac{W_{pl,y} \cdot f_{yb}}{\gamma_{M0}} = \frac{883400 \text{ mm}^3 \cdot 355 \text{ MPa}}{1} = 314 \text{ kNm}$$

**Influence of shear**

$$\frac{V_{pl,Rd}}{2} > \text{abs}(V_{Ed,comp})$$

$$\frac{711 \text{ kN}}{2} > 136 \text{ kN}$$

$$356 \text{ kN} > 136 \text{ kN} \quad \text{OK}$$

The influence of the vertical shear on the bending moment resistance may be neglected.

$$f_{yb,w} = f_{yb} = 355 \text{ MPa}$$

**Modified tension resistance of the steel member**

$$r = 0 \text{ mm}$$

$$A_a = 2 \cdot t_f \cdot b + t_w \cdot (h_a - 2 \cdot t_f) = 2 \cdot 24 \text{ mm} \cdot 186 \text{ mm} + 14.5 \text{ mm} \cdot (200 \text{ mm} - 2 \cdot 24 \text{ mm}) = 11132 \text{ mm}^2$$

$$N_{pl,a} = A_a \cdot f_{yb} = 11132 \text{ mm}^2 \cdot 355 \text{ MPa} = 3951.86 \text{ kN}$$

Note: Roundings of the steel cross-section are neglected in bending resistance calculation.

$$N_{c,f} = \min(F_s; N_{pl,a}) = \min(583 \text{ kN}; 3951.86 \text{ kN}) = 582.79 \text{ kN}$$

**Negative bending moment resistance calculation**

Warning: Full degree of shear connection is required according to EN 1994-1-1, Art. 6.2.1.3 (2).

The plastic neutral axis is located within the web of the steel section.

$$N_{at,f} = b \cdot t_f \cdot f_{yb} = 0.186 \cdot 0.024 \cdot 355 \cdot 10^6 = 1584.72 \text{ kN}$$

$$N_{pl,a} - N_{at,f} = N_{at,w} = F_s + N_{at,f} + N_{at,w}$$

$$x = \frac{(N_{pl,a} - 2 \cdot N_{at,f} - F_s)}{(2 \cdot t_w \cdot f_{yb,w})} = \frac{(3951.86 \text{ kN} - 2 \cdot 1584.72 \text{ kN} - 583 \text{ kN})}{(2 \cdot 14.5 \text{ mm} \cdot 355 \text{ MPa})} = 19.4 \text{ mm}$$

Verification of the steel web classification.

$$\alpha_{cl} = \frac{c_w - x}{c_w} = \frac{122 - 19.4}{122} = 0.841$$

$$\frac{c_w}{t_w} \leq \frac{396 \cdot \epsilon}{13 \cdot \alpha_{cl} - 1}$$

$$\frac{122 \text{ mm}}{14.5 \text{ mm}} \leq \frac{396 \cdot 0.814}{13 \cdot 0.841 - 1}$$

$$8.41 \leq 32.4 \quad \text{OK}$$

Web classified as Class 1.

$$N_{at,w} = t_w \cdot x \cdot f_{yb,w} = 14.5 \text{ mm} \cdot 19.4 \text{ mm} \cdot 355 \text{ MPa} = 99.82 \text{ kN}$$

$$N_{a,c} = N_{pl,a} - N_{at,f} - N_{at,w} = 3951.86 \text{ kN} - 1584.72 \text{ kN} - 99.82 \text{ kN} = 2267.32 \text{ kN}$$

Leverage arm of the compression part of the steel section calculated to the PNA.

$$h_{cs} = \frac{(t_w \cdot (h_a - 2 \cdot t_f - x)^2 \cdot 0.5 + t_f \cdot b \cdot (h_a - 1.5 \cdot t_f - x))}{t_w \cdot (h_a - 2 \cdot t_f - x) + t_f \cdot b}$$

$$= \frac{(14.5 \cdot (200 - 2 \cdot 24 - 19.4)^2 \cdot 0.5 + 24 \cdot 186 \cdot (200 - 1.5 \cdot 24 - 19.4))}{14.5 \cdot (200 - 2 \cdot 24 - 19.4) + 24 \cdot 186} = 121 \text{ mm}$$

$$h_l = x + t_f + h_s - c_l + \frac{d_l}{2} = 0.0194 + 0.024 + 0.15 - 0.03 + \frac{0.016}{2} = 155 \text{ mm}$$

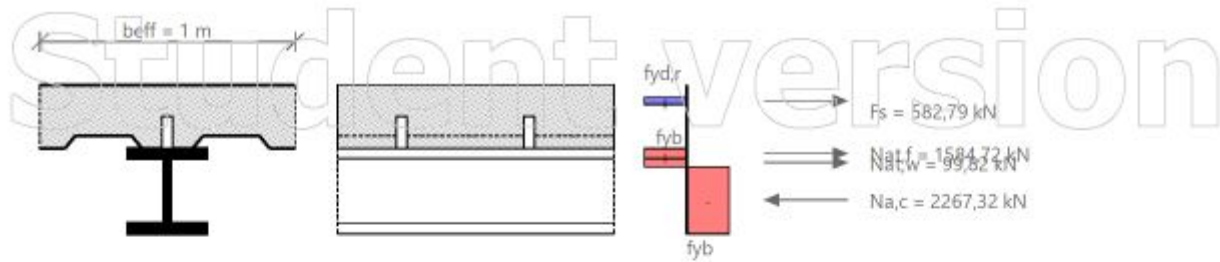

$$\begin{aligned}
 M_{pl,Rd} &= F_s \cdot h_1 + N_{at,f} \cdot \left( \frac{t_f}{2} + x \right) + \frac{N_{at,w} \cdot x}{2} + N_{a,c} \cdot h_{cs} \\
 &= 583 \cdot 155 + 1584,72 \cdot \left( \frac{24}{2} + 19,4 \right) + \frac{99,82 \cdot 19,4}{2} + 2267,32 \cdot 121 = 416 \text{ kNm}
 \end{aligned}$$

**Design moment resistance according to simplified method given by EN 1994-1-1 Art.6.2.1.3 (5)**

$$M_{Rd} = M_{pl,Rd,a} + (M_{pl,Rd} - M_{pl,Rd,a}) \cdot \eta = 314 \text{ kNm} + (416 \text{ kNm} - 314 \text{ kNm}) \cdot 0,99 = 414 \text{ kNm}$$

$$UC_{comp,M} = \frac{\text{abs}(M_{Ed,comp})}{M_{Rd}} = \frac{\text{abs}(-236,121 \text{ kNm})}{414 \text{ kNm}} = 0,57$$

The bending moment resistance of the section is adequate.

**5.3 LTB resistance**

$$F = \left( 1 + \frac{t_w \cdot (h_a - t_f)}{4 \cdot b \cdot t_f} \right) \cdot \left( \frac{h_a - t_f}{t_w} \right)^{0,75} \cdot \left( \frac{t_f}{b} \right)^{0,25} = \left( 1 + \frac{14,5 \cdot (200 - 24)}{4 \cdot 186 \cdot 24} \right) \cdot \left( \frac{200 - 24}{14,5} \right)^{0,75} \cdot \left( \frac{24}{186} \right)^{0,25} = 4,45$$

$$F_{lim} = 12,3$$

$$F \leq F_{lim}$$

$$4,45 \leq 12,3$$

OK

The cross-section is qualified for verification of LTB by the simplified method.

$$C_4 = 25$$

$$\begin{aligned}
 \lambda_{LT,rel} &= 5 \cdot \left( 1 + \frac{t_w \cdot (h_a - t_f)}{4 \cdot b \cdot t_f} \right) \cdot \left( \frac{h_a - t_f}{t_w} \right)^{0,75} \cdot \left( \frac{t_f}{b} \right)^{0,25} \cdot \left( \frac{f_{yb}}{E_b \cdot C_4} \right)^{0,5} \\
 &= 5 \cdot \left( 1 + \frac{0,0145 \cdot (0,2 - 0,024)}{4 \cdot 0,186 \cdot 0,024} \right) \cdot \left( \frac{0,2 - 0,024}{0,0145} \right)^{0,75} \cdot \left( \frac{0,024}{0,186} \right)^{0,25} \cdot \left( \frac{355 \cdot 10^6}{210 \cdot 10^9 \cdot 25} \right)^{0,5} = 0,183
 \end{aligned}$$

$$X_{LT} = 1 = 1$$

$$M_{b,Rd} = X_{LT} \cdot M_{Rd} = 1 \cdot 414,394 = 414,394 \text{ kNm}$$

$$UC_{comp\_LTB} = \frac{\text{abs}(M_{Ed,comp})}{M_{b,Rd}} = \frac{\text{abs}(-236,121 \text{ kNm})}{414,394 \text{ kNm}} = 0,57$$

The later torsional buckling resistance of the section is adequate.

Student version

**5.4 Longitudinal shear****5.4.1 Transverse reinforcement**

Design shear flow

$$h_f = h_c = 120 \text{ mm}$$

$$v_{Ed} = \frac{n_f \cdot P_{Rd}}{l_s \cdot h_f} = \frac{1 \cdot 115 \text{ kN}}{2871 \text{ mm} \cdot 120 \text{ mm}} = 0.334 \text{ MPa}$$

Transverse reinforcement

$$\frac{A_{sf} \cdot f_{yk,f}}{\gamma_s \cdot s_f} \geq \frac{v_{Ed} \cdot h_f}{\cotg(\theta)}$$

$$A_t = A_{sf}/s_f$$

$$A_t = \frac{v_{Ed} \cdot h_f}{\left( \frac{\cotg(\theta) \cdot f_{yk,f}}{\gamma_s} \right)} = \frac{334021 \cdot 0.12}{\left( \frac{\cotg(26.5) \cdot 500 \cdot 10^6}{1.15} \right)} = 46 \text{ mm}^2/\text{m}$$

$$A_{t,prov} = \frac{1}{s_t} \cdot \left( \frac{d_t^2}{4} \right) \cdot 3.14 = \frac{1}{0.15} \cdot \left( \frac{0.016^2}{4} \right) \cdot 3.14 = 1340 \text{ mm}^2/\text{m}$$

$$A_{t,prov} \geq A_t$$

$$1340 \text{ mm}^2/\text{m} \geq 46 \text{ mm}^2/\text{m} \quad \text{OK}$$

The transverse reinforcement of the section is adequate.

**ULS check of Final stage is NOT OK.**

$$UC_{comp} = \max(0.19; 0.57; 0.57) = 0.57$$

Iskoristivost elemenata za GSN – 57%

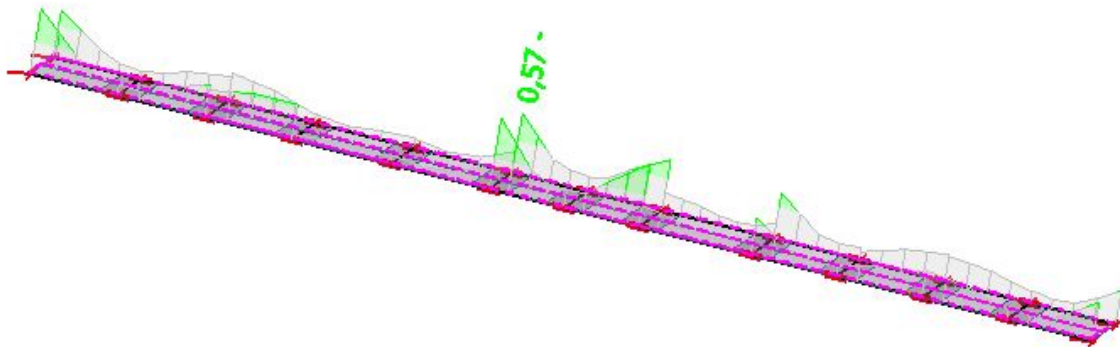

Slika 5.25. Prikaz iskoristivosti grednih nosača rampe

### 5.5. Stupovi rampe (kat-krov)

Rezne sile stupova rampe

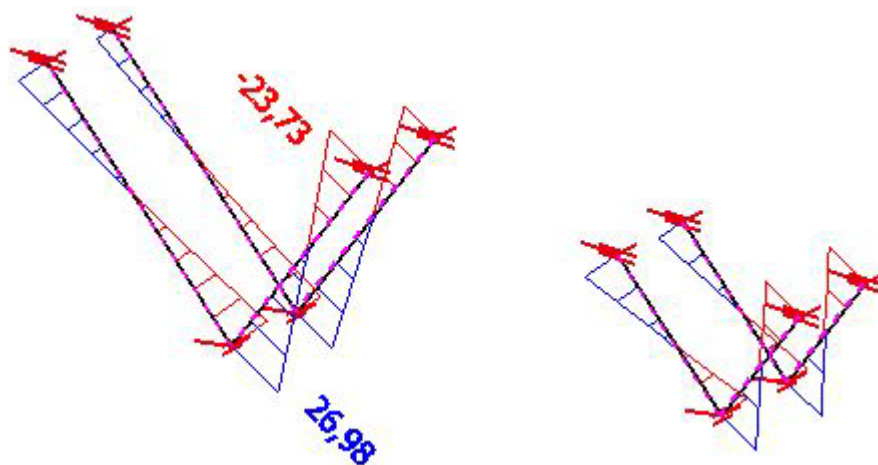

Slika 5.26. Rezne sile  $M_y$

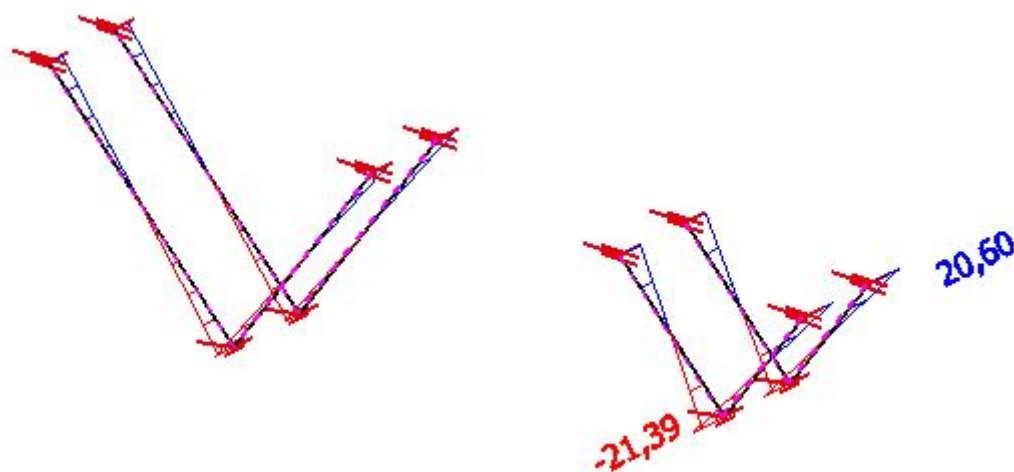

Slika 5.27. Rezne sile  $M_z$

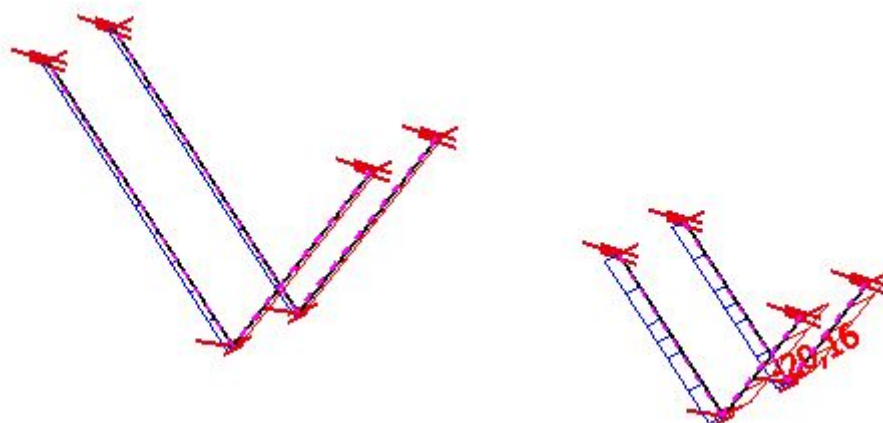

Slika 5.28. Rezne sile  $V_y$



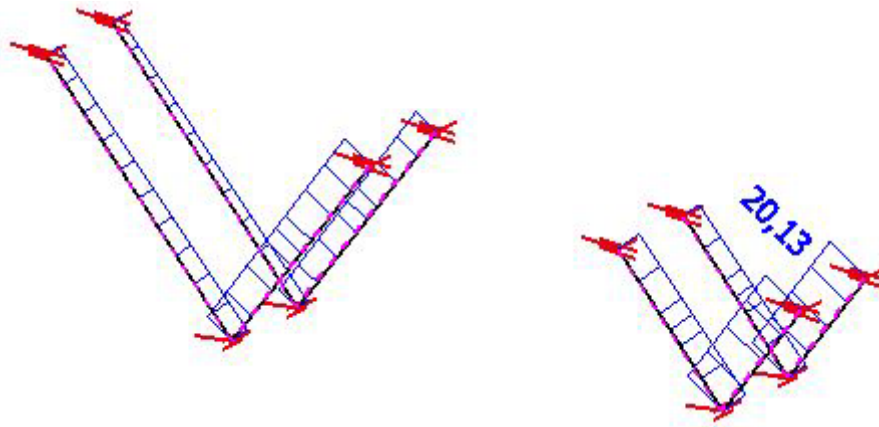

Slika 5.29. Rezne sile Vz

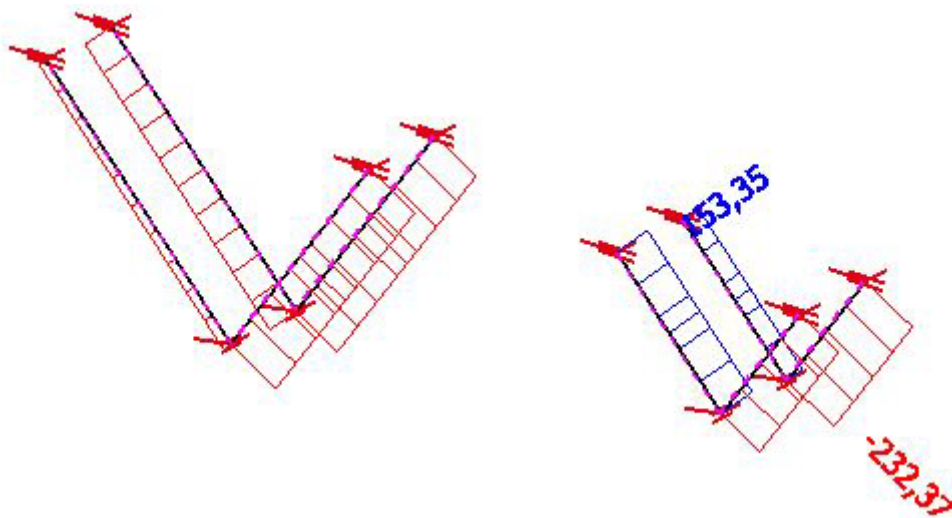

Slika 5.30. Rezne sile N

Poprečni presjek stupova rampe

Name	Stupovi rampe kata	
Type	HEB140	
Source description	Profil Arbed / Structural shapes / Edition Octobre 1995	
Item material	S 355	
Fabrication	rolled	
Flexural buckling y-y	b	
Flexural buckling z-z	c	
Lateral torsional buckling	Default	
Use 2D FEM analysis	*	
A [m <sup>2</sup> ]	4,2960 e-03	
A <sub>y, z</sub> [m <sup>2</sup> ]	3,2127 e-03	1,0456 e-03
I <sub>y, z</sub> [m <sup>4</sup> ]	1,5090 e-05	5,4970 e-06
I <sub>w</sub> [m <sup>6</sup> ], I <sub>t</sub> [m <sup>4</sup> ]	2,2479 e-08	2,0060 e-07
W <sub>el y, z</sub> [m <sup>3</sup> ]	2,1560 e-04	7,8520 e-05
W <sub>pl y, z</sub> [m <sup>3</sup> ]	2,4540 e-04	1,1980 e-04
d <sub>y, z</sub> [mm]	0	0
c <sub>YUCS, ZUCS</sub> [mm]	70	70
α [deg]	0,00	
A <sub>L, D</sub> [m <sup>2</sup> /m]	8,0500 e-01	8,0530 e-01
M <sub>ply +, -</sub> [Nm]	8,72e+04	8,72e+04
M <sub>plz +, -</sub> [Nm]	4,25e+04	4,25e+04

Slika 5.31. Prikaz geometrijskih karakteristika stupova rampe

## Dimenzioniranje

### Check of steel

Cross-sections were changed during Autodesign. The structure has to be recalculated !

Linear calculation, Extreme : Member

Selection : B548

Class : GSN

Cross-section : Stupovi rampe kata - HEB140

#### EN 1993-1-1 Code Check

National annex: Standard EN

Member B548	2,075 m	HEB140	S 355	GSN21/4	0,81 -
-------------	---------	--------	-------	---------	--------

Partial safety factors	
Gamma M0 for resistance of cross-sections	1,00
Gamma M1 for resistance to instability	1,00
Gamma M2 for resistance of net sections	1,25

Material		
Yield strength $f_y$	355,0	MPa
Ultimate strength $f_u$	490,0	MPa
Fabrication	Rolled	

....:SECTION CHECK:....

#### Classification for cross-section design

According to EN 1993-1-1 article 5.5.2

#### Classification of Internal Compression parts

According to EN 1993-1-1 Table 5.2 Sheet 1

Maximum width-to-thickness ratio	13,14
Class 1 Limit	27,95
Class 2 Limit	32,19
Class 3 Limit	51,97

=> Internal Compression parts Class 1

#### Classification of Outstand Flanges

According to EN 1993-1-1 Table 5.2 Sheet 2

Maximum width-to-thickness ratio	4,54
Class 1 Limit	7,32
Class 2 Limit	8,14
Class 3 Limit	12,06

=> Outstand Flanges Class 1

=> Section classified as Class 1 for cross-section design

The critical check is on position 2.075 m

Internal forces	Calculated	Unit
$N_{Ed}$	-232,34	kN
$V_{y,Ed}$	-17,94	kN
$V_{z,Ed}$	19,12	kN
$T_{Ed}$	-0,01	kNm
$M_{y,Ed}$	19,13	kNm
$M_{z,Ed}$	-17,34	kNm

#### Compression check

According to EN 1993-1-1 article 6.2.4 and formula (6.9)

A	4,2960e-03	m <sup>2</sup>
$N_{c,Rd}$	1525,08	kN
Unity check	0,15	-

#### Bending moment check for $M_y$

According to EN 1993-1-1 article 6.2.5 and formula (6.12),(6.13)

$W_{pl,y}$	2,4540e-04	m <sup>3</sup>
$M_{pl,y,Rd}$	87,12	kNm
Unity check	0,22	-

#### Bending moment check for $M_z$

According to EN 1993-1-1 article 6.2.5 and formula (6.12),(6.13)

$W_{pl,z}$	1,1980e-04	m <sup>3</sup>
$M_{pl,z,Rd}$	42,53	kNm
Unity check	0,41	-

#### Shear check for $V_y$

According to EN 1993-1-1 article 6.2.6 and formula (6.17)

Eta	1,20	
Av	3,4930e-03	m <sup>2</sup>
Vpl,y,Rd	715,92	kN
Unity check	0,03	-

**Shear check for Vz**

According to EN 1993-1-1 article 6.2.6 and formula (6.17)

Eta	1,20	
Av	1,3080e-03	m <sup>2</sup>
Vpl,z,Rd	268,09	kN
Unity check	0,07	-

**Torsion check**

According to EN 1993-1-1 article 6.2.7 and formula (6.23)

Tau,t,Ed	0,4	MPa
Tau,Rd	205,0	MPa
Unity check	0,00	-

**Note:** The unity check for torsion is lower than the limit value of 0,05. Therefore torsion is considered as insignificant and is ignored in the combined checks.

**Combined bending, axial force and shear force check**

According to EN 1993-1-1 article 6.2.9.1 and formula (6.41)

MN,y,Rd	82,87	kNm
Alpha	2,00	
Mpl,z,Rd	42,53	kNm
Beta	1,00	

Unity check (6.41) = 0,05 + 0,41 = 0,46 -

**Note:** Since the shear forces are less than half the plastic shear resistances their effect on the moment resistances is neglected.

**Note:** Since the axial force satisfies criteria (6.35) of EN 1993-1-1 article 6.2.9.1(4) its effect on the moment resistance about the z-z axis is neglected.

The member satisfies the section check.

**...:STABILITY CHECK:...:****Classification for member buckling design**

Decisive position for stability classification: 0,000 m

**Classification of Internal Compression parts**

According to EN 1993-1-1 Table 5.2 Sheet 1

Maximum width-to-thickness ratio	13,14
Class 1 Limit	29,57
Class 2 Limit	34,05
Class 3 Limit	53,45

=&gt; Internal Compression parts Class 1

**Classification of Outstand Flanges**

According to EN 1993-1-1 Table 5.2 Sheet 2

Maximum width-to-thickness ratio	4,54
Class 1 Limit	7,32
Class 2 Limit	8,14
Class 3 Limit	12,09

=&gt; Outstand Flanges Class 1

=&gt; Section classified as Class 1 for member buckling design

**Flexural Buckling check**

According to EN 1993-1-1 article 6.3.1.1 and formula (6.46)

Buckling parameters	yy	zz	
Sway type	sway	non-sway	
System length L	2,075	2,075	m
Buckling factor k	1,05	0,64	
Buckling length Lcr	2,174	1,336	m
Critical Euler load Ncr	6617,79	6381,28	kN
Slenderness Lambda	36,68	37,35	
Relative slenderness Lambda,rel	0,48	0,49	
Limit slenderness Lambda,rel,0	0,20	0,20	

**Note:** The slenderness or compression force is such that Flexural Buckling effects may be ignored according to EN 1993-1-1 article 6.3.1.2(4).

**Torsional(-Flexural) Buckling check**

According to EN 1993-1-1 article 6.3.1.1 and formula (6.46)

Torsional buckling length $L_{cr}$	2,075	m
Elastic critical load $N_{cr,T}$	5638,40	kN
Elastic critical load $N_{cr,TF}$	5638,40	kN
Relative slenderness $\lambda_{rel,T}$	0,52	
Limit slenderness $\lambda_{rel,0}$	0,20	
Buckling curve	c	
Imperfection $\alpha$	0,49	
Reduction factor $\chi$	0,83	
Cross-section area $A$	4,2960e-03	m <sup>2</sup>
Buckling resistance $N_b, R_d$	1268,40	kN
Unity check	0,18	-

#### Lateral Torsional Buckling check

According to EN 1993-1-1 article 6.3.2.1 & 6.3.2.2 and formula (6.54)

LTB parameters		
Method for LTB curve	General case	
Cross-section plastic modulus $W_{pl,y}$	2,4540e-04	m <sup>3</sup>
Elastic critical moment $M_{cr}$	703,36	kNm
Relative slenderness $\lambda_{rel,LT}$	0,35	
Limit slenderness $\lambda_{rel,LT,0}$	0,20	

**Note:** The slenderness or bending moment is such that Lateral Torsional Buckling effects may be ignored according to EN 1993-1-1 article 6.3.2.2(4).

Mcr parameters		
LTB length $L$	2,075	m
Influence of load position	no influence	
Correction factor $k$	1,00	
Correction factor $k_w$	1,00	
LTB moment factor $C_1$	2,63	
LTB moment factor $C_2$	0,01	
LTB moment factor $C_3$	0,00	
Shear center distance $d_z$	0	mm
Distance of load application $z_g$	0	mm
Mono-symmetry constant $\beta_{a,y}$	0	mm
Mono-symmetry constant $z_j$	0	mm

**Note:** C parameters are determined according to ECCS 119 2006 / Galea 2002.

#### Bending and axial compression check

According to EN 1993-1-1 article 6.3.3 and formula (6.61),(6.62)

Bending and axial compression check parameters		
Interaction method	alternative method 1	
Cross-section area $A$	4,2960e-03	m <sup>2</sup>
Cross-section plastic modulus $W_{pl,y}$	2,4540e-04	m <sup>3</sup>
Cross-section plastic modulus $W_{pl,z}$	1,1980e-04	m <sup>3</sup>
Design compression force $N_{Ed}$	232,34	kN
Design bending moment (maximum) $M_{y,Ed}$	-21,29	kNm
Design bending moment (maximum) $M_{z,Ed}$	19,90	kNm
Characteristic compression resistance $N_{Rk}$	1525,08	kN
Characteristic moment resistance $M_{y,Rk}$	87,12	kNm
Characteristic moment resistance $M_{z,Rk}$	42,53	kNm
Reduction factor $\chi_{i,y}$	1,00	
Reduction factor $\chi_{i,z}$	0,83	
Reduction factor $\chi_{i,LT}$	1,00	
Interaction factor $k_{yy}$	1,00	
Interaction factor $k_{yz}$	0,66	
Interaction factor $k_{zy}$	0,60	
Interaction factor $k_{zz}$	1,02	

Maximum moment  $M_{y,Ed}$  is derived from beam B548 position 0,000 m.

Maximum moment  $M_{z,Ed}$  is derived from beam B548 position 0,000 m.

Interaction method 1 parameters		
Critical Euler load $N_{cr,y}$	6617,79	kN
Critical Euler load $N_{cr,z}$	6381,28	kN
Elastic critical load $N_{cr,T}$	5638,40	kN
Cross-section plastic modulus $W_{pl,y}$	2,4540e-04	m <sup>3</sup>
Cross-section elastic modulus $W_{el,y}$	2,1560e-04	m <sup>3</sup>
Cross-section plastic modulus $W_{pl,z}$	1,1980e-04	m <sup>3</sup>
Cross-section elastic modulus $W_{el,z}$	7,8520e-05	m <sup>3</sup>



## 5.6. Spregnuta konstrukcija kata

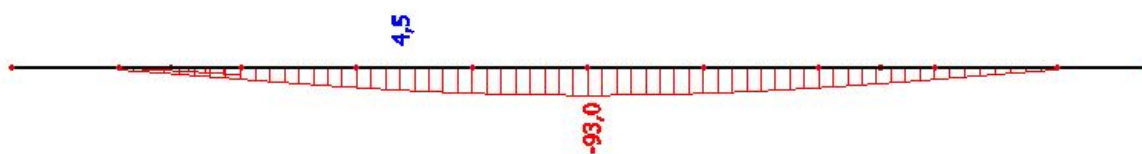

Slika 5.33. Prikaz vertikalnog pomaka grednih nosača

Dopušteni vertikalni pomak (progib):

$$u_{dop} = \frac{l}{300} = \frac{32,22}{300} = 107,4 \text{ mm}$$

$$u_z = 93,0 \text{ mm} < u_{dop} = 107,4 \text{ mm} \quad \text{-zadovoljava}$$

$$\text{-iskoristivost na GSU} - 93,0 \text{ mm} / 107,4 \text{ mm} = 0,87 = 87\%$$

Rezne sile grednih nosača

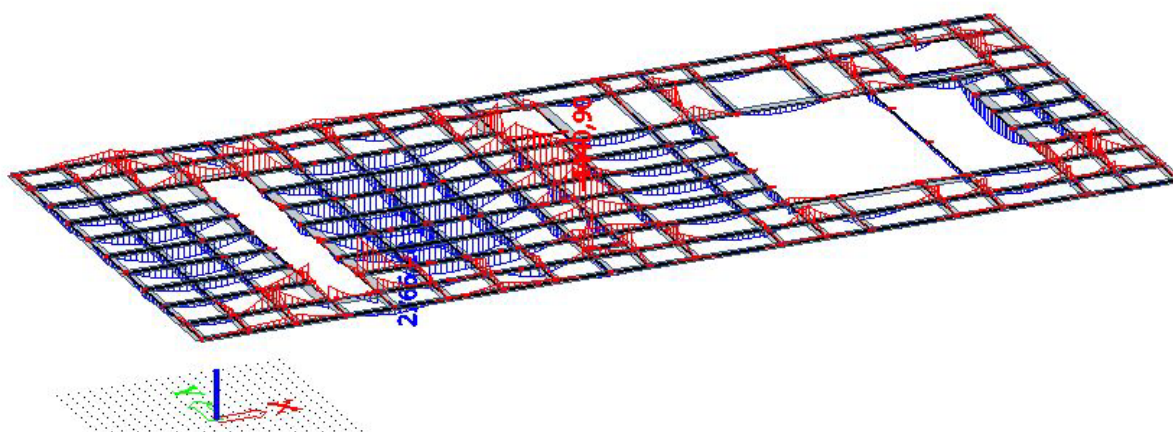

Slika 5.34. Rezne sile- My

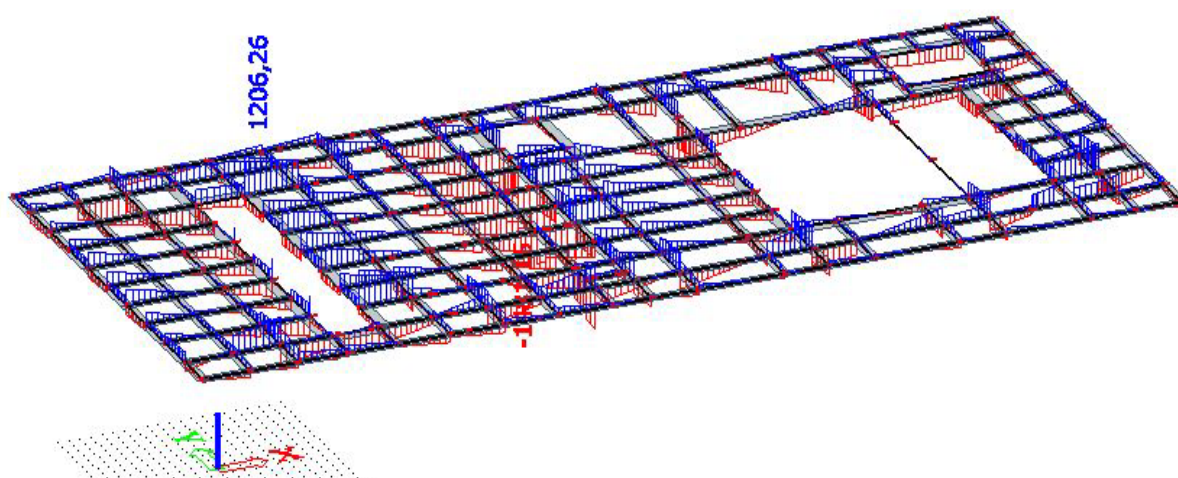

Slika 5.35. Rezne sile- Vz

Poprečni presjek grednih nosača

Name	Krov prizemlja	
Type	HL920x390	
Source description	ArcelorMittal / Sabs Programme / Version 2012-1	
Item material	S 355	
Fabrication	rolled	
Flexural buckling y-y	a	
Flexural buckling z-z	b	
Lateral torsional buckling	Default	
Use 2D FEM analysis	x	

A [m <sup>2</sup> ]	4,9430e-02	
A <sub>y, z</sub> [m <sup>4</sup> ]	2,8935e-02	2,0047 e-02
I <sub>y, z</sub> [m <sup>4</sup> ]	7,4170e-03	4,5270 e-04
I <sub>w</sub> [m <sup>6</sup> ], I <sub>t</sub> [m <sup>4</sup> ]	9,1550e-05	1,6910 e-05
W <sub>el y, z</sub> [m <sup>3</sup> ]	1,5850e-02	2,1560 e-03
W <sub>pl y, z</sub> [m <sup>3</sup> ]	1,7920e-02	3,3310 e-03
d <sub>y, z</sub> [mm]	0	0
c <sub>YUCS, ZUCS</sub> [mm]	210	468
α [deg]	0,00	
A <sub>L, D</sub> [m <sup>2</sup> /m]	3,4766e+00	3,4766e+00
M <sub>pl y, -</sub> [Nm]	6,36e+06	6,36e+06
M <sub>pl z, -</sub> [Nm]	1,18e+06	1,18e+06

Slika 5.36. Prikaz geometrijskih karakteristika grednog nosača

Dimenzioniranje

Composite Beam - Final stage

Linear calculation  
 Class: GSN  
 Extreme 1D: Global  
 Selection: B455  
 Filter: Cross-section = Krov prizemlja - HL920x390

Composite beam verification

for beam B455 at section 4.21 m, in accordance with EC EN 1994-1-1

1. Geometry data

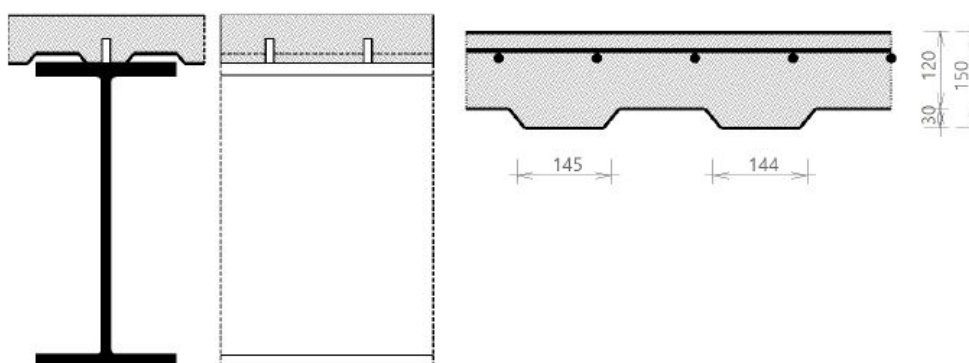

Continuous beam

Length of the current span  $L = 4.214 \text{ m}$   
 Length of next span  $L_{\text{next}} = 3.652 \text{ m}$   
 Beam spacing at the left  $L_{\text{left}} = 0 \text{ m}$   
 Beam spacing at the right  $L_{\text{right}} = 0 \text{ m}$   
 Checked section  $d_x = 4.214 \text{ m}$

Warning: For a continuous beam, intermediate buckling supports y-y are ignored in both the calculation of the effective width for the analysis model and the check.

## 2. Cross-section & materials

### 2.1 Steel section properties

#### 2.1.1 Cross-section

Cross-section	HL920x390
Height	$h_a = 936 \text{ mm}$
Width	$b = 420 \text{ mm}$
Web thickness	$t_w = 21 \text{ mm}$
Flange thickness	$t_f = 36.6 \text{ mm}$
Radius	$r = 19 \text{ mm}$
Area	$A_a = 49430 \text{ mm}^2$
Moment of inertia	$I_y = 7.42 \cdot 10^9 \text{ mm}^4$
Radius of gyration	$i_z = 96 \text{ mm}$
Plastic section modulus	$W_{pl,y} = 17.92 \cdot 10^6 \text{ mm}^3$

#### 2.1.2 Material

Steel grade	S 355
Yield strength	$f_{yb} = 355 \text{ MPa}$
Ultimate strength	$f_{ub} = 490 \text{ MPa}$
E modulus	$E_b = 210000 \text{ MPa}$

#### 2.1.3 Cross-section classification

$$\varepsilon = \sqrt{\frac{235}{355}} = 0.814$$

(EN 1993-1-1 §5.6 Tab. 5.2)

##### 2.1.3.1 Flange in compression

$$c_f = \frac{b - t_w - 2 \cdot r}{2} = \frac{420 \text{ mm} - 21.3 \text{ mm} - 2 \cdot 19 \text{ mm}}{2} = 180 \text{ mm}$$

$$\frac{c_f}{t_f} \leq 9 \cdot \varepsilon$$

$$\frac{180 \text{ mm}}{36.6 \text{ mm}} \leq 9 \cdot 0.814$$

$$4.93 \leq 7.32$$

OK

Flange classified as Class 1.

##### 2.1.3.2 Web in bending

$$c_w = h_a - 2 \cdot t_f - 2 \cdot r = 936 \text{ mm} - 2 \cdot 36.6 \text{ mm} - 2 \cdot 19 \text{ mm} = 825 \text{ mm}$$

$$\alpha_{cl} = 0.5$$

$$\frac{c_w}{t_w} \leq \frac{36 \cdot \varepsilon}{\alpha_{cl}}$$

$$\frac{825 \text{ mm}}{21.3 \text{ mm}} \leq \frac{36 \cdot 0.814}{0.5}$$

$$38.7 \leq 58.6$$

OK

Web classified as Class 1.

#### Cross-section classified as Class 1

Cross-section Class OK.

## 2.2 Concrete slab with profiled sheeting

### 2.2.1 Concrete slab

#### 2.2.1.1 Slab

Total height of the slab	$h_s = 150 \text{ mm}$
--------------------------	------------------------

#### 2.2.1.2 Material

Concrete class	C30/37
Characteristic strength	$f_{ck} = 30 \text{ MPa}$
E modulus	$E_{cm} = 32800 \text{ MPa}$



### 2.2.2 Profiled steel sheeting

Note: The angle between the member and the ribs of profiled steel sheeting is smaller than  $10^\circ$  thus the ribs are considered as parallel to the beam.

Sheeting with ribs parallel to the supporting beams

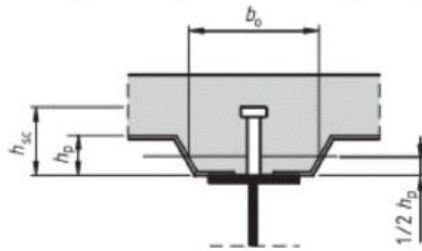

Name	ComFlor 80-0.9
Depth of the ribs	$h_{op} = 30$ mm
Height of full concrete	$h_c = 120$ mm
Height of the re-entrant stiffener	$h_d = 0$ mm
Spacing of the ribs	$b_s = 300$ mm
Top width of the rib	$b_r = 131$ mm
Bottom width of the rib	$b_b = 120$ mm
Mean width of the ribs	$b_{o,rib} = 144.5$ mm
Thickness of the sheeting	$t_p = 2$ mm

### 2.2.3 Shear connectors

#### 2.2.3.1 Geometry

Name	SHC1
Diameter	$d_s = 25$ mm
Nominal height	$h_{nom} = 80$ mm
As-welded height	$h_{sc} = 75$ mm
Amount per trough or section	$n_r = 1$

Warning: Condition given by EN 1994-1-1 Art. 6.6.5.8 (1) is not fulfilled.

#### 2.2.3.2 Material

Steel grade	S 355
Ultimate strength	$f_{us} = 490$ MPa

### 2.2.4 Reinforcement

#### 2.2.4.1 Geometry

Longitudinal bar diameter	$d_l = 16$ mm
Longitudinal bar spacing	$s_l = 150$ mm
Longitudinal bar cover	$c_l = 30$ mm
Transverse bar diameter	$d_t = 16$ mm
Transverse bar spacing	$s_t = 150$ mm
Transverse bar cover	$c_t = 46$ mm

#### 2.2.4.2 Material

Material	B 500B
Characteristic yield strength	$f_{yk,r} = 500$ MPa

## 3. Design values of loads

Load Name : GSN21

Content of combination :  $1.35 \cdot \text{vlastitateZina} + 1.35 \cdot \text{vlastitateZina\_dryconcrete} + 1.35 \cdot \text{Snijeg} + 1.35 \cdot \text{Dodatnostalno} + 1.62 \cdot \text{Pokretno} + 1.35 \cdot \text{vjetarkrovx2} + 1.35 \cdot \text{temperaturajednolika}$

Bending moment	$M_{Ed,comp} = -4464.430$ kNm
Shear force	$V_{Ed,comp} = -1238.530$ kN

## 4. Partial safety factors

Steel section	$\gamma_{M0} = 1$ $\gamma_{M1} = 1$
Shear connectors	$\gamma_V = 1.25$
Concrete	$\gamma_C = 1.5$
Reinforcement	$\gamma_S = 1.15$

## 5. ULS check of the Final stage

### 5.1 Shear connection

#### 5.1.1 Design resistance of shear connectors

##### 5.1.1.1 Shear connector in a solid slab

$$3 \leq \frac{h_{sc}}{d_s} \leq 4$$

$$3 \leq 3 \leq 4$$

$$\alpha = 0.2 \cdot \left( \frac{h_{sc}}{d_s} + 1 \right) = 0.2 \cdot \left( \frac{75 \text{ mm}}{25 \text{ mm}} + 1 \right) = 0.8$$

$$f_{us} = \min(490; 500) \text{ MPa}$$

$$P_{Rd,solid,1} = \frac{0.8 \cdot f_{us} \cdot \left( \frac{\pi \cdot d_s^2}{4} \right)}{\gamma_v} = \frac{0.8 \cdot 490 \text{ MPa} \cdot \left( \frac{3.14 \cdot 25 \text{ mm}^2}{4} \right)}{1.25} = 154 \text{ kN}$$

$$P_{Rd,solid,2} = \frac{0.29 \cdot \alpha \cdot d_s^2 \cdot \sqrt{f_{ctk} \cdot F_{cm}}}{\gamma_v} = \frac{0.29 \cdot 0.8 \cdot 25 \text{ mm}^2 \cdot \sqrt{30 \text{ MPa} \cdot 32800 \text{ MPa}}}{1.25} = 115 \text{ kN}$$

$$P_{Rd,solid} = \min(P_{Rd,solid,1}; P_{Rd,solid,2}) = \min(154 \text{ kN}; 115 \text{ kN}) = 115 \text{ kN}$$

##### 5.1.1.2 Shear connector in profiled sheeting

Sheeting with ribs parallel to the supporting beams

$$k_1 = \frac{0.6 \cdot b_{0,rib}}{h_p} \cdot \left( \frac{h_{sc}}{h_p} - 1 \right) = \frac{0.6 \cdot 145 \text{ mm}}{30 \text{ mm}} \cdot \left( \frac{75 \text{ mm}}{30 \text{ mm}} - 1 \right) = 4.34$$

$$k_1 = 1$$

$$P_{Rd} = k_1 \cdot P_{Rd,solid} = 1 \cdot 115 \text{ kN} = 115 \text{ kN}$$

#### 5.1.2 Degree of shear connection

##### 5.1.2.1 Determination of $b_{eff}$ of the concrete flange and length $L_e$

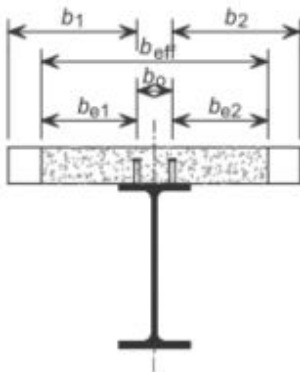

The effective width at the internal support

$$L_{e2} = 0.25 \cdot (L_1 + L_2) = 0.25 \cdot (4.21 \text{ m} + 3.65 \text{ m}) = 1.97 \text{ m}$$

##### Left side of the beam

Manual input of effective width on the side.

$$b_{eff,l} = 0.5 \text{ m}$$

##### Right side of the beam

Manual input of effective width on the side.

$$b_{eff,r} = 0.5 \text{ m}$$

**Calculation of  $b_{eff}$** 

$$b_{eff} = b_{eff,l} + b_{eff,r} = 1 \text{ m}$$

**Determination of  $L_e$** 

$$L_e = L_{e2} = 1.97 \text{ m}$$

**5.1.2.2 Minimum degree of shear connection**

Warning: Conditions given by EN 1994-1-1 Art. 6.6.1.2 (3) are not fulfilled.

Warning: Conditions given by EN 1994-1-1 Art. 6.6.1.2 (1) are not fulfilled.

$$\eta_{min,calc} = 1 - \frac{355}{f_{yb}} \cdot (0.75 - 0.03 \cdot L_e)$$

$$\eta_{min,calc} = 1 - \frac{355}{355} \cdot (0.75 - 0.03 \cdot 1.97 \text{ m}) = 0.31$$

$$\eta_{min} = \max(\eta_{min,calc}; 0.4) = \max(0.31; 0.4) = 0.4$$

**5.1.2.3 Degree of shear connection present**
**5.1.2.3.1 Tension resistance of the reinforcement**

$$A_s = \frac{b_{eff}}{s_l} \cdot \left( \frac{d_t^2}{4} \right) \cdot \pi = \frac{1 \text{ m}}{150 \text{ mm}} \cdot \left( \frac{16 \text{ mm}^2}{4} \right) \cdot 3.14 = 1340 \text{ mm}^2$$

$$F_s = \frac{A_s \cdot f_{yk,r}}{\gamma_s} = \frac{1.34 \cdot 10^{-3} \cdot 500 \cdot 10^6}{1.15} = 583 \text{ kN}$$

**5.1.2.3.2 Tension resistance of the steel member**

$$N_{pl,a} = f_{yb} \cdot A_a = 355 \text{ MPa} \cdot 49430 \text{ mm}^2 = 17547.65 \text{ kN}$$

$$N_{c,r} = \min(F_s; N_{pl,a}) = \min(583 \text{ kN}; 17547.65 \text{ kN}) = 582.79 \text{ kN}$$

**5.1.2.3.3 Resistance of the shear connectors**

$$l_s = \frac{L}{n_{row}} = \frac{4.21}{10} = 421 \text{ mm}$$

Number of shear studs available per length  $L_e/2$

$$n_{sp} = \frac{0.5 \cdot L_e}{l_s} \cdot n_r$$

$$n_{sp} = 2 \cdot 1 = 2$$

$$N_c = n_{sp} \cdot P_{Rd} = 2 \cdot 115068 = 230.14 \text{ kN}$$

$$\eta = \min\left(\frac{N_c}{N_{c,r}}; 1\right) = \min\left(\frac{230.14 \text{ kN}}{582.79 \text{ kN}}; 1\right) = 0.39$$

$$\eta \geq \eta_{min}$$

$$0.4 \geq 0.4 \quad \text{NOT OK}$$

Warning: The shear connection degree is not adequate.

**5.2 Cross-sectional resistance of the composite beam**
**5.2.1 Shear buckling**

$$h_w = h_a - 2 \cdot t_f = 936 \text{ mm} - 2 \cdot 36.6 \text{ mm} = 863 \text{ mm}$$

$$\eta_{sb} = 1.2$$

$$\frac{h_w}{t_w} \leq \frac{72 \cdot \epsilon}{\eta_{sb}}$$

$$\frac{863 \text{ mm}}{21.3 \text{ mm}} \leq \frac{72 \cdot 0.814}{1.2}$$

$$40.5 \leq 48.8$$

OK

The shear buckling resistance of the web does not need to be verified.

### 5.2.2 Vertical shear

The resistance to vertical shear should be taken as the resistance of the structural steel section.

$$A_v = A_a - 2 \cdot b \cdot t_f + (t_w + 2 \cdot r) \cdot t_f = 0.0494 - 2 \cdot 0.42 \cdot 0.0366 + (0.0213 + 2 \cdot 0.019) \cdot 0.0366 = 20856 \text{ mm}^2$$

$$A_{v,\min} = \eta_{sb} \cdot h_w \cdot t_w = 1.2 \cdot 0.863 \cdot 0.0213 = 22053 \text{ mm}^2$$

$$A_v \geq A_{v,\min}$$

$$20856 \text{ mm}^2 < 22053 \text{ mm}^2$$

$$A_v = A_{v,\min} = 22053 \text{ mm}^2 = 22053 \text{ mm}^2$$

$$V_{pl,Rd} = \frac{A_v \cdot f_{yb}}{\sqrt{3} \cdot \gamma_{Mo}} = \frac{22053 \text{ mm}^2 \cdot 355 \cdot 10^6}{\sqrt{3} \cdot 1} = 4520 \text{ kN}$$

$$UC_{\text{comp}_V} = \frac{\text{abs}(V_{Ed,\text{comp}})}{V_{pl,Rd}} = \frac{\text{abs}(-1238.530 \text{ kN})}{4520 \text{ kN}} = 0.27$$

The shear resistance of the section is adequate.

### 5.2.3 Bending moment

#### 5.2.3.1 Longitudinal reinforcement

##### 5.2.3.1.1 Centre of composite section

For buildings not intended mainly for storage the effects of creep in concrete beams may be taken into account by using an effective E modulus  $E_{\text{ceff}} = E_{\text{cm}}/2$ .

$$E_{\text{ceff}} = \frac{E_{\text{cm}}}{2} = \frac{32800 \text{ MPa}}{2} = 16400 \text{ MPa}$$

$$n_E = \frac{E_b}{E_{\text{ceff}}} = \frac{210000 \text{ MPa}}{16400 \text{ MPa}} = 12.8$$

$$y_{it} = \frac{A_a \cdot \left(\frac{h_a}{2}\right) + \left(\frac{1}{n_E}\right) \cdot b_{\text{eff}} \cdot (h_c - h_d) \cdot \left(h_a + h_s - \frac{h_c - h_d}{2}\right)}{A_a + \left(\frac{1}{n_E}\right) \cdot b_{\text{eff}} \cdot (h_c - h_d)}$$

$$= \frac{0.0494 \cdot \left(\frac{0.936}{2}\right) + \left(\frac{1}{12.8}\right) \cdot 1 \cdot (0.12 - 0) \cdot \left(0.936 + 0.15 - \frac{0.12 - 0}{2}\right)}{0.0494 + \left(\frac{1}{12.8}\right) \cdot 1 \cdot (0.12 - 0)} = 557 \text{ mm}$$

##### 5.2.3.1.2 Degree of reinforcement

$$A_s = \frac{b_{\text{eff}}}{s_t} \cdot \left(\frac{d_t^2}{4}\right) \cdot \pi = \frac{1 \text{ m}}{150 \text{ mm}} \cdot \left(\frac{16 \text{ mm}^2}{4}\right) \cdot 3.14 = 1340 \text{ mm}^2$$

$$A_c = b_{\text{eff}} \cdot (h_c - h_d) = 1 \cdot (0.12 - 0) = 120000 \text{ mm}^2$$

$$z_0 = \left(h_a + h_s - \frac{h_c - h_d}{2}\right) - y_d = \left(0.936 + 0.15 - \frac{0.12 - 0}{2}\right) - 0.557 = 469 \text{ mm}$$

$$k_c = \min\left(\frac{1}{\left(1 + \frac{h_c - h_d}{2 \cdot z_0}\right)} + 0.3; 1\right) = \min\left(\frac{1}{\left(1 + \frac{0.12 - 0}{2 \cdot 0.469}\right)} + 0.3; 1\right) = 1$$

$$\rho_s = \delta \cdot \left(\frac{f_{yb}}{235}\right) \cdot \left(\frac{f_{ctm}}{f_{yk,r}}\right) \cdot \sqrt{k_c} = 1.1 \cdot \left(\frac{355}{235}\right) \cdot \left(\frac{2.9 \cdot 10^6}{500 \cdot 10^6}\right) \cdot \sqrt{1} = 0.964 \%$$

$$A_s \geq \rho_s \cdot A_c$$

$$1340 \text{ mm}^2 \geq 9.64 \cdot 10^{-3} \cdot 120000 \text{ mm}^2$$

$$1340 \text{ mm}^2 \geq 1157 \text{ mm}^2 \quad \text{OK}$$

The longitudinal reinforcement of the section is adequate.

**5.2.3.2 Moment resistance****Moment resistance of a steel cross-section**

$$M_{pl,Rd,a} = \frac{W_{pl,y} \cdot f_{yb}}{\gamma_{M0}} = \frac{17,9 \cdot 10^3 \text{ mm}^3 \cdot 355 \text{ MPa}}{1} = 6362 \text{ kNm}$$

**Influence of shear**

$$\frac{V_{pl,Rd}}{2} > \text{abs}(V_{Ed,comp})$$

$$\frac{4520 \text{ kN}}{2} > 1239 \text{ kN}$$

$$2260 \text{ kN} > 1239 \text{ kN} \quad \text{OK}$$

The influence of the vertical shear on the bending moment resistance may be neglected.

$$f_{yb,w} = f_{yb} = 355 \text{ MPa}$$

**Modified tension resistance of the steel member**

$$r = 0 \text{ mm}$$

$$A_n = 2 \cdot t_f \cdot b + t_w \cdot (h_a - 2 \cdot t_f) = 2 \cdot 36,6 \text{ mm} \cdot 420 \text{ mm} + 21,3 \text{ mm} \cdot (936 \text{ mm} - 2 \cdot 36,6 \text{ mm}) = 49122 \text{ mm}^2$$

$$N_{pl,a} = A_n \cdot f_{yb} = 49122 \text{ mm}^2 \cdot 355 \text{ MPa} = 17438,18 \text{ kN}$$

Note: Roundings of the steel cross-section are neglected in bending resistance calculation.

$$N_{c,t} = \min(F_s; N_{pl,a}) = \min(583 \text{ kN}; 17438,18 \text{ kN}) = 582,79 \text{ kN}$$

**Negative bending moment resistance calculation**

Warning: Full degree of shear connection is required according to EN 1994-1-1, Art. 6.2.1.3 (2).

The plastic neutral axis is located within the web of the steel section.

$$N_{at,t} = b \cdot t_f \cdot f_{yb} = 0,42 \cdot 0,0366 \cdot 355 \cdot 10^6 = 5457,06 \text{ kN}$$

$$N_{pl,a} - N_{at,t} - N_{at,w} = F_s + N_{at,t} + N_{at,w}$$

$$x = \frac{(N_{pl,a} - 2 \cdot N_{at,t} - F_s)}{(2 \cdot t_w \cdot f_{yb,w})} = \frac{(17438,18 \text{ kN} - 2 \cdot 5457,06 \text{ kN} - 583 \text{ kN})}{(2 \cdot 21,3 \text{ mm} \cdot 355 \text{ MPa})} = 393 \text{ mm}$$

Verification of the steel web classification.

$$\alpha_{cl} = \frac{c_w - x}{c_w} = \frac{825 - 393}{825} = 0,524$$

$$\frac{c_w}{t_w} \leq \frac{396 \cdot \varepsilon}{13 \cdot \alpha_{cl} - 1}$$

$$\frac{825 \text{ mm}}{21,3 \text{ mm}} \leq \frac{396 \cdot 0,814}{13 \cdot 0,524 - 1}$$

$$38,7 \leq 55,5 \quad \text{OK}$$

Web classified as Class 1.

$$N_{at,w} = t_w \cdot x \cdot f_{yb,w} = 21,3 \text{ mm} \cdot 393 \text{ mm} \cdot 355 \text{ MPa} = 2970,64 \text{ kN}$$

$$N_{a,c} = N_{pl,a} - N_{at,t} - N_{at,w} = 17438,18 \text{ kN} - 5457,06 \text{ kN} - 2970,64 \text{ kN} = 9010,49 \text{ kN}$$

Leverage arm of the compression part of the steel section calculated to the PNA.

$$h_{cs} = \frac{(t_w \cdot (h_a - 2 \cdot t_f - x)^2 \cdot 0,5 + t_f \cdot b \cdot (h_a - 1,5 \cdot t_f - x))}{t_w \cdot (h_a - 2 \cdot t_f - x) + t_f \cdot b}$$

$$= \frac{(21,3 \cdot (936 - 2 \cdot 36,6 - 393)^2 \cdot 0,5 + 36,6 \cdot 420 \cdot (936 - 1,5 \cdot 36,6 - 393))}{21,3 \cdot (936 - 2 \cdot 36,6 - 393) + 36,6 \cdot 420} = 388 \text{ mm}$$

$$h_1 = x + t_f + h_s - c_1 + \frac{d_1}{2} = 0,393 + 0,0366 + 0,15 - 0,03 + \frac{0,016}{2} = 541 \text{ mm}$$

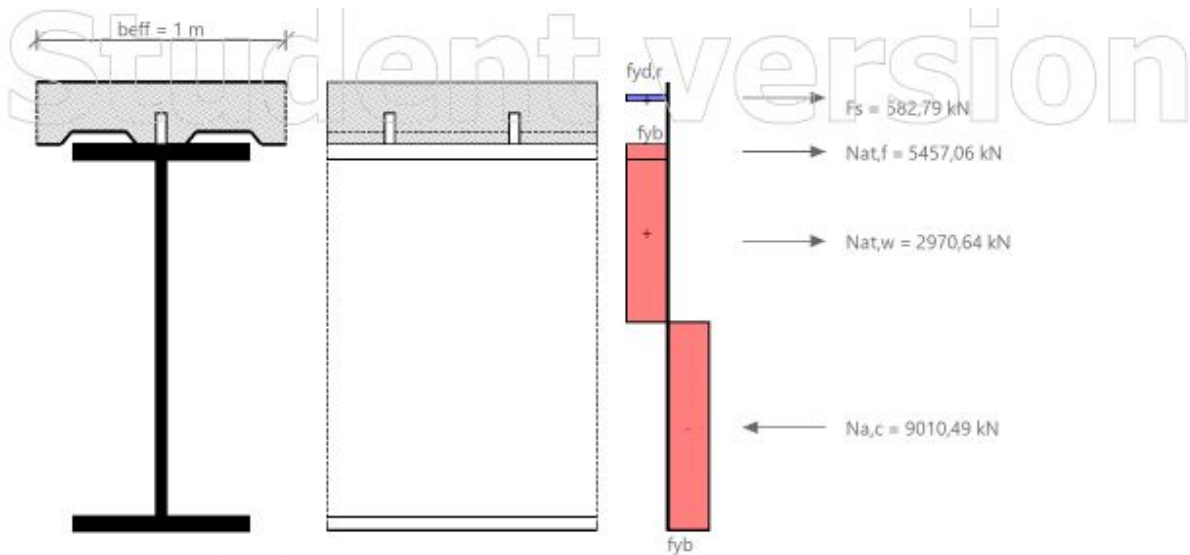

$$M_{pl,Rd} = F_s \cdot h_1 + N_{at,r} \cdot \left( \frac{t_f}{2} + x \right) + \frac{N_{at,w} \cdot x}{2} + N_{a,c} \cdot h_{cs}$$

$$= 583 \cdot 541 + 5457,06 \cdot \left( \frac{36,6}{2} + 393 \right) + \frac{2970,64 \cdot 393}{2} + 9010,49 \cdot 388 = 6642 \text{ kNm}$$

**Design moment resistance according to simplified method given by EN 1994-1-1 Art.6.2.1.3 (5)**

$$M_{Rd} = M_{pl,Rd,a} + (M_{pl,Rd} - M_{pl,Rd,a}) \cdot \eta = 6362 \text{ kNm} + (6642 \text{ kNm} - 6362 \text{ kNm}) \cdot 0,39 = 6472 \text{ kNm}$$

$$UC_{comp\_M} = \frac{abs(M_{Ed,comp})}{M_{Rd}} = \frac{abs(-4464,430 \text{ kNm})}{6472 \text{ kNm}} = 0,69$$

The bending moment resistance of the section is adequate.

**5.3 LTB resistance**

$$F = \left( 1 + \frac{t_w \cdot (h_a - t_f)}{4 \cdot b \cdot t_f} \right) \cdot \left( \frac{h_a - t_f}{t_w} \right)^{0.75} \cdot \left( \frac{t_f}{b} \right)^{0.25} = \left( 1 + \frac{21.3 \cdot (936 - 36.6)}{4 \cdot 420 \cdot 36.6} \right) \cdot \left( \frac{936 - 36.6}{21.3} \right)^{0.75} \cdot \left( \frac{36.6}{420} \right)^{0.25} = 11.8$$

$$F_{lim} = 12.3$$

$$F \leq F_{lim}$$

$$11.8 \leq 12.3$$

OK

The cross-section is qualified for verification of LTB by the simplified method.

$$C_4 = 25$$

$$\lambda_{LT,rel} = 5 \cdot \left( 1 + \frac{t_w \cdot (h_a - t_f)}{4 \cdot b \cdot t_f} \right) \cdot \left( \frac{h_a - t_f}{t_w} \right)^{0.75} \cdot \left( \frac{t_f}{b} \right)^{0.25} \cdot \left( \frac{f_{yb}}{E_b \cdot C_4} \right)^{0.5}$$

$$= 5 \cdot \left( 1 + \frac{0.0213 \cdot (0.936 - 0.0366)}{4 \cdot 0.42 \cdot 0.0366} \right) \cdot \left( \frac{0.936 - 0.0366}{0.0213} \right)^{0.75} \cdot \left( \frac{0.0366}{0.42} \right)^{0.25} \cdot \left( \frac{355 \cdot 10^6}{210 \cdot 10^9 \cdot 25} \right)^{0.5} = 0.485$$

$h_a/b > 2$  -> Buckling curve 'b'

$$\alpha_{LT} = 0.34$$

$$\Phi_{LT} = 0.5 \cdot \left( 1 + \alpha_{LT} \cdot (\lambda_{LT,rel} - 0.2) + \lambda_{LT,rel}^2 \right) = 0.5 \cdot \left( 1 + 0.34 \cdot (0.485 - 0.2) + 0.485^2 \right) = 0.666$$

$$X_{LT} = \frac{1}{\Phi_{LT} + \sqrt{\Phi_{LT}^2 - \lambda_{LT,rel}^2}} = \frac{1}{0.666 + \sqrt{0.666^2 - 0.485^2}} = 0.891$$

$$X_{LT} = \min(X_{LT}; 1) = \min(0.891; 1) = 0.891$$

$$M_{b,Rd} = X_{LT} \cdot M_{Rd} = 0.891 \cdot 6.47 \cdot 10^6 = 5764.677 \text{ kNm}$$

$$UC_{comp\_LTB} = \frac{\text{abs}(M_{Ed,comp})}{M_{b,Rd}} = \frac{\text{abs}(-4464.430 \text{ kNm})}{5764.677 \text{ kNm}} = 0.77$$

The later torsional buckling resistance of the section is adequate.

**5.4 Longitudinal shear**
**5.4.1 Transverse reinforcement**

Design shear flow

$$h_f = h_c = 120 \text{ mm}$$

$$v_{Ed} = \frac{n_r \cdot P_{Rd}}{l_s \cdot h_f} = \frac{1 \cdot 115 \text{ kN}}{421 \text{ mm} \cdot 120 \text{ mm}} = 2.28 \text{ MPa}$$

Transverse reinforcement

$$\frac{A_{st} \cdot f_{yk,r}}{\gamma_s \cdot s_f} \geq \frac{v_{Ed} \cdot h_f}{\cotg(\theta)}$$

$$A_t = A_{st}/s_f$$

$$A_t = \frac{v_{Ed} \cdot h_f}{\left( \frac{\cotg(\theta) \cdot f_{yk,r}}{\gamma_s} \right)} = \frac{2.28 \cdot 10^6 \cdot 0.12}{\left( \frac{\cotg(26.5) \cdot 500 \cdot 10^6}{1.15} \right)} = 313 \text{ mm}^2/\text{m}$$

$$A_{t,prov} = \frac{1}{s_f} \cdot \left( \frac{d_t^2}{4} \right) \cdot 3.14 = \frac{1}{0.15} \cdot \left( \frac{0.016^2}{4} \right) \cdot 3.14 = 1340 \text{ mm}^2/\text{m}$$

$$A_{t,prov} \geq A_t$$

$$1340 \text{ mm}^2/\text{m} \geq 313 \text{ mm}^2/\text{m} \quad \text{OK}$$

The transverse reinforcement of the section is adequate.

**ULS check of Final stage is NOT OK.**

$$UC_{comp} = \max(0.27; 0.69; 0.77) = 0.77$$

Iskoristivost elemenata za GSN – 77%

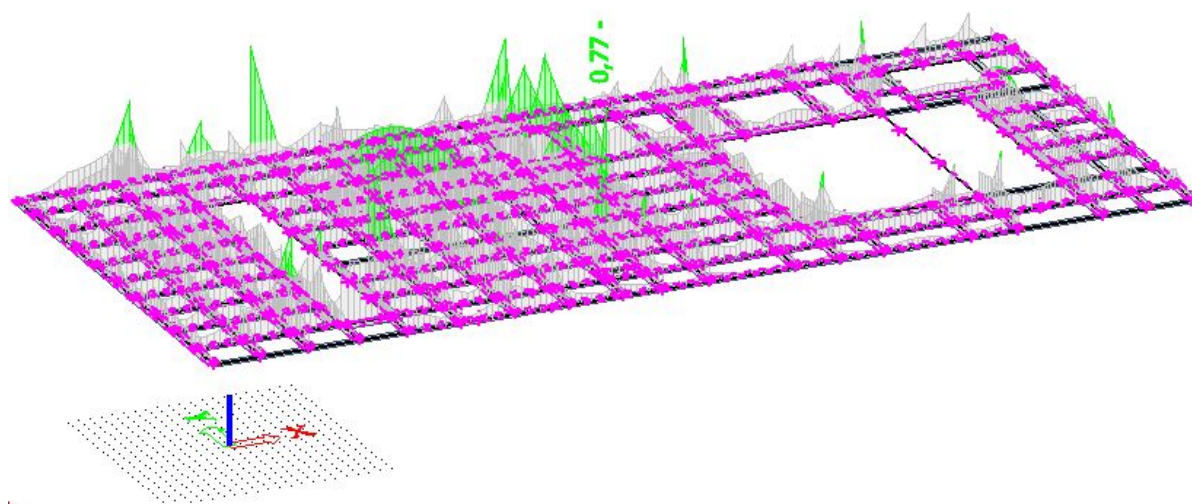

*Slika 5.37. Prikaz iskoristivosti grednih nosača*



### 5.7. Spregnuta rampa (prizemlje-kat)

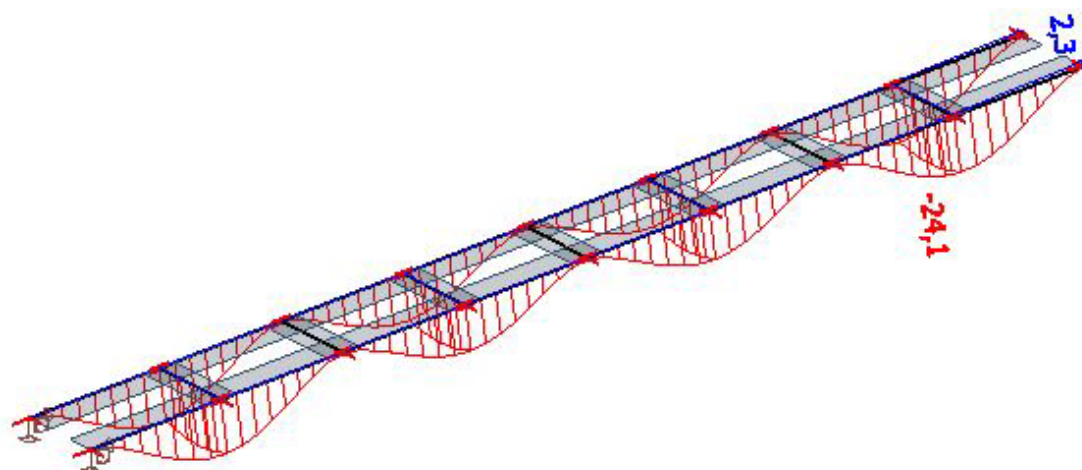

*Slika 5.38. Prikaz vertikalnog pomaka grednih nosača rampe*

Dopušteni vertikalni pomak (progib):

$$u_{dop} = \frac{l}{300} = \frac{8,26}{300} = 27,5 \text{ mm}$$

$$u_z = 24,1 \text{ mm} < u_{dop} = 27,5 \text{ mm} \quad \text{-zadovoljava}$$

$$\text{-iskoristivost na GSU} - 24,1 \text{ mm} / 27,5 \text{ mm} = 0,88 = 88\%$$

Rezne sile grednih nosača rampe

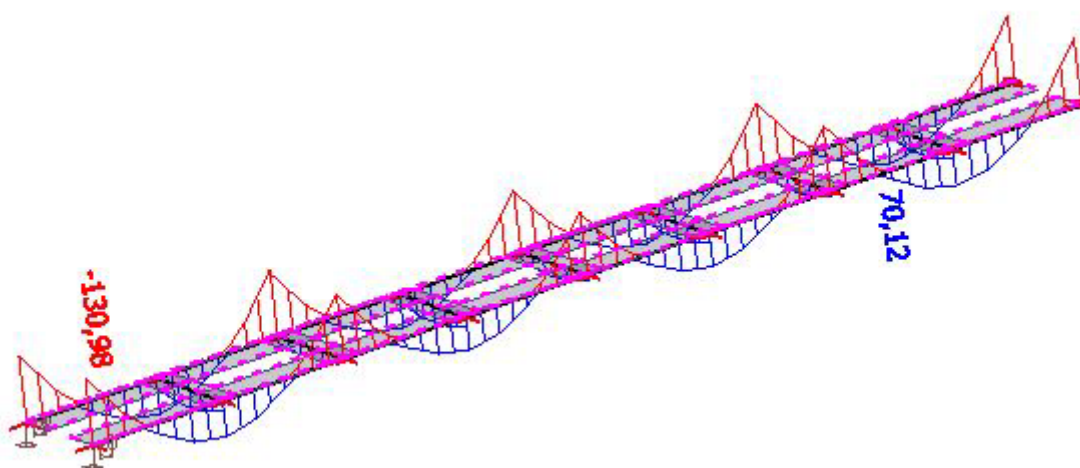

*Slika 5.39. Rezne sile -My*

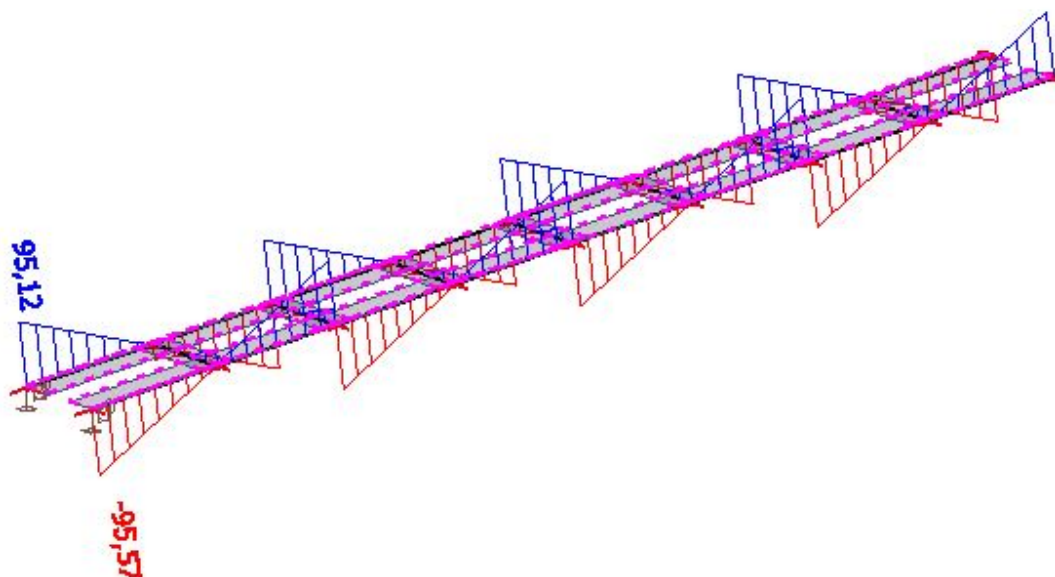

Slika 5.39. Rezne sile -Vz

### Poprečni presjek grednih nosača rampe

Name	Rampa nosači prizemlja	
Type	HEB180	
Source description	Profil Arbed / Structural shapes / Edition Octobre 1995	
Item material	S 355	
Fabrication	rolled	
Flexural buckling y-y	b	
Flexural buckling z-z	c	
Lateral torsional buckling	Default	
Use 2D FEM analysis	x	
A [m <sup>2</sup> ]	6,5250e-03	
A <sub>y, z</sub> [m <sup>2</sup> ]	4,8159e-03	1,6236e-03
I <sub>y, z</sub> [m <sup>4</sup> ]	3,8310e-05	1,3630e-05
I <sub>w</sub> [m <sup>6</sup> ], I <sub>t</sub> [m <sup>4</sup> ]	9,3746e-08	4,2160e-07
W <sub>el y, z</sub> [m <sup>3</sup> ]	4,2570e-04	1,5140e-04
W <sub>pl y, z</sub> [m <sup>3</sup> ]	4,8140e-04	2,3100e-04
d <sub>y, z</sub> [mm]	0	0
c <sub>YUCS, ZUCS</sub> [mm]	90	90
α [deg]	0,00	
A <sub>L, D</sub> [m <sup>2</sup> /m]	1,0400e+00	1,0371e+00
M <sub>ply +, -</sub> [Nm]	1,71e+05	1,71e+05
M <sub>plz +, -</sub> [Nm]	8,20e+04	8,20e+04

Slika 5.40. Prikaz geometrijskih karakteristika grednih nosača rampe

Dimenzioniranje**Composite Beam - Final stage**

Linear calculation  
 Class: GSN  
 Extreme 1D: Global  
 Selection: B503  
 Filter: Cross-section = Rampa nosači prizemlja - HEB180

**Composite beam verification**

for beam B503 at section 0 m, in accordance with EC EN 1994-1-1

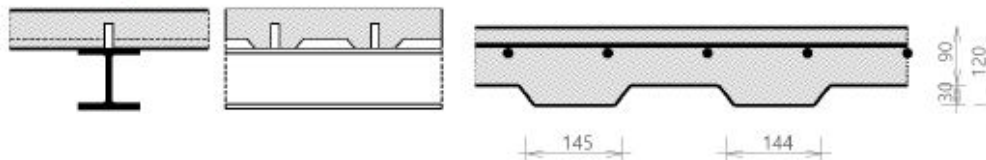
**1. Geometry data****Simply supported beam**

Length of the current span	$L = 32.54$ m
Distance to the slab edge at the left	$L_{\text{left}} = 3$ m
Distance to the slab edge at the right	$L_{\text{right}} = 3.55 \cdot 10^{-15}$ m
Checked section	$d_x = 0$ m

*Warning: For a continuous beam, intermediate buckling supports y-y are ignored in both the calculation of the effective width for the analysis model and the check.*

**2. Cross-section & materials****2.1 Steel section properties****2.1.1 Cross-section**

Cross-section	HEB180
Height	$h_a = 180$ mm
Width	$b = 180$ mm
Web thickness	$t_w = 8.5$ mm
Flange thickness	$t_f = 14$ mm
Radius	$r = 15$ mm
Area	$A_a = 6525$ mm <sup>2</sup>
Moment of inertia	$I_y = 38.3 \cdot 10^6$ mm <sup>4</sup>
Radius of gyration	$i_z = 46$ mm
Plastic section modulus	$W_{pl,y} = 481400$ mm <sup>3</sup>

**2.1.2 Material**

Steel grade	S 355
Yield strength	$f_{yb} = 355$ MPa
Ultimate strength	$f_{ub} = 490$ MPa
E modulus	$E_b = 210000$ MPa

Student version

**2.1.3 Cross-section classification**

$$\varepsilon = \sqrt{\frac{235}{355}} = 0.814$$

(EN 1993-1-1 §5.6 Tab. 5.2)

**2.1.3.1 Flange in compression**

$$c_f = \frac{b - t_w - 2 \cdot r}{2} = \frac{180 \text{ mm} - 8.5 \text{ mm} - 2 \cdot 15 \text{ mm}}{2} = 70.8 \text{ mm}$$

$$\frac{c_f}{t_f} \leq 9 \cdot \varepsilon$$

$$\frac{70.8 \text{ mm}}{14 \text{ mm}} \leq 9 \cdot 0.814$$

$$5.05 \leq 7.32 \quad \text{OK}$$

Flange classified as Class 1.

**2.1.3.2 Web in bending**

$$c_w = h_a - 2 \cdot t_f - 2 \cdot r = 180 \text{ mm} - 2 \cdot 14 \text{ mm} - 2 \cdot 15 \text{ mm} = 122 \text{ mm}$$

$$\alpha_{cl} = 0.5$$

$$\frac{c_w}{t_w} \leq \frac{36 \cdot \varepsilon}{\alpha_{cl}}$$

$$\frac{122 \text{ mm}}{8.5 \text{ mm}} \leq \frac{36 \cdot 0.814}{0.5}$$

$$14.4 \leq 58.6 \quad \text{OK}$$

Web classified as Class 1.

**Cross-section classified as Class 1**

Cross-section Class OK.

**2.2 Concrete slab with profiled sheeting****2.2.1 Concrete slab****2.2.1.1 Slab**Total height of the slab  $h_s = 120 \text{ mm}$ **2.2.1.2 Material**

Concrete class	C30/37
Characteristic strength	$f_{ck} = 30 \text{ MPa}$
E modulus	$E_{cm} = 32800 \text{ MPa}$

**2.2.2 Profiled steel sheeting**

Sheeting with ribs transverse to the supporting beams

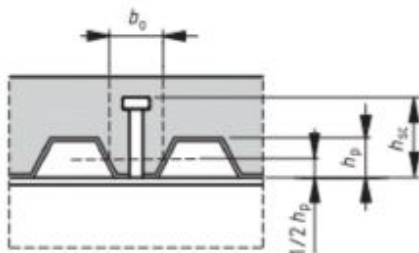

Student version

Name	ComFlor 80-0.9
Depth of the ribs	$h_p = 30$ mm
Height of full concrete	$h_c = 90$ mm
Height of the re-entrant stiffener	$h_d = 0$ mm
Spacing of the ribs	$b_s = 300$ mm
Top width of the rib	$b_r = 131$ mm
Bottom width of the rib	$b_b = 120$ mm
Mean width of the ribs	$b_{0,rib} = 144.5$ mm
Thickness of the sheeting	$t_p = 2$ mm

### 2.2.3 Shear connectors

#### 2.2.3.1 Geometry

Name	SHC1
Diameter	$d_s = 25$ mm
Nominal height	$h_{nom} = 80$ mm
As-welded height	$h_{sc} = 75$ mm
Amount per trough or section	$n_r = 1$

Warning: Condition given by EN 1994-1-1 Art. 6.6.5.8 (1) is not fulfilled.

#### 2.2.3.2 Material

Steel grade	S 355
Ultimate strength	$f_{us} = 490$ MPa

### 2.2.4 Reinforcement

#### 2.2.4.1 Geometry

Longitudinal bar diameter	$d_l = 16$ mm
Longitudinal bar spacing	$s_l = 150$ mm
Longitudinal bar cover	$c_l = 30$ mm
Transverse bar diameter	$d_t = 16$ mm
Transverse bar spacing	$s_t = 150$ mm
Transverse bar cover	$c_t = 46$ mm

#### 2.2.4.2 Material

Material	B 500B
Characteristic yield strength	$f_{ykr} = 500$ MPa

### 3. Design values of loads

Load Name : GSN1

Content of combination : 1.35\*vlastitatežina+1.35\*vlastitatežina\_dryconcrete+1.35\*Dodatnostalno+  
1.80\*Pokretno

Bending moment	$M_{Ed,comp} = -130.167$ kNm
Shear force	$V_{Ed,comp} = 95.099$ kN

### 4. Partial safety factors

Steel section	$\gamma_{M0} = 1$
	$\gamma_{M1} = 1$
Shear connectors	$\gamma_V = 1.25$
Concrete	$\gamma_C = 1.5$
Reinforcement	$\gamma_S = 1.15$

## 5. ULS check of the Final stage

### 5.1 Shear connection

#### 5.1.1 Design resistance of shear connectors

##### 5.1.1.1 Shear connector in a solid slab

$$3 \leq \frac{h_{sc}}{d_s} \leq 4$$

$$3 \leq 3 \leq 4$$

$$\alpha = 0.2 \cdot \left( \frac{h_{sc}}{d_s} + 1 \right) = 0.2 \cdot \left( \frac{75 \text{ mm}}{25 \text{ mm}} + 1 \right) = 0.8$$

$$f_{us} = \min(490; 450) \text{ MPa}$$

$$f_{us} = 450 \text{ MPa}$$

$$P_{Rd,solid,1} = \frac{0.8 \cdot f_{us} \cdot \left( \frac{\pi \cdot d_s^2}{4} \right)}{\gamma_v} = \frac{0.8 \cdot 450 \text{ MPa} \cdot \left( \frac{3.14 \cdot 25 \text{ mm}^2}{4} \right)}{1.25} = 141 \text{ kN}$$

$$P_{Rd,solid,2} = \frac{0.29 \cdot \alpha \cdot d_s^2 \cdot \sqrt{f_{ck} \cdot E_{cm}}}{\gamma_v} = \frac{0.29 \cdot 0.8 \cdot 25 \text{ mm}^2 \cdot \sqrt{30 \text{ MPa} \cdot 32800 \text{ MPa}}}{1.25} = 115 \text{ kN}$$

$$P_{Rd,solid} = \min(P_{Rd,solid,1}; P_{Rd,solid,2}) = \min(141 \text{ kN}; 115 \text{ kN}) = 115 \text{ kN}$$

##### 5.1.1.2 Shear connector in profiled sheeting

Sheeting with ribs transverse to the supporting beams

$$k_t = \frac{0.7}{\sqrt{b_r}} \cdot \left( \frac{b_{0,rib}}{h_p} \right) \cdot \left( \frac{h_{sc}}{h_p} - 1 \right) = \frac{0.7}{\sqrt{1}} \cdot \left( \frac{145 \text{ mm}}{30 \text{ mm}} \right) \cdot \left( \frac{75 \text{ mm}}{30 \text{ mm}} - 1 \right) = 5.06$$

$$k_{t,max} = 0.75$$

$$k_t = \max(0; \min(k_t; k_{t,max})) = \max(0; \min(5.06; 0.75)) = 0.75$$

$$P_{Rd} = k_t \cdot P_{Rd,solid} = 0.75 \cdot 115 \text{ kN} = 86.3 \text{ kN}$$

Warning: The conditions given by EN 1994-1-1 Art.6.6.4.2 (3) are not fulfilled.

#### 5.1.2 Degree of shear connection

##### 5.1.2.1 Determination of $b_{eff}$ of the concrete flange and length $L_e$

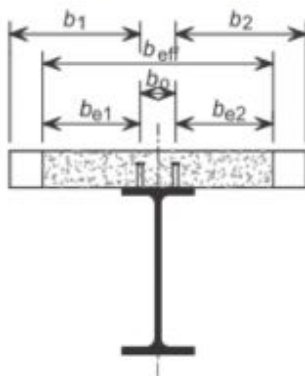

The effective width at the end support

$$L_{e0} = L_1 = 32.5 \text{ m}$$

Left side of the beam

Manual input of effective width on the side.

$$b_{eff,1} = 1 \text{ m}$$

**Right side of the beam**

Manual input of effective width on the side.

$$b_{\text{eff},r} = 0 \text{ m}$$

**Calculation of  $b_{\text{eff}}$** 

$$b_{\text{eff}} = b_{\text{eff},l} + b_{\text{eff},r} = 1 \text{ m}$$

**Determination of  $L_e$** 

$$L_e = L_{e0} = 32.5 \text{ m}$$

**5.1.2.2 Minimum degree of shear connection**

$$\eta_{\text{min}} = 1 = 1$$

**5.1.2.3 Degree of shear connection present****5.1.2.3.1 Tension resistance of the reinforcement**

$$A_s = \frac{b_{\text{eff}}}{s_l} \cdot \left( \frac{d_l^2}{4} \right) \cdot \pi = \frac{1 \text{ m}}{150 \text{ mm}} \cdot \left( \frac{16 \text{ mm}^2}{4} \right) \cdot 3.14 = 1340 \text{ mm}^2$$

$$F_s = \frac{A_s \cdot f_{yk,r}}{\gamma_s} = \frac{1.34 \cdot 10^{-3} \cdot 500 \cdot 10^6}{1.15} = 583 \text{ kN}$$

**5.1.2.3.2 Tension resistance of the steel member**

$$N_{pl,a} = f_{yb} \cdot A_a = 355 \text{ MPa} \cdot 6525 \text{ mm}^2 = 2316.38 \text{ kN}$$

$$N_{c,r} = \min(F_s, N_{pl,a}) = \min(583 \text{ kN}; 2316.38 \text{ kN}) = 582.79 \text{ kN}$$

**5.1.2.3.3 Resistance of the shear connectors**Number of full ribs available per length  $L_e$ 

$$n_{\text{rib}} = \frac{L_e}{b_s} = \frac{32.5 \text{ m}}{300 \text{ mm}}$$

$$n_{\text{rib}} = 108$$

$$l_s = b_s \cdot \text{trough} = 300 \text{ mm} \cdot 1 = 300 \text{ mm}$$

Number of shear studs available per length  $L_e/2$ 

$$n_{\text{sp}} = \frac{0.5 \cdot n_{\text{rib}} \cdot n_r}{\text{trough}} = \frac{0.5 \cdot 108 \cdot 1}{1} = 54$$

$$N_c = n_{\text{sp}} \cdot P_{Rd} = 54 \cdot 86301 = 4660.26 \text{ kN}$$

$$\eta = \min\left(\frac{N_c}{N_{c,r}}, 1\right) = \min\left(\frac{4660.26 \text{ kN}}{582.79 \text{ kN}}; 1\right) = 1$$

$$\eta \geq \eta_{\text{min}}$$

$$1 \geq 1$$

NOT OK

Warning: The shear connection degree is not adequate.

**5.2 Cross-sectional resistance of the composite beam****5.2.1 Shear buckling**

$$h_w = h_a - 2 \cdot t_f = 180 \text{ mm} - 2 \cdot 14 \text{ mm} = 152 \text{ mm}$$

$$\eta_{\text{sb}} = 1.2$$

$$\frac{h_w}{t_w} \leq \frac{72 \cdot \epsilon}{\eta_{\text{sb}}}$$

$$\frac{152 \text{ mm}}{8.5 \text{ mm}} \leq \frac{72 \cdot 0.814}{1.2}$$

$$17.9 \leq 48.8$$

OK

The shear buckling resistance of the web does not need to be verified.

### 5.2.2 Vertical shear

The resistance to vertical shear should be taken as the resistance of the structural steel section.

$$A_v = A_a - 2 \cdot b \cdot t_f + (t_w + 2 \cdot t_f) \cdot t_f \\ = 6.53 \cdot 10^{-3} - 2 \cdot 0.18 \cdot 0.014 + (8.5 \cdot 10^{-3} + 2 \cdot 0.015) \cdot 0.014 = 2024 \text{ mm}^2$$

$$A_{v,\min} = \eta_{sb} \cdot h_w \cdot t_w = 1.2 \cdot 0.152 \cdot 8.5 \cdot 10^{-3} = 1550 \text{ mm}^2$$

$$A_v \geq A_{v,\min}$$

$$2024 \text{ mm}^2 \geq 1550 \text{ mm}^2$$

$$V_{pl,Rd} = \frac{A_v \cdot f_{yb}}{\sqrt{3} \cdot \gamma_{M0}} = \frac{2024 \text{ mm}^2 \cdot 355 \cdot 10^6}{\sqrt{3} \cdot 1} = 415 \text{ kN}$$

$$UC_{\text{comp}_V} = \frac{\text{abs}(V_{Ed,\text{comp}})}{V_{pl,Rd}} = \frac{\text{abs}(95.099 \text{ kN})}{415 \text{ kN}} = 0.23$$

The shear resistance of the section is adequate.

### 5.2.3 Bending moment

#### 5.2.3.1 Longitudinal reinforcement

##### 5.2.3.1.1 Centre of composite section

For buildings not intended mainly for storage the effects of creep in concrete beams may be taken into account by using an effective E modulus  $E_{\text{ceff}} = E_{\text{cm}}/2$ .

$$E_{\text{ceff}} = \frac{E_{\text{cm}}}{2} = \frac{32800 \text{ MPa}}{2} = 16400 \text{ MPa}$$

$$\eta_E = \frac{E_b}{E_{\text{ceff}}} = \frac{210000 \text{ MPa}}{16400 \text{ MPa}} = 12.8$$

$$y_d = \frac{A_a \cdot \left(\frac{h_a}{2}\right) + \left(\frac{1}{\eta_E}\right) \cdot b_{\text{eff}} \cdot (h_c - h_d) \cdot \left(h_a + h_s + \frac{h_c - h_d}{2}\right)}{A_a + \left(\frac{1}{\eta_E}\right) \cdot b_{\text{eff}} \cdot (h_c - h_d)} \\ = \frac{6.53 \cdot 10^{-3} \cdot \left(\frac{0.18}{2}\right) + \left(\frac{1}{12.8}\right) \cdot 1 \cdot (0.09 - 0) \cdot \left(0.18 + 0.12 - \frac{0.09 - 0}{2}\right)}{6.53 \cdot 10^{-3} + \left(\frac{1}{12.8}\right) \cdot 1 \cdot (0.09 - 0)} = 176 \text{ mm}$$

##### 5.2.3.1.2 Degree of reinforcement

$$A_s = \frac{b_{\text{eff}}}{s_l} \cdot \left(\frac{d_l^2}{4}\right) \cdot \pi = \frac{1 \text{ m}}{150 \text{ mm}} \cdot \left(\frac{16 \text{ mm}^2}{4}\right) \cdot 3.14 = 1340 \text{ mm}^2$$

$$A_c = b_{\text{eff}} \cdot (h_c - h_d) = 1 \cdot (0.09 - 0) = 90000 \text{ mm}^2$$

$$z_0 = \left(h_a + h_s - \frac{h_c - h_d}{2}\right) - y_d = \left(0.18 + 0.12 - \frac{0.09 - 0}{2}\right) - 0.176 = 79.4 \text{ mm}$$

$$k_c = \min\left(\frac{1}{\left(1 + \frac{h_c - h_d}{2 \cdot z_0}\right)} + 0.3; 1\right) = \min\left(\frac{1}{\left(1 + \frac{0.09 - 0}{2 \cdot 0.0794}\right)} + 0.3; 1\right) = 0.938$$

$$\rho_s = \delta \cdot \left(\frac{f_{yb}}{235}\right) \cdot \left(\frac{f_{ctm}}{f_{ykr}}\right) \cdot \sqrt{k_c} = 1.1 \cdot \left(\frac{355}{235}\right) \cdot \left(\frac{2.9 \cdot 10^6}{500 \cdot 10^6}\right) \cdot \sqrt{0.938} = 0.934 \%$$

$$A_s \geq \rho_s \cdot A_c$$

$$1340 \text{ mm}^2 \geq 9.34 \cdot 10^{-3} \cdot 90000 \text{ mm}^2$$

$$1340 \text{ mm}^2 \geq 840 \text{ mm}^2 \quad \text{OK}$$

The longitudinal reinforcement of the section is adequate.



**5.2.3.2 Moment resistance****Moment resistance of a steel cross-section**

$$M_{pl,Rd,a} = \frac{W_{ply} \cdot f_{yb}}{\gamma_{M0}} = \frac{481400 \text{ mm}^3 \cdot 355 \text{ MPa}}{1} = 171 \text{ kNm}$$

**Influence of shear**

$$\frac{V_{pl,Rd}}{2} > \text{abs}(V_{Ed,comp})$$

$$\frac{415 \text{ kN}}{2} > 95.1 \text{ kN}$$

$$207 \text{ kN} > 95.1 \text{ kN} \quad \text{OK}$$

The influence of the vertical shear on the bending moment resistance may be neglected.

$$f_{yb,w} = f_{yb} = 355 \text{ MPa}$$

**Modified tension resistance of the steel member**

$$r = 0 \text{ mm}$$

$$A_a = 2 \cdot t_f \cdot b + t_w \cdot (h_a - 2 \cdot t_f) = 2 \cdot 14 \text{ mm} \cdot 180 \text{ mm} + 8.5 \text{ mm} \cdot (180 \text{ mm} - 2 \cdot 14 \text{ mm}) = 6332 \text{ mm}^2$$

$$N_{pl,a} = A_a \cdot f_{yb} = 6332 \text{ mm}^2 \cdot 355 \text{ MPa} = 2247.86 \text{ kN}$$

Note: Roundings of the steel cross-section are neglected in bending resistance calculation.

$$N_{c,t} = \min(F_s; N_{pl,a}) = \min(583 \text{ kN}; 2247.86 \text{ kN}) = 582.79 \text{ kN}$$

**Negative bending moment resistance calculation**

The plastic neutral axis is located within the flange of the steel section.

$$N_{pl,a} - N_{a,t} = F_s + N_{a,t}$$

$$x = \frac{(N_{pl,a} - F_s)}{(2 \cdot b \cdot f_{yb})} = \frac{(2247.86 \text{ kN} - 583 \text{ kN})}{(2 \cdot 180 \text{ mm} \cdot 355 \text{ MPa})} = 13 \text{ mm}$$

Verification of the steel web classification.

$$\alpha_{cl} = 1$$

$$\frac{c_w}{t_w} \leq \frac{396 \cdot \epsilon}{13 \cdot \alpha_{cl} - 1}$$

$$\frac{122 \text{ mm}}{8.5 \text{ mm}} \leq \frac{396 \cdot 0.814}{13 \cdot 1 - 1}$$

$$14.4 \leq 26.8 \quad \text{OK}$$

Web classified as Class 1.

$$N_{a,t} = b \cdot x \cdot f_{yb} = 180 \text{ mm} \cdot 13 \text{ mm} \cdot 355 \text{ MPa} = 832.54 \text{ kN}$$

$$N_{a,c} = N_{pl,a} - N_{a,t} = 2247.86 \text{ kN} - 832.54 \text{ kN} = 1415.32 \text{ kN}$$

Leverage arm of the compression part of the steel section calculated to the PNA.

$$h_{cs} = \frac{\left( b \cdot (t_f - x)^2 \cdot 0.5 + t_w \cdot (h_a - 2 \cdot t_f) \cdot \left( \frac{h_a}{2} - x \right) + t_f \cdot b \cdot \left( h_a - \frac{t_f}{2} - x \right) \right)}{b \cdot (t_f - x) + t_w \cdot (h_a - 2 \cdot t_f) + t_f \cdot b}$$

$$= \frac{\left( 180 \cdot (14 - 13)^2 \cdot 0.5 + 8.5 \cdot (180 - 2 \cdot 14) \cdot \left( \frac{180}{2} - 13 \right) + 14 \cdot 180 \cdot \left( 180 - \frac{14}{2} - 13 \right) \right)}{180 \cdot (14 - 13) + 8.5 \cdot (180 - 2 \cdot 14) + 14 \cdot 180}$$

$$h_{cs} = 126 \text{ mm}$$

$$h_1 = x + h_s - c_1 + \frac{d_1}{2} = 0.013 + 0.12 - 0.03 + \frac{0.016}{2} = 95 \text{ mm}$$

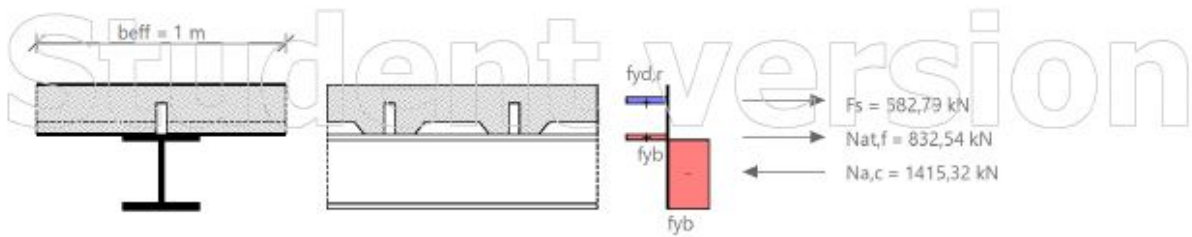

$$M_{pl,Rd} = F_s \cdot h_t + \frac{N_{at,f} \cdot x}{2} + N_{a,c} \cdot h_{cs} = 583 \cdot 95 + \frac{832,54 \cdot 13}{2} + 1415,32 \cdot 126 = 239 \text{ kNm}$$

### Design moment resistance according to EN 1994-1-1 Art.6.2.1.2

$$M_{Rd} = M_{pl,Rd} = 239 \text{ kNm}$$

$$UC_{comp,M} = \frac{abs(M_{Ed,comp})}{M_{Rd}} = \frac{abs(-130,167 \text{ kNm})}{239 \text{ kNm}} = 0,54$$

The bending moment resistance of the section is adequate.

### 5.3 LTB resistance

$$F = \left( 1 + \frac{t_w \cdot (h_a - t_f)}{4 \cdot b \cdot t_f} \right) \cdot \left( \frac{h_a - t_f}{t_w} \right)^{0,75} \cdot \left( \frac{t_f}{b} \right)^{0,25} = \left( 1 + \frac{8,5 \cdot (180 - 14)}{4 \cdot 180 \cdot 14} \right) \cdot \left( \frac{180 - 14}{8,5} \right)^{0,75} \cdot \left( \frac{14}{180} \right)^{0,25} = 5,59$$

$$F_{lim} = 12,3$$

$$F \leq F_{lim}$$

$$5,59 \leq 12,3$$

OK

The cross-section is qualified for verification of LTB by the simplified method.

$$C_4 = 25$$

$$\lambda_{LT,rel} = 5 \cdot \left( 1 + \frac{t_w \cdot (h_a - t_f)}{4 \cdot b \cdot t_f} \right) \cdot \left( \frac{h_a - t_f}{t_w} \right)^{0,75} \cdot \left( \frac{t_f}{b} \right)^{0,25} \cdot \left( \frac{f_{yb}}{E_b \cdot C_4} \right)^{0,5}$$

$$= 5 \cdot \left( 1 + \frac{8,5 \cdot 10^{-3} \cdot (0,18 - 0,014)}{4 \cdot 0,18 \cdot 0,014} \right) \cdot \left( \frac{0,18 - 0,014}{8,5 \cdot 10^{-3}} \right)^{0,75} \cdot \left( \frac{0,014}{0,18} \right)^{0,25} \cdot \left( \frac{355 \cdot 10^6}{210 \cdot 10^9 \cdot 25} \right)^{0,5} = 0,23$$

$h_a/b \leq 2 \rightarrow$  Buckling curve 'a'

$$\alpha_{LT} = 0,21$$

$$\Phi_{LT} = 0,5 \cdot \left( 1 + \alpha_{LT} \cdot (\lambda_{LT,rel} - 0,2) + \lambda_{LT,rel}^2 \right) = 0,5 \cdot \left( 1 + 0,21 \cdot (0,23 - 0,2) + 0,23^2 \right) = 0,53$$

$$X_{LT} = \frac{1}{\Phi_{LT} + \sqrt{\Phi_{LT}^2 - \lambda_{LT,rel}^2}} = \frac{1}{0,53 + \sqrt{0,53^2 - 0,23^2}} = 0,993$$

$$X_{LT} = \min(X_{LT}; 1) = \min(0,993; 1) = 0,993$$

$$M_{b,Rd} = X_{LT} \cdot M_{Rd} = 0,993 \cdot 239249 = 237,671 \text{ kNm}$$

$$UC_{comp\_LTB} = \frac{abs(M_{Ed,comp})}{M_{b,Rd}} = \frac{abs(-130,167 \text{ kNm})}{237,671 \text{ kNm}} = 0,55$$

The later torsional buckling resistance of the section is adequate.

Student version

## 5.4 Longitudinal shear

### 5.4.1 Transverse reinforcement

Design shear flow

$$h_f = h_c = 90 \text{ mm}$$

$$v_{Ed} = \frac{n_r \cdot P_{Rd}}{l_s \cdot h_f} = \frac{1 \cdot 86,3 \text{ kN}}{300 \text{ mm} \cdot 90 \text{ mm}} = 3,2 \text{ MPa}$$

Transverse reinforcement

$$\frac{A_{st} \cdot f_{yk,r}}{\gamma_s \cdot s_f} \geq \frac{v_{Ed} \cdot h_f}{\cotg(\theta)}$$

$$A_t = A_{st}/s_f$$

$$A_t = \frac{v_{Ed} \cdot h_f}{\left( \frac{\cotg(\theta) \cdot f_{yk,r}}{\gamma_s} \right)} = \frac{3,2 \cdot 10^6 \cdot 0,09}{\left( \frac{\cotg(26,5) \cdot 500 \cdot 10^6}{1,15} \right)} = 330 \text{ mm}^2/\text{m}$$

$$A_{t,prov} = \frac{1}{s_t} \cdot \left( \frac{d_t^2}{4} \right) \cdot 3,14 = \frac{1}{0,15} \cdot \left( \frac{0,016^2}{4} \right) \cdot 3,14 = 1340 \text{ mm}^2/\text{m}$$

$$A_{t,prov} \geq A_t$$

$$1340 \text{ mm}^2/\text{m} \geq 330 \text{ mm}^2/\text{m} \quad \text{OK}$$

The transverse reinforcement of the section is adequate.

**ULS check of Final stage is NOT OK.**

$$UC_{comp} = \max(0,23; 0,54; 0,55) = 0,55$$

Iskoristivost elemenata za GSN – 55%

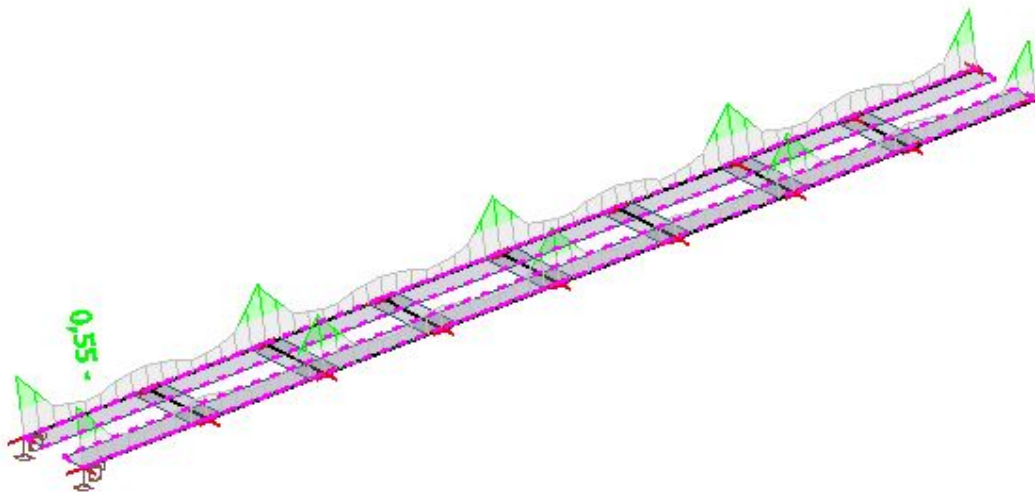

Slika 5.41. Prikaz iskoristivosti grednih nosača rampe

### 5.8. Stupovi rampe (prizemlje-kat)

#### Rezne sile stupova rampe

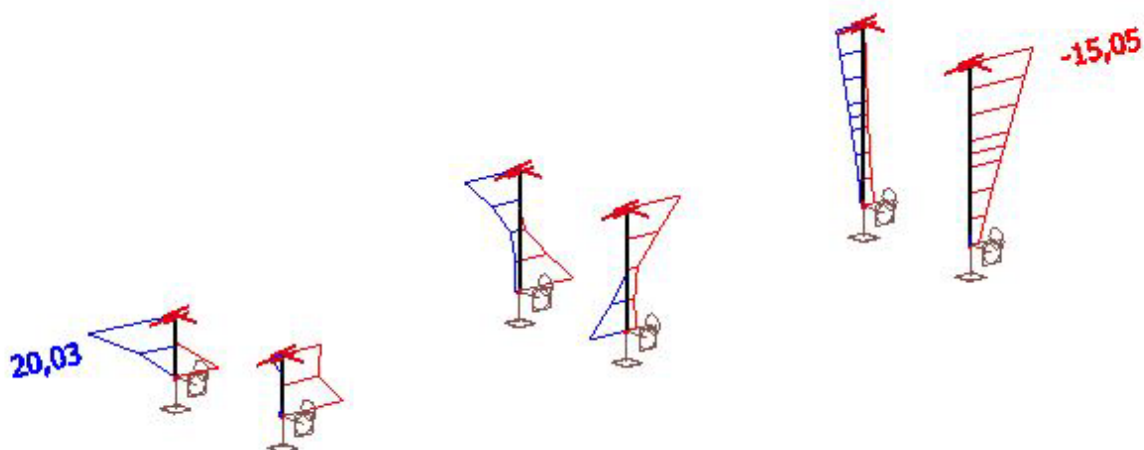

Slika 5.42. Rezne sile  $M_y$

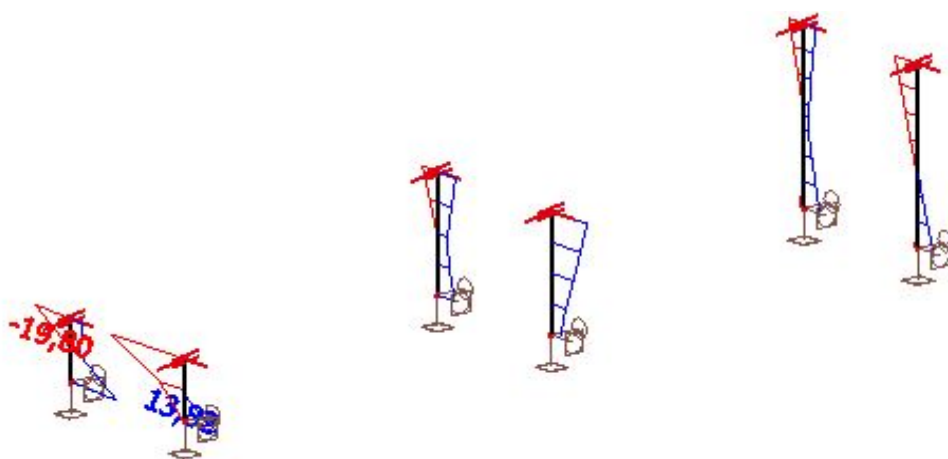

Slika 5.43. Rezne sile  $M_z$

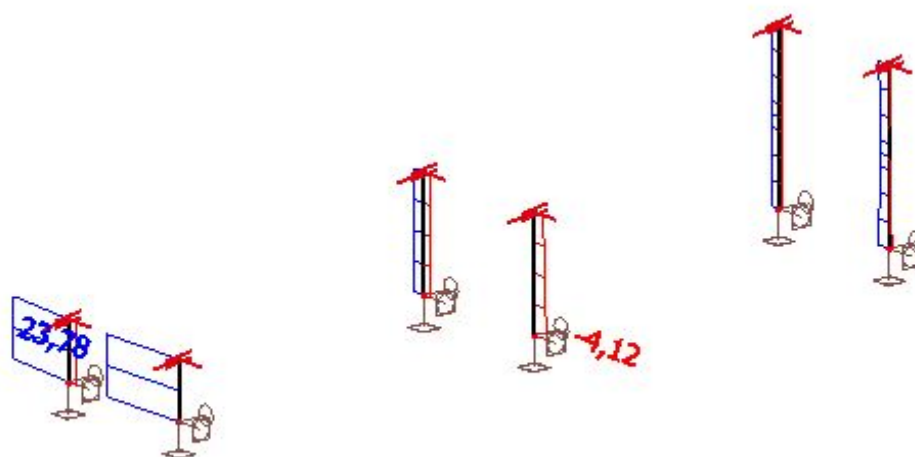

Slika 5.44. Rezne sile  $V_y$

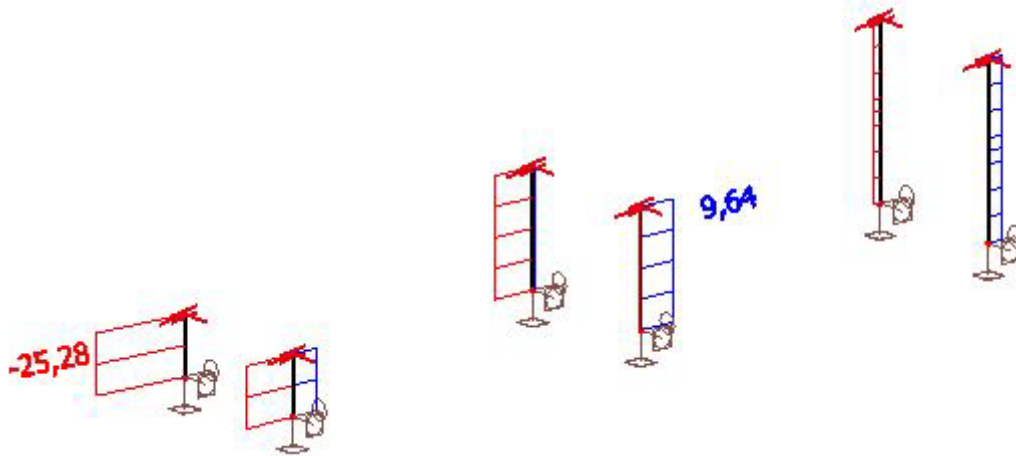

Slika 5.45. Rezne sile Vz

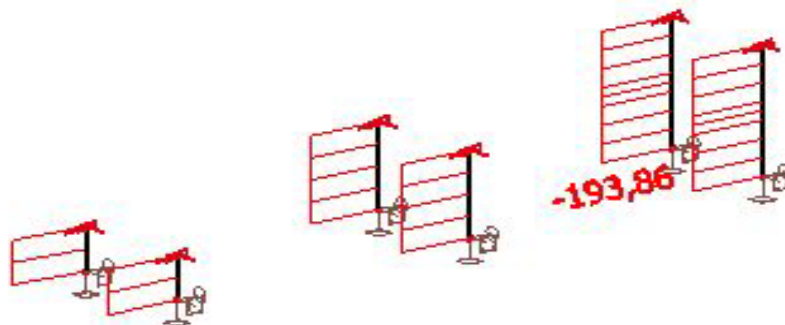

Slika 5.46. Rezne sile N

Poprečni presjek stupova rampe

Name	Stupovi rampe prizemlje	
Type	HEA200A	
Source description	Profil Arbed / Structural shapes / Edition Octobre 1995	
Item material	S 355	
Fabrication	rolled	
Flexural buckling y-y	b	
Flexural buckling z-z	c	
Lateral torsional buckling	Default	
Use 2D FEM analysis	x	
A [m <sup>2</sup> ]	4,4100e-03	
A <sub>y, z</sub> [m <sup>2</sup> ]	3,1221e-03	1,1054e-03
I <sub>y, z</sub> [m <sup>4</sup> ]	2,9400e-05	1,0700e-05
I <sub>w</sub> [m <sup>6</sup> ], I <sub>t</sub> [m <sup>4</sup> ]	8,4491e-08	1,2700e-07
W <sub>el y, z</sub> [m <sup>3</sup> ]	3,1700e-04	1,0700e-04
W <sub>pl y, z</sub> [m <sup>3</sup> ]	3,4708e-04	1,6333e-04
d <sub>y, z</sub> [mm]	0	0
c <sub>YUCS, ZUCS</sub> [mm]	100	93
α [deg]	0,00	
A <sub>L, D</sub> [m <sup>2</sup> /m]	1,1300e+00	1,1300e+00
M <sub>ply +, -</sub> [Nm]	1,23e+05	1,23e+05
M <sub>plz +, -</sub> [Nm]	5,79e+04	5,79e+04

Slika 5.47. Prikaz geometrijskih karakteristika stupova rampe

Dimenzioniranje

**Check of steel**

Linear calculation, Extreme : Global  
 Selection : B618  
 Class : GSN  
 Cross-section : Stupovi rampe prizemlje - HEA200A

**EN 1993-1-1 Code Check**

National annex: Standard EN

<b>Member B618</b>	<b>1,158 m</b>	<b>HEA200A</b>	<b>S 355</b>	<b>GSN19/1</b>	<b>0,76 -</b>
--------------------	----------------	----------------	--------------	----------------	---------------

Partial safety factors	
Gamma M0 for resistance of cross-sections	1,00
Gamma M1 for resistance to instability	1,00
Gamma M2 for resistance of net sections	1,25

Material		
Yield strength fy	355,0	MPa
Ultimate strength fu	490,0	MPa
Fabrication	Rolled	

**....SECTION CHECK:....**

**Classification for cross-section design**

According to EN 1993-1-1 article 5.5.2

**Classification of Internal Compression parts**

According to EN 1993-1-1 Table 5.2 Sheet 1

Maximum width-to-thickness ratio	24,36
Class 1 Limit	26,85
Class 2 Limit	30,92
Class 3 Limit	48,38

=> Internal Compression parts Class 1

**Classification of Outstand Flanges**

According to EN 1993-1-1 Table 5.2 Sheet 2

Maximum width-to-thickness ratio	9,91
Class 1 Limit	7,32
Class 2 Limit	8,14
Class 3 Limit	11,78

=> Outstand Flanges Class 3

=> Section classified as Class 3 for cross-section design

**The critical check is on position 1.158 m**

Internal forces	Calculated	Unit
N,Ed	-179,01	kN
Vy,Ed	23,78	kN
Vz,Ed	-10,75	kN
T,Ed	0,00	kNm
My,Ed	-14,28	kNm
Mz,Ed	8,03	kNm

**Compression check**

According to EN 1993-1-1 article 6.2.4 and formula (6.9)

A	4,4100e-03	m <sup>2</sup>
Nc,Rd	1565,55	kN
Unity check	0,11	-

**Bending moment check for My**

According to EN 1993-1-1 article 6.2.5 and formula (6.12),(6.14)

W <sub>el,y,min</sub>	3,1700e-04	m <sup>3</sup>
M <sub>el,y,Rd</sub>	112,54	kNm
Unity check	0,13	-

**Bending moment check for Mz**

According to EN 1993-1-1 article 6.2.5 and formula (6.12),(6.14)

W <sub>el,z,min</sub>	1,0700e-04	m <sup>3</sup>
M <sub>el,z,Rd</sub>	37,98	kNm
Unity check	0,21	-

**Shear check for Vy**

According to EN 1993-1-1 article 6.2.6 and formula (6.17)

Eta	1,20	
-----	------	--

Av	3,3293e-03	m <sup>2</sup>
Vpl,y,Rd	682,36	kN
Unity check	0,03	-

**Shear check for Vz**

According to EN 1993-1-1 article 6.2.6 and formula (6.17)

Eta	1,20	
Av	1,5420e-03	m <sup>2</sup>
Vpl,z,Rd	316,05	kN
Unity check	0,03	-

**Torsion check**

According to EN 1993-1-1 article 6.2.7 and formula (6.23)

Tau,t,Ed	0,3	MPa
Tau,Rd	205,0	MPa
Unity check	0,00	-

**Note:** The unity check for torsion is lower than the limit value of 0,05. Therefore torsion is considered as insignificant and is ignored in the combined checks.

**Combined bending, axial force and shear force check**

According to EN 1993-1-1 article 6.2.9.2 and formula (6.42)

Normal stresses		
Fibre	3	
Sigma,N,Ed	40,6	MPa
Sigma,My,Ed	45,2	MPa
Sigma,Mz,Ed	75,0	MPa
Sigma,tot,Ed	160,8	MPa
Unity check	0,45	-

The member satisfies the section check.

**...:STABILITY CHECK:...****Classification for member buckling design**

Decisive position for stability classification: 0,000 m

**Classification of Internal Compression parts**

According to EN 1993-1-1 Table 5.2 Sheet 1

Maximum width-to-thickness ratio	24,35
Class 1 Limit	26,85
Class 2 Limit	30,92
Class 3 Limit	36,42

=&gt; Internal Compression parts Class 1

**Classification of Outstand Flanges**

According to EN 1993-1-1 Table 5.2 Sheet 2

Maximum width-to-thickness ratio	9,91
Class 1 Limit	7,32
Class 2 Limit	8,14
Class 3 Limit	12,37

=&gt; Outstand Flanges Class 3

=&gt; Section classified as Class 3 for member buckling design

**Flexural Buckling check**

According to EN 1993-1-1 article 6.3.1.1 and formula (6.46)

Buckling parameters	yy	zz	
Sway type	sway	non-sway	
System length L	1,158	1,158	m
Buckling factor k	1,58	0,62	
Buckling length Lcr	1,828	0,715	m
Critical Euler load Ncr	18237,29	43332,47	kN
Slenderness Lambda	22,39	14,52	
Relative slenderness Lambda,rel	0,29	0,19	
Limit slenderness Lambda,rel,0	0,20	0,20	

**Note:** The slenderness or compression force is such that Flexural Buckling effects may be ignored according to EN 1993-1-1 article 6.3.1.2(4).

**Torsional(-Flexural) Buckling check**

According to EN 1993-1-1 article 6.3.1.1 and formula (6.46)

**Note:** For this I-section the Torsional(-Flexural) buckling resistance is higher than the resistance for Flexural buckling. Therefore Torsional(-Flexural) buckling is not printed on the output.

**Lateral Torsional Buckling check**

According to EN 1993-1-1 article 6.3.2.1 &amp; 6.3.2.2 and formula (6.54)

LTB parameters		
Method for LTB curve	General case	
Cross-section elastic modulus $W_{el,y}$	3,1700e-04	m <sup>3</sup>
Elastic critical moment $M_{cr}$	2502,97	kNm
Relative slenderness $\Lambda_{rel,LT}$	0,21	
Limit slenderness $\Lambda_{rel,LT,0}$	0,20	

**Note:** The slenderness or bending moment is such that Lateral Torsional Buckling effects may be ignored according to EN 1993-1-1 article 6.3.2.2(4).

Mcr parameters		
LTB length L	1,158	m
Influence of load position	no influence	
Correction factor k	1,00	
Correction factor $k_w$	1,00	
LTB moment factor C1	1,64	
LTB moment factor C2	0,00	
LTB moment factor C3	1,00	
Shear center distance $d_z$	0	mm
Distance of load application $z_g$	0	mm
Mono-symmetry constant $\beta_{y1}$	0	mm
Mono-symmetry constant $z_j$	0	mm

**Note:** C parameters are determined according to ECCS 119 2006 / Galea 2002.

**Bending and axial compression check**

According to EN 1993-1-1 article 6.3.3 and formula (6.61),(6.62)

Bending and axial compression check parameters		
Interaction method	alternative method 1	
Cross-section area A	4,4100e-03	m <sup>2</sup>
Cross-section elastic modulus $W_{el,y}$	3,1700e-04	m <sup>3</sup>
Cross-section elastic modulus $W_{el,z}$	1,0700e-04	m <sup>3</sup>
Design compression force $N_{Ed}$	179,01	kN
Design bending moment (maximum) $M_{y,Ed}$	-14,28	kNm
Design bending moment (maximum) $M_{z,Ed}$	-19,51	kNm
Characteristic compression resistance $N_{Rk}$	1565,55	kN
Characteristic moment resistance $M_{y,Rk}$	112,54	kNm
Characteristic moment resistance $M_{z,Rk}$	37,98	kNm
Reduction factor $\chi_{i,y}$	1,00	
Reduction factor $\chi_{i,z}$	1,00	
Reduction factor $\chi_{i,LT}$	1,00	
Interaction factor $k_{yy}$	1,01	
Interaction factor $k_{yz}$	1,00	
Interaction factor $k_{zy}$	1,01	
Interaction factor $k_{zz}$	1,00	

Maximum moment  $M_{y,Ed}$  is derived from beam B618 position 1,158 m.

Maximum moment  $M_{z,Ed}$  is derived from beam B618 position 0,000 m.

Interaction method 1 parameters		
Critical Euler load $N_{cr,y}$	18237,29	kN
Critical Euler load $N_{cr,z}$	43332,47	kN
Elastic critical load $N_{cr,T}$	15495,88	kN
Cross-section elastic modulus $W_{el,y}$	3,1700e-04	m <sup>3</sup>
Second moment of area $I_y$	2,9400e-05	m <sup>4</sup>
Second moment of area $I_z$	1,0700e-05	m <sup>4</sup>
Torsional constant $I_t$	1,2700e-07	m <sup>4</sup>
Method for equivalent moment factor $C_{m,y,0}$	Table A.2 Line 2 (General)	
Design bending moment (maximum) $M_{y,Ed}$	-14,28	kNm
Maximum relative deflection $\delta_{rel,z}$	0,2	mm
Equivalent moment factor $C_{m,y,0}$	1,00	
Method for equivalent moment factor $C_{m,z,0}$	Table A.2 Line 2 (General)	
Design bending moment (maximum) $M_{z,Ed}$	-19,51	kNm
Maximum relative deflection $\delta_{rel,y}$	0,4	mm
Equivalent moment factor $C_{m,z,0}$	1,00	
Factor $\mu_{y1}$	1,00	
Factor $\mu_{z1}$	1,00	
Factor $\epsilon_{y1}$	1,11	



Interaction method 1 parameters		
Factor $a_{LT}$	1,00	
Critical moment for uniform bending $M_{cr,D}$	1526,85	kNm
Relative slenderness $\lambda_{rel,0}$	0,27	
Limit relative slenderness $\lambda_{rel,0,lim}$	0,26	
Equivalent moment factor $C_{my}$	1,00	
Equivalent moment factor $C_{mz}$	1,00	
Equivalent moment factor $C_{mLT}$	1,00	

Unity check (6.61) =  $0,11 + 0,13 + 0,51 = 0,76$  -

Unity check (6.62) =  $0,11 + 0,13 + 0,51 = 0,76$  -

**Shear Buckling check**

According to EN 1993-1-5 article 5 & 7.1 and formula (5.10) & (7.1)

Shear Buckling parameters		
Buckling field length $a$	1,158	m
Web	unstiffened	
Web height $h_w$	170	mm
Web thickness $t$	6	mm
Material coefficient $\epsilon$	0,81	
Shear correction factor $\eta$	1,20	

Shear Buckling verification	
Web slenderness $h_w/t$	30,91
Web slenderness limit	48,82

**Note:** The web slenderness is such that Shear Buckling effects may be ignored according to EN 1993-1-5 article 5.1(2).

The member satisfies the stability check.

Iskoristivost elemenata za GSN – 76%

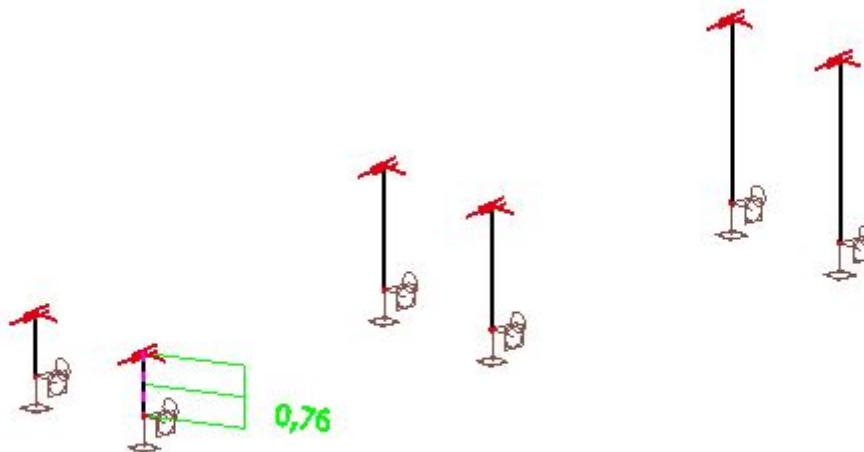

Slika 5.48. Prikaz iskoristivosti stupova rampe

## 5.9. Dijagonale prizemlja

### Rezne sile dijagonala

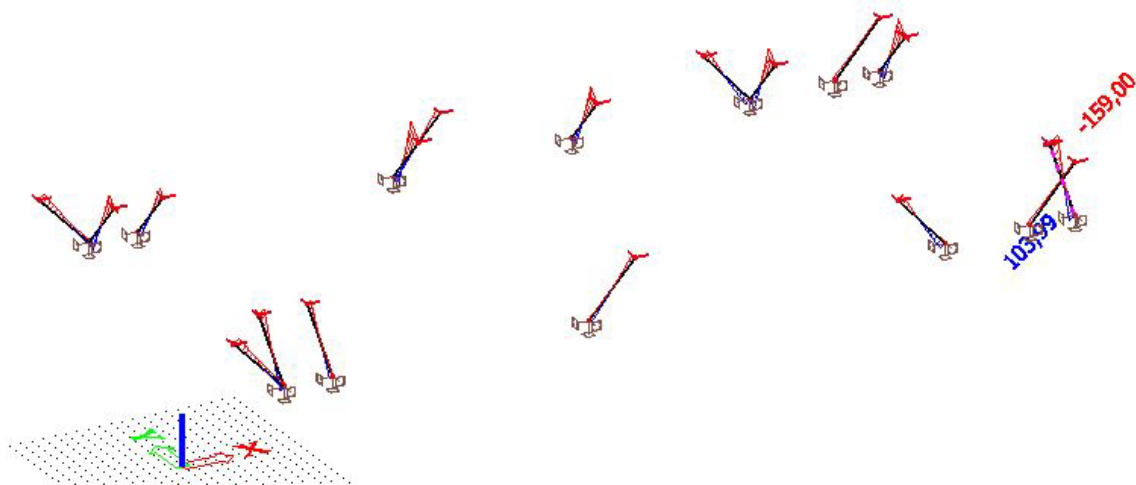

Slika 5.49. Rezne sile-My

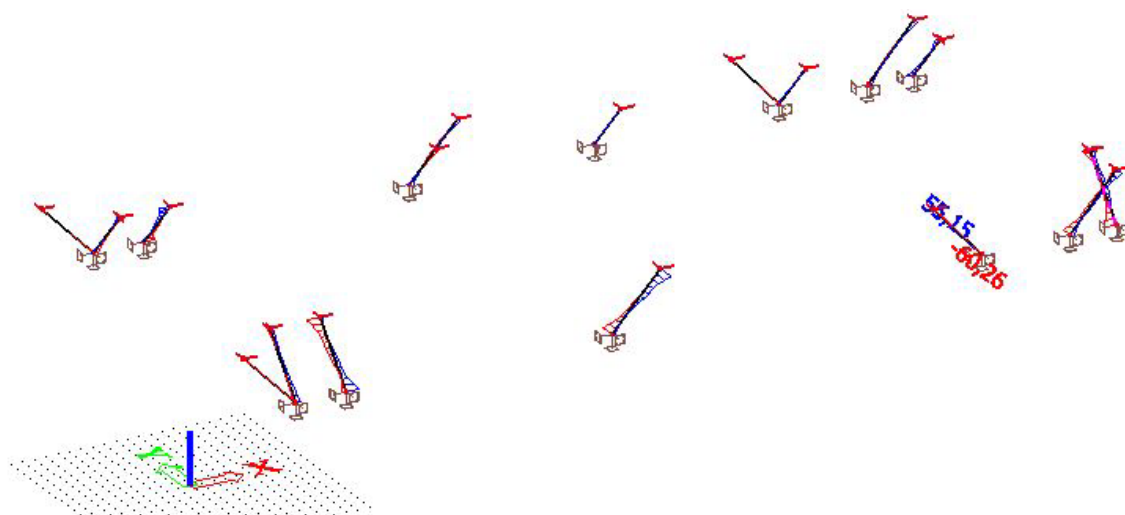

Slika 5.50. Rezne sile-Mz

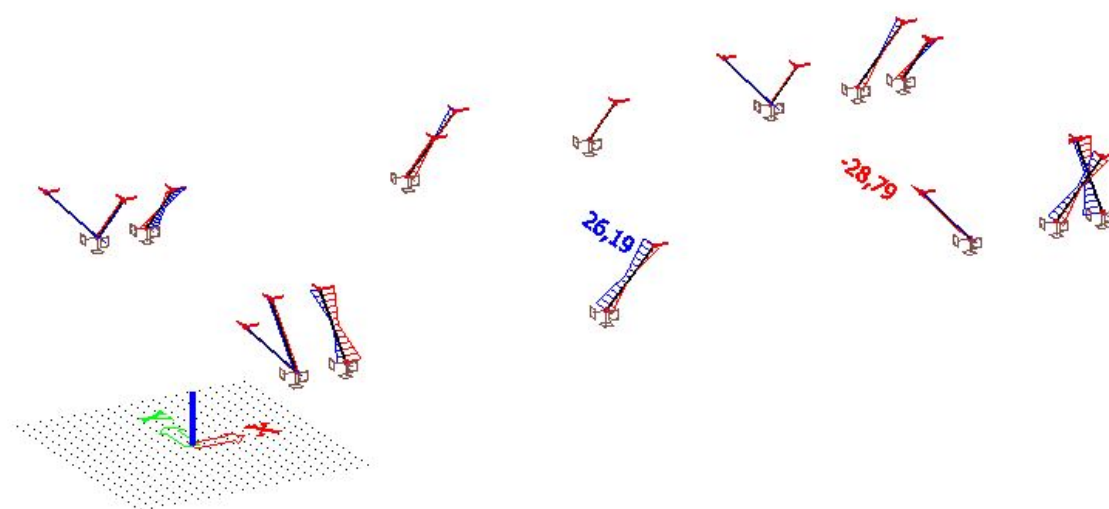

Slika 5.51. Rezne sile-Vy

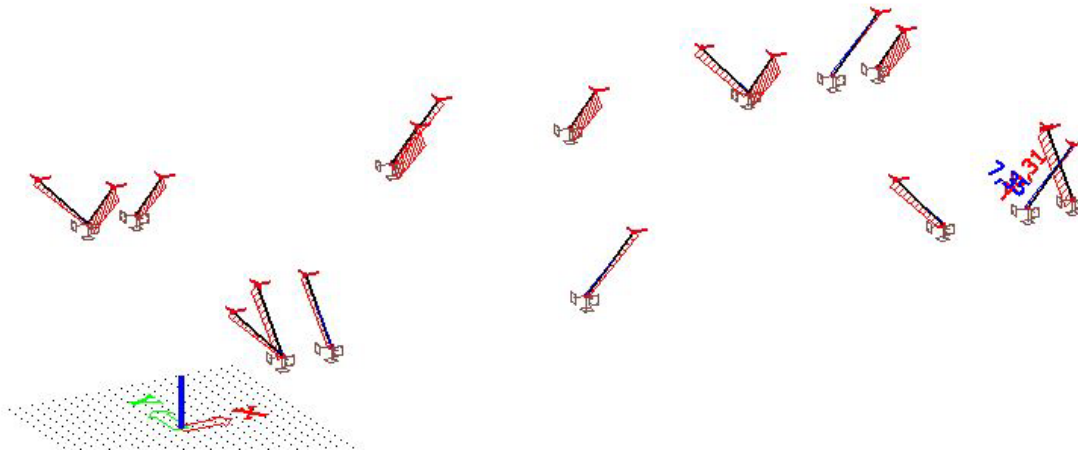

Slika 5.52. Rezne sile-Vz

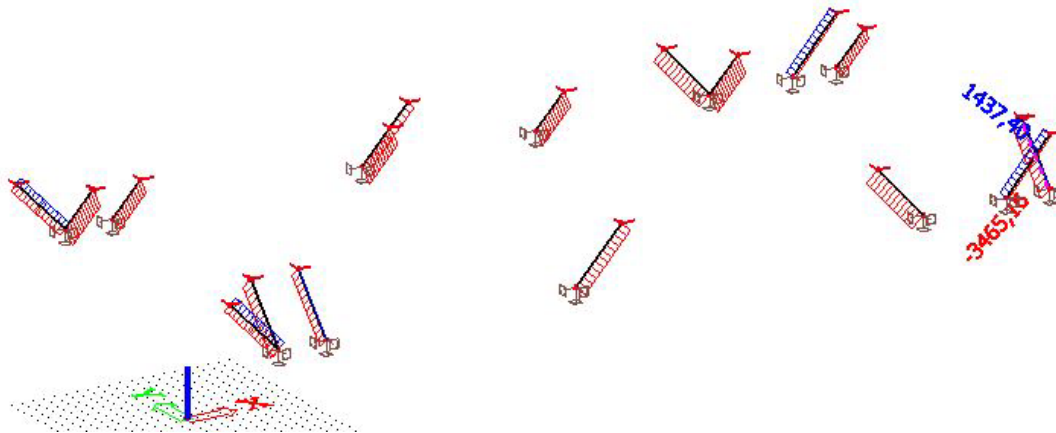

Slika 5.53. Rezne sile-N

Poprečni presjek dijagonala prizemlja

Name	Dijagonale prizemlja	
Type	HEB360	
Source description	Profil Arbed / Structural shapes / Edition Octobre 1995	
Item material	S 355	
Fabrication	rolled	
Flexural buckling y-y	b	
Flexural buckling z-z	c	
Lateral torsional buckling	Default	
Use 2D FEM analysis	x	
A [m <sup>2</sup> ]	1,8060e-02	
A <sub>y, z</sub> [m <sup>2</sup> ]	1,2975e-02	4,7491e-03
I <sub>y, z</sub> [m <sup>4</sup> ]	4,3190e-04	1,0140e-04
I <sub>w</sub> [m <sup>6</sup> ], I <sub>t</sub> [m <sup>4</sup> ]	2,8833e-06	2,9250e-06
W <sub>el y, z</sub> [m <sup>3</sup> ]	2,4000e-03	6,7610e-04
W <sub>pl y, z</sub> [m <sup>3</sup> ]	2,6830e-03	1,0320e-03
d <sub>y, z</sub> [mm]	0	0
c YUCS, ZUCS [mm]	150	180
α [deg]	0,00	
A <sub>L, D</sub> [m <sup>2</sup> /m]	1,8500e+00	1,8484e+00
M <sub>ply +, -</sub> [Nm]	9,53e+05	9,53e+05
M <sub>plz +, -</sub> [Nm]	3,67e+05	3,67e+05

Slika 5.54. Prikaz geometrijskih karakteristika dijagonala prizemlja

**Dimenzioniranje**

**Check of steel**

Linear calculation, Extreme : Global  
 Selection : B35  
 Class : GSN  
 Cross-section : Dijagonale prizemlja - HEB360

**EN 1993-1-1 Code Check**

National annex: Standard EN

Member B35	6,210 m	HEB360	S 355	GSN17/1	0,92 -
------------	---------	--------	-------	---------	--------

Partial safety factors	
Gamma M0 for resistance of cross-sections	1,00
Gamma M1 for resistance to instability	1,00
Gamma M2 for resistance of net sections	1,25

Material		
Yield strength fy	355,0	MPa
Ultimate strength fu	490,0	MPa
Fabrication	Rolled	

**...:SECTION CHECK:...**

**Classification for cross-section design**

According to EN 1993-1-1 article 5.5.2

**Classification of Internal Compression parts**

According to EN 1993-1-1 Table 5.2 Sheet 1

Maximum width-to-thickness ratio	20,88
Class 1 Limit	26,85
Class 2 Limit	30,92
Class 3 Limit	39,38

=> Internal Compression parts Class 1

**Classification of Outstand Flanges**

According to EN 1993-1-1 Table 5.2 Sheet 2

Maximum width-to-thickness ratio	5,19
Class 1 Limit	7,32
Class 2 Limit	8,14
Class 3 Limit	11,21

=> Outstand Flanges Class 1

=> Section classified as Class 1 for cross-section design

**The critical check is on position 6.210 m**

Internal forces	Calculated	Unit
N <sub>Ed</sub>	-3456,11	kN
V <sub>y,Ed</sub>	-5,31	kN
V <sub>z,Ed</sub>	-46,22	kN
T <sub>Ed</sub>	-0,02	kNm
M <sub>y,Ed</sub>	-158,71	kNm
M <sub>z,Ed</sub>	0,85	kNm

**Compression check**

According to EN 1993-1-1 article 6.2.4 and formula (6.9)

A	1,8060e-02	m <sup>2</sup>
N <sub>c,Rd</sub>	6411,30	kN
Unity check	0,54	-

**Bending moment check for My**

According to EN 1993-1-1 article 6.2.5 and formula (6.12),(6.13)

W <sub>pl,y</sub>	2,6830e-03	m <sup>3</sup>
M <sub>pl,y,Rd</sub>	952,47	kNm
Unity check	0,17	-

**Bending moment check for Mz**

According to EN 1993-1-1 article 6.2.5 and formula (6.12),(6.13)

W <sub>pl,z</sub>	1,0320e-03	m <sup>3</sup>
M <sub>pl,z,Rd</sub>	366,36	kNm
Unity check	0,00	-

**Shear check for Vy**

According to EN 1993-1-1 article 6.2.6 and formula (6.17)

Eta	1,20	
-----	------	--

Av	1,3994e-02	m <sup>2</sup>
Vpl,y,Rd	2868,15	kN
Unity check	0,00	-

**Shear check for Vz**

According to EN 1993-1-1 article 6.2.6 and formula (6.17)

Eta	1,20	
Av	6,0563e-03	m <sup>2</sup>
Vpl,z,Rd	1241,29	kN
Unity check	0,04	-

**Torsion check**

According to EN 1993-1-1 article 6.2.7 and formula (6.23)

Tau,t,Ed	0,2	MPa
Tau,Rd	205,0	MPa
Unity check	0,00	-

**Note:** The unity check for torsion is lower than the limit value of 0,05. Therefore torsion is considered as insignificant and is ignored in the combined checks.

**Combined bending, axial force and shear force check**

According to EN 1993-1-1 article 6.2.9.1 and formula (6.41)

MN,y,Rd	502,46	kNm
Alpha	2,00	
MN,z,Rd	312,51	kNm
Beta	2,70	

Unity check (6.41) = 0,10 + 0,00 = 0,10 -

**Note:** Since the shear forces are less than half the plastic shear resistances their effect on the moment resistances is neglected.

The member satisfies the section check.

**....:STABILITY CHECK:....****Classification for member buckling design**

Decisive position for stability classification: 0,000 m

**Classification of Internal Compression parts**

According to EN 1993-1-1 Table 5.2 Sheet 1

Maximum width-to-thickness ratio	20,88
Class 1 Limit	26,85
Class 2 Limit	30,92
Class 3 Limit	37,66

=&gt; Internal Compression parts Class 1

**Classification of Outstand Flanges**

According to EN 1993-1-1 Table 5.2 Sheet 2

Maximum width-to-thickness ratio	5,19
Class 1 Limit	7,32
Class 2 Limit	8,14
Class 3 Limit	11,32

=&gt; Outstand Flanges Class 1

=&gt; Section classified as Class 1 for member buckling design

**Flexural Buckling check**

According to EN 1993-1-1 article 6.3.1.1 and formula (6.46)

Buckling parameters	yy	zz	
Sway type	sway	non-sway	
System length L	6,210	6,210	m
Buckling factor k	1,23	0,51	
Buckling length Lcr	7,629	3,163	m
Critical Euler load Ncr	15382,22	21003,91	kN
Slenderness Lambda	49,33	42,22	
Relative slenderness Lambda,rel	0,65	0,55	
Limit slenderness Lambda,rel,0	0,20	0,20	
Buckling curve	b	c	
Imperfection Alpha	0,34	0,49	
Reduction factor Chi	0,81	0,81	
Buckling resistance Nb,Rd	5215,70	5213,52	kN

Flexural Buckling verification		
Cross-section area A	1,8060e-02	m <sup>2</sup>
Buckling resistance Nb,Rd	5213,52	kN
Unity check	0,66	-

**Torsional(-Flexural) Buckling check**

According to EN 1993-1-1 article 6.3.1.1 and formula (6.46)

Torsional buckling length Lcr	6,210	m
Elastic critical load Ncr,T	13248,67	kN
Elastic critical load Ncr,TF	13248,67	kN
Relative slenderness Lambda,rel,T	0,70	
Limit slenderness Lambda,rel,0	0,20	
Buckling curve	c	
Imperfection Alpha	0,49	
Reduction factor Chi	0,73	
Cross-section area A	1,8060e-02	m <sup>2</sup>
Buckling resistance Nb,Rd	4663,48	kN
Unity check	0,74	-

**Lateral Torsional Buckling check**

According to EN 1993-1-1 article 6.3.2.1 & 6.3.2.2 and formula (6.54)

LTB parameters		
Method for LTB curve	General case	
Cross-section plastic modulus Wpl,y	2,6830e-03	m <sup>3</sup>
Elastic critical moment Mcr	3802,51	kNm
Relative slenderness Lambda,rel,LT	0,50	
Limit slenderness Lambda,rel,LT,0	0,20	
LTB curve	a	
Imperfection Alpha,LT	0,21	
Reduction factor Chi,LT	0,92	
Design buckling resistance Mb,Rd	880,19	kNm
Unity check	0,18	-

Mcr parameters		
LTB length L	6,210	m
Influence of load position	no influence	
Correction factor k	1,00	
Correction factor kw	1,00	
LTB moment factor C1	2,60	
LTB moment factor C2	0,03	
LTB moment factor C3	1,00	
Shear center distance d,z	0	mm
Distance of load application z,g	0	mm
Mono-symmetry constant beta,y	0	mm
Mono-symmetry constant z,j	0	mm

**Note:** C parameters are determined according to ECCS 119 2006 / Galea 2002.

**Bending and axial compression check**

According to EN 1993-1-1 article 6.3.3 and formula (6.61),(6.62)

Bending and axial compression check parameters		
Interaction method	alternative method 1	
Cross-section area A	1,8060e-02	m <sup>2</sup>
Cross-section plastic modulus Wpl,y	2,6830e-03	m <sup>3</sup>
Cross-section plastic modulus Wpl,z	1,0320e-03	m <sup>3</sup>
Design compression force N,Ed	3456,11	kN
Design bending moment (maximum) My,Ed	-158,71	kNm
Design bending moment (maximum) Mz,Ed	-24,87	kNm
Characteristic compression resistance N,Rk	6411,30	kN
Characteristic moment resistance My,Rk	952,47	kNm
Characteristic moment resistance Mz,Rk	366,36	kNm
Reduction factor Chi,y	0,81	
Reduction factor Chi,z	0,73	
Reduction factor Chi,LT	0,92	
Interaction factor k,yy	1,05	
Interaction factor k,yz	0,53	
Interaction factor k,zy	0,62	
Interaction factor k,zz	1,05	

Maximum moment  $M_{y,Ed}$  is derived from beam B35 position 6,210 m.

Maximum moment  $M_{z,Ed}$  is derived from beam B35 position 0,000 m.

Interaction method 1 parameters		
Critical Euler load $N_{cr,y}$	15382,22	kN
Critical Euler load $N_{cr,z}$	21003,91	kN
Elastic critical load $N_{cr,T}$	13248,67	kN
Cross-section plastic modulus $W_{pl,y}$	2,6830e-03	m <sup>3</sup>
Cross-section elastic modulus $W_{el,y}$	2,4000e-03	m <sup>3</sup>
Cross-section plastic modulus $W_{pl,z}$	1,0320e-03	m <sup>3</sup>
Cross-section elastic modulus $W_{el,z}$	6,7610e-04	m <sup>3</sup>
Second moment of area $I_y$	4,3190e-04	m <sup>4</sup>
Second moment of area $I_z$	1,0140e-04	m <sup>4</sup>
Torsional constant $I_t$	2,9250e-06	m <sup>4</sup>
Method for equivalent moment factor $C_{my,0}$	Table A.2 Line 2 (General)	
Design bending moment (maximum) $M_{y,Ed}$	-158,71	kNm
Maximum relative deflection $\delta_{r,z}$	1,7	mm
Equivalent moment factor $C_{my,0}$	0,83	
Method for equivalent moment factor $C_{mz,0}$	Table A.2 Line 2 (General)	
Design bending moment (maximum) $M_{z,Ed}$	-24,87	kNm
Maximum relative deflection $\delta_{r,y}$	0,4	mm
Equivalent moment factor $C_{mz,0}$	0,85	
Factor $\mu_{y,0}$	0,95	
Factor $\mu_{z,0}$	0,96	
Factor $\epsilon_{y,0}$	0,35	
Factor $a_{LT}$	0,99	
Critical moment for uniform bending $M_{cr,0}$	1460,23	kNm
Relative slenderness $\lambda_{rel,0}$	0,81	
Limit relative slenderness $\lambda_{rel,0,lim}$	0,29	
Equivalent moment factor $C_{my}$	0,89	
Equivalent moment factor $C_{mz}$	0,85	
Equivalent moment factor $C_{m,LT}$	1,01	
Factor $b_{LT}$	0,00	
Factor $c_{LT}$	0,26	
Factor $d_{LT}$	0,13	
Factor $e_{LT}$	1,42	
Factor $w_{y,0}$	1,12	
Factor $w_{z,0}$	1,50	
Factor $n_{pl}$	0,54	
Maximum relative slenderness $\lambda_{rel,max}$	0,65	
Factor $C_{yy}$	1,05	
Factor $C_{yz}$	1,26	
Factor $C_{zy}$	0,94	
Factor $C_{zz}$	0,93	

Unity check (6.61) =  $0,66 + 0,19 + 0,04 = 0,89$  -

Unity check (6.62) =  $0,74 + 0,11 + 0,07 = 0,92$  -

#### Shear Buckling check

According to EN 1993-1-5 article 5 & 7.1 and formula (5.10) & (7.1)

Shear Buckling parameters		
Buckling field length $a$	6,210	m
Web	unstiffened	
Web height $h_w$	315	mm
Web thickness $t$	13	mm
Material coefficient $\epsilon$	0,81	
Shear correction factor $\eta$	1,20	

Shear Buckling verification	
Web slenderness $h_w/t$	25,20
Web slenderness limit	48,82

**Note:** The web slenderness is such that Shear Buckling effects may be ignored according to EN 1993-1-5 article 5.1(2).

The member satisfies the stability check.

Iskoristivost elemenata za GSN – 92%

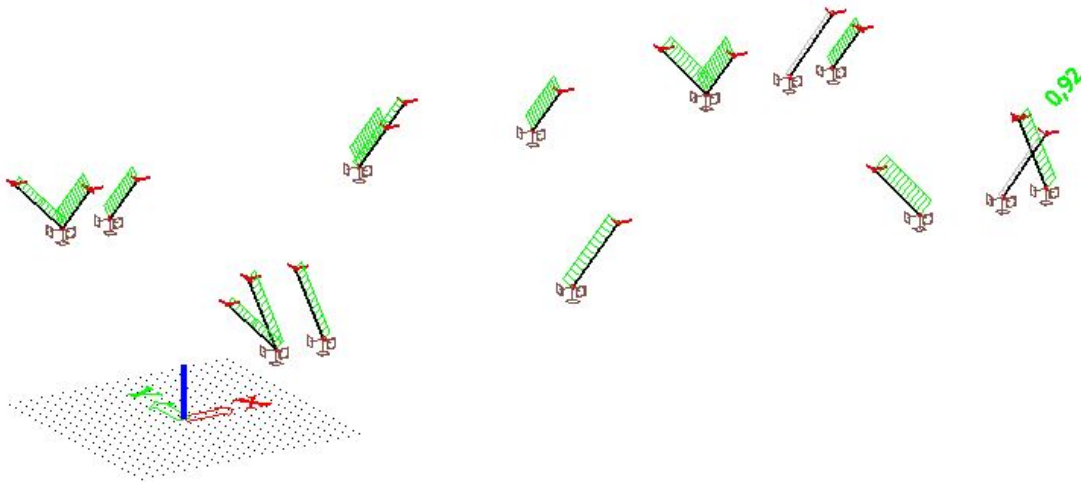

*Slika 5.55. Prikaz iskoristivosti dijagonala prizemlja*



### 5.10. Stupovi prizemlja(spregnuti)

#### Pomaci stupova prizemlja

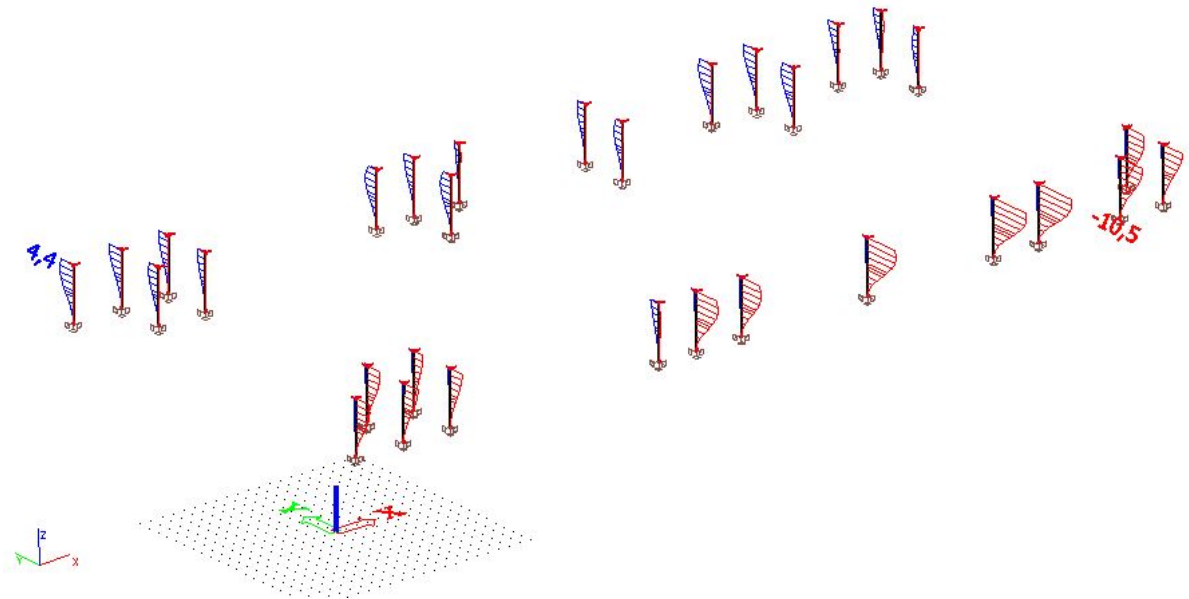

*Slika 5.56. Prikaz horizontalnog pomaka stupova prizemlja*

Dopušteni horizontalni pomak :

$$u_{dop} = \frac{h}{200} = \frac{4,56}{200} = 22,8 \text{ mm}$$

$$u_z = 10,5 \text{ mm} < u_{dop} = 22,8 \text{ mm} \quad \text{-zadovoljava}$$

-iskoristivost na GSU –  $10,5 \text{ mm} / 22,8 \text{ mm} = 0,46 = 46\%$

#### Rezne sile stupova prizemlja

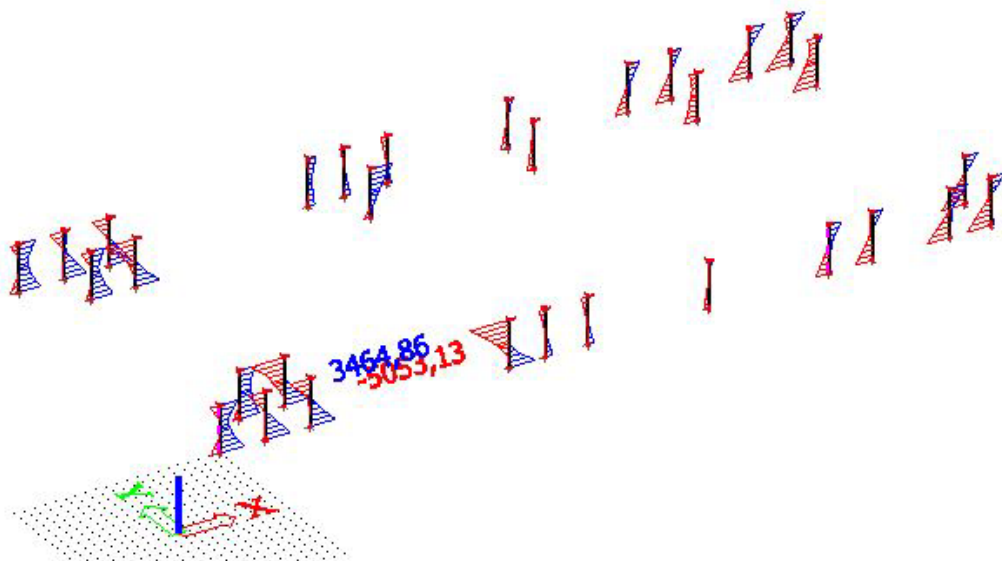

*Slika 5.57. Rezne sile-My*

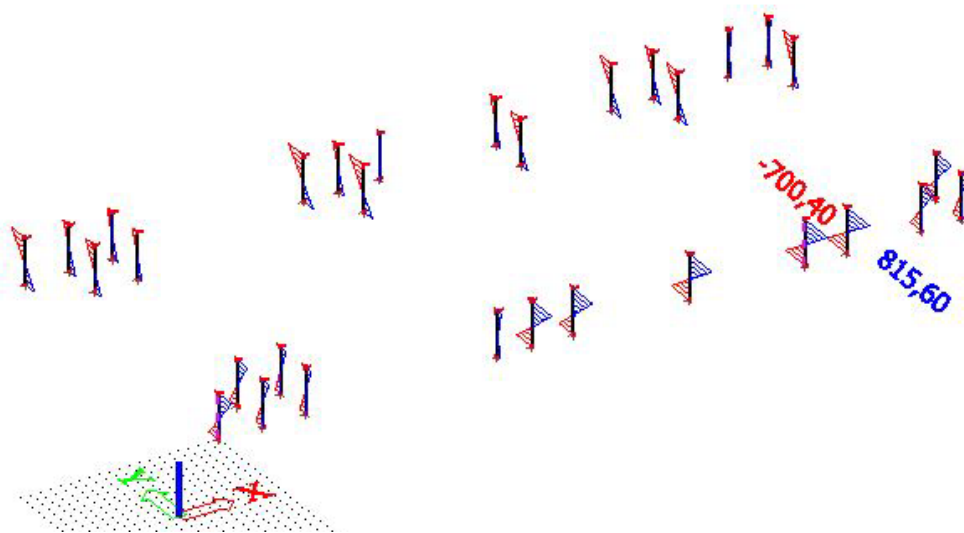

Slika 5.58. Rezne sile- $M_z$

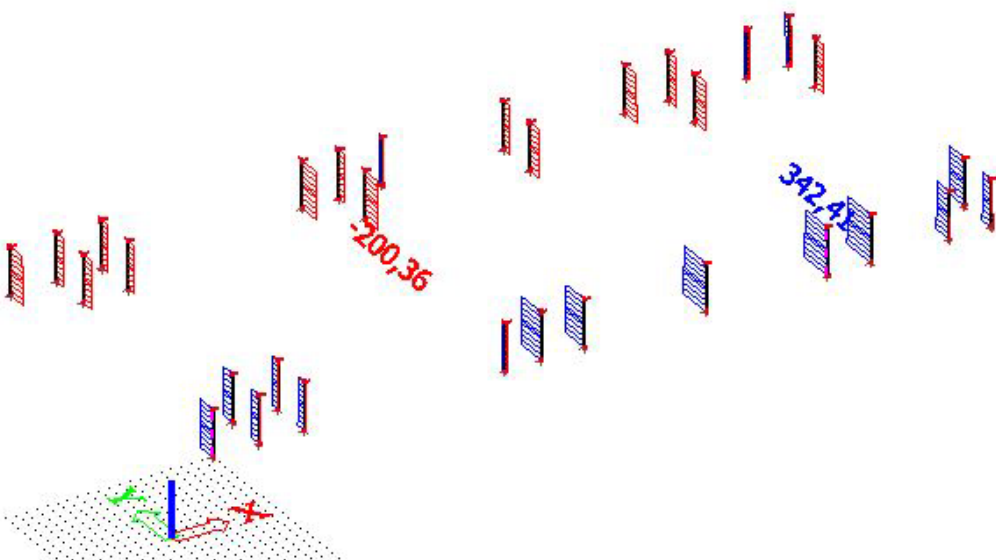

Slika 5.59. Rezne sile- $V_y$

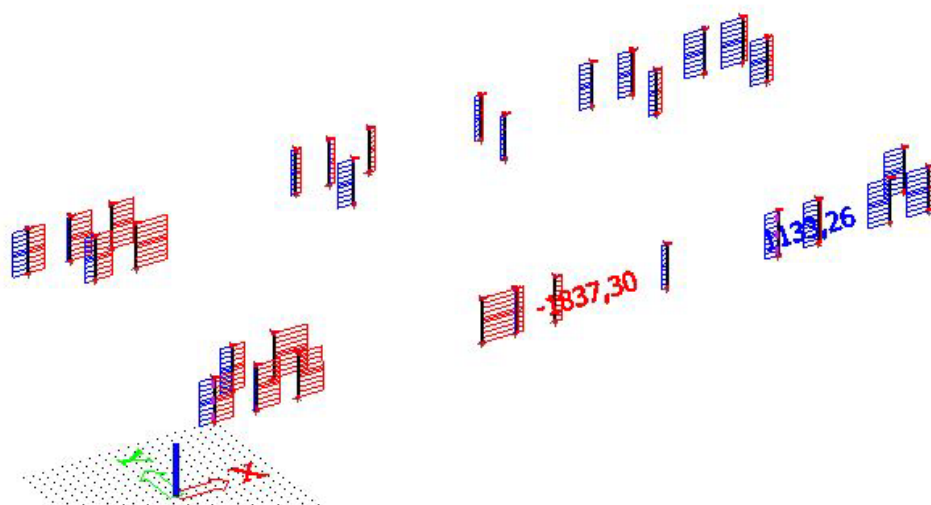

Slika 5.60. Rezne sile- $V_z$

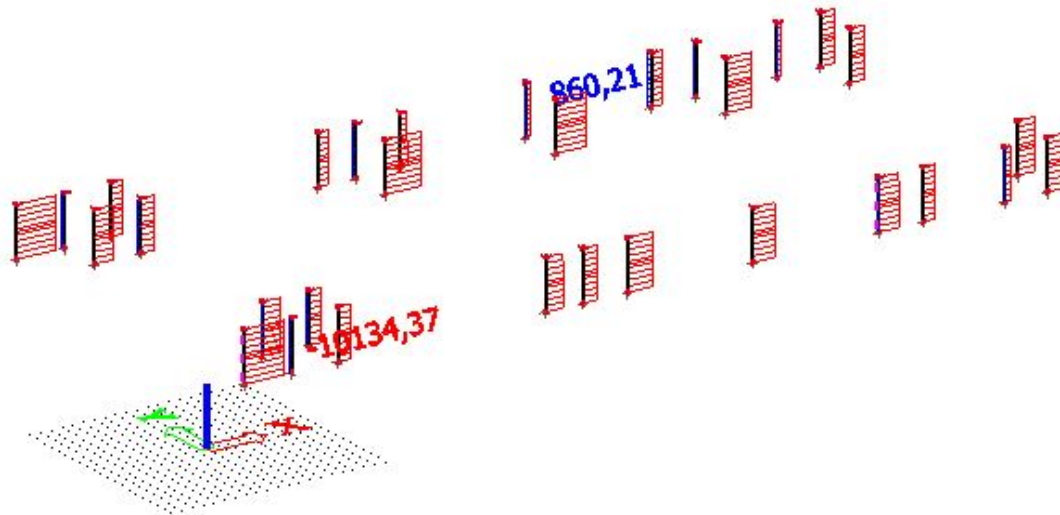

Slika 5.61. Rezne sile-N

Poprečni presjek stupova prizemlja

Name	stupovi prizemlja kompozitni	
Type	type dw	
Detailed	560; 560; 30	
Item material	S 355 C30/37	
Fabrication	concrete	
Flexural buckling y-y	a	
Flexural buckling z-z	a	
Lateral torsional buckling	Default	
Use 2D FEM analysis	<input checked="" type="checkbox"/>	

A [m <sup>2</sup> ]	1,0265e-01	
A y, z [m <sup>2</sup> ]	7,8931e-02	7,8931e-02
I y, z [m <sup>4</sup> ]	3,8006e-03	3,8006e-03
I w [m <sup>6</sup> ], t [m <sup>4</sup> ]	1,0053e-06	6,1026e-03
Wey y, z [m <sup>3</sup> ]	1,3573e-02	1,3573e-02
Wpl y, z [m <sup>3</sup> ]	1,3631e-02	1,3631e-02
d y, z [mm]	0	0
c YUC S, ZUC S [mm]	280	280
α [deg]	0,00	
A L, D [m <sup>2</sup> /m]	2,2400e+00	2,2400e+00
Mply +, - [Nm]	4,84e+06	4,84e+06
Mplz +, - [Nm]	4,84e+06	4,84e+06

Slika 5.62. Prikaz geometrijskih karakteristika stupova prizemlja

Dijagram granične nosivosti stupova

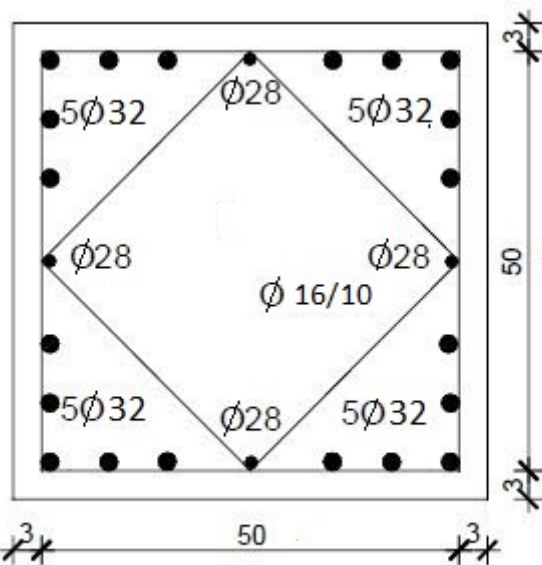
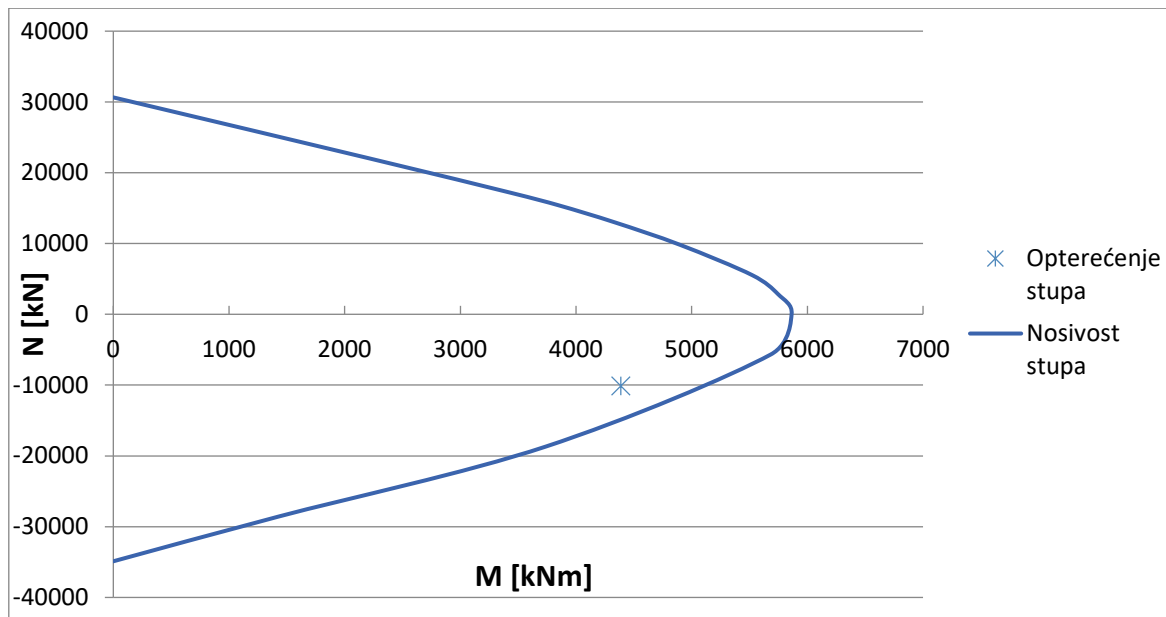

- beton: **C30/37**  
 $f_{ck}=30$  MPa  
 $f_{cd}=30/1,5= 20.00$  Mpa
- armatura : **B 500B**  
 $f_{yk}=500$  MPa  
 $f_{yd}=500/1,15 = 434.78$  Mpa
- čelik: S355

Odabrana glavna armatura :  $20\phi 32 + 4\phi 28$  mm

$$A_s=160,84 \text{ cm}^2 + 24,63 \text{ cm}^2$$

Dimenzioniranje na poprečnu silu:

- armatura : **B 500B**  
 $f_{yk}=500$  MPa  
 $f_{yd}=500/1,15 = 434.78$  Mpa

Dio poprečne sile koju preuzima beton i uzdužna armatura

$$V_{Rd,c} = \left[ C_{Rd,c} \cdot k \cdot (100 \cdot \rho_l \cdot f_{ck})^{1/3} + k_1 \cdot \sigma_{cp} \right] \cdot b_w \cdot d$$

$$b_w = 50 \text{ cm} \quad d = h - d_1 = 50 - 5 = 45 \text{ cm}$$

$$k = 1.0 + \sqrt{\frac{200}{d}} = 1.0 + \sqrt{\frac{200}{450}} = 1.67 < 2.0 \Rightarrow k = 1.67$$

$$k_1 = 0.15$$

$$\sigma_{cp} = N_{Ed}/A_c = \frac{10134,37}{2500} = 4,05 \text{ kN/cm}^2$$

$$C_{Rd,c} = 0.18/\gamma_c = 0.18/1.5 = 0.12$$

$$\sum A_s = 20\Phi 32 + 4\Phi 20 = 160,84 + 24,63 = 185,47 \text{ cm}^2$$

$$\rho_l = \frac{\sum A_s}{A_c} = \frac{185,47}{2500} = 0.07$$

$$V_{Rd,c} = [0.12 \cdot 1.67 \cdot (100 \cdot 0.07 \cdot 30)^{1/3} + 0,15 \cdot 4,05] \cdot 500 \cdot 450 = 404698,94 \text{ N} \\ = 404,7 \text{ kN}$$

$$V_{Rd,c} \geq [v_{\min} + k_1 \cdot \sigma_{cp}] \cdot b_w \cdot d$$

$$k_1 = 0.15, \quad v_{\min} = 0.035 \cdot k^{3/2} \cdot f_{ck}^{1/2} = 0.035 \cdot 1.67^{3/2} \cdot 30^{1/2} = 0.414$$

$$\sigma_{cp} = N_{Ed}/A_c = \frac{10134,37}{2500} = 4,05 \text{ kN/cm}^2$$

$$V_{Rd,c} \geq [0.414 + 0,15 \cdot 4,05] \cdot 500 \cdot 450 = 229837,5 \text{ N} = 229,8 \text{ kN}$$

$$V_{Rd,c} = 404,7 \text{ kN} \geq 229,8 \text{ kN}$$

Nosivost tlačnih dijagonala:

$$V_{Rd,max} = 0.5 \cdot v \cdot b_w \cdot d \cdot f_{cd}$$

$$v = 0.6 \cdot \left[ 1.0 - \frac{f_{ck}}{250} \right] = 0.6 \cdot \left[ 1.0 - \frac{30}{250} \right] = 0.528$$

$$V_{Rd,max} = 0.5 \cdot 0.528 \cdot 20,0 \cdot 500 \cdot 450 = 1188000,0 \text{ N} = 1188,0 \text{ kN} < V_{Ed} = 1837,3 \text{ kN}$$

Potrebna računaska poprečna armatura:

$$\frac{V_{Ed}}{V_{Rd,max}} = \frac{1837,3}{1188,0} \approx 1,55; \quad s_{w,max} = (0,3d; 20\text{cm}) = 13,5 \text{ cm}$$

$$A_{sw,min} = \frac{\rho_{\min} \cdot s_w \cdot b_w}{m} = \frac{0.0011 \cdot 13,5 \cdot 500}{4} = 1.86 \text{ cm}^2$$

Nosivost odabranih spona  $\Phi 16$  ( $A_{sw} = 2.01 \text{ cm}^2$ )

$$s_{w,pot} \leq \frac{m \cdot A_{sw} \cdot f_{yd} \cdot 0.9 \cdot d}{V_{Ed}} = \frac{4 \cdot 2.01 \cdot 43.5 \cdot 0.9 \cdot 45}{1837,3} = 11.66 \text{ cm}$$

**Odabrane spone:  $\varnothing 16/10 \text{ cm}$ ,  $m=4$**

Poprečnu silu preuzeo je armirano betonski poprečni presjek čime smo na strani sigurnosti. U proračunu nije uzeta nosivost čeličnog profila.

## 6. PRORAČUN SPOJEVA

### 6.1. Spoj stup-temelj

Stup - pravokutni čelični profil dimenzija 560x560x30mm

$N = -10134,37 \text{ kN}$   $M = 3122,54 \text{ kNm}$   $V = 962,23 \text{ kN}$

Osnovni materijal:

Čelik S355

$$f_y = 355 \text{ N/mm}^2$$

$$E = 210 \text{ GPa}$$

Vlačna sila od momenta savijanja:

$$N_P^M = \frac{M_{sd}}{h} = \frac{3122,54}{0,53} = 5891,58 \text{ kN}$$

Tlačna sila od uzdužne sile:

$$N_P^N = \frac{A_P}{A} \cdot N_{sd} = -\frac{56 \cdot 3 + 25 \cdot 2 \cdot 3}{2 \cdot (56 \cdot 3 + 50 \cdot 3)} = -5067,19 \text{ kN}$$

Ukupna vlačna sila:

$$N_P = N_P^M + N_P^N = 5891,58 - 5067,19 = 824,39 \text{ kN}$$

Kontrola varova:

Maksimalna debljina vara:

$$a_{max} = 0,7 \cdot t_w = 0,7 \cdot 30 = 21,0 \text{ mm}$$

Za odabrano var  $a = 12,0 \text{ mm}$

Otpornost vara:

$$L_w = 2 \cdot 560 = 1120,0 \text{ mm}$$

$$\text{-uzdužna sila: } F_{w,rd} = \frac{F_{w,rk}}{\gamma_{M1}} \cdot \frac{l}{100} = \frac{392,6}{1,25} \cdot \frac{1120,0}{100} = 3517,7 \text{ kN} > N_{Ed} = 824,39 \text{ kN}$$

$$\text{- poprečna sila: } F_{w,rd} = \frac{F_{w,rk}}{\gamma_{M1}} \cdot \frac{l}{100} = \frac{392,6}{1,25} \cdot \frac{1120,0}{100} = 3517,7 \text{ kN} > V_{Ed} = 962,23 \text{ kN}$$

Pretpostavka vijaka M27 udaljenost  $c_{min}$  vijaka od ruba iznosi:

$$c_{min} = 2d + a\sqrt{2} = 2 \cdot 27 + 12 \cdot 1,41 = 70,92 \text{ mm}$$

-usvojeni  $c = 75 \text{ mm}$

$$\text{-ekscentricitet uzdužne sile } e = \frac{M_{ED}}{N_{ED}} = \frac{3122,54}{10134,37} = 0,31 \text{ m}$$

-ekscentricitet  $x_1 = 75 + 560 - 15 = 620\text{mm} = 0,62\text{ m}$

-ekscentricitet  $x_2 = 31 - \left(\frac{56}{2}\right) = 30\text{mm} = 0,03\text{ m}$

$$F_{t,ed} = N_{ed} \cdot \frac{x_2}{x_1} = 10134,37 \cdot \frac{0,03}{0,62} = 490,37\text{ kN}$$

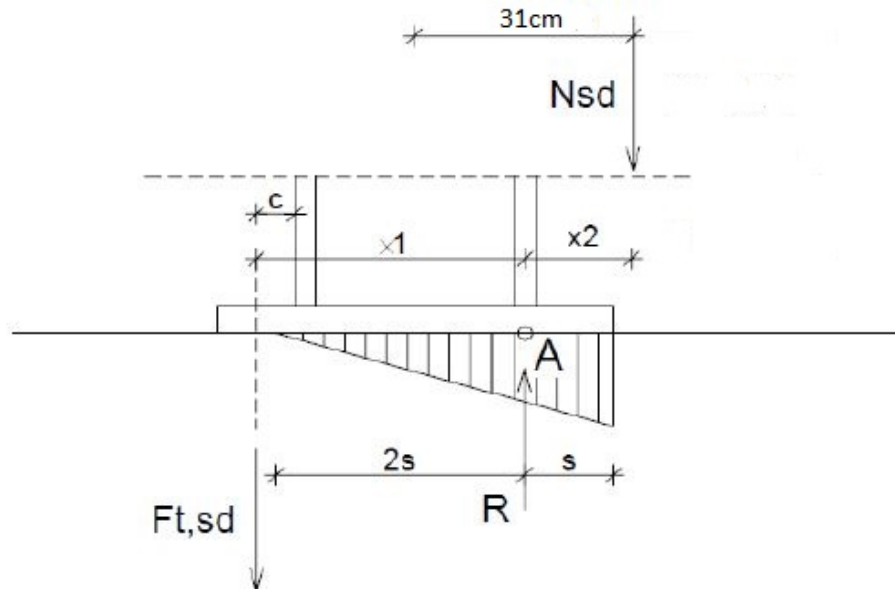

Otpornost vijaka: Pretpostavljeni vijci: M27, k.v.8.8, n=8 vijka

- NA VLAK :

$$F_{t,rd} = \frac{F_{t,rk}}{\gamma_{M1}} = \frac{330,5}{1,25} = 264,4\text{ kN} \geq \frac{F_{t,ed}}{4} = 122,6\text{ kN}$$

- NA POSMIK :

$$F_{v,rd} = \frac{F_{v,rk}}{\gamma_{M1}} = \frac{220,3}{1,25} = 176,24\text{ kN}$$

$$F_{V,Ed} = \frac{V_{Ed}}{8} = 120,3 \leq F_t = 176,24\text{ kN}$$

- NA INTERAKCIJU UZDUŽNE I ODREZNE SILE:

$$\frac{F_{V,Sd}}{F_{V,Rd}} + \frac{F_{t,Sd}}{1,4 \cdot F_{t,Rd}} \leq 1$$

$$\frac{120,3}{176,24} + \frac{122,6}{1,4 \cdot 264,4} = 0,99 < 1$$

→ Vijci zadovoljavaju



Proračun dimenzija ploče:

- pritisak po omotaču rupe osnovnog materijala:

$$F_{V,Ed} = \frac{V_{Ed}}{8} = 120,3 \text{ kN}$$

$$F_{b,Rd} = \frac{F_{b,Rk} t_{pl}}{1,25 \cdot 10}$$

$$t_{pl} = 120,3 \cdot \frac{12,5}{258,2} = 5,8 \text{ mm}$$

- udaljenost  $c_{min}$  vijaka od ruba:  $c = 70,92 \text{ mm}$

Usvojeni  $c=75,0 \text{ mm}$

$$a_{pl}^{min} = h + 2 \cdot (c + e_1 + p_1) = 560 + 2 \cdot (75 + 70 + 90) = 1030 \text{ mm}$$

$$b_{pl}^{min} = 2e + p_2 = 2 \cdot 55 + 90 = 200 \text{ mm}$$

$$b_{pl}^{min} = b + 2 \cdot a\sqrt{2} + 27 = 560 + 2 \cdot 12\sqrt{2} + 27 = 620,94 \text{ mm}$$

→ Odabrane dimenzije širine i dužine ploče su 1030 x 820 mm

$$M_{Ed} = F_{t,Ed} \cdot (c + t_f/2) = 490,37 \cdot (0,09) = 44,13 \text{ kNm}$$

$$M_{Ed} \leq \frac{W_{min} \cdot f_y}{\gamma_M} \Rightarrow W_{min} = \frac{1,1 \cdot M_{Ed}}{f_y} = \frac{b_{pl} \cdot t_{pl}^2}{6}$$

$$\Rightarrow t_{pl}^{min} = \sqrt{\frac{1,1 \cdot 44,13 \cdot 6}{82 \cdot 35,5}} = 3,16 \text{ cm}$$

→ Odabrana debljina ploče je 32 mm

**Usvojene dimenzije ploče: 1030x820x32 mm**

Duljina sidrenja ankera:  $30\Phi=30 \cdot 28=840 \text{ mm}=84 \text{ cm}$

## 6.2. Spoj stup rampe-temelj

Project:  
Project no:  
Author:



### Project item Con N510

#### Design

Name: Con N510  
Description:  
Analysis: Stress, strain/ loads in equilibrium

#### Beams and columns

Name	Cross-section	$\beta$ - Direction [°]	$\gamma$ - Pitch [°]	$\alpha$ - Rotation [°]	Offset ex [mm]	Offset ey [mm]	Offset ez [mm]	Forces in
B616	1 - HEA200A	71,6	-90,0	108,4	0	0	0	Position

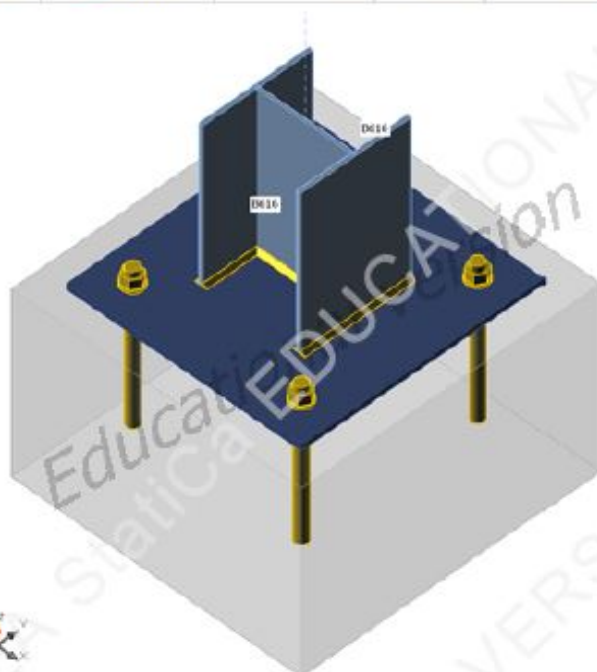

#### Cross-sections

Name	Material
1 - HEA200A	S 355

#### Anchors

Name	Bolt assembly	Diameter [mm]	$f_u$ [MPa]	Gross area [mm <sup>2</sup> ]
M22 8.8	M22 8.8	22	800,0	380

#### Load effects (forces in equilibrium)

Name	Member	N [kN]	Vy [kN]	Vz [kN]	Mx [kNm]	My [kNm]	Mz [kNm]
GSN16(9)	B616	-182,0	-1,6	-4,7	0,0	9,0	0,0

Project:  
Project no:  
Author:



### Foundation block

Item	Value	Unit
<b>CB 1</b>		
Dimensions	540 x 526	mm
Depth	350	mm
Anchor	M22 8.8	
Anchoring length	250	mm
Shear force transfer	Friction	

### Check

### Summary

Name	Value	Status
Analysis	100,0%	OK
Plates	0,0 < 5%	OK
Anchors	1,0 < 100%	OK
Welds	35,7 < 100%	OK
Concrete block	21,9 < 100%	OK
Shear	10,3 < 100%	OK
Buckling	Not calculated	

### Plates

Name	Thickness [mm]	Loads	$\sigma_{Ed}$ [MPa]	$\epsilon_{pl}$ [%]	Status
B616-bf 1	8,0	GSN16(9)	112,7	0,0	OK
B616-tf 1	8,0	GSN16(9)	30,9	0,0	OK
B616-w 1	5,5	GSN16(9)	67,4	0,0	OK
BP1	10,0	GSN16(9)	84,5	0,0	OK

### Design data

Material	$f_y$ [MPa]	$\epsilon_{lim}$ [1e-4]
S 355	355,0	500,0

### Symbol explanation

$\epsilon_{pl}$	Strain
$\sigma_{Ed}$	Eq. stress
$f_y$	Yield strength
$\epsilon_{lim}$	Limit of plastic strain

Project:  
Project no:  
Author:

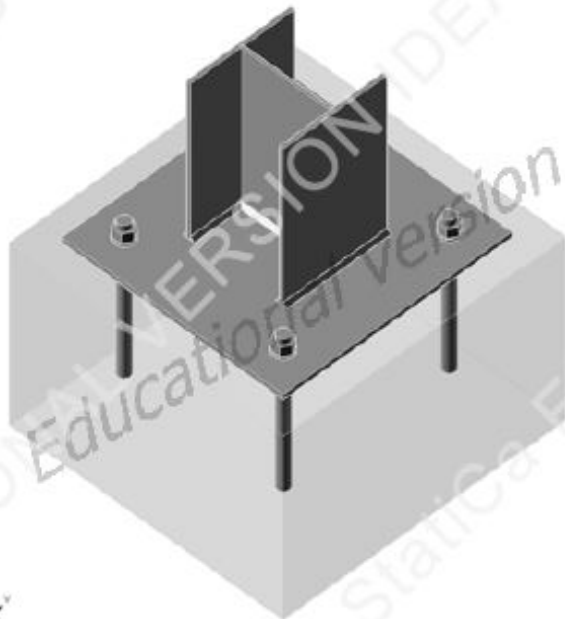

Overall check, GSN16(9)

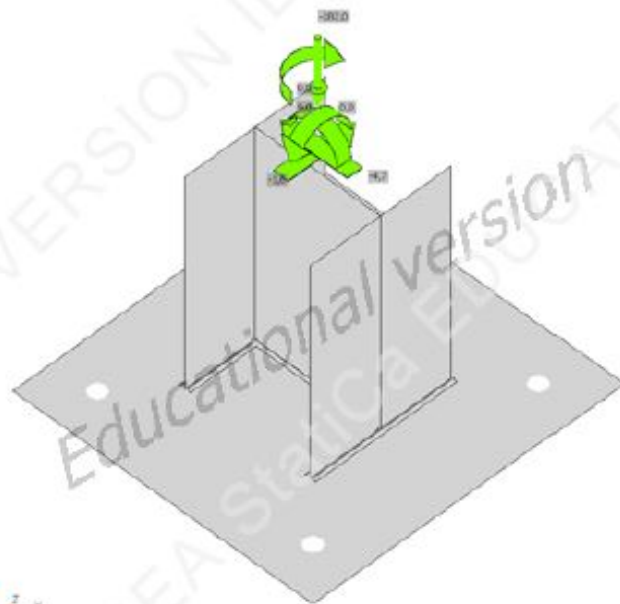

Strain check, GSN16(9)



Project:  
Project no:  
Author:

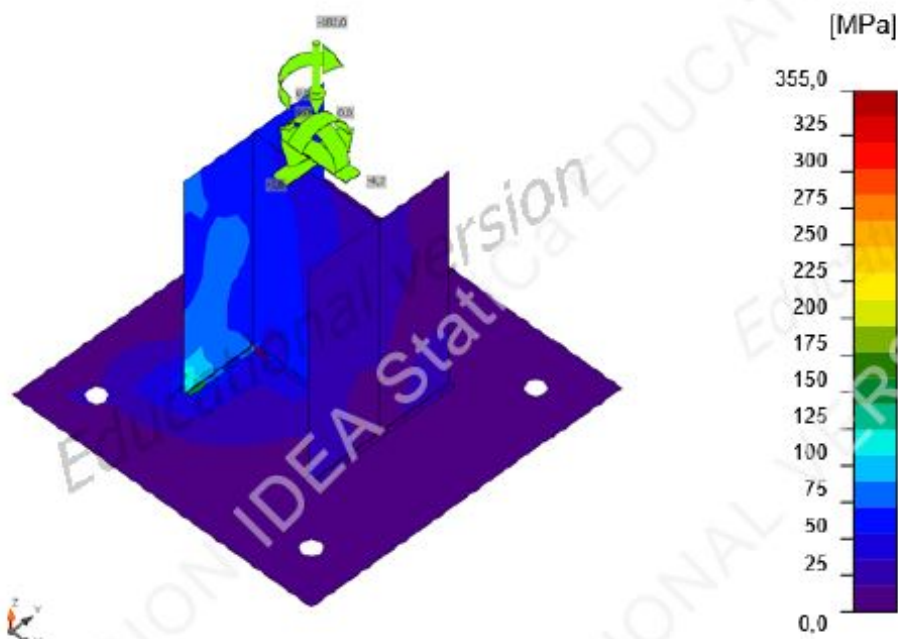

Equivalent stress, GSN16(9)

**Anchors**

	Name	Loads	$F_{t,Ed}$ [kN]	V [kN]	$N_{rdc}$ [kN]	$N_{rdp}$ [kN]	$U_t$ [%]	$F_{b,Rd}$ [kN]	$U_s$ [%]	$U_{ts}$ [%]	$V_{Rd,cp}$ [kN]	$V_{Rd,c}$ [kN]	Status
	A1	GSN16(9)	0,3	0,0	0,0	0,0	0,2	215,6	0,0	0,0	0,0	0,0	OK
	A2	GSN16(9)	0,3	0,0	0,0	0,0	0,2	215,6	0,0	0,0	0,0	0,0	OK
	A3	GSN16(9)	1,4	0,0	0,0	0,0	1,0	215,6	0,0	0,0	0,0	0,0	OK
	A4	GSN16(9)	1,4	0,0	0,0	0,0	0,9	215,6	0,0	0,0	0,0	0,0	OK

**Design data**

Name	$F_{t,Rd}$ [kN]	$B_{p,Rd}$ [kN]	$F_{v,Rd}$ [kN]	$V_{rds}$ [kN]	$S_{tr}$ [MN/m]
M22 8.8 - 1	148,3	254,9	116,4	0,0	453

Project:  
Project no:  
Author:



### Symbol explanation

$F_{t,Rd}$	Bolt tension resistance EN 1993-1-8 tab. 3.4
$F_{t,Ed}$	Tension force
$B_{p,Rd}$	Punching shear resistance
$V$	Resultant of shear forces $V_y, V_z$ in bolt
$F_{v,Rd}$	Bolt shear resistance EN_1993-1-8 table 3.4
$V_{rds}$	Characteristic anchor resistance ETAG 001 Annex C (5.2.3.2)
$S_{tf}$	Anchor longitudinal stiffness
$F_{b,Rd}$	Plate bearing resistance EN 1993-1-8 tab. 3.4
$N_{rd,c}$	Concrete breakout resistance
$N_{rd,p}$	Pull-out resistance
$U_t$	Utilization in tension
$U_s$	Utilization in shear
$U_{ts}$	Utilization in tension and shear EN 1993-1-8 table 3.4
$V_{rd,cp}$	Concrete pry-out failure ETAG 001 Annex C (5.2.3.3)
$V_{rd,c}$	Concrete edge failure ETAG 001 Annex C (5.2.3.4)
$C_{pf}$	Concrete pry-out failure ETAG 001 Annex C (5.2.3.3)
$C_{ef}$	Concrete edge failure ETAG 001 Annex C (5.2.3.4)

### Welds (Plastic redistribution)

Item	Edge	Throat th. [mm]	Length [mm]	Loads	$\sigma_{w,Ed}$ [MPa]	$\epsilon_{pl}$ [%]	$\sigma_{\perp}$ [MPa]	$\tau_{\parallel}$ [MPa]	$\tau_{\perp}$ [MPa]	$U_t$ [%]	$U_c$ [%]	Status
BP1	B616-bfl 1	▲5,0▲	200	GSN16(9)	155,4	0,0	-60,5	54,5	-62,1	35,7	23,6	OK
		▲5,0▲	200	GSN16(9)	151,9	0,0	-59,9	-55,6	58,3	34,9	21,1	OK
BP1	B616-tfl 1	▲5,0▲	200	GSN16(9)	36,1	0,0	-15,1	-13,4	-13,3	8,3	5,1	OK
		▲5,0▲	200	GSN16(9)	30,6	0,0	-10,8	10,7	12,5	7,0	4,1	OK
BP1	B616-w 1	▲5,0▲	178	GSN16(9)	61,7	0,0	-28,8	12,6	-28,9	14,2	7,5	OK
		▲5,0▲	178	GSN16(9)	61,6	0,0	-28,8	-12,6	28,8	14,1	7,5	OK

### Design data

	$\beta_w$ [-]	$\sigma_{w,Rd}$ [MPa]	$0.9 \sigma$ [MPa]
S 355	0,90	435,6	352,8

### Symbol explanation

$\epsilon_{pl}$	Strain
$\sigma_{w,Ed}$	Equivalent stress
$\sigma_{w,Rd}$	Equivalent stress resistance
$\sigma_{\perp}$	Perpendicular stress
$\tau_{\parallel}$	Shear stress parallel to weld axis
$\tau_{\perp}$	Shear stress perpendicular to weld axis
$0.9 \sigma$	Perpendicular stress resistance - $0.9 \cdot f_u / \gamma_{M2}$
$\beta_w$	Correlation factor EN 1993-1-8 tab. 4.1
$U_t$	Utilization
$U_c$	Weld capacity utilization

Project:  
Project no:  
Author:



### Concrete block

Item	Loads	c [mm]	A <sub>eff</sub> [mm <sup>2</sup> ]	σ [MPa]	K <sub>j</sub> [-]	F <sub>Jd</sub> [MPa]	Ut [%]	Status
CB 1	GSN16(9)	19	26283	7,3	3,00	33,5	21,9	OK

### Symbol explanation

c	Bearing width
A <sub>eff</sub>	Effective area
σ	Average stress in concrete
K <sub>j</sub>	Concentration factor
F <sub>Jd</sub>	The ultimate bearing strength of the concrete block
Ut	Utilization

### Shear in contact plane

Name	Loads	V <sub>y</sub> [kN]	V <sub>z</sub> [kN]	V <sub>Rd,y</sub> [kN]	V <sub>Rd,z</sub> [kN]	V <sub>c,Rd</sub> [kN]	Ut [%]	Status
BP1	GSN16(9)	-1,5	-4,7	48,2	48,2	0,0	10,3	OK

### Symbol explanation

V <sub>y</sub>	Shear force in base plate V <sub>y</sub>
V <sub>z</sub>	Shear force in base plate V <sub>z</sub>
V <sub>Rd,y</sub>	Shear resistance
V <sub>Rd,z</sub>	Shear resistance
V <sub>c,Rd</sub>	Concrete bearing resistance
Ut	Utilization

### Buckling

Buckling analysis was not calculated.

### Code settings

Item	Value	Unit	Reference
Y <sub>M0</sub>	1,00	-	EN 1993-1-1: 6.1
Y <sub>M1</sub>	1,00	-	EN 1993-1-1: 6.1
Y <sub>M2</sub>	1,25	-	EN 1993-1-1: 6.1
Y <sub>M3</sub>	1,25	-	EN 1993-1-8: 2.2
Y <sub>C</sub>	1,50	-	EN 1992-1-1: 2.4.2.4
Y <sub>inst</sub>	1,20	-	ETAG 001-C: 3.2.1
Joint coefficient β <sub>j</sub>	0,67	-	EN 1993-1-8: 6.2.5
Effective area - influence of mesh size	0,10	-	
Friction coefficient - concrete	0,25	-	EN 1993-1-8
Friction coefficient in slip-resistance	0,30	-	EN 1993-1-8 tab 3.7
Limit plastic strain	0,05	-	EN 1993-1-5
Weld stress evaluation	Plastic redistribution		
Detailing	No		
Distance between bolts [d0]	2,20	-	EN 1993-1-8: tab 3.3

Project:  
 Project no:  
 Author:



Item	Value	Unit	Reference
Distance between bolts and edge [d0]	1,20	-	EN 1993-1-8; tab 3.3
Concrete breakout resistance	Yes		ETAG 001-C
Use calculated ab in bearing check.	Yes		EN 1993-1-8; tab 3.4
Cracked concrete	Yes		



### 6.3. Spoj glavnih nosača krova

Project:  
Project no:  
Author:



#### Project item Con N247

#### Design

Name: Con N247  
Description:  
Analysis: Stress, strain/ loads in equilibrium

#### Beams and columns

Name	Cross-section	$\beta$ - Direction [°]	$\gamma$ - Pitch [°]	$\alpha$ - Rotation [°]	Offset ex [mm]	Offset ey [mm]	Offset ez [mm]	Forces in
B383	2 - HL920X449	-90,0	0,0	0,0	0	0	0	Position
B389	4 - HL920X449	180,0	0,0	0,0	0	0	0	Position
B388	5 - HL920X449	0,0	0,0	0,0	0	0	0	Position

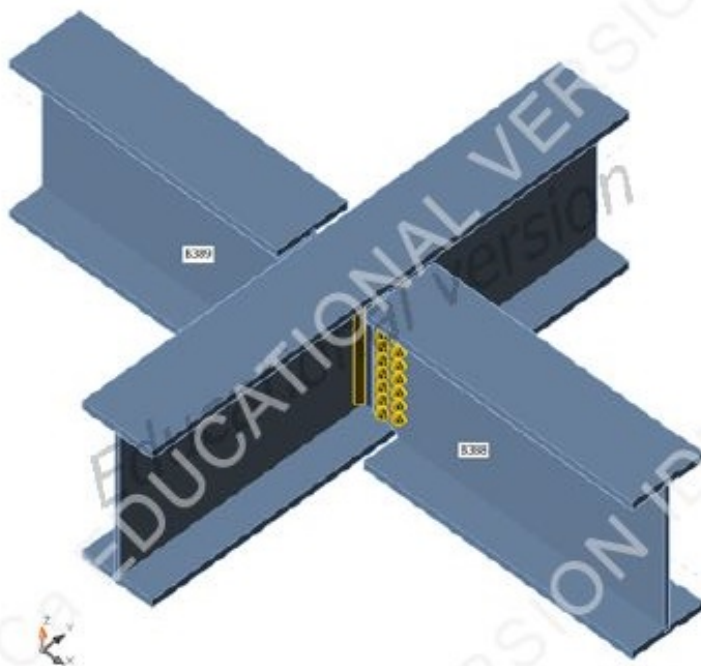

#### Cross-sections

Name	Material
2 - HL920X449	S 355
4 - HL920X449	S 355
5 - HL920X449	S 355

#### Bolts

Name	Bolt assembly	Diameter [mm]	$f_u$ [MPa]	Gross area [mm <sup>2</sup> ]
M30 10.9	M30 10.9	30	1000,0	707

Project:  
Project no:  
Author:



### Load effects (forces in equilibrium)

Name	Member	N [kN]	Vy [kN]	Vz [kN]	Mx [kNm]	My [kNm]	Mz [kNm]
GSN7(68)	B383	236,3	-8,0	-61,1	-4,5	249,1	3,1
	B383	-240,0	6,6	-36,0	-4,7	-252,4	2,8
	B389	-121,0	-1,5	-4,1	-1,5	-583,6	-0,4
	B388	-121,1	-7,4	127,2	1,8	-592,8	-5,5

### Check

#### Summary

Name	Value	Status
Analysis	100,0%	OK
Plates	0,2 < 5%	OK
Bolts	99,9 < 100%	OK
Welds	45,9 < 100%	OK
Buckling	Not calculated	

#### Plates

Name	Material	Thickness [mm]	Loads	$\sigma_{Ed}$ [MPa]	$\epsilon_{pl}$ [%]	Status
B383-bfl 1	S 355	47,0	GSN7(68)	17,5	0,0	OK
B383-tf 1	S 355	47,0	GSN7(68)	31,5	0,0	OK
B383-w 1	S 355 - 1	25,9	GSN7(68)	43,6	0,0	OK
B389-bfl 1	S 355	47,0	GSN7(68)	68,3	0,0	OK
B389-tf 1	S 355	47,0	GSN7(68)	67,4	0,0	OK
B389-w 1	S 355 - 1	25,9	GSN7(68)	355,4	0,2	OK
B388-bfl 1	S 355	47,0	GSN7(68)	66,3	0,0	OK
B388-tf 1	S 355	47,0	GSN7(68)	60,3	0,0	OK
B388-w 1	S 355 - 1	25,9	GSN7(68)	355,4	0,2	OK
FP1	S 355 - 1	25,0	GSN7(68)	355,2	0,1	OK
FP2	S 355 - 1	25,0	GSN7(68)	355,3	0,1	OK

#### Design data

Material	$f_y$ [MPa]	$\epsilon_{lim}$ [1e-4]
S 355	335,0	500,0
S 355 - 1	355,0	500,0

#### Symbol explanation

$\epsilon_{pl}$	Strain
$\sigma_{Ed}$	Eq. stress
$f_y$	Yield strength
$\epsilon_{lim}$	Limit of plastic strain

Project:  
Project no:  
Author:

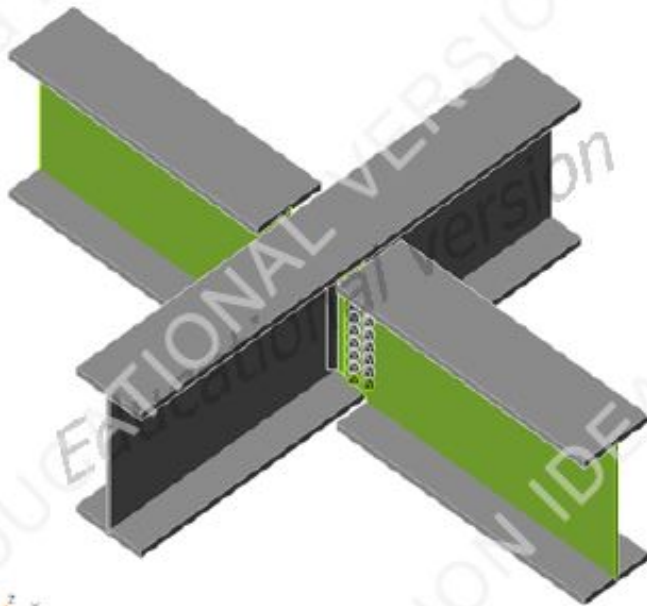

Overall check, GSN7(68)

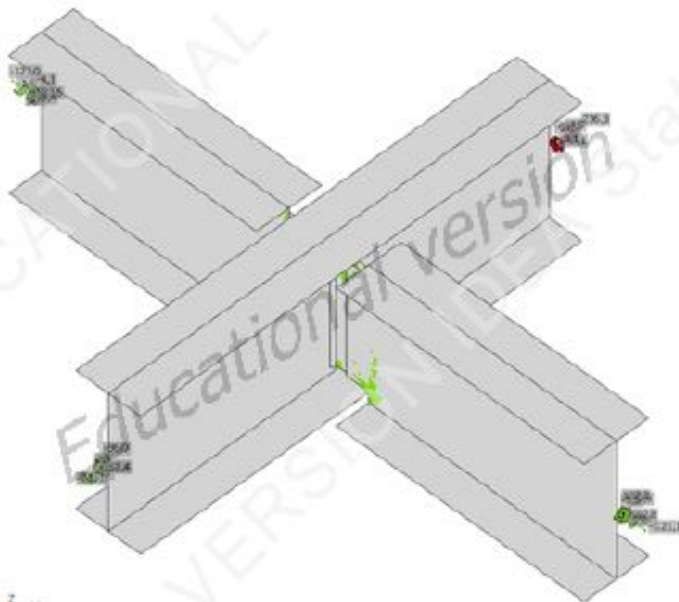

Strain check, GSN7(68)



Project:  
Project no:  
Author:

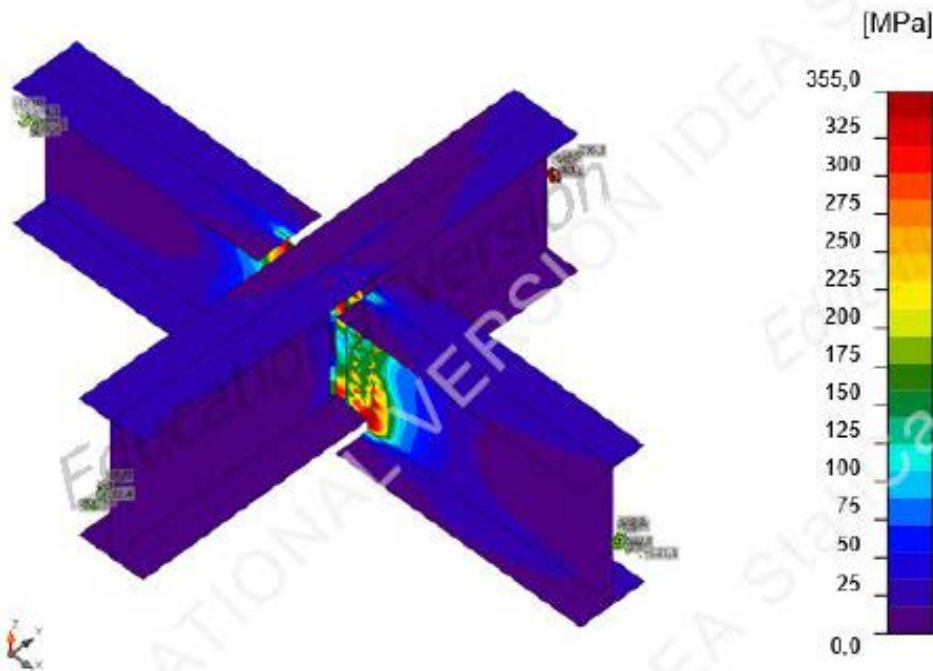

Equivalent stress, GSN7(68)

Project:  
Project no:  
Author:



**Bolts**

Name	Loads	$F_{t,Ed}$ [kN]	V [kN]	$U_{t,t}$ [%]	$F_{b,Rd}$ [kN]	$U_{t,s}$ [%]	$U_{t,s}$ [%]	Status
B1	GSN7(68)	3,9	89,0	1,0	735,0	39,7	40,4	OK
B2	GSN7(68)	10,0	80,6	2,5	735,0	35,9	37,7	OK
B3	GSN7(68)	17,7	133,4	4,4	735,0	59,5	62,6	OK
B4	GSN7(68)	28,2	211,8	7,0	638,0	94,4	99,4	OK
B5	GSN7(68)	41,8	206,4	10,4	735,0	92,0	99,4	OK
B6	GSN7(68)	0,9	152,1	0,2	615,9	67,8	68,0	OK
B7	GSN7(68)	0,0	224,2	0,0	615,9	99,9	99,9	OK
B8	GSN7(68)	13,5	218,6	3,3	735,0	97,4	99,8	OK
B9	GSN7(68)	7,7	69,0	1,9	410,2	30,7	32,1	OK
B10	GSN7(68)	8,4	112,5	2,1	735,0	50,1	51,6	OK
B11	GSN7(68)	15,2	192,9	3,8	638,0	86,0	88,7	OK
B12	GSN7(68)	10,5	219,7	2,6	638,0	97,9	99,8	OK
B13	GSN7(68)	39,9	207,7	9,9	498,0	92,5	99,6	OK
B14	GSN7(68)	18,3	97,3	4,5	735,0	43,3	46,6	OK
B15	GSN7(68)	28,8	164,8	7,1	615,9	73,5	78,5	OK
B16	GSN7(68)	25,5	213,1	6,3	598,9	94,9	99,5	OK
B17	GSN7(68)	9,6	220,2	2,4	397,5	98,1	99,8	OK

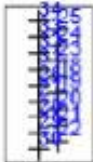

B18	GSN7(68)	4,8	72,1	1,2	735,0	21,3	22,1	OK
B19	GSN7(68)	10,8	70,1	2,7	735,0	20,6	22,6	OK
B20	GSN7(68)	18,2	105,3	4,5	735,0	31,0	34,2	OK
B21	GSN7(68)	26,2	160,8	6,5	638,0	47,4	52,0	OK
B22	GSN7(68)	60,6	236,7	15,0	638,0	69,8	80,5	OK
B23	GSN7(68)	1,1	110,7	0,3	735,0	32,6	32,8	OK
B24	GSN7(68)	0,1	160,0	0,0	615,9	49,8	49,8	OK
B25	GSN7(68)	12,4	247,3	3,1	615,9	72,9	75,1	OK
B26	GSN7(68)	6,9	42,4	1,7	410,2	12,5	13,7	OK
B27	GSN7(68)	11,6	65,9	2,9	735,0	19,4	21,5	OK
B28	GSN7(68)	19,3	115,3	4,8	615,9	34,0	37,4	OK
B29	GSN7(68)	21,3	176,5	5,3	594,4	52,0	55,8	OK
B30	GSN7(68)	11,3	251,9	2,8	395,6	74,2	76,2	OK
B31	GSN7(68)	11,8	76,6	2,9	735,0	22,6	24,7	OK
B32	GSN7(68)	19,8	133,9	4,9	638,0	39,5	43,0	OK
B33	GSN7(68)	16,8	201,5	4,2	735,0	59,4	62,4	OK
B34	GSN7(68)	51,4	280,7	12,7	498,0	82,7	91,8	OK

**Design data**

Name	$F_{t,Rd}$ [kN]	$B_{p,Rd}$ [kN]	$F_{v,Rd}$ [kN]
M30 10.9 - 1	403,9	973,2	224,4

**Symbol explanation**

$F_{t,Rd}$	Bolt tension resistance EN 1993-1-8 tab. 3.4
$F_{t,Ed}$	Tension force
$B_{p,Rd}$	Punching shear resistance
V	Resultant of shear forces $V_y$ , $V_z$ in bolt
$F_{v,Rd}$	Bolt shear resistance EN_1993-1-8 table 3.4
$F_{b,Rd}$	Plate bearing resistance EN 1993-1-8 tab. 3.4
$U_t$	Utilization in tension
$U_s$	Utilization in shear
$U_{ts}$	Utilization in tension and shear EN 1993-1-8 table 3.4

**Welds (Plastic redistribution)**

Item	Edge	Throat th. [mm]	Length [mm]	Loads	$\sigma_{w,Ed}$ [MPa]	$\epsilon_{pI}$ [%]	$\sigma_{\perp}$ [MPa]	$\tau_{\parallel}$ [MPa]	$\tau_{\perp}$ [MPa]	$U_t$ [%]	$U_c$ [%]	Status
B383-w 1	FP1	▲24,0▲	782	GSN7(68)	121,4	0,0	-56,4	-14,9	-59,6	27,9	17,7	OK
		▲24,0▲	782	GSN7(68)	182,4	0,0	-93,2	7,5	90,2	41,9	23,9	OK
B383-w 1	FP2	▲24,0▲	782	GSN7(68)	126,7	0,0	61,0	-8,9	-63,5	29,1	17,6	OK
		▲24,0▲	782	GSN7(68)	200,1	0,0	-105,5	22,6	-95,5	45,9	23,7	OK

**Design data**

	$\beta_w$ [-]	$\sigma_{w,Rd}$ [MPa]	$0,9 \sigma$ [MPa]
S 355	0,90	435,6	352,8

**Symbol explanation**

$\epsilon_{pl}$	Strain
$\sigma_{w,Ed}$	Equivalent stress
$\sigma_{w,Rd}$	Equivalent stress resistance
$\sigma_{\perp}$	Perpendicular stress
$\tau_{  }$	Shear stress parallel to weld axis
$\tau_{\perp}$	Shear stress perpendicular to weld axis
$0.9 \sigma$	Perpendicular stress resistance - $0.9 \cdot f_u \gamma_{M2}$
$\beta_w$	Correlation factor EN 1993-1-8 tab. 4.1
$U_t$	Utilization
$U_{tc}$	Weld capacity utilization

**Buckling**

Buckling analysis was not calculated.

**Code settings**

Item	Value	Unit	Reference
$Y_{M0}$	1,00	-	EN 1993-1-1: 6.1
$Y_{M1}$	1,00	-	EN 1993-1-1: 6.1
$Y_{M2}$	1,25	-	EN 1993-1-1: 6.1
$Y_{M3}$	1,25	-	EN 1993-1-8: 2.2

Item	Value	Unit	Reference
$Y_c$	1,50	-	EN 1992-1-1: 2.4.2.4
$Y_{inst}$	1,20	-	ETAG 001-C: 3.2.1
Joint coefficient $\beta_j$	0,67	-	EN 1993-1-8: 6.2.5
Effective area - influence of mesh size	0,10	-	
Friction coefficient - concrete	0,25	-	EN 1993-1-8
Friction coefficient in slip-resistance	0,30	-	EN 1993-1-8 tab 3.7
Limit plastic strain	0,05	-	EN 1993-1-5
Weld stress evaluation	Plastic redistribution		
Detailing	No		
Distance between bolts $[d_0]$	2,20	-	EN 1993-1-8: tab 3.3
Distance between bolts and edge $[d_0]$	1,20	-	EN 1993-1-8: tab 3.3
Concrete breakout resistance	Yes		ETAG 001-C
Use calculated $\sigma_b$ in bearing check.	Yes		EN 1993-1-8: tab 3.4
Cracked concrete	Yes		

## 6.4. Spoj glavnih nosača sa dijagonalama

Project:  
Project no:  
Author:



### Project item Con N183

#### Design

Name: Con N183  
Description:  
Analysis: Stress, strain/ loads in equilibrium

#### Beams and columns

Name	Cross-section	$\beta$ - Direction [°]	$\gamma$ - Pitch [°]	$\alpha$ - Rotation [°]	Offset ex [mm]	Offset ey [mm]	Offset ez [mm]	Forces in
B572	3 - HL920X449	-90,0	0,0	0,0	0	0	0	Position
B279	1 - HEM360	90,0	52,1	0,0	0	0	0	Position
B278	1 - HEM360	-90,0	52,0	0,0	0	0	0	Position



#### Cross-sections

Name	Material
3 - HL920X449	S 355
1 - HEM360	S 355

#### Bolts

Name	Bolt assembly	Diameter [mm]	$f_u$ [MPa]	Gross area [mm <sup>2</sup> ]
M48 10.9	M48 10.9	48	1000,0	1810

Project:  
Project no:  
Author:



### Load effects (forces in equilibrium)

Name	Member	N [kN]	Vy [kN]	Vz [kN]	Mx [kNm]	My [kNm]	Mz [kNm]
GSN4(2)	B572	596,9	-2,5	-20,1	10,2	42,0	-78,5
	B572	-590,2	-1,1	-26,2	7,6	-43,4	77,2
	B279	24,8	-19,8	-10,7	0,6	14,7	-24,2
	B278	36,9	19,9	-10,7	-0,6	14,5	17,7

### Check

#### Summary

Name	Value	Status
Analysis	100,0%	OK
Plates	3,6 < 5%	OK
Bolts	96,9 < 100%	OK
Welds	63,7 < 100%	OK
Buckling	Not calculated	

#### Plates

Name	Material	Thickness [mm]	Loads	$\sigma_{Ed}$ [MPa]	$\epsilon_{p1}$ [%]	Status
B572-bfl 1	S 355	42,7	GSN4(2)	95,5	0,0	OK
B572-tfl 1	S 355	42,7	GSN4(2)	60,6	0,0	OK
B572-w 1	S 355 - 1	24,0	GSN4(2)	154,9	0,0	OK
B279-bfl 1	S 355	40,0	GSN4(2)	10,0	0,0	OK
B279-tfl 1	S 355	40,0	GSN4(2)	10,1	0,0	OK
B279-w 1	S 355 - 1	21,0	GSN4(2)	6,1	0,0	OK
B278-bfl 1	S 355	40,0	GSN4(2)	116,5	0,0	OK
B278-tfl 1	S 355	40,0	GSN4(2)	100,8	0,0	OK
B278-w 1	S 355 - 1	21,0	GSN4(2)	124,3	0,0	OK
CPL1a	S 355 - 1	27,0	GSN4(2)	199,4	0,0	OK
CPL1b	S 355 - 1	27,0	GSN4(2)	5,5	0,0	OK
CPL1c	S 355 - 1	27,0	GSN4(2)	145,9	0,0	OK
CPL2a	S 355 - 1	27,0	GSN4(2)	361,8	3,2	OK
CPL2b	S 355 - 1	27,0	GSN4(2)	142,3	0,0	OK
CPL2c	S 355 - 1	27,0	GSN4(2)	362,7	3,6	OK

#### Design data

Material	$f_y$ [MPa]	$\epsilon_{lim}$ [1e-4]
S 355	335,0	500,0
S 355 - 1	355,0	500,0



Project:  
Project no:  
Author:



Symbol explanation

$\epsilon_{pl}$	Strain
$\sigma_{Ed}$	Eq. stress
$f_y$	Yield strength
$\epsilon_{lim}$	Limit of plastic strain



Overall check, GSN1(2)

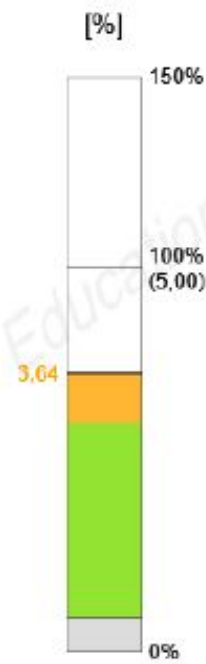

Project:  
Project no:  
Author:



Strain check, GSN4(2)

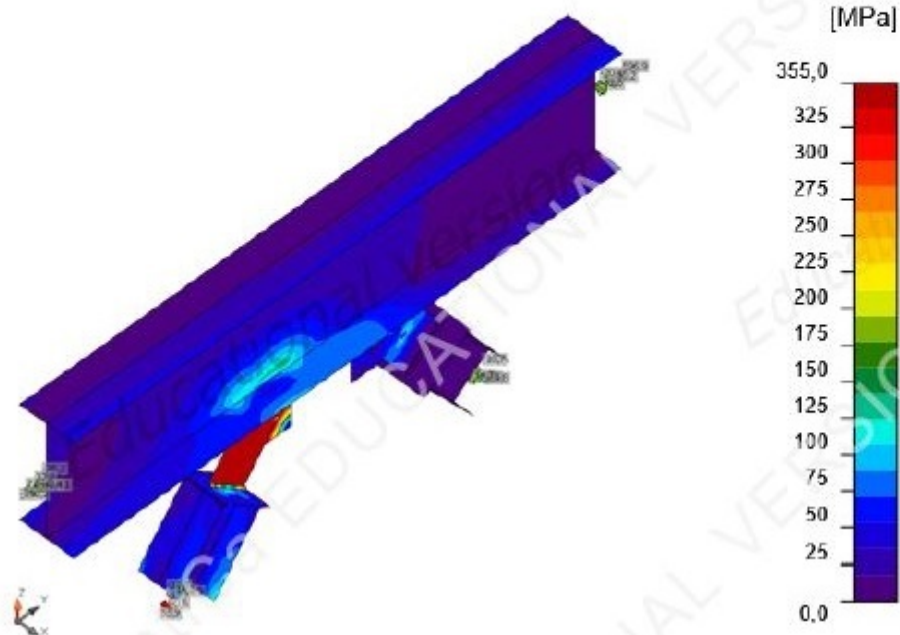

Equivalent stress, GSN4(2)

**Bolts**

	Name	Loads	$F_{t,Ed}$ [kN]	V [kN]	$U_{t1}$ [%]	$F_{b,Rd}$ [kN]	$U_{t2}$ [%]	$U_{t12}$ [%]	Status
	B1	GSN4(2)	29,2	32,7	2,8	809,9	5,6	7,5	OK
	B2	GSN4(2)	61,8	49,7	5,8	1146,2	8,5	12,6	OK
	B3	GSN4(2)	219,8	505,9	20,8	809,9	86,0	96,9	OK
	B4	GSN4(2)	321,9	462,2	30,4	809,9	78,6	96,3	OK

**Design data**

Name	$F_{t,Rd}$ [kN]	$B_{p,Rd}$ [kN]	$F_{v,Rd}$ [kN]
M48 10.9 - 1	1058,4	1586,1	588,0

Project:  
Project no:  
Author:

**Symbol explanation**

$F_{t,Rd}$	Bolt tension resistance EN 1993-1-8 tab. 3.4
$F_{t,Ed}$	Tension force
$B_{p,Rd}$	Punching shear resistance
$V$	Resultant of shear forces $V_y, V_z$ in bolt
$F_{v,Rd}$	Bolt shear resistance EN_1993-1-8 table 3.4
$F_{b,Rd}$	Plate bearing resistance EN 1993-1-8 tab. 3.4
$U_t$	Utilization in tension
$U_s$	Utilization in shear
$U_{ts}$	Utilization in tension and shear EN 1993-1-8 table 3.4

**Welds (Plastic redistribution)**

Item	Edge	Throat th. [mm]	Length [mm]	Loads	$\sigma_{w,Ed}$ [MPa]	$\epsilon_{Pl}$ [%]	$\sigma_{\perp}$ [MPa]	$\tau_{\parallel}$ [MPa]	$\tau_{\perp}$ [MPa]	$U_t$ [%]	$U_s$ [%]	Status
B572-bfl 1	CPL1a	▲20,0▲	500	GSN4(2)	57,5	0,0	-11,8	30,6	-10,8	13,2	10,6	OK
		▲20,0▲	500	GSN4(2)	55,9	0,0	27,5	13,2	-24,8	12,8	11,4	OK
CPL1b	CPL1c	▲20,0▲	350	GSN4(2)	10,4	0,0	8,4	-0,8	3,4	2,4	1,3	OK
		▲20,0▲	350	GSN4(2)	4,7	0,0	-2,9	0,3	-2,1	1,1	0,6	OK
CPL1b	B279-bfl 1	▲20,0▲	308	GSN4(2)	2,8	0,0	1,3	1,1	0,9	0,6	0,4	OK
		▲20,0▲	308	GSN4(2)	3,5	0,0	0,1	-2,0	-0,5	0,8	0,5	OK
CPL1b	B279-tfl 1	▲20,0▲	308	GSN4(2)	4,9	0,0	0,6	2,6	1,1	1,1	0,7	OK
		▲20,0▲	308	GSN4(2)	3,9	0,0	1,9	-1,4	-1,4	0,9	0,5	OK
CPL1b	B279-w 1	▲20,0▲	355	GSN4(2)	4,4	0,0	0,7	-1,9	1,7	1,0	0,5	OK
		▲20,0▲	355	GSN4(2)	4,6	0,0	0,7	2,6	-0,3	1,0	0,7	OK
B572-bfl 1	CPL2a	▲20,0▲	500	GSN4(2)	129,1	0,0	65,3	-26,2	58,8	29,6	24,6	OK
		▲20,0▲	500	GSN4(2)	196,2	0,0	-107,8	70,8	62,9	45,0	30,7	OK
CPL2b	CPL2c	▲20,0▲	350	GSN4(2)	277,6	0,0	-189,9	56,4	-102,4	63,7	40,6	OK
		▲20,0▲	350	GSN4(2)	113,9	0,0	-65,8	-39,2	36,6	26,1	16,9	OK
CPL2b	B278-bfl 1	▲20,0▲	308	GSN4(2)	67,6	0,0	-13,3	-28,3	-25,7	15,5	8,5	OK
		▲20,0▲	308	GSN4(2)	73,2	0,0	-43,4	14,0	31,0	16,8	7,1	OK
CPL2b	B278-tfl 1	▲20,0▲	308	GSN4(2)	64,1	0,0	38,4	11,8	27,2	14,7	6,3	OK
		▲20,0▲	308	GSN4(2)	61,1	0,0	12,8	-24,8	-24,0	14,0	7,6	OK
CPL2b	B278-w 1	▲20,0▲	355	GSN4(2)	93,2	0,0	-3,1	-53,8	-1,2	21,4	15,6	OK
		▲20,0▲	355	GSN4(2)	69,6	0,0	-0,6	-40,1	2,5	16,0	12,2	OK

**Design data**

	$\beta_w$ [-]	$\sigma_{w,Rd}$ [MPa]	$0,9 \sigma$ [MPa]
S 355	0,90	435,6	352,8

Project:  
Project no:  
Author:



### Symbol explanation

$\epsilon_{pi}$	Strain
$\sigma_{w,Ed}$	Equivalent stress
$\sigma_{w,Rd}$	Equivalent stress resistance
$\sigma_{\perp}$	Perpendicular stress
$\tau_{\parallel}$	Shear stress parallel to weld axis
$\tau_{\perp}$	Shear stress perpendicular to weld axis
$0.9 \sigma$	Perpendicular stress resistance - $0.9 \cdot f_u \cdot \gamma_{M2}$
$\beta_w$	Corelation factor EN 1993-1-8 tab. 4.1
$U_t$	Utilization
$U_{tc}$	Weld capacity utilization

### Buckling

Buckling analysis was not calculated.

### Code settings

Item	Value	Unit	Reference
$Y_{M0}$	1,00	-	EN 1993-1-1: 6.1
$Y_{M1}$	1,00	-	EN 1993-1-1: 6.1
$Y_{M2}$	1,25	-	EN 1993-1-1: 6.1
$Y_{M3}$	1,25	-	EN 1993-1-8: 2.2
$Y_C$	1,50	-	EN 1992-1-1: 2.4.2.4
$Y_{inst}$	1,20	-	ETAG 001-C: 3.2.1
Joint coefficient $\beta_j$	0,87	-	EN 1993-1-8: 6.2.5
Effective area - influence of mesh size	0,10	-	
Friction coefficient - concrete	0,25	-	EN 1993-1-8
Friction coefficient in slip-resistance	0,30	-	EN 1993-1-8 tab 3.7
Limit plastic strain	0,05	-	EN 1993-1-5
Weld stress evaluation	Plastic redistribution		
Detailing	No		
Distance between bolts [d0]	2,20	-	EN 1993-1-8: tab 3.3
Distance between bolts and edge [d0]	1,20	-	EN 1993-1-8: tab 3.3
Concrete breakout resistance	Yes		ETAG 001-C
Use calculated ab in bearing check.	Yes		EN 1993-1-8: tab 3.4
Cracked concrete	Yes		

## 7. DIMENZIONIRANJE TEMELJA

Proračun dimenzija temeljnih traka

Dopušteno naprezanje  $\sigma = 500 \text{ Mpa}$

$M_{sd} = 1347,28 \text{ kNm}$

$N_{sd} = 8254,24 \text{ Kn}$

$h = 5 \text{ cm}$

Težina temelja:  $W = B \cdot L \cdot h \cdot \gamma_{bet} = B \cdot 10,7 \cdot 0,50 \cdot 25 = B \cdot 133,6$

$N_d = 8254,24 + B \cdot 133,6$

$$\sigma_{1,2} = \frac{N}{A} \mp \frac{M}{W}$$

$$A = B \cdot 10,7$$

$$W = \frac{bL^2}{6} = \frac{B \cdot 10,7^2}{6}$$

$$\sigma_1 = \frac{8254,24 + B \cdot 133,6}{B \cdot 10,7} + \frac{1347,28}{\frac{B \cdot 10,7^2}{6}} < 500 \frac{\text{kN}}{\text{m}^2}$$

$$\frac{8254,24 \cdot 10,7 + B \cdot 133,6 \cdot 10,7}{B \cdot 10,7^2} + \frac{6 \cdot 1347,28}{B \cdot 10,7^2} < 500 \frac{\text{kN}}{\text{m}^2}$$

$$B > 1,7\text{m}$$

$$\sigma_2 = \frac{8254,24 + B \cdot 133,6}{B \cdot 10,7^2} - \frac{1347,28}{\frac{B \cdot 10,7^2}{6}} < 500 \frac{\text{kN}}{\text{m}^2}$$

$$B > 1,6\text{m}$$

**Odabrana širina temelja  $B = 1,80 \text{ cm}$**

$$\sigma_1 = \frac{8254,24 + 240,48}{19,26} + \frac{1347,28}{34,35} = 480,28 < 500 \frac{\text{kN}}{\text{m}^2}$$

$$\sigma_2 = \frac{8254,24 + 240,48}{19,26} - \frac{115,29}{34,35} = 401,83 < 500 \frac{\text{kN}}{\text{m}^2}$$

$$M'_{Ed} = \sigma' \cdot \frac{b'^2}{2} + (\sigma_1 - \sigma') \cdot \frac{2b'^2}{6} = 451,95 \cdot \frac{0,65^2}{2} + (480,28 - 401,83) \cdot \frac{0,65^2}{3} \\ = 8,2 \text{ kNm}$$

$$M_{Ed} = 106,5 \text{ kNm}$$

$$\mu_{Ed} = \frac{M_{Ed}}{b \cdot d^2 \cdot f_{cd}} = \frac{10650}{180 \cdot 47^2 \cdot 2,0} = 0,013$$

$$\text{Očitano: } \varepsilon_{s1} = 10,0\% \quad \varepsilon_{c2} = 0,6\% \quad \zeta = 0,981$$

$$A_{s1} = \frac{M_{Ed}}{\zeta \cdot d \cdot f_{yd}} = \frac{10650}{0,981 \cdot 47 \cdot 43,48} = 5,31 \text{ cm}^2/\text{m}'$$

$$A_{min} = 0,15\% \cdot b \cdot d = 0,15 \cdot 180 \cdot \frac{47}{100} = 12,7 \text{ cm}^2$$

$$\text{Odabrana armatura: } 10\emptyset 14 A_s = 15,39 \text{ cm}^2$$

## 8. LITERATURA

- [1] EN 1991:Eurokod 1 – Djelovanja na konstrukciju (EN 1991:2002)
- [2] EN 1991:Eurokod 3 – Projektiranje čeličnih konstrukcija
- [3] EN 1991:Eurokod 4 – Projektiranje spregnutih konstrukcija
- [4] EN 1998:2008 Eurokod 8-Projektiranje konstrukcija otpornih na potres- 1. dio:  
Opća pravila, potresna djelovanja i pravila za zgrade
- [5] Androić, Dujmović, Džeba, Metalne konstrukcije 1, IGH Zagreb, 1994.
- [2] Androić, Dujmović, Džeba, Metalne konstrukcije 2; IA Projektiranje Zagreb,  
1995.
- [3] Androić, Dujmović, Džeba, Metalne konstrukcije 3, IA Projektiranje, Zagreb,  
1995.
- [4] Androić, Dujmović, Lukačević, Projektiranje spregnutih konstrukcija prema  
Eurocode 4, IA Projektiranje, Zagreb, 2012

### Računalni programi:

- [1] Microsoft Office Word 365 ProPlus
- [2] Microsoft Office Excel 365 ProPlus
- [3] AutoCad 2016, Student version
- [4] Scia Engineer 16.1., Student version
- [5] Aspalathos Section Desing
- [6] IDEA StatiCa, connection

## **9. NACRTI**



# PLAN POZICIJA ČELIČNE KONSTRUKCIJE-TLOCRT PRIZEMLJA (TEMELJI) M 1:200 ČELIK S355

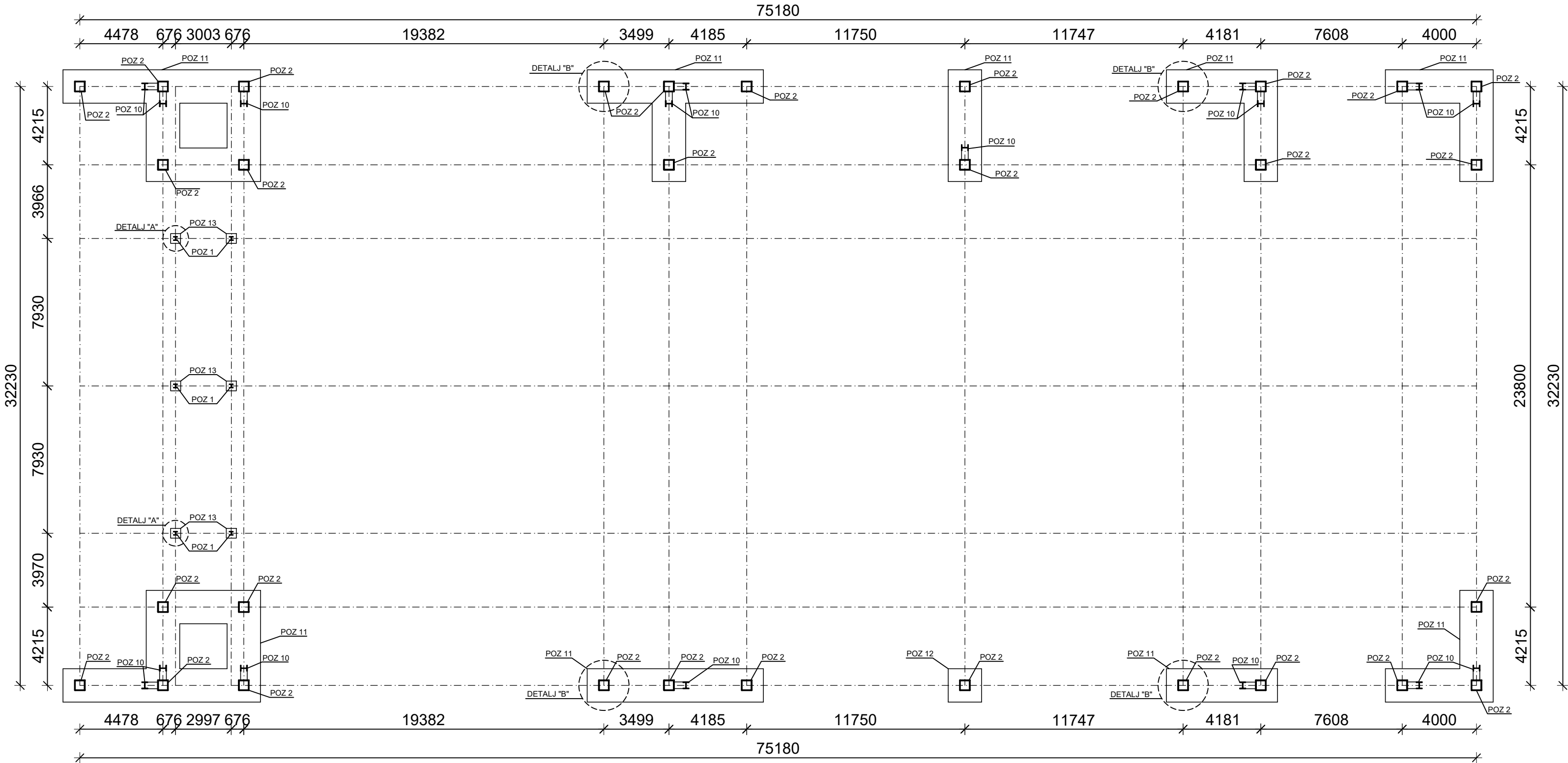

PRIKAZ I OPIS POZICIJA

POZICIJA	PROFIL	NAZIV
POZ 1	HEA 200A	Stupovi rampe (prizemlje-kat)
POZ 2	560x560x30	Spregnuti stupovi
POZ 10	HEB 360	Dijagonale prizemlja
POZ 11	1800xLx500	AB trakasti temelji
POZ 12	1800x1800x500	AB temelji samci
POZ 13	1800x1800x500	AB temelji samci

 <p>SVEUČILIŠTE U SPLITU, GRAĐEVINSKO - ARHITEKTONSKI FAKULTET 21000 SPLIT, MATICE HRVATSKE 15</p>	TEMA: GLAVNI PROJEKT KONSTRUKCIJE SPORTSKO-REKREACIJSKOG CENTRA ZENTA		
	STUDENTI: Marijan Baleta	MENTOR	Dr. sc. Vladimir Divić
	SADRŽAJ Plan pozicija	MJERILO 1:200	PRILOG: 1
	srpanj, 2019.		

# PLAN POZICIJA ČELIČNE KONSTRUKCIJE-TLOCRT KATA M 1:200 ČELIK S355

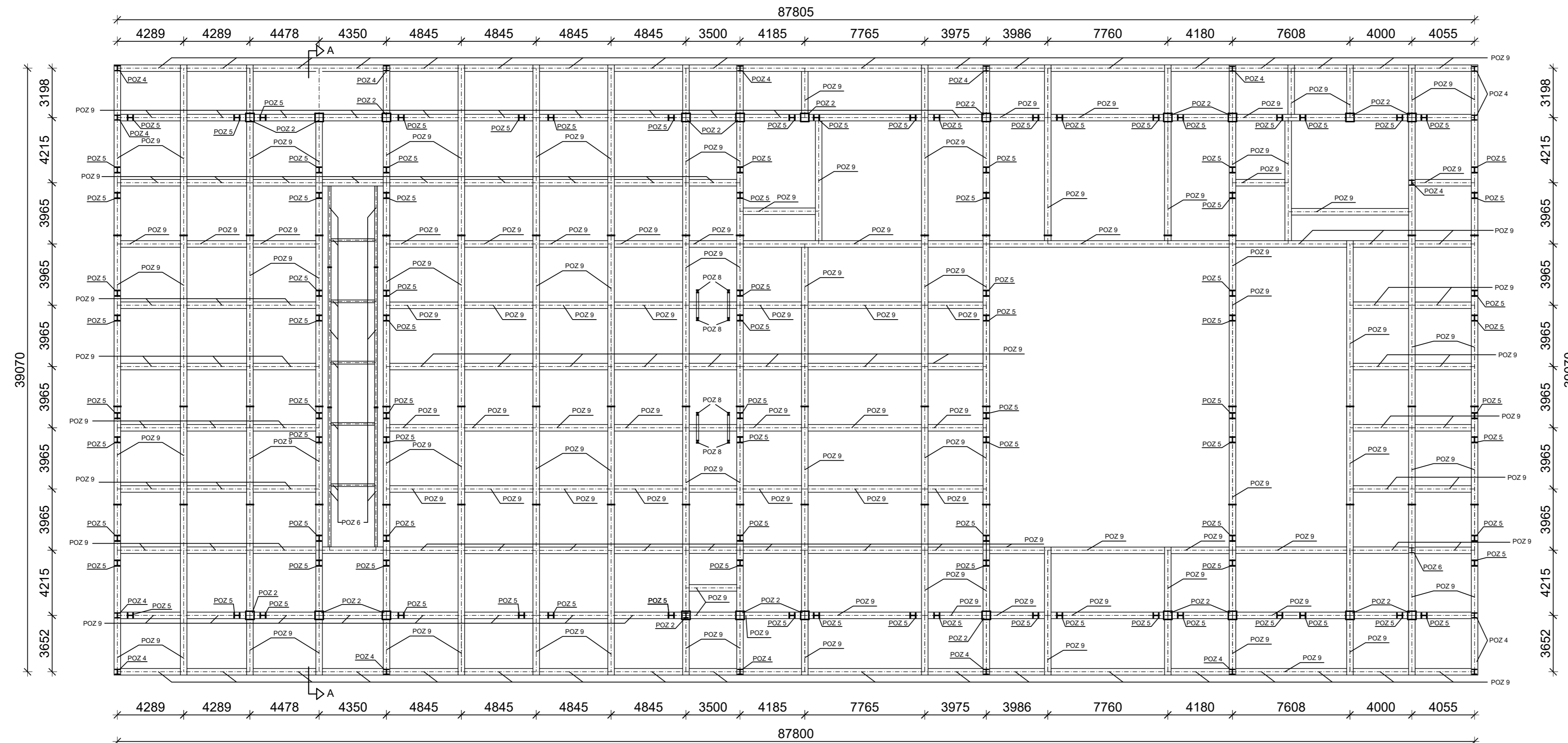

PRIKAZ I OPIS POZICIJA		
POZICIJA	PROFIL	NAZIV
POZ 2	560x560x30	Spregnuti stupovi
POZ 4	HEA 340	Stupovi kata
POZ 5	HEM 360	Dijagonale kata
POZ 6	HEB 180	Gredni nosači rampe prizemlje-kat
POZ 8	HEB 140	Stupovi rampe kata
POZ 9	HL 920X390	Gredni nosači kata

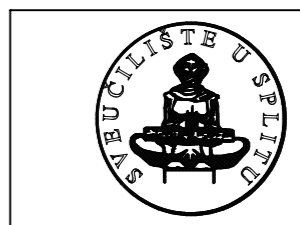

TEMA: GLAVNI PROJEKT KONSTRUKCIJE SPORTSKO-REKREACIJSKOG CENTRA ZENTA		
STUDENTI: Marijan Baleta	MENTOR: Dr. sc. Vladimir Divić	
SADRŽAJ: Plan pozicija	MJERILO: 1:200	PRILOG: 2
srpanj, 2019.		

SVEUČILIŠTE U SPLITU  
GRAĐEVINSKO-ARHITEKTONSKI FAKULTET  
21000 SPLIT, MATICE HRVATSKE 15

# PLAN POZICIJA ČELIČNE KONSTRUKCIJE-TLOCRT KROVA M 1:200 ČELIK S355

PRIKAZ I OPIS POZICIJA		
POZICIJA	PROFIL	NAZIV
POZ 3	HL 920X449	Gredni nosači krova
POZ 7	HEM 180	Gredni nosači rampe kat-krov

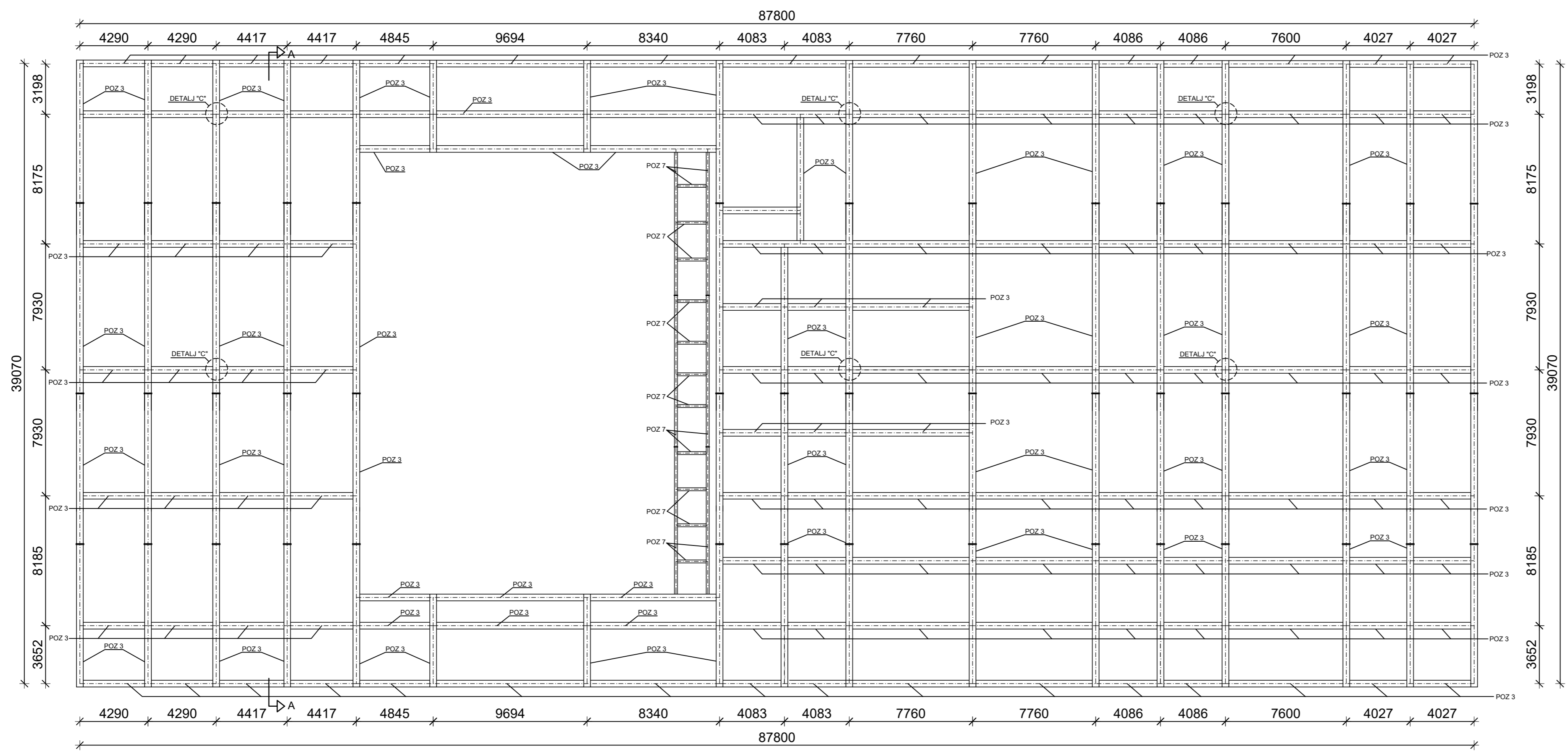

SVEUČILIŠTE U SPLITU  
GRAĐEVINSKO-ARHITEKTONSKI FAKULTET  
21000 SPLIT, MATICE HRVATSKE 15

TEMA: GLAVNI PROJEKT KONSTRUKCIJE SPORTSKO-REKREACIJSKOG CENTRA ZENTA		
STUDENTI: <b>Marijan Baleta</b>	MENTOR: Dr. sc. Vladimir Divić	
SADRŽAJ: Plan pozicija	MJERILO: 1:200	PRILOG: 3
srpanj, 2019.		

PRESJEK A-A  
M 1:50

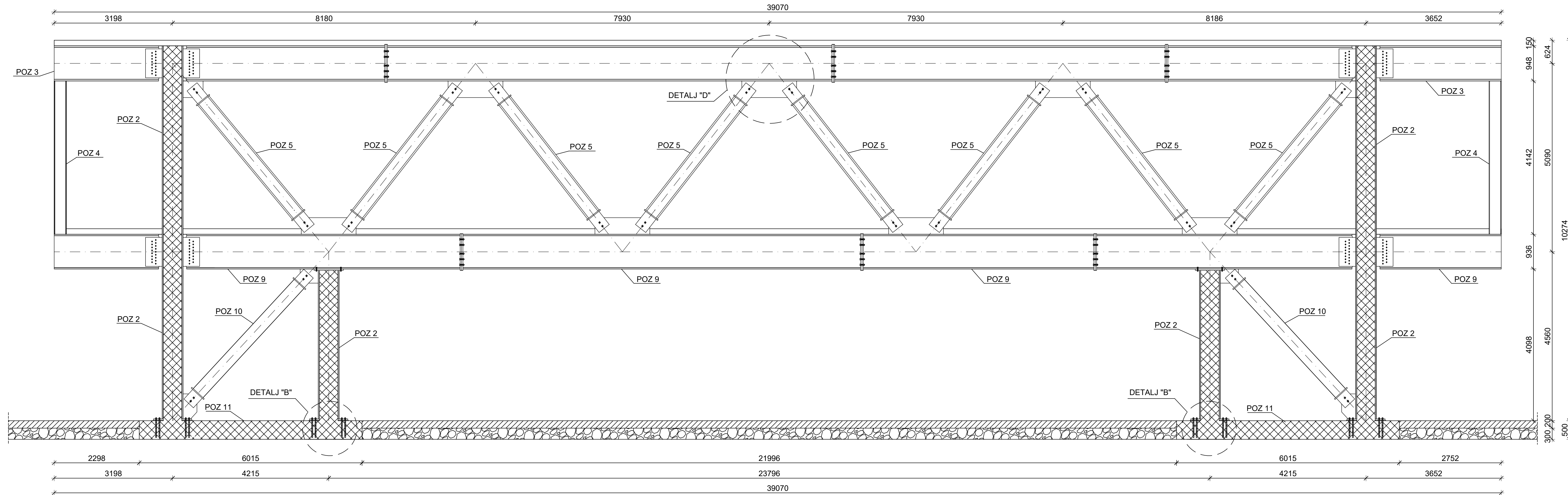

PRIKAZ I OPIS POZICIJA		
POZICIJA	PROFIL	NAZIV
POZ 2	560x560x30	Spregnuti stupovi
POZ 3	HL 920x449	Gredni nosači krova
POZ 4	HEA 340	Stupovi kata
POZ 5	HEM 360	Dijagonale kata
POZ 9	HL 920x390	Gredni nosači kata
POZ 10	HEB 360	Dijagonale prizemlja
POZ 11	1800xLx500	AB trakasti temelji

	TEMA: GLAVNI PROJEKT KONSTRUKCIJE SPORTSKO-REKREACIJSKOG CENTRA ZENTA	
	STUDENTI: Marijan Baleta	MENTOR: Dr. sc. Vladimir Divić
	SADRŽAJ: Presjek A-A	MJERILO: 1:50
	srpanj, 2019.	PRILOG: 4

# RADIONIČKI NACRT GORNJEG POJASA GLAVNOG NOSAČA M 1:25

POZ 1 HEA 200A

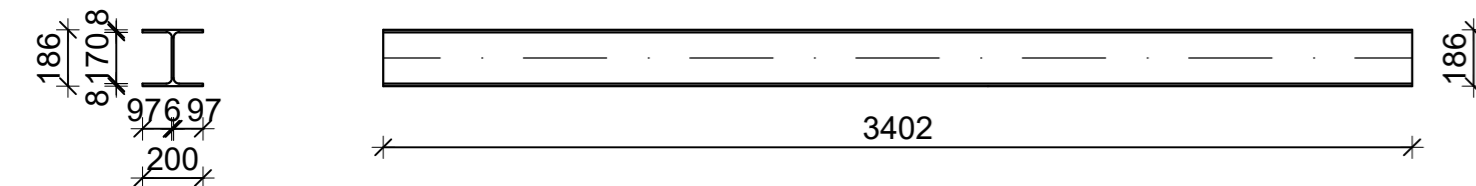

POZ 2 560x560x30

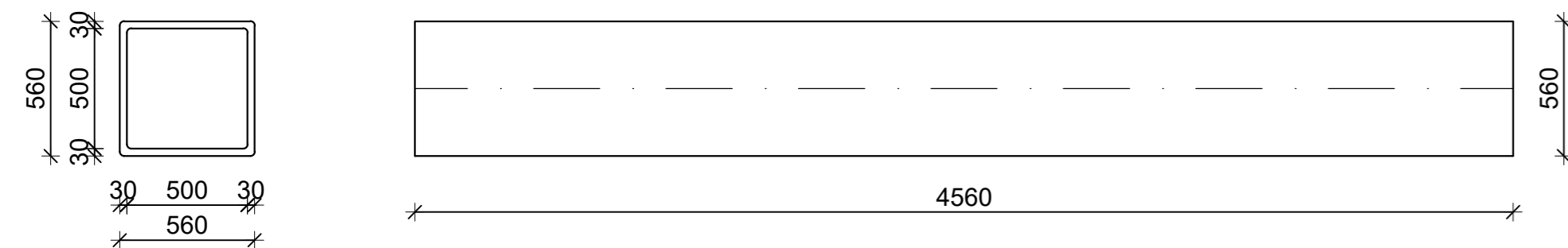

POZ 3 HL 920x449

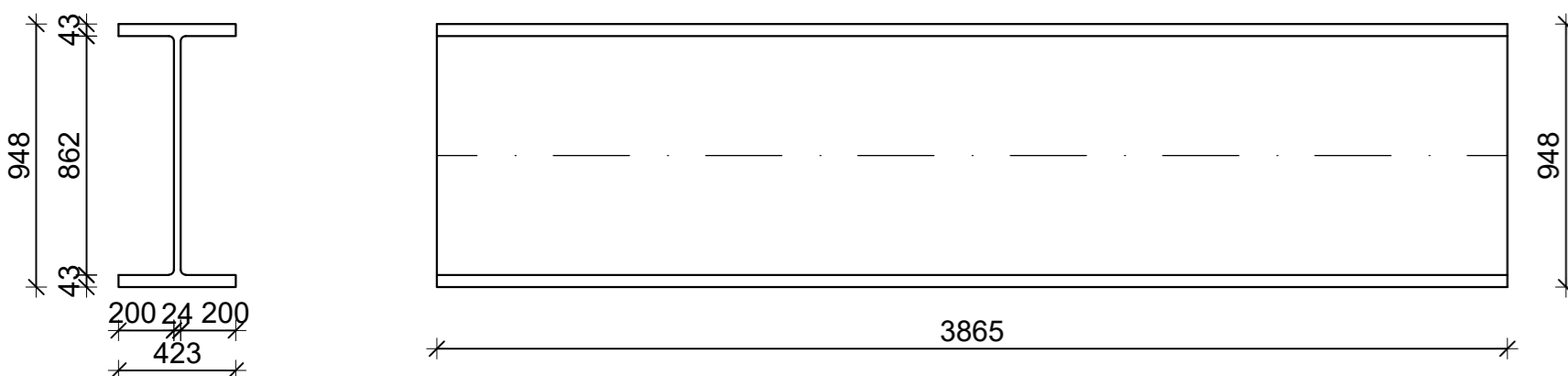

POZ 4 HEA 340

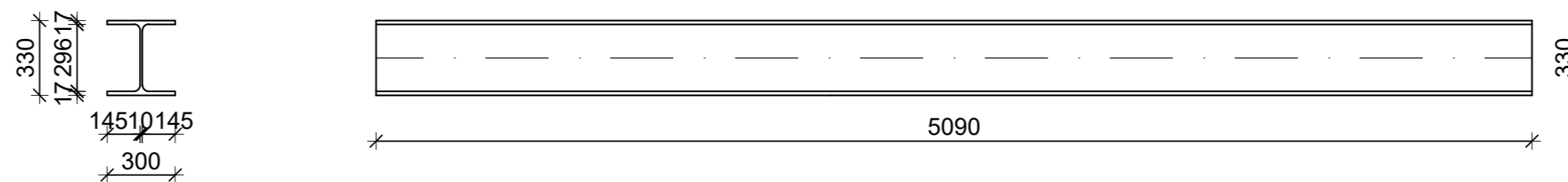

POZ 5 HEM 360

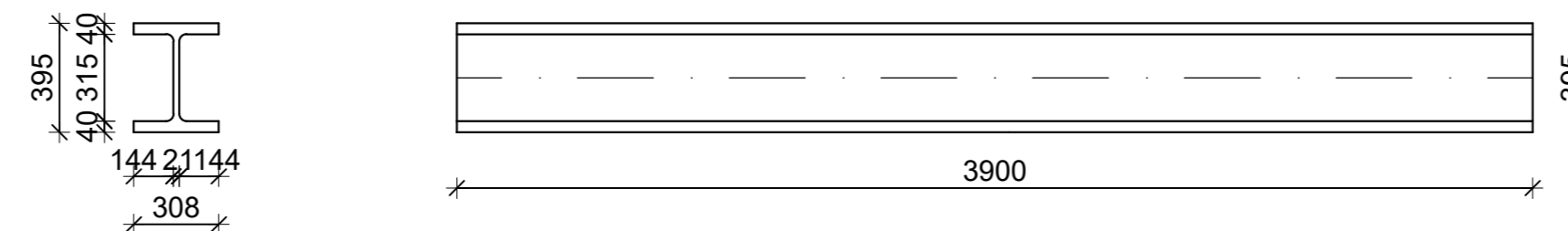

POZ 6 HEB 180

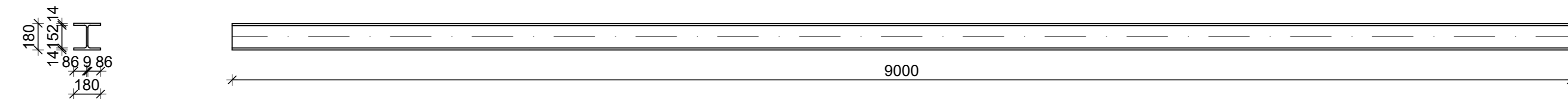

POZ 7 HEM 180

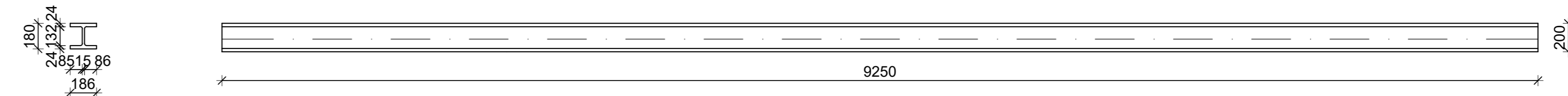

POZ 8 HEB 140

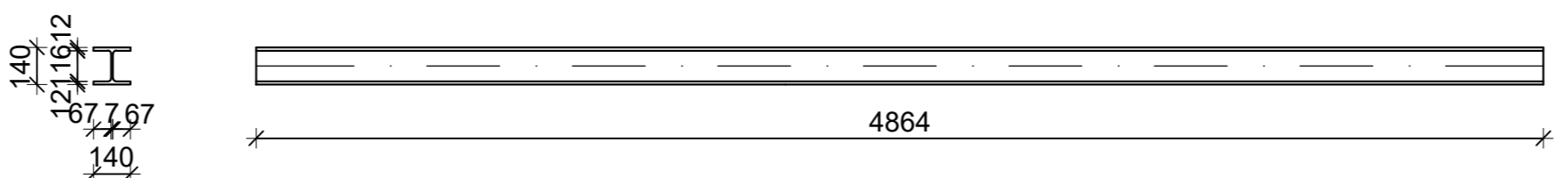

POZ 9 HL 920x390

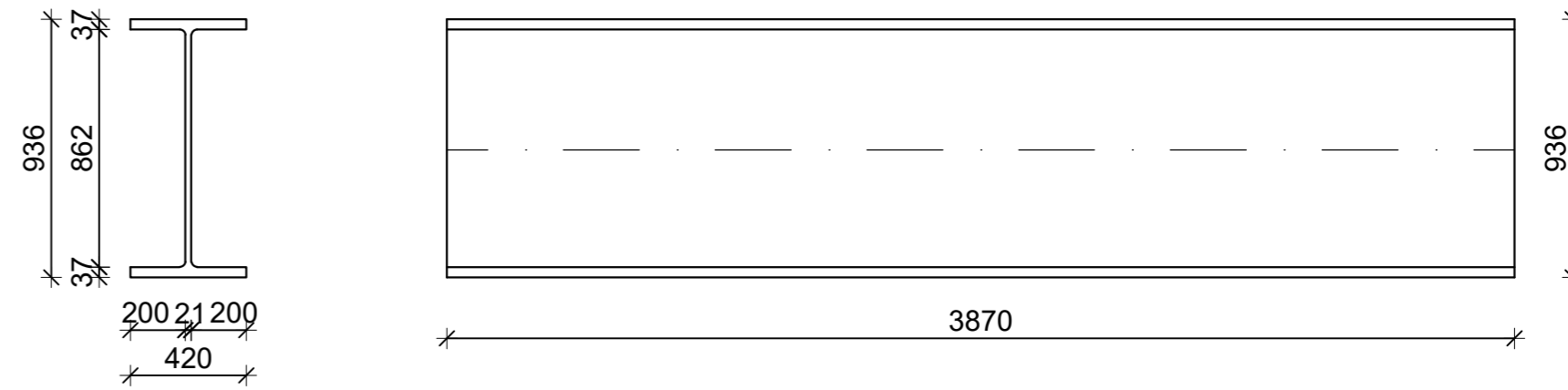

POZ 10 HEB 360

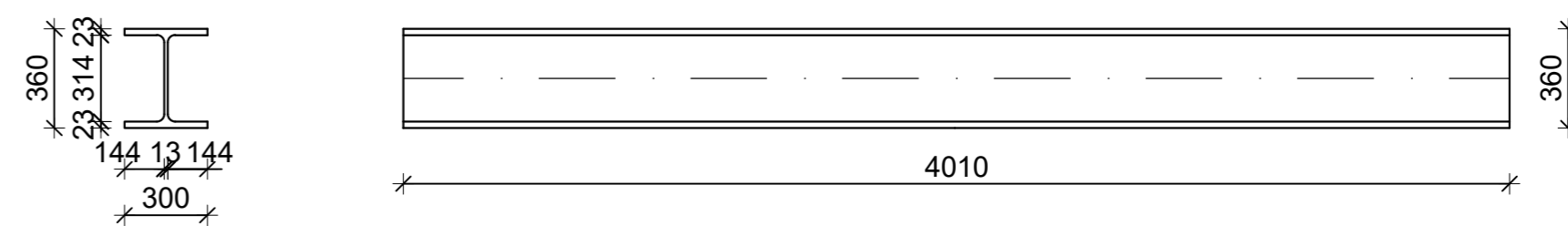

 SVEUČILIŠTE U SPLITU GRAĐEVINSKO-ARHITEKTONSKI FAKULTET 21000 SPLIT, MATICE HRVATSKE 15	Tema: GLAVNI PROJEKT KONSTRUKCIJE SPORTSKO-REKREACIJSKOG CENTRA ZENTA		
	STUDENTI: Marijan Baleta	MENTOR:	Dr. sc. Vladimir Divić
	SADRŽAJ: RADIONIČKI NACRT KONTRUKCIJE OBJEKTA srpanj, 2019.		MJERILO: 1:25 PRILOG: 5

DETALJ "A"  
SPOJ STUPA RAMPE-TEMELJ  
M 1:10

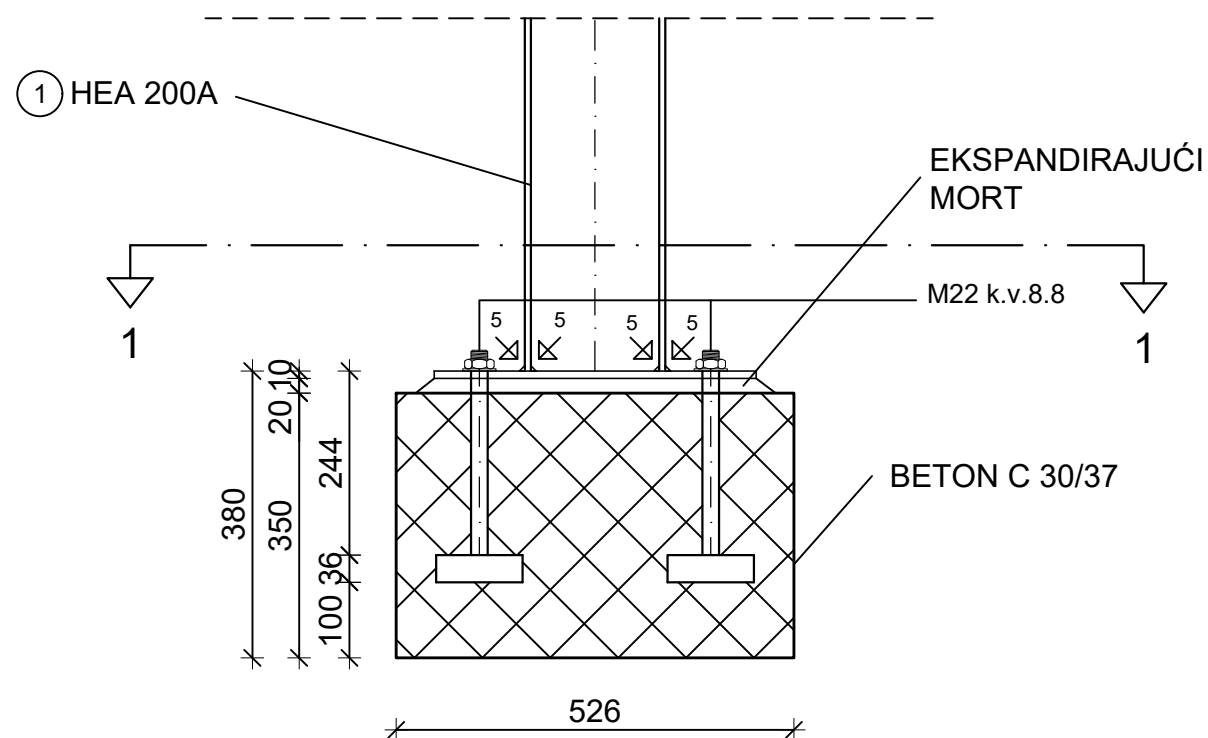

PRESJEK 1-1

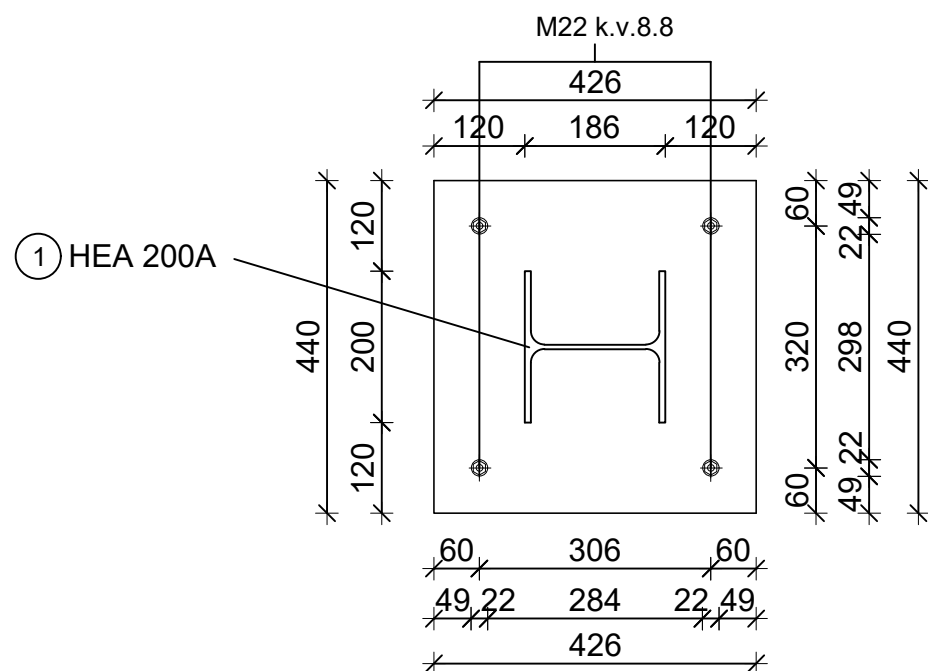

PLOČICA (P1)

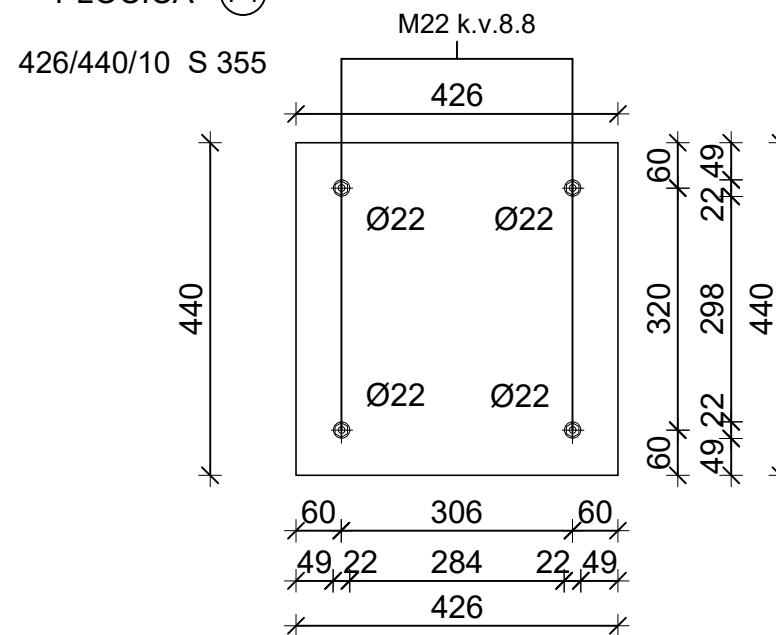

PLOČICA (P1)

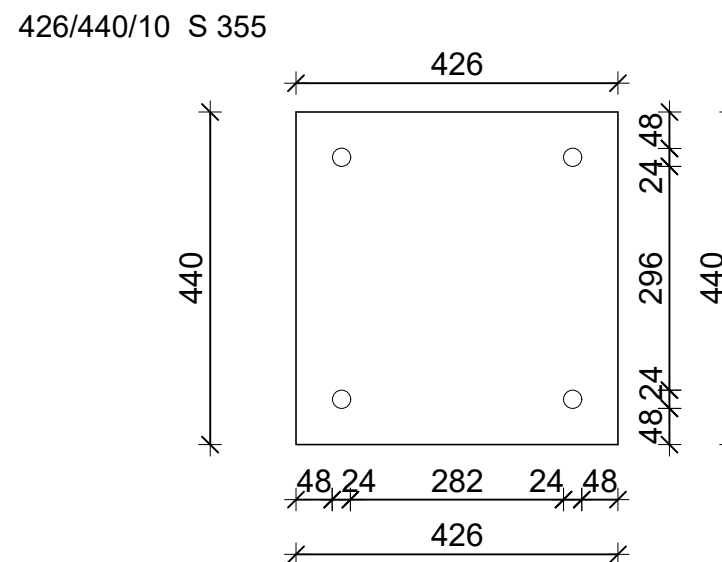

 SVEUČILIŠTE U SPLITU GRAĐEVINSKO - ARHITEKTONSKI FAKULTET 21000 SPLIT, MATICE HRVATSKE 15	TEMA: GLAVNI PROJEKT KONSTRUKCIJE SPORTSKO-REKREACIJSKOG CENTRA ZENTA		
	STUDENTI: Marijan Baleta		MENTOR: Dr. sc. Vladimir Divić
	SADRŽAJ: DETALJ "A"		MJERILO: 1:10
	srpanj, 2019.		PRILOG: 6

DETALJ "B"  
SPOJ STUP-TEMELJ  
M 1:10

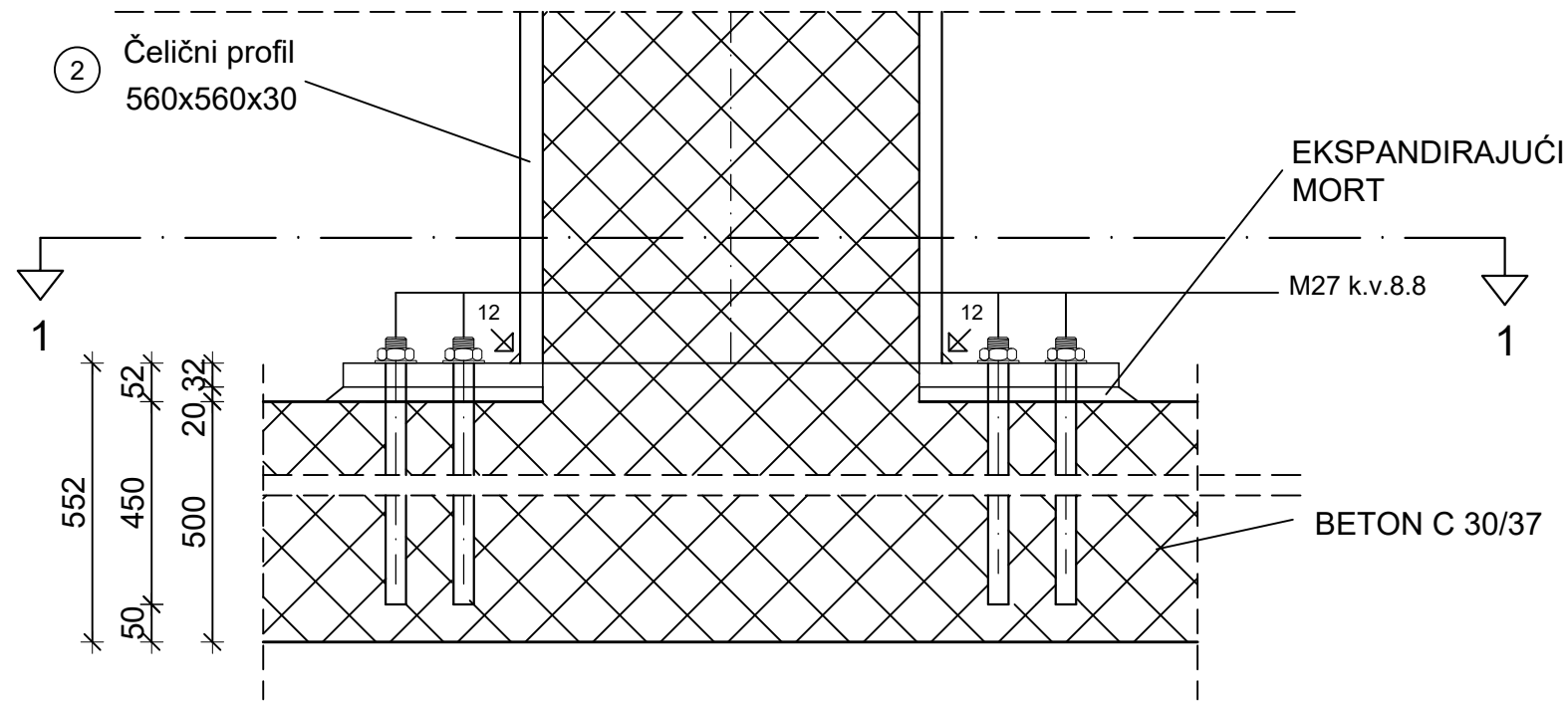

PRESJEK 1-1

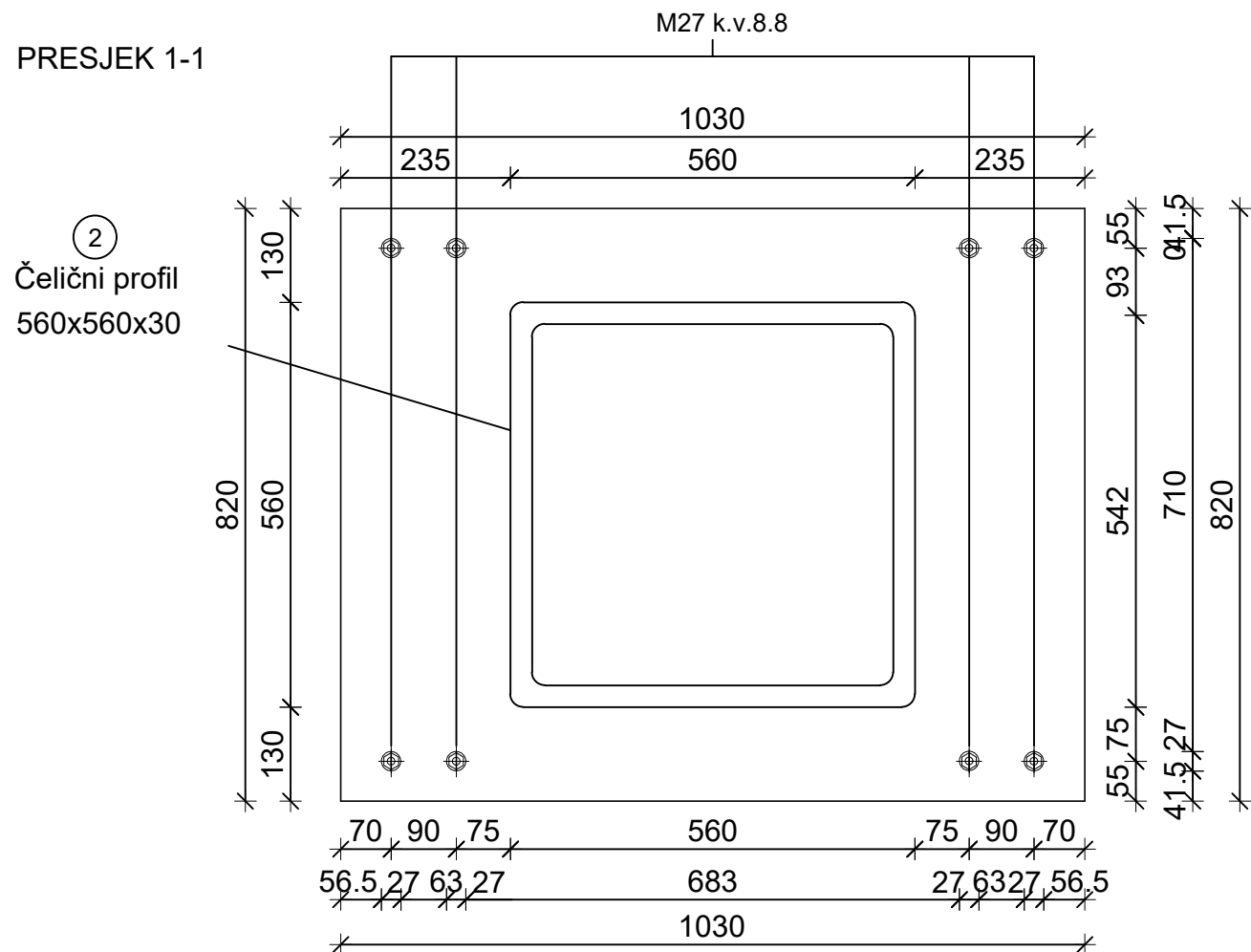

PLOČICA (P2)  
1030/820/32 S 355

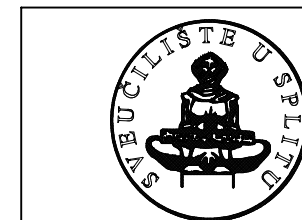
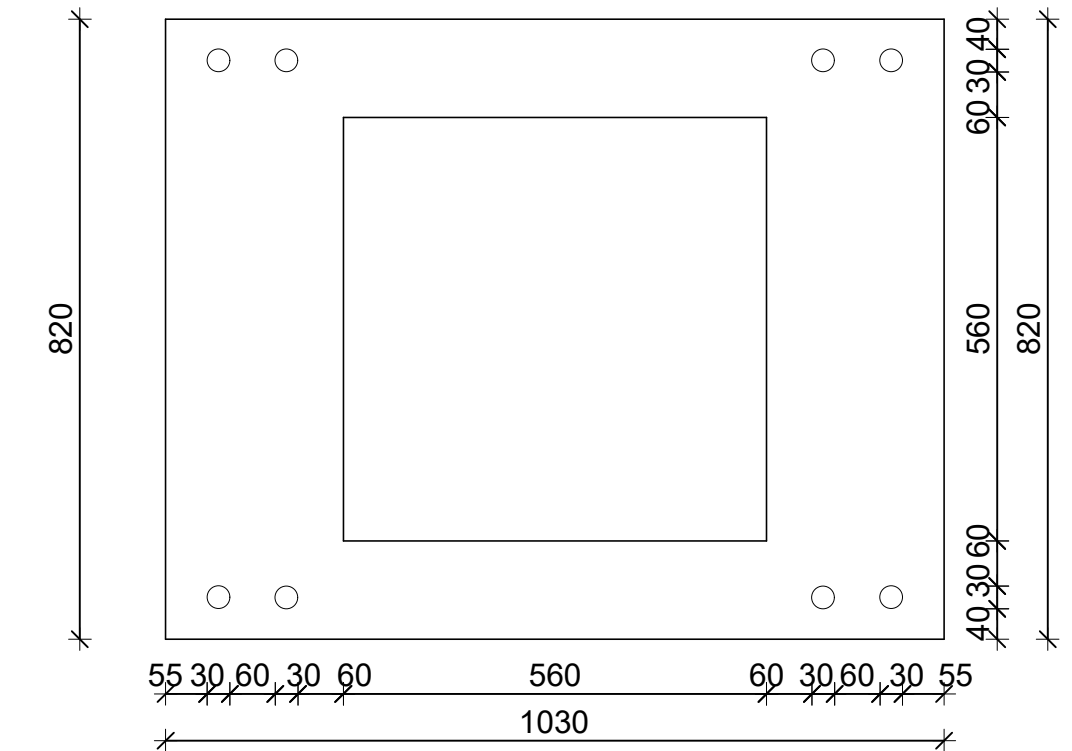
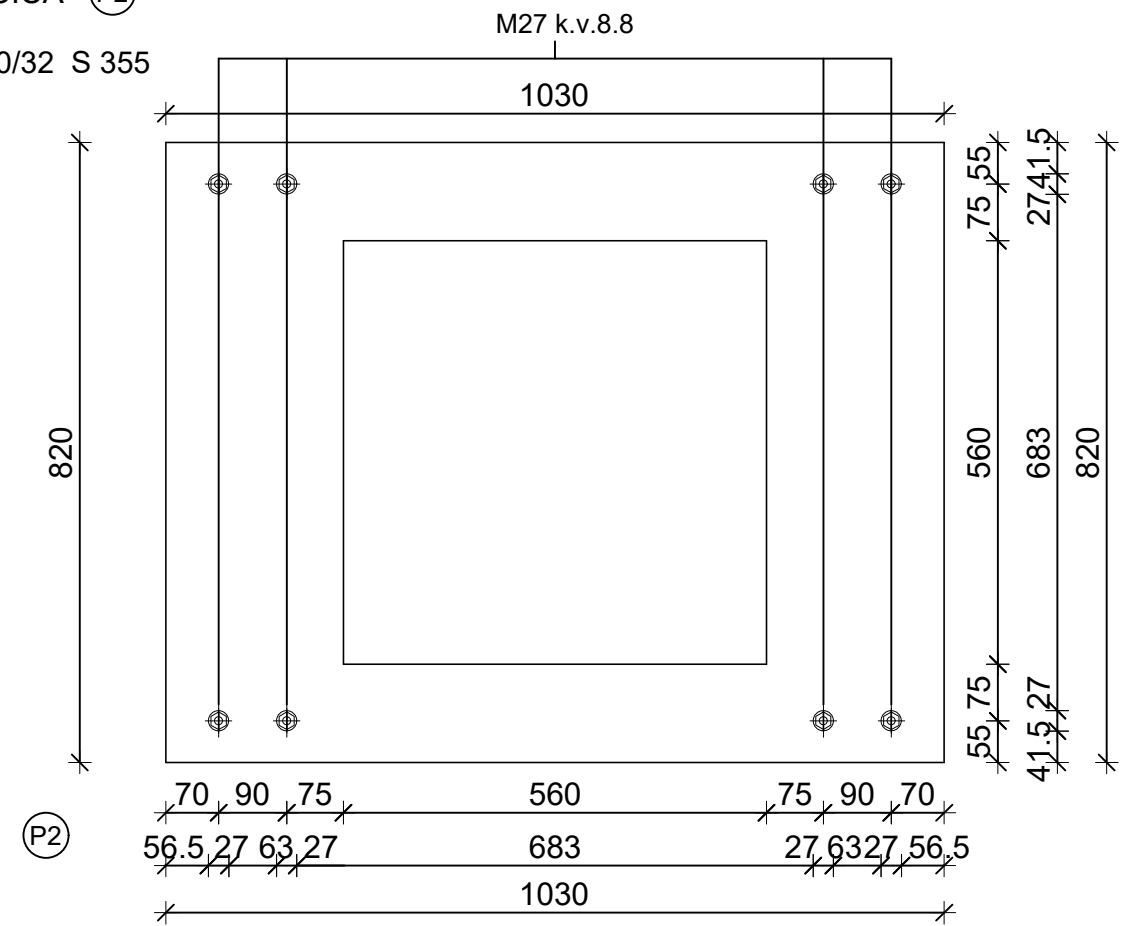

SVEUČILIŠTE U SPLITU,  
GRAĐEVINSKO - ARHITEKTONSKI FAKULTET  
21000 SPLIT, MATICE HRVATSKE 15

TEMA: GLAVNI PROJEKT KONSTRUKCIJE SPORTSKO-REKREACIJSKOG CENTRA ZENTA		
STUDENTI: Marijan Baleta	MENTOR Dr. sc. Vladimir Divić	
SADRŽAJ DETALJ "B"	MJERILO 1:10	
srpanj, 2019.	PRILOG: 7	

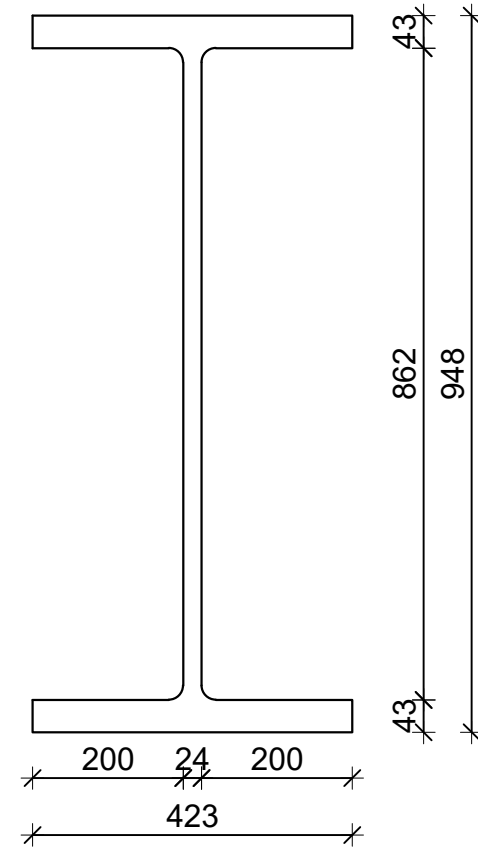
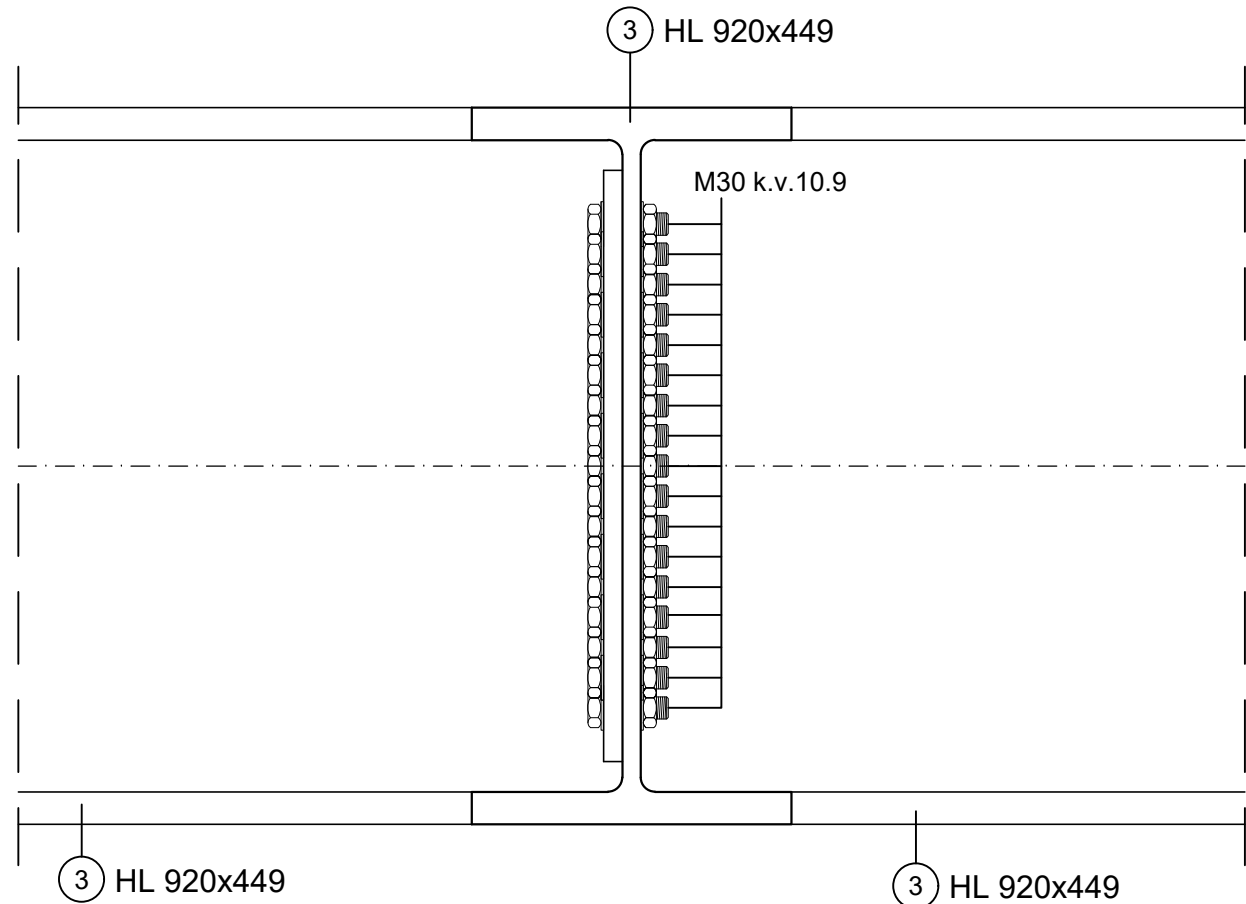

PLOČICA (P3)  
450/782/25 S 355

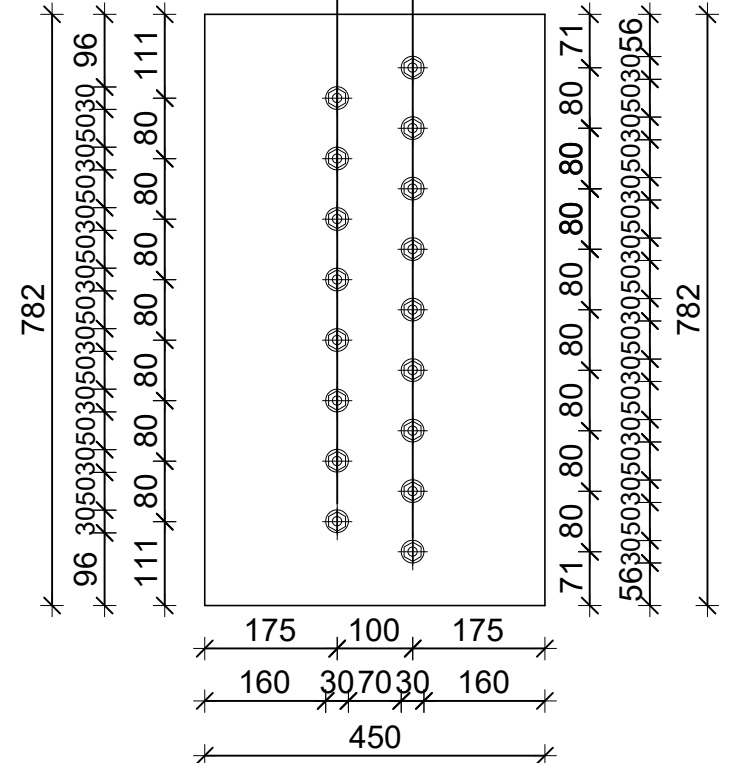

PLOČICA (P3)  
450/782/25 S 355

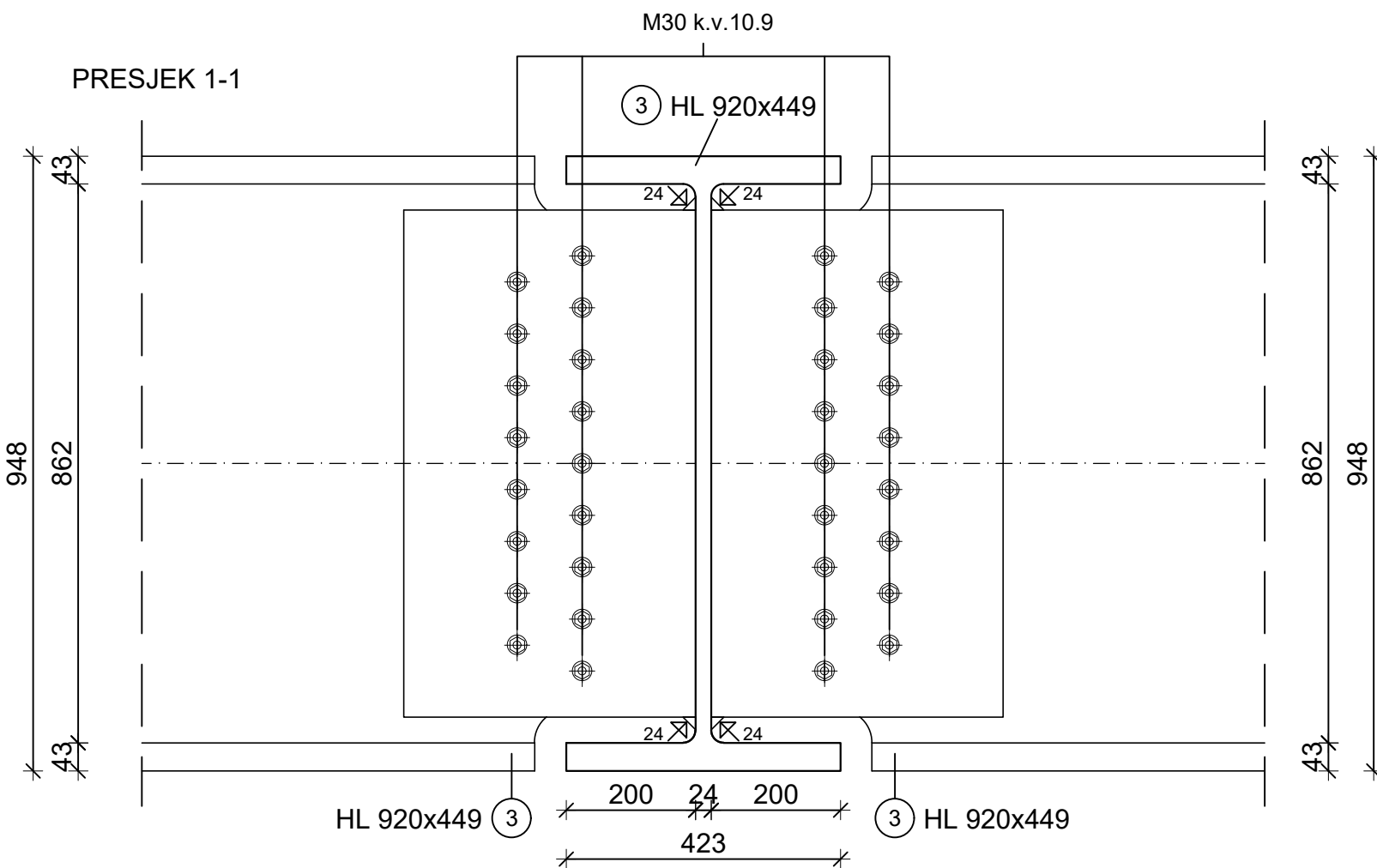
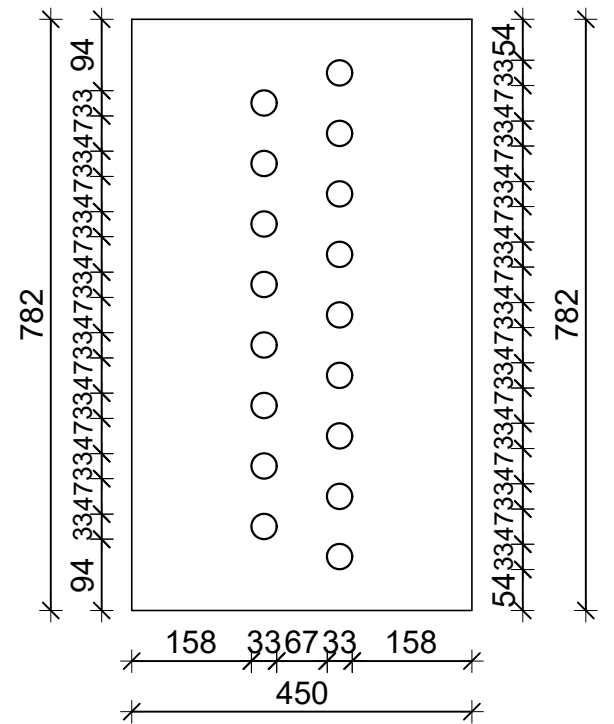

 SVEUČILIŠTE U SPLITU, GRAĐEVINSKO - ARHITEKTONSKI FAKULTET 21000 SPLIT, MATICE HRVATSKE 15	TEMA: GLAVNI PROJEKT KONSTRUKCIJE SPORTSKO-REKREACIJSKOG CENTRA ZENTA		
	STUDENTI: Marijan Baleta	MENTOR	Dr. sc. Vladimir Divić
	SADRŽAJ DETALJ "C"		MJERILO 1:10
	srpanj, 2019.		PRILOG: 8



DETALJ "D"  
SPOJ GLAVNIH NOSAČA SA DIJAGONALAMA 1:10

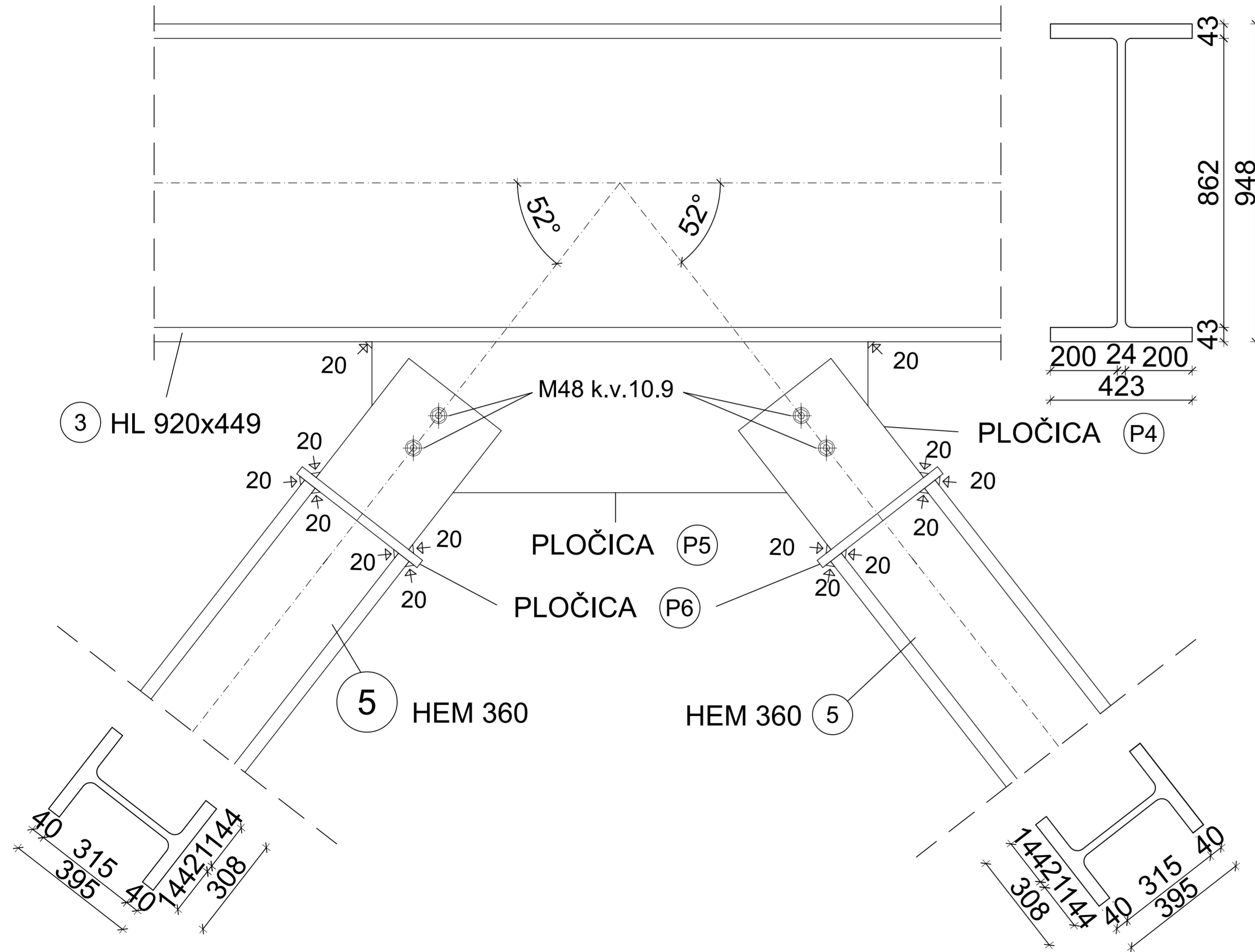

PRESJEK 1-1

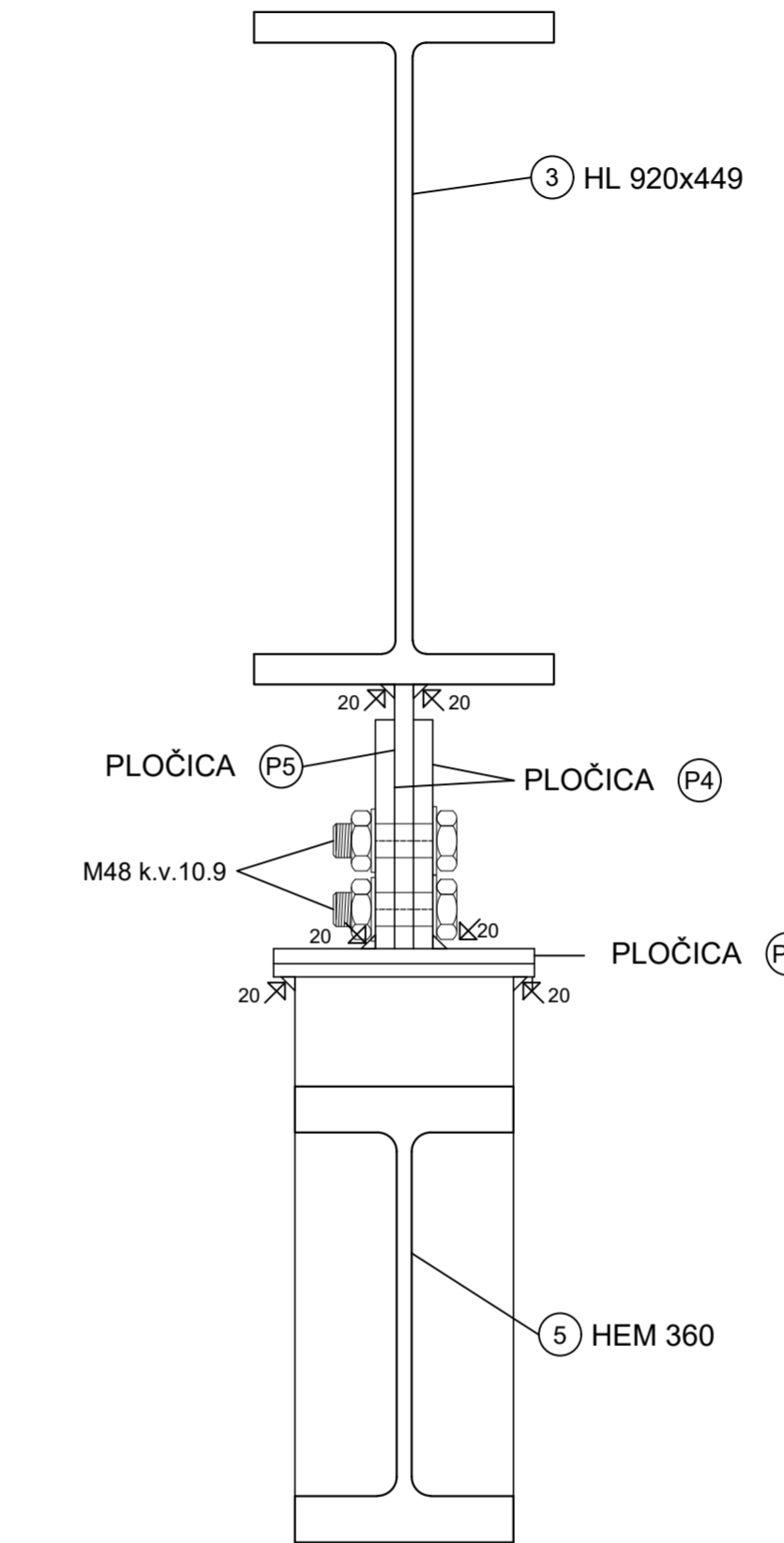

PRESJEK 2-2

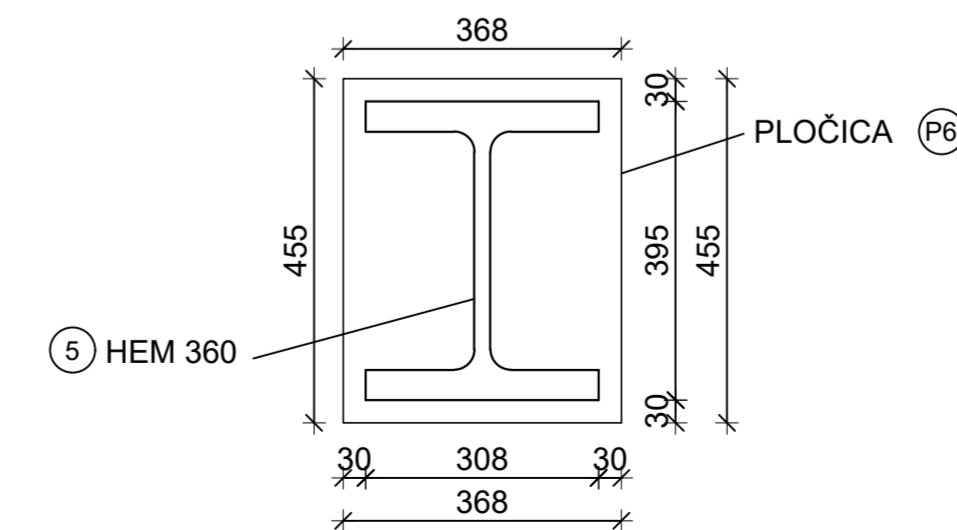

PLOČICA P5  
1480/450/27 S 355

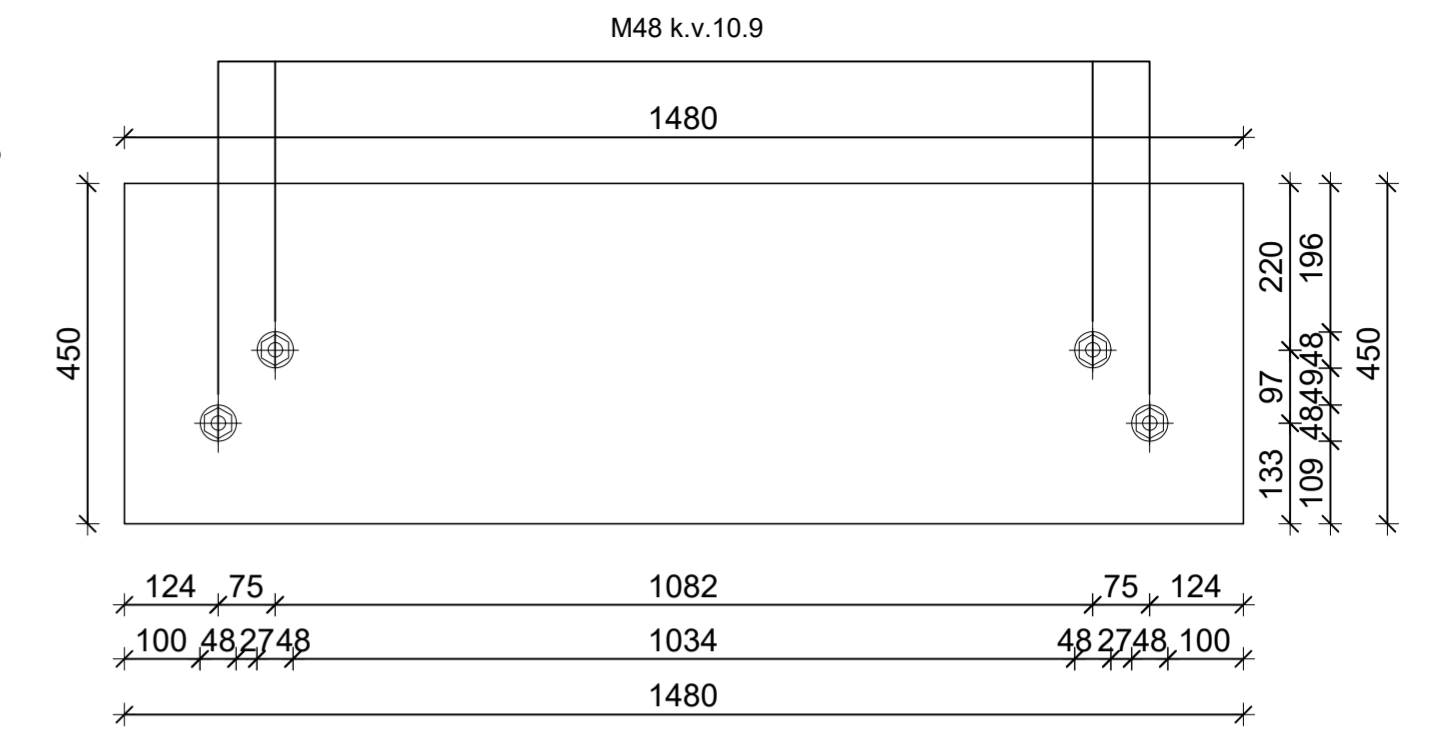

PLOČICA P5  
1480/450/27 S 355

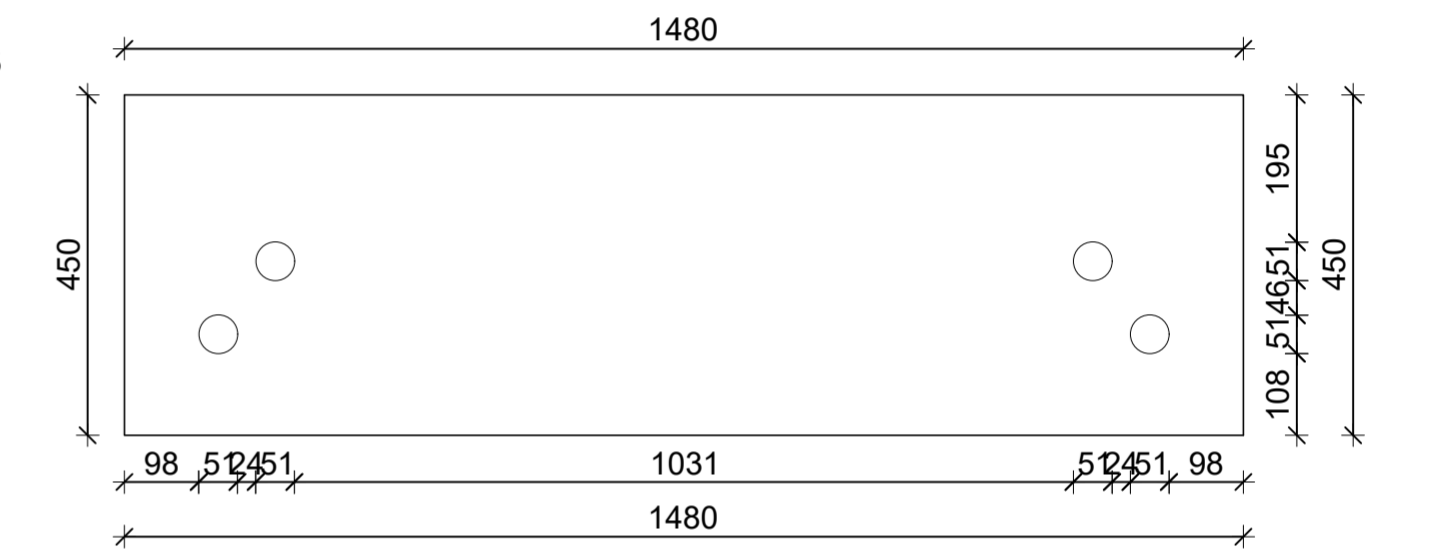

PLOČICA P4  
450/350/27 S 355

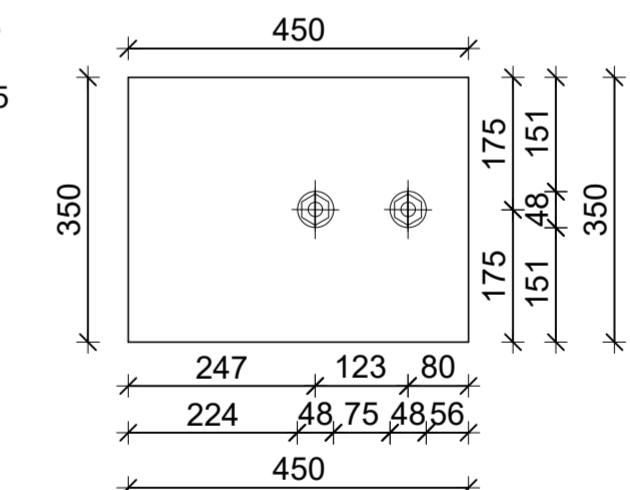

PLOČICA P6  
450/350/27 S 355

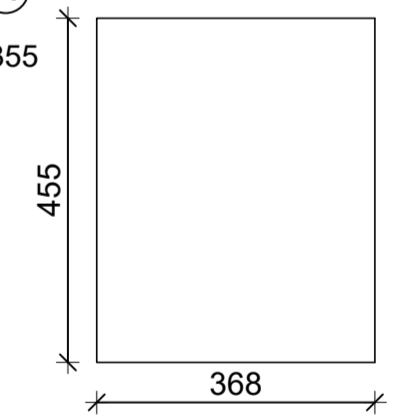

PLOČICA P4  
450/350/27 S 355

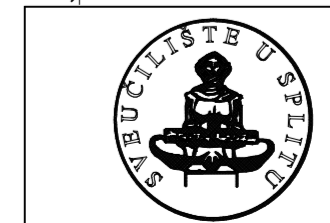
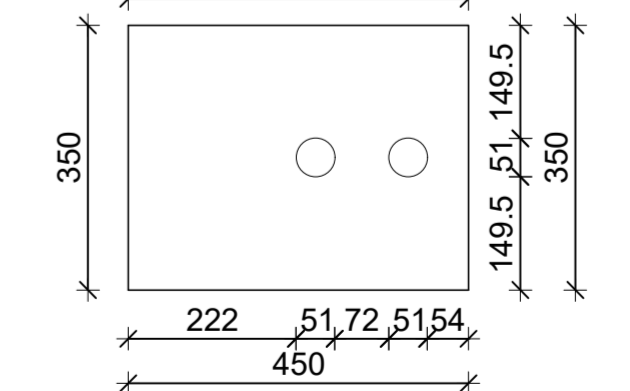

SVEUČILIŠTE U SPLITU,  
GRAĐEVINSKO - ARHITEKTONSKI FAKULTET  
21000 SPLIT, MATICE HRVATSKE 15

TEMA: GLAVNI PROJEKT KONSTRUKCIJE SPORTSKO-REKREACIJSKOG CENTRA ZENTA		
STUDENTI: Marijan Baleta	MENTOR: Dr. sc. Vladimir Divić	
SADRŽAJ: DETALJ "D"	MJERILO: 1:10	
srpanj, 2019.		PRILOG: 9

# RADIONIČKI NACRT PLOČICA ZA SPOJEVE M 1:25

PLOČICA (P1)  
426/440/10 S 355

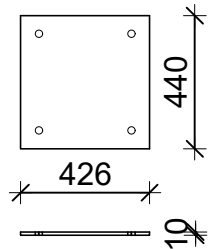

PLOČICA (P2)  
1030/820/32 S 355

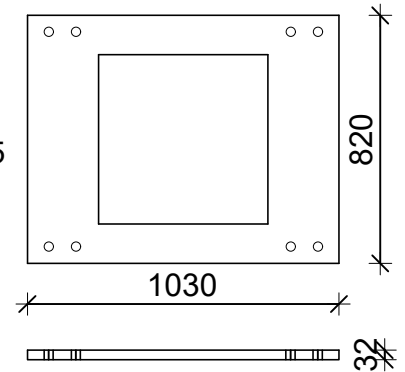

PLOČICA (P3)  
450/782/25 S 355

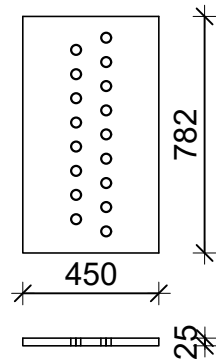

PLOČICA (P4)  
450/350/27 S 355

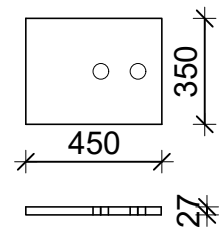

PLOČICA (P5)  
1480/450/27 S 355

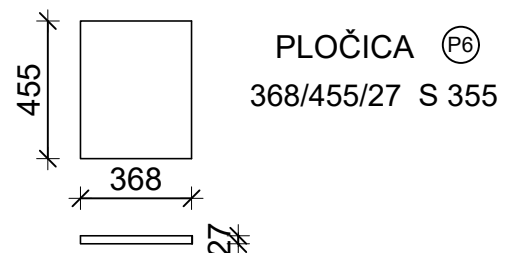
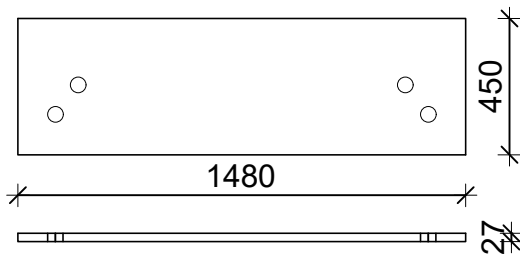

PLOČICA (P6)  
368/455/27 S 355



SVEUČILIŠTE U SPLITU,  
GRADEVINSKO-ARHITEKTONSKI FAKULTET  
21000 SPLIT, MATICE HRVATSKE 15

Tema: GLAVNI PROJEKT KONSTRUKCIJE SPORTSKO-REKREACIJSKOG CENTRA ZENTA		
STUDENTI: Marijan Baleta	MENTOR: Dr. sc. Vladimir Divić	
SADRŽAJ: RADIONIČKI NACRT PLOČICA ZA SPOJEVE srpanj, 2019.	MJERILO: 1:25	PRILOG: 10