

# Projekt konstrukcije čeličnog krova industrijske hale

---

Mošić, Ivan

Master's thesis / Diplomski rad

2019

*Degree Grantor / Ustanova koja je dodijelila akademski / stručni stupanj:*

**University of Split, Faculty of Civil Engineering, Architecture and Geodesy / Sveučilište u Splitu, Fakultet građevinarstva, arhitekture i geodezije**

*Permanent link / Trajna poveznica:* <https://um.nsk.hr/um:nbn:hr:123:924508>

*Rights / Prava:* [In copyright](#)/[Zaštićeno autorskim pravom.](#)

*Download date / Datum preuzimanja:* **2024-07-03**



*Repository / Repozitorij:*

[FCEAG Repository - Repository of the Faculty of Civil Engineering, Architecture and Geodesy, University of Split](#)



UNIVERSITY OF SPLIT



**SVEUČILIŠTE U SPLITU**  
**FAKULTET GRAĐEVINARSTVA ARHITEKTURE I GEODEZIJE**

# **DIPLOMSKI RAD**

**Ivan Mošić**

**Split, 2019.**

**SVEUČILIŠTE U SPLITU  
FAKULTET GRAĐEVINARSTVA ARHITEKTURE I GEODEZIJE**

**Ivan Mošić**

**Projekt konstrukcije čeličnog krova industrijske hale**

**Diplomski rad**

**Split, 2019.**

# Projekt konstrukcije čeličnog krova industrijske hale

## *Sažetak:*

Tema ovog diplomskoga rada je proračunati glavne elemente čeličnog krova industrijske hale. Glavna nosiva konstrukcija se sastoji od višedjelnih čeličnih IPE profila (saćasti nosači) postavljenih na osnovnom razmaku od 3.35 m, a sekundarna konstrukcija od standardnih IPE nosača postavljenih na osnovnom razmaku od 2,0 m. Projekt se izvodi za halu tlocrtnih dimenzija 30.45 x 12.10 m sa jednostrešnim krovom nagiba 7%. Visina hale u strehi iznosi 5.0 m, a u sljemenu 5.85 m. Analiza konstrukcije je provedena računanim programima SCIA engineer 2018 i ArceloMittal software Angelina. Zbog kompleksnosti samih saćastih profila, te zbog toga što im svojstva poprečnog presjeka nisu jednoznačno definirana, posebna pozornost u projektu je posvećena izradi modela glavnog nosivog sustava krovišta. Jednostavnim postupcima rezanja i ponovnog zavarivanja od standardnih vrućevaljanih profila dobivaju se nosači koji imaju moment tromosti veći do 100% i moment otpora veći od 50% uz isti utrošak materijala, odnosno istu vlastitu težinu. Povećanje otpornosti saćastih nosača je nešto manje, ali ipak znatno u odnosu na profil od kojeg su dobiveni. Na kraju se može zaključiti da je kompleksnost izvedbe saćastih nosača znatno manja od prednosti koju ovakvi nosači pružaju te njihova primjena može biti racionalnija od primjene odgovarajućih valjanih ili zavarenih profila. Nakon dimenzioniranja nosivih elemenata pristupilo se oblikovanju i proračunu spoja stup-greda. U zadnjoj fazi izrađeni su odgovarajući nacrti konstrukcije te nacrti detalja spoja. Svi elementi su dimenzionirani prema HRN EN 1993, a korisno opterećenje prema HRN EN 1991. Diplomski rad je izrađen na razini izvedbenog projekta.

## *Ključne riječi:*

Industrijska hala, saćasti nosači, spoj stup-greda

## **Design of the steel roof for industrial building**

### ***Abstract:***

This thesis presents a design of main elements in the steel roof of an industrial hall. The main load bearing elements are steel IPE profiles (castellated beams) spaced every 3.35m apart, while the secondary elements are standard IPE girders, spaced every 2m. Design was carried out for a rectangular hall with dimensions 30.45 x 12.10m, with one-sided roof with inclination of 7%. Height of the ridge of the structure is 5.85m, while height of the eave is 5.0m. Numerical modeling and structural analysis of the building was performed in SCIA engineer 2008 and ArceloMittal software. Special attention was paid to the making of an accurate model, due to complexity of castellated beams and their not uniform geometry. By using simple technique of cutting and then welding of standard hot rolled profiles, it is possible to obtain the girders with increase in moment of inertia up to 100% and moment of resistance up to 50%, with the same costs in terms of material and with the same self-weight. The enhancement in strength of castellated beams is lower, but still significant comparing with the elements that were used for their production. In conclusion, the complex execution of castellated beam is justified by plenty of advantages, since it is more rational to use them than similar rolled or welded profiles. After design of load bearing elements, connection between column and beam was calculated. Finally, detailed drawings of structure and of joints were done in AutoCAD software. Structural elements were designed according to HRN EN 1993, while loads were obtained from HRN EN 1991.

### ***Keywords:***

Industrial building, castellated beams, joints

**SVEUČILIŠTE U SPLITU**

**FAKULTET GRAĐEVINARSTVA, ARHITEKTURE I GEODEZIJE**

STUDIJ: **DIPLOMSKI SVEUČILIŠNI STUDIJ GRAĐEVINARSTVA**  
KANDIDAT: Ivan Mošić  
BROJ INDEKSA: 652  
KATEDRA: **Katedra za metalne i drvene konstrukcije**  
PREDMET: Metalne konstrukcije

## **ZADATAK ZA DIPLOMSKI RAD**

Tema: Projekt konstrukcije čeličnog krova industrijske hale

Opis zadatka:

Zadatak diplomskoga rada je projektiranje konstrukcije čeličnog krova industrijske hale pomoću višedjelnih čeličnih greda (saćastih nosača). Predmetna građevina se nalazi na otoku Braču iznad mjesta Selca, tlocrtne dimenzije su 30,45 x 12,10 m sa jednostrešnim krovom nagiba 7%. Visina konstrukcije u strehi je 5.0 m, a u sljemenu 5.85 m. Potrebno je izraditi model glavnog nosivog elementa konstrukcije krova primjenom sustava saćastih nosača, dimenzionirati elemente te izvršiti proračun spoja stup-greda. Treba napraviti usporedbu između nosivog sustava od standardnih valjanih nosača te nosivog sustava od saćastih nosača. Također je potrebno izraditi pripadajuće nacрте uz iskaz količine materijala za pojedine elemente. Proračun je potrebno provoditi u skladu sa HRN EN 1991 te HRN EN 1993.

U Splitu, srpanj 2019.

Voditelj Diplomskog rada:

Dr.sc. Vladimir Divić

Predsjednik Povjerenstva

za završne i diplomske ispite

Dr.sc. Ivo Andrić

*Zahvaljujem mentoru Dr.sc. Vladimiru Diviću  
na pomoći i savjetima pri pisanju ovoga rada,  
a posebno se zahvaljujem mojoj obitelji  
na strpljenju i podršci tijekom studiranja.*

## SADRŽAJ :

<b>1. TEHNIČKI OPIS</b> .....	1
1.1 Opis konstrukcije.....	1
1.2 O proračunu konstrukcije .....	1
1.3 Materijali za izradu konstrukcije .....	2
1.4 Primjenjeni propisi .....	2
1.5 Antikorozivna zaštita.....	2
1.6 Protupožarna zaštita.....	3
1.7 Uvjeti za izradu čelične konstrukcije .....	3
1.8 Opće napomene za izradu čelične konstrukcije u radionici.....	3
<b>2 ANALIZA OPTEREĆENJA</b> .....	4
2.1 Stalno djelovanje .....	4
2.2 Djelovanje snijega .....	4
2.3 Djelovanje vjetra .....	6
<b>3 GLAVNA NOSIVA KONSTRUKCIJA</b> .....	12
3.1 Odabir IPE profila glavne nosive konstrukcije krova.....	12
3.2 Način izvedbe glavne nosive konstrukcije .....	12
3.3 Dimenzioniranje nosača .....	13
3.3.1 Sačasti nosač IPE 220.....	13
3.3.2 Sačasti nosač IPE 240.....	27
3.3.3 Sačasti nosač IPE 270.....	40
3.3.4 Sačasti nosač IPE 300.....	59



<b>4</b>	<b>DIMENZIONIRANJE SPOJA GLAVNE NOSIVE KONSTRUKCIJE I AB STUPA.....</b>	<b>72</b>
4.1	Dimenzioniranje spoja.....	72
<b>5</b>	<b>SEKUNDARNA KONSTRUKCIJA.....</b>	<b>75</b>
5.1	Krovne podrožnice .....	75
5.2	Dijagrami reznih sila .....	75
5.3	Provjera progiba GSU .....	76
5.4	Dimenzioniranje presjeka.....	77
<b>6</b>	<b>ZAKLJUČAK.....</b>	<b>80</b>
<b>7</b>	<b>ISKAZ MATERIJALA.....</b>	<b>81</b>
<b>8</b>	<b>LITERATURA .....</b>	<b>82</b>
<b>9</b>	<b>NACRTI.....</b>	<b>83</b>

# 1. TEHNIČKI OPIS

## 1.1 Opis konstrukcije

Predmet ovog projekta je proračun čelične konstrukcije krovišta industrijske hale. Predmetna građevina nalazi se na području otoka Brača iznad mjesta Selca. Tlocrtna dimenzije građevine, koje se odnose na osi glavne nosive konstrukcije, iznose 30,45 x 12,10 m. Visina konstrukcije u bočnom poprečnom presjeku iznosi 5,85 m iznad kote tla, dok niža visina iznosi 5,0 m. Krovna ploha je u odnosu na horizontalnu ravninu nagnuta pod kutem od  $\alpha = 4,00^\circ$ , što je ekvivalentno nagibu od 7%. Predviđena je krovna konstrukcija sa pokrovom od sendvič panela na koju se proračunava mogućnost postavljanja solarnih panela. Glavnu nosivu čeličnu konstrukciju krova čine sačaste nosive grede raspona 12,0 m postavljenih na osnom razmaku 3,35 m, a sastoje se od sastavljenih grednih elemenata IPE 270 profili. Sekundarnu konstrukciju čine krovne podrožnice izvedene od IPE 100 profila, koje sudjeluju u horizontalnoj stabilizaciji ravnine i preuzimanju opterećenja od krovnih i solarnih panela. Glavna nosiva konstrukcija se oslanja na armiranobetonske stupove te je detalj njihova spoja posebno proračunat i detaljno prikazan u građevinskim nacrtima.

## 1.2 O proračunu konstrukcije

Proračun unutarnjih sila, momenata savijanja i dimenzioniranje elemenata čelične konstrukcije provedeno je u skladu s Eurocode-om. Proračunom su obuhvaćena sva djelovanja na konstrukciju, vlastita težina, dodatno stalno opterećenje, opterećenje vjetrom te opterećenje snijegom. S obzirom na lokaciju objekta i namjenu hale, posebna pažnja posvećena je opterećenju vjetra na konstrukciju. U svrhu dimenzioniranja elemenata konstrukcije određena je mjerodavna kombinacija opterećenja za provjeru kranje graničnoga stanja i graničnoga stanja uporabljivosti. Rezultati prikazani u grafičkome dijelu projekta uključuju rezne sile i pomake određenih dijelova konstrukcije. Analiza konstrukcije provedena je računalnim programom SCIA engineer 2018 i ArceloMittal pre-design software for Angelina beam. Sve mjerodavne kombinacije su uzete u obzir, te je svaki element konstrukcije dimenzioniran u skladu njihovim reznim silama.

### **1.3 Materijali za izradu konstrukcije**

Materijal za izradu glavne nosive konstrukcije, kao i sekundarne konstrukcije je čelik oznake Fe 510 (S 355). Svi elementi konstrukcije će se izraditi od iste kvalitete čelika, a biti će međusobno povezani zavarivanjem. Vijci korišteni za izvedbu ovog krovišta industrijske hale su M20 kvalitete 10.9. Spojevi elemenata konstrukcije uključuju dodatne pločice i ukrute, također iste kvalitete čelika. Za krovnu oblogu objekta koristimo sendvič panele vlastite težine 10 kg/m<sup>2</sup>, od tankog profiliranog aluminijskog lima, ispunjene mineralnom (kamenom) vunom.

### **1.4 Primjenjeni propisi**

Proračun čelične konstrukcije hale proveden je prema sljedećim propisima:

Analiza opterećenja:

Vlastita težina građevine HR EN 1991-2-1

Djelovanje snijega na konstrukciju HR EN 1991-2-3

Djelovanje vjetra na konstrukciju HR EN 1991-2-4

Dimenzioniranje čeličnih konstrukcij HR EN 1993

### **1.5 Antikorozivna zaštita**

Svi dijelovi čelične konstrukcije moraju biti zaštićeni od korozije prema odredbama "Pravilnika o tehničkim mjerama i uvjetima za zaštitu čeličnih konstrukcije od korozije". Kao vrsta zaštite od korozije odabrana je zaštita pocinčavanjem. Ukupna debljina zaštitnog sloja usvaja se 200 μm. Svi djelovi konstrukcije se također premazuju i završnim slojem premaza. Nakon završene izvedbe svakog sloja potrebno je provjeriti debljinu i prionjivost namaza.

## **1.6 Protupožarna zaštita**

Svi elementi konstrukcije se moraju zaštititi specijalnim premazima otpornim na visoke temperature. Industrijsku halu je potrebno opremiti protupožarnim vatrogasnim aparatima u slučaju nastanka požara. Svi vatrogasni aparati moraju biti ispravni i uredno servisirani te moraju biti postavljeni na lako dostupnim i vidljivim mjestima.

## **1.7 Uvjeti za izradu čelične konstrukcije**

Izrada čelične konstrukcije mora se povjeriti onom izvođaču koji ima odgovarajuće reference već izvedenih sličnih elemenata konstrukcije. U tehničkoj dokumentaciji predviđena je vrsta i kvaliteta materijala od kojeg treba izraditi konstrukciju. Odstupanja u kvaliteti materijala može odobriti jedino projektant konstrukcije. Prije isporuke konstrukcije na gradilište vrši se prijem konstrukcije u radionici zajedno sa kompletnom dokumentacijom o izvedenoj kvaliteti elemenata.

## **1.8 Opće napomene za izradu čelične konstrukcije u radionici**

Prilikom rezanja materijala treba paziti na mogućnost pojave lokalnih zarez. Svaki uočeni zarez potrebno je izbrusiti ili dovariti i izbrusiti. Svi elementi trebaju biti izrađeni u granicama dopuštenih odstupanja. Premaše li odstupanja granične vrijednosti, potrebno je zatražiti suglasnost projektanta na izvedeno stanje. Kod zavarivačkih radova potrebno je osigurati stalnu kontrolu prije, u toku i nakon izvedenih radova. Poslije izvedenih radova potrebno je obaviti vizualnu i dimenzionalnu kontrolu te kontrole predviđene projektom. Prilikom izvođenja zavarivačkih radova potrebno je voditi računa da konstrukcija u fazi hlađenja ne poprimi nepovoljni deformirani oblik. Ne dopušta se zavarivanje na temperaturi nižoj od 0 °C.

## 2 ANALIZA OPTEREĆENJA

### 2.1 Stalno djelovanje

- Solarni paneli.....0,20 kN/m<sup>2</sup>
  - Sendvič paneli (aluminij) .....0,10 kN/m<sup>2</sup>
  - Sekundarna krovna konstrukcija .....0,08 kN/m<sup>2</sup>
  - Instalacije .....0,02 kN/m<sup>2</sup>
- $\Sigma = 0,40 \text{ kN/m}^2$

### 2.2 Djelovanje snijega

Za lokaciju građevine u zoni I iz karte klimatskih zona karakterističnog opterećenja snijegom, za nadmorsku visinu od 0-100 m, očitana je karakteristična vrijednost opterećenja snijega na tlu:

$$S_k = 0,50 \text{ kN/m}^2$$

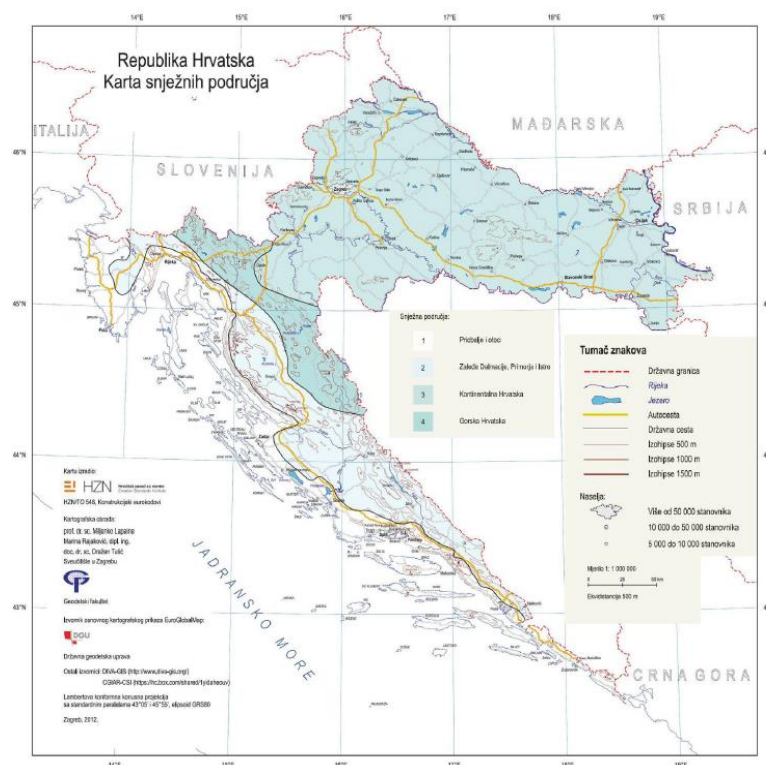

Slika 1: Karta opterećenja snijegom za RH

Nadmorska visina do [m]	1. područje – priobalje i otoci [kN/m <sup>2</sup> ]	2. područje – zaleđe Dalmacije, Primorja i Istre [kN/m <sup>2</sup> ]	3. područje – kontinentalna Hrvatska [kN/m <sup>2</sup> ]	4. područje – gorska Hrvatska [kN/m <sup>2</sup> ]
100	0,50	0,75	1,00	1,25
200	0,50	0,75	1,25	1,50
300	0,50	0,75	1,50	1,75
400	0,50	1,00	1,75	2,00
500	0,50	1,25	2,00	2,50
600	0,50	1,50	2,25	3,00
700	0,50	2,00	2,50	3,50
800	0,50	2,50	2,75	4,00
900	1,00	3,00	3,00	4,50
1 000	2,00	4,00	3,50	5,00
1 100	3,00	5,00	4,00	5,50
1 200	4,00	6,00	4,50	6,00
1 300	5,00	7,00		7,00
1 400	6,00	8,00		8,00
1 500		9,00		9,00
1 600		10,00		10,00
1 700		11,00		11,00
1 800		12,00		

**Tablica 1:** Opterećenje snijegom za sniježna područja i pripadajuće nadmorske visine

Opterećenje snijegom na krovu „s”:

$$s = s_k \cdot \mu_i \cdot C_e \cdot C_t$$

gdje je:

$$\mu_i = 0,8 \text{ (koeficijent oblika za kut nagiba krova: } 0^\circ < 4^\circ < 30^\circ \text{)}$$

$$C_e = 1,0 \text{ (koeficijent izloženosti)}$$

$$C_t = 1,0 \text{ (temperaturni koeficijent)}$$

$$s = s_k \cdot \mu_i \cdot C_e \cdot C_t = 0,50 \cdot 0,8 \cdot 1,0 \cdot 1,0 = 0,40 \text{ kN/m}^2$$

## 2.3 Djelovanje vjetra

- pritisak vjetra na vanjske površine:  $w_e = q_p \cdot c_e(z_e) \cdot c_{pe}$  [kN/m<sup>2</sup>]

- pritisak vjetra na unutarnje površine:  $w_i = q_p \cdot c_e(z_i) \cdot c_{pi}$  [kN/m<sup>2</sup>]

Gdje je:

$q_{ref}$  – poredbeni tlak vjetra pri srednjoj brzini vjetra

$C_e(z_e); C_e(z_i)$  – koeficijenti izloženosti koji uzimaju u obzir neravnine terena

$z_e; z_i$  – poredbene visine za lokalni ili unutarnji tlak

$c_{pe}; c_{pi}$  – vanjski i unutarnji koeficijent pritiska

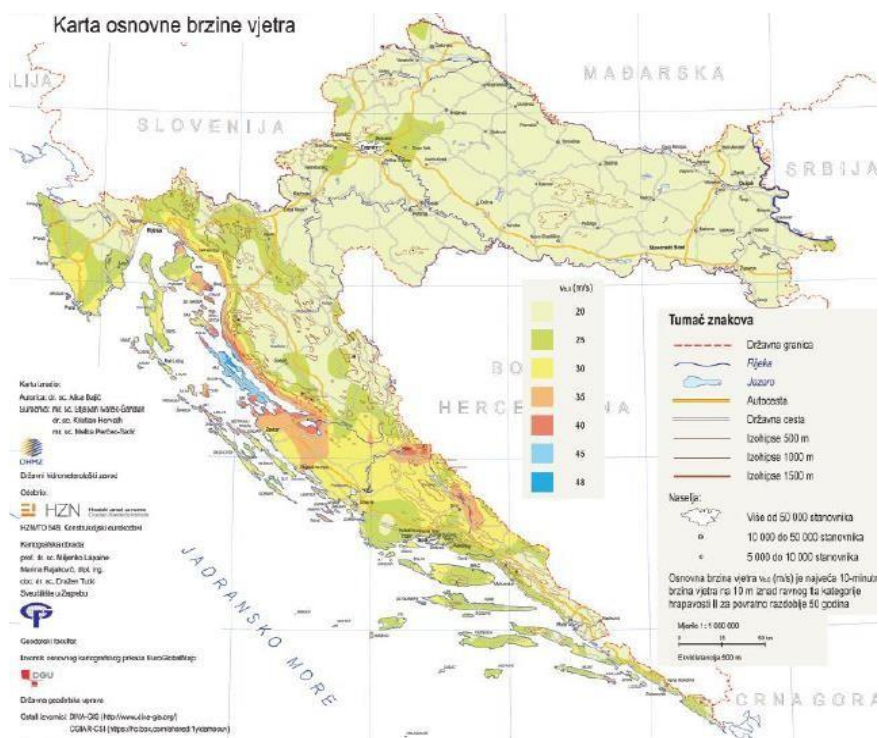

Slika 2: Prikaz karte osnovnih brzina vjetra za RH

$$q_b = \frac{1}{2} \cdot \rho \cdot v_b^2 \text{ [kN/m}^2\text{]}$$

gdje je:

$v_b$  – osnovna brzina vjetra

$\rho$  – gustoća zraka ( $\rho=1,25 \text{ kg/m}^3$ )

Osnovna brzina vjetra  $v_b$  dana je izrazom:

$$v_b = c_{dir} \cdot c_{season} \cdot v_{b0}$$

gdje je:

$v_b$  – osnovna brzina vjetra

$c_{dir}$  – koeficijent smjera vjetra (obično uzima vrijednost 1,0)

$c_{season}$  – koeficijent ovisan o godišnjem dobu (obično uzima vrijednost 1,0)

Osnovni pritisak vjetra:

$v_b = 30 \text{ m/s}$  - očitano za otok Brač

$$c_{dir} \cdot c_{season} = 1.0$$

$$v_b = v_{b,0} \cdot c_{dir} \cdot c_{season} = 30 \cdot 1.0 \cdot 1.0 = 30.0 \text{ m/s}$$

$$\rho = 1.25 \text{ kg/m}^3$$

$$q_b = \frac{\rho}{2} \cdot v_b^2 = \frac{1,25}{2} \cdot 30,0^2 = 562,5,4(N / m^2) = 0,56(kN / m^2)$$

Faktor terena  $k_r$  -za kategoriju terena II (Područja s niskom vegetacijom i izoliranim preprekama):

$$k_r = 0,19 \cdot \left( \frac{z_0}{z_{0,II}} \right)^{0,07} = 0,19 \cdot \left( \frac{0,05}{0,05} \right)^{0,07} = 0,19$$

$$C_{r(z)} = k_r \cdot \ln \left( \frac{z}{z_0} \right) = 0,19 \cdot \ln \left( \frac{5,36}{0,05} \right) = 0,89$$



$$C_{0(z)} = 1,0$$

Srednja brzina vjetra iznad terena:

$$v_m = v_b \cdot C_{r(z)} \cdot C_{0(z)} = 30 \cdot 0,89 \cdot 1,0 = 26,65 \text{ m/s}$$

Intezitet turbulencije:

$$I_{v(z)} = \frac{k_I}{C_{0(z)} \cdot \ln\left(\frac{z}{z_0}\right)} = \frac{1}{1 \cdot \ln\left(\frac{5,36}{0,05}\right)} = 0,213$$

Pritisak brzine vjetra pri udaru:

$$q_{p(z)} = [1 + 7 \cdot I_{v(z)}] \cdot 0,5 \cdot \rho \cdot v_m^2 = [1 + 7 \cdot 0,213] \cdot 0,5 \cdot 1,25 \cdot 26,65^2 \cdot 10^{-3} = 11,05 \text{ kN/m}^2$$

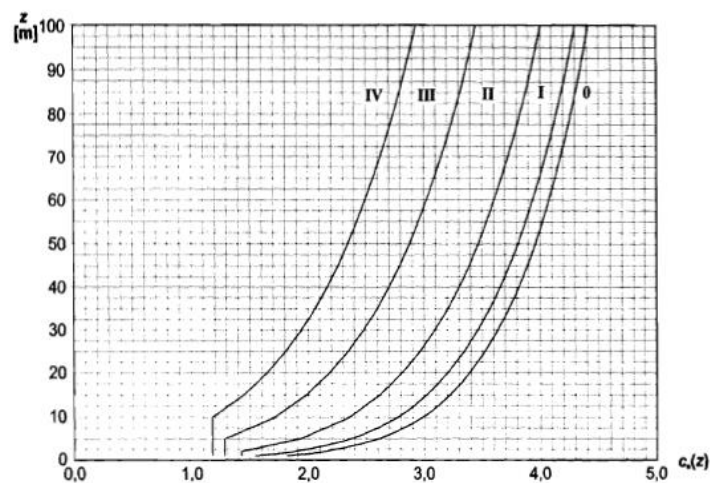

Slika 4.2: Prikazi koeficijenta izloženosti  $c_e(z)$  za  $c_{0(z)} = 1,0$ ,  $k_1 = 1,0$

**Slika 3:** Prikazi koeficijenata izloženosti

$C_{e(z)} = 2,0$  - očitani faktor izloženosti

$q_b$  je tlak pri osnovnoj brzini i on se može dobiti kao:  $q_b = \frac{1}{2} \rho v_b^2$ , što daje vrijednost od 0.56 kN/m<sup>2</sup>.

$$q_p(z) = 2 * 0,56 = 1,12 \text{ kN/m}^2.$$

Pritisak vjetra na vanjske površine:  $w_e = q_p * c_e(z_e) * c_{pe}$  [kN/m<sup>2</sup>]

Pritisak vjetra na unutarnje površine:  $w_i = q_p * c_e(z_i) * c_{pi}$  [kN/m<sup>2</sup>]

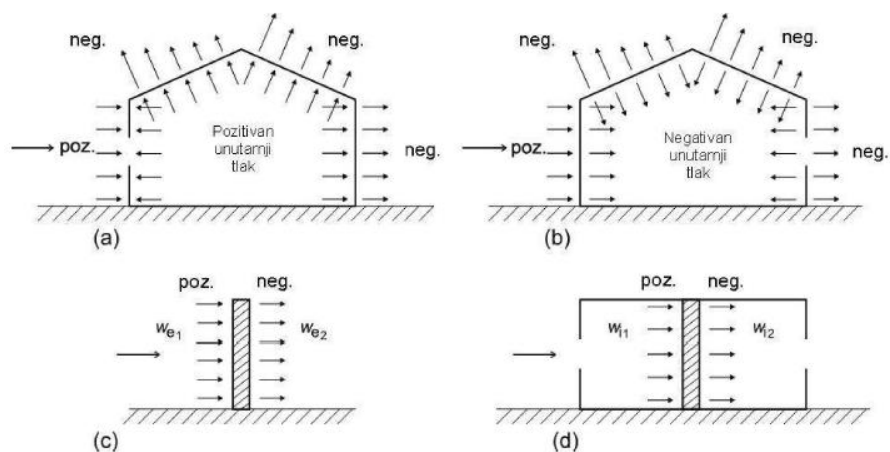

**Slika 4:** Tlak na površine

Odabrani koeficijenti tlaka su za ravne krovove. Ravni krovovi su definirani kao ravni ako imaju kosinu između  $-5^\circ < \alpha < 5^\circ$ . Različiti koeficijenti tlaka su definirani za svako područje.

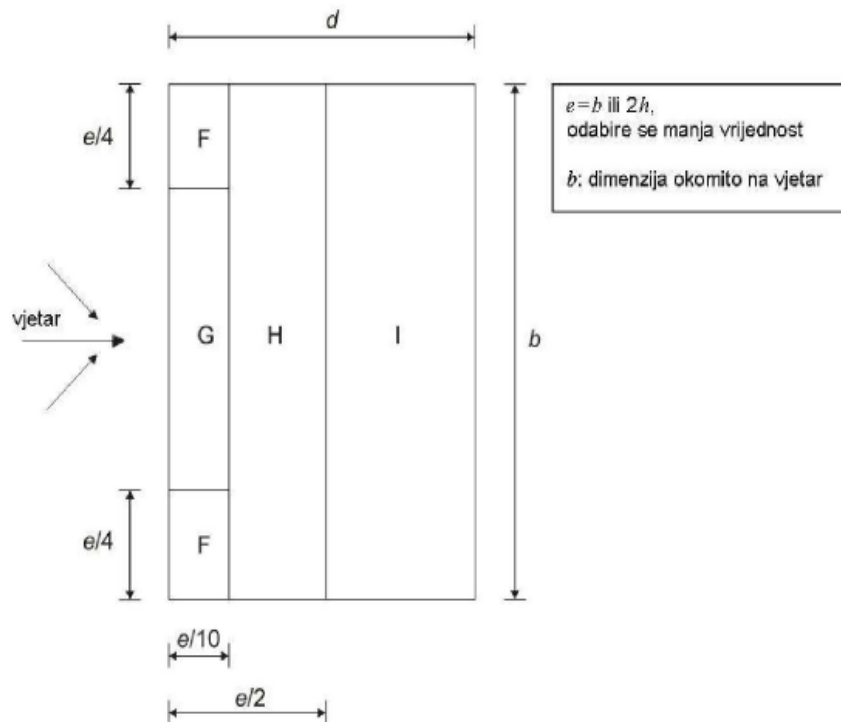

Slika 5 : Legenda za ravne krovove

Vrsta krova	Područje							
	F		G		H		I	
	$c_{pe,10}$	$c_{pe,1}$	$c_{pe,10}$	$c_{pe,1}$	$c_{pe,10}$	$c_{pe,1}$	$c_{pe,10}$	$c_{pe,1}$
Oštri zabati	-1,8	-2,5	-1,2	-2,0	-0,7	-1,2	+0,2	-0,2

Tablica 2 : Preporučene vrijednosti koeficijena vanjskog tlaka za ravne krovove

U proračunu se uzima u obzir da unutarnji i vanjski tlakovi djeluju u isto vrijeme. Najnepovoljnija kombinacija vanjskih i unutarnjih tlakova se uzima u obzir.

$C_{pi}$  iznosi +/- 0.25.

-Vanjski pritisak vjetra

područje	F	G	H	I
cpe	-1,8	-1,2	-0,7	0,2
we	-2,016	-1,344	-0,784	0,224

-Unutarnji pritisak vjetra (+)

područje	F	G	H	I
cpi +	0,25	0,25	0,25	0,25
wi +	0,28	0,28	0,28	0,28

-Unutarnji pritisak vjetra (-)

područje	F	G	H	I
cpi -	-0,25	-0,25	-0,25	-0,25
wi -	-0,28	-0,28	-0,28	-0,28

-Rezultantno djelovanje vjetra

područje	F	G	H	I
we +	-1,736	-1,064	-0,504	0,504
we -	-2,296	-1,624	-1,064	-0,056

### 3 GLAVNA NOSIVA KONSTRUKCIJA

#### 3.1 Odabir IPE profila glavne nosive konstrukcije krova

Svi saćasti IPE profili su jednake duljine ( 12,00 m ) i jednake kvalitete čelika ( S355 )  
Kod odabira odgovarajućeg IPE profila najveću važnost pridodajemo nosivosti, težini samih elemenata, jednostavnosti izrade u postrojenju i jednostavnosti montaže na samome gradilištu. Duljina rezanja i duljina zavora najviše utječu na jednostavnost izrade pojedinog elementa, a samim time i utječu na konačnu ukupnu cijenu svih elemenata.

Oznaka	Masa (kg)	Površina rezanja (cm <sup>2</sup> )	Duljina zavora (cm)	Broj polja
IPE 220	317	709	1202	11
IPE 240	371	744	1200,8	10
IPE 270	436	793	1201,2	9
IPE 300	511	852	1200,8	8

U obzir su uzeta četiri saćasta nosača, te je svaki posebno dimenzioniran.

#### 3.2 Način izvedbe glavne nosive konstrukcije

Kod izvedbe sustava nosača "Angelina" koristi se standardan IPE profil koji se posebnim rezom hrpta reže te naknadno sastavlja. Prednosti ovog načina izvedbe je povećanje statičke visine standardnog IPE profila uz istu masu, mogućnost provođenja instalacija te sam estetski izgled.

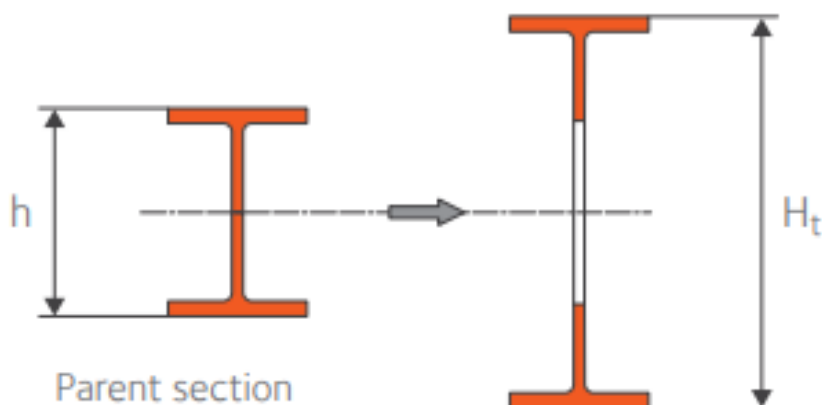

Slika 6 : Povećanje statičke visine IPE nosača

Angelina™  
stage 1: flame cutting



stage 2: separation of T-sections



stage 3: re-assembly & welding



Slika 7 : Sustav greda "Angelina"

### 3.3 Dimenzioniranje nosača

#### 3.3.1. Sačasti nosač IPE 220

IPE 220



## Parameters

### General Parameters

#### Non composite Beam

End supports :	Simply supported beam
Horizontal span length :	$L = 12.00 \text{ m}$
Total number of openings :	$n = 11$
Dimensions of the openings :	
Height :	$a_0 = 200.0 \text{ mm}$
Length of the sinusoide :	$s = 260.0 \text{ mm}$
Length of the flat part :	$w_0 = 260.0 \text{ mm}$
Web post width :	$w_p = w_0 = 260.0 \text{ mm}$
Spacing between openings center :	$e = 2s + w_0 + w_p = 1040 \text{ mm}$
End web posts widths :	$w_{\text{end,l}} = 410.0 \text{ mm}$ $w_{\text{end,r}} = 410.0 \text{ mm}$
Mass :	$m = 317 \text{ kg}$
Total paint surface :	$S = 11.43 \text{ m}^2$
Paint surface (without upper face) :	$S' = 10.11 \text{ m}^2$
Massiveness :	$M = 283.03 \text{ m}^{-1}$
Massiveness (without upper face) :	$M' = 250.33 \text{ m}^{-1}$

### Checking of the ANGELINA scope

Spacing cutting / flange inner face :	$d = 50.80 \text{ mm}$	$\geq 50.00 \text{ mm}$	OK
Spacing cutting / web-flange root :	$d = 38.80 \text{ mm}$	$\geq 10.00 \text{ mm}$	OK
Dimensions of an opening :	$(2b+w)/a = 3.90$	$\leq 5.00$	OK
Web slenderness :	$h_w / t_w = 47.05$	$\leq 124.0 \epsilon_w = 100.9$	OK

### Position of the beam

The studied beam is an intermediate beam.

Spacing of the beam	- to the adjacent left beam :	$L_1 = 3.350 \text{ m}$
	- to the adjacent right beam :	$L_2 = 3.350 \text{ m}$

Width for the calculation of the surface loads supported by the beam :	
on the left side :	$d_1 = 1.675 \text{ m}$
on the right side :	$d_2 = 1.675 \text{ m}$
Total width :	$d_1 + d_2 = 3.350 \text{ m}$

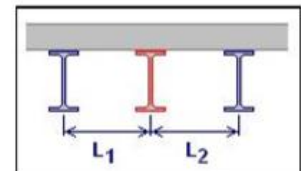

### Lateral restraint

Concentrated lateral restraints :

	x (m)	Lateral restraints	
1	0.0	Both flanges	Origin section
2	12.00	Both flanges	End section

**Cross-section**

	Upper chord	Lower chord
Base profile	IPE 220	IPE 220
Grade	S355 JR/J0/J2/K2	S355 JR/J0/J2/K2
$h_t$ (mm)	220.0	220.0
$b_f$ (mm)	110.0	110.0
$t_f$ (mm)	9.2	9.2
$t_w$ (mm)	5.9	5.9
$r_c$ (mm)	12.0	12.0

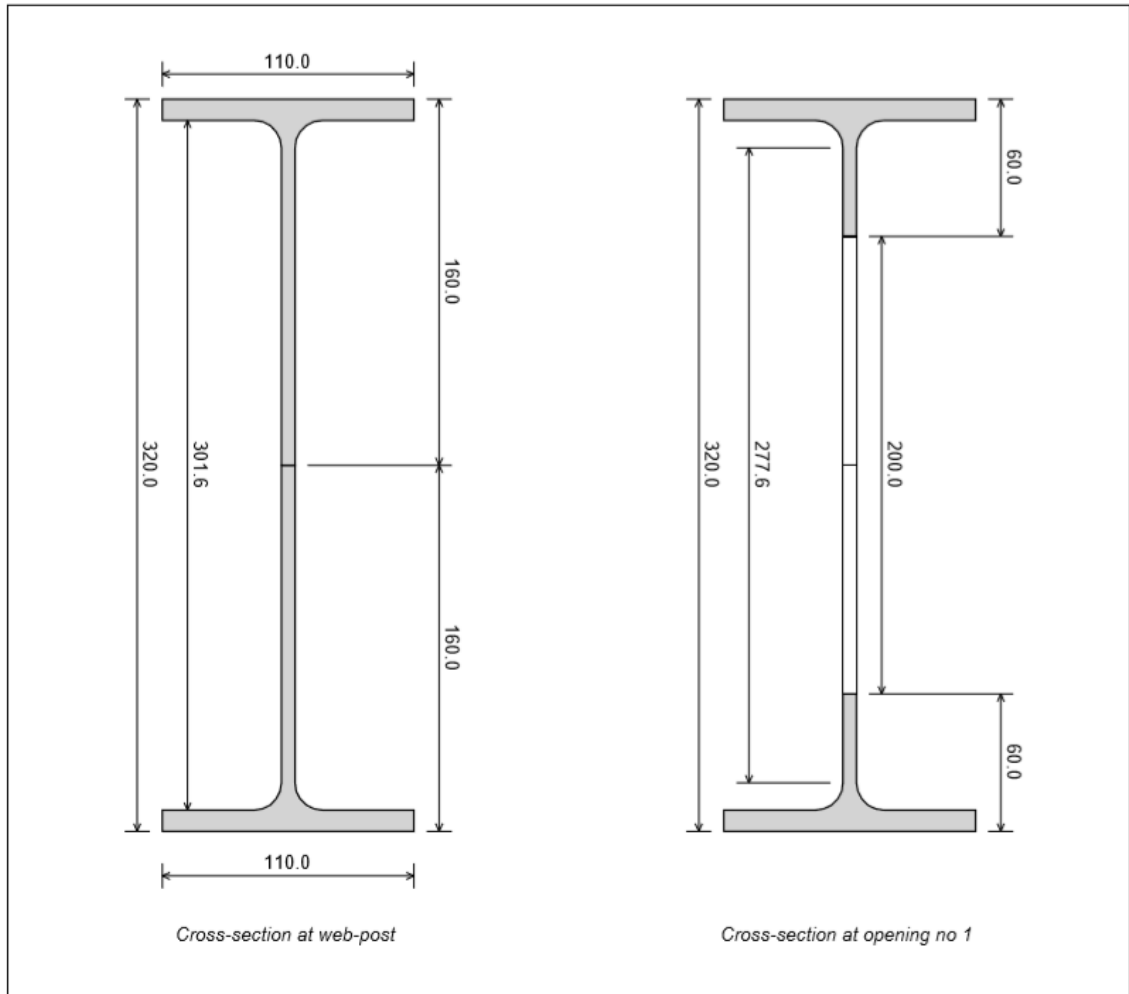

**Cross-section properties**

	Gross section	Net section
Area (cm <sup>2</sup> )	39.27	27.47
Position of the centroid (mm)	160.0	160.0
Inertia /yy (cm <sup>4</sup> )	6509	6116
Inertia /zz (cm <sup>4</sup> )	205.0	204.6



## Load cases

### Permanent loads (G)

Dead load :	0.26 kN/m	
Arising from :	Mass of the steel beam :	317 kg
Reactions at supports :	Left end :	$R_{Av} = 1.55 \text{ kN}$
	Right end :	$R_{Bv} = 1.55 \text{ kN}$

### Live loads 1 (Q1)

Psi factor  $\psi_0 = 0.70$

Distributed loads :

	Location $x_1$ (m)	Intensity $q_1$ (kN/m)	Location $x_2$ (m)	Intensity $q_2$ (kN/m)	Orientation
1	0.0	1.340	12.00	1.340	Vertical
2	0.0	1.340	12.00	1.340	Vertical

Reactions at supports :	Left end :	$R_{Av} = 16.08 \text{ kN}$
	Right end :	$R_{Bv} = 16.08 \text{ kN}$

### Live loads 2 (Q2)

Psi factor  $\psi_0 = 0.70$

Distributed loads :

	Location $x_1$ (m)	Intensity $q_1$ (kN/m)	Location $x_2$ (m)	Intensity $q_2$ (kN/m)	Orientation
1	0.0	-7.692	12.00	-7.692	Vertical

Reactions at supports :	Left end :	$R_{Av} = -46.15 \text{ kN}$
	Right end :	$R_{Bv} = -46.15 \text{ kN}$

### Partial factors

Factors on the loads :	$\gamma_{G,sup} = 1.350$
	$\gamma_{G,inf} = 1.000$
	$\gamma_Q = 1.500$

Factors on the resistance :	$\gamma_{M0} = 1.000$
	$\gamma_{M1} = 1.000$
	$\gamma_{M2} = 1.250$
	$\gamma_{M,fi} = 1.000$

### Steel properties

	Both chords
Steel	S355 JR/J0/J2/K2
Reduction curve from	EN 10025-2
Standard	EN 10025-2 : 2004
Flange $f_y$   $f_u$ (MPa)	355   470
Web $f_y$   $f_u$ (MPa)	355   470
Cross-section $f_y$   $f_u$ (MPa)	355   470
Cross-section $\epsilon$	0.814

### Load combinations

Ultimate Limit States	U1 =	1.35 G + 1.50 Q1 + 1.05 Q2
	U5 =	1.35 G + 1.50 Q1 + 1.50 Q2

Serviceability Limit States	S1 =	1.00 G + 1.00 Q1
-----------------------------	------	------------------



### Live loads 1 (Q1)

Reactions at supports :                      Left end :                       $R_{Av} = 16.08 \text{ kN}$   
Right end :                       $R_{Bv} = 16.08 \text{ kN}$

Maximum moment :                       $M_{Max} = 48.24 \text{ kNm}$  in section no 13

Maximum shear force :                       $V_{Max} = -16.08 \text{ kN}$  in section no 1

	x (m)	M (kNm)	$V_L$ (kN)	$V_R$ (kN)	$N_L$ (kN)	$N_R$ (kN)
1	0.000	0.00	-	-16.08	-	0.0
2	0.205	3.24	-15.53	-15.53	0.0	0.0
3	0.800	12.01	-13.94	-13.94	0.0	0.0
4	1.320	18.89	-12.54	-12.54	0.0	0.0
5	1.840	25.05	-11.15	-11.15	0.0	0.0
6	2.360	30.49	-9.76	-9.76	0.0	0.0
7	2.880	35.20	-8.36	-8.36	0.0	0.0
8	3.400	39.18	-6.97	-6.97	0.0	0.0
9	3.920	42.44	-5.57	-5.57	0.0	0.0
10	4.440	44.98	-4.18	-4.18	0.0	0.0
11	4.960	46.79	-2.79	-2.79	0.0	0.0
12	5.480	47.88	-1.39	-1.39	0.0	0.0
13	6.000	48.24	0.00	0.00	0.0	0.0
14	6.520	47.88	1.39	1.39	0.0	0.0
15	7.040	46.79	2.79	2.79	0.0	0.0
16	7.560	44.98	4.18	4.18	0.0	0.0
17	8.080	42.44	5.57	5.57	0.0	0.0
18	8.600	39.18	6.97	6.97	0.0	0.0
19	9.120	35.20	8.36	8.36	0.0	0.0
20	9.640	30.49	9.76	9.76	0.0	0.0
21	10.160	25.05	11.15	11.15	0.0	0.0
22	10.680	18.89	12.54	12.54	0.0	0.0
23	11.200	12.01	13.94	13.94	0.0	0.0
24	11.795	3.24	15.53	15.53	0.0	0.0
25	12.000	0.00	16.08	-	0.0	-



**Under ULS Combinations**

$$U1 = 1.35 G + 1.50 Q1 + 1.05 Q2$$

Reactions at supports : Left end :  $R_{Av} = -22.24 \text{ kN}$   
 Right end :  $R_{Bv} = -22.24 \text{ kN}$

Maximum moment :  $M_{Max} = -66.72 \text{ kNm}$  in section no 13  
 Maximum shear force :  $V_{Max} = 22.24 \text{ kN}$  in section no 1

	x (m)	M (kNm)	$V_L$ (kN)	$V_R$ (kN)	$N_L$ (kN)	$N_R$ (kN)
1	0.000	0.00	-	22.24	-	0.0
2	0.205	-4.48	21.48	21.48	0.0	0.0
3	0.800	-16.61	19.28	19.28	0.0	0.0
4	1.320	-26.13	17.35	17.35	0.0	0.0
5	1.840	-34.65	15.42	15.42	0.0	0.0
6	2.360	-42.17	13.49	13.49	0.0	0.0
7	2.880	-48.68	11.57	11.57	0.0	0.0
8	3.400	-54.19	9.64	9.64	0.0	0.0
9	3.920	-58.70	7.71	7.71	0.0	0.0
10	4.440	-62.21	5.78	5.78	0.0	0.0
11	4.960	-64.72	3.86	3.86	0.0	0.0
12	5.480	-66.22	1.93	1.93	0.0	0.0
13	6.000	-66.72	0.00	0.00	0.0	0.0
14	6.520	-66.22	-1.93	-1.93	0.0	0.0
15	7.040	-64.72	-3.86	-3.86	0.0	0.0
16	7.560	-62.21	-5.78	-5.78	0.0	0.0
17	8.080	-58.70	-7.71	-7.71	0.0	0.0
18	8.600	-54.19	-9.64	-9.64	0.0	0.0
19	9.120	-48.68	-11.57	-11.57	0.0	0.0
20	9.640	-42.17	-13.49	-13.49	0.0	0.0
21	10.160	-34.65	-15.42	-15.42	0.0	0.0
22	10.680	-26.13	-17.35	-17.35	0.0	0.0
23	11.200	-16.61	-19.28	-19.28	0.0	0.0
24	11.795	-4.48	-21.48	-21.48	0.0	0.0
25	12.000	0.00	-22.24	-	0.0	-

Open.	Sect.	$N_{m,top}$ (kN)	$N_{m,bot}$ (kN)	$V_{m,top}$ (kN)	$V_{m,bot}$ (kN)
1	3	-55.904	55.904	9.638	9.638
2	5	-116.641	116.641	7.710	7.710

Open.	Sect.	$N_{m,top}$ (kN)	$N_{m,bot}$ (kN)	$V_{m,top}$ (kN)	$V_{m,bot}$ (kN)
3	7	-163.880	163.880	5.783	5.783
4	9	-197.622	197.622	3.855	3.855
5	11	-217.867	217.867	1.928	1.928
6	13	-224.616	224.616	0.000	0.000
7	15	-217.867	217.867	-1.928	-1.928
8	17	-197.622	197.622	-3.855	-3.855
9	19	-163.880	163.880	-5.783	-5.783
10	21	-116.641	116.641	-7.710	-7.710
11	23	-55.904	55.904	-9.638	-9.638

$$U5 = 1.35 G + 1.50 Q1 + 1.50 Q2$$

Reactions at supports :

Left end :

$$R_{Av} = -43.01 \text{ kN}$$

Right end :

$$R_{Bv} = -43.01 \text{ kN}$$

Maximum moment :

$$M_{Max} = -129.0 \text{ kNm in section no 13}$$

Maximum shear force :

$$V_{Max} = 43.01 \text{ kN in section no 1}$$

	x (m)	M (kNm)	$V_L$ (kN)	$V_R$ (kN)	$N_L$ (kN)	$N_R$ (kN)
1	0.000	0.0	-	43.01	-	0.0
2	0.205	-8.7	41.54	41.54	0.0	0.0
3	0.800	-32.1	37.27	37.27	0.0	0.0
4	1.320	-50.5	33.55	33.55	0.0	0.0
5	1.840	-67.0	29.82	29.82	0.0	0.0
6	2.360	-81.5	26.09	26.09	0.0	0.0
7	2.880	-94.1	22.36	22.36	0.0	0.0
8	3.400	-104.8	18.64	18.64	0.0	0.0
9	3.920	-113.5	14.91	14.91	0.0	0.0
10	4.440	-120.3	11.18	11.18	0.0	0.0
11	4.960	-125.2	7.45	7.45	0.0	0.0
12	5.480	-128.1	3.73	3.73	0.0	0.0
13	6.000	-129.0	0.00	0.00	0.0	0.0
14	6.520	-128.1	-3.73	-3.73	0.0	0.0
15	7.040	-125.2	-7.45	-7.45	0.0	0.0
16	7.560	-120.3	-11.18	-11.18	0.0	0.0
17	8.080	-113.5	-14.91	-14.91	0.0	0.0
18	8.600	-104.8	-18.64	-18.64	0.0	0.0
19	9.120	-94.1	-22.36	-22.36	0.0	0.0
20	9.640	-81.5	-26.09	-26.09	0.0	0.0

	x (m)	M (kNm)	V <sub>L</sub> (kN)	V <sub>R</sub> (kN)	N <sub>L</sub> (kN)	N <sub>R</sub> (kN)
21	10.160	-67.0	-29.82	-29.82	0.0	0.0
22	10.680	-50.5	-33.55	-33.55	0.0	0.0
23	11.200	-32.1	-37.27	-37.27	0.0	0.0
24	11.795	-8.7	-41.54	-41.54	0.0	0.0
25	12.000	0.0	-43.01	-	0.0	-

Open.	Sect.	N <sub>m,top</sub> (kN)	N <sub>m,bot</sub> (kN)	V <sub>m,top</sub> (kN)	V <sub>m,bot</sub> (kN)
1	3	-108.108	108.108	18.637	18.637
2	5	-225.559	225.559	14.910	14.910
3	7	-316.910	316.910	11.182	11.182
4	9	-382.160	382.160	7.455	7.455
5	11	-421.311	421.311	3.727	3.727
6	13	-434.361	434.361	0.000	0.000
7	15	-421.311	421.311	-3.727	-3.727
8	17	-382.160	382.160	-7.455	-7.455
9	19	-316.910	316.910	-11.182	-11.182
10	21	-225.559	225.559	-14.910	-14.910
11	23	-108.108	108.108	-18.637	-18.637

## ULTIMATE LIMIT STATES (ULS)

**Note: the calculation method applies to steel rolled profiles only.**

### Summary of the criteria

S = Satisfactory NS = Not satisfactory

#### Checkings of net sections at openings

Resistance to shear force (Open. no 1 - Comb. U5) :	$\Gamma_{V,max}$	= 0.182	< 1	S
Resistance to M+N interaction (Open. no 7 - Comb. U5) :	$\Gamma_{MN,max}$	= 1.051	> 1	NS
Resistance to M+N+V interaction (Open. no 7 - Comb. U5) :	$\Gamma_{MNV,max}$	= 1.051	> 1	NS

#### Web checkings

Shear buckling check required (Post no 1 - Comb. U5) :	$\Gamma_{Vbw,max}$	= 0.081	< 1	S
--	--------------------	---------	-----	---

#### Posts checkings

Resistance to shear (Post no 1 - Comb. U5) :	$\Gamma_{Vh,max}$	= 0.287	< 1	S
--	-------------------	---------	-----	---

Minimum throat thickness

Intermediate posts (Post no 1 - Comb. U5) :  $a_{min} = 0.94$  mm

Warning: the throat thickness is assessed by assuming two welds

The total thickness of welds should be at least 1.87 mm

End posts (Post no 11 - Comb. U5) :  $a_{min} = 0.59$  mm

The calculation for end posts does not take into account the details of the joint

Warning : the throat thickness of the fillet weld must be at least 3 mm (EC3)

#### Gross sections checkings

Resistance to bending (Post no 6 - Comb. U5) :	$\Gamma_{Mg,max}$	= 0.772 (Classe 1)	< 1	S
Resistance to shear (Left end - Comb. U5) :	$\Gamma_{Vg,max}$	= 0.096	< 1	S

#### Other checkings

Resistance to lateral torsional buckling	$\Gamma_{LT,max}$	= 28.400	> 1	NS
--	-------------------	----------	-----	----

### ULS Combinations checkings

#### ULS Combination U1

$$U1 = 1.35 G + 1.50 Q1 + 1.05 Q2$$

#### Verifications in the openings sections

Open.	$\Gamma_V$	$\Gamma_{MN}$	$\Gamma_{MNV}$
1	0.094	0.376	0.376
2	0.075	0.371	0.371
3	0.057	0.388	0.388
4	0.038	0.406	0.406
5	0.019	0.406	0.406
6	0.000	0.382	0.382
7	0.019	0.406	0.406
8	0.038	0.406	0.406
9	0.057	0.388	0.388
10	0.075	0.371	0.371
11	0.094	0.376	0.376

#### ULS Combination U5

$$U5 = 1.35 G + 1.50 Q1 + 1.50 Q2$$

#### Verifications in the openings sections

Open.	$\Gamma_V$	$\Gamma_{MN}$	$\Gamma_{MNV}$
1	0.182	0.750	0.750
2	0.146	0.812	0.812
3	0.109	0.922	0.922
4	0.073	1.017	1.017
5	0.036	1.051	1.051
6	0.000	1.004	1.004
7	0.036	1.051	1.051
8	0.073	1.017	1.017
9	0.109	0.922	0.922
10	0.146	0.812	0.812
11	0.182	0.750	0.750

### Detailed checkings

#### Net section at opening no 1 - Resistance to shear force

Combination U5

Bending moment	$M_{Ed}$	=	-32.11 kNm		
Shear forces	$V_{Ed,l}$	=	37.27 kN	$V_{Ed,r}$	= 37.27 kN
Axial forces	$N_{Ed,l}$	=	0.0 kN	$N_{Ed,r}$	= 0.0 kN

#### Top chord - Left cantilever arm

Axial force	$N_{m,Ed}$	=	-108.1 kN		
Shear force	$V_{m,Ed}$	=	-18.64 kN		
Location section / post	$x_{Sec}$	=	263.3 mm		
Height of the section	$h_{Sec}$	=	60.00 mm		
Position of the centroid	$d_{G,Te}$	=	11.47 mm		(about the external fibre of the flange)
Distances for the moment	$e_N$	=	0.0 mm	$e_V$	= 126.8 mm
Forces in the design section	$N_{S,Ed}$	=	-108.1 kN	$V_{S,Ed}$	= -18.64 kN
Moment in the design section	$M_{S,Ed}$	=	$V_{S,Ed} e_V - N_{S,Ed} e_N$		= -2.362 kNm
Yield strength	$f_y$	=	355.0 MPa	$\epsilon$	= 0.814
Shear area	$A_V$	=	499.1 mm <sup>2</sup>		
Partial factor	$\gamma_{M0}$	=	1.000		
Shear resistant force	$V_{c,Rd}$	=	102.3 kN		
Criterion	$\Gamma_V$	=	0.182		



**Opening no 7 - Resistance to MN interaction**

Combination U5

Bending moment	$M_{Ed}$	=	-125.2 kNm		
Shear forces	$V_{Ed,l}$	=	-7.455 kN	$V_{Ed,r}$	= -7.455 kN
Axial forces	$N_{Ed,l}$	=	0.0 kN	$N_{Ed,r}$	= 0.0 kN
Distributed load for local bending	$q_{Lin}$	=	-7168 N/m		

Class of a post (web)	$C_{wP}$	=	2	
Class of the opening	$C_{wT}$	=	2	
Reduction coefficient	$\rho_{hT}$	=	1.000	
Exposant for MN Interaction	Standard opening			$\alpha = 2.0$

Local bend. moment (upper chord)  $M_m = 0.2$  kNm

	Opening quarter			
	Upper LHS	Upper RHS	Lower LHS	Lower RHS
Location section / post $x_{Sec}$ (mm)	165.8	136.5	156.0	136.5
Height of the section $h_{Sec}$ (mm)	89.1	106.1	94.5	106.1
Position of the centroid $d_{G,Te}$ (mm)	18.5	23.3	20.0	23.3
$N_{S,Ed}$ (kN)	-421.3	-421.3	421.3	421.3
$V_{S,Ed}$ (kN)	3.7	-3.7	-3.7	3.7
$M_{S,Ed}$ (kNm)	3.8	4.0	-4.5	-4.0
$N_{Rd}$ (kN)	548.5	584.1	560.0	584.1
$\Gamma_N$	0.768	0.721	0.752	0.721
$M_{Rd}$ (kNm)	8.2	11.4	9.2	11.4
$\Gamma_M$	0.461	0.349	0.485	0.353
Criteria $\Gamma_{MN}$	1.051	0.869	1.051	0.874
Criteria $\Gamma_{MN}$ per chord	$\Gamma_{MN,Top} = 1.051$		$\Gamma_{MN,Bot} = 1.051$	
Final $\Gamma_{MN}$ criteria for the opening	$\Gamma_{MN} = 1.051$			

**Opening no 7 - Resistance to MNV interaction**

Combination U5

Bending moment	$M_{Ed}$	=	-125.2 kNm		
Shear forces	$V_{Ed,l}$	=	-7.455 kN	$V_{Ed,r}$	= -7.455 kN
Axial forces	$N_{Ed,l}$	=	0.0 kN	$N_{Ed,r}$	= 0.0 kN
Distributed load for local bending	$q_{Lin}$	=	-7168 N/m		

Class of a post (web)	$C_{wP}$	=	2	
Class of the opening	$C_{wT}$	=	2	
Reduction coefficient	$\rho_{hT}$	=	1.000	
Exposant for MN Interaction	Standard opening			$\alpha = 2.0$

Local bend. moment (upper chord)  $M_m = 0.2$  kNm

	Opening quarter			
	Upper LHS	Upper RHS	Lower LHS	Lower RHS
Location section / post $x_{Sec}$ (mm)	165.8	136.5	156.0	136.5
Height of the section $h_{Sec}$ (mm)	89.1	106.1	94.5	106.1
Position of the centroid $d_{G,Te}$ (mm)	18.5	23.3	20.0	23.3
$N_{S,Ed}$ (kN)	-421.3	-421.3	421.3	421.3
$V_{S,Ed}$ (kN)	3.7	-3.7	-3.7	3.7
$M_{S,Ed}$ (kNm)	3.8	4.0	-4.5	-4.0
$N_{Rd}$ (kN)	548.5	584.1	560.0	584.1
$\Gamma_N$	0.768	0.721	0.752	0.721
$V_{Rd}$ (kN)	137.4	158.0	144.1	158.0
$\Gamma_V$	0.027	0.024	0.026	0.024
$M_{Rd}$ (kNm)	8.2	11.4	9.2	11.4
$\Gamma_M$	0.461	0.349	0.485	0.353
Criteria $\Gamma_{MNV}$	1.051	0.869	1.051	0.874
Criteria $\Gamma_{MNV}$ per chord	$\Gamma_{MNV,Top} = 1.051$		$\Gamma_{MNV,Bot} = 1.051$	
Final $\Gamma_{MNV}$ criteria for the opening	$\Gamma_{MNV} = 1.051$			

### Shear buckling

Section at web post no 1

ULS Combination U5

Web dimensions	$h_w$	=	301.6 mm	$t_w$	=	5.9 mm
Yield strengths	$f_y$	=	355 MPa	$\varepsilon$	=	0.814

$h_w / t_w = 51.12 > 72\varepsilon / \eta = 48.82$  Shear buckling check is required

Reduced slenderness	$\lambda_w$	=	0.73
Reduction factor	$\chi_w$	=	1.14
Shear force	$V_{Ed}$	=	33.55 kN
Shear buckling resistance	$V_{bw,Rd}$	=	416.28 kN
Check	$\Gamma_{Vbw}$	=	0.081

### Resistance of Web post no 1 to horizontal shear

Combination U5

Tee geometrical centres	$d_G$	=	297.1 mm			
Bending moments	$M_{Ed,l}$	=	-32.11 kNm	$M_{Ed,r}$	=	-67.00 kNm
Axial forces in tees	$N_{m,Sup,l}$	=	-108.1 kN	$N_{m,Inf,l}$	=	108.1 kN
	$N_{m,Sup,r}$	=	-225.6 kN	$N_{m,Inf,r}$	=	225.6 kN
Horizontal shear force in post	$V_{hm}$	=	-117.5 kN			
In adjacent openings:	$\Gamma_{N,max}$	=	0.463			

Extra resistance parameters	$\Omega$	=	1.577	$\chi$	=	0.923
	$\xi$	=	0.188	$\beta$	=	0.500
Intermediate post - Extra resistance				$\eta$	=	1.300

Post width	$w$	=	260.0 mm
Resistant shear forces	$V_{hRd}$	=	408.73 kN
Checkings	$\Gamma_{Vh}$	=	0.287

### Bending resistance of gross sections

Section at web post no 6 (Section no 14) - Combination U5

Internal moment and force	$M_{Ed}$	=	-128.06 kNm	$N_{Ed}$	=	0.00 kN
---------------------------	----------	---	-------------	----------	---	---------

Lower flange under compression: Class 1

Class of the web

Steel	$f_{y,w}$	=	355 MPa	$\varepsilon_w$	=	0.814
Slenderness:	$c / t$	=	47.05			
Plastic distribution factor	$\alpha$	=	0.50			

Class of the web

1

Check of the resistance (Class1)

Steel	$f_{y,top}$	=	355 MPa	$f_{y,bot}$	=	355 MPa
Partial factor	$\gamma_{M0}$	=	1.00			
Plastic resistant moment	$M_{pl,Rd}$	=	165.79 kNm			
Check	$\Gamma_{Mg}$	=	0.772			

### Shear resistance of gross sections

Section at left end (Section no 1) - Combination U5

Height of the cross-section	$h$	=	320.0 mm			
Shear area	$A_{v,top}$	=	1089.1 mm <sup>2</sup>	$A_{v,bot}$	=	1089.1 mm <sup>2</sup>
Yield strengths	$f_{y,top}$	=	355 MPa	$f_{y,bot}$	=	355 MPa
Shear design force	$V_{Ed}$	=	43.01 kN			
Shear resistance force	$V_{plRd}$	=	446.43 kN	$\gamma_{M0}$	=	1.00
Check	$\Gamma_{Vg}$	=	0.096			

### Resistance to lateral torsional buckling

Combination U5

Check of lower flange

Part between sections laterally maintained in  $x = 0.0$  m and  $x = 12.00$  m

Length of the part	$L$	=	12.00 m		
Moments at ends	$M_{end,l}$	=	0.00 kNm	$M_{end,r}$	= 0.00 kNm
Maximum moment	$M_{Ed}$	=	129.03 kNm		
Maximum normal force in chord	$N_{Ed}$	=	434.36 kN		
Properties of the chord section	$A_0$	=	1373.5 mm <sup>2</sup>	$I_{z,0}$	= 102.3 cm <sup>4</sup>
Yielding strength	$f_y$	=	355 MPa		
Height of the tee	$h_{Te}$	=	60.0 mm		
Isostatic moment distribution	$C_1$	=	1.132		
Critical normal force	$N_{cr}$	=	16.67 kN		

Reduced slenderness	$\lambda_b$	=	5.408
Reduction factor (curve "c")	$\chi$	=	0.031
Partial factor	$\gamma_{M1}$	=	1.000
Resistant normal force	$N_{b,Rd}$	=	15.29 kN
Check	$\Gamma_{LT}$	=	28.400

### Minimal throat thickness at post no 1

Combination U5

Width of the post	$w$	=	260.0 mm		
Ultimate strength	$f_u$	=	470.0 MPa	$\beta_w$	= 0.90
Moments at openings sections	$M_{Ed,l}$	=	-32.11 kNm	$M_{Ed,r}$	= -67.00 kNm
Spacings between tee chords	$d_{G,l}$	=	297.1 mm	$d_{G,r}$	= 297.1 mm
Axial forces in lower chords	$N_{m,Ed,l}$	=	-108.1 kN	$N_{m,Ed,r}$	= -225.6 kN
Force and moment in the post	$V_{h,Ed}$	=	117.5 kN	$M_{h,Ed}$	= 0.0 kNm
Partial factor	$\gamma_{M2}$	=	1.25		
Throat thickness	$a$	=	0.936 mm		

Warning: the throat thickness is assessed by assuming two welds  
The total thickness of welds should be at least 1.87 mm

## SERVICEABILITY LIMIT STATES (SLS)

### Deflections

$v$  : Maximum vertical deflection of the beam

#### Under elementary load cases

Permanent loads (G) :	$v = 6.07$ mm (S13)	=	$L / 1978$
Live loads 1 (Q1) :	$v = 62.76$ mm (S13)	=	$L / 191$
Live loads 2 (Q2) :	$v = -180.1$ mm (S13)	=	$L / 67$

#### Under SLS Combinations

S1 = 1.00 G + 1.00 Q1 :	$v = 68.8$ mm (S13)	=	$L / 174$
-------------------------	---------------------	---	-----------

The user has to check whether the deflections are acceptable according to the project requirements and to consider a precambering if necessary.

### Natural frequencies

Load case / Combination	Mass assumed to be concentrated	Mass assumed to be distributed
G	6.41Hz	7.31Hz
G + 0.1 Q1	4.50Hz	5.12Hz
G + 0.2 Q1	3.66Hz	4.17Hz
G + 0.3 Q1	3.17Hz	3.61Hz
G + 0.4 Q1	2.83Hz	3.22Hz
G + 0.5 Q1	2.58Hz	2.94Hz

### 3.3.2 Sačasti nosač IPE 240

## IPE 240



### Parameters

#### General Parameters

##### Non composite Beam

End supports :	Simply supported beam
Horizontal span length :	$L = 12.00 \text{ m}$
Total number of openings :	$n = 10$
Dimensions of the openings :	
Height :	$a_0 = 220.0 \text{ mm}$
Length of the sinusoide :	$s = 300.0 \text{ mm}$
Length of the flat part :	$w_0 = 280.0 \text{ mm}$
Web post width :	$w_p = w_o = 280.0 \text{ mm}$
Spacing between openings center :	$e = 2s + w_o + w_p = 1160 \text{ mm}$
End web posts widths :	$w_{\text{end,l}} = 340.0 \text{ mm}$ $w_{\text{end,r}} = 340.0 \text{ mm}$
Mass :	$m = 371 \text{ kg}$
Total paint surface :	$S = 12.43 \text{ m}^2$
Paint surface (without upper face) :	$S' = 10.99 \text{ m}^2$
Massiveness :	$M = 263.20 \text{ m}^{-1}$
Massiveness (without upper face) :	$M' = 232.70 \text{ m}^{-1}$

#### Checking of the ANGELINA scope

Spacing cutting / flange inner face :	$d = 55.20 \text{ mm}$	$\geq 50.00 \text{ mm}$	OK
Spacing cutting / web-flange root :	$d = 40.20 \text{ mm}$	$\geq 10.00 \text{ mm}$	OK
Dimensions of an opening :	$(2b+w)/a = 4.00$	$\leq 5.00$	OK
Web slenderness :	$h_w / t_w = 48.45$	$\leq 124.0_{e_w} = 100.9$	OK

#### Position of the beam

The studied beam is an intermediate beam.

Spacing of the beam - to the adjacent left beam :	$L_1 = 3.350 \text{ m}$
- to the adjacent right beam :	$L_2 = 3.350 \text{ m}$

Width for the calculation of the surface loads supported by the beam :	
on the left side :	$d_1 = 1.675 \text{ m}$
on the right side :	$d_2 = 1.675 \text{ m}$
Total width :	$d_1 + d_2 = 3.350 \text{ m}$

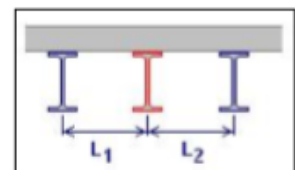

**Lateral restraint**

Concentrated lateral restraints :

	x (m)	Lateral restraints	
1	0.0	Both flanges	Origin section
2	12.00	Both flanges	End section

**Cross-section**

	Upper chord	Lower chord
Base profile	IPE 240	IPE 240
Grade	S355 JR/J0/J2/K2	S355 JR/J0/J2/K2
$h_t$ (mm)	240.0	240.0
$b_f$ (mm)	120.0	120.0
$t_f$ (mm)	9.8	9.8
$t_w$ (mm)	6.2	6.2
$r_c$ (mm)	15.0	15.0

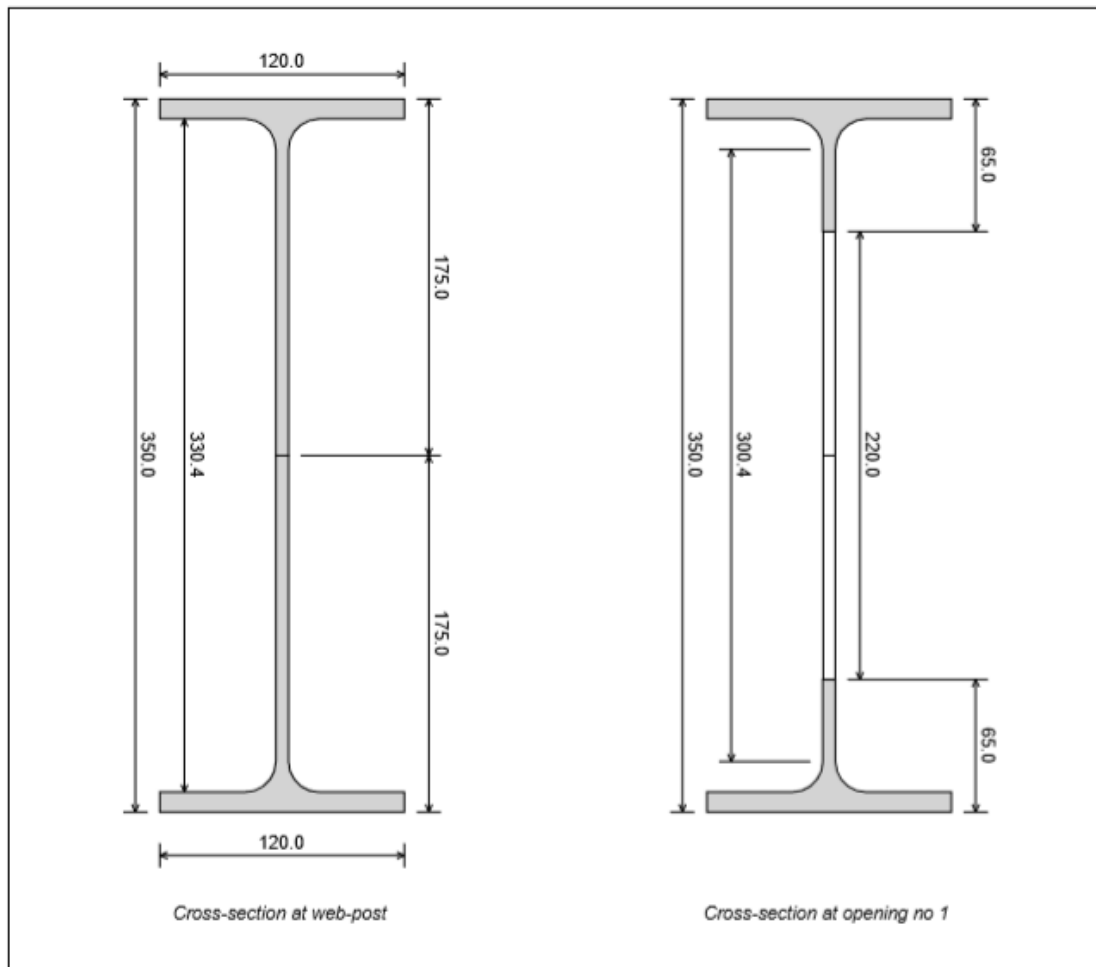

**Cross-section properties**

	Gross section	Net section
Area (cm <sup>2</sup> )	45.94	32.30
Position of the centroid (mm)	175.0	175.0
Inertia /yy (cm <sup>4</sup> )	9176	8627
Inertia /zz (cm <sup>4</sup> )	283.6	283.2

## Load cases

### Permanent loads (G)

Dead load :	0.30 kN/m	
Arising from :	Mass of the steel beam :	371 kg
Reactions at supports :	Left end :	$R_{Av} = 1.82$ kN
	Right end :	$R_{Bv} = 1.82$ kN

### Live loads 1 (Q1)

Psi factor  $\psi_0 = 0.70$

Distributed loads :

	Location $x_1$ (m)	Intensity $q_1$ (kN/m)	Location $x_2$ (m)	Intensity $q_2$ (kN/m)	Orientation
1	0.0	1.340	12.00	1.340	Vertical
2	0.0	1.340	12.00	1.340	Vertical

Reactions at supports :	Left end :	$R_{Av} = 16.08$ kN
	Right end :	$R_{Bv} = 16.08$ kN

### Live loads 2 (Q2)

Psi factor  $\psi_0 = 0.70$

Distributed loads :

	Location $x_1$ (m)	Intensity $q_1$ (kN/m)	Location $x_2$ (m)	Intensity $q_2$ (kN/m)	Orientation
1	0.0	-7.692	12.00	-7.692	Vertical

Reactions at supports :	Left end :	$R_{Av} = -46.15$ kN
	Right end :	$R_{Bv} = -46.15$ kN

## Partial factors

Factors on the loads :	$\gamma_{G,sup} = 1.350$
	$\gamma_{G,inf} = 1.000$
	$\gamma_Q = 1.500$

Factors on the resistance :	$\gamma_{M0} = 1.000$
	$\gamma_{M1} = 1.000$
	$\gamma_{M2} = 1.250$
	$\gamma_{M,fi} = 1.000$

## Steel properties

	Both chords
Steel	S355 JR/J0/J2/K2
Reduction curve from	EN 10025-2
Standard	EN 10025-2 : 2004
Flange $f_y$   $f_u$ (MPa)	355   470
Web $f_y$   $f_u$ (MPa)	355   470
Cross-section $f_y$   $f_u$ (MPa)	355   470
Cross-section $\epsilon$	0.814

## Load combinations

Ultimate Limit States	U1 =	1.35 G + 1.50 Q1 + 1.05 Q2
	U5 =	1.35 G + 1.50 Q1 + 1.50 Q2

Serviceability Limit States	S1 =	1.00 G + 1.00 Q1
-----------------------------	------	------------------



*Live loads 1 (Q1)*

**Reactions at supports :**      Left end :                       $R_{Av} = 16.08 \text{ kN}$   
Right end :                       $R_{Bv} = 16.08 \text{ kN}$

**Maximum moment :**               $M_{Max} = 48.24 \text{ kNm}$  in section no 12  
**Maximum shear force :**         $V_{Max} = -16.08 \text{ kN}$  in section no 1

	x (m)	M (kNm)	$V_L$ (kN)	$V_R$ (kN)	$N_L$ (kN)	$N_R$ (kN)
1	0.000	0.00	-	-16.08	-	0.0
2	0.170	2.69	-15.62	-15.62	0.0	0.0
3	0.780	11.73	-13.99	-13.99	0.0	0.0
4	1.360	19.39	-12.44	-12.44	0.0	0.0
5	1.940	26.15	-10.88	-10.88	0.0	0.0
6	2.520	32.01	-9.33	-9.33	0.0	0.0
7	3.100	36.97	-7.77	-7.77	0.0	0.0
8	3.680	41.03	-6.22	-6.22	0.0	0.0
9	4.260	44.18	-4.66	-4.66	0.0	0.0
10	4.840	46.44	-3.11	-3.11	0.0	0.0
11	5.420	47.79	-1.55	-1.55	0.0	0.0
12	6.000	48.24	0.00	0.00	0.0	0.0
13	6.580	47.79	1.55	1.55	0.0	0.0
14	7.160	46.44	3.11	3.11	0.0	0.0
15	7.740	44.18	4.66	4.66	0.0	0.0
16	8.320	41.03	6.22	6.22	0.0	0.0
17	8.900	36.97	7.77	7.77	0.0	0.0
18	9.480	32.01	9.33	9.33	0.0	0.0
19	10.060	26.15	10.88	10.88	0.0	0.0
20	10.640	19.39	12.44	12.44	0.0	0.0
21	11.220	11.73	13.99	13.99	0.0	0.0
22	11.830	2.69	15.62	15.62	0.0	0.0
23	12.000	0.00	16.08	-	0.0	-







Open.	Sect.	$N_{m,top}$ (kN)	$N_{m,bot}$ (kN)	$V_{m,top}$ (kN)	$V_{m,bot}$ (kN)
5	11	-199.863	199.863	1.058	1.058
6	13	-199.863	199.863	-1.058	-1.058
7	15	-184.781	184.781	-3.173	-3.173
8	17	-154.618	154.618	-5.289	-5.289
9	19	-109.372	109.372	-7.405	-7.405
10	21	-49.045	49.045	-9.520	-9.520

$$U5 = 1.35 G + 1.50 Q1 + 1.50 Q2$$

Reactions at supports :

Left end :  $R_{Av} = -42.65 \text{ kN}$   
Right end :  $R_{Bv} = -42.65 \text{ kN}$

Maximum moment :

$M_{Max} = -128.0 \text{ kNm}$  in section no 12

Maximum shear force :

$V_{Max} = 42.65 \text{ kN}$  in section no 1

	x (m)	M (kNm)	$V_L$ (kN)	$V_R$ (kN)	$N_L$ (kN)	$N_R$ (kN)
1	0.000	0.0	-	42.65	-	0.0
2	0.170	-7.1	41.45	41.45	0.0	0.0
3	0.780	-31.1	37.11	37.11	0.0	0.0
4	1.360	-51.4	32.99	32.99	0.0	0.0
5	1.940	-69.4	28.86	28.86	0.0	0.0
6	2.520	-84.9	24.74	24.74	0.0	0.0
7	3.100	-98.1	20.62	20.62	0.0	0.0
8	3.680	-108.8	16.49	16.49	0.0	0.0
9	4.260	-117.2	12.37	12.37	0.0	0.0
10	4.840	-123.2	8.25	8.25	0.0	0.0
11	5.420	-126.8	4.12	4.12	0.0	0.0
12	6.000	-128.0	0.00	0.00	0.0	0.0
13	6.580	-126.8	-4.12	-4.12	0.0	0.0
14	7.160	-123.2	-8.25	-8.25	0.0	0.0
15	7.740	-117.2	-12.37	-12.37	0.0	0.0
16	8.320	-108.8	-16.49	-16.49	0.0	0.0
17	8.900	-98.1	-20.62	-20.62	0.0	0.0
18	9.480	-84.9	-24.74	-24.74	0.0	0.0
19	10.060	-69.4	-28.86	-28.86	0.0	0.0
20	10.640	-51.4	-32.99	-32.99	0.0	0.0
21	11.220	-31.1	-37.11	-37.11	0.0	0.0
22	11.830	-7.1	-41.45	-41.45	0.0	0.0
23	12.000	0.0	-42.65	-	0.0	-

## ULTIMATE LIMIT STATES (ULS)

**Note: the calculation method applies to steel rolled profiles only.**

### Summary of the criteria

S = Satisfactory NS = Not satisfactory

#### Checkings of net sections at openings

Resistance to shear force (Open. no 10 - Comb. U5) :	$\Gamma_{V,max}$	= 0.147	< 1	S
Resistance to M+N interaction (Open. no 4 - Comb. U5) :	$\Gamma_{MN,max}$	= 0.725	< 1	S
Resistance to M+N+V interaction (Open. no 4 - Comb. U5) :	$\Gamma_{MNV,max}$	= 0.725	< 1	S

#### Web checkings

Shear buckling check required (Post no 1 - Comb. U5) :	$\Gamma_{Vbw,max}$	= 0.072	< 1	S
--	--------------------	---------	-----	---

#### Posts checkings

Resistance to shear (Post no 1 - Comb. U5) :	$\Gamma_{Vh,max}$	= 0.254	< 1	S
Minimum throat thickness				
Intermediate posts (Post no 1 - Comb. U5) :	$a_{min}$	= 0.87 mm		
Warning: the throat thickness is assessed by assuming two welds				
The total thickness of welds should be at least 1.74 mm				
End posts (Post no 10 - Comb. U5) :	$a_{min}$	= 0.64 mm		
The calculation for end posts does not take into account the details of the joint				

Warning : the throat thickness of the fillet weld must be at least 3 mm (EC3)

#### Gross sections checkings

Resistance to bending (Post no 5 - Comb. U5) :	$\Gamma_{Mg,max}$	= 0.600 (Classe 1)	< 1	S
Resistance to shear (Left end - Comb. U5) :	$\Gamma_{Vg,max}$	= 0.080	< 1	S

#### Other checkings

Resistance to lateral torsional buckling	$\Gamma_{LT,max}$	= 18.534	> 1	NS
--	-------------------	----------	-----	----

### ULS Combinations checkings

#### ULS Combination U1

$$U1 = 1.35 G + 1.50 Q1 + 1.05 Q2$$

#### Verifications in the openings sections

Open.	$\Gamma_V$	$\Gamma_{MN}$	$\Gamma_{MNV}$
1	0.075	0.320	0.320
2	0.059	0.300	0.300
3	0.042	0.298	0.298
4	0.025	0.298	0.298
5	0.008	0.284	0.284
6	0.008	0.284	0.284
7	0.025	0.298	0.298
8	0.042	0.298	0.298
9	0.059	0.300	0.300
10	0.075	0.320	0.320

**ULS Combination U5**

**U5 = 1.35 G + 1.50 Q1 + 1.50 Q2**

**Verifications in the openings sections**

Open.	$\Gamma_V$	$\Gamma_{MN}$	$\Gamma_{MNV}$
1	0.147	0.636	0.636
2	0.114	0.647	0.647
3	0.082	0.693	0.693
4	0.049	0.725	0.725
5	0.016	0.708	0.708
6	0.016	0.708	0.708
7	0.049	0.725	0.725
8	0.082	0.693	0.693
9	0.114	0.647	0.647
10	0.147	0.636	0.636

**Detailed checkings**

**Net section at opening no 10 - Resistance to shear force**

Combination U5

Bending moment	$M_{Ed}$	=	-31.11 kNm		
Shear forces	$V_{Ed,l}$	=	-37.11 kN	$V_{Ed,r}$	= -37.11 kN
Axial forces	$N_{Ed,l}$	=	0.0 kN	$N_{Ed,r}$	= 0.0 kN

**Top chord - Left cantilever arm**

Axial force	$N_{m,Ed}$	=	-95.59 kN		
Shear force	$V_{m,Ed}$	=	18.55 kN		
Location section / post	$x_{Sec}$	=	303.1 mm		
Height of the section	$h_{Sec}$	=	65.00 mm		
Position of the centroid	$d_{G,Te}$	=	12.28 mm	(about the external fibre of the flange)	
Distances for the moment	$e_N$	=	0.0 mm	$e_V$	= 136.9 mm
Forces in the design section	$N_{S,Ed}$	=	-95.59 kN	$V_{S,Ed}$	= 18.55 kN
Moment in the design section	$M_{S,Ed}$	=	$V_{S,Ed} e_V - N_{S,Ed} e_N$	=	2.540 kNm
Yield strength	$f_y$	=	355.0 MPa	$\epsilon$	= 0.814
Shear area	$A_V$	=	616.2 mm <sup>2</sup>		
Partial factor	$\gamma_{M0}$	=	1.000		
Shear resistant force	$V_{c,Rd}$	=	126.3 kN		
Criterion	$\Gamma_V$	=	0.147		

**Opening no 4 - Resistance to MN interaction**

Combination U5

Bending moment	$M_{Ed}$	=	-117.2 kNm		
Shear forces	$V_{Ed,l}$	=	12.37 kN	$V_{Ed,r}$	= 12.37 kN
Axial forces	$N_{Ed,l}$	=	0.0 kN	$N_{Ed,r}$	= 0.0 kN
Distributed load for local bending	$q_{Lin}$	=	-7109 N/m		

Class of a post (web)	$C_{wP}$	=	2		
Class of the opening	$C_{wT}$	=	2		
Reduction coefficient	$\rho_{hT}$	=	1.000		
Exposant for MN Interaction	Standard opening			$\alpha$	= 2.0

Local bend. moment (upper chord)  $M_m$  = 0.2 kNm

	Opening quarter			
	Upper LHS	Upper RHS	Lower LHS	Lower RHS
Location section / post $x_{Sec}$ (mm)	293.3	195.6	293.3	185.8
Height of the section $h_{Sec}$ (mm)	65.1	94.7	65.1	99.9
Position of the centroid $d_{G,Te}$ (mm)	12.3	19.2	12.3	20.6
$N_{S,Ed}$ (kN)	-360.1	-360.1	360.1	360.1
$V_{S,Ed}$ (kN)	-6.2	6.2	6.2	-6.2
$M_{S,Ed}$ (kNm)	-0.7	4.0	0.9	-4.6
$N_{Rd}$ (kN)	573.6	638.7	573.6	650.0
$\Gamma_N$	0.628	0.564	0.628	0.554
$M_{Rd}$ (kNm)	5.1	9.9	5.1	10.9
$\Gamma_M$	0.145	0.407	0.175	0.418
Criteria $\Gamma_{MN}$	0.539	0.725	0.569	0.725
Criteria $\Gamma_{MN}$ per chord	$\Gamma_{MN,Top} = 0.725$		$\Gamma_{MN,Bot} = 0.725$	
Final $\Gamma_{MN}$ criteria for the opening	$\Gamma_{MN} = 0.725$			

#### Opening no 4 - Resistance to MNV interaction

Combination U5

Bending moment	$M_{Ed}$	=	-117.2 kNm		
Shear forces	$V_{Ed,l}$	=	12.37 kN	$V_{Ed,r}$	= 12.37 kN
Axial forces	$N_{Ed,l}$	=	0.0 kN	$N_{Ed,r}$	= 0.0 kN
Distributed load for local bending	$q_{Lin}$	=	-7109 N/m		

Class of a post (web)	$C_{wP}$	=	2	
Class of the opening	$C_{wT}$	=	2	
Reduction coefficient	$\rho_{hT}$	=	1.000	
Exposant for MN Interaction	Standard opening			$\alpha = 2.0$

Local bend. moment (upper chord)  $M_m = 0.2$  kNm

	Opening quarter			
	Upper LHS	Upper RHS	Lower LHS	Lower RHS
Location section / post $x_{Sec}$ (mm)	293.3	195.6	293.3	185.8
Height of the section $h_{Sec}$ (mm)	65.1	94.7	65.1	99.9
Position of the centroid $d_{G,Te}$ (mm)	12.3	19.2	12.3	20.6
$N_{S,Ed}$ (kN)	-360.1	-360.1	360.1	360.1
$V_{S,Ed}$ (kN)	-6.2	6.2	6.2	-6.2
$M_{S,Ed}$ (kNm)	-0.7	4.0	0.9	-4.6
$N_{Rd}$ (kN)	573.6	638.7	573.6	650.0
$\Gamma_N$	0.628	0.564	0.628	0.554
$V_{Rd}$ (kN)	126.5	164.1	126.5	170.6
$\Gamma_V$	0.049	0.038	0.049	0.036
$M_{Rd}$ (kNm)	5.1	9.9	5.1	10.9
$\Gamma_M$	0.145	0.407	0.175	0.418
Criteria $\Gamma_{MNV}$	0.539	0.725	0.569	0.725
Criteria $\Gamma_{MNV}$ per chord	$\Gamma_{MNV,Top} = 0.725$		$\Gamma_{MNV,Bot} = 0.725$	
Final $\Gamma_{MNV}$ criteria for the opening	$\Gamma_{MNV} = 0.725$			

### Shear buckling

Section at web post no 1

ULS Combination U5

Web dimensions	$h_w$	=	330.4 mm	$t_w$	=	6.2 mm
Yield strengths	$f_y$	=	355 MPa	$\varepsilon$	=	0.814
	$\eta$	=	1.20			
$h_w / t_w = 53.29 > 72\varepsilon / \eta = 48.82$	Shear buckling check is required					
Reduced slenderness	$\lambda_w$	=	0.76			
Reduction factor	$\chi_w$	=	1.09			
Shear force	$V_{Ed}$	=	32.99 kN			
Shear buckling resistance	$V_{bw,Rd}$	=	459.69 kN			
Check	$\Gamma_{Vbw}$	=	0.072			

### Resistance of Web post no 1 to horizontal shear

Combination U5

Tee geometrical centres	$d_G$	=	325.4 mm			
Bending moments	$M_{Ed,l}$	=	-31.11 kNm	$M_{Ed,r}$	=	-69.37 kNm
Axial forces in tees	$N_{m,Sup,l}$	=	-95.59 kN	$N_{m,Inf,l}$	=	95.59 kN
	$N_{m,Sup,r}$	=	-213.2 kN	$N_{m,Inf,r}$	=	213.2 kN
Horizontal shear force in post	$V_{hm}$	=	-117.6 kN			
In adjacent openings:	$\Gamma_{N,max}$	=	0.372			
Extra resistance parameters	$\Omega$	=	1.214	$\chi$	=	1.000
	$\xi$	=	0.186	$\beta$	=	0.524
Intermediate post - Extra resistance				$\eta$	=	1.300
Post width	$w$	=	280.0 mm			
Resistant shear forces	$V_{hRd}$	=	462.55 kN			
Checkings	$\Gamma_{Vh}$	=	0.254			

### Bending resistance of gross sections

Section at web post no 5 (Section no 12) - Combination U5

Internal moment and force	$M_{Ed}$	=	-127.96 kNm	$N_{Ed}$	=	0.00 kN
Lower flange under compression: Class 1						
Class of the web						
Steel	$f_{y,w}$	=	355 MPa	$\varepsilon_w$	=	0.814
Slenderness:	$c / t$	=	48.45			
Plastic distribution factor	$\alpha$	=	0.50			
Class of the web	1					
Check of the resistance (Class1)						
Steel	$f_{y,top}$	=	355 MPa	$f_{y,bot}$	=	355 MPa
Partial factor	$\gamma_{M0}$	=	1.00			
Plastic resistant moment	$M_{pl,Rd}$	=	213.19 kNm			
Check	$\Gamma_{Mg}$	=	0.600			

### Shear resistance of gross sections

Section at left end (Section no 1) - Combination U5

Height of the cross-section	$h$	=	350.0 mm			
Shear area	$A_{v,top}$	=	1298.2 mm <sup>2</sup>	$A_{v,bot}$	=	1298.2 mm <sup>2</sup>
Yield strengths	$f_{y,top}$	=	355 MPa	$f_{y,bot}$	=	355 MPa
Shear design force	$V_{Ed}$	=	42.65 kN			
Shear resistance force	$V_{plRd}$	=	532.15 kN	$\gamma_{M0}$	=	1.00
Check	$\Gamma_{Vg}$	=	0.080			

### Resistance to lateral torsional buckling

Combination U5

Check of lower flange

Part between sections laterally maintained in  $x = 0.0$  m and  $x = 12.00$  m

Length of the part	$L$	=	12.00 m		
Moments at ends	$M_{end,l}$	=	0.00 kNm	$M_{end,r}$	= 0.00 kNm
Maximum moment	$M_{Ed}$	=	127.96 kNm		
Maximum normal force in chord	$N_{Ed}$	=	389.52 kN		
Properties of the chord section	$A_0$	=	1614.8 mm <sup>2</sup>	$I_{z,0}$	= 141.6 cm <sup>4</sup>
Yielding strength	$f_y$	=	355 MPa		
Height of the tee	$h_{Te}$	=	65.0 mm		
Isostatic moment distribution	$C_1$	=	1.132		
Critical normal force	$N_{cr}$	=	23.08 kN		

Reduced slenderness	$\lambda_b$	=	4.984
Reduction factor (curve "c")	$\chi$	=	0.037
Partial factor	$\gamma_{M1}$	=	1.000
Resistant normal force	$N_{b,Rd}$	=	21.02 kN
Check	$\Gamma_{LT}$	=	18.534

### Minimal throat thickness at post no 1

Combination U5

Width of the post	$w$	=	280.0 mm		
Ultimate strength	$f_u$	=	470.0 MPa	$\beta_w$	= 0.90
Moments at openings sections	$M_{Ed,l}$	=	-31.11 kNm	$M_{Ed,r}$	= -69.37 kNm
Spacings between tee chords	$d_{G,l}$	=	325.4 mm	$d_{G,r}$	= 325.4 mm
Axial forces in lower chords	$N_{m,Ed,l}$	=	-95.59 kN	$N_{m,Ed,r}$	= -213.2 kN
Force and moment in the post	$V_{h,Ed}$	=	117.6 kN	$M_{h,Ed}$	= 0.0 kNm
Partial factor	$\gamma_{M2}$	=	1.25		
Throat thickness	$a$	=	0.870 mm		

Warning: the throat thickness is assessed by assuming two welds  
The total thickness of welds should be at least 1.74 mm

## SERVICEABILITY LIMIT STATES (SLS)

### Deflections

$v$  : Maximum vertical deflection of the beam

#### Under elementary load cases

Permanent loads (G) :	$v = 5.14$ mm (S12)	= $L / 2337$
Live loads 1 (Q1) :	$v = 45.42$ mm (S12)	= $L / 264$
Live loads 2 (Q2) :	$v = -130.4$ mm (S12)	= $L / 92$

#### Under SLS Combinations

S1 = 1.00 G + 1.00 Q1 :	$v = 50.6$ mm (S12)	= $L / 237$
-------------------------	---------------------	-------------

The user has to check whether the deflections are acceptable according to the project requirements and to consider a precambering if necessary.

### Natural frequencies

Load case / Combination	Mass assumed to be concentrated	Mass assumed to be distributed
G	6.97Hz	7.94Hz
G + 0.1 Q1	5.08Hz	5.79Hz
G + 0.2 Q1	4.19Hz	4.77Hz
G + 0.3 Q1	3.65Hz	4.16Hz
G + 0.4 Q1	3.27Hz	3.73Hz
G + 0.5 Q1	2.99Hz	3.41Hz



### 3.3.3. Sačasti nosač IPE 270

## IPE 270



### Parameters

#### General Parameters

##### Non composite Beam

End supports :	Simply supported beam
Horizontal span length :	$L = 12.00 \text{ m}$
Total number of openings :	$n = 9$
Dimensions of the openings :	
Height :	$a_0 = 260.0 \text{ mm}$
Length of the sinusoide :	$s = 320.0 \text{ mm}$
Length of the flat part :	$w_0 = 320.0 \text{ mm}$
Web post width :	$w_p = w_o = 320.0 \text{ mm}$
Spacing between openings center :	$e = 2 s + w_o + w_p = 1280 \text{ mm}$
End web posts widths :	$w_{\text{end,l}} = 400.0 \text{ mm}$ $w_{\text{end,r}} = 400.0 \text{ mm}$
Mass :	$m = 436 \text{ kg}$
Total paint surface :	$S = 14.11 \text{ m}^2$
Paint surface (without upper face) :	$S' = 12.49 \text{ m}^2$
Massiveness :	$M = 254.11 \text{ m}^{-1}$
Massiveness (without upper face) :	$M' = 224.95 \text{ m}^{-1}$

#### Checking of the ANGELINA scope

Spacing cutting / flange innerface :	$d = 59.80 \text{ mm}$	$\geq 50.00 \text{ mm}$ OK
Spacing cutting / web-flange root :	$d = 44.80 \text{ mm}$	$\geq 10.00 \text{ mm}$ OK
Dimensions of an opening :	$(2b+w)/a = 3.69$	$\leq 5.00$ OK
Web slenderness :	$h_w / t_w = 52.97$	$\leq 124.0_{e_w} = 100.9$ OK

**Position of the beam**

The studied beam is an intermediate beam.

Spacing of the beam - to the adjacent left beam :  $L_1 = 3.350 \text{ m}$   
 - to the adjacent right beam :  $L_2 = 3.350 \text{ m}$

Width for the calculation of the surface loads supported by the beam :  
 on the left side :  $d_1 = 1.675 \text{ m}$   
 on the right side :  $d_2 = 1.675 \text{ m}$   
 Total width :  $d_1 + d_2 = 3.350 \text{ m}$

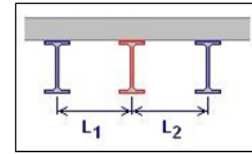

**Lateral restraint**

Concentrated lateral restraints :

	x (m)	Lateral restraints	
1	0.0	Both flanges	Origin section
2	12.00	Both flanges	End section

**Cross-section**

	Upper chord	Lower chord
Base profile	IPE 270	IPE 270
Grade	S355 JR/J0/J2/K2	S355 JR/J0/J2/K2
$h_t$ (mm)	270.0	270.0
$b_f$ (mm)	135.0	135.0
$t_f$ (mm)	10.2	10.2
$t_w$ (mm)	6.6	6.6
$r_e$ (mm)	15.0	15.0

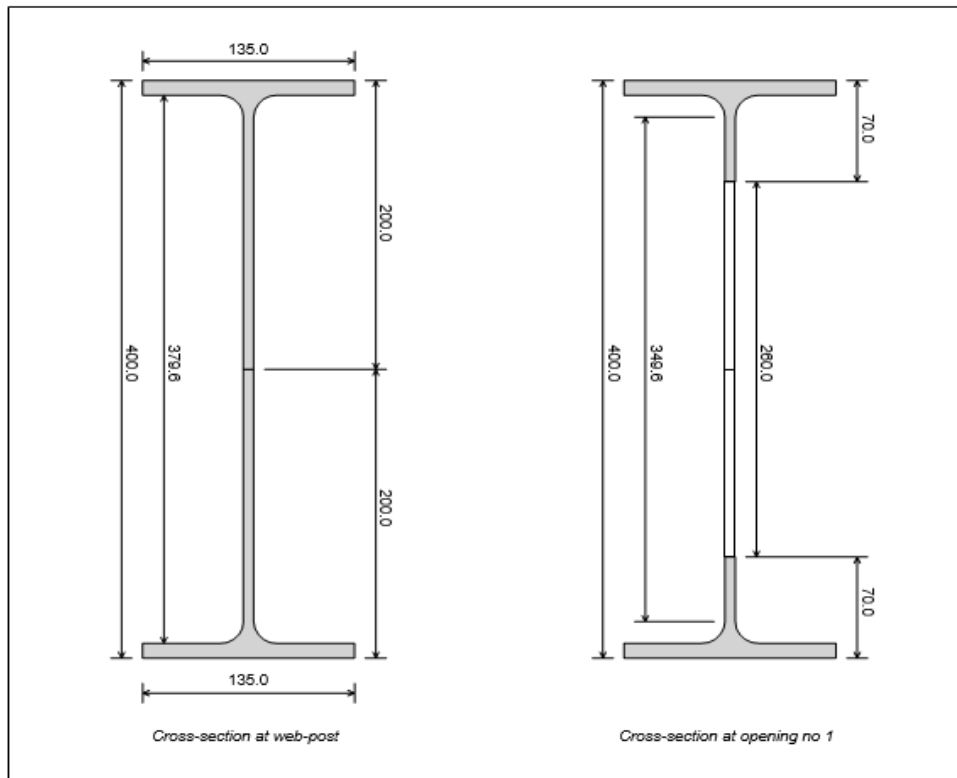

**Cross-section properties**

	Gross section	Net section
Area (cm <sup>2</sup> )	54.53	37.37
Position of the centroid (mm)	200.0	200.0
Inertia /yy (cm <sup>4</sup> )	14143	13177
Inertia /zz (cm <sup>4</sup> )	420.0	419.3

### Load combinations

Ultimate Limit States	U1 =	1.35 G + 1.50 Q1 + 1.05 Q2
	U5 =	1.35 G + 1.50 Q1 + 1.50 Q2
Serviceability Limit States	S1 =	1.00 G + 1.00 Q1

### Load cases

#### Permanent loads (G)

Dead load :	0.36 kN/m
Arising from :	Mass of the steel beam : 436 kg
Reactions at supports :	Left end : $R_{Av} = 2.14\text{kN}$
	Right end : $R_{Bv} = 2.14\text{kN}$

#### Live loads 1 (Q1)

Psi factor  $\psi_0 = 0.70$

Distributed loads :

	Location $x_1$ (m)	Intensity $q_1$ (kN/m)	Location $x_2$ (m)	Intensity $q_2$ (kN/m)	Orientation
1	0.0	1.340	12.00	1.340	Vertical
2	0.0	1.340	12.00	1.340	Vertical

Reactions at supports :	Left end :	$R_{Av} = 16.08\text{kN}$
	Right end :	$R_{Bv} = 16.08\text{kN}$

#### W (Q2)

Psi factor  $\psi_0 = 0.70$

Distributed loads :

	Location $x_1$ (m)	Intensity $q_1$ (kN/m)	Location $x_2$ (m)	Intensity $q_2$ (kN/m)	Orientation
1	0.0	-7.692	12.00	-7.692	Vertical

Reactions at supports :	Left end :	$R_{Av} = -46.15\text{kN}$
	Right end :	$R_{Bv} = -46.15\text{kN}$

### Partial factors

Factors on the loads :	$\gamma_{G,\text{sup}}$	= 1.350
	$\gamma_{G,\text{inf}}$	= 1.000
	$\gamma_Q$	= 1.500
	$\gamma$	

Factors on the resistance :	$\gamma_{M0}$	= 1.000
	$\gamma_{M1}$	= 1.000
	$\gamma_{M2}$	= 1.250
	$\gamma_{M,\text{fi}}$	= 1.000
	$\gamma$	

### Steel properties

	Both chords
Steel	S355 JR/J0/J2/K2
Reduction curve from	EN 10025-2
Standard	EN 10025-2 : 2004
Flange $f_v$   $f_u$ (MPa)	355   470
Web $f_v$   $f_u$ (MPa)	355   470
Cross-section $f_v$   $f_u$ (MPa)	355   470
Cross-section $\epsilon$	0.814

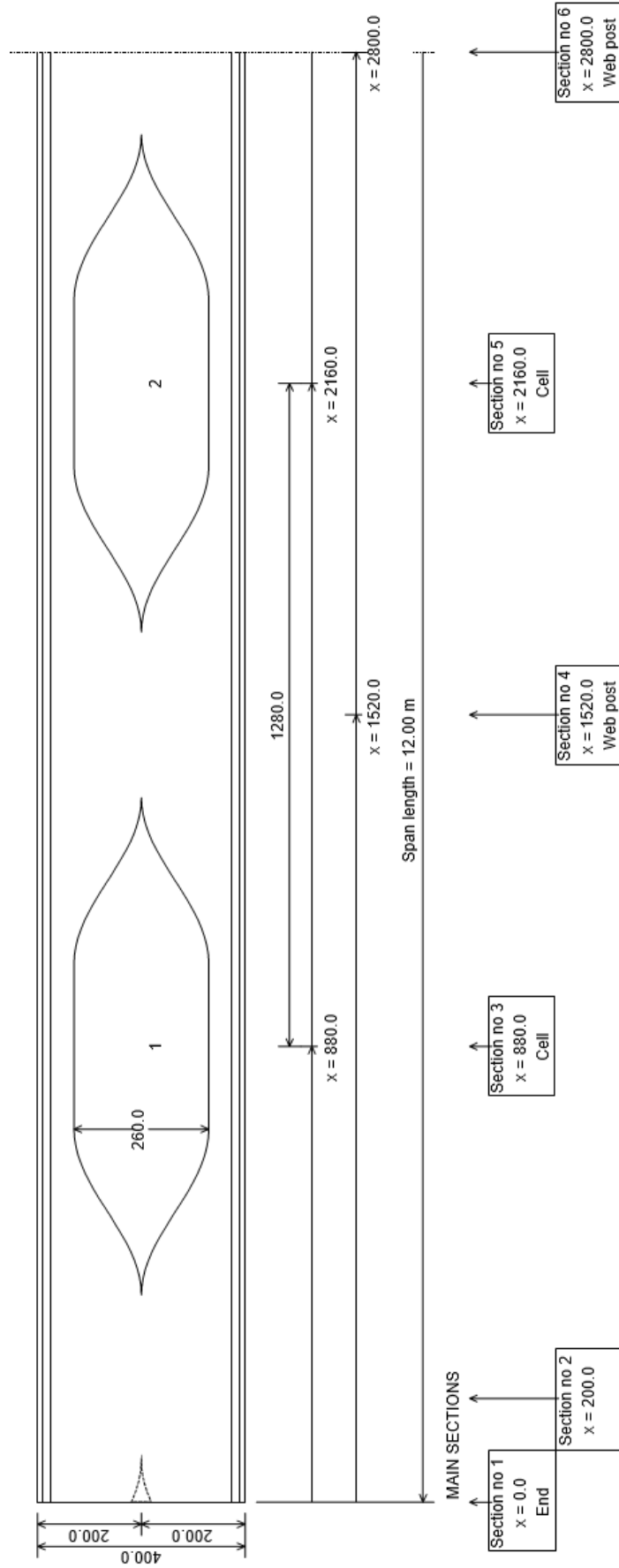

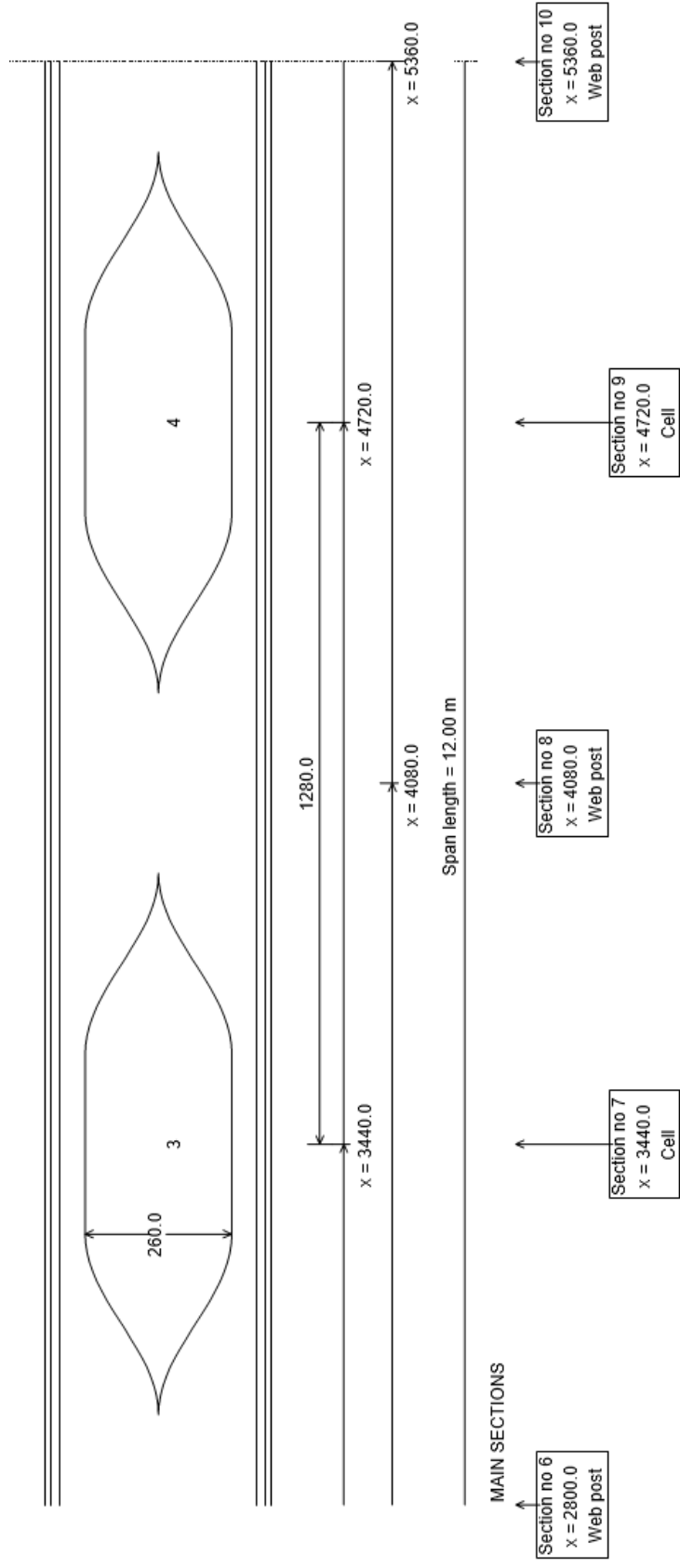

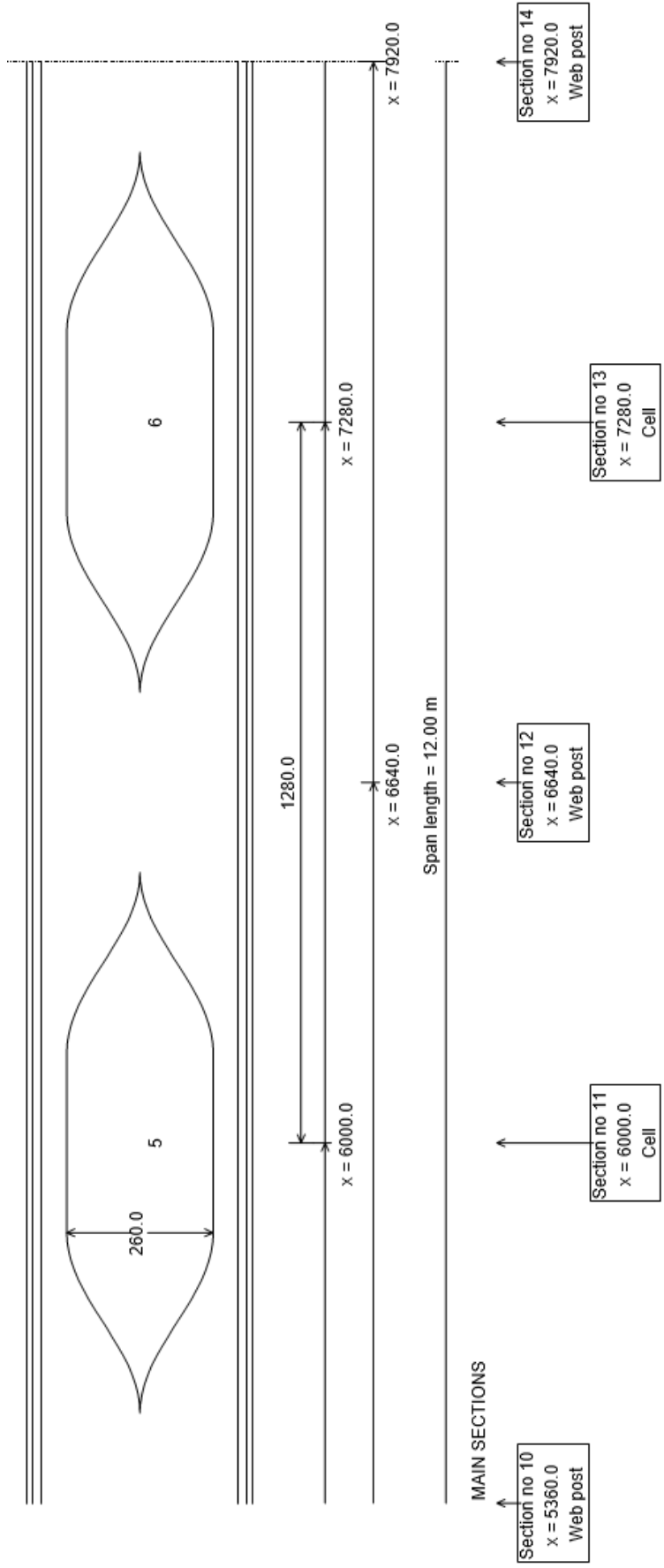

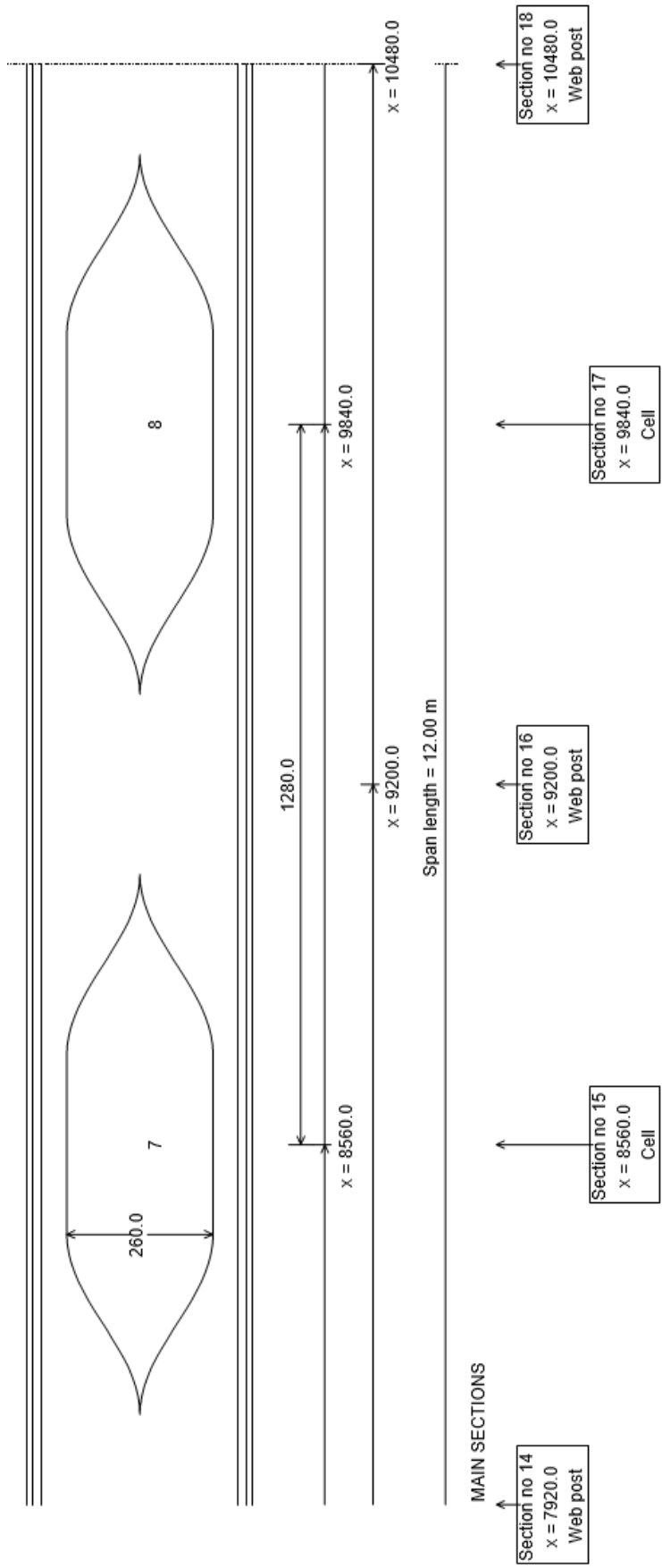

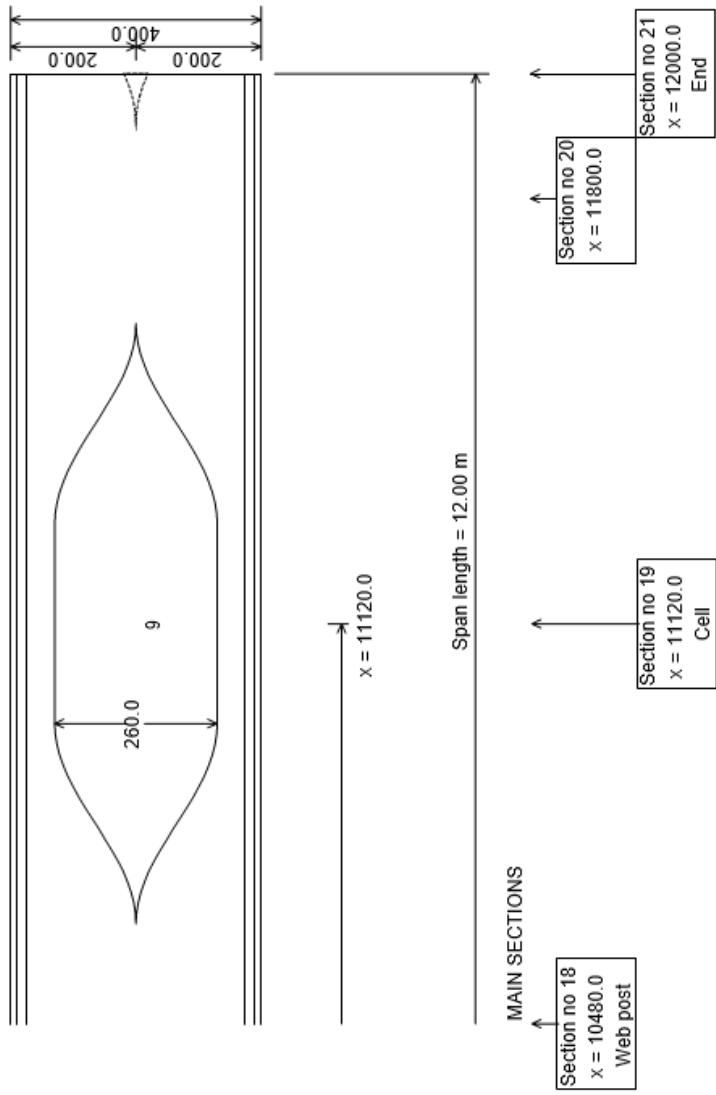



## INTERNAL FORCES AND MOMENTS

### *Under elementary load cases*

#### *Permanent loads (G)*

**Reactions at supports :** Left end :  $R_{Av} = 2.14 \text{ kN}$   
Right end :  $R_{Bv} = 2.14 \text{ kN}$

**Maximum moment :**  $M_{Max} = 6.416 \text{ kNm}$  in section no 11  
**Maximum shear force :**  $V_{Max} = -2.139 \text{ kN}$  in section no 1



	x (m)	M (kNm)	$V_L$ (kN)	$V_R$ (kN)	$N_L$ (kN)	$N_R$ (kN)
1	0.000	0.000	-	-2.139	-	0.0
2	0.200	0.421	-2.067	-2.067	0.0	0.0
3	0.880	1.744	-1.825	-1.825	0.0	0.0
4	1.520	2.839	-1.597	-1.597	0.0	0.0
5	2.160	3.788	-1.369	-1.369	0.0	0.0
6	2.800	4.591	-1.141	-1.141	0.0	0.0
7	3.440	5.248	-0.913	-0.913	0.0	0.0
8	4.080	5.759	-0.684	-0.684	0.0	0.0
9	4.720	6.124	-0.456	-0.456	0.0	0.0
10	5.360	6.343	-0.228	-0.228	0.0	0.0
11	6.000	6.416	0.000	0.000	0.0	0.0
12	6.640	6.343	0.228	0.228	0.0	0.0
13	7.280	6.124	0.456	0.456	0.0	0.0
14	7.920	5.759	0.684	0.684	0.0	0.0
15	8.560	5.248	0.913	0.913	0.0	0.0
16	9.200	4.591	1.141	1.141	0.0	0.0
17	9.840	3.788	1.369	1.369	0.0	0.0
18	10.480	2.839	1.597	1.597	0.0	0.0
19	11.120	1.744	1.825	1.825	0.0	0.0
20	11.800	0.421	2.067	2.067	0.0	0.0
21	12.000	0.000	2.139	-	0.0	-

**Live loads 1 (Q1)**

**Reactions at supports :** Left end :  $R_{Av} = 16.08\text{kN}$   
 Right end :  $R_{Bv} = 16.08\text{kN}$

**Maximum moment :**  $M_{Max} = 48.24\text{ kNm}$  in section no 11  
**Maximum shear force :**  $V_{Max} = -16.08\text{ kN}$  in section no 1

	x (m)	M (kNm)	$V_L$ (kN)	$V_R$ (kN)	$N_L$ (kN)	$N_R$ (kN)
1	0.000	0.00	-	-16.08	-	0.0
2	0.200	3.16	-15.54	-15.54	0.0	0.0
3	0.880	13.11	-13.72	-13.72	0.0	0.0
4	1.520	21.35	-12.01	-12.01	0.0	0.0
5	2.160	28.48	-10.29	-10.29	0.0	0.0
6	2.800	34.52	-8.58	-8.58	0.0	0.0
7	3.440	39.46	-6.86	-6.86	0.0	0.0
8	4.080	43.30	-5.15	-5.15	0.0	0.0
9	4.720	46.04	-3.43	-3.43	0.0	0.0
10	5.360	47.69	-1.72	-1.72	0.0	0.0
11	6.000	48.24	0.00	0.00	0.0	0.0
12	6.640	47.69	1.72	1.72	0.0	0.0
13	7.280	46.04	3.43	3.43	0.0	0.0
14	7.920	43.30	5.15	5.15	0.0	0.0
15	8.560	39.46	6.86	6.86	0.0	0.0
16	9.200	34.52	8.58	8.58	0.0	0.0
17	9.840	28.48	10.29	10.29	0.0	0.0
18	10.480	21.35	12.01	12.01	0.0	0.0
19	11.120	13.11	13.72	13.72	0.0	0.0
20	11.800	3.16	15.54	15.54	0.0	0.0
21	12.000	0.00	16.08	-	0.0	-

**W (Q2)**

**Reactions at supports :**

Left end :

$R_{Av} = -46.15 \text{ kN}$

Right end :

$R_{Bv} = -46.15 \text{ kN}$

**Maximum moment :**

$M_{Max} = -138.5 \text{ kNm}$  in section no 11

**Maximum shear force :**

$V_{Max} = 46.15 \text{ kN}$  in section no 1



	x (m)	M (kNm)	$V_L$ (kN)	$V_R$ (kN)	$N_L$ (kN)	$N_R$ (kN)
1	0.000	0.0	-	46.15	-	0.0
2	0.200	-9.1	44.61	44.61	0.0	0.0
3	0.880	-37.6	39.38	39.38	0.0	0.0
4	1.520	-61.3	34.46	34.46	0.0	0.0
5	2.160	-81.7	29.54	29.54	0.0	0.0
6	2.800	-99.1	24.61	24.61	0.0	0.0
7	3.440	-113.3	19.69	19.69	0.0	0.0
8	4.080	-124.3	14.77	14.77	0.0	0.0
9	4.720	-132.2	9.85	9.85	0.0	0.0
10	5.360	-136.9	4.92	4.92	0.0	0.0
11	6.000	-138.5	0.00	0.00	0.0	0.0
12	6.640	-136.9	-4.92	-4.92	0.0	0.0
13	7.280	-132.2	-9.85	-9.85	0.0	0.0
14	7.920	-124.3	-14.77	-14.77	0.0	0.0
15	8.560	-113.3	-19.69	-19.69	0.0	0.0
16	9.200	-99.1	-24.61	-24.61	0.0	0.0
17	9.840	-81.7	-29.54	-29.54	0.0	0.0
18	10.480	-61.3	-34.46	-34.46	0.0	0.0
19	11.120	-37.6	-39.38	-39.38	0.0	0.0
20	11.800	-9.1	-44.61	-44.61	0.0	0.0
21	12.000	0.0	-46.15	-	0.0	-



Open.	Sect.	$N_{m,top}$ (kN)	$N_{m,bot}$ (kN)	$V_{m,top}$ (kN)	$V_{m,bot}$ (kN)
7	15	-140.699	140.699	-4.576	-4.576
8	17	-101.557	101.557	-6.865	-6.865
9	19	-46.757	46.757	-9.153	-9.153

$$U5 = 1.35 G + 1.50 Q1 + 1.50 Q2$$

Reactions at supports :

Left end :

$$R_{Av} = -42.22 \text{ kN}$$

Right end :

$$R_{Bv} = -42.22 \text{ kN}$$

Maximum moment :

$$M_{Max} = -126.7 \text{ kNm in section no 11}$$

Maximum shear force :

$$V_{Max} = 42.22 \text{ kN in section no 1}$$

	x (m)	M (kNm)	$V_L$ (kN)	$V_R$ (kN)	$N_L$ (kN)	$N_R$ (kN)
1	0.000	0.0	-	42.22	-	0.0
2	0.200	-8.3	40.81	40.81	0.0	0.0
3	0.880	-34.4	36.03	36.03	0.0	0.0
4	1.520	-56.0	31.52	31.52	0.0	0.0
5	2.160	-74.8	27.02	27.02	0.0	0.0
6	2.800	-90.6	22.52	22.52	0.0	0.0
7	3.440	-103.6	18.01	18.01	0.0	0.0
8	4.080	-113.7	13.51	13.51	0.0	0.0
9	4.720	-120.9	9.01	9.01	0.0	0.0
10	5.360	-125.2	4.50	4.50	0.0	0.0
11	6.000	-126.7	0.00	0.00	0.0	0.0
12	6.640	-125.2	-4.50	-4.50	0.0	0.0
13	7.280	-120.9	-9.01	-9.01	0.0	0.0
14	7.920	-113.7	-13.51	-13.51	0.0	0.0
15	8.560	-103.6	-18.01	-18.01	0.0	0.0
16	9.200	-90.6	-22.52	-22.52	0.0	0.0
17	9.840	-74.8	-27.02	-27.02	0.0	0.0
18	10.480	-56.0	-31.52	-31.52	0.0	0.0
19	11.120	-34.4	-36.03	-36.03	0.0	0.0
20	11.800	-8.3	-40.81	-40.81	0.0	0.0
21	12.000	0.0	-42.22	-	0.0	-

Open.	Sect.	$N_{m,top}$ (kN)	$N_{m,bot}$ (kN)	$V_{m,top}$ (kN)	$V_{m,bot}$ (kN)
1	3	-92.024	92.024	18.014	18.014

Open.	Sect.	$N_{m,top}$ (kN)	$N_{m,bot}$ (kN)	$V_{m,top}$ (kN)	$V_{m,bot}$ (kN)
2	5	-199.876	199.876	13.511	13.511
3	7	-276.913	276.913	9.007	9.007
4	9	-323.136	323.136	4.504	4.504
5	11	-338.543	338.543	0.000	0.000
6	13	-323.136	323.136	-4.504	-4.504
7	15	-276.913	276.913	-9.007	-9.007
8	17	-199.876	199.876	-13.511	-13.511
9	19	-92.024	92.024	-18.014	-18.014

## ULTIMATE LIMIT STATES (ULS)

**Note: the calculation method applies to steel rolled profiles only.**

### *Summary of the criteria*

S = Satisfactory    NS = Not satisfactory

#### *Checkings of net sections at openings*

Resistance to shear force (Open. no 9 - Comb. U5) :	$V_{max} = 0.130$	< 1	S
Resistance to M+N interaction (Open. no 9 - Comb. U5) :	$MN_{max} = 0.553$	< 1	S
Resistance to M+N+V interaction (Open. no 9 - Comb. U5) :	$MNV_{max} = 0.553$	< 1	S

#### *Web checkings*

Shear buckling check required (Post no 1 - Comb. U5) :	$V_{bw,max} = 0.061$	< 1	S
--	----------------------	-----	---

#### *Posts checkings*

Resistance to shear (Post no 1 - Comb. U5) :	$V_h,max = 0.192$	< 1	S
Minimum throat thickness			
Intermediate posts (Post no 1 - Comb. U5) :	$a_{min} = 0.70 \text{ mm}$		
Warning: the throat thickness is assessed by assuming two welds			
The total thickness of welds should be at least 1.40 mm			
End posts (Post no 9 - Comb. U5) :	$a_{min} = 0.53 \text{ mm}$		
<i>The calculation for end posts does not take into account the details of the joint</i>			

Warning : the throat thickness of the fillet weld must be at least 3 mm (EC3)

#### *Gross sections checkings*

Resistance to bending (Post no 5 - Comb. U5) :	$M_{g,max} = 0.435 \text{ (Classe 1)}$	< 1	S
Resistance to shear (Left end - Comb. U5) :	$V_{g,max} = 0.067$	< 1	S

#### *Other checkings*

Resistance to lateral torsional buckling	$LT_{max} = 11.012$	> 1	NS
--	---------------------	-----	----

### **ULS Combinations checkings**

#### **ULS Combination U1**

$$U1 = 1.35 G + 1.50 Q1 + 1.05 Q2$$

#### **Verifications in the openings sections**

Open.	v	MN	MNV
1	0.066	0.276	0.276
2	0.049	0.242	0.242
3	0.033	0.222	0.222
4	0.016	0.208	0.208
5	0.000	0.184	0.184
6	0.016	0.208	0.208
7	0.033	0.222	0.222
8	0.049	0.242	0.242
9	0.066	0.276	0.276

#### **ULS Combination U5**

$$U5 = 1.35 G + 1.50 Q1 + 1.50 Q2$$

#### **Verifications in the openings sections**

Open.	v	MN	MNV
1	0.130	0.553	0.553
2	0.097	0.518	0.518
3	0.065	0.508	0.508
4	0.032	0.493	0.493
5	0.000	0.444	0.444
6	0.032	0.493	0.493
7	0.065	0.508	0.508
8	0.097	0.518	0.518
9	0.130	0.553	0.553

## Detailed checkings

### Net section at opening no 9 - Resistance to shear force

Combination U5			
Bending moment	$M_{Ed}$	=	-34.43 kNm
Shear forces	$V_{Ed,l}$	=	-36.03 kN
	$V_{Ed,r}$	=	-36.03 kN
Axial forces	$N_{Ed,l}$	=	0.0 kN
	$N_{Ed,r}$	=	0.0 kN
<b>Top chord - Left cantilever arm</b>			
Axial force	$N_{m,Ed}$	=	-92.02 kN
Shear force	$V_{m,Ed}$	=	18.01 kN
Location section / post	$x_{Sec}$	=	323.3 mm
Height of the section	$h_{Sec}$	=	70.00 mm
Position of the centroid	$d_{G,Te}$	=	12.93 mm
			(about the external fibre of the flange)
Distances for the moment	$e_N$	=	0.0 mm
	$e_V$	=	156.7 mm
Forces in the design section	$N_{S,Ed}$	=	-92.02 kN
	$V_{S,Ed}$	=	18.01 kN
Moment in the design section	$M_{S,Ed}$	=	$V_{S,Ed} e_V - N_{S,Ed} e_N = 2.823$ kNm
Yield strength	$f_y$	=	355.0 MPa
		=	0.814
Shear area	$A_v$	=	677.9 mm <sup>2</sup>
Partial factor	$M_0$	=	1.000
Shear resistant force	$V_{c,Rd}$	=	138.9 kN
Criterion	$v$	=	0.130

### Opening no 9 - Resistance to MN interaction

Combination U5			
Bending moment	$M_{Ed}$	=	-34.43 kNm
Shear forces	$V_{Ed,l}$	=	-36.03 kN
	$V_{Ed,r}$	=	-36.03 kN
Axial forces	$N_{Ed,l}$	=	0.0 kN
	$N_{Ed,r}$	=	0.0 kN
Distributed load for local bending	$q_{Lin}$	=	-7037 N/m
Class of a post (web)	$C_{wP}$	=	2
Class of the opening	$C_{wT}$	=	2
Reduction coefficient	$\rho_{hT}$	=	1.000
Coefficient for the end portal effect	End opening		$k_{Port} = 2.10$
Exposant for MN Interaction	End opening		$\alpha = 2.0$
Coefficient for local bending	End opening		$k_{Mm} = 1.0$
Local bend. moment (upperchord)	$M_m$	=	0.3 kNm

	Opening quarter			
	Upper LHS	Upper RHS	Lower LHS	Lower RHS
Location section / post $x_{Sec}$ (mm)	284.1	284.1	274.3	293.9
Height of the section $h_{Sec}$ (mm)	74.0	74.0	76.4	72.1
Position of the centroid $d_{G,Te}$ (mm)	13.8	13.8	14.3	13.4
$N_{S,Ed}$ (kN)	-92.0	-92.0	92.0	92.0
$V_{S,Ed}$ (kN)	18.0	-18.0	-18.0	18.0
$M_{S,Ed}$ (kNm)	3.7	-3.3	-3.8	3.3
$N_{Rd}$ (kN)	672.6	672.6	678.3	668.2
$\Gamma_N$	0.137	0.137	0.136	0.138
$M_{Rd}$ (kNm)	6.9	6.9	7.3	6.6
$\Gamma_M$	0.543	0.482	0.526	0.502
Criteria $\Gamma_{MN}$	0.561	0.500	0.544	0.521
Criteria $\Gamma_{MN}$ per chord	$\Gamma_{MN,Top} = 0.561$		$\Gamma_{MN,Bot} = 0.544$	
Final $\Gamma_{MN}$ criteria for the opening	$\Gamma_{MN} = 0.553$			



### Opening no 9 - Resistance to MNV interaction

Combination U5				
Bending moment	$M_{Ed}$	=	-34.43 kNm	
Shear forces	$V_{Ed,l}$	=	-36.03 kN	$V_{Ed,r}$ = -36.03 kN
Axial forces	$N_{Ed,l}$	=	0.0 kN	$N_{Ed,r}$ = 0.0 kN
Distributed load for local bending	$q_{Lin}$	=	-7037 N/m	
Class of a post (web)	$C_{wP}$	=	2	
Class of the opening	$C_{wT}$	=	2	
Reduction coefficient	$\rho_{hT}$	=	1.000	
Coefficient for the end portal effect	End opening			$k_{Port} = 2.10$
Exposant for MN Interaction	End opening			$\alpha = 2.0$
Coefficient for local bending	End opening			$k_{Mm} = 1.0$
Local bend. moment (upper chord)	$M_m$	=	0.3 kNm	

	Opening quarter			
	Upper LHS	Upper RHS	Lower LHS	Lower RHS
Location section / post x $Sec$ (mm)	284.1	284.1	274.3	293.9
Height of the section $h_{Sec}$ (mm)	74.0	74.0	76.4	72.1
Position of the centroid $d_{G,Te}$ (mm)	13.8	13.8	14.3	13.4
$N_{S,Ed}$ (kN)	-92.0	-92.0	92.0	92.0
$V_{S,Ed}$ (kN)	18.0	-18.0	-18.0	18.0
$M_{S,Ed}$ (kNm)	3.7	-3.3	-3.8	3.3
$N_{Rd}$ (kN)	672.6	672.6	678.3	668.2
$\Gamma_N$	0.137	0.137	0.136	0.138
$V_{Rd}$ (kN)	144.4	144.4	147.7	141.8
$\Gamma_V$	0.125	0.125	0.122	0.127
$M_{Rd}$ (kNm)	6.9	6.9	7.3	6.6
$\Gamma_M$	0.543	0.482	0.526	0.502
Criteria $\Gamma_{MNV}$	0.561	0.500	0.544	0.521
Criteria $\Gamma_{MNV}$ per chord	$\Gamma_{MNV,Top} = 0.561$		$\Gamma_{MN,Bot} = 0.544$	
Final $\Gamma_{MNV}$ criteria for the opening	$\Gamma_{MNV} = 0.553$			

### Shear buckling

Section at web post no 1

ULS Combination U5

Web dimensions	$h_w$	=	379.6 mm	$t_w$	=	6.6 mm
Yield strengths	$f_y$	=	355 MPa	$\varepsilon$	=	0.814
		=	1.20			

$h_w / t_w = 57.52 > 72 / \lambda = 48.82$  Shear buckling check is required

Reduced slenderness $\lambda_{s1}$	$\lambda_w$	=	0.82
Reduction factor	$\chi_w$	=	1.01
Shear force	$V_{Ed}$	=	31.52 kN
Shear buckling resistance	$V_{bw,Rd}$	=	520.92 kN

Check	$V_{bw}$	=	0.061
-------	----------	---	-------

#### Resistance of Web post no 1 to horizontal shear

Combination U5

Tee geometrical centres	$d_G$	=	374.1 mm		
Bending moments	$M_{Ed,l}$	=	-34.43 kNm	$M_{Ed,r}$	= -74.78 kNm
Axial forces in tees	$N_{m,Sup,l}$	=	-92.02 kN	$N_{m,Inf,l}$	= 92.02 kN
	$N_{m,Sup,r}$	=	-199.9 kN	$N_{m,Inf,r}$	= 199.9 kN
Horizontal shear force in post	$V_{hm}$	=	-107.9 kN		
In adjacent openings:	$N_{max}$	=	0.301		
Extra resistance parameters		=	1.250		= 1.000
	$\xi$	=	0.175	$\beta$	= 0.500
Intermediate post - Extra resistance					= 1.300
Post width	$w$	=	320.0 mm		
Resistant shear forces	$V_{hRd}$	=	562.74 kN		
Checkings	$V_h$	=	0.192		

#### Bending resistance of gross sections

Section at web post no 5 (Section no 12) - Combination U5

Internal moment and force	$M_{Ed}$	=	-125.22 kNm	$N_{Ed}$	= 0.00 kN
Lower flange under compression: Class 1					
Class of the web					
Steel	$f_{y,w}$	=	355 MPa	$w$	= 0.814
Slenderness:	$c / t$	=	52.97		
Plastic distribution factor		=	0.50		
Class of the web	1				
Check of the resistance (Class1)					
Steel	$f_{y,top}$	=	355 MPa	$f_{y,bot}$	= 355 MPa
Partial factor	$M_0$	=	1.00		
Plastic resistant moment	$M_{pl,Rd}$	=	287.74 kNm		
Check	$M_g$	=	0.435		

#### Shear resistance of gross sections

Section at left end (Section no 1) - Combination U5

Height of the cross-section	$h$	=	400.0 mm		
Shear area	$A_{v,top}$	=	1535.9 mm <sup>2</sup>	$A_{v,bot}$	= 1535.9 mm <sup>2</sup>
Yield strengths	$f_{y,top}$	=	355 MPa	$f_{y,bot}$	= 355 MPa
Shear design force	$V_{Ed}$	=	42.22 kN		
Shear resistance force	$V_{plRd}$	=	629.60 kN	$M_0$	= 1.00
Check	$V_g$	=	0.067		

#### Resistance to lateral torsional buckling

Combination U5

Check of lower flange

Part between sections laterally maintained in  $x = 0.0$  m and  $x = 12.00$  m

Length of the part	$L$	=	12.00 m		
Moments at ends	$M_{end,l}$	=	0.00 kNm	$M_{end,r}$	= 0.00 kNm
Maximum moment	$M_{Ed}$	=	126.66 kNm		
Maximum normal force in chord	$N_{Ed}$	=	338.54 kN		
Properties of the chord section	$A_0$	=	1868.3 mm <sup>2</sup>	$I_{z,0}$	= 209.7 cm <sup>4</sup>
Yielding strength	$f_y$	=	355 MPa		
Height of the tee	$h_{Te}$	=	70.0 mm		
Isostatic moment distribution	$C_1$	=	1.132		
Critical normal force	$N_{cr}$	=	34.17 kN		

Reduced slenderness	b	=	4.406
Reduction factor (curve "c")		=	0.046
Partial factor	M1	=	1.000
Resistant normal force	$N_{h,Rd}$	=	30.74 kN
Check	LT	=	11.012

#### Minimal throat thickness at post no 1

Combination U5				
Width of the post	w	=	320.0 mm	
Ultimate strength	$f_u$	=	470.0 MPa	$\beta_w$ = 0.90
Moments at openings sections	$M_{Fd,l}$	=	-34.43 kNm	$M_{Ed,r}$ = -74.78 kNm
Spacings between tee chords	$d_{G,l}$	=	374.1 mm	$d_{G,r}$ = 374.1 mm
Axial forces in lower chords	$N_{m,Fd,l}$	=	-92.02 kN	$N_{m,Ed,r}$ = -199.9 kN
Force and moment in the post	$V_{h,Fd}$	=	107.9 kN	$M_{h,Ed}$ = 0.0 kNm
Partial factor	M2	=	1.25	
Throat thickness	a	=	0.699 mm	

Warning: the throat thickness is assessed by assuming two welds  
The total thickness of welds should be at least 1.40 mm

### SERVICEABILITY LIMIT STATES (SLS)

#### Deflections

v : Maximum vertical deflection of the beam

##### Under elementary load cases

Permanent loads (G) :	v = 4.01 mm (S11)	= L / 2993
Live loads 1 (Q1) :	v = 30.15 mm (S11)	= L / 398
W (Q2) :	v = -86.52 mm (S11)	= L / 139

##### Under SLS Combinations

S1 = 1.00 G + 1.00 Q1 :	v = 34.2 mm (S11)	= L / 351
-------------------------	-------------------	-----------

The user has to check whether the deflections are acceptable according to the project requirements and to consider a precambering if necessary.

#### Natural frequencies

Load case / Combination	Mass assumed to be concentrated	Mass assumed to be distributed
G	7.89Hz	8.99Hz
G + 0.1 Q1	5.96Hz	6.79Hz
G + 0.2 Q1	4.99Hz	5.68Hz
G + 0.3 Q1	4.37Hz	4.98Hz
G + 0.4 Q1	3.94Hz	4.49Hz
G + 0.5 Q1	3.62Hz	4.12Hz

### 3.3.4. Sačasti nosač IPE 300

## IPE 300



### Parameters

#### General Parameters

##### Non composite Beam

End supports :	Simply supported beam
Horizontal span length :	$L = 12.00 \text{ m}$
Total number of openings :	$n = 8$
Dimensions of the openings :	
Height :	$a_0 = 280.0 \text{ mm}$
Length of the sinusoide :	$s = 360.0 \text{ mm}$
Length of the flat part :	$w_o = 360.0 \text{ mm}$
Web post width :	$w_p = w_o = 360.0 \text{ mm}$
Spacing between openings center :	$e = 2s + w_o + w_p = 1440 \text{ mm}$
End web posts widths :	$w_{\text{end,l}} = 420.0 \text{ mm}$ $w_{\text{end,r}} = 420.0 \text{ mm}$
Mass :	$m = 511 \text{ kg}$
Total paint surface :	$S = 15.67 \text{ m}^2$
Paint surface (without upper face) :	$S' = 13.87 \text{ m}^2$
Massiveness :	$M = 240.85 \text{ m}^{-1}$
Massiveness (without upper face) :	$M' = 213.18 \text{ m}^{-1}$

#### Checking of the ANGELINA scope

Spacing cutting / flange inner face :	$d = 69.30 \text{ mm}$	$\geq 50.00 \text{ mm}$	OK
Spacing cutting / web-flange root :	$d = 54.30 \text{ mm}$	$\geq 10.00 \text{ mm}$	OK
Dimensions of an opening :	$(2b+w)/a = 3.86$	$\leq 5.00$	OK
Web slenderness :	$h_w / t_w = 54.73$	$\leq 124.0_{e_w} = 100.9$	OK

#### Position of the beam

The studied beam is an intermediate beam.

Spacing of the beam - to the adjacent left beam :	$L_1 = 3.350 \text{ m}$
- to the adjacent right beam :	$L_2 = 3.350 \text{ m}$

Width for the calculation of the surface loads supported by the beam :	
on the left side :	$d_1 = 1.675 \text{ m}$
on the right side :	$d_2 = 1.675 \text{ m}$
Total width :	$d_1 + d_2 = 3.350 \text{ m}$

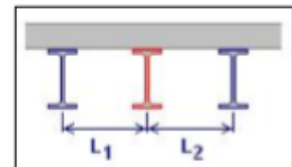

**Lateral restraint**

Concentrated lateral restraints :

	x (m)	Lateral restraints	
1	0.0	Both flanges	Origin section
2	12.00	Both flanges	End section

**Cross-section**

	Upper chord	Lower chord
Base profile	IPE 300	IPE 300
Grade	S355 JR/J0/J2/K2	S355 JR/J0/J2/K2
$h_t$ (mm)	300.0	300.0
$b_f$ (mm)	150.0	150.0
$t_f$ (mm)	10.7	10.7
$t_w$ (mm)	7.1	7.1
$r_c$ (mm)	15.0	15.0

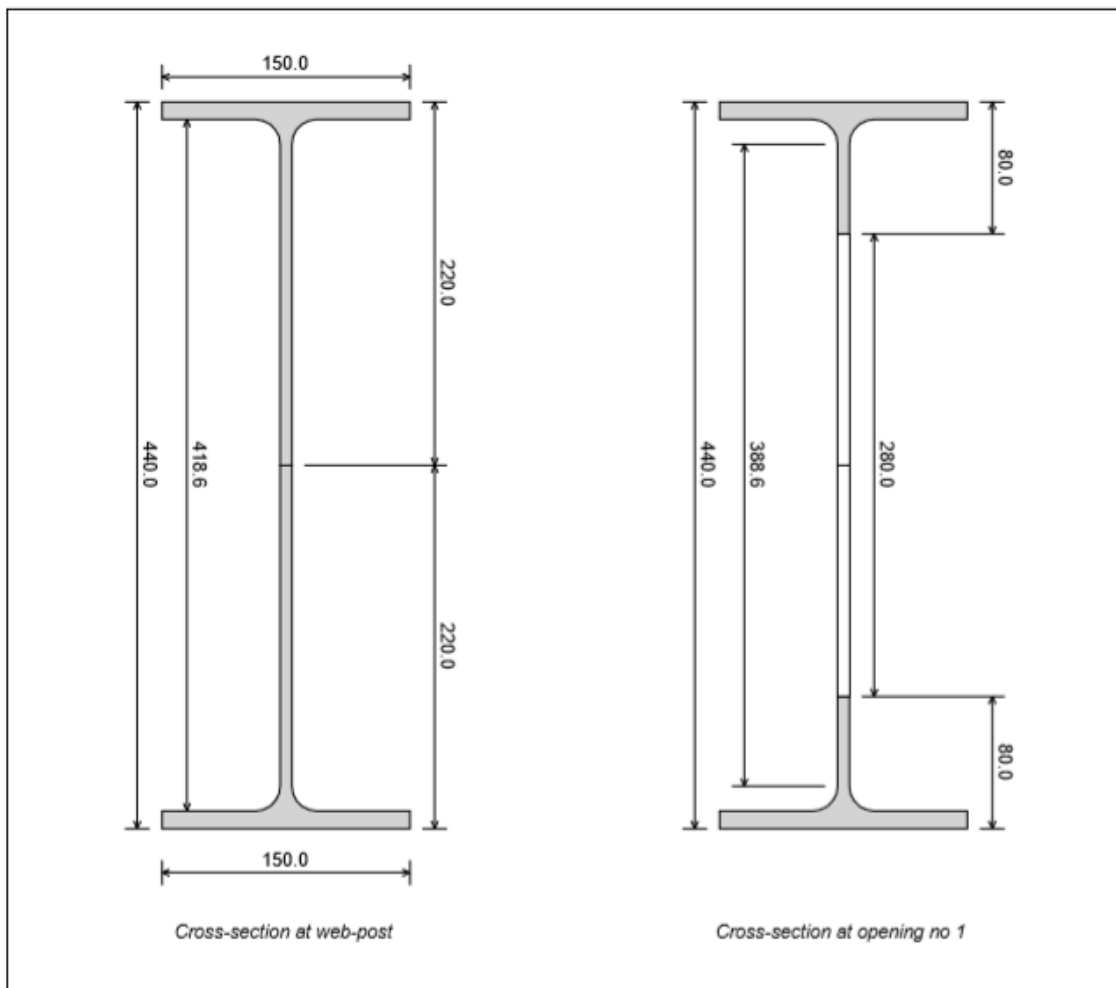

**Cross-section properties**

	Gross section	Net section
Area (cm <sup>2</sup> )	63.75	43.87
Position of the centroid (mm)	220.0	220.0
Inertia /yy (cm <sup>4</sup> )	19952	18653
Inertia /zz (cm <sup>4</sup> )	604.0	603.1

## Load cases

### Permanent loads (G)

Dead load :	0.42 kN/m	
Arising from :	Mass of the steel beam :	511 kg
Reactions at supports :	Left end :	$R_{Av} = 2.50$ kN
	Right end :	$R_{Bv} = 2.50$ kN

### Live loads 1 (Q1)

Psi factor  $\psi_0 = 0.70$

Distributed loads :

	Location $x_1$ (m)	Intensity $q_1$ (kN/m)	Location $x_2$ (m)	Intensity $q_2$ (kN/m)	Orientation
1	0.0	1.340	12.00	1.340	Vertical
2	0.0	1.340	12.00	1.340	Vertical

Reactions at supports :	Left end :	$R_{Av} = 16.08$ kN
	Right end :	$R_{Bv} = 16.08$ kN

### Live loads 2 (Q2)

Psi factor  $\psi_0 = 0.70$

Distributed loads :

	Location $x_1$ (m)	Intensity $q_1$ (kN/m)	Location $x_2$ (m)	Intensity $q_2$ (kN/m)	Orientation
1	0.0	-7.692	12.00	-7.692	Vertical

Reactions at supports :	Left end :	$R_{Av} = -46.15$ kN
	Right end :	$R_{Bv} = -46.15$ kN

## Partial factors

Factors on the loads :	$\gamma_{G,sup} = 1.350$
	$\gamma_{G,inf} = 1.000$
	$\gamma_Q = 1.500$

Factors on the resistance :	$\gamma_{M0} = 1.000$
	$\gamma_{M1} = 1.000$
	$\gamma_{M2} = 1.250$
	$\gamma_{M,fi} = 1.000$

## Steel properties

	Both chords
Steel	S355 JR/J0/J2/K2
Reduction curve from	EN 10025-2
Standard	EN 10025-2 : 2004
Flange $f_y$   $f_u$ (MPa)	355   470
Web $f_y$   $f_u$ (MPa)	355   470
Cross-section $f_y$   $f_u$ (MPa)	355   470
Cross-section $\varepsilon$	0.814

## Load combinations

Ultimate Limit States	$U1 = 1.35 G + 1.50 Q1 + 1.05 Q2$
	$U5 = 1.35 G + 1.35 Q1 + 1.35 Q2$

Serviceability Limit States	$S1 = 1.00 G + 1.00 Q1$
-----------------------------	-------------------------



**Live loads 2 (Q2)**

**Reactions at supports :** Left end :  $R_{Av} = -46.15 \text{ kN}$   
 Right end :  $R_{Bv} = -46.15 \text{ kN}$

**Maximum moment :**  $M_{Max} = -138.5 \text{ kNm}$  in section no 10  
**Maximum shear force :**  $V_{Max} = 46.15 \text{ kN}$  in section no 1

	x (m)	M (kNm)	$V_L$ (kN)	$V_R$ (kN)	$N_L$ (kN)	$N_R$ (kN)
1	0.000	0.0	-	46.15	-	0.0
2	0.210	-9.5	44.54	44.54	0.0	0.0
3	0.960	-40.8	38.77	38.77	0.0	0.0
4	1.680	-66.7	33.23	33.23	0.0	0.0
5	2.400	-88.6	27.69	27.69	0.0	0.0
6	3.120	-106.6	22.15	22.15	0.0	0.0
7	3.840	-120.5	16.61	16.61	0.0	0.0
8	4.560	-130.5	11.08	11.08	0.0	0.0
9	5.280	-136.5	5.54	5.54	0.0	0.0
10	6.000	-138.5	0.00	0.00	0.0	0.0
11	6.720	-136.5	-5.54	-5.54	0.0	0.0
12	7.440	-130.5	-11.08	-11.08	0.0	0.0
13	8.160	-120.5	-16.61	-16.61	0.0	0.0
14	8.880	-106.6	-22.15	-22.15	0.0	0.0
15	9.600	-88.6	-27.69	-27.69	0.0	0.0
16	10.320	-66.7	-33.23	-33.23	0.0	0.0
17	11.040	-40.8	-38.77	-38.77	0.0	0.0
18	11.790	-9.5	-44.54	-44.54	0.0	0.0
19	12.000	0.0	-46.15	-	0.0	-





**Under ULS Combinations**

$$U1 = 1.35 G + 1.50 Q1 + 1.05 Q2$$

**Reactions at supports :**  
 Left end :  $R_{Av} = -20.96$  kN  
 Right end :  $R_{Bv} = -20.96$  kN

**Maximum moment :**  $M_{Max} = -62.87$  kNm in section no 10  
**Maximum shear force :**  $V_{Max} = 20.96$  kN in section no 1

	x (m)	M (kNm)	$V_L$ (kN)	$V_R$ (kN)	$N_L$ (kN)	$N_R$ (kN)
1	0.000	0.00	-	20.96	-	0.0
2	0.210	-4.32	20.22	20.22	0.0	0.0
3	0.960	-18.51	17.60	17.60	0.0	0.0
4	1.680	-30.28	15.09	15.09	0.0	0.0
5	2.400	-40.24	12.57	12.57	0.0	0.0
6	3.120	-48.39	10.06	10.06	0.0	0.0
7	3.840	-54.73	7.54	7.54	0.0	0.0
8	4.560	-59.25	5.03	5.03	0.0	0.0
9	5.280	-61.97	2.51	2.51	0.0	0.0
10	6.000	-62.87	0.00	0.00	0.0	0.0
11	6.720	-61.97	-2.51	-2.51	0.0	0.0
12	7.440	-59.25	-5.03	-5.03	0.0	0.0
13	8.160	-54.73	-7.54	-7.54	0.0	0.0
14	8.880	-48.39	-10.06	-10.06	0.0	0.0
15	9.600	-40.24	-12.57	-12.57	0.0	0.0
16	10.320	-30.28	-15.09	-15.09	0.0	0.0
17	11.040	-18.51	-17.60	-17.60	0.0	0.0
18	11.790	-4.32	-20.22	-20.22	0.0	0.0
19	12.000	0.00	-20.96	-	0.0	-

Open.	Sect.	$N_{m,top}$ (kN)	$N_{m,bot}$ (kN)	$V_{m,top}$ (kN)	$V_{m,bot}$ (kN)
1	3	-45.082	45.082	8.802	8.802
2	5	-98.005	98.005	6.287	6.287
3	7	-133.286	133.286	3.772	3.772
4	9	-150.927	150.927	1.257	1.257
5	11	-150.927	150.927	-1.257	-1.257
6	13	-133.286	133.286	-3.772	-3.772
7	15	-98.005	98.005	-6.287	-6.287
8	17	-45.082	45.082	-8.802	-8.802



## ULTIMATE LIMIT STATES (ULS)

**Note: the calculation method applies to steel rolled profiles only.**

### Summary of the criteria

S = Satisfactory NS = Not satisfactory

#### Checkings of net sections at openings

Resistance to shear force (Open. no 1 - Comb. U5) :	$\Gamma_{V,max}$	= 0.097	< 1	S
Resistance to M+N interaction (Open. no 1 - Comb. U5) :	$\Gamma_{MN,max}$	= 0.393	< 1	S
Resistance to M+N+V interaction (Open. no 1 - Comb. U5) :	$\Gamma_{MNV,max}$	= 0.393	< 1	S

#### Web checkings

Shear buckling check required (Post no 1 - Comb. U5) :	$\Gamma_{Vbw,max}$	= 0.044	< 1	S
--	--------------------	---------	-----	---

#### Posts checkings

Resistance to shear (Post no 1 - Comb. U5) :	$\Gamma_{Vh,max}$	= 0.138	< 1	S
Minimum throat thickness				
Intermediate posts (Post no 1 - Comb. U5) :	$a_{min}$	= 0.54 mm		
Warning: the throat thickness is assessed by assuming two welds				
The total thickness of welds should be at least 1.08 mm				
End posts (Post no 0 - Comb. U5) :	$a_{min}$	= 0.44 mm		
The calculation for end posts does not take into account the details of the joint				

Warning : the throat thickness of the fillet weld must be at least 3 mm (EC3)

#### Gross sections checkings

Resistance to bending (Post no 4 - Comb. U5) :	$\Gamma_{Mg,max}$	= 0.302 (Classe 1)	< 1	S
Resistance to shear (Left end - Comb. U5) :	$\Gamma_{Vg,max}$	= 0.051	< 1	S

#### Other checkings

Resistance to lateral torsional buckling	$\Gamma_{LT,max}$	= 6.129	> 1	NS
--	-------------------	---------	-----	----

## ULS Combinations checkings

### ULS Combination U1

$$U1 = 1.35 G + 1.50 Q1 + 1.05 Q2$$

#### Verifications in the openings sections

Open.	$\Gamma_V$	$\Gamma_{MN}$	$\Gamma_{MNV}$
1	0.055	0.219	0.219
2	0.039	0.184	0.184
3	0.023	0.161	0.161
4	0.008	0.143	0.143
5	0.008	0.143	0.143
6	0.023	0.161	0.161
7	0.039	0.184	0.184
8	0.055	0.219	0.219

## Detailed checkings

### Net section at opening no 1 - Resistance to shear force

Combination U5			
Bending moment	$M_{Ed}$	=	-32.87 kNm
Shear forces	$V_{Ed,l}$	=	31.26 kN
Axial forces	$N_{Ed,l}$	=	0.0 kN
		$V_{Ed,r}$	= 31.26 kN
		$N_{Ed,r}$	= 0.0 kN
<b>Top chord - Left cantilever arm</b>			
Axial force	$N_{m,Ed}$	=	-80.05 kN
Shear force	$V_{m,Ed}$	=	-15.63 kN
Location section / post	$x_{Sec}$	=	363.3 mm
Height of the section	$h_{Sec}$	=	80.00 mm
Position of the centroid	$d_{G,Te}$	=	14.71 mm (about the external fibre of the flange)
Distances for the moment	$e_N$	=	0.0 mm
		$e_V$	= 176.7 mm
Forces in the design section	$N_{S,Ed}$	=	-80.05 kN
		$V_{S,Ed}$	= -15.63 kN
Moment in the design section	$M_{S,Ed}$	=	$V_{S,Ed} e_V - N_{S,Ed} e_N = -2.762$ kNm
Yield strength	$f_y$	=	355.0 MPa
		$\epsilon$	= 0.814
Shear area	$A_V$	=	787.1 mm <sup>2</sup>
Partial factor	$\gamma_{M0}$	=	1.000
Shear resistant force	$V_{c,Rd}$	=	161.3 kN
Criterion	$\Gamma_V$	=	0.097

### Opening no 1 - Resistance to MN interaction

Combination U5			
Bending moment	$M_{Ed}$	=	-32.87 kNm
Shear forces	$V_{Ed,l}$	=	31.26 kN
Axial forces	$N_{Ed,l}$	=	0.0 kN
Distributed load for local bending	$q_{Lin}$	=	-6203 N/m
		$V_{Ed,r}$	= 31.26 kN
		$N_{Ed,r}$	= 0.0 kN
Class of a post (web)	$C_{wP}$	=	2
Class of the opening	$C_{wT}$	=	2
Reduction coefficient	$\rho_{hT}$	=	1.000
Coefficient for the end portal effect	End opening		$k_{Port} = 2.65$
Exposant for MN Interaction	End opening		$\alpha = 2.0$
Coefficient for local bending	End opening		$k_{Mm} = 1.0$
Local bend. moment (upper chord)	$M_m$	=	0.3 kNm

	Opening quarter			
	Upper LHS	Upper RHS	Lower LHS	Lower RHS
Location section / post $x_{Sec}$ (mm)	324.0	314.2	324.0	304.4
Height of the section $h_{Sec}$ (mm)	83.4	85.5	83.4	88.1
Position of the centroid $d_{G,Te}$ (mm)	15.4	15.9	15.4	16.5
$N_{S,Ed}$ (kN)	-80.1	-80.1	80.1	80.1
$V_{S,Ed}$ (kN)	-15.6	15.6	15.6	-15.6
$M_{S,Ed}$ (kNm)	-3.2	3.8	3.3	-3.8
$N_{Rd}$ (kN)	787.4	792.6	787.4	799.1
$\Gamma_N$	0.102	0.101	0.102	0.100
$M_{Rd}$ (kNm)	9.2	9.7	9.2	10.2
$\Gamma_M$	0.342	0.390	0.359	0.376
Criteria $\Gamma_{MN}$	0.352	0.401	0.369	0.386
Criteria $\Gamma_{MN}$ per chord	$\Gamma_{MN,Top} = 0.401$		$\Gamma_{MN,Bot} = 0.386$	
Final $\Gamma_{MN}$ criteria for the opening	$\Gamma_{MN} = 0.393$			

**Opening no 1 - Resistance to MNV interaction**

Combination U5

Bending moment	$M_{Ed}$	=	-32.87 kNm		
Shear forces	$V_{Ed,l}$	=	31.26 kN	$V_{Ed,r}$	= 31.26 kN
Axial forces	$N_{Ed,l}$	=	0.0 kN	$N_{Ed,r}$	= 0.0 kN
Distributed load for local bending	$q_{Lin}$	=	-6203 N/m		

Class of a post (web)	$C_{wP}$	=	2		
Class of the opening	$C_{wT}$	=	2		
Reduction coefficient	$\rho_{hT}$	=	1.000		
Coefficient for the end portal effect	End opening			$k_{Port}$	= 2.65
Exposant for MN Interaction	End opening			$\alpha$	= 2.0

Coefficient for local bending	End opening			$k_{Mm}$	= 1.0
Local bend. moment (upper chord)	$M_m$	=	0.3 kNm		

	Opening quarter			
	Upper LHS	Upper RHS	Lower LHS	Lower RHS
Location section / post $x_{Sec}$ (mm)	324.0	314.2	324.0	304.4
Height of the section $h_{Sec}$ (mm)	83.4	85.5	83.4	88.1
Position of the centroid $d_{G,Te}$ (mm)	15.4	15.9	15.4	16.5
$N_{S,Ed}$ (kN)	-80.1	-80.1	80.1	80.1
$V_{S,Ed}$ (kN)	-15.6	15.6	15.6	-15.6
$M_{S,Ed}$ (kNm)	-3.2	3.8	3.3	-3.8
$N_{Rd}$ (kN)	787.4	792.6	787.4	799.1
$\Gamma_N$	0.102	0.101	0.102	0.100
$V_{Rd}$ (kN)	166.3	169.4	166.3	173.1
$\Gamma_V$	0.094	0.092	0.094	0.090
$M_{Rd}$ (kNm)	9.2	9.7	9.2	10.2
$\Gamma_M$	0.342	0.390	0.359	0.376
Criteria $\Gamma_{MNV}$	0.352	0.401	0.369	0.386
Criteria $\Gamma_{MNV}$ per chord	$\Gamma_{MNV,Top} = 0.401$		$\Gamma_{MN,Bot} = 0.386$	
Final $\Gamma_{MNV}$ criteria for the opening	$\Gamma_{MNV} = 0.393$			

**Shear buckling**

Section at web post no 1

ULS Combination U5

Web dimensions	$h_w$	=	418.6 mm	$t_w$	=	7.1 mm
Yield strengths	$f_y$	=	355 MPa	$\epsilon$	=	0.814
	$\eta$	=	1.20			

$h_w / t_w = 58.96 > 72\epsilon / \eta = 48.82$  Shear buckling check is required

Reduced slenderness	$\lambda_w$	=	0.84
Reduction factor	$\chi_w$	=	0.99
Shear force	$V_{Ed}$	=	26.80 kN
Shear buckling resistance	$V_{bw,Rd}$	=	602.83 kN

Check	$\Gamma_{Vbw}$	=	0.044
-------	----------------	---	-------

#### Resistance of Web post no 1 to horizontal shear

Combination U5			
Tee geometrical centres	$d_G$	=	410.6 mm
Bending moments	$M_{Ed,l}$	=	-32.87 kNm
Axial forces in tees	$N_{m,Sup,l}$	=	-80.05 kN
	$N_{m,Sup,r}$	=	-174.0 kN
Horizontal shear force in post	$V_{hm}$	=	-93.98 kN
In adjacent openings:	$\Gamma_{N,max}$	=	0.223
Extra resistance parameters	$\Omega$	=	1.167
	$\xi$	=	0.182
Intermediate post - Extra resistance			$\chi = 1.000$
Post width	$w$	=	360.0 mm
Resistant shear forces	$V_{hRd}$	=	681.04 kN
Checkings	$\Gamma_{Vh}$	=	0.138
			$\beta = 0.508$
			$\eta = 1.300$

#### Bending resistance of gross sections

Section at web post no 4 (Section no 10) - Combination U5			
Internal moment and force	$M_{Ed}$	=	-111.65 kNm
Lower flange under compression: Class 1			$N_{Ed} = 0.00$ kN
Class of the web			
Steel	$f_{y,w}$	=	355 MPa
Slenderness:	$c / t$	=	54.73
Plastic distribution factor	$\alpha$	=	0.50
Class of the web	1		$\epsilon_w = 0.814$
Check of the resistance (Class1)			
Steel	$f_{y,top}$	=	355 MPa
Partial factor	$\gamma_{M0}$	=	1.00
Plastic resistant moment	$M_{pl,Rd}$	=	369.14 kNm
Check	$\Gamma_{Mg}$	=	0.302
			$f_{y,bot} = 355$ MPa

#### Shear resistance of gross sections

Section at left end (Section no 1) - Combination U5			
Height of the cross-section	$h$	=	440.0 mm
Shear area	$A_{v,top}$	=	1781.1 mm <sup>2</sup>
Yield strengths	$f_{y,top}$	=	355 MPa
Shear design force	$V_{Ed}$	=	37.22 kN
Shear resistance force	$V_{plRd}$	=	730.10 kN
Check	$\Gamma_{Vg}$	=	0.051
			$f_{y,bot} = 355$ MPa
			$\gamma_{M0} = 1.00$

#### Resistance to lateral torsional buckling

Combination U5			
Check of lower flange			
Part between sections laterally maintained in $x = 0.0$ m and $x = 12.00$ m			
Length of the part	$L$	=	12.00 m
Moments at ends	$M_{end,l}$	=	0.00 kNm
Maximum moment	$M_{Ed}$	=	111.65 kNm
Maximum normal force in chord	$N_{Ed}$	=	268.00 kN
Properties of the chord section	$A_0$	=	2193.6 mm <sup>2</sup>
Yielding strength	$f_y$	=	355 MPa
Height of the tee	$h_{Te}$	=	80.0 mm
Isostatic moment distribution	$C_1$	=	1.132
Critical normal force	$N_{cr}$	=	49.14 kN
			$M_{end,r} = 0.00$ kNm
			$I_{z,0} = 301.6$ cm <sup>4</sup>

Reduced slenderness	$\lambda_b$	=	3.981
Reduction factor (curve "c")	$\chi$	=	0.056
Partial factor	$\gamma_{M1}$	=	1.000
Resistant normal force	$N_{b,Rd}$	=	43.72 kN
Check	$\Gamma_{LT}$	=	6.129

#### Minimal throat thickness at post no 1

Combination U5			
Width of the post	w	=	360.0 mm
Ultimate strength	$f_u$	=	470.0 MPa
Moments at openings sections	$M_{Ed,l}$	=	-32.87 kNm
Spacings between tee chords	$d_{G,l}$	=	410.6 mm
Axial forces in lower chords	$N_{m,Ed,l}$	=	-80.05 kN
Force and moment in the post	$V_{h,Ed}$	=	93.98 kN
Partial factor	$\gamma_{M2}$	=	1.25
Throat thickness	a	=	0.541 mm
	$\beta_w$	=	0.90
	$M_{Ed,r}$	=	-71.45 kNm
	$d_{G,r}$	=	410.6 mm
	$N_{m,Ed,r}$	=	-174.0 kN
	$M_{h,Ed}$	=	0.0 kNm

Warning: the throat thickness is assessed by assuming two welds  
The total thickness of welds should be at least 1.08 mm

### SERVICEABILITY LIMIT STATES (SLS)

#### Deflections

v : Maximum vertical deflection of the beam

#### Under elementary load cases

Permanent loads (G) :	v = 3.39 mm (S10)	= L / 3543
Live loads 1 (Q1) :	v = 21.74 mm (S10)	= L / 552
Live loads 2 (Q2) :	v = -62.40 mm (S10)	= L / 192

#### Under SLS Combinations

S1 = 1.00 G + 1.00 Q1 :	v = 25.1 mm (S10)	= L / 478
-------------------------	-------------------	-----------

The user has to check whether the deflections are acceptable according to the project requirements and to consider a precambering if necessary.

#### Natural frequencies

Load case / Combination	Mass assumed to be concentrated	Mass assumed to be distributed
G	8.59Hz	9.78Hz
G + 0.1 Q1	6.70Hz	7.63Hz
G + 0.2 Q1	5.68Hz	6.47Hz
G + 0.3 Q1	5.02Hz	5.72Hz
G + 0.4 Q1	4.55Hz	5.18Hz
G + 0.5 Q1	4.18Hz	4.77Hz



## 4 DIMENZIONIRANJE SPOJA GLAVNE NOSIVE KONSTRUKCIJE I AB STUPA

### 4.1 Dimenzioniranje spoja

Koristeći von Mises-ovu teoriju čvrstoće, višeosno stanje naprezanja u kratkim čeličnim elementima svodi se na ekvivalentno jednoosno stanje naprezanja. Napon je vrijednost koju koristimo za provjeru da li je materijal dostigao granicu tečenja. Ovaj kriterij se koristi za duktilne materijale, u ovom projektu to je čelik. Von Misesov kriterij kaže da, ako je Von Misesov napon u materijalu pod opterećenjem jednak ili veći od granice tečenja istog materijala pod čistim zatezanjem, onda će taj material teći. Teorija von Mises se koristi u materijalima koji se nalaze u višeosnim stanjima naprezanja.

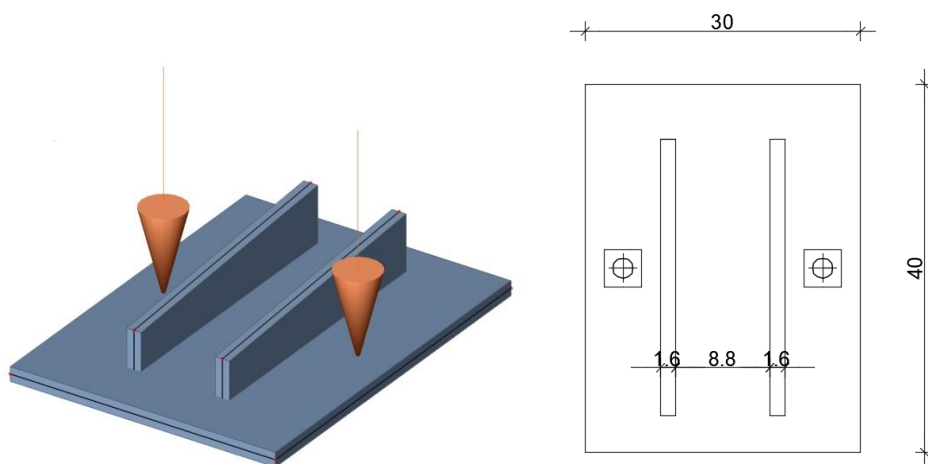

Slika 8 : Detalj spoja

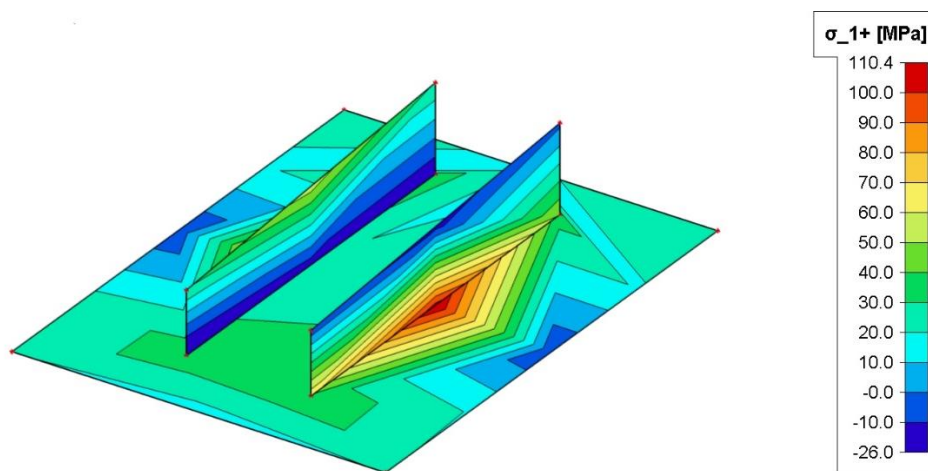

Slika 9 : Glavno naprezanje  $\sigma_{1+}$

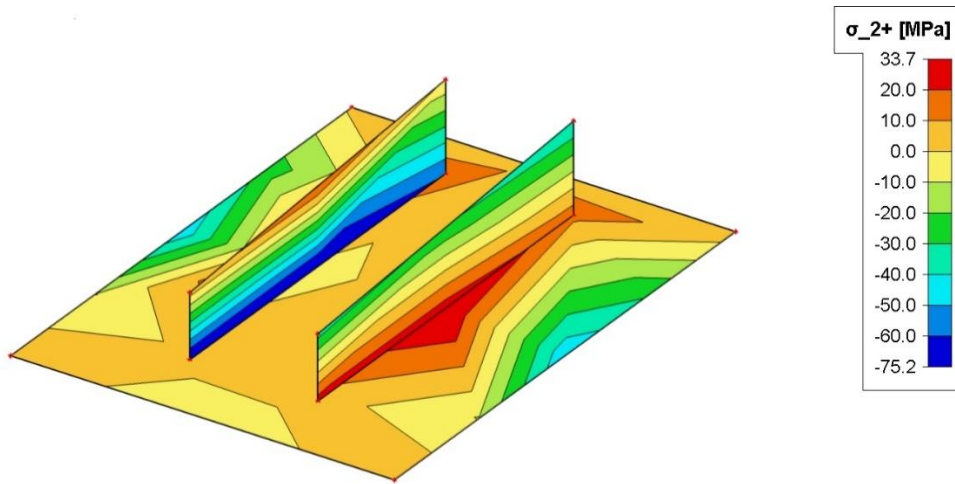

**Slika 10** : Glavno naprezanje  $\sigma_{2+}$

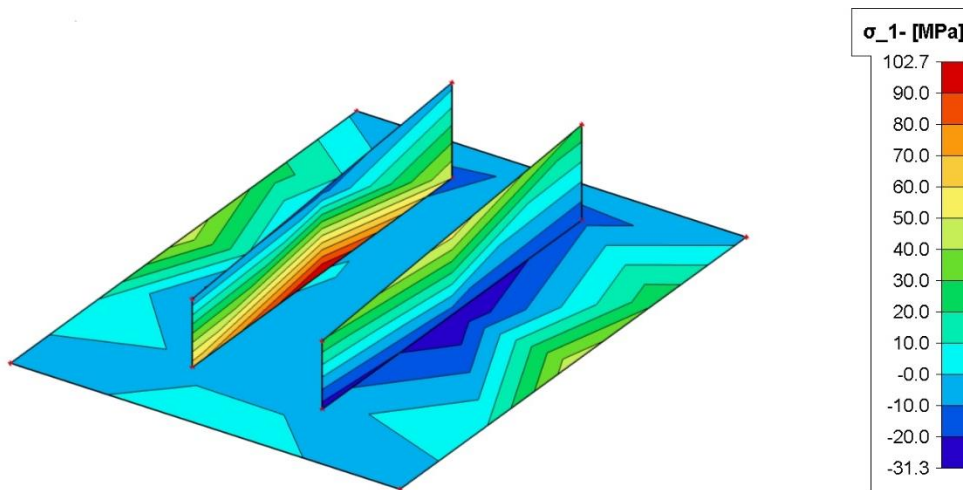

**Slika 11** : Glavno naprezanje  $\sigma_{1-}$

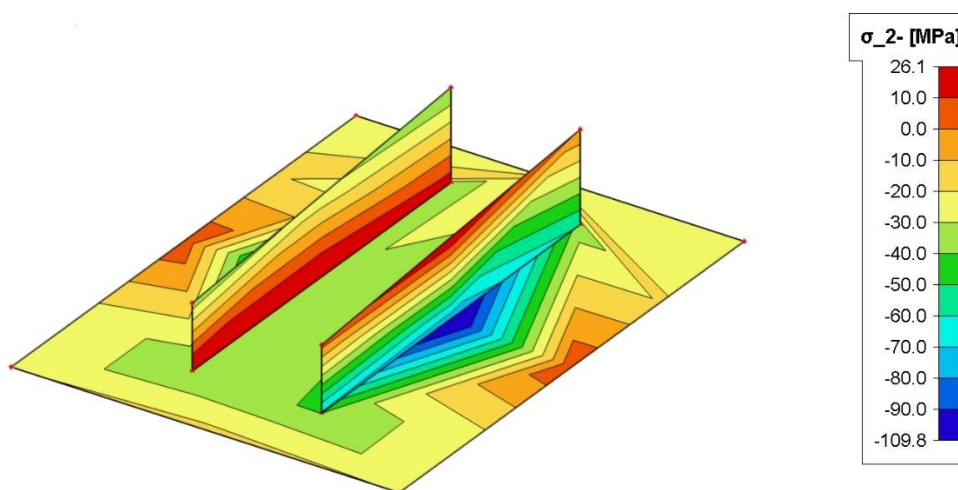

**Slika 12** : Glavno naprezanje  $\sigma_{2-}$

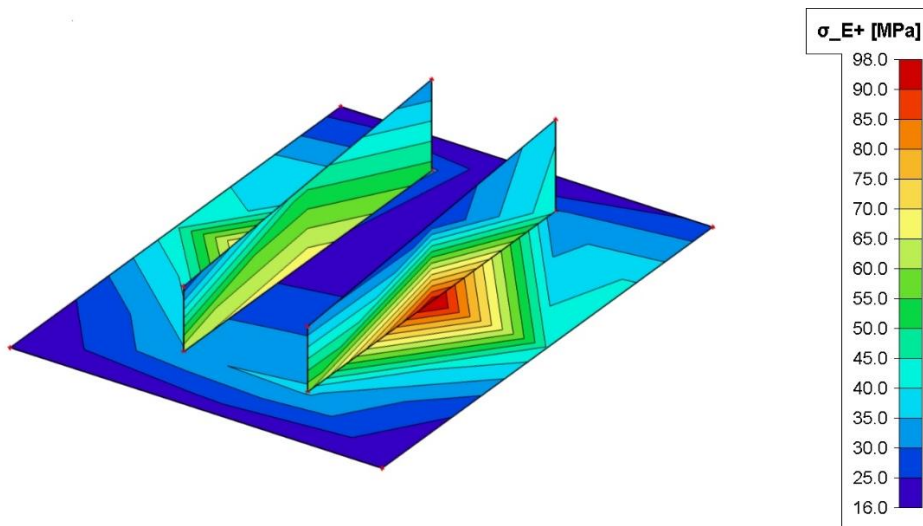

Slika 13 : Glavno naprezanje + [Mises]

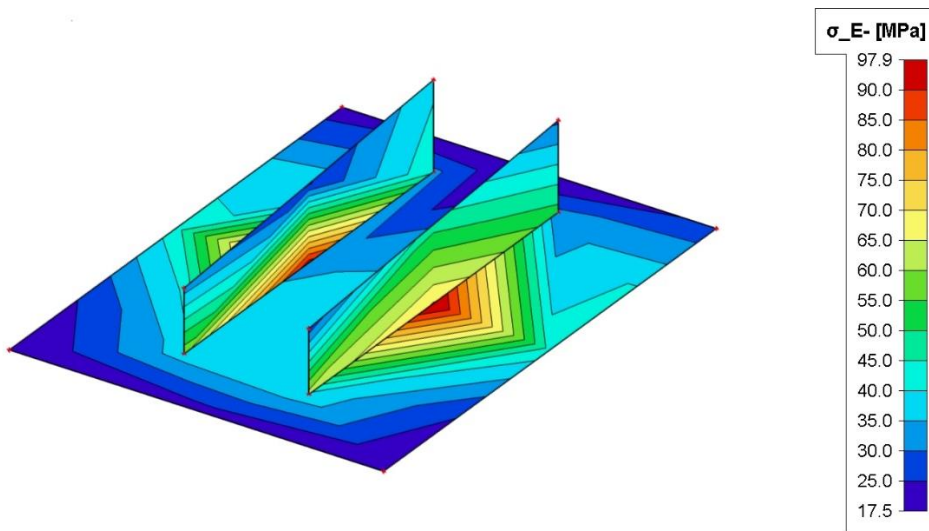

Slika 14 : Glavno naprezanje - [Mises]

Zadovoljen je uvjet :

Principal stress:

$$\max \sigma_E < f_y / \gamma_M$$

$$110,4 \text{ Mpa} < 355 / 1,15 \text{ N/mm}^2$$

$$110,4 \text{ Mpa} < 308,7 \text{ N/mm}^2$$

## 5 SEKUNDARNA KONSTRUKCIJA

### 5.1 Krovne podrožnice

Poprečni presjek : IPE 100

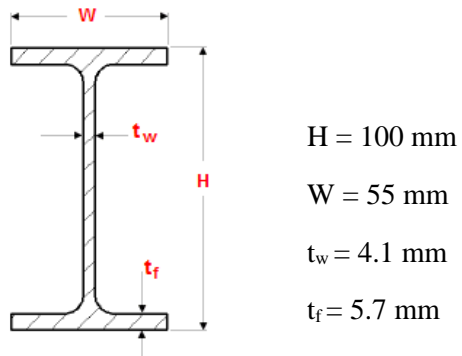

### 5.2 Dijagrami reznih sila

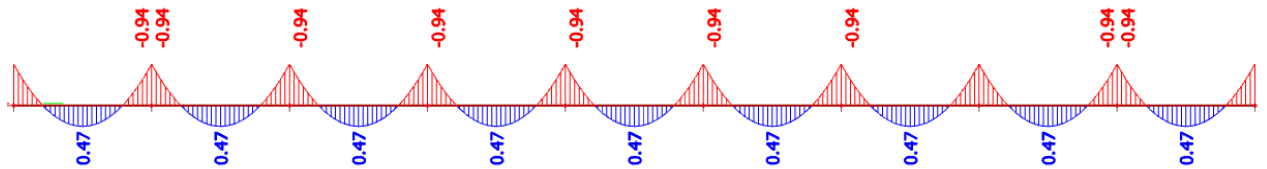

Slika 6 : Moment savijanja  $M_y$  (kNm)

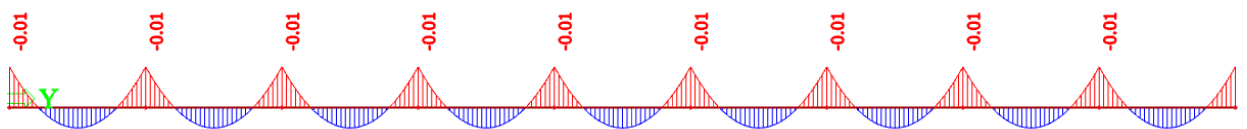

Slika 7 : Moment savijanja  $M_z$  (kNm)

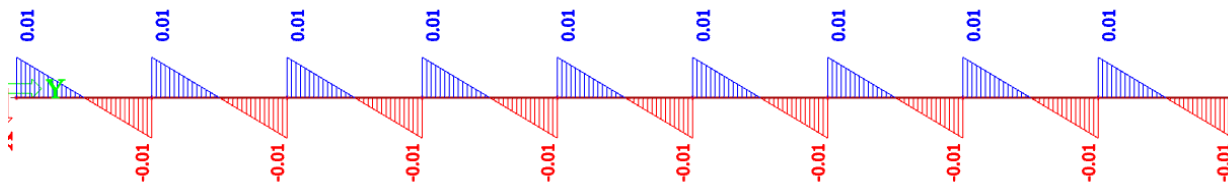

Slika 8 : Poprečna sila  $V_y$  (kN)

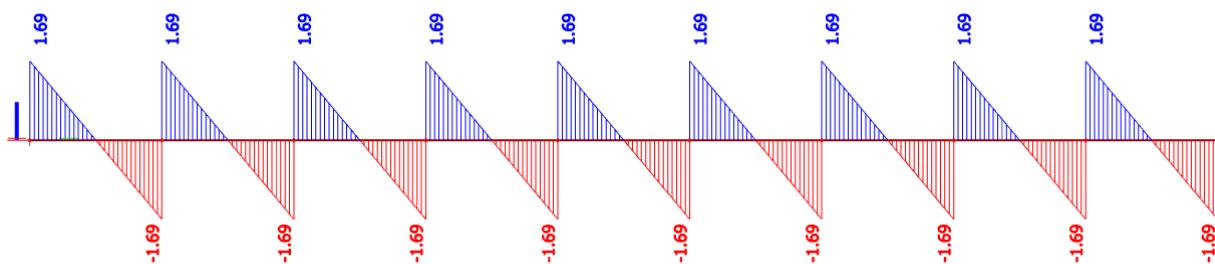

Slika 7 : Poprečna sila  $V_z$  (kN)

### 5.3 Provjera progiba GSU

3D displacement  
 Values:  $u_z$   
 Linear calculation  
 Combination: GSU  
 Selection: All  
 Location: In nodes avg. on macro.  
 System: LCS mesh element

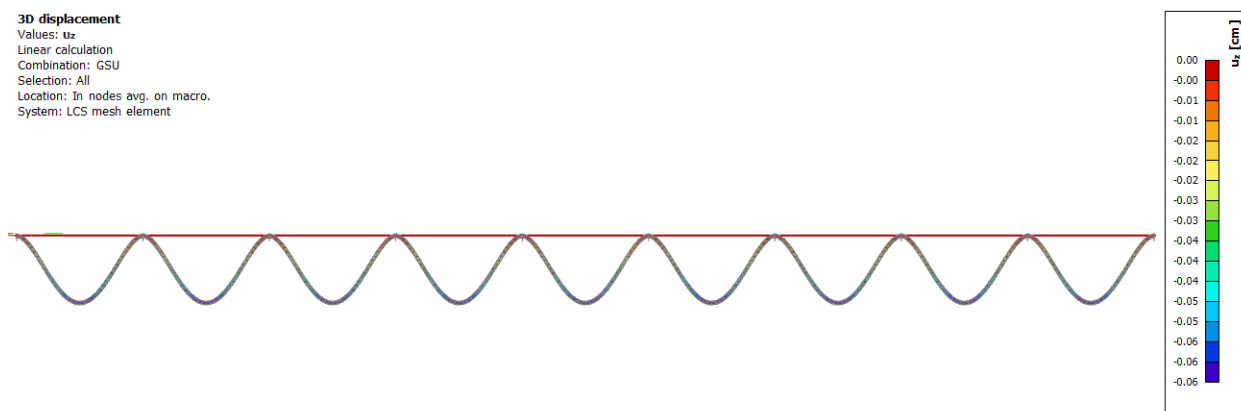

$$w = -0.06 \text{ mm} < L/250 = 3350/250 = 13.4 \text{ mm}$$

- Najveći progib zadovoljava GSU.

## 5.4 Dimenzioniranje presjeka

### EC-EN 1993 Steel check ULS

Linear calculation  
 Combination: GSN  
 Coordinate system: Principal  
 Extreme 1D: Global  
 Selection: All

**EN 1993-1-1 Code Check**  
 National annex: Standard EN

<b>Member B9</b>	<b>0.000 / 3.350 m</b>	<b>IPE100</b>	<b>S 355</b>	<b>GSN</b>	<b>0.10 -</b>
------------------	------------------------	---------------	--------------	------------	---------------

<b>Combination key</b>	
GSN /	1.35*G + 1.35*Gdst + 1.50*Q

<b>Partial safety factors</b>	
$\gamma_{M0}$ for resistance of cross-sections	1.00
$\gamma_{M1}$ for resistance to instability	1.00
$\gamma_{M2}$ for resistance of net sections	1.25

<b>Material</b>		
Yield strength $f_y$	355.00	MPa
Ultimate strength $f_u$	490.00	MPa
Fabrication	Rolled	

....SECTION CHECK:....

The critical check is on position 0.000 m

Internal forces	Calculated	Unit
$N_{Ed}$	0.00	kN
$V_{y,Ed}$	0.01	kN
$V_{z,Ed}$	1.69	kN
$T_{Ed}$	0.00	kNm
$M_{y,Ed}$	-0.94	kNm
$M_{z,Ed}$	-0.01	kNm

#### Classification for cross-section design

Classification according to EN 1993-1-1 article 5.5.2

Classification of Internal and Outstand parts according to EN 1993-1-1 Table 5.2 Sheet 1 & 2

Id	Type	c [cm]	t [cm]	$\sigma_1$ [MPa]	$\sigma_2$ [MPa]	$\Psi$ [-]	$k_\sigma$ [-]	$\alpha$ [-]	c/t [-]	Class 1 Limit [-]	Class 2 Limit [-]	Class 3 Limit [-]	Class
1	SO	1.84	0.57	26.353	27.162	1.0	0.4	1.0	3.2	7.3	8.1	11.2	1
3	SO	1.84	0.57	25.558	24.749	1.0	0.4	1.0	3.2	7.3	8.1	11.4	1
4	I	7.46	0.41	20.533	-20.533	-1.0		0.5	18.2	58.6	67.5	100.9	1
5	SO	1.84	0.57	-26.353	-27.162								
7	SO	1.84	0.57	-25.558	-24.749								

The cross-section is classified as Class 1

#### Bending moment check for $M_y$

According to EN 1993-1-1 article 6.2.5 and formula (6.12),(6.13)

$W_{pl,y}$	39.4000	cm <sup>3</sup>
$M_{pl,y,Rd}$	13.99	kNm
Unity check	0.07	-

#### Bending moment check for $M_z$

According to EN 1993-1-1 article 6.2.5 and formula (6.12),(6.13)

$W_{pl,z}$	9.2000	cm <sup>3</sup>
$M_{pl,z,Rd}$	3.27	kNm
Unity check	0.00	-

### Shear check for $V_y$

According to EN 1993-1-1 article 6.2.6 and formula (6.17)

$\eta$	1.20	
$A_v$	6.7251	cm <sup>2</sup>
$V_{pl,y,Rd}$	137.84	kN
Unity check	0.00	-

### Shear check for $V_z$

According to EN 1993-1-1 article 6.2.6 and formula (6.17)

$\eta$	1.20	
$A_v$	5.0617	cm <sup>2</sup>
$V_{pl,z,Rd}$	103.74	kN
Unity check	0.02	-

### Combined bending, axial force and shear force check

According to EN 1993-1-1 article 6.2.9.1 and formula (6.41)

$M_{pl,y,Rd}$	13.99	kNm
$\alpha$	2.00	

$M_{pl,z,Rd}$	3.27	kNm
$\beta$	1.00	

Unity check (6.41) = 0.00 + 0.00 = 0.01 -

**Note:** Since the shear forces are less than half the plastic shear resistances their effect on the moment resistances is neglected.

The member satisfies the section check.

### ....:STABILITY CHECK:....

#### Classification for member buckling design

Decisive position for stability classification: 0.000 m

Classification according to EN 1993-1-1 article 5.5.2

Classification of Internal and Outstand parts according to EN 1993-1-1 Table 5.2 Sheet 1 & 2

Id	Type	c [cm]	t [cm]	$\sigma_1$ [MPa]	$\sigma_2$ [MPa]	$\Psi$ [-]	$k_\sigma$ [-]	$\alpha$ [-]	c/t [-]	Class 1 Limit [-]	Class 2 Limit [-]	Class 3 Limit [-]	Class
1	SO	1.84	0.57	26.353	27.162	1.0	0.4	1.0	3.2	7.3	8.1	11.2	1
3	SO	1.84	0.57	25.558	24.749	1.0	0.4	1.0	3.2	7.3	8.1	11.4	1
4	I	7.46	0.41	20.533	-20.533	-1.0		0.5	18.2	58.6	67.5	100.9	1
5	SO	1.84	0.57	-26.353	-27.162								
7	SO	1.84	0.57	-25.558	-24.749								

The cross-section is classified as Class 1

### Lateral Torsional Buckling check

According to EN 1993-1-1 article 6.3.2.1 & 6.3.2.2 and formula (6.54)

LTB parameters		
Method for LTB curve	General case	
Plastic section modulus $W_{pl,y}$	39.4000	cm <sup>3</sup>
Elastic critical moment $M_{cr}$	14.20	kNm
Relative slenderness $\lambda_{rel,LT}$	0.99	
Limit slenderness $\lambda_{rel,LT,0}$	0.20	
LTB curve	a	
Imperfection $\alpha_{LT}$	0.21	
Reduction factor $\chi_{LT}$	0.67	
Design buckling resistance $M_{b,Rd}$	9.38	kNm
Unity check	0.10	-

Mcr parameters		
LTB length $l_{LT}$	3.350	m
Influence of load position	no influence	
Correction factor k	1.00	
Correction factor $k_w$	1.00	
LTB moment factor $C_1$	2.58	
LTB moment factor $C_2$	1.55	
LTB moment factor $C_3$	0.41	
Shear center distance $d_z$	0.00	cm
Distance of load application $z_g$	0.00	cm
Mono-symmetry constant $\beta_y$	0.00	cm
Mono-symmetry constant $z_1$	0.00	cm

**Note:** C parameters are determined according to ECCS 119 2006 / Galea 2002.

#### Bending and axial compression check

According to EN 1993-1-1 article 6.3.3 and formula (6.61),(6.62)

Bending and axial compression check parameters		
Interaction method	alternative method 1	
Cross-section area A	10.3000	cm <sup>2</sup>
Plastic section modulus $W_{pl,y}$	39.4000	cm <sup>3</sup>
Plastic section modulus $W_{pl,z}$	9.2000	cm <sup>3</sup>
Design compression force $N_{Ed}$	0.00	kN
Design bending moment (maximum) $M_{y,Ed}$	-0.94	kNm
Design bending moment (maximum) $M_{z,Ed}$	-0.01	kNm
Characteristic compression resistance $N_{Rk}$	365.65	kN
Characteristic moment resistance $M_{y,Rk}$	13.99	kNm
Characteristic moment resistance $M_{z,Rk}$	3.27	kNm
Reduction factor $\chi_y$	1.00	
Reduction factor $\chi_z$	1.00	
Reduction factor $\chi_{LT}$	0.67	
Interaction factor $k_{yy}$	1.00	
Interaction factor $k_{yz}$	0.69	
Interaction factor $k_{zy}$	0.53	
Interaction factor $k_{zz}$	1.00	

Maximum moment  $M_{y,Ed}$  is derived from beam B9 position 0.000 m.

Maximum moment  $M_{z,Ed}$  is derived from beam B9 position 0.000 m.

#### Shear Buckling check

According to EN 1993-1-5 article 5 & 7.1 and formula (5.10) & (7.1)

Shear Buckling parameters		
Buckling field length a	3.350	m
Web	unstiffened	
Web height $h_w$	8.86	cm
Web thickness t	0.41	cm
Material coefficient $\epsilon$	0.81	
Shear correction factor $\eta$	1.20	

Shear Buckling verification	
Web slenderness $h_w/t$	21.61
Web slenderness limit	48.82

**Note:** The web slenderness is such that Shear Buckling effects may be ignored according to EN 1993-1-5 article 5.1(2).

The member satisfies the stability check.

Odbrani profil sekundarnog nosača je IPE 100.



## 6 ZAKLJUČAK

Tema ovog diplomskoga rada bila je proračunati glavne elemente čeličnog krova industrijske hale. Odabrani i proračunati profili nosača glavne nosive konstrukcije su IPE 270 (saćasti nosač) duljine 12.0 m, postavljenih na osnom razmaku od 3.35 m. Sekundarna konstrukcija je dimenzionirana od standardnih IPE 100 nosača postavljenih na osnom razmaku od 2,0 m. Projekt je izveden za halu tlocrtnih dimenzija 30.45 x 12.10 m sa jednostrešnim krovom nagiba 7%. Visina hale u strehi iznosi 5.0 m, a u sljemenu 5.85 m. Analiza konstrukcije je provedena računalnim programima SCIA engineer 2018 i ArceloMittal software Angelina. Zbog kompleksnosti samih saćastih profila, te zbog toga što im svojstva poprečnog presjeka nisu jednoznačno definirana, posebna pozornost u projektu je posvećena izradi modela glavnog nosivog sustava krovišta odnosno saćastog nosača. Jednostavnim postupcima rezanja i ponovnog zavarivanja od standardnih vrućevaljanih profila dobivaju se nosači koji imaju moment tromosti veći do 100% i moment otpora veći od 50% uz isti utrošak materijala, odnosno istu vlastitu težinu. Povećanje otpornosti saćastih nosača je nešto manje, ali ipak znatno u odnosu na profil od kojeg su dobiveni. Na kraju se može zaključiti da je kompleksnost izvedbe saćastih nosača znatno manja od prednosti koju ovakvi nosači pružaju te je njihova primjena racionalnija od primjene odgovarajućih standardnih valjanih ili zavarenih profila. Nakon dimenzioniranja nosivih elemenata pristupilo se oblikovanju i proračunu spoja stup-greda. Veza između spoja glavne nosive grede i AB stupa ostvarena je sidrenjem vijaka M20 k.v. 10.9 u AB stup. U zadnjoj fazi izrađeni su detaljni nacrti konstrukcije te nacrti detalja spoja. Također je izveden detaljan radionički nacrt rezanja i ponovnog spajanja IPE profila kojim se dobiva gotovi saćasti nosač. Kod projektiranja svih nosivih elemenata konstrukcije korišten je čelik Fe 510 (S 355). Svi elementi su dimenzionirani prema HRN EN 1993, a korisno opterećenje prema HRN EN 1991. Diplomski rad je izrađen na razini izvedbenog projekta.

## 7 ISKAZ MATERIJALA

Svi elementi su izrađeni od čelika Fe 510 ( S355).

POZICIJA	PROFIL	DULJINA (m)	KOMADA	SPECIFIČNA TEŽINA	UKUPNA TEŽINA (kg)
1	Saćasti IPE 270	12	10	436,0 kg/kom	4360,0
2a	IPE 100	3,41	14	8,1 kg/m'	386,7
2b	IPE 100	3,35	49	8,1 kg/m'	1329,6
P1	40x30x1.6	Proračun preko zapremnine	20	7850 kg/m <sup>3</sup>	376,8
P2	30x6x1.6	Proračun preko zapremnine	40	7850 kg/m <sup>3</sup>	170,0

Ukupno (kg)	6623,3
+2% spojna sredstva	132,5
<b>UKUPNO (kg)</b>	<b>6755,8</b>

## 8 LITERATURA

- (1) B. Androić; D. Dumović; I. Džeba: Metalne konstrukcije 1, Institut građevinarstva Hrvatske, Zagreb, 1994.
- (2) Eurocode HRN EN 1993
- (3) Fakultet građevinarstva, arhitekture i geodezije, Split : B.Peroš , I.Boko ; Predavanja
- (4) ArceloMittal predesign software 'Angelina'
- (5) ArceloMittal internet page; design and fabrication of castelled beams
- (6) Glavni projekt trgovačkog centra 'Portanova' u Osijeku; I.Matić , I.Boko

## **9 NACRTI**

# PLAN POZICIJA KROVIŠTA M 1:200

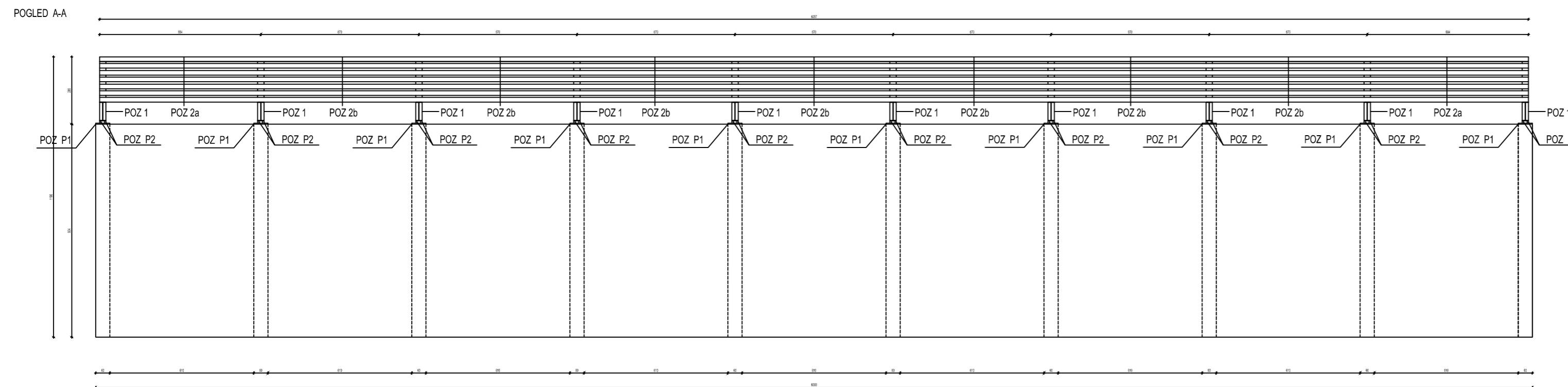
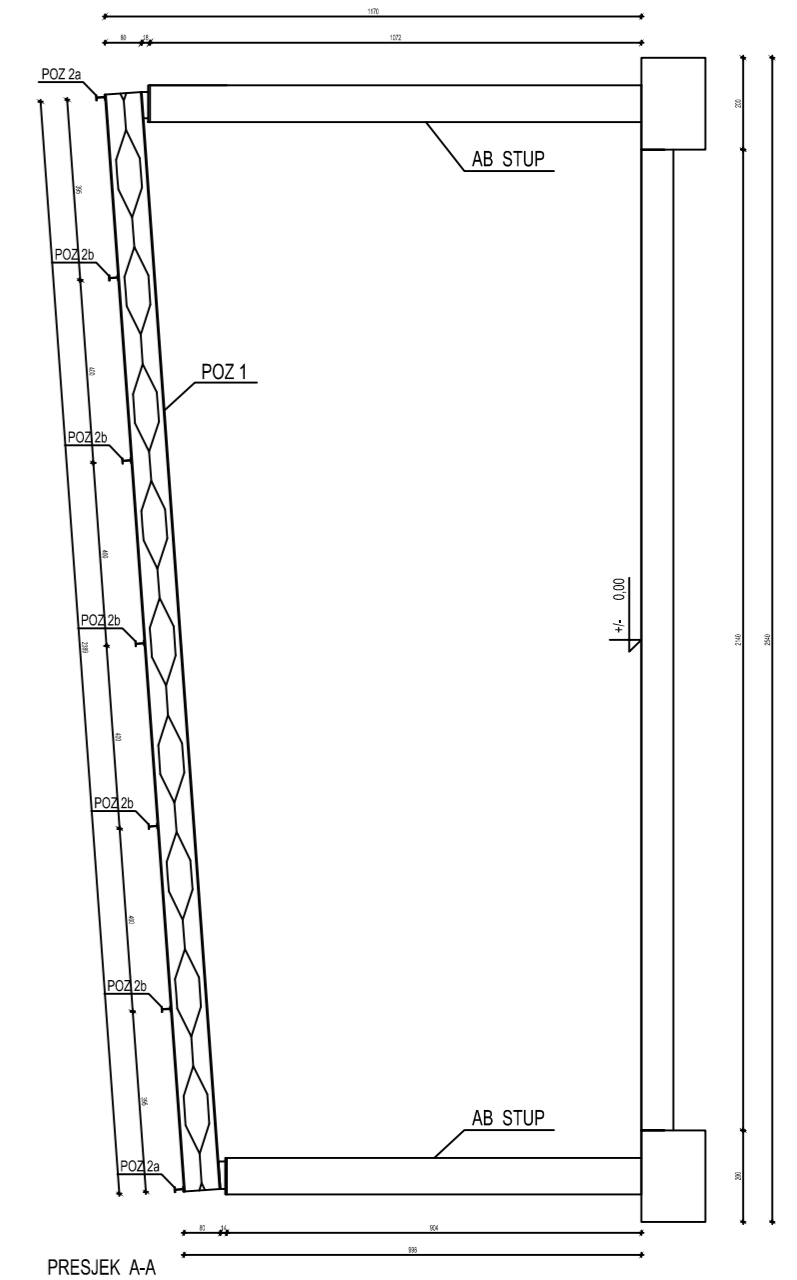
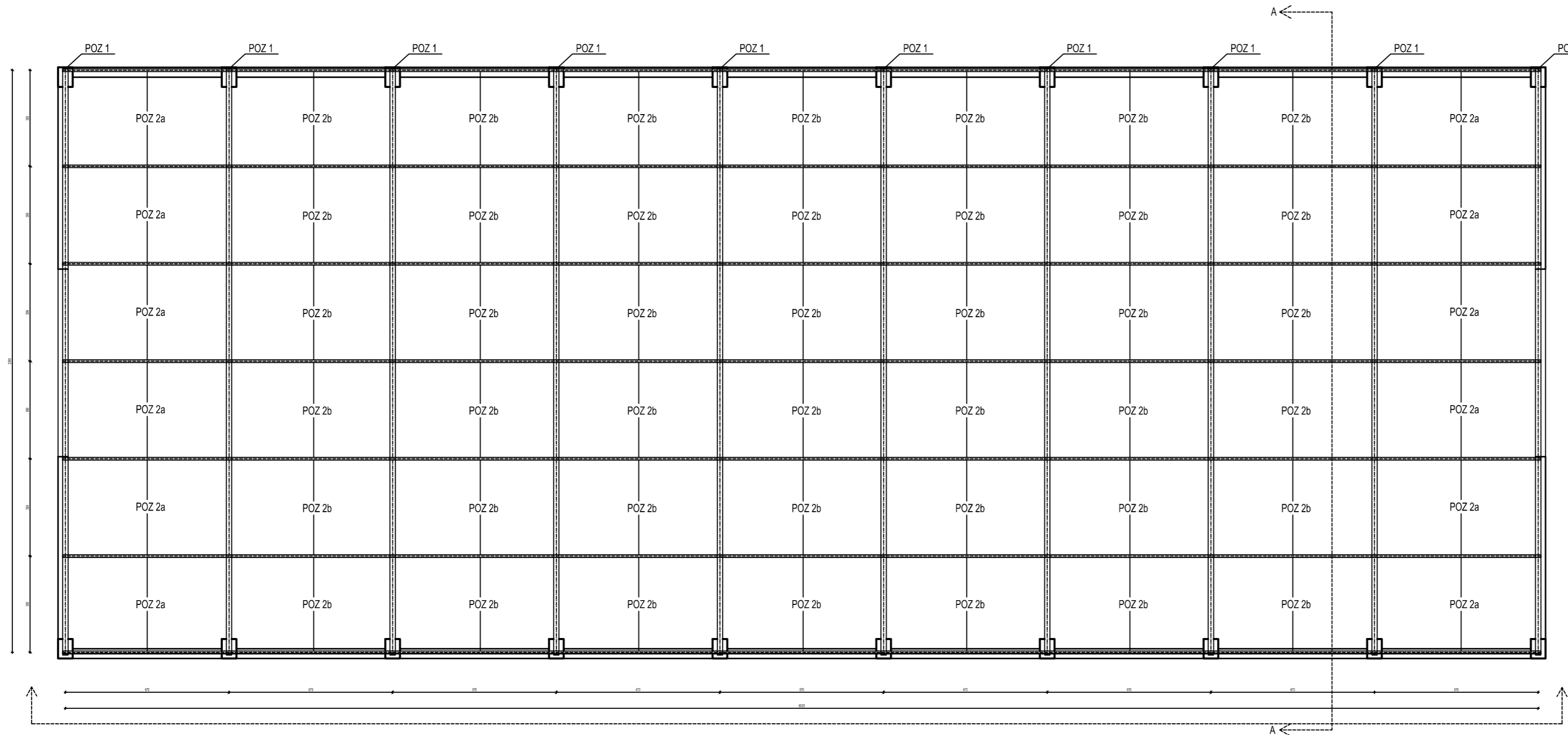

Prikaz i opis pozicija		
POZICIJA	PROFIL	NAZIV
POZ 1	IPE 270	SLAVNENOSIČ
POZ 2a	IPE 100	SEKONDARNE NOSIČ
POZ 2b	IPE 100	SEKONDARNE NOSIČ
POZ P1	40x30x1,6 cm	POŠA U SPOLU-STUPANJ GREDI
POZ P2	30x7x1,6 cm	PROJE U SPOLU

Sve dimenzije su prikazane u ( cm )

 <p>FAKULTET GRAĐEVINARSTVA, ARHITEKTURE I GEODEZIJE KATEDRA ZA BETONSKE KONSTRUKCIJE I MOSTOVE 21000 SPLIT, MATICE HRVATSKE 15</p>	DIPLOMSKI RAD	
	TEMA: PROJEKT KONSTRUKCIJE ČELIČNOG KROVIŠTA INDUSTRIJSKE HALE	
STUDENT: Ivan Mošić		MJERILO 1:200
SADRŽAJ: PLAN POZICIJA KROVIŠTA	DATUM: srpanj 2019.	PRILOG 1

# PRESJEK A-A KROZ GLAVNI OKVIR M 1:50

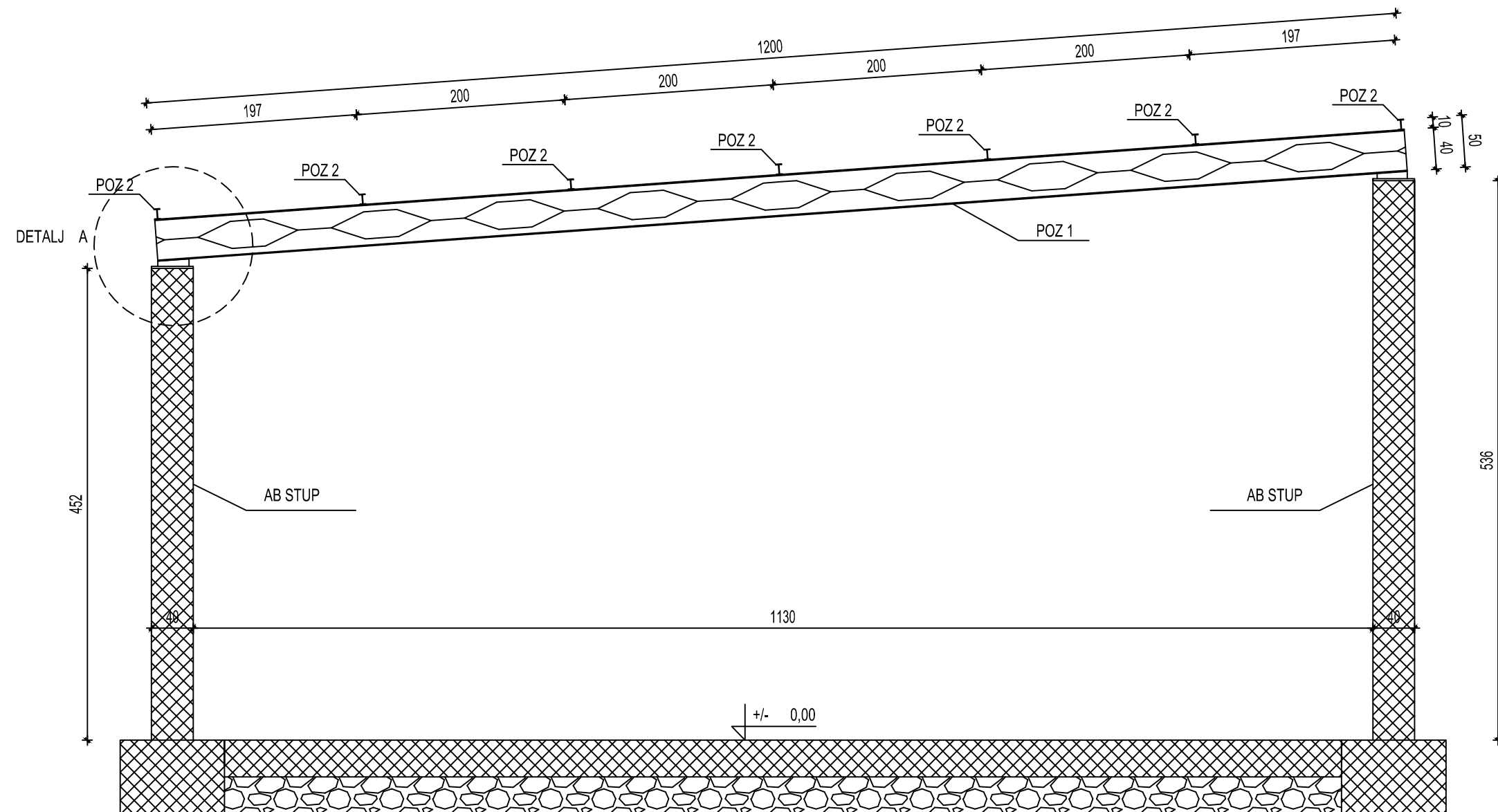

Sve dimenzije su prikazane u ( cm )

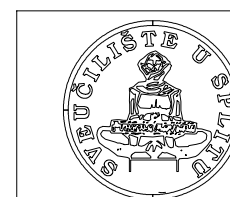

FAKULTET GRAĐEVINARSTVA, ARHITEKTURE I  
GEODEZIJE  
KATEDRA ZA BETONSKE KONSTRUKCIJE I MOSTOVE  
21000 SPLIT, MATICE HRVATSKE 15

DIPLOMSKI RAD			
TEMA:	PROJEKT KONSTRUKCIJE ČELIČNOG KROVIŠTA INDUSTRIJSKE HALE		
STUDENT:	Ivan Mošić		
SADRŽAJ	PRESJEK A-A KROZ GLAVNI OKVIR	MJERILO	1:50
DATUM	srpanj 2019.	PRILOG	2

# RADIONIČKI NACRT M 1:50

POZ 1 ; IPE 270 ; L=1200 mm ; kom 10

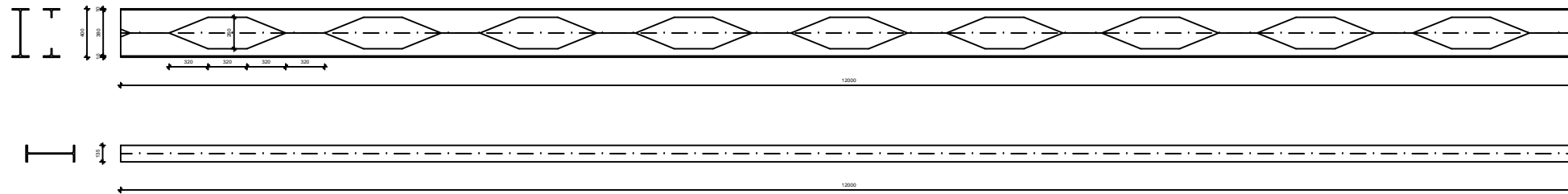

POZ 2a ; IPE 100 ; L=3410 mm ; kom 14

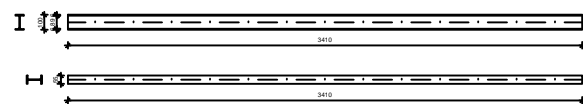

POZ 2b ; IPE 100 ; L=3350 mm ; kom 49

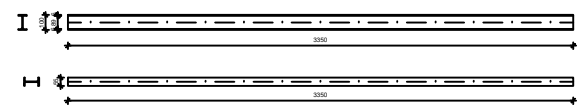

POZ P1 ; 40x30x1.6 cm ; kom 20



POZ P2 ; 30x7x1.6 cm ; kom 40



PRIKAZ I OPIS POZICIJA		
POZICIJA	PROFIL	NAZIV
POZ 1	IPE 270	GLAVNI NOSAČ
POZ 2a	IPE 100	SEKUNDARNI NOSAČ
POZ 2b	IPE 100	SEKUNDARNI NOSAČ
POZ P1	40x30x1.6 cm	PLOČA U SPOJU STUPA I GREDE
POZ P2	30x7x1.6 cm	PLOČE U SPOJU

Sve dimenzije su prikazane u ( mm )

<p>FAKULTET GRAĐEVINARSTVA, ARHITEKTURE I GEODEZIJE KATEDRA ZA BETONSKE KONSTRUKCIJE I MOSTOVE 21000 SPLIT, MATICE HRVATSKE 15</p>	DIPLOMSKI RAD			
	TEMA: PROJEKT KONSTRUKCIJE ČELIČNOG KROVIŠTA INDUSTRIJSKE HALE			
	STUDENT: Ivan Mošić			
	SADRŽAJ	RADIONIČKI NACRT	MJERILO	1:50
DATUM	srpanj 2019.	PRILOG	3	

DETALJ SPOJA STUPA I GLAVNOG NOSAČA

DETALJ A M 1:10

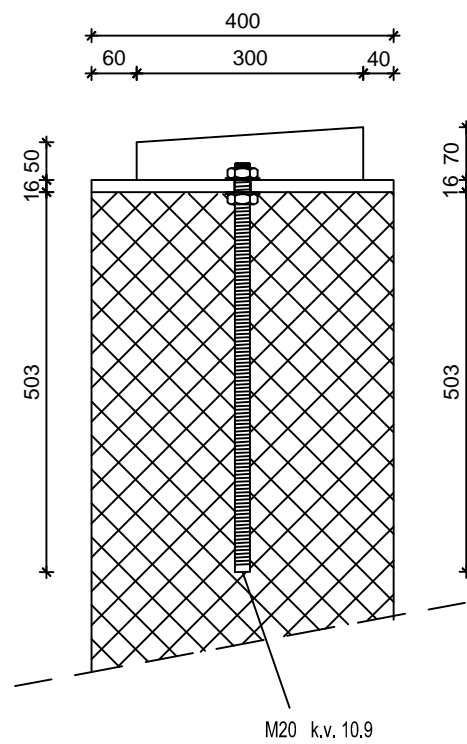
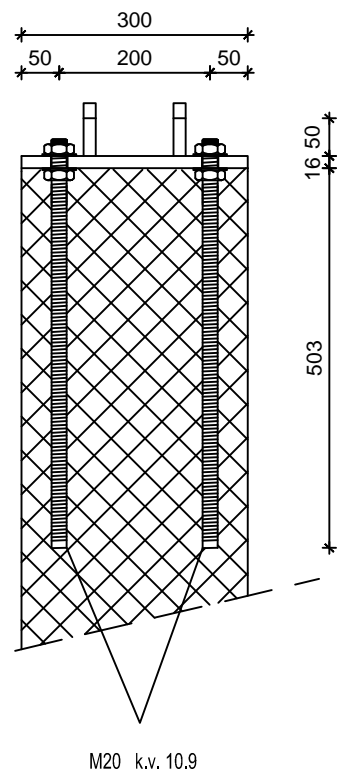
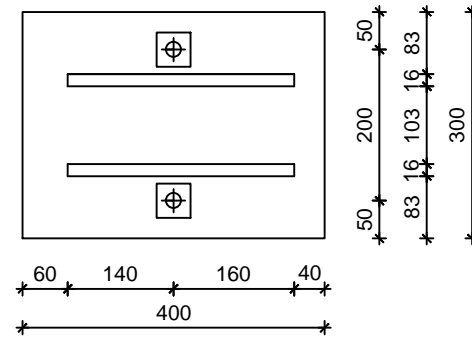
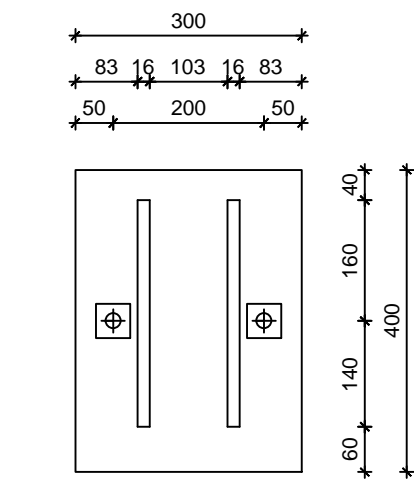

DETALJ A

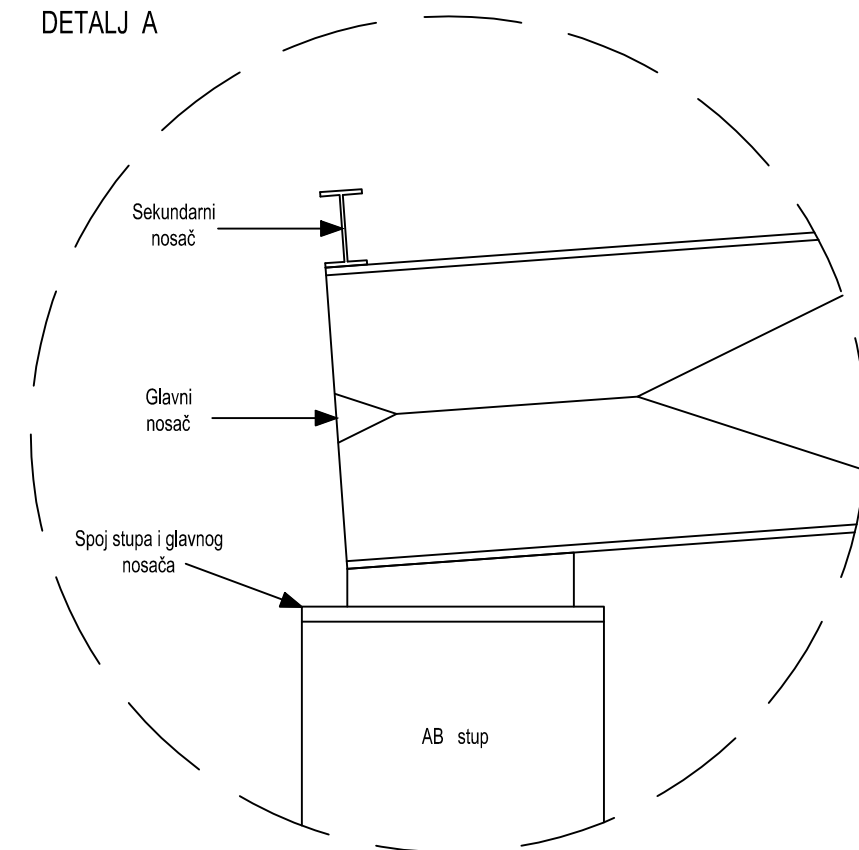

Sve dimenzije su prikazane u ( mm )

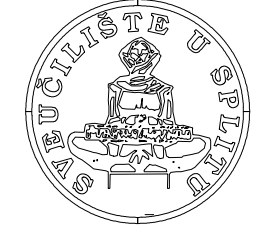
 <p>FAKULTET GRAĐEVINARSTVA, ARHITEKTURE I GEODEZIJE KATEDRA ZA BETONSKE KONSTRUKCIJE I MOSTOVE 21000 SPLIT, MATICE HRVATSKE 15</p>	DIPLOMSKI RAD		
	TEMA: PROJEKT KONSTRUKCIJE ČELIČNOG KROVIŠTA INDUSTRIJSKE HALE		
	STUDENT: Ivan Mošić		
	SADRŽAJ	DETALJ A	MJERILO
DATUM	srpanj 2019.	PRILOG	4



# RADIONIČKI PLAN REZANJA I SASTAVLJANJA M 1:50

Rezanje standardnog IPE 270

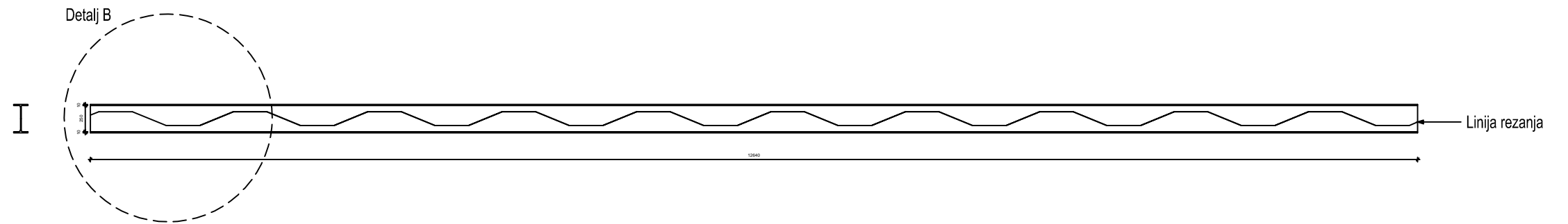

Rastavljanje IPE 270

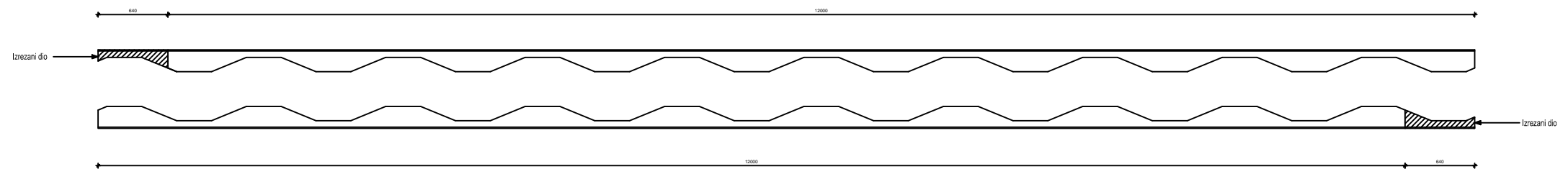

Sastavljanje sačastog nosača IPE 270

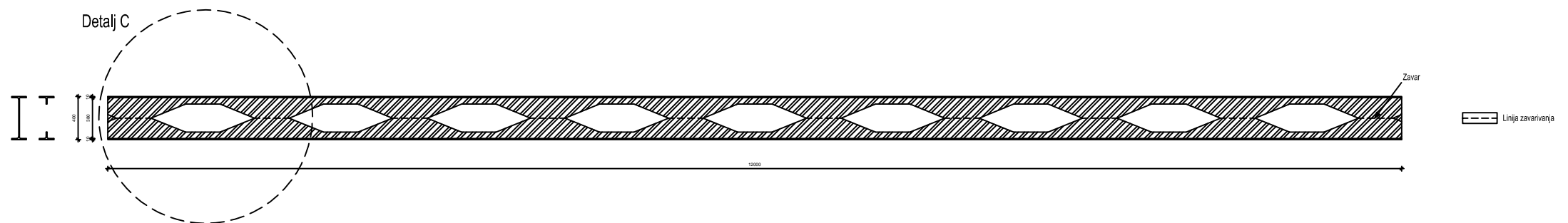

Sve dimenzije su prikazane u ( mm )

 <p>FAKULTET GRAĐEVINARSTVA, ARHITEKTURE I GEODEZIJE KATEDRA ZA BETONSKE KONSTRUKCIJE I MOSTOVE 21000 SPLIT, MATICE HRVATSKE 15</p>	DIPLOMSKI RAD			
	TEMA:			
	PROJEKT KONSTRUKCIJE ČELIČNOG KROVIŠTA INDUSTRIJSKE HALE			
	STUDENT:			
Ivan Mošić				
SADRŽAJ	RADIONIČKI PLAN REZANJA I SASTAVLJANJA	MJERILO	1:50	
DATUM	srpanj 2019.	PRILOG	5	

# DETALJ B i C M 1:10

Detalj B

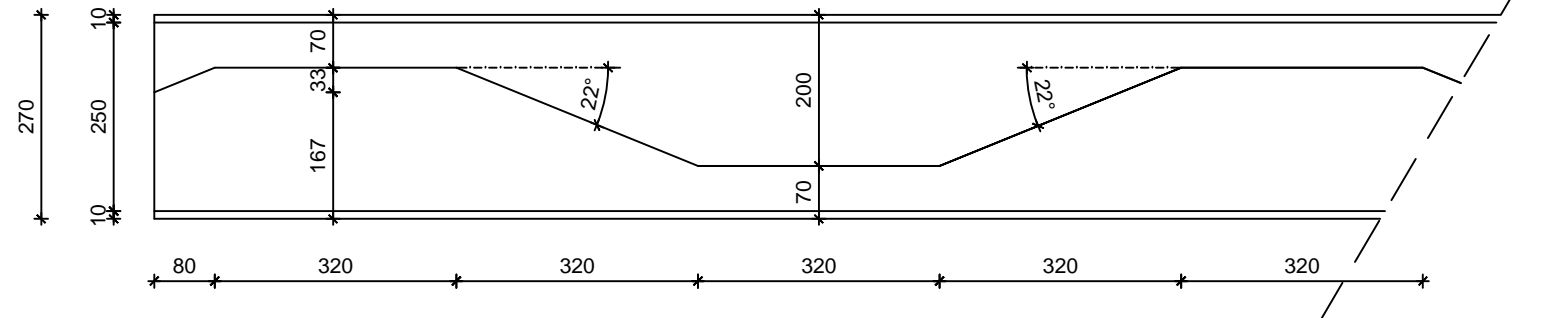
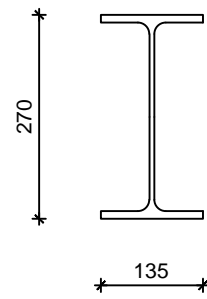

Detalj C

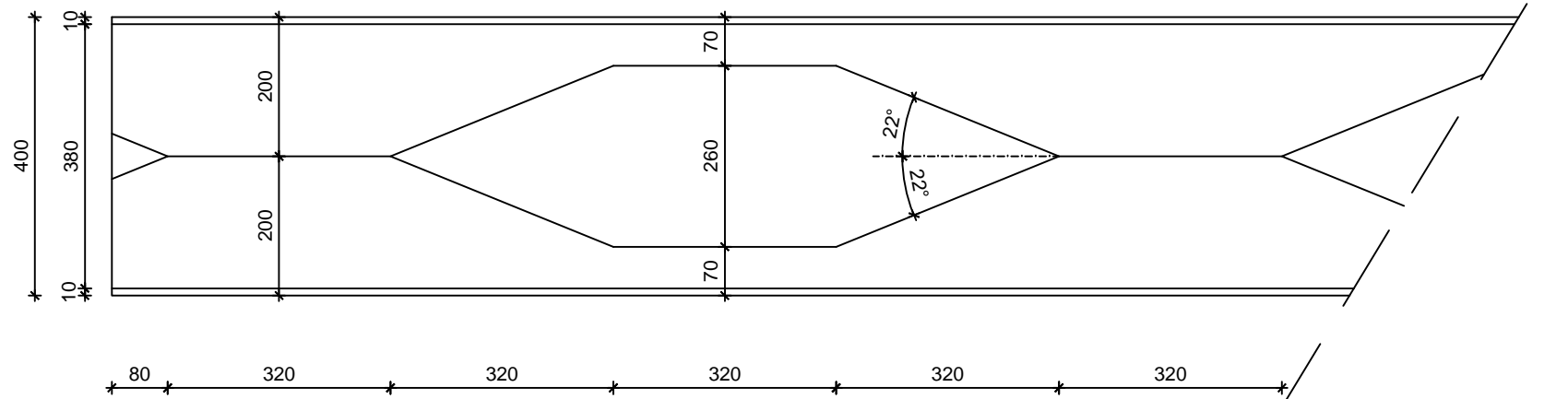
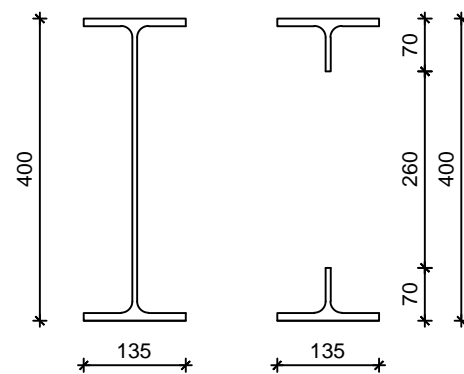

Sve dimenzije su prikazane u ( mm )

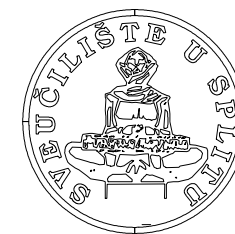

FAKULTET GRAĐEVINARSTVA, ARHITEKTURE I  
GEODEZIJE  
KATEDRA ZA BETONSKE KONSTRUKCIJE I MOSTOVE  
21000 SPLIT, MATICE HRVATSKE 15

DIPLOMSKI RAD

TEMA:

PROJEKT KONSTRUKCIJE ČELIČNOG KROVIŠTA  
INDUSTRIJSKE HALE

STUDENT:

Ivan Mošić

SADRŽAJ

DETALJ B i C

MJERILO

1:10

DATUM

srpanj 2019.

PRILOG

6