

Proračun utjecaja veličine vremenskog koraka na razinu vode u spremnicima

Gverović, Matej

Undergraduate thesis / Završni rad

2020

Degree Grantor / Ustanova koja je dodijelila akademski / stručni stupanj:

University of Split, Faculty of Civil Engineering, Architecture and Geodesy / Sveučilište u Splitu, Fakultet građevinarstva, arhitekture i geodezije

Permanent link / Trajna poveznica: <https://um.nsk.hr/um:nbn:hr:123:264310>

Rights / Prava: [In copyright](#)/[Zaštićeno autorskim pravom.](#)

Download date / Datum preuzimanja: **2024-12-26**



Repository / Repozitorij:

[FCEAG Repository - Repository of the Faculty of Civil Engineering, Architecture and Geodesy, University of Split](#)



SVEUČILIŠTE U SPLITU
FAKULTET GRAĐEVINARSTVA, ARHITEKTURE I
GEODEZIJE

ZAVRŠNI RAD

Matej Gverović

Split, rujan 2020.

SVEUČILIŠTE U SPLITU FAKULTET GRAĐEVINARSTVA,
ARHITEKTURE I
GEODEZIJE

Proračun utjecaja veličine vremenskog koraka na razinu vode u spremnicima

Završni rad

Split, rujan 2020.

SVEUČILIŠTE U SPLITU

FAKULTET GRAĐEVINARSTVA, ARHITEKTURE I GEODEZIJE

Split, Matice hrvatske 15

STUDIJ: PREDDIPLOMSKI SVEUČILIŠNI STUDIJ GRAĐEVINARSTVA

KANDIDAT: Matej Gverović

BROJ INDEKSA: **4311**

KATEDRA: **Hidromehanika**

ZADATAK ZA ZAVRŠNI RAD

Tema: Proračun razine vodostaja u zavisnosti o vremenu numeričkom integracijom mješovitim postupkom, te usporedba dobivenih rezultata.

Opis zadatka: Potrebno je za zadane spremnike povezane jednom kratkom cijevi, izračunati razine vode u zavisnosti o vremenu te grafički prikazati rezultate. Proračun razine vodostaja u zavisnosti o vremenu provodi se numeričkom integracijom mješovitim postupkom te se uspoređuju dobiveni rezultati.

U Splitu 17. svibnja 2020

Voditelj završnog rada

doc. dr. sc. Davor Bojanić, dipl.ing.gra .

Proračun utjecaja veličine vremenskog koraka na razinu vode u spremnicima

Sažetak:

U ovom radu definirane su nam početne razine vodostaja, preljevni pragovi, te površine vodospremnika. Na temelju toga izvršen je proračun za promjenjive vodostaje u spremnicima. U spremnike se ulijevaju protoci promjenjivi po vremenu, a voda se prelijeva preko preljevnih pragova. Proračun je riješen numeričkom integracijom mješovitim postupkom.

Ključne riječi:

protok, preljev, preljevni prag, numerička integracija, mješoviti postupak, spremnik

Calculation of water face in nonprismatic stationary flow channel

Abstract:

In this paper, we have defined the initial water level levels, overflow thresholds, and reservoir surfaces . Based on this, a calculation was made for the variable water levels in the tanks. Time-varying flows are poured into the tanks, and water is poured over the overflow thresholds. The calculation is solved by numerical integration by a mixed procedure.

Keywords: flow, overflow, overflow threshold, numerical integration, mixed process, tank

Sadržaj

1. ZADATAK	1
2. TEHNIČKI OPIS	3
2.1. Uvod	3
2.2. Geometrijske i hidrauličke karakteristike	4
3. Proračun	4
3.1. Postupak proračuna	4
3.2. Rezultati proračuna.....	7
3.3. Grafički prikaz rezultata proračuna.....	32
4. Zaključak	38
5. LITERATURA	38

1. ZADATAK

Proračun utjecaja veličine vremenskog koraka na razinu vodostaja u spremnicima

Zadana su dva otvorena spremnika čije su površine promjenjive ovisno o vodostajima u spremnicima. U spremnike se ulijevaju protoci promjenjivi po vremenu. Spremnici su povezani sa jednom kratkom cijevi. Na spremniku 1, na koti z_{p1} postoji preljevni prag preko kojega se prelijeva višak vode iz prvog spremnika. Na spremniku 2, na koti z_{p2} postoji preljevni prag preko kojega se prelijeva višak vode iz drugog spremnika.

Student će postaviti sve potrebne jednadžbe koje opisuju zadani problem. Zadatak će riješiti numeričkom integracijom mješovitim postupkom.

Zadatak treba riješiti za 3 varijante dužine preljednog praga 2.

Za rješavanje koristiti tablični kalkulator (EXCELL). Rezultate prikazati grafički.

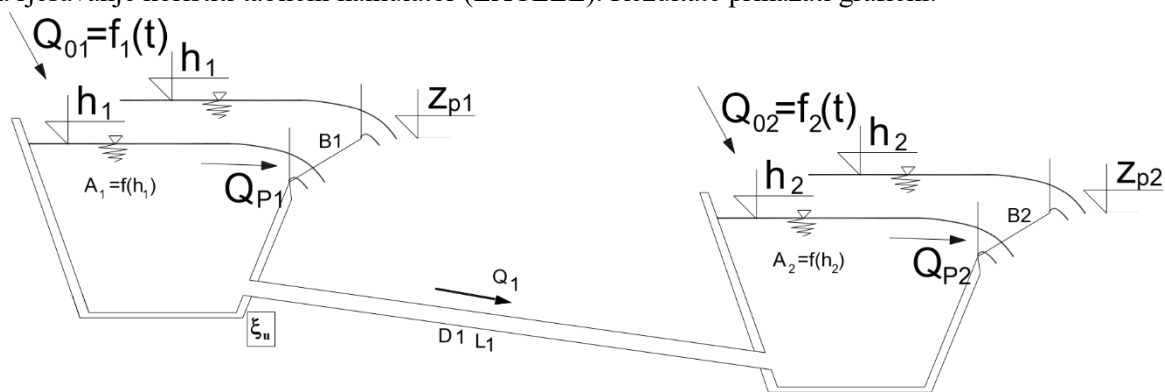

Slika 1. Dva vodospremnika s preljevima povezana sa jednom cijevi

Zadano je:

Površina prvog vodospremnika u funkciji nadmorske visine:

h_1 (m n.m.)	A_1 (m^2)
90	200
100	250
105	270
110	300

Površina drugog vodospremnika u funkciji nadmorske visine:

h_2 (m n.m.)	A_2 (m^2)
90	230
100	280
105	320
110	400

Dotok u prvi vodospremnik:

t (s)	Q ₀ (m ³ /s)
0,00	2,00
200,00	3,00
300,00	8,00
500,00	7,00
900,00	4,00
1200,00	2,00
10000,00	2,00

Dotok u drugi vodospremnik:

t (s)	Q ₀₂ (m ³ /s)
0,00	1,00
200,00	2,00
300,00	6,00
500,00	5,00
900,00	2,50
1200,00	1,50
10000,00	1,50

$D_1=0.8$ (m)

$L_1=100.0$ (m)

$\varepsilon = 0.001$ (m)

$\nu = 0.00000131$ (m/s²)

$\xi_u = 0.5$

$B_1=3.0$ (m); $B_{21}=2.0$ (m); $B_{22}=4.0$ (m); $B_{23}=6.0$ (m) $z_{p1} = 100$ (m n. m.), $z_{p2} = 97$ (m n. m.), $m = 0.4$

Početna razina vode u prvom spremniku je 98.00 (m n.m.). Početna razina vode u drugom spremniku je 96.00 (m n.m.).

Split, 17. svibnja 2020. godine

Mentor:

doc. dr. sc. Davor Bojanić, dipl.ing.gra .

2. TEHNIČKI OPIS

2.1. Uvod

Projektnim zadatkom zadana su dva spremnika s preljevima povezana jednom cijevi. Voda se počinje prelijevati kada razina vode u vodostaju prijeđe visinu krune preljevnog praga prvog i/ili drugog spremnika. Na temelju zadanih podataka istražen je utjecaj dužine preljeva iz drugog spremnika na vodostaje i protoke u sustavu.

Zadano je:

- Površine vodospremnika u funkciji nadmorske visine
- Dotok u funkciji vremena
- Početne razine vode u vodospremnicima
- Visine preljevnih pragova

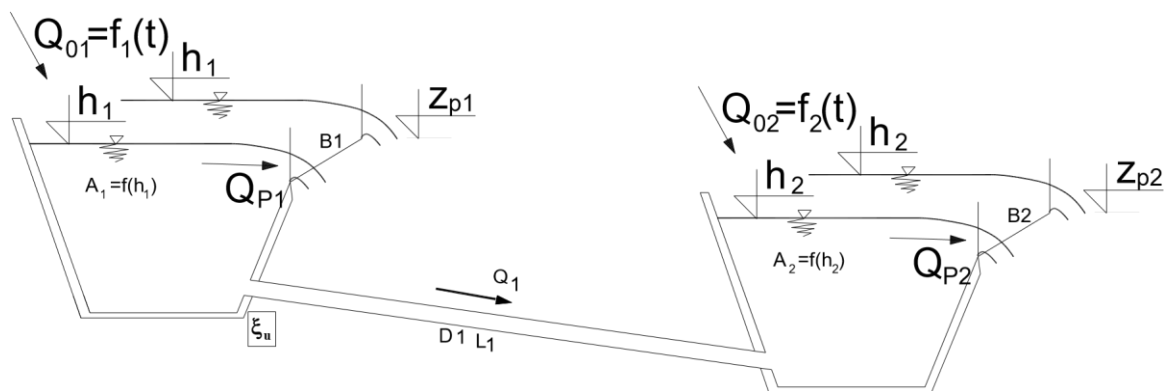

Slika 1. Dva vodospremnika s preljevima povezana sa jednom cijevi

2.2. Geometrijske i hidrauličke karakteristike

Zadani sustav sastoji se od dva otvorena spremnika s dotokom promjenjivim u vremenu, spremnici su povezani kratkom cijevi. Površina vodospremnika se mijenja u funkciji nadmorske visine. Na nadmorskoj visini $h_1=90.0$ (m n.m.) površina vodospremnika iznosi $A_1=200$ (m^2), za $h_1=100.0$ (m n.m.) površina iznosi $A_1=250$ (m^2), za $h_1=105.0$ (m n.m.) površina iznosi $A_1=270$ (m^2) i za $h_1=110.0$ (m n.m.) površina vodospremnika iznosi $A_1=300$ (m^2). Kruna preljevnog praga nalazi se na koti $Z_{p1}=100$ (m n.m.). Na nadmorskoj visini $h_2=90.0$ (m n.m.) površina vodospremnika iznosi $A_2=230$ (m^2), za $h_2=100.0$ (m n.m.) površina iznosi $A_2=280$ (m^2), za $h_2=105.0$ (m n.m.) površina iznosi $A_2=320$ (m^2) i za $h_2=110.0$ (m n.m.) površina vodospremnika iznosi $A_2=400$ (m^2). Kruna preljevnog praga nalazi se na koti $Z_{p2}=97$ (m n.m.). Za koeficijent lokalnog gubitka energije na ulazu uzeta je vrijednost $\zeta_u=0.5$. Zadatom je zadana apsolutna pogonska hidraulička hrapavost u iznosu od $\varepsilon=0.001$ (m), pomoću koje se izračunavaju linijski gubitci energije. Također je zadana vrijednosti i kinematičkog koeficijenta viskoznosti tekućine $\nu = 0.00000131$ (m/s^2).

3. Proračun

3.1. Postupak proračuna

Početna razina vode u prvom spremniku je 98.00 (m n.m.). Početna razina vode u drugom spremniku je 96.00 (m n.m.).

1. Jednadžba kontinuiteta za prvi vodospremnik:

$$A_1 \cdot \frac{dh_1}{dt} = Q_{01} - Q_1 - Q_{p1} \quad (1)$$

Nakon separacije varijabli dobije se:

$$dh_1 = \frac{Q_{01} - Q_1 - Q_{p1}}{A_1} \cdot dt \quad (2)$$

Numerička integracija mješovitim postupkom daje:

$$h_1^{k+1} = h_1^k + \frac{Q_{01}^k - Q_1^k - Q_{p1}^k}{A_1^k} \cdot (1 - \vartheta) \cdot \Delta t + \frac{Q_{01}^{k+1} - Q_1^{k+1} - Q_{p1}^{k+1}}{A_1^{k+1}} \cdot \vartheta \cdot \Delta t \quad (3)$$

2. Jednadžba kontinuiteta za drugi vodospremnik:

$$A_2 \cdot \frac{dh_2}{dt} = Q_{02} + Q_1 - Q_{p2} \quad (4)$$

Nakon separacije varijabli dobije se:

$$dh_2 = \frac{Q_{02} + Q_1 - Q_{p2}}{A_2} \cdot dt \quad (5)$$

Numerička integracija mješovitim postupkom daje:

$$h_2^{k+1} = h_2^k + \frac{Q_{02}^k + Q_1^k - Q_{p2}^k}{A_2^k} \cdot (1 - \vartheta) \cdot \Delta t + \frac{Q_{02}^{k+1} + Q_1^{k+1} - Q_{p2}^{k+1}}{A_2^{k+1}} \cdot \vartheta \cdot \Delta t \quad (6)$$

3. Preljevni protok preko prvog preljeva računati prema sljedećem:

$$\text{ako je } h_1 > z_{p1}, Q_{p1} = m \cdot B_1 \cdot \sqrt{2g} \cdot (h_1 - z_{p1})^{3/2} \quad (7)$$

$$\text{ako je } h_1 = z_{p1}, Q_{p1} = 0.00 \quad (8)$$

$$\text{ako je } h_1 < z_{p1}, Q_{p1} = 0.00 \quad (9)$$

4. Preljevni protok preko drugog preljeva računati prema sljedećem:

$$\text{ako je } h_2 > z_{p2}, Q_{p2} = m \cdot B_2 \cdot \sqrt{2g} \cdot (h_2 - z_{p2})^{3/2} \quad (10)$$

$$\text{ako je } h_2 = z_{p2}, Q_{p2} = 0.00 \quad (11)$$

$$\text{ako je } h_2 < z_{p2}, Q_{p2} = 0.00 \quad (12)$$

5. Protok kroz cijev:

ako je $h_1 > h_2$

$$Q_1 = \frac{1}{\sqrt{\xi_u + \lambda \frac{L_1}{D_1} + \alpha}} \sqrt{2g \cdot (h_1 - h_2)} \cdot D_1^2 \cdot \frac{\pi}{4} \quad (13)$$

ako je $h_1 = h_2$

$$Q_1 = 0.0 \quad (14)$$

ako je $h_1 < h_2$

$$Q_1 = \frac{1}{\sqrt{\xi_u + \lambda \frac{L_1}{D_1} + \alpha}} \sqrt{2g \cdot (h_2 - h_1)} \cdot D_1^2 \cdot \frac{\pi}{4} \quad (15)$$

Jednadžbe (3) i (6) su dvije nelinearne jednadžbe s dvije nepoznanice. Traži se h_1^{k+1} i h_2^{k+1} tj. vodostaji u oba vodospremnika na kraju vremenskog koraka.

Primijenit će se Newtonova metoda za rješavanje nelinearnih jednadžbi.

Na slici 2. dato je kratko objašnjenje Newtonove metode za rješavanje jedne nelinearne jednadžbe s jednom nepoznicom.

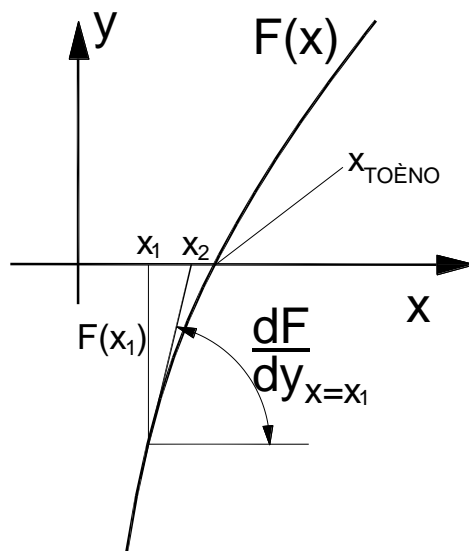

Slika 2. Objašnjenje Newtonove metode

Neka je zadana funkcija $F(x)$. Tražimo onaj x ($x_{\text{točno}}$) za kojeg vrijedi da je $F(x)=0.0$. Postupak je takav da se odabere vrijednost x_1 . Za tu vrijednost x_1 izračuna se vrijednost funkcije u toj točki $F(x_1)$ i vrijednost derivacije u toj točki. Novu vrijednost za x , tj. x_2 koja će biti bliže točnom rješenju dobit će se iz sljedećeg:

$$(x_2 - x_1) \cdot \frac{dF}{dy}_{x=x_1} = -F(x_1) \quad (16)$$

Oдавде slijedi:

$$x_2 = x_1 - \frac{F(x_1)}{\frac{dF}{dy}_{x=x_1}} \quad (17)$$

Time je određen postupak postupnog približavanja točnom rješenju.

Kod rješavanja dvije jednačbe s dvije nepoznanice zadatak se rješava prema sljedećem:

Formiraju se funkcije F1 i F2 koje ovise o varijablama x i y.

$$F1(x, y) = 0 \quad (18)$$

$$F2(x, y) = 0 \quad (19)$$

$$\frac{\delta F1}{\delta x} \cdot \Delta x + \frac{\delta F1}{\delta y} \cdot \Delta y = -F1(x, y) \quad (20)$$

$$\frac{\delta F2}{\delta x} \cdot \Delta x + \frac{\delta F2}{\delta y} \cdot \Delta y = -F2(x, y) \quad (21)$$

Prirasti Δx i Δy dobiju se rješavanjem dvije linearne jednačbe (20) i (21) s dvije nepoznanice Δx i Δy .

Poboljšanje rješenja je:

$$\begin{aligned} x^n &= x + \Delta x \\ y^n &= y + \Delta y \end{aligned}$$

U konkretnom primjeru treba formirati dvije funkcije F1 i F2 iz izraza (3) i (6).

$$F1 = h_1^{k+1} - h_1^k - \frac{Q_{01}^k - Q_1^k - Q_{p1}^k}{A_1^k} \cdot (1 - \vartheta) \cdot \Delta t - \frac{Q_{01}^{k+1} - Q_1^{k+1} - Q_{p1}^{k+1}}{A_1^{k+1}} \cdot \vartheta \cdot \Delta t = 0 \quad (22)$$

$$F2 = h_2^{k+1} - h_2^k - \frac{Q_{02}^k + Q_1^k - Q_{p2}^k}{A_2^k} \cdot (1 - \vartheta) \cdot \Delta t - \frac{Q_{02}^{k+1} + Q_1^{k+1} - Q_{p2}^{k+1}}{A_2^{k+1}} \cdot \vartheta \cdot \Delta t \quad (23)$$

Parcijalne derivacije funkcije F1 po h_1^{k+1} i h_2^{k+1} su:

$$\frac{\delta F1}{\delta h_1^{k+1}} = 1 + \frac{\vartheta \cdot \Delta t}{A_1^{k+1}} \cdot \left(\frac{\delta Q_1^{k+1}}{\delta h_1^{k+1}} + \frac{dQ_{p1}^{k+1}}{dh_1^{k+1}} \right) \quad (24)$$

ako je $h_1^{k+1} > h_2^{k+1}$

$$\frac{\delta Q_1^{k+1}}{\delta h_1^{k+1}} = \frac{1}{\sqrt{\xi_u + \lambda^{k+1} \frac{L_1}{D_1} + \alpha}} \sqrt{2g} \cdot D_1^2 \cdot \frac{\pi}{4} \cdot \frac{1}{2 \cdot \sqrt{(h_1^{k+1} - h_2^{k+1})}} \quad (25)$$

ako je $h_1^{k+1} < h_2^{k+1}$

$$\frac{\delta Q_1^{k+1}}{\delta h_1^{k+1}} = \frac{1}{\sqrt{\xi_u + \lambda^{k+1} \frac{L_1}{D_1} + \alpha}} \sqrt{2g} \cdot D_1^2 \cdot \frac{\pi}{4} \cdot \frac{-1}{2 \cdot \sqrt{(h_2^{k+1} - h_1^{k+1})}} \quad (26)$$

ako je $h_1^{k+1} > z_{p1}$,

$$\frac{dQ_{p1}^{k+1}}{dh_1^{k+1}} = m \cdot B_1 \cdot \sqrt{2g} \cdot \frac{3}{2} \cdot (h_1^{k+1} - z_{p1})^{1/2} \quad (27)$$

ako je $h_1^{k+1} = z_{p1}$,

$$\frac{dQ_{p1}^{k+1}}{dh_1^{k+1}} = 0.00 \quad (28)$$

ako je $h_1^{k+1} < z_{p1}$,

$$\frac{dQ_{p1}^{k+1}}{dh_1^{k+1}} = 0.00 \quad (29)$$

$$\frac{\delta F_1}{\delta h_2^{k+1}} = \frac{\vartheta \cdot \Delta t}{A_1^{k+1}} \cdot \left(\frac{\delta Q_1^{k+1}}{\delta h_2^{k+1}} \right) \quad (30)$$

ako je $h_1^{k+1} > h_2^{k+1}$

$$\frac{\delta Q_1^{k+1}}{\delta h_2^{k+1}} = \frac{1}{\sqrt{\xi_u + \lambda^{k+1} \frac{L_1}{D_1} + \alpha}} \sqrt{2g} \cdot D_1^2 \cdot \frac{\pi}{4} \cdot \frac{-1}{2 \cdot \sqrt{(h_1^{k+1} - h_2^{k+1})}} \quad (31)$$

ako je $h_1^{k+1} < h_2^{k+1}$

$$\frac{\delta Q_1^{k+1}}{\delta h_2^{k+1}} = \frac{1}{\sqrt{\xi_u + \lambda^{k+1} \frac{L_1}{D_1} + \alpha}} \sqrt{2g} \cdot D_1^2 \cdot \frac{\pi}{4} \cdot \frac{1}{2 \cdot \sqrt{(h_2^{k+1} - h_1^{k+1})}} \quad (32)$$

3.2. Rezultati proračuna

Rješavanjem numeričkom integracijom mješovitim postupkom dobiveni su sljedeći podaci koji prikazuju razinu vode u vodospremniku, dotok, protok kroz cijev i protok koji se prelijeva preko preljevnog praga u ovisnosti o vremenu, za različite širine preljevnog praga.

t (s)	h1 (m n.m.)	h2 (m n.m.)	Q01	Q02	Qp1	Qp2	Q1
0	98,000	96,000	2,000	1,000	0,000	0,000	1,535
5	98,010	96,0488	2,025	1,025	0,000	0,000	1,522
10	97,965	96,0976	2,050	1,050	0,000	0,000	1,485
15	97,925	96,1461	2,075	1,075	0,000	0,000	1,450
20	97,889	96,1944	2,100	1,100	0,000	0,000	1,415
25	97,858	96,2425	2,125	1,125	0,000	0,000	1,381
30	97,830	96,2903	2,150	1,150	0,000	0,000	1,348
35	97,805	96,3380	2,175	1,175	0,000	0,000	1,316
40	97,784	96,3855	2,200	1,200	0,000	0,000	1,285
45	97,765	96,4328	2,225	1,225	0,000	0,000	1,254
50	97,748	96,4800	2,250	1,250	0,000	0,000	1,224
55	97,735	96,5271	2,275	1,275	0,000	0,000	1,194
60	97,723	96,5740	2,300	1,300	0,000	0,000	1,165
65	97,713	96,6208	2,325	1,325	0,000	0,000	1,136
70	97,705	96,6675	2,350	1,350	0,000	0,000	1,107
75	97,699	96,7140	2,375	1,375	0,000	0,000	1,078
80	97,694	96,7605	2,400	1,400	0,000	0,000	1,050
85	97,690	96,8069	2,425	1,425	0,000	0,000	1,021
90	97,689	96,8531	2,450	1,450	0,000	0,000	0,993
95	97,688	96,8993	2,475	1,475	0,000	0,000	0,965
100	97,688	96,9453	2,500	1,500	0,000	0,000	0,937
105	97,690	96,9913	2,525	1,525	0,000	0,000	0,908
110	97,692	97,0369	2,550	1,550	0,000	0,025	0,880
115	97,696	97,0816	2,575	1,575	0,000	0,083	0,851
120	97,700	97,1250	2,600	1,600	0,000	0,157	0,824
125	97,705	97,1668	2,625	1,625	0,000	0,241	0,797
130	97,711	97,2069	2,650	1,650	0,000	0,334	0,771
135	97,718	97,2452	2,675	1,675	0,000	0,430	0,747
140	97,725	97,2817	2,700	1,700	0,000	0,530	0,723
145	97,732	97,3162	2,725	1,725	0,000	0,630	0,701
150	97,740	97,3490	2,750	1,750	0,000	0,731	0,680
155	97,749	97,3799	2,775	1,775	0,000	0,830	0,660
160	97,758	97,4091	2,800	1,800	0,000	0,927	0,641
165	97,767	97,4366	2,825	1,825	0,000	1,022	0,624
170	97,776	97,4625	2,850	1,850	0,000	1,115	0,608
175	97,785	97,4868	2,875	1,875	0,000	1,204	0,593
180	97,795	97,5098	2,900	1,900	0,000	1,290	0,579
185	97,804	97,5313	2,925	1,925	0,000	1,372	0,567
190	97,814	97,5516	2,950	1,950	0,000	1,452	0,556
195	97,823	97,5707	2,975	1,975	0,000	1,528	0,546
200	97,833	97,5887	3,000	2,000	0,000	1,600	0,537
205	97,845	97,6072	3,250	2,200	0,000	1,677	0,529
210	97,861	97,6278	3,500	2,400	0,000	1,763	0,525
215	97,882	97,6504	3,750	2,600	0,000	1,859	0,522
220	97,906	97,6748	4,000	2,800	0,000	1,964	0,522
225	97,933	97,7009	4,250	3,000	0,000	2,079	0,523
230	97,964	97,7285	4,500	3,200	0,000	2,203	0,526
235	97,997	97,7575	4,750	3,400	0,000	2,336	0,531
240	98,032	97,7877	5,000	3,600	0,000	2,477	0,537
245	98,069	97,8191	5,250	3,800	0,000	2,627	0,543
250	98,109	97,8514	5,500	4,000	0,000	2,784	0,551
255	98,150	97,8846	5,750	4,200	0,000	2,948	0,559
260	98,192	97,9185	6,000	4,400	0,000	3,119	0,568
265	98,235	97,9530	6,250	4,600	0,000	3,297	0,577
270	98,280	97,9881	6,500	4,800	0,000	3,480	0,586
275	98,325	98,0236	6,750	5,000	0,000	3,669	0,596
280	98,371	98,0593	7,000	5,200	0,000	3,864	0,606
285	98,417	98,0953	7,250	5,400	0,000	4,062	0,616
290	98,464	98,1315	7,500	5,600	0,000	4,265	0,626
295	98,511	98,1677	7,750	5,800	0,000	4,471	0,637
300	98,558	98,2040	8,000	6,000	0,000	4,681	0,647
305	98,603	98,2382	7,975	5,975	0,000	4,882	0,656
310	98,642	98,2686	7,950	5,950	0,000	5,063	0,664

Tablica 1. Dotok Q_{01} , Dotok Q_{02} , preljevni protok Q_{p1} , preljevni protok Q_{p2} i protok Q_1 za dužinu preljevnog praga $B_2=2$ (m) u ovisnosti o vremenu t

315	98,677	98,2955	7,925	5,925	0,000	5,225	0,671
320	98,707	98,3192	7,900	5,900	0,000	5,369	0,676
325	98,733	98,3400	7,875	5,875	0,000	5,497	0,681
330	98,756	98,3583	7,850	5,850	0,000	5,609	0,685
335	98,776	98,3742	7,825	5,825	0,000	5,708	0,688
340	98,793	98,3880	7,800	5,800	0,000	5,794	0,691
345	98,808	98,3998	7,775	5,775	0,000	5,869	0,694
350	98,820	98,4100	7,750	5,750	0,000	5,933	0,696
355	98,831	98,4187	7,725	5,725	0,000	5,988	0,697
360	98,840	98,4260	7,700	5,700	0,000	6,034	0,698
365	98,847	98,4321	7,675	5,675	0,000	6,073	0,699
370	98,853	98,4371	7,650	5,650	0,000	6,105	0,700
375	98,858	98,4412	7,625	5,625	0,000	6,131	0,701
380	98,861	98,4443	7,600	5,600	0,000	6,151	0,701
385	98,864	98,4467	7,575	5,575	0,000	6,166	0,702
390	98,866	98,4484	7,550	5,550	0,000	6,177	0,702
395	98,867	98,4494	7,525	5,525	0,000	6,184	0,702
400	98,868	98,4500	7,500	5,500	0,000	6,187	0,702
405	98,868	98,4500	7,475	5,475	0,000	6,187	0,702
410	98,868	98,4496	7,450	5,450	0,000	6,185	0,702
415	98,867	98,4488	7,425	5,425	0,000	6,179	0,702
420	98,865	98,4476	7,400	5,400	0,000	6,172	0,702
425	98,864	98,4462	7,375	5,375	0,000	6,163	0,702
430	98,862	98,4445	7,350	5,350	0,000	6,152	0,701
435	98,859	98,4425	7,325	5,325	0,000	6,139	0,701
440	98,857	98,4403	7,300	5,300	0,000	6,125	0,701
445	98,854	98,4379	7,275	5,275	0,000	6,110	0,701
450	98,851	98,4353	7,250	5,250	0,000	6,093	0,700
455	98,848	98,4326	7,225	5,225	0,000	6,076	0,700
460	98,844	98,4297	7,200	5,200	0,000	6,058	0,700
465	98,841	98,4267	7,175	5,175	0,000	6,039	0,699
470	98,837	98,4236	7,150	5,150	0,000	6,019	0,699
475	98,834	98,4204	7,125	5,125	0,000	5,999	0,698
480	98,830	98,4171	7,100	5,100	0,000	5,978	0,698
485	98,826	98,4138	7,075	5,075	0,000	5,957	0,698
490	98,822	98,4103	7,050	5,050	0,000	5,935	0,697
495	98,818	98,4068	7,025	5,025	0,000	5,913	0,697
500	98,814	98,4033	7,000	5,000	0,000	5,890	0,696
505	98,810	98,3996	6,963	4,969	0,000	5,867	0,696
510	98,805	98,3958	6,925	4,938	0,000	5,843	0,695
515	98,801	98,3918	6,888	4,906	0,000	5,818	0,694
520	98,796	98,3877	6,850	4,875	0,000	5,793	0,694
525	98,790	98,3835	6,813	4,844	0,000	5,767	0,693
530	98,785	98,3792	6,775	4,813	0,000	5,740	0,692
535	98,779	98,3748	6,738	4,781	0,000	5,712	0,691
540	98,774	98,3704	6,700	4,750	0,000	5,684	0,690
545	98,768	98,3658	6,663	4,719	0,000	5,656	0,689
550	98,762	98,3612	6,625	4,688	0,000	5,627	0,688
555	98,756	98,3565	6,588	4,656	0,000	5,598	0,686
560	98,750	98,3517	6,550	4,625	0,000	5,569	0,685
565	98,744	98,3469	6,513	4,594	0,000	5,539	0,684
570	98,737	98,3421	6,475	4,563	0,000	5,509	0,683
575	98,731	98,3372	6,438	4,531	0,000	5,479	0,682
580	98,724	98,3322	6,400	4,500	0,000	5,449	0,680
585	98,718	98,3272	6,363	4,469	0,000	5,418	0,679
590	98,711	98,3222	6,325	4,438	0,000	5,388	0,678
595	98,705	98,3172	6,288	4,406	0,000	5,357	0,676
600	98,698	98,3121	6,250	4,375	0,000	5,326	0,675
605	98,692	98,3070	6,213	4,344	0,000	5,295	0,674
610	98,685	98,3018	6,175	4,313	0,000	5,263	0,672
615	98,678	98,2967	6,138	4,281	0,000	5,232	0,671
620	98,672	98,2915	6,100	4,250	0,000	5,201	0,670

Tablica 1 (nastavak). Dotok Q_{01} , Dotok Q_{02} , preljevni protok Q_{p1} , preljevni protok Q_{p2} i protok Q_1 za dužinu preljevnog praga $B_2=2$ (m) u ovisnosti o vremenu t

625	98,665	98,2863	6,063	4,219	0,000	5,169	0,668
630	98,658	98,2810	6,025	4,188	0,000	5,138	0,667
635	98,651	98,2758	5,988	4,156	0,000	5,106	0,665
640	98,644	98,2705	5,950	4,125	0,000	5,075	0,664
645	98,637	98,2652	5,913	4,094	0,000	5,043	0,663
650	98,631	98,2599	5,875	4,063	0,000	5,011	0,661
655	98,624	98,2546	5,838	4,031	0,000	4,979	0,660
660	98,617	98,2492	5,800	4,000	0,000	4,948	0,658
665	98,610	98,2439	5,763	3,969	0,000	4,916	0,657
670	98,603	98,2385	5,725	3,938	0,000	4,884	0,656
675	98,596	98,2331	5,688	3,906	0,000	4,852	0,654
680	98,589	98,2277	5,650	3,875	0,000	4,820	0,653
685	98,582	98,2223	5,613	3,844	0,000	4,788	0,651
690	98,575	98,2168	5,575	3,813	0,000	4,756	0,650
695	98,568	98,2114	5,538	3,781	0,000	4,724	0,648
700	98,561	98,2059	5,500	3,750	0,000	4,692	0,647
705	98,553	98,2004	5,463	3,719	0,000	4,660	0,645
710	98,546	98,1949	5,425	3,688	0,000	4,629	0,644
715	98,539	98,1894	5,388	3,656	0,000	4,597	0,642
720	98,532	98,1839	5,350	3,625	0,000	4,565	0,641
725	98,525	98,1783	5,313	3,594	0,000	4,533	0,639
730	98,518	98,1728	5,275	3,563	0,000	4,501	0,638
735	98,511	98,1672	5,238	3,531	0,000	4,468	0,636
740	98,503	98,1616	5,200	3,500	0,000	4,436	0,635
745	98,496	98,1560	5,163	3,469	0,000	4,404	0,633
750	98,489	98,1504	5,125	3,438	0,000	4,372	0,632
755	98,482	98,1448	5,088	3,406	0,000	4,340	0,630
760	98,474	98,1392	5,050	3,375	0,000	4,308	0,629
765	98,467	98,1335	5,013	3,344	0,000	4,276	0,627
770	98,460	98,1278	4,975	3,313	0,000	4,244	0,626
775	98,452	98,1221	4,938	3,281	0,000	4,212	0,624
780	98,445	98,1164	4,900	3,250	0,000	4,180	0,623
785	98,438	98,1107	4,863	3,219	0,000	4,148	0,621
790	98,430	98,1050	4,825	3,188	0,000	4,116	0,620
795	98,423	98,0993	4,788	3,156	0,000	4,084	0,618
800	98,416	98,0935	4,750	3,125	0,000	4,052	0,616
805	98,408	98,0877	4,713	3,094	0,000	4,020	0,615
810	98,401	98,0819	4,675	3,063	0,000	3,988	0,613
815	98,393	98,0761	4,638	3,031	0,000	3,956	0,612
820	98,386	98,0703	4,600	3,000	0,000	3,924	0,610
825	98,378	98,0645	4,563	2,969	0,000	3,892	0,608
830	98,371	98,0586	4,525	2,938	0,000	3,860	0,607
835	98,363	98,0528	4,488	2,906	0,000	3,828	0,605
840	98,356	98,0469	4,450	2,875	0,000	3,796	0,604
845	98,348	98,0410	4,413	2,844	0,000	3,764	0,602
850	98,341	98,0351	4,375	2,813	0,000	3,732	0,600
855	98,333	98,0292	4,338	2,781	0,000	3,700	0,599
860	98,325	98,0232	4,300	2,750	0,000	3,668	0,597
865	98,318	98,0172	4,263	2,719	0,000	3,636	0,595
870	98,310	98,0113	4,225	2,688	0,000	3,604	0,594
875	98,302	98,0053	4,188	2,656	0,000	3,572	0,592
880	98,295	97,9992	4,150	2,625	0,000	3,540	0,590
885	98,287	97,9932	4,113	2,594	0,000	3,508	0,589
890	98,279	97,9872	4,075	2,563	0,000	3,476	0,587
895	98,272	97,9811	4,038	2,531	0,000	3,444	0,585
900	98,264	97,9750	4,000	2,500	0,000	3,412	0,584
905	98,256	97,9690	3,967	2,483	0,000	3,380	0,582
910	98,248	97,9633	3,933	2,467	0,000	3,350	0,580
915	98,241	97,9577	3,900	2,450	0,000	3,321	0,578
920	98,233	97,9523	3,867	2,433	0,000	3,293	0,575
925	98,226	97,9471	3,833	2,417	0,000	3,266	0,573
930	98,218	97,9420	3,800	2,400	0,000	3,240	0,571
935	98,211	97,9371	3,767	2,383	0,000	3,214	0,568
940	98,203	97,9322	3,733	2,367	0,000	3,190	0,565
945	98,196	97,9275	3,700	2,350	0,000	3,165	0,563
950	98,189	97,9228	3,667	2,333	0,000	3,141	0,560
955	98,181	97,9182	3,633	2,317	0,000	3,118	0,557
960	98,174	97,9137	3,600	2,300	0,000	3,095	0,554

Tablica 1 (nastavak). Dotok Q_{01} , Dotok Q_{02} , preljevni protok Q_{p1} , preljevni protok Q_{p2} i protok Q_1 za dužinu preljevnog praga $B_2=2$ (m) u ovisnosti o vremenu t

965	98,167	97,9093	3,567	2,283	0,000	3,072	0,551
970	98,160	97,9048	3,533	2,267	0,000	3,050	0,548
975	98,152	97,9005	3,500	2,250	0,000	3,028	0,545
980	98,145	97,8962	3,467	2,233	0,000	3,006	0,542
985	98,138	97,8919	3,433	2,217	0,000	2,985	0,539
990	98,131	97,8876	3,400	2,200	0,000	2,963	0,536
995	98,124	97,8834	3,367	2,183	0,000	2,942	0,532
1000	98,117	97,8792	3,333	2,167	0,000	2,921	0,529
1005	98,109	97,8750	3,300	2,150	0,000	2,900	0,526
1010	98,102	97,8708	3,267	2,133	0,000	2,879	0,522
1015	98,095	97,8666	3,233	2,117	0,000	2,859	0,519
1020	98,088	97,8624	3,200	2,100	0,000	2,838	0,515
1025	98,081	97,8583	3,167	2,083	0,000	2,818	0,512
1030	98,074	97,8541	3,133	2,067	0,000	2,797	0,509
1035	98,066	97,8500	3,100	2,050	0,000	2,777	0,505
1040	98,059	97,8459	3,067	2,033	0,000	2,757	0,501
1045	98,052	97,8417	3,033	2,017	0,000	2,736	0,498
1050	98,045	97,8376	3,000	2,000	0,000	2,716	0,494
1055	98,038	97,8334	2,967	1,983	0,000	2,696	0,491
1060	98,030	97,8293	2,933	1,967	0,000	2,676	0,487
1065	98,023	97,8251	2,900	1,950	0,000	2,656	0,483
1070	98,016	97,8210	2,867	1,933	0,000	2,636	0,479
1075	98,009	97,8168	2,833	1,917	0,000	2,616	0,476
1080	98,001	97,8126	2,800	1,900	0,000	2,596	0,472
1085	97,994	97,8084	2,767	1,883	0,000	2,576	0,468
1090	97,987	97,8042	2,733	1,867	0,000	2,556	0,464
1095	97,980	97,8000	2,700	1,850	0,000	2,536	0,460
1100	97,972	97,7958	2,667	1,833	0,000	2,516	0,456
1105	97,965	97,7916	2,633	1,817	0,000	2,496	0,452
1110	97,958	97,7873	2,600	1,800	0,000	2,475	0,448
1115	97,950	97,7831	2,567	1,783	0,000	2,455	0,444
1120	97,943	97,7788	2,533	1,767	0,000	2,435	0,440
1125	97,936	97,7745	2,500	1,750	0,000	2,415	0,436
1130	97,928	97,7702	2,467	1,733	0,000	2,395	0,431
1135	97,921	97,7659	2,433	1,717	0,000	2,375	0,427
1140	97,913	97,7616	2,400	1,700	0,000	2,355	0,423
1145	97,906	97,7572	2,367	1,683	0,000	2,335	0,419
1150	97,899	97,7528	2,333	1,667	0,000	2,315	0,414
1155	97,891	97,7485	2,300	1,650	0,000	2,295	0,410
1160	97,884	97,7441	2,267	1,633	0,000	2,274	0,405
1165	97,876	97,7397	2,233	1,617	0,000	2,254	0,401
1170	97,869	97,7352	2,200	1,600	0,000	2,234	0,396
1175	97,861	97,7308	2,167	1,583	0,000	2,214	0,392
1180	97,853	97,7263	2,133	1,567	0,000	2,193	0,387
1185	97,846	97,7218	2,100	1,550	0,000	2,173	0,382
1190	97,838	97,7173	2,067	1,533	0,000	2,153	0,377
1195	97,831	97,7128	2,033	1,517	0,000	2,132	0,373
1200	97,823	97,7082	2,000	1,500	0,000	2,112	0,368
1205	97,816	97,7038	2,000	1,500	0,000	2,092	0,363
1210	97,809	97,6996	2,000	1,500	0,000	2,074	0,359
1215	97,803	97,6957	2,000	1,500	0,000	2,056	0,355
1220	97,798	97,6921	2,000	1,500	0,000	2,040	0,352
1225	97,792	97,6887	2,000	1,500	0,000	2,025	0,349
1230	97,788	97,6855	2,000	1,500	0,000	2,011	0,347
1235	97,784	97,6825	2,000	1,500	0,000	1,998	0,345
1240	97,780	97,6797	2,000	1,500	0,000	1,986	0,343
1245	97,776	97,6771	2,000	1,500	0,000	1,975	0,341
1250	97,773	97,6747	2,000	1,500	0,000	1,964	0,340
1255	97,770	97,6725	2,000	1,500	0,000	1,954	0,338
1260	97,767	97,6704	2,000	1,500	0,000	1,945	0,337
1265	97,765	97,6684	2,000	1,500	0,000	1,936	0,336
1270	97,762	97,6666	2,000	1,500	0,000	1,929	0,335
1275	97,760	97,6649	2,000	1,500	0,000	1,921	0,335
1280	97,758	97,6633	2,000	1,500	0,000	1,914	0,334
1285	97,756	97,6619	2,000	1,500	0,000	1,908	0,333
1290	97,755	97,6605	2,000	1,500	0,000	1,902	0,333
1295	97,753	97,6592	2,000	1,500	0,000	1,897	0,332
1300	97,752	97,6580	2,000	1,500	0,000	1,892	0,332

Tablica 1 (nastavak). Dotok Q_{01} , Dotok Q_{02} , preljevni protok Q_{p1} , preljevni protok Q_{p2} i protok Q_1 za dužinu preljevnog praga $B_2=2$ (m) u ovisnosti o vremenu t

t (s)	h1 (m n.m.)	h2 (m n.m.)	Q01	Q02	Qp1	Qp2	Q1
0	98,000	96,000	2,000	1,000	0,000	0,000	1,535
5	98,010	96,0488	2,025	1,025	0,000	0,000	1,522
10	97,965	96,0976	2,050	1,050	0,000	0,000	1,485
15	97,925	96,1461	2,075	1,075	0,000	0,000	1,450
20	97,889	96,1944	2,100	1,100	0,000	0,000	1,415
25	97,858	96,2425	2,125	1,125	0,000	0,000	1,381
30	97,830	96,2903	2,150	1,150	0,000	0,000	1,348
35	97,805	96,3380	2,175	1,175	0,000	0,000	1,316
40	97,784	96,3855	2,200	1,200	0,000	0,000	1,285
45	97,765	96,4328	2,225	1,225	0,000	0,000	1,254
50	97,748	96,4800	2,250	1,250	0,000	0,000	1,224
55	97,735	96,5271	2,275	1,275	0,000	0,000	1,194
60	97,723	96,5740	2,300	1,300	0,000	0,000	1,165
65	97,713	96,6208	2,325	1,325	0,000	0,000	1,136
70	97,705	96,6675	2,350	1,350	0,000	0,000	1,107
75	97,699	96,7140	2,375	1,375	0,000	0,000	1,078
80	97,694	96,7605	2,400	1,400	0,000	0,000	1,050
85	97,690	96,8069	2,425	1,425	0,000	0,000	1,021
90	97,689	96,8531	2,450	1,450	0,000	0,000	0,993
95	97,688	96,8993	2,475	1,475	0,000	0,000	0,965
100	97,688	96,9453	2,500	1,500	0,000	0,000	0,937
105	97,690	96,9913	2,525	1,525	0,000	0,000	0,908
110	97,692	97,0366	2,550	1,550	0,000	0,050	0,880
115	97,696	97,0804	2,575	1,575	0,000	0,162	0,852
120	97,700	97,1217	2,600	1,600	0,000	0,301	0,826
125	97,705	97,1602	2,625	1,625	0,000	0,455	0,802
130	97,711	97,1958	2,650	1,650	0,000	0,614	0,780
135	97,717	97,2285	2,675	1,675	0,000	0,774	0,759
140	97,724	97,2582	2,700	1,700	0,000	0,930	0,741
145	97,731	97,2853	2,725	1,725	0,000	1,080	0,725
150	97,739	97,3097	2,750	1,750	0,000	1,222	0,711
155	97,747	97,3318	2,775	1,775	0,000	1,355	0,699
160	97,754	97,3518	2,800	1,800	0,000	1,479	0,689
165	97,763	97,3698	2,825	1,825	0,000	1,594	0,681
170	97,771	97,3860	2,850	1,850	0,000	1,700	0,674
175	97,779	97,4007	2,875	1,875	0,000	1,798	0,668
180	97,787	97,4140	2,900	1,900	0,000	1,888	0,664
185	97,796	97,4260	2,925	1,925	0,000	1,971	0,660
190	97,804	97,4370	2,950	1,950	0,000	2,047	0,658
195	97,812	97,4470	2,975	1,975	0,000	2,118	0,656
200	97,820	97,4562	3,000	2,000	0,000	2,184	0,655
205	97,831	97,4662	3,250	2,200	0,000	2,256	0,656
210	97,845	97,4785	3,500	2,400	0,000	2,345	0,658
215	97,864	97,4927	3,750	2,600	0,000	2,451	0,662
220	97,887	97,5086	4,000	2,800	0,000	2,571	0,668
225	97,912	97,5260	4,250	3,000	0,000	2,704	0,675
230	97,941	97,5448	4,500	3,200	0,000	2,850	0,684
235	97,973	97,5645	4,750	3,400	0,000	3,006	0,694
240	98,007	97,5852	5,000	3,600	0,000	3,173	0,705
245	98,043	97,6067	5,250	3,800	0,000	3,349	0,717
250	98,080	97,6287	5,500	4,000	0,000	3,533	0,730
255	98,120	97,6512	5,750	4,200	0,000	3,724	0,744
260	98,161	97,6741	6,000	4,400	0,000	3,922	0,758
265	98,203	97,6972	6,250	4,600	0,000	4,126	0,773
270	98,247	97,7204	6,500	4,800	0,000	4,334	0,788
275	98,291	97,7438	6,750	5,000	0,000	4,546	0,803
280	98,335	97,7671	7,000	5,200	0,000	4,762	0,819
285	98,381	97,7905	7,250	5,400	0,000	4,981	0,835
290	98,427	97,8137	7,500	5,600	0,000	5,202	0,851
295	98,473	97,8368	7,750	5,800	0,000	5,425	0,866
300	98,519	97,8598	8,000	6,000	0,000	5,650	0,882
305	98,563	97,8806	7,975	5,975	0,000	5,857	0,897
310	98,601	97,8977	7,950	5,950	0,000	6,028	0,911
315	98,635	97,9117	7,925	5,925	0,000	6,170	0,924
320	98,664	97,9231	7,900	5,900	0,000	6,286	0,935

Tablica 2 . Dotok Q_{01} , Dotok Q_{02} , preljevni protok Q_{p1} , preljevni protok Q_{p2} i protok Q_1 za dužinu preljevnog praga $B_2=4$ (m) u ovisnosti o vremenu t

325	98,690	97,9323	7,875	5,875	0,000	6,380	0,946
330	98,712	97,9396	7,850	5,850	0,000	6,455	0,955
335	98,731	97,9454	7,825	5,825	0,000	6,514	0,963
340	98,747	97,9498	7,800	5,800	0,000	6,560	0,970
345	98,761	97,9532	7,775	5,775	0,000	6,595	0,977
350	98,773	97,9556	7,750	5,750	0,000	6,621	0,982
355	98,783	97,9573	7,725	5,725	0,000	6,638	0,987
360	98,791	97,9584	7,700	5,700	0,000	6,649	0,991
365	98,797	97,9589	7,675	5,675	0,000	6,655	0,995
370	98,803	97,9589	7,650	5,650	0,000	6,655	0,998
375	98,807	97,9586	7,625	5,625	0,000	6,652	1,001
380	98,810	97,9580	7,600	5,600	0,000	6,645	1,003
385	98,813	97,9570	7,575	5,575	0,000	6,635	1,005
390	98,814	97,9559	7,550	5,550	0,000	6,623	1,007
395	98,815	97,9545	7,525	5,525	0,000	6,609	1,008
400	98,815	97,9530	7,500	5,500	0,000	6,594	1,009
405	98,815	97,9514	7,475	5,475	0,000	6,576	1,010
410	98,814	97,9496	7,450	5,450	0,000	6,558	1,010
415	98,812	97,9477	7,425	5,425	0,000	6,538	1,010
420	98,811	97,9457	7,400	5,400	0,000	6,518	1,011
425	98,809	97,9437	7,375	5,375	0,000	6,497	1,011
430	98,806	97,9416	7,350	5,350	0,000	6,475	1,011
435	98,804	97,9394	7,325	5,325	0,000	6,453	1,010
440	98,801	97,9372	7,300	5,300	0,000	6,430	1,010
445	98,798	97,9349	7,275	5,275	0,000	6,407	1,010
450	98,795	97,9326	7,250	5,250	0,000	6,383	1,009
455	98,792	97,9303	7,225	5,225	0,000	6,359	1,008
460	98,788	97,9279	7,200	5,200	0,000	6,335	1,008
465	98,785	97,9255	7,175	5,175	0,000	6,310	1,007
470	98,781	97,9231	7,150	5,150	0,000	6,286	1,006
475	98,777	97,9207	7,125	5,125	0,000	6,261	1,006
480	98,773	97,9182	7,100	5,100	0,000	6,236	1,005
485	98,769	97,9158	7,075	5,075	0,000	6,211	1,004
490	98,765	97,9133	7,050	5,050	0,000	6,186	1,003
495	98,761	97,9108	7,025	5,025	0,000	6,160	1,002
500	98,757	97,9083	7,000	5,000	0,000	6,135	1,001
505	98,753	97,9057	6,963	4,969	0,000	6,109	1,000
510	98,748	97,9031	6,925	4,938	0,000	6,082	0,999
515	98,744	97,9003	6,888	4,906	0,000	6,054	0,998
520	98,739	97,8975	6,850	4,875	0,000	6,026	0,996
525	98,733	97,8946	6,813	4,844	0,000	5,996	0,995
530	98,728	97,8916	6,775	4,813	0,000	5,966	0,994
535	98,722	97,8886	6,738	4,781	0,000	5,936	0,992
540	98,717	97,8855	6,700	4,750	0,000	5,905	0,991
545	98,711	97,8824	6,663	4,719	0,000	5,874	0,989
550	98,705	97,8793	6,625	4,688	0,000	5,843	0,987
555	98,699	97,8761	6,588	4,656	0,000	5,812	0,986
560	98,693	97,8729	6,550	4,625	0,000	5,780	0,984
565	98,686	97,8697	6,513	4,594	0,000	5,748	0,982
570	98,680	97,8665	6,475	4,563	0,000	5,716	0,980
575	98,674	97,8632	6,438	4,531	0,000	5,684	0,978
580	98,667	97,8600	6,400	4,500	0,000	5,652	0,976
585	98,661	97,8567	6,363	4,469	0,000	5,619	0,974
590	98,654	97,8534	6,325	4,438	0,000	5,587	0,972
595	98,648	97,8500	6,288	4,406	0,000	5,554	0,970
600	98,641	97,8467	6,250	4,375	0,000	5,522	0,968
605	98,635	97,8434	6,213	4,344	0,000	5,489	0,966
610	98,628	97,8400	6,175	4,313	0,000	5,456	0,964
615	98,621	97,8367	6,138	4,281	0,000	5,424	0,962
620	98,615	97,8333	6,100	4,250	0,000	5,391	0,960
625	98,608	97,8299	6,063	4,219	0,000	5,358	0,958
630	98,601	97,8265	6,025	4,188	0,000	5,325	0,956
635	98,594	97,8231	5,988	4,156	0,000	5,293	0,954
640	98,587	97,8197	5,950	4,125	0,000	5,260	0,952

Tablica 2 (nastavak). Dotok Q_{01} , Dotok Q_{02} , preljevni protok Q_{p1} , preljevni protok Q_{p2} i protok Q_1 za dužinu preljevnog praga $B_2=4$ (m) u ovisnosti o vremenu t

645	98,580	97,8163	5,913	4,094	0,000	5,227	0,950
650	98,574	97,8129	5,875	4,063	0,000	5,194	0,948
655	98,567	97,8094	5,838	4,031	0,000	5,161	0,945
660	98,560	97,8060	5,800	4,000	0,000	5,128	0,943
665	98,553	97,8025	5,763	3,969	0,000	5,095	0,941
670	98,546	97,7990	5,725	3,938	0,000	5,062	0,939
675	98,539	97,7956	5,688	3,906	0,000	5,029	0,937
680	98,532	97,7921	5,650	3,875	0,000	4,996	0,935
685	98,525	97,7886	5,613	3,844	0,000	4,963	0,932
690	98,518	97,7851	5,575	3,813	0,000	4,930	0,930
695	98,511	97,7816	5,538	3,781	0,000	4,897	0,928
700	98,504	97,7781	5,500	3,750	0,000	4,864	0,926
705	98,497	97,7745	5,463	3,719	0,000	4,831	0,923
710	98,490	97,7710	5,425	3,688	0,000	4,798	0,921
715	98,483	97,7674	5,388	3,656	0,000	4,765	0,919
720	98,475	97,7639	5,350	3,625	0,000	4,732	0,916
725	98,468	97,7603	5,313	3,594	0,000	4,699	0,914
730	98,461	97,7568	5,275	3,563	0,000	4,666	0,912
735	98,454	97,7532	5,238	3,531	0,000	4,632	0,910
740	98,447	97,7496	5,200	3,500	0,000	4,599	0,907
745	98,440	97,7460	5,163	3,469	0,000	4,566	0,905
750	98,432	97,7424	5,125	3,438	0,000	4,533	0,903
755	98,425	97,7387	5,088	3,406	0,000	4,500	0,900
760	98,418	97,7351	5,050	3,375	0,000	4,467	0,898
765	98,411	97,7315	5,013	3,344	0,000	4,434	0,895
770	98,403	97,7278	4,975	3,313	0,000	4,401	0,893
775	98,396	97,7242	4,938	3,281	0,000	4,367	0,891
780	98,389	97,7205	4,900	3,250	0,000	4,334	0,888
785	98,382	97,7168	4,863	3,219	0,000	4,301	0,886
790	98,374	97,7131	4,825	3,188	0,000	4,268	0,883
795	98,367	97,7094	4,788	3,156	0,000	4,235	0,881
800	98,359	97,7057	4,750	3,125	0,000	4,202	0,878
805	98,352	97,7020	4,713	3,094	0,000	4,169	0,876
810	98,345	97,6983	4,675	3,063	0,000	4,135	0,873
815	98,337	97,6945	4,638	3,031	0,000	4,102	0,871
820	98,330	97,6908	4,600	3,000	0,000	4,069	0,868
825	98,322	97,6870	4,563	2,969	0,000	4,036	0,866
830	98,315	97,6833	4,525	2,938	0,000	4,003	0,863
835	98,307	97,6795	4,488	2,906	0,000	3,969	0,861
840	98,300	97,6757	4,450	2,875	0,000	3,936	0,858
845	98,292	97,6719	4,413	2,844	0,000	3,903	0,856
850	98,285	97,6681	4,375	2,813	0,000	3,870	0,853
855	98,277	97,6642	4,338	2,781	0,000	3,837	0,851
860	98,270	97,6604	4,300	2,750	0,000	3,803	0,848
865	98,262	97,6565	4,263	2,719	0,000	3,770	0,845
870	98,255	97,6527	4,225	2,688	0,000	3,737	0,843
875	98,247	97,6488	4,188	2,656	0,000	3,704	0,840
880	98,239	97,6449	4,150	2,625	0,000	3,670	0,838
885	98,232	97,6410	4,113	2,594	0,000	3,637	0,835
890	98,224	97,6371	4,075	2,563	0,000	3,604	0,832
895	98,216	97,6332	4,038	2,531	0,000	3,571	0,830
900	98,208	97,6292	4,000	2,500	0,000	3,537	0,827
905	98,201	97,6254	3,967	2,483	0,000	3,505	0,824
910	98,193	97,6218	3,933	2,467	0,000	3,475	0,821
915	98,186	97,6184	3,900	2,450	0,000	3,446	0,818
920	98,178	97,6151	3,867	2,433	0,000	3,419	0,815
925	98,171	97,6119	3,833	2,417	0,000	3,393	0,812
930	98,163	97,6089	3,800	2,400	0,000	3,367	0,809
935	98,156	97,6060	3,767	2,383	0,000	3,343	0,805
940	98,148	97,6031	3,733	2,367	0,000	3,319	0,802
945	98,141	97,6003	3,700	2,350	0,000	3,296	0,799
950	98,134	97,5976	3,667	2,333	0,000	3,274	0,795
955	98,126	97,5948	3,633	2,317	0,000	3,251	0,792
960	98,119	97,5922	3,600	2,300	0,000	3,230	0,789

Tablica 2 (nastavak). Dotok Q_{01} , Dotok Q_{02} , preljevni protok Q_{p1} , preljevni protok Q_{p2} i protok Q_1 za dužinu preljevnog praga $B_2=4$ (m) u ovisnosti o vremenu t

965	98,112	97,5895	3,567	2,283	0,000	3,208	0,785
970	98,105	97,5869	3,533	2,267	0,000	3,187	0,782
975	98,097	97,5843	3,500	2,250	0,000	3,166	0,778
980	98,090	97,5817	3,467	2,233	0,000	3,145	0,775
985	98,083	97,5792	3,433	2,217	0,000	3,124	0,771
990	98,076	97,5766	3,400	2,200	0,000	3,103	0,767
995	98,069	97,5741	3,367	2,183	0,000	3,083	0,764
1000	98,061	97,5715	3,333	2,167	0,000	3,062	0,760
1005	98,054	97,5690	3,300	2,150	0,000	3,042	0,757
1010	98,047	97,5664	3,267	2,133	0,000	3,021	0,753
1015	98,040	97,5639	3,233	2,117	0,000	3,001	0,749
1020	98,033	97,5614	3,200	2,100	0,000	2,981	0,746
1025	98,025	97,5588	3,167	2,083	0,000	2,960	0,742
1030	98,018	97,5563	3,133	2,067	0,000	2,940	0,738
1035	98,011	97,5537	3,100	2,050	0,000	2,920	0,734
1040	98,004	97,5511	3,067	2,033	0,000	2,900	0,731
1045	97,996	97,5486	3,033	2,017	0,000	2,880	0,727
1050	97,989	97,5460	3,000	2,000	0,000	2,859	0,723
1055	97,982	97,5434	2,967	1,983	0,000	2,839	0,719
1060	97,974	97,5409	2,933	1,967	0,000	2,819	0,715
1065	97,967	97,5383	2,900	1,950	0,000	2,799	0,711
1070	97,960	97,5357	2,867	1,933	0,000	2,779	0,707
1075	97,952	97,5331	2,833	1,917	0,000	2,758	0,703
1080	97,945	97,5305	2,800	1,900	0,000	2,738	0,699
1085	97,938	97,5278	2,767	1,883	0,000	2,718	0,695
1090	97,930	97,5252	2,733	1,867	0,000	2,698	0,691
1095	97,923	97,5226	2,700	1,850	0,000	2,677	0,687
1100	97,915	97,5199	2,667	1,833	0,000	2,657	0,683
1105	97,908	97,5173	2,633	1,817	0,000	2,637	0,679
1110	97,900	97,5146	2,600	1,800	0,000	2,616	0,675
1115	97,893	97,5119	2,567	1,783	0,000	2,596	0,670
1120	97,885	97,5093	2,533	1,767	0,000	2,576	0,666
1125	97,878	97,5066	2,500	1,750	0,000	2,555	0,662
1130	97,870	97,5039	2,467	1,733	0,000	2,535	0,658
1135	97,863	97,5011	2,433	1,717	0,000	2,514	0,653
1140	97,855	97,4984	2,400	1,700	0,000	2,494	0,649
1145	97,848	97,4957	2,367	1,683	0,000	2,473	0,644
1150	97,840	97,4929	2,333	1,667	0,000	2,453	0,640
1155	97,832	97,4902	2,300	1,650	0,000	2,432	0,635
1160	97,825	97,4874	2,267	1,633	0,000	2,411	0,631
1165	97,817	97,4846	2,233	1,617	0,000	2,391	0,626
1170	97,809	97,4818	2,200	1,600	0,000	2,370	0,621
1175	97,802	97,4790	2,167	1,583	0,000	2,350	0,617
1180	97,794	97,4762	2,133	1,567	0,000	2,329	0,612
1185	97,786	97,4733	2,100	1,550	0,000	2,308	0,607
1190	97,778	97,4705	2,067	1,533	0,000	2,287	0,602
1195	97,770	97,4676	2,033	1,517	0,000	2,266	0,598
1200	97,763	97,4648	2,000	1,500	0,000	2,246	0,593
1205	97,755	97,4620	2,000	1,500	0,000	2,226	0,588
1210	97,748	97,4595	2,000	1,500	0,000	2,208	0,583
1215	97,742	97,4573	2,000	1,500	0,000	2,192	0,579
1220	97,736	97,4553	2,000	1,500	0,000	2,177	0,576
1225	97,731	97,4535	2,000	1,500	0,000	2,164	0,572
1230	97,726	97,4518	2,000	1,500	0,000	2,152	0,569
1235	97,722	97,4503	2,000	1,500	0,000	2,141	0,566
1240	97,718	97,4489	2,000	1,500	0,000	2,132	0,563
1245	97,714	97,4477	2,000	1,500	0,000	2,123	0,560
1250	97,711	97,4465	2,000	1,500	0,000	2,115	0,558
1255	97,707	97,4455	2,000	1,500	0,000	2,107	0,556
1260	97,705	97,4445	2,000	1,500	0,000	2,101	0,554
1265	97,702	97,4437	2,000	1,500	0,000	2,095	0,552
1270	97,700	97,4429	2,000	1,500	0,000	2,089	0,550
1275	97,698	97,4422	2,000	1,500	0,000	2,084	0,549
1280	97,696	97,4415	2,000	1,500	0,000	2,079	0,547
1285	97,694	97,4409	2,000	1,500	0,000	2,075	0,546
1290	97,692	97,4404	2,000	1,500	0,000	2,071	0,545
1295	97,691	97,4399	2,000	1,500	0,000	2,068	0,544
1300	97,689	97,4394	2,000	1,500	0,000	2,065	0,543

Tablica 2 (nastavak). Dotok Q_{01} , Dotok Q_{02} , preljevni protok Q_{p1} , preljevni protok Q_{p2} i protok Q_1 za dužinu preljevnog praga $B_2=4$ (m) u ovisnosti o vremenu t

t (s)	h1 (m n.m.)	h2 (m n.m.)	Q01	Q02	Qp1	Qp2	Q1
0	98,000	96,000	2,000	1,000	0,000	0,000	1,535
5	98,010	96,0488	2,025	1,025	0,000	0,000	1,522
10	97,965	96,0976	2,050	1,050	0,000	0,000	1,485
15	97,925	96,1461	2,075	1,075	0,000	0,000	1,450
20	97,889	96,1944	2,100	1,100	0,000	0,000	1,415
25	97,858	96,2425	2,125	1,125	0,000	0,000	1,381
30	97,830	96,2903	2,150	1,150	0,000	0,000	1,348
35	97,805	96,3380	2,175	1,175	0,000	0,000	1,316
40	97,784	96,3855	2,200	1,200	0,000	0,000	1,285
45	97,765	96,4328	2,225	1,225	0,000	0,000	1,254
50	97,748	96,4800	2,250	1,250	0,000	0,000	1,224
55	97,735	96,5271	2,275	1,275	0,000	0,000	1,194
60	97,723	96,5740	2,300	1,300	0,000	0,000	1,165
65	97,713	96,6208	2,325	1,325	0,000	0,000	1,136
70	97,705	96,6675	2,350	1,350	0,000	0,000	1,107
75	97,699	96,7140	2,375	1,375	0,000	0,000	1,078
80	97,694	96,7605	2,400	1,400	0,000	0,000	1,050
85	97,690	96,8069	2,425	1,425	0,000	0,000	1,021
90	97,689	96,8531	2,450	1,450	0,000	0,000	0,993
95	97,688	96,8993	2,475	1,475	0,000	0,000	0,965
100	97,688	96,9453	2,500	1,500	0,000	0,000	0,937
105	97,690	96,9913	2,525	1,525	0,000	0,000	0,908
110	97,692	97,0364	2,550	1,550	0,000	0,074	0,880
115	97,696	97,0792	2,575	1,575	0,000	0,237	0,853
120	97,700	97,1186	2,600	1,600	0,000	0,434	0,828
125	97,705	97,1542	2,625	1,625	0,000	0,644	0,806
130	97,711	97,1859	2,650	1,650	0,000	0,852	0,787
135	97,717	97,2139	2,675	1,675	0,000	1,051	0,770
140	97,723	97,2384	2,700	1,700	0,000	1,237	0,757
145	97,730	97,2598	2,725	1,725	0,000	1,408	0,745
150	97,737	97,2784	2,750	1,750	0,000	1,562	0,736
155	97,745	97,2946	2,775	1,775	0,000	1,700	0,729
160	97,752	97,3087	2,800	1,800	0,000	1,823	0,723
165	97,760	97,3210	2,825	1,825	0,000	1,933	0,719
170	97,767	97,3317	2,850	1,850	0,000	2,031	0,717
175	97,775	97,3411	2,875	1,875	0,000	2,118	0,715
180	97,782	97,3495	2,900	1,900	0,000	2,196	0,715
185	97,790	97,3569	2,925	1,925	0,000	2,266	0,715
190	97,797	97,3635	2,950	1,950	0,000	2,330	0,715
195	97,805	97,3695	2,975	1,975	0,000	2,387	0,717
200	97,812	97,3749	3,000	2,000	0,000	2,440	0,718
205	97,822	97,3814	3,250	2,200	0,000	2,504	0,721
210	97,836	97,3903	3,500	2,400	0,000	2,592	0,725
215	97,854	97,4011	3,750	2,600	0,000	2,701	0,731
220	97,876	97,4137	4,000	2,800	0,000	2,828	0,738
225	97,901	97,4275	4,250	3,000	0,000	2,972	0,747
230	97,929	97,4425	4,500	3,200	0,000	3,129	0,758
235	97,960	97,4584	4,750	3,400	0,000	3,299	0,769
240	97,993	97,4749	5,000	3,600	0,000	3,480	0,782
245	98,029	97,4920	5,250	3,800	0,000	3,669	0,796
250	98,066	97,5095	5,500	4,000	0,000	3,866	0,811
255	98,105	97,5272	5,750	4,200	0,000	4,070	0,826
260	98,146	97,5451	6,000	4,400	0,000	4,279	0,842
265	98,188	97,5631	6,250	4,600	0,000	4,492	0,859
270	98,231	97,5811	6,500	4,800	0,000	4,710	0,876
275	98,274	97,5991	6,750	5,000	0,000	4,930	0,893
280	98,319	97,6170	7,000	5,200	0,000	5,152	0,910
285	98,364	97,6348	7,250	5,400	0,000	5,377	0,928
290	98,410	97,6524	7,500	5,600	0,000	5,602	0,945
295	98,455	97,6699	7,750	5,800	0,000	5,829	0,963
300	98,502	97,6872	8,000	6,000	0,000	6,056	0,981
305	98,545	97,7024	7,975	5,975	0,000	6,258	0,997
310	98,583	97,7141	7,950	5,950	0,000	6,416	1,013
315	98,617	97,7231	7,925	5,925	0,000	6,537	1,027
320	98,646	97,7298	7,900	5,900	0,000	6,628	1,040

Tablica 3. Dotok Q_{01} , Dotok Q_{02} , preljevni protok Q_{p1} , preljevni protok Q_{p2} i protok Q_1 za dužinu preljevnog praga $B_2=6$ (m) u ovisnosti o vremenu t

325	98,671	97,7348	7,875	5,875	0,000	6,697	1,051
330	98,693	97,7385	7,850	5,850	0,000	6,747	1,062
335	98,712	97,7411	7,825	5,825	0,000	6,782	1,071
340	98,728	97,7428	7,800	5,800	0,000	6,805	1,078
345	98,742	97,7438	7,775	5,775	0,000	6,820	1,085
350	98,753	97,7443	7,750	5,750	0,000	6,826	1,091
355	98,763	97,7444	7,725	5,725	0,000	6,827	1,097
360	98,771	97,7441	7,700	5,700	0,000	6,823	1,101
365	98,778	97,7435	7,675	5,675	0,000	6,816	1,105
370	98,783	97,7427	7,650	5,650	0,000	6,805	1,108
375	98,787	97,7418	7,625	5,625	0,000	6,792	1,111
380	98,790	97,7406	7,600	5,600	0,000	6,776	1,113
385	98,792	97,7394	7,575	5,575	0,000	6,759	1,115
390	98,794	97,7381	7,550	5,550	0,000	6,740	1,117
395	98,795	97,7366	7,525	5,525	0,000	6,721	1,118
400	98,795	97,7351	7,500	5,500	0,000	6,700	1,119
405	98,794	97,7335	7,475	5,475	0,000	6,679	1,119
410	98,793	97,7319	7,450	5,450	0,000	6,657	1,120
415	98,792	97,7303	7,425	5,425	0,000	6,634	1,120
420	98,790	97,7286	7,400	5,400	0,000	6,611	1,120
425	98,788	97,7268	7,375	5,375	0,000	6,587	1,120
430	98,786	97,7251	7,350	5,350	0,000	6,563	1,119
435	98,784	97,7233	7,325	5,325	0,000	6,539	1,119
440	98,781	97,7215	7,300	5,300	0,000	6,515	1,118
445	98,778	97,7197	7,275	5,275	0,000	6,490	1,118
450	98,775	97,7178	7,250	5,250	0,000	6,465	1,117
455	98,771	97,7160	7,225	5,225	0,000	6,440	1,116
460	98,768	97,7141	7,200	5,200	0,000	6,415	1,116
465	98,764	97,7122	7,175	5,175	0,000	6,390	1,115
470	98,761	97,7103	7,150	5,150	0,000	6,364	1,114
475	98,757	97,7084	7,125	5,125	0,000	6,339	1,113
480	98,753	97,7065	7,100	5,100	0,000	6,313	1,112
485	98,749	97,7046	7,075	5,075	0,000	6,288	1,111
490	98,745	97,7027	7,050	5,050	0,000	6,262	1,110
495	98,741	97,7008	7,025	5,025	0,000	6,236	1,108
500	98,737	97,6988	7,000	5,000	0,000	6,210	1,107
505	98,733	97,6968	6,963	4,969	0,000	6,184	1,106
510	98,728	97,6947	6,925	4,938	0,000	6,156	1,105
515	98,723	97,6926	6,888	4,906	0,000	6,127	1,103
520	98,718	97,6903	6,850	4,875	0,000	6,097	1,102
525	98,713	97,6880	6,813	4,844	0,000	6,067	1,100
530	98,708	97,6857	6,775	4,813	0,000	6,036	1,099
535	98,702	97,6833	6,738	4,781	0,000	6,005	1,097
540	98,696	97,6809	6,700	4,750	0,000	5,973	1,095
545	98,691	97,6785	6,663	4,719	0,000	5,941	1,093
550	98,685	97,6761	6,625	4,688	0,000	5,909	1,091
555	98,679	97,6736	6,588	4,656	0,000	5,877	1,089
560	98,673	97,6711	6,550	4,625	0,000	5,845	1,087
565	98,666	97,6686	6,513	4,594	0,000	5,812	1,085
570	98,660	97,6661	6,475	4,563	0,000	5,779	1,083
575	98,654	97,6636	6,438	4,531	0,000	5,747	1,081
580	98,647	97,6611	6,400	4,500	0,000	5,714	1,079
585	98,641	97,6585	6,363	4,469	0,000	5,681	1,077
590	98,634	97,6560	6,325	4,438	0,000	5,648	1,075
595	98,628	97,6534	6,288	4,406	0,000	5,615	1,073
600	98,621	97,6509	6,250	4,375	0,000	5,582	1,070
605	98,615	97,6483	6,213	4,344	0,000	5,549	1,068
610	98,608	97,6457	6,175	4,313	0,000	5,516	1,066
615	98,601	97,6431	6,138	4,281	0,000	5,483	1,064
620	98,594	97,6405	6,100	4,250	0,000	5,450	1,061
625	98,588	97,6379	6,063	4,219	0,000	5,416	1,059
630	98,581	97,6353	6,025	4,188	0,000	5,383	1,057
635	98,574	97,6327	5,988	4,156	0,000	5,350	1,054
640	98,567	97,6301	5,950	4,125	0,000	5,317	1,052

Tablica 3 (nastavak). Dotok Q_{01} , Dotok Q_{02} , preljevni protok Q_{p1} , preljevni protok Q_{p2} i protok Q_l za dužinu preljevnog praga $B_2=6$ (m) u ovisnosti o vremenu t

645	98,560	97,6274	5,913	4,094	0,000	5,283	1,050
650	98,554	97,6248	5,875	4,063	0,000	5,250	1,047
655	98,547	97,6222	5,838	4,031	0,000	5,217	1,045
660	98,540	97,6195	5,800	4,000	0,000	5,184	1,042
665	98,533	97,6168	5,763	3,969	0,000	5,150	1,040
670	98,526	97,6142	5,725	3,938	0,000	5,117	1,038
675	98,519	97,6115	5,688	3,906	0,000	5,084	1,035
680	98,512	97,6088	5,650	3,875	0,000	5,050	1,033
685	98,505	97,6061	5,613	3,844	0,000	5,017	1,030
690	98,498	97,6035	5,575	3,813	0,000	4,983	1,028
695	98,491	97,6008	5,538	3,781	0,000	4,950	1,025
700	98,484	97,5981	5,500	3,750	0,000	4,917	1,023
705	98,477	97,5953	5,463	3,719	0,000	4,883	1,020
710	98,470	97,5926	5,425	3,688	0,000	4,850	1,018
715	98,463	97,5899	5,388	3,656	0,000	4,816	1,015
720	98,456	97,5872	5,350	3,625	0,000	4,783	1,013
725	98,448	97,5844	5,313	3,594	0,000	4,750	1,010
730	98,441	97,5817	5,275	3,563	0,000	4,716	1,007
735	98,434	97,5789	5,238	3,531	0,000	4,683	1,005
740	98,427	97,5762	5,200	3,500	0,000	4,649	1,002
745	98,420	97,5734	5,163	3,469	0,000	4,616	1,000
750	98,413	97,5706	5,125	3,438	0,000	4,582	0,997
755	98,405	97,5678	5,088	3,406	0,000	4,549	0,994
760	98,398	97,5650	5,050	3,375	0,000	4,515	0,992
765	98,391	97,5622	5,013	3,344	0,000	4,482	0,989
770	98,384	97,5594	4,975	3,313	0,000	4,448	0,986
775	98,376	97,5566	4,938	3,281	0,000	4,415	0,984
780	98,369	97,5538	4,900	3,250	0,000	4,381	0,981
785	98,362	97,5510	4,863	3,219	0,000	4,348	0,978
790	98,354	97,5481	4,825	3,188	0,000	4,314	0,976
795	98,347	97,5453	4,788	3,156	0,000	4,281	0,973
800	98,340	97,5424	4,750	3,125	0,000	4,247	0,970
805	98,332	97,5396	4,713	3,094	0,000	4,213	0,967
810	98,325	97,5367	4,675	3,063	0,000	4,180	0,965
815	98,317	97,5338	4,638	3,031	0,000	4,146	0,962
820	98,310	97,5309	4,600	3,000	0,000	4,113	0,959
825	98,303	97,5280	4,563	2,969	0,000	4,079	0,956
830	98,295	97,5251	4,525	2,938	0,000	4,045	0,953
835	98,288	97,5222	4,488	2,906	0,000	4,012	0,951
840	98,280	97,5193	4,450	2,875	0,000	3,978	0,948
845	98,273	97,5164	4,413	2,844	0,000	3,945	0,945
850	98,265	97,5134	4,375	2,813	0,000	3,911	0,942
855	98,258	97,5105	4,338	2,781	0,000	3,877	0,939
860	98,250	97,5075	4,300	2,750	0,000	3,844	0,936
865	98,242	97,5045	4,263	2,719	0,000	3,810	0,933
870	98,235	97,5016	4,225	2,688	0,000	3,776	0,930
875	98,227	97,4986	4,188	2,656	0,000	3,743	0,927
880	98,219	97,4956	4,150	2,625	0,000	3,709	0,924
885	98,212	97,4926	4,113	2,594	0,000	3,675	0,921
890	98,204	97,4896	4,075	2,563	0,000	3,641	0,918
895	98,196	97,4865	4,038	2,531	0,000	3,608	0,915
900	98,189	97,4835	4,000	2,500	0,000	3,574	0,912
905	98,181	97,4806	3,967	2,483	0,000	3,542	0,909
910	98,173	97,4779	3,933	2,467	0,000	3,512	0,906
915	98,166	97,4753	3,900	2,450	0,000	3,484	0,903
920	98,158	97,4729	3,867	2,433	0,000	3,457	0,899
925	98,151	97,4706	3,833	2,417	0,000	3,432	0,896
930	98,143	97,4684	3,800	2,400	0,000	3,408	0,893
935	98,136	97,4662	3,767	2,383	0,000	3,384	0,889
940	98,129	97,4642	3,733	2,367	0,000	3,362	0,886
945	98,121	97,4621	3,700	2,350	0,000	3,339	0,882
950	98,114	97,4601	3,667	2,333	0,000	3,318	0,879
955	98,107	97,4581	3,633	2,317	0,000	3,296	0,875
960	98,100	97,4561	3,600	2,300	0,000	3,275	0,871

Tablica 3 (nastavak). Dotok Q_{01} , Dotok Q_{02} , preljevni protok Q_{p1} , preljevni protok Q_{p2} i protok Q_1 za dužinu preljevnog praga $B_2=6$ (m) u ovisnosti o vremenu t

965	98,092	97,4542	3,567	2,283	0,000	3,254	0,868
970	98,085	97,4522	3,533	2,267	0,000	3,233	0,864
975	98,078	97,4503	3,500	2,250	0,000	3,212	0,861
980	98,071	97,4484	3,467	2,233	0,000	3,192	0,857
985	98,063	97,4465	3,433	2,217	0,000	3,171	0,853
990	98,056	97,4445	3,400	2,200	0,000	3,151	0,850
995	98,049	97,4426	3,367	2,183	0,000	3,131	0,846
1000	98,042	97,4407	3,333	2,167	0,000	3,110	0,842
1005	98,034	97,4388	3,300	2,150	0,000	3,090	0,838
1010	98,027	97,4369	3,267	2,133	0,000	3,070	0,835
1015	98,020	97,4349	3,233	2,117	0,000	3,049	0,831
1020	98,013	97,4330	3,200	2,100	0,000	3,029	0,827
1025	98,005	97,4311	3,167	2,083	0,000	3,009	0,823
1030	97,998	97,4291	3,133	2,067	0,000	2,989	0,819
1035	97,991	97,4272	3,100	2,050	0,000	2,968	0,816
1040	97,984	97,4253	3,067	2,033	0,000	2,948	0,812
1045	97,976	97,4233	3,033	2,017	0,000	2,928	0,808
1050	97,969	97,4213	3,000	2,000	0,000	2,907	0,804
1055	97,962	97,4194	2,967	1,983	0,000	2,887	0,800
1060	97,954	97,4174	2,933	1,967	0,000	2,867	0,796
1065	97,947	97,4154	2,900	1,950	0,000	2,846	0,792
1070	97,939	97,4134	2,867	1,933	0,000	2,826	0,788
1075	97,932	97,4115	2,833	1,917	0,000	2,806	0,784
1080	97,925	97,4095	2,800	1,900	0,000	2,785	0,780
1085	97,917	97,4075	2,767	1,883	0,000	2,765	0,776
1090	97,910	97,4054	2,733	1,867	0,000	2,744	0,771
1095	97,902	97,4034	2,700	1,850	0,000	2,724	0,767
1100	97,895	97,4014	2,667	1,833	0,000	2,704	0,763
1105	97,887	97,3994	2,633	1,817	0,000	2,683	0,759
1110	97,880	97,3973	2,600	1,800	0,000	2,663	0,755
1115	97,872	97,3953	2,567	1,783	0,000	2,642	0,750
1120	97,865	97,3932	2,533	1,767	0,000	2,621	0,746
1125	97,857	97,3912	2,500	1,750	0,000	2,601	0,741
1130	97,850	97,3891	2,467	1,733	0,000	2,580	0,737
1135	97,842	97,3870	2,433	1,717	0,000	2,559	0,733
1140	97,834	97,3849	2,400	1,700	0,000	2,539	0,728
1145	97,827	97,3828	2,367	1,683	0,000	2,518	0,724
1150	97,819	97,3807	2,333	1,667	0,000	2,497	0,719
1155	97,811	97,3786	2,300	1,650	0,000	2,476	0,714
1160	97,804	97,3765	2,267	1,633	0,000	2,456	0,710
1165	97,796	97,3743	2,233	1,617	0,000	2,435	0,705
1170	97,788	97,3722	2,200	1,600	0,000	2,414	0,700
1175	97,780	97,3700	2,167	1,583	0,000	2,393	0,696
1180	97,772	97,3679	2,133	1,567	0,000	2,372	0,691
1185	97,765	97,3657	2,100	1,550	0,000	2,351	0,686
1190	97,757	97,3635	2,067	1,533	0,000	2,330	0,681
1195	97,749	97,3613	2,033	1,517	0,000	2,309	0,676
1200	97,741	97,3591	2,000	1,500	0,000	2,288	0,671
1205	97,733	97,3571	2,000	1,500	0,000	2,268	0,666
1210	97,726	97,3552	2,000	1,500	0,000	2,251	0,662
1215	97,720	97,3536	2,000	1,500	0,000	2,236	0,657
1220	97,714	97,3522	2,000	1,500	0,000	2,222	0,653
1225	97,709	97,3510	2,000	1,500	0,000	2,211	0,650
1230	97,704	97,3499	2,000	1,500	0,000	2,200	0,646
1235	97,699	97,3489	2,000	1,500	0,000	2,191	0,643
1240	97,695	97,3481	2,000	1,500	0,000	2,183	0,640
1245	97,692	97,3473	2,000	1,500	0,000	2,176	0,637
1250	97,688	97,3466	2,000	1,500	0,000	2,169	0,635
1255	97,685	97,3459	2,000	1,500	0,000	2,163	0,632
1260	97,682	97,3454	2,000	1,500	0,000	2,158	0,630
1265	97,680	97,3449	2,000	1,500	0,000	2,153	0,628
1270	97,677	97,3444	2,000	1,500	0,000	2,149	0,626
1275	97,675	97,3440	2,000	1,500	0,000	2,145	0,625
1280	97,673	97,3436	2,000	1,500	0,000	2,141	0,623
1285	97,671	97,3433	2,000	1,500	0,000	2,138	0,622
1290	97,669	97,3430	2,000	1,500	0,000	2,135	0,620
1295	97,668	97,3427	2,000	1,500	0,000	2,132	0,619
1300	97,666	97,3424	2,000	1,500	0,000	2,130	0,618

Tablica 3 (nastavak). Dotok Q_{01} , Dotok Q_{02} , preljevni protok Q_{p1} , preljevni protok Q_{p2} i protok Q_I za dužinu preljevnog praga $B_2=6$ (m) u ovisnosti o vremenu t

t (s)	h1 (m n.m.)	h2 (m n.m.)	Q01	Q02	Qp1	Qp2	Q1
0	98,000	96,000	2,000	1,000	0,000	0,000	1,535
5	98,010	96,0488	2,025	1,025	0,000	0,000	1,522
10	97,984	96,0977	2,050	1,050	0,000	0,000	1,493
15	97,960	96,1464	2,075	1,075	0,000	0,000	1,464
20	97,938	96,1950	2,100	1,100	0,000	0,000	1,435
25	97,919	96,2435	2,125	1,125	0,000	0,000	1,407
30	97,902	96,2919	2,150	1,150	0,000	0,000	1,379
35	97,887	96,3402	2,175	1,175	0,000	0,000	1,352
40	97,874	96,3884	2,200	1,200	0,000	0,000	1,325
45	97,863	96,4365	2,225	1,225	0,000	0,000	1,298
50	97,853	96,4846	2,250	1,250	0,000	0,000	1,271
55	97,845	96,5326	2,275	1,275	0,000	0,000	1,245
60	97,838	96,5805	2,300	1,300	0,000	0,000	1,219
65	97,833	96,6283	2,325	1,325	0,000	0,000	1,193
70	97,829	96,6761	2,350	1,350	0,000	0,000	1,167
75	97,826	96,7238	2,375	1,375	0,000	0,000	1,141
80	97,825	96,7715	2,400	1,400	0,000	0,000	1,115
85	97,825	96,8191	2,425	1,425	0,000	0,000	1,090
90	97,825	96,8667	2,450	1,450	0,000	0,000	1,064
95	97,827	96,9142	2,475	1,475	0,000	0,000	1,038
100	97,830	96,9616	2,500	1,500	0,000	0,000	1,012
105	97,833	97,0090	2,525	1,525	0,000	0,006	0,987
110	97,838	97,0554	2,550	1,550	0,000	0,092	0,961
115	97,843	97,0997	2,575	1,575	0,000	0,223	0,937
120	97,849	97,1413	2,600	1,600	0,000	0,377	0,914
125	97,856	97,1800	2,625	1,625	0,000	0,541	0,893
130	97,863	97,2156	2,650	1,650	0,000	0,710	0,874
135	97,871	97,2482	2,675	1,675	0,000	0,876	0,858
140	97,880	97,2779	2,700	1,700	0,000	1,038	0,843
145	97,888	97,3047	2,725	1,725	0,000	1,192	0,830
150	97,897	97,3290	2,750	1,750	0,000	1,338	0,819
155	97,907	97,3510	2,775	1,775	0,000	1,474	0,810
160	97,916	97,3708	2,800	1,800	0,000	1,600	0,802
165	97,926	97,3886	2,825	1,825	0,000	1,717	0,796
170	97,935	97,4047	2,850	1,850	0,000	1,825	0,791
175	97,945	97,4192	2,875	1,875	0,000	1,924	0,788
180	97,955	97,4324	2,900	1,900	0,000	2,015	0,785
185	97,965	97,4444	2,925	1,925	0,000	2,099	0,784
190	97,975	97,4552	2,950	1,950	0,000	2,177	0,783
195	97,985	97,4652	2,975	1,975	0,000	2,249	0,783
200	97,995	97,4743	3,000	2,000	0,000	2,315	0,784
205	98,007	97,4842	3,250	2,200	0,000	2,388	0,785
210	98,023	97,4964	3,500	2,400	0,000	2,479	0,789
215	98,044	97,5106	3,750	2,600	0,000	2,586	0,794
220	98,069	97,5265	4,000	2,800	0,000	2,707	0,800
225	98,097	97,5438	4,250	3,000	0,000	2,842	0,808
230	98,129	97,5624	4,500	3,200	0,000	2,989	0,818
235	98,164	97,5821	4,750	3,400	0,000	3,147	0,829
240	98,202	97,6026	5,000	3,600	0,000	3,316	0,841
245	98,242	97,6239	5,250	3,800	0,000	3,493	0,854
250	98,285	97,6458	5,500	4,000	0,000	3,678	0,868
255	98,330	97,6682	5,750	4,200	0,000	3,871	0,884
260	98,376	97,6909	6,000	4,400	0,000	4,070	0,900
265	98,425	97,7139	6,250	4,600	0,000	4,275	0,916
270	98,475	97,7371	6,500	4,800	0,000	4,485	0,934
275	98,527	97,7603	6,750	5,000	0,000	4,698	0,951
280	98,580	97,7836	7,000	5,200	0,000	4,916	0,970
285	98,634	97,8069	7,250	5,400	0,000	5,136	0,988
290	98,689	97,8301	7,500	5,600	0,000	5,360	1,007
295	98,745	97,8531	7,750	5,800	0,000	5,585	1,026
300	98,801	97,8761	8,000	6,000	0,000	5,812	1,045
305	98,856	97,8970	7,975	5,975	0,000	6,021	1,064
310	98,905	97,9142	7,950	5,950	0,000	6,194	1,082
315	98,950	97,9282	7,925	5,925	0,000	6,338	1,098
320	98,990	97,9397	7,900	5,900	0,000	6,456	1,114

Tablica 4 Dotok Q_{01} , Dotok Q_{02} , preljevni protok Q_{p1} , preljevni protok Q_{p2} i protok Q_1 za dužinu preljevnog praga $B_1=2$ (m) i $B_2=4$ (m) u ovisnosti o vremenu t

325	99,027	97,9491	7,875	5,875	0,000	6,553	1,128
330	99,060	97,9566	7,850	5,850	0,000	6,630	1,141
335	99,089	97,9625	7,825	5,825	0,000	6,693	1,153
340	99,116	97,9672	7,800	5,800	0,000	6,742	1,165
345	99,139	97,9708	7,775	5,775	0,000	6,779	1,175
350	99,161	97,9736	7,750	5,750	0,000	6,808	1,184
355	99,179	97,9755	7,725	5,725	0,000	6,829	1,192
360	99,196	97,9769	7,700	5,700	0,000	6,843	1,200
365	99,211	97,9777	7,675	5,675	0,000	6,851	1,207
370	99,223	97,9780	7,650	5,650	0,000	6,854	1,213
375	99,234	97,9780	7,625	5,625	0,000	6,854	1,218
380	99,244	97,9776	7,600	5,600	0,000	6,850	1,223
385	99,252	97,9769	7,575	5,575	0,000	6,843	1,227
390	99,259	97,9760	7,550	5,550	0,000	6,834	1,231
395	99,265	97,9749	7,525	5,525	0,000	6,822	1,234
400	99,270	97,9737	7,500	5,500	0,000	6,809	1,237
405	99,274	97,9722	7,475	5,475	0,000	6,794	1,240
410	99,277	97,9707	7,450	5,450	0,000	6,778	1,242
415	99,279	97,9690	7,425	5,425	0,000	6,760	1,244
420	99,281	97,9673	7,400	5,400	0,000	6,742	1,245
425	99,281	97,9654	7,375	5,375	0,000	6,723	1,247
430	99,282	97,9635	7,350	5,350	0,000	6,702	1,248
435	99,281	97,9615	7,325	5,325	0,000	6,682	1,248
440	99,280	97,9594	7,300	5,300	0,000	6,660	1,249
445	99,279	97,9573	7,275	5,275	0,000	6,638	1,249
450	99,278	97,9552	7,250	5,250	0,000	6,616	1,250
455	99,276	97,9530	7,225	5,225	0,000	6,593	1,250
460	99,273	97,9507	7,200	5,200	0,000	6,570	1,250
465	99,270	97,9485	7,175	5,175	0,000	6,546	1,249
470	99,267	97,9462	7,150	5,150	0,000	6,523	1,249
475	99,264	97,9439	7,125	5,125	0,000	6,499	1,249
480	99,261	97,9415	7,100	5,100	0,000	6,474	1,248
485	99,257	97,9391	7,075	5,075	0,000	6,450	1,248
490	99,253	97,9367	7,050	5,050	0,000	6,425	1,247
495	99,249	97,9343	7,025	5,025	0,000	6,401	1,246
500	99,245	97,9319	7,000	5,000	0,000	6,376	1,245
505	99,240	97,9294	6,963	4,969	0,000	6,350	1,244
510	99,236	97,9268	6,925	4,938	0,000	6,323	1,243
515	99,230	97,9241	6,888	4,906	0,000	6,295	1,242
520	99,225	97,9213	6,850	4,875	0,000	6,267	1,241
525	99,219	97,9184	6,813	4,844	0,000	6,238	1,239
530	99,213	97,9155	6,775	4,813	0,000	6,208	1,238
535	99,207	97,9125	6,738	4,781	0,000	6,178	1,236
540	99,200	97,9095	6,700	4,750	0,000	6,147	1,235
545	99,193	97,9065	6,663	4,719	0,000	6,116	1,233
550	99,186	97,9034	6,625	4,688	0,000	6,085	1,231
555	99,179	97,9002	6,588	4,656	0,000	6,053	1,229
560	99,172	97,8971	6,550	4,625	0,000	6,022	1,227
565	99,164	97,8939	6,513	4,594	0,000	5,990	1,225
570	99,157	97,8907	6,475	4,563	0,000	5,957	1,223
575	99,149	97,8875	6,438	4,531	0,000	5,925	1,221
580	99,142	97,8842	6,400	4,500	0,000	5,893	1,219
585	99,134	97,8810	6,363	4,469	0,000	5,860	1,216
590	99,126	97,8777	6,325	4,438	0,000	5,827	1,214
595	99,118	97,8744	6,288	4,406	0,000	5,795	1,212
600	99,109	97,8711	6,250	4,375	0,000	5,762	1,209
605	99,101	97,8678	6,213	4,344	0,000	5,729	1,207
610	99,093	97,8644	6,175	4,313	0,000	5,696	1,205
615	99,085	97,8611	6,138	4,281	0,000	5,663	1,202
620	99,076	97,8577	6,100	4,250	0,000	5,630	1,200
625	99,068	97,8543	6,063	4,219	0,000	5,596	1,197
630	99,059	97,8510	6,025	4,188	0,000	5,563	1,195
635	99,051	97,8476	5,988	4,156	0,000	5,530	1,192
640	99,042	97,8442	5,950	4,125	0,000	5,497	1,189

Tablica 4 (nastavak). Dotok Q_{01} , Dotok Q_{02} , preljevni protok Q_{p1} , preljevni protok Q_{p2} i protok Q_1 za dužinu preljevnog praga $B_1=2$ (m) i $B_2=4$ (m) u ovisnosti o vremenu t

645	99,033	97,8407	5,913	4,094	0,000	5,463	1,187
650	99,025	97,8373	5,875	4,063	0,000	5,430	1,184
655	99,016	97,8339	5,838	4,031	0,000	5,397	1,181
660	99,007	97,8304	5,800	4,000	0,000	5,363	1,179
665	98,998	97,8270	5,763	3,969	0,000	5,330	1,176
670	98,989	97,8235	5,725	3,938	0,000	5,296	1,173
675	98,980	97,8200	5,688	3,906	0,000	5,263	1,171
680	98,972	97,8166	5,650	3,875	0,000	5,229	1,168
685	98,963	97,8131	5,613	3,844	0,000	5,196	1,165
690	98,954	97,8096	5,575	3,813	0,000	5,162	1,162
695	98,945	97,8061	5,538	3,781	0,000	5,129	1,160
700	98,936	97,8025	5,500	3,750	0,000	5,095	1,157
705	98,927	97,7990	5,463	3,719	0,000	5,062	1,154
710	98,917	97,7955	5,425	3,688	0,000	5,028	1,151
715	98,908	97,7919	5,388	3,656	0,000	4,994	1,148
720	98,899	97,7884	5,350	3,625	0,000	4,961	1,145
725	98,890	97,7848	5,313	3,594	0,000	4,927	1,142
730	98,881	97,7812	5,275	3,563	0,000	4,893	1,140
735	98,872	97,7776	5,238	3,531	0,000	4,860	1,137
740	98,862	97,7740	5,200	3,500	0,000	4,826	1,134
745	98,853	97,7704	5,163	3,469	0,000	4,792	1,131
750	98,844	97,7668	5,125	3,438	0,000	4,759	1,128
755	98,835	97,7632	5,088	3,406	0,000	4,725	1,125
760	98,825	97,7595	5,050	3,375	0,000	4,691	1,122
765	98,816	97,7559	5,013	3,344	0,000	4,658	1,119
770	98,806	97,7522	4,975	3,313	0,000	4,624	1,116
775	98,797	97,7486	4,938	3,281	0,000	4,590	1,113
780	98,788	97,7449	4,900	3,250	0,000	4,556	1,110
785	98,778	97,7412	4,863	3,219	0,000	4,523	1,107
790	98,769	97,7375	4,825	3,188	0,000	4,489	1,104
795	98,759	97,7338	4,788	3,156	0,000	4,455	1,100
800	98,750	97,7301	4,750	3,125	0,000	4,421	1,097
805	98,740	97,7264	4,713	3,094	0,000	4,387	1,094
810	98,731	97,7226	4,675	3,063	0,000	4,353	1,091
815	98,721	97,7189	4,638	3,031	0,000	4,320	1,088
820	98,712	97,7151	4,600	3,000	0,000	4,286	1,085
825	98,702	97,7113	4,563	2,969	0,000	4,252	1,082
830	98,692	97,7076	4,525	2,938	0,000	4,218	1,078
835	98,683	97,7038	4,488	2,906	0,000	4,184	1,075
840	98,673	97,7000	4,450	2,875	0,000	4,150	1,072
845	98,663	97,6961	4,413	2,844	0,000	4,116	1,069
850	98,654	97,6923	4,375	2,813	0,000	4,083	1,065
855	98,644	97,6885	4,338	2,781	0,000	4,049	1,062
860	98,634	97,6846	4,300	2,750	0,000	4,015	1,059
865	98,624	97,6808	4,263	2,719	0,000	3,981	1,056
870	98,615	97,6769	4,225	2,688	0,000	3,947	1,052
875	98,605	97,6730	4,188	2,656	0,000	3,913	1,049
880	98,595	97,6691	4,150	2,625	0,000	3,879	1,046
885	98,585	97,6652	4,113	2,594	0,000	3,845	1,042
890	98,575	97,6613	4,075	2,563	0,000	3,811	1,039
895	98,565	97,6573	4,038	2,531	0,000	3,777	1,035
900	98,555	97,6534	4,000	2,500	0,000	3,743	1,032
905	98,545	97,6495	3,967	2,483	0,000	3,710	1,028
910	98,535	97,6459	3,933	2,467	0,000	3,679	1,025
915	98,526	97,6425	3,900	2,450	0,000	3,650	1,021
920	98,516	97,6392	3,867	2,433	0,000	3,622	1,017
925	98,506	97,6361	3,833	2,417	0,000	3,595	1,014
930	98,497	97,6330	3,800	2,400	0,000	3,569	1,010
935	98,487	97,6301	3,767	2,383	0,000	3,544	1,006
940	98,477	97,6272	3,733	2,367	0,000	3,520	1,002
945	98,468	97,6244	3,700	2,350	0,000	3,496	0,998
950	98,458	97,6216	3,667	2,333	0,000	3,473	0,994
955	98,449	97,6189	3,633	2,317	0,000	3,450	0,990
960	98,439	97,6162	3,600	2,300	0,000	3,428	0,986

Tablica 4 (nastavak). Dotok Q_{01} , Dotok Q_{02} , preljevni protok Q_{p1} , preljevni protok Q_{p2} i protok Q_1 za dužinu preljevnog praga $B_1=2$ (m) i $B_2=4$ (m) u ovisnosti o vremenu t

965	98,430	97,6135	3,567	2,283	0,000	3,406	0,982
970	98,420	97,6109	3,533	2,267	0,000	3,384	0,978
975	98,411	97,6083	3,500	2,250	0,000	3,362	0,973
980	98,402	97,6057	3,467	2,233	0,000	3,341	0,969
985	98,392	97,6031	3,433	2,217	0,000	3,319	0,965
990	98,383	97,6005	3,400	2,200	0,000	3,298	0,961
995	98,373	97,5979	3,367	2,183	0,000	3,277	0,957
1000	98,364	97,5953	3,333	2,167	0,000	3,256	0,953
1005	98,355	97,5928	3,300	2,150	0,000	3,235	0,948
1010	98,345	97,5902	3,267	2,133	0,000	3,214	0,944
1015	98,336	97,5877	3,233	2,117	0,000	3,193	0,940
1020	98,326	97,5851	3,200	2,100	0,000	3,172	0,935
1025	98,317	97,5825	3,167	2,083	0,000	3,151	0,931
1030	98,307	97,5799	3,133	2,067	0,000	3,130	0,927
1035	98,298	97,5774	3,100	2,050	0,000	3,109	0,922
1040	98,289	97,5748	3,067	2,033	0,000	3,088	0,918
1045	98,279	97,5722	3,033	2,017	0,000	3,068	0,914
1050	98,270	97,5696	3,000	2,000	0,000	3,047	0,909
1055	98,260	97,5670	2,967	1,983	0,000	3,026	0,905
1060	98,251	97,5644	2,933	1,967	0,000	3,005	0,900
1065	98,241	97,5618	2,900	1,950	0,000	2,984	0,896
1070	98,232	97,5592	2,867	1,933	0,000	2,964	0,891
1075	98,222	97,5566	2,833	1,917	0,000	2,943	0,886
1080	98,213	97,5539	2,800	1,900	0,000	2,922	0,882
1085	98,203	97,5513	2,767	1,883	0,000	2,901	0,877
1090	98,194	97,5486	2,733	1,867	0,000	2,880	0,872
1095	98,184	97,5460	2,700	1,850	0,000	2,859	0,868
1100	98,174	97,5433	2,667	1,833	0,000	2,838	0,863
1105	98,165	97,5406	2,633	1,817	0,000	2,817	0,858
1110	98,155	97,5380	2,600	1,800	0,000	2,796	0,853
1115	98,145	97,5353	2,567	1,783	0,000	2,775	0,849
1120	98,136	97,5326	2,533	1,767	0,000	2,754	0,844
1125	98,126	97,5298	2,500	1,750	0,000	2,733	0,839
1130	98,116	97,5271	2,467	1,733	0,000	2,712	0,834
1135	98,106	97,5244	2,433	1,717	0,000	2,691	0,829
1140	98,097	97,5216	2,400	1,700	0,000	2,670	0,824
1145	98,087	97,5189	2,367	1,683	0,000	2,649	0,819
1150	98,077	97,5161	2,333	1,667	0,000	2,628	0,814
1155	98,067	97,5133	2,300	1,650	0,000	2,606	0,809
1160	98,057	97,5105	2,267	1,633	0,000	2,585	0,803
1165	98,047	97,5077	2,233	1,617	0,000	2,564	0,798
1170	98,038	97,5049	2,200	1,600	0,000	2,543	0,793
1175	98,028	97,5021	2,167	1,583	0,000	2,521	0,787
1180	98,018	97,4992	2,133	1,567	0,000	2,500	0,782
1185	98,008	97,4964	2,100	1,550	0,000	2,479	0,777
1190	97,998	97,4935	2,067	1,533	0,000	2,457	0,771
1195	97,988	97,4906	2,033	1,517	0,000	2,436	0,766
1200	97,977	97,4877	2,000	1,500	0,000	2,414	0,760
1205	97,968	97,4850	2,000	1,500	0,000	2,394	0,755
1210	97,959	97,4825	2,000	1,500	0,000	2,375	0,749
1215	97,950	97,4802	2,000	1,500	0,000	2,358	0,745
1220	97,942	97,4782	2,000	1,500	0,000	2,343	0,740
1225	97,935	97,4763	2,000	1,500	0,000	2,330	0,735
1230	97,928	97,4746	2,000	1,500	0,000	2,317	0,731
1235	97,921	97,4730	2,000	1,500	0,000	2,306	0,727
1240	97,915	97,4716	2,000	1,500	0,000	2,295	0,723
1245	97,909	97,4703	2,000	1,500	0,000	2,286	0,720
1250	97,904	97,4691	2,000	1,500	0,000	2,277	0,716
1255	97,899	97,4680	2,000	1,500	0,000	2,269	0,713
1260	97,895	97,4670	2,000	1,500	0,000	2,261	0,710
1265	97,890	97,4660	2,000	1,500	0,000	2,255	0,707
1270	97,886	97,4652	2,000	1,500	0,000	2,248	0,705
1275	97,882	97,4643	2,000	1,500	0,000	2,243	0,702
1280	97,879	97,4636	2,000	1,500	0,000	2,237	0,700
1285	97,876	97,4629	2,000	1,500	0,000	2,232	0,698
1290	97,873	97,4623	2,000	1,500	0,000	2,228	0,696
1295	97,870	97,4617	2,000	1,500	0,000	2,223	0,694
1300	97,867	97,4611	2,000	1,500	0,000	2,219	0,692

Tablica 4 (nastavak). Dotok Q_{01} , Dotok Q_{02} , preljevni protok Q_{p1} , preljevni protok Q_{p2} i protok Q_1 za dužinu preljevnog praga $B_1=2$ (m) i $B_2=4$ (m) u ovisnosti o vremenu t

t (s)	h1 (m n.m.)	h2 (m n.m.)	Q01	Q02	Qp1	Qp2	Q1
0	98,000	96,000	2,000	1,000	0,000	0,000	1,535
5	98,010	96,0488	2,025	1,025	0,000	0,000	1,522
10	98,002	96,0978	2,050	1,050	0,000	0,000	1,500
15	97,996	96,1467	2,075	1,075	0,000	0,000	1,478
20	97,990	96,1956	2,100	1,100	0,000	0,000	1,456
25	97,986	96,2446	2,125	1,125	0,000	0,000	1,434
30	97,983	96,2936	2,150	1,150	0,000	0,000	1,413
35	97,981	96,3425	2,175	1,175	0,000	0,000	1,391
40	97,980	96,3916	2,200	1,200	0,000	0,000	1,370
45	97,980	96,4406	2,225	1,225	0,000	0,000	1,348
50	97,981	96,4897	2,250	1,250	0,000	0,000	1,327
55	97,982	96,5387	2,275	1,275	0,000	0,000	1,306
60	97,985	96,5879	2,300	1,300	0,000	0,000	1,285
65	97,989	96,6370	2,325	1,325	0,000	0,000	1,263
70	97,993	96,6862	2,350	1,350	0,000	0,000	1,242
75	97,998	96,7354	2,375	1,375	0,000	0,000	1,221
80	98,005	96,7846	2,400	1,400	0,000	0,000	1,200
85	98,012	96,8338	2,425	1,425	0,000	0,000	1,179
90	98,019	96,8831	2,450	1,450	0,000	0,000	1,158
95	98,028	96,9324	2,475	1,475	0,000	0,000	1,137
100	98,037	96,9818	2,500	1,500	0,000	0,000	1,116
105	98,047	97,0308	2,525	1,525	0,000	0,038	1,095
110	98,057	97,0784	2,550	1,550	0,000	0,156	1,075
115	98,068	97,1235	2,575	1,575	0,000	0,308	1,056
120	98,080	97,1657	2,600	1,600	0,000	0,478	1,039
125	98,092	97,2047	2,625	1,625	0,000	0,656	1,024
130	98,105	97,2405	2,650	1,650	0,000	0,836	1,010
135	98,118	97,2732	2,675	1,675	0,000	1,012	0,999
140	98,131	97,3029	2,700	1,700	0,000	1,182	0,989
145	98,145	97,3298	2,725	1,725	0,000	1,342	0,981
150	98,159	97,3541	2,750	1,750	0,000	1,494	0,975
155	98,173	97,3761	2,775	1,775	0,000	1,634	0,970
160	98,188	97,3958	2,800	1,800	0,000	1,765	0,967
165	98,202	97,4137	2,825	1,825	0,000	1,885	0,965
170	98,217	97,4297	2,850	1,850	0,000	1,997	0,964
175	98,232	97,4443	2,875	1,875	0,000	2,099	0,964
180	98,247	97,4575	2,900	1,900	0,000	2,193	0,965
185	98,261	97,4695	2,925	1,925	0,000	2,280	0,967
190	98,276	97,4804	2,950	1,950	0,000	2,360	0,969
195	98,291	97,4904	2,975	1,975	0,000	2,434	0,972
200	98,306	97,4996	3,000	2,000	0,000	2,503	0,976
205	98,323	97,5096	3,250	2,200	0,000	2,578	0,980
210	98,345	97,5219	3,500	2,400	0,000	2,672	0,985
215	98,370	97,5361	3,750	2,600	0,000	2,782	0,993
220	98,401	97,5520	4,000	2,800	0,000	2,907	1,001
225	98,435	97,5693	4,250	3,000	0,000	3,045	1,011
230	98,473	97,5879	4,500	3,200	0,000	3,195	1,022
235	98,514	97,6075	4,750	3,400	0,000	3,356	1,035
240	98,559	97,6280	5,000	3,600	0,000	3,527	1,048
245	98,607	97,6492	5,250	3,800	0,000	3,707	1,064
250	98,659	97,6710	5,500	4,000	0,000	3,896	1,080
255	98,713	97,6933	5,750	4,200	0,000	4,091	1,097
260	98,770	97,7159	6,000	4,400	0,000	4,293	1,116
265	98,830	97,7387	6,250	4,600	0,000	4,500	1,135
270	98,892	97,7618	6,500	4,800	0,000	4,712	1,155
275	98,956	97,7849	6,750	5,000	0,000	4,928	1,176
280	99,023	97,8081	7,000	5,200	0,000	5,148	1,198
285	99,092	97,8313	7,250	5,400	0,000	5,371	1,220
290	99,162	97,8544	7,500	5,600	0,000	5,597	1,243
295	99,234	97,8775	7,750	5,800	0,000	5,825	1,266
300	99,308	97,9004	8,000	6,000	0,000	6,055	1,289
305	99,381	97,9213	7,975	5,975	0,000	6,267	1,313
310	99,449	97,9386	7,950	5,950	0,000	6,444	1,336
315	99,514	97,9527	7,925	5,925	0,000	6,591	1,358
320	99,575	97,9644	7,900	5,900	0,000	6,712	1,379

Tablica 5 Dotok Q_{01} , Dotok Q_{02} , preljevni protok Q_{p1} , preljevni protok Q_{p2} i protok Q_1 za dužinu preljevnog praga $B_1=1$ (m) i $B_2=4$ (m) u ovisnosti o vremenu t

325	99,632	97,9739	7,875	5,875	0,000	6,812	1,399
330	99,686	97,9817	7,850	5,850	0,000	6,893	1,419
335	99,736	97,9879	7,825	5,825	0,000	6,959	1,437
340	99,783	97,9929	7,800	5,800	0,000	7,012	1,454
345	99,828	97,9969	7,775	5,775	0,000	7,055	1,471
350	99,869	98,0001	7,750	5,750	0,000	7,088	1,486
355	99,908	98,0024	7,725	5,725	0,000	7,113	1,500
360	99,944	98,0042	7,700	5,700	0,000	7,132	1,514
365	99,978	98,0055	7,675	5,675	0,000	7,145	1,527
370	100,010	98,0063	7,650	5,650	0,002	7,154	1,538
375	100,039	98,0067	7,625	5,625	0,014	7,159	1,549
380	100,066	98,0069	7,600	5,600	0,030	7,160	1,560
385	100,091	98,0067	7,575	5,575	0,048	7,158	1,569
390	100,114	98,0063	7,550	5,550	0,068	7,154	1,578
395	100,134	98,0057	7,525	5,525	0,087	7,148	1,586
400	100,154	98,0049	7,500	5,500	0,107	7,139	1,593
405	100,171	98,0039	7,475	5,475	0,125	7,129	1,600
410	100,187	98,0029	7,450	5,450	0,143	7,118	1,606
415	100,201	98,0016	7,425	5,425	0,159	7,105	1,612
420	100,213	98,0003	7,400	5,400	0,175	7,090	1,617
425	100,225	97,9989	7,375	5,375	0,189	7,075	1,622
430	100,235	97,9974	7,350	5,350	0,202	7,059	1,626
435	100,244	97,9958	7,325	5,325	0,213	7,042	1,630
440	100,252	97,9941	7,300	5,300	0,224	7,024	1,633
445	100,259	97,9923	7,275	5,275	0,233	7,006	1,636
450	100,264	97,9905	7,250	5,250	0,241	6,987	1,639
455	100,269	97,9887	7,225	5,225	0,248	6,967	1,641
460	100,274	97,9868	7,200	5,200	0,253	6,947	1,644
465	100,277	97,9848	7,175	5,175	0,258	6,926	1,646
470	100,279	97,9828	7,150	5,150	0,262	6,905	1,647
475	100,281	97,9808	7,125	5,125	0,265	6,884	1,649
480	100,283	97,9787	7,100	5,100	0,266	6,862	1,650
485	100,283	97,9766	7,075	5,075	0,267	6,840	1,651
490	100,284	97,9744	7,050	5,050	0,268	6,817	1,652
495	100,283	97,9723	7,025	5,025	0,267	6,794	1,652
500	100,282	97,9701	7,000	5,000	0,266	6,771	1,653
505	100,281	97,9678	6,963	4,969	0,264	6,747	1,653
510	100,279	97,9654	6,925	4,938	0,261	6,722	1,653
515	100,276	97,9629	6,888	4,906	0,257	6,696	1,653
520	100,273	97,9603	6,850	4,875	0,253	6,669	1,653
525	100,269	97,9576	6,813	4,844	0,248	6,641	1,653
530	100,265	97,9549	6,775	4,813	0,242	6,613	1,652
535	100,260	97,9521	6,738	4,781	0,235	6,584	1,651
540	100,255	97,9492	6,700	4,750	0,228	6,554	1,650
545	100,249	97,9463	6,663	4,719	0,221	6,524	1,650
550	100,244	97,9434	6,625	4,688	0,213	6,494	1,648
555	100,237	97,9404	6,588	4,656	0,205	6,463	1,647
560	100,231	97,9374	6,550	4,625	0,196	6,432	1,646
565	100,224	97,9344	6,513	4,594	0,187	6,401	1,645
570	100,216	97,9313	6,475	4,563	0,178	6,370	1,643
575	100,209	97,9283	6,438	4,531	0,169	6,338	1,641
580	100,201	97,9252	6,400	4,500	0,160	6,307	1,640
585	100,193	97,9220	6,363	4,469	0,150	6,275	1,638
590	100,185	97,9189	6,325	4,438	0,140	6,242	1,636
595	100,176	97,9157	6,288	4,406	0,131	6,210	1,634
600	100,167	97,9125	6,250	4,375	0,121	6,178	1,632
605	100,158	97,9093	6,213	4,344	0,112	6,145	1,630
610	100,149	97,9061	6,175	4,313	0,102	6,113	1,628
615	100,140	97,9029	6,138	4,281	0,093	6,080	1,626
620	100,130	97,8996	6,100	4,250	0,083	6,048	1,623
625	100,121	97,8964	6,063	4,219	0,074	6,015	1,621
630	100,111	97,8931	6,025	4,188	0,066	5,982	1,619
635	100,101	97,8898	5,988	4,156	0,057	5,949	1,616
640	100,091	97,8865	5,950	4,125	0,049	5,916	1,614

Tablica 5 (nastavak). Dotok Q_{01} , Dotok Q_{02} , preljevni protok Q_{p1} , preljevni protok Q_{p2} i protok Q_1 za dužinu preljevnog praga $B_1=1$ (m) i $B_2=4$ (m) u ovisnosti o vremenu t

645	100,081	97,8832	5,913	4,094	0,041	5,883	1,611
650	100,070	97,8799	5,875	4,063	0,033	5,849	1,609
655	100,060	97,8766	5,838	4,031	0,026	5,816	1,606
660	100,049	97,8732	5,800	4,000	0,019	5,783	1,603
665	100,038	97,8698	5,763	3,969	0,013	5,749	1,600
670	100,027	97,8665	5,725	3,938	0,008	5,716	1,598
675	100,016	97,8631	5,688	3,906	0,004	5,683	1,595
680	100,005	97,8597	5,650	3,875	0,001	5,649	1,592
685	99,993	97,8563	5,613	3,844	0,000	5,615	1,589
690	99,982	97,8528	5,575	3,813	0,000	5,582	1,586
695	99,970	97,8494	5,538	3,781	0,000	5,548	1,583
700	99,958	97,8460	5,500	3,750	0,000	5,514	1,580
705	99,946	97,8425	5,463	3,719	0,000	5,481	1,576
710	99,934	97,8390	5,425	3,688	0,000	5,447	1,573
715	99,922	97,8355	5,388	3,656	0,000	5,413	1,570
720	99,909	97,8320	5,350	3,625	0,000	5,379	1,566
725	99,897	97,8285	5,313	3,594	0,000	5,345	1,563
730	99,884	97,8250	5,275	3,563	0,000	5,311	1,560
735	99,871	97,8215	5,238	3,531	0,000	5,277	1,556
740	99,858	97,8179	5,200	3,500	0,000	5,243	1,552
745	99,845	97,8144	5,163	3,469	0,000	5,208	1,549
750	99,832	97,8108	5,125	3,438	0,000	5,174	1,545
755	99,819	97,8072	5,088	3,406	0,000	5,140	1,542
760	99,806	97,8036	5,050	3,375	0,000	5,106	1,538
765	99,792	97,8000	5,013	3,344	0,000	5,071	1,534
770	99,779	97,7964	4,975	3,313	0,000	5,037	1,530
775	99,765	97,7927	4,938	3,281	0,000	5,002	1,526
780	99,752	97,7891	4,900	3,250	0,000	4,968	1,523
785	99,738	97,7854	4,863	3,219	0,000	4,933	1,519
790	99,724	97,7818	4,825	3,188	0,000	4,899	1,515
795	99,710	97,7781	4,788	3,156	0,000	4,864	1,511
800	99,696	97,7744	4,750	3,125	0,000	4,830	1,507
805	99,682	97,7707	4,713	3,094	0,000	4,795	1,503
810	99,668	97,7670	4,675	3,063	0,000	4,760	1,499
815	99,654	97,7632	4,638	3,031	0,000	4,726	1,495
820	99,640	97,7595	4,600	3,000	0,000	4,691	1,490
825	99,626	97,7557	4,563	2,969	0,000	4,656	1,486
830	99,612	97,7520	4,525	2,938	0,000	4,621	1,482
835	99,597	97,7482	4,488	2,906	0,000	4,587	1,478
840	99,583	97,7444	4,450	2,875	0,000	4,552	1,474
845	99,568	97,7406	4,413	2,844	0,000	4,517	1,469
850	99,554	97,7368	4,375	2,813	0,000	4,482	1,465
855	99,539	97,7329	4,338	2,781	0,000	4,447	1,461
860	99,525	97,7291	4,300	2,750	0,000	4,412	1,456
865	99,510	97,7252	4,263	2,719	0,000	4,377	1,452
870	99,495	97,7214	4,225	2,688	0,000	4,342	1,448
875	99,481	97,7175	4,188	2,656	0,000	4,307	1,443
880	99,466	97,7136	4,150	2,625	0,000	4,272	1,439
885	99,451	97,7097	4,113	2,594	0,000	4,237	1,434
890	99,436	97,7058	4,075	2,563	0,000	4,202	1,430
895	99,421	97,7018	4,038	2,531	0,000	4,167	1,425
900	99,406	97,6979	4,000	2,500	0,000	4,132	1,421
905	99,391	97,6940	3,967	2,483	0,000	4,098	1,416
910	99,376	97,6904	3,933	2,467	0,000	4,066	1,411
915	99,361	97,6870	3,900	2,450	0,000	4,035	1,406
920	99,347	97,6837	3,867	2,433	0,000	4,006	1,402
925	99,332	97,6805	3,833	2,417	0,000	3,979	1,397
930	99,317	97,6775	3,800	2,400	0,000	3,952	1,392
935	99,302	97,6745	3,767	2,383	0,000	3,926	1,387
940	99,287	97,6716	3,733	2,367	0,000	3,901	1,382
945	99,273	97,6688	3,700	2,350	0,000	3,876	1,376
950	99,258	97,6660	3,667	2,333	0,000	3,852	1,371
955	99,243	97,6632	3,633	2,317	0,000	3,828	1,366
960	99,229	97,6605	3,600	2,300	0,000	3,805	1,361

Tablica 5 (nastavak). Dotok Q_{01} , Dotok Q_{02} , preljevni protok Q_{p1} , preljevni protok Q_{p2} i protok Q_1 za dužinu preljevnog praga $B_1=1$ (m) i $B_2=4$ (m) u ovisnosti o vremenu t

965	99,214	97,6578	3,567	2,283	0,000	3,781	1,356
970	99,199	97,6552	3,533	2,267	0,000	3,758	1,351
975	99,185	97,6525	3,500	2,250	0,000	3,736	1,345
980	99,170	97,6499	3,467	2,233	0,000	3,713	1,340
985	99,156	97,6473	3,433	2,217	0,000	3,691	1,335
990	99,141	97,6447	3,400	2,200	0,000	3,668	1,329
995	99,126	97,6420	3,367	2,183	0,000	3,646	1,324
1000	99,112	97,6394	3,333	2,167	0,000	3,624	1,319
1005	99,097	97,6368	3,300	2,150	0,000	3,602	1,313
1010	99,083	97,6342	3,267	2,133	0,000	3,580	1,308
1015	99,068	97,6316	3,233	2,117	0,000	3,558	1,302
1020	99,053	97,6290	3,200	2,100	0,000	3,536	1,297
1025	99,039	97,6264	3,167	2,083	0,000	3,514	1,292
1030	99,024	97,6238	3,133	2,067	0,000	3,492	1,286
1035	99,010	97,6212	3,100	2,050	0,000	3,470	1,281
1040	98,995	97,6186	3,067	2,033	0,000	3,448	1,275
1045	98,980	97,6159	3,033	2,017	0,000	3,426	1,269
1050	98,966	97,6133	3,000	2,000	0,000	3,404	1,264
1055	98,951	97,6107	2,967	1,983	0,000	3,382	1,258
1060	98,936	97,6080	2,933	1,967	0,000	3,360	1,253
1065	98,922	97,6054	2,900	1,950	0,000	3,338	1,247
1070	98,907	97,6027	2,867	1,933	0,000	3,316	1,241
1075	98,892	97,6000	2,833	1,917	0,000	3,294	1,235
1080	98,878	97,5974	2,800	1,900	0,000	3,272	1,230
1085	98,863	97,5947	2,767	1,883	0,000	3,250	1,224
1090	98,848	97,5920	2,733	1,867	0,000	3,228	1,218
1095	98,833	97,5893	2,700	1,850	0,000	3,206	1,212
1100	98,818	97,5866	2,667	1,833	0,000	3,184	1,206
1105	98,804	97,5838	2,633	1,817	0,000	3,162	1,200
1110	98,789	97,5811	2,600	1,800	0,000	3,140	1,194
1115	98,774	97,5784	2,567	1,783	0,000	3,117	1,188
1120	98,759	97,5756	2,533	1,767	0,000	3,095	1,182
1125	98,744	97,5729	2,500	1,750	0,000	3,073	1,176
1130	98,729	97,5701	2,467	1,733	0,000	3,051	1,170
1135	98,714	97,5673	2,433	1,717	0,000	3,028	1,164
1140	98,699	97,5645	2,400	1,700	0,000	3,006	1,158
1145	98,684	97,5617	2,367	1,683	0,000	2,984	1,151
1150	98,669	97,5589	2,333	1,667	0,000	2,961	1,145
1155	98,654	97,5561	2,300	1,650	0,000	2,939	1,139
1160	98,639	97,5533	2,267	1,633	0,000	2,916	1,132
1165	98,624	97,5504	2,233	1,617	0,000	2,894	1,126
1170	98,609	97,5476	2,200	1,600	0,000	2,871	1,119
1175	98,593	97,5447	2,167	1,583	0,000	2,849	1,113
1180	98,578	97,5418	2,133	1,567	0,000	2,826	1,106
1185	98,563	97,5389	2,100	1,550	0,000	2,804	1,100
1190	98,548	97,5360	2,067	1,533	0,000	2,781	1,093
1195	98,532	97,5331	2,033	1,517	0,000	2,758	1,086
1200	98,517	97,5301	2,000	1,500	0,000	2,736	1,079
1205	98,502	97,5273	2,000	1,500	0,000	2,714	1,073
1210	98,487	97,5248	2,000	1,500	0,000	2,694	1,066
1215	98,474	97,5225	2,000	1,500	0,000	2,677	1,060
1220	98,460	97,5204	2,000	1,500	0,000	2,660	1,054
1225	98,448	97,5184	2,000	1,500	0,000	2,646	1,048
1230	98,436	97,5167	2,000	1,500	0,000	2,632	1,042
1235	98,424	97,5150	2,000	1,500	0,000	2,619	1,036
1240	98,413	97,5135	2,000	1,500	0,000	2,608	1,031
1245	98,402	97,5121	2,000	1,500	0,000	2,597	1,025
1250	98,392	97,5108	2,000	1,500	0,000	2,587	1,020
1255	98,382	97,5095	2,000	1,500	0,000	2,578	1,015
1260	98,373	97,5084	2,000	1,500	0,000	2,569	1,010
1265	98,364	97,5073	2,000	1,500	0,000	2,561	1,006
1270	98,356	97,5063	2,000	1,500	0,000	2,553	1,001
1275	98,347	97,5053	2,000	1,500	0,000	2,546	0,997
1280	98,340	97,5044	2,000	1,500	0,000	2,539	0,993
1285	98,332	97,5036	2,000	1,500	0,000	2,532	0,989
1290	98,325	97,5027	2,000	1,500	0,000	2,526	0,985
1295	98,318	97,5020	2,000	1,500	0,000	2,521	0,982
1300	98,311	97,5012	2,000	1,500	0,000	2,515	0,978

Tablica 5 (nastavak). Dotok Q_{01} , Dotok Q_{02} , preljevni protok Q_{p1} , preljevni protok Q_{p2} i protok Q_1 za dužinu preljevnog praga $B_1=1$ (m) i $B_2=4$ (m) u ovisnosti o vremenu t

t (s)	h1 (m n.m.)	h2 (m n.m.)	Q01	Q02	Qp1	Qp2	Q1
0	98,000	96,000	2,000	1,000	0,000	0,000	1,535
5	98,010	96,0488	2,025	1,025	0,000	0,000	1,522
10	98,012	96,0978	2,050	1,050	0,000	0,000	1,504
15	98,014	96,1468	2,075	1,075	0,000	0,000	1,485
20	98,017	96,1959	2,100	1,100	0,000	0,000	1,467
25	98,022	96,2451	2,125	1,125	0,000	0,000	1,449
30	98,027	96,2944	2,150	1,150	0,000	0,000	1,430
35	98,033	96,3438	2,175	1,175	0,000	0,000	1,412
40	98,039	96,3932	2,200	1,200	0,000	0,000	1,394
45	98,047	96,4428	2,225	1,225	0,000	0,000	1,376
50	98,055	96,4924	2,250	1,250	0,000	0,000	1,359
55	98,064	96,5421	2,275	1,275	0,000	0,000	1,341
60	98,074	96,5919	2,300	1,300	0,000	0,000	1,323
65	98,084	96,6418	2,325	1,325	0,000	0,000	1,305
70	98,096	96,6918	2,350	1,350	0,000	0,000	1,288
75	98,108	96,7419	2,375	1,375	0,000	0,000	1,270
80	98,120	96,7921	2,400	1,400	0,000	0,000	1,252
85	98,134	96,8423	2,425	1,425	0,000	0,000	1,235
90	98,148	96,8927	2,450	1,450	0,000	0,000	1,217
95	98,163	96,9431	2,475	1,475	0,000	0,000	1,200
100	98,178	96,9937	2,500	1,500	0,000	0,000	1,183
105	98,194	97,0440	2,525	1,525	0,000	0,033	1,165
110	98,211	97,0935	2,550	1,550	0,000	0,101	1,149
115	98,228	97,1417	2,575	1,575	0,000	0,189	1,133
120	98,246	97,1882	2,600	1,600	0,000	0,289	1,118
125	98,264	97,2329	2,625	1,625	0,000	0,398	1,104
130	98,283	97,2756	2,650	1,650	0,000	0,513	1,091
135	98,302	97,3164	2,675	1,675	0,000	0,631	1,079
140	98,322	97,3552	2,700	1,700	0,000	0,750	1,069
145	98,342	97,3920	2,725	1,725	0,000	0,870	1,059
150	98,363	97,4269	2,750	1,750	0,000	0,988	1,051
155	98,384	97,4599	2,775	1,775	0,000	1,105	1,044
160	98,405	97,4910	2,800	1,800	0,000	1,219	1,039
165	98,427	97,5204	2,825	1,825	0,000	1,330	1,034
170	98,448	97,5482	2,850	1,850	0,000	1,438	1,031
175	98,470	97,5743	2,875	1,875	0,000	1,542	1,028
180	98,492	97,5990	2,900	1,900	0,000	1,643	1,027
185	98,514	97,6222	2,925	1,925	0,000	1,739	1,026
190	98,537	97,6442	2,950	1,950	0,000	1,832	1,027
195	98,559	97,6649	2,975	1,975	0,000	1,921	1,028
200	98,582	97,6845	3,000	2,000	0,000	2,007	1,029
205	98,607	97,7046	3,250	2,200	0,000	2,096	1,032
210	98,637	97,7267	3,500	2,400	0,000	2,195	1,036
215	98,671	97,7507	3,750	2,600	0,000	2,305	1,042
220	98,709	97,7763	4,000	2,800	0,000	2,424	1,049
225	98,752	97,8036	4,250	3,000	0,000	2,553	1,058
230	98,799	97,8322	4,500	3,200	0,000	2,690	1,068
235	98,850	97,8621	4,750	3,400	0,000	2,836	1,080
240	98,904	97,8931	5,000	3,600	0,000	2,991	1,093
245	98,963	97,9251	5,250	3,800	0,000	3,153	1,107
250	99,025	97,9580	5,500	4,000	0,000	3,323	1,122
255	99,090	97,9917	5,750	4,200	0,000	3,500	1,139
260	99,159	98,0261	6,000	4,400	0,000	3,683	1,157
265	99,232	98,0610	6,250	4,600	0,000	3,873	1,176
270	99,307	98,0964	6,500	4,800	0,000	4,068	1,196
275	99,385	98,1322	6,750	5,000	0,000	4,269	1,217
280	99,467	98,1683	7,000	5,200	0,000	4,475	1,238
285	99,551	98,2046	7,250	5,400	0,000	4,685	1,261
290	99,637	98,2411	7,500	5,600	0,000	4,900	1,284
295	99,726	98,2777	7,750	5,800	0,000	5,118	1,308
300	99,818	98,3144	8,000	6,000	0,000	5,340	1,333
305	99,909	98,3491	7,975	5,975	0,000	5,553	1,358
310	99,997	98,3800	7,950	5,950	0,000	5,745	1,382
315	100,082	98,4076	7,925	5,925	0,021	5,918	1,406
320	100,163	98,4321	7,900	5,900	0,058	6,073	1,430

Tablica 6. Dotok Q_{01} , Dotok Q_{02} , preljevni protok Q_{p1} , preljevni protok Q_{p2} i protok Q_1 za dužinu preljevnog praga $B_1=0,5$ (m) i $B_2=2$ (m) u ovisnosti o vremenu t

325	100,241	98,4539	7,875	5,875	0,105	6,212	1,453
330	100,315	98,4732	7,850	5,850	0,157	6,336	1,475
335	100,386	98,4903	7,825	5,825	0,213	6,447	1,497
340	100,454	98,5054	7,800	5,800	0,271	6,545	1,517
345	100,519	98,5187	7,775	5,775	0,331	6,632	1,537
350	100,580	98,5303	7,750	5,750	0,391	6,709	1,556
355	100,638	98,5406	7,725	5,725	0,452	6,776	1,574
360	100,694	98,5496	7,700	5,700	0,512	6,835	1,592
365	100,746	98,5574	7,675	5,675	0,571	6,887	1,608
370	100,796	98,5641	7,650	5,650	0,629	6,932	1,624
375	100,843	98,5699	7,625	5,625	0,686	6,970	1,639
380	100,888	98,5749	7,600	5,600	0,741	7,003	1,653
385	100,930	98,5790	7,575	5,575	0,794	7,031	1,667
390	100,970	98,5826	7,550	5,550	0,846	7,055	1,679
395	101,007	98,5854	7,525	5,525	0,895	7,074	1,691
400	101,042	98,5878	7,500	5,500	0,943	7,089	1,703
405	101,075	98,5896	7,475	5,475	0,988	7,102	1,714
410	101,107	98,5909	7,450	5,450	1,031	7,111	1,724
415	101,136	98,5919	7,425	5,425	1,072	7,117	1,734
420	101,163	98,5924	7,400	5,400	1,111	7,121	1,743
425	101,189	98,5926	7,375	5,375	1,148	7,122	1,751
430	101,213	98,5925	7,350	5,350	1,183	7,122	1,759
435	101,235	98,5922	7,325	5,325	1,216	7,119	1,767
440	101,256	98,5915	7,300	5,300	1,247	7,115	1,774
445	101,275	98,5906	7,275	5,275	1,275	7,109	1,781
450	101,293	98,5895	7,250	5,250	1,302	7,102	1,787
455	101,309	98,5883	7,225	5,225	1,327	7,093	1,793
460	101,325	98,5868	7,200	5,200	1,351	7,083	1,799
465	101,339	98,5851	7,175	5,175	1,372	7,072	1,804
470	101,352	98,5833	7,150	5,150	1,392	7,060	1,809
475	101,363	98,5814	7,125	5,125	1,410	7,047	1,813
480	101,374	98,5793	7,100	5,100	1,427	7,033	1,817
485	101,384	98,5771	7,075	5,075	1,442	7,018	1,821
490	101,393	98,5748	7,050	5,050	1,456	7,003	1,825
495	101,400	98,5724	7,025	5,025	1,468	6,987	1,828
500	101,407	98,5698	7,000	5,000	1,479	6,970	1,831
505	101,413	98,5672	6,963	4,969	1,489	6,952	1,834
510	101,418	98,5643	6,925	4,938	1,496	6,933	1,836
515	101,422	98,5613	6,888	4,906	1,503	6,913	1,839
520	101,425	98,5581	6,850	4,875	1,508	6,892	1,841
525	101,428	98,5548	6,813	4,844	1,511	6,870	1,842
530	101,429	98,5513	6,775	4,813	1,513	6,847	1,844
535	101,429	98,5478	6,738	4,781	1,514	6,823	1,845
540	101,429	98,5441	6,700	4,750	1,514	6,799	1,846
545	101,428	98,5403	6,663	4,719	1,512	6,774	1,847
550	101,427	98,5364	6,625	4,688	1,510	6,748	1,848
555	101,424	98,5324	6,588	4,656	1,506	6,722	1,848
560	101,421	98,5284	6,550	4,625	1,501	6,696	1,849
565	101,418	98,5243	6,513	4,594	1,496	6,669	1,849
570	101,414	98,5201	6,475	4,563	1,489	6,641	1,849
575	101,409	98,5158	6,438	4,531	1,482	6,613	1,849
580	101,404	98,5115	6,400	4,500	1,473	6,585	1,849
585	101,398	98,5071	6,363	4,469	1,464	6,556	1,848
590	101,392	98,5027	6,325	4,438	1,455	6,527	1,848
595	101,385	98,4982	6,288	4,406	1,444	6,498	1,847
600	101,378	98,4936	6,250	4,375	1,433	6,469	1,846
605	101,371	98,4890	6,213	4,344	1,422	6,439	1,845
610	101,363	98,4844	6,175	4,313	1,409	6,409	1,844
615	101,355	98,4798	6,138	4,281	1,397	6,379	1,843
620	101,346	98,4750	6,100	4,250	1,383	6,348	1,842
625	101,337	98,4703	6,063	4,219	1,370	6,318	1,840
630	101,328	98,4655	6,025	4,188	1,355	6,287	1,839
635	101,318	98,4607	5,988	4,156	1,341	6,256	1,837
640	101,308	98,4558	5,950	4,125	1,326	6,225	1,836

Tablica 6 (nastavak). Dotok Q_{01} , Dotok Q_{02} , preljevni protok Q_{p1} , preljevni protok Q_{p2} i protok Q_1 za dužinu preljevnog praga $B_1=0,5$ (m) i $B_2=2$ (m) u ovisnosti o vremenu t

645	101,298	98,4510	5,913	4,094	1,310	6,193	1,834
650	101,288	98,4461	5,875	4,063	1,295	6,162	1,832
655	101,277	98,4411	5,838	4,031	1,279	6,130	1,831
660	101,266	98,4361	5,800	4,000	1,262	6,099	1,829
665	101,255	98,4311	5,763	3,969	1,245	6,067	1,827
670	101,244	98,4261	5,725	3,938	1,228	6,035	1,825
675	101,232	98,4211	5,688	3,906	1,211	6,003	1,822
680	101,220	98,4160	5,650	3,875	1,194	5,971	1,820
685	101,208	98,4109	5,613	3,844	1,176	5,939	1,818
690	101,196	98,4058	5,575	3,813	1,158	5,906	1,816
695	101,183	98,4006	5,538	3,781	1,140	5,874	1,813
700	101,171	98,3955	5,500	3,750	1,122	5,841	1,811
705	101,158	98,3903	5,463	3,719	1,104	5,809	1,808
710	101,145	98,3851	5,425	3,688	1,085	5,776	1,806
715	101,132	98,3798	5,388	3,656	1,067	5,743	1,803
720	101,119	98,3746	5,350	3,625	1,048	5,711	1,801
725	101,105	98,3693	5,313	3,594	1,029	5,678	1,798
730	101,092	98,3640	5,275	3,563	1,010	5,645	1,795
735	101,078	98,3587	5,238	3,531	0,991	5,612	1,792
740	101,064	98,3533	5,200	3,500	0,972	5,579	1,790
745	101,050	98,3480	5,163	3,469	0,953	5,546	1,787
750	101,036	98,3426	5,125	3,438	0,934	5,513	1,784
755	101,022	98,3372	5,088	3,406	0,915	5,480	1,781
760	101,007	98,3318	5,050	3,375	0,896	5,446	1,778
765	100,993	98,3264	5,013	3,344	0,876	5,413	1,775
770	100,978	98,3209	4,975	3,313	0,857	5,380	1,772
775	100,964	98,3155	4,938	3,281	0,838	5,346	1,769
780	100,949	98,3100	4,900	3,250	0,819	5,313	1,766
785	100,934	98,3045	4,863	3,219	0,799	5,279	1,763
790	100,919	98,2989	4,825	3,188	0,780	5,246	1,759
795	100,904	98,2934	4,788	3,156	0,761	5,212	1,756
800	100,889	98,2879	4,750	3,125	0,742	5,179	1,753
805	100,873	98,2823	4,713	3,094	0,723	5,145	1,750
810	100,858	98,2767	4,675	3,063	0,704	5,112	1,746
815	100,842	98,2711	4,638	3,031	0,685	5,078	1,743
820	100,827	98,2654	4,600	3,000	0,666	5,044	1,740
825	100,811	98,2598	4,563	2,969	0,647	5,011	1,736
830	100,795	98,2541	4,525	2,938	0,628	4,977	1,733
835	100,779	98,2484	4,488	2,906	0,610	4,943	1,729
840	100,763	98,2427	4,450	2,875	0,591	4,909	1,726
845	100,747	98,2370	4,413	2,844	0,572	4,875	1,722
850	100,731	98,2313	4,375	2,813	0,554	4,842	1,719
855	100,715	98,2255	4,338	2,781	0,536	4,808	1,715
860	100,699	98,2198	4,300	2,750	0,518	4,774	1,711
865	100,682	98,2140	4,263	2,719	0,499	4,740	1,708
870	100,666	98,2082	4,225	2,688	0,481	4,706	1,704
875	100,649	98,2023	4,188	2,656	0,464	4,672	1,700
880	100,633	98,1965	4,150	2,625	0,446	4,638	1,697
885	100,616	98,1906	4,113	2,594	0,428	4,604	1,693
890	100,599	98,1847	4,075	2,563	0,411	4,570	1,689
895	100,583	98,1788	4,038	2,531	0,394	4,535	1,685
900	100,566	98,1729	4,000	2,500	0,377	4,501	1,681
905	100,549	98,1671	3,967	2,483	0,360	4,468	1,677
910	100,532	98,1615	3,933	2,467	0,343	4,436	1,673
915	100,515	98,1561	3,900	2,450	0,327	4,405	1,669
920	100,498	98,1509	3,867	2,433	0,311	4,375	1,665
925	100,481	98,1459	3,833	2,417	0,295	4,346	1,661
930	100,464	98,1409	3,800	2,400	0,280	4,318	1,657
935	100,447	98,1361	3,767	2,383	0,264	4,291	1,652
940	100,430	98,1314	3,733	2,367	0,249	4,265	1,648
945	100,413	98,1268	3,700	2,350	0,235	4,239	1,643
950	100,395	98,1223	3,667	2,333	0,220	4,213	1,639
955	100,378	98,1179	3,633	2,317	0,206	4,188	1,634
960	100,361	98,1135	3,600	2,300	0,192	4,164	1,630

Tablica 6 (nastavak). Dotok Q_{01} , Dotok Q_{02} , preljevni protok Q_{p1} , preljevni protok Q_{p2} i protok Q_1 za dužinu preljevnog praga $B_1=0,5$ (m) i $B_2=2$ (m) u ovisnosti o vremenu t

965	100,344	98,1092	3,567	2,283	0,179	4,139	1,625
970	100,327	98,1049	3,533	2,267	0,166	4,116	1,620
975	100,310	98,1007	3,500	2,250	0,153	4,092	1,615
980	100,293	98,0965	3,467	2,233	0,140	4,069	1,611
985	100,275	98,0923	3,433	2,217	0,128	4,045	1,606
990	100,258	98,0882	3,400	2,200	0,116	4,023	1,601
995	100,241	98,0841	3,367	2,183	0,105	4,000	1,596
1000	100,223	98,0800	3,333	2,167	0,093	3,977	1,591
1005	100,206	98,0759	3,300	2,150	0,083	3,955	1,586
1010	100,188	98,0719	3,267	2,133	0,072	3,932	1,581
1015	100,171	98,0678	3,233	2,117	0,063	3,910	1,576
1020	100,153	98,0638	3,200	2,100	0,053	3,888	1,571
1025	100,135	98,0598	3,167	2,083	0,044	3,866	1,566
1030	100,118	98,0557	3,133	2,067	0,036	3,844	1,561
1035	100,100	98,0517	3,100	2,050	0,028	3,822	1,556
1040	100,082	98,0477	3,067	2,033	0,021	3,800	1,550
1045	100,064	98,0437	3,033	2,017	0,014	3,778	1,545
1050	100,046	98,0396	3,000	2,000	0,009	3,756	1,540
1055	100,028	98,0356	2,967	1,983	0,004	3,734	1,534
1060	100,010	98,0315	2,933	1,967	0,001	3,713	1,529
1065	99,991	98,0275	2,900	1,950	0,000	3,691	1,523
1070	99,973	98,0234	2,867	1,933	0,000	3,669	1,517
1075	99,954	98,0194	2,833	1,917	0,000	3,647	1,512
1080	99,935	98,0153	2,800	1,900	0,000	3,625	1,506
1085	99,916	98,0112	2,767	1,883	0,000	3,603	1,500
1090	99,897	98,0071	2,733	1,867	0,000	3,581	1,494
1095	99,878	98,0030	2,700	1,850	0,000	3,560	1,488
1100	99,859	97,9989	2,667	1,833	0,000	3,538	1,482
1105	99,839	97,9947	2,633	1,817	0,000	3,516	1,476
1110	99,820	97,9906	2,600	1,800	0,000	3,494	1,470
1115	99,800	97,9864	2,567	1,783	0,000	3,472	1,464
1120	99,780	97,9822	2,533	1,767	0,000	3,449	1,457
1125	99,760	97,9780	2,500	1,750	0,000	3,427	1,451
1130	99,740	97,9738	2,467	1,733	0,000	3,405	1,445
1135	99,720	97,9695	2,433	1,717	0,000	3,383	1,438
1140	99,700	97,9653	2,400	1,700	0,000	3,361	1,432
1145	99,680	97,9610	2,367	1,683	0,000	3,338	1,425
1150	99,659	97,9567	2,333	1,667	0,000	3,316	1,418
1155	99,639	97,9524	2,300	1,650	0,000	3,294	1,411
1160	99,618	97,9481	2,267	1,633	0,000	3,271	1,405
1165	99,598	97,9437	2,233	1,617	0,000	3,249	1,398
1170	99,577	97,9393	2,200	1,600	0,000	3,226	1,391
1175	99,556	97,9349	2,167	1,583	0,000	3,203	1,384
1180	99,535	97,9305	2,133	1,567	0,000	3,181	1,377
1185	99,514	97,9261	2,100	1,550	0,000	3,158	1,369
1190	99,493	97,9216	2,067	1,533	0,000	3,135	1,362
1195	99,472	97,9172	2,033	1,517	0,000	3,112	1,355
1200	99,450	97,9127	2,000	1,500	0,000	3,090	1,348
1205	99,429	97,9083	2,000	1,500	0,000	3,067	1,340
1210	99,409	97,9042	2,000	1,500	0,000	3,047	1,333
1215	99,389	97,9003	2,000	1,500	0,000	3,027	1,326
1220	99,369	97,8967	2,000	1,500	0,000	3,009	1,319
1225	99,351	97,8932	2,000	1,500	0,000	2,991	1,312
1230	99,332	97,8899	2,000	1,500	0,000	2,975	1,305
1235	99,315	97,8869	2,000	1,500	0,000	2,960	1,299
1240	99,297	97,8839	2,000	1,500	0,000	2,945	1,292
1245	99,280	97,8811	2,000	1,500	0,000	2,931	1,286
1250	99,264	97,8785	2,000	1,500	0,000	2,918	1,279
1255	99,248	97,8759	2,000	1,500	0,000	2,905	1,273
1260	99,233	97,8735	2,000	1,500	0,000	2,893	1,267
1265	99,218	97,8712	2,000	1,500	0,000	2,882	1,261
1270	99,203	97,8690	2,000	1,500	0,000	2,871	1,255
1275	99,189	97,8669	2,000	1,500	0,000	2,860	1,249
1280	99,175	97,8648	2,000	1,500	0,000	2,850	1,244
1285	99,162	97,8629	2,000	1,500	0,000	2,840	1,238
1290	99,148	97,8610	2,000	1,500	0,000	2,831	1,233
1295	99,136	97,8592	2,000	1,500	0,000	2,822	1,228
1300	99,123	97,8575	2,000	1,500	0,000	2,814	1,223

Tablica 6 (nastavak). Dotok Q_{01} , Dotok Q_{02} , preljevni protok Q_{p1} , preljevni protok Q_{p2} i protok Q_1 za dužinu preljevnog praga $B_1=0,5$ (m) i $B_2=2$ (m) u ovisnosti o vremenu t

3.3. Grafički prikaz rezultata proračuna

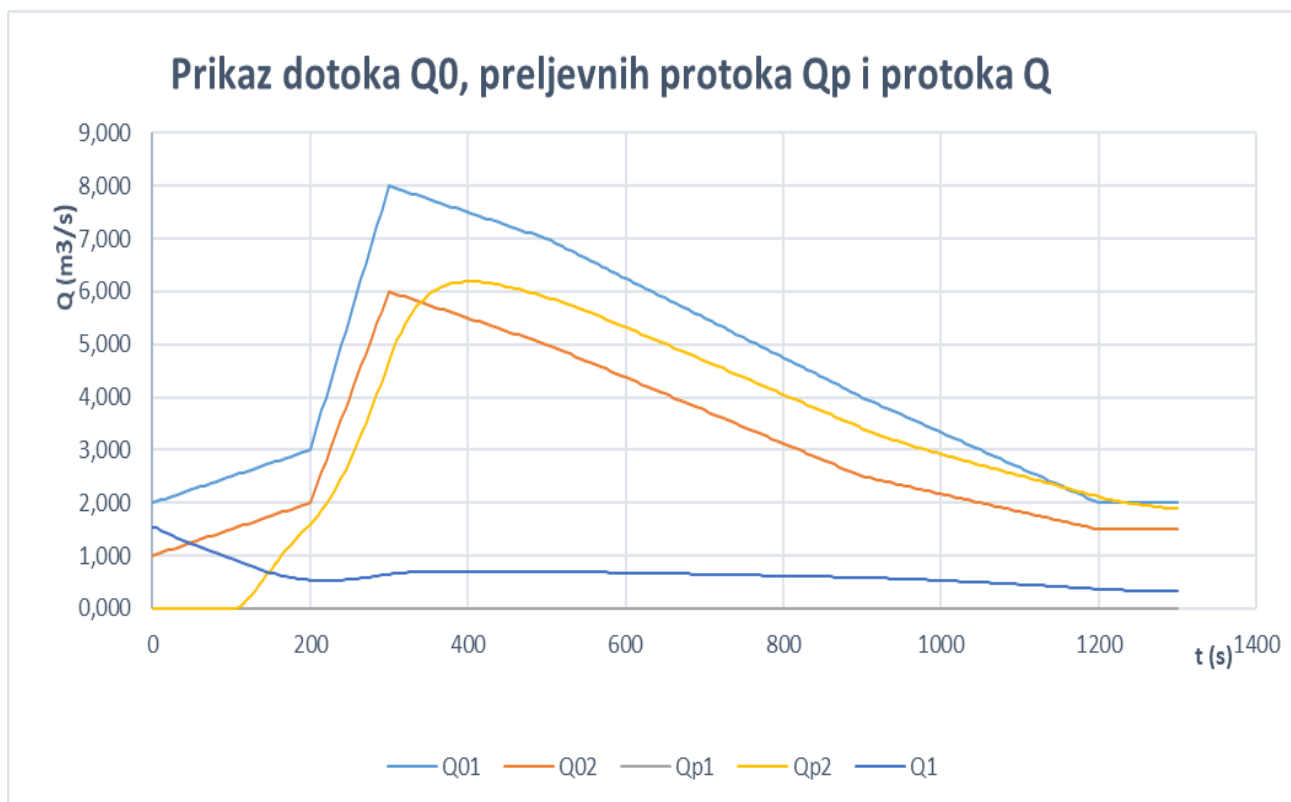
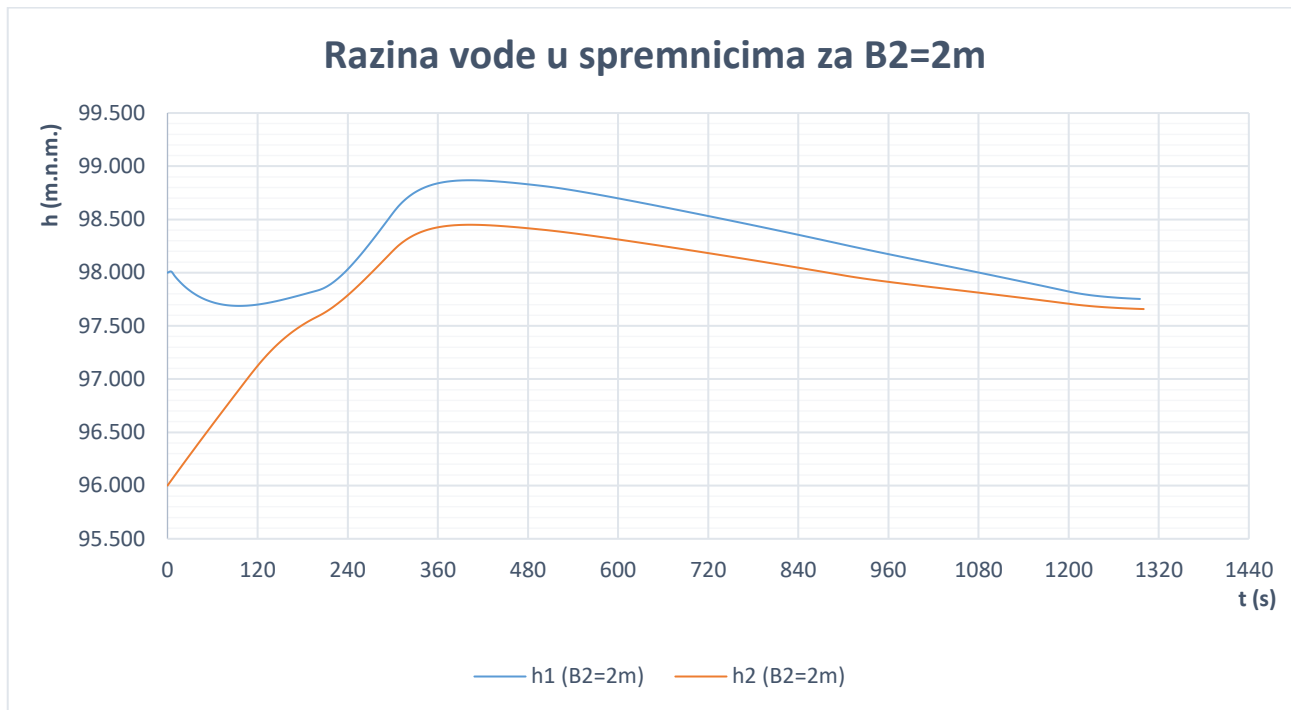

Razina vode u spremnicima za B2=4m

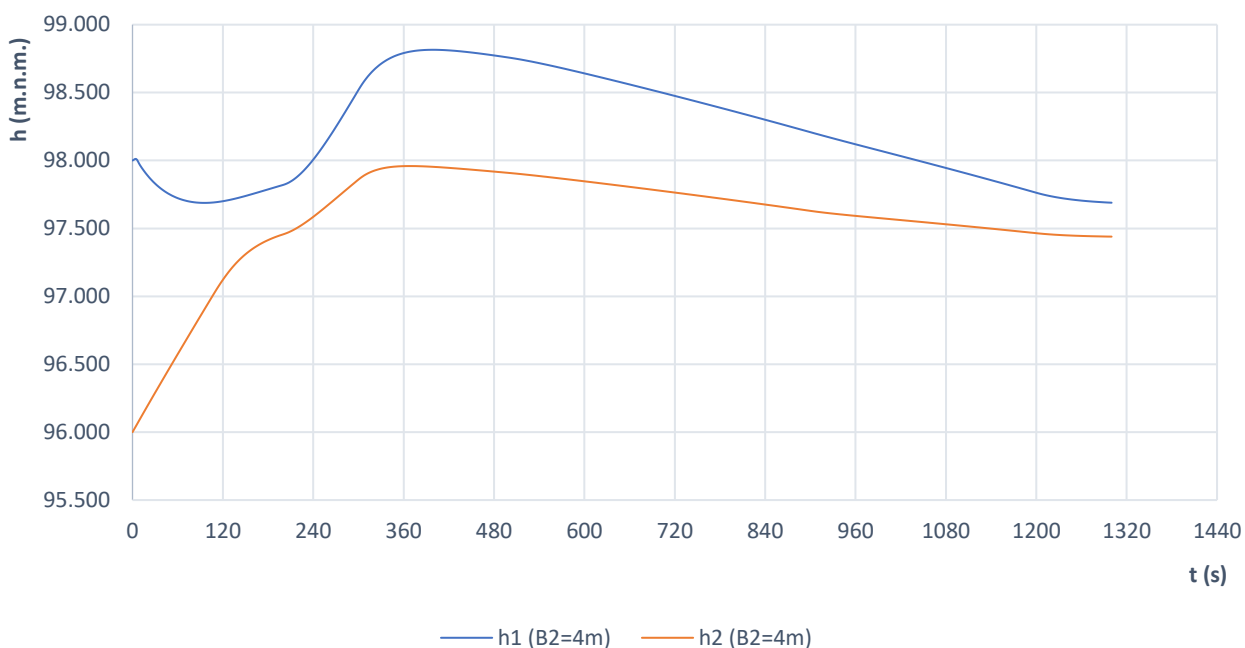

Prikaz dotoka Q0, preljevnih protoka Qp i protoka Q

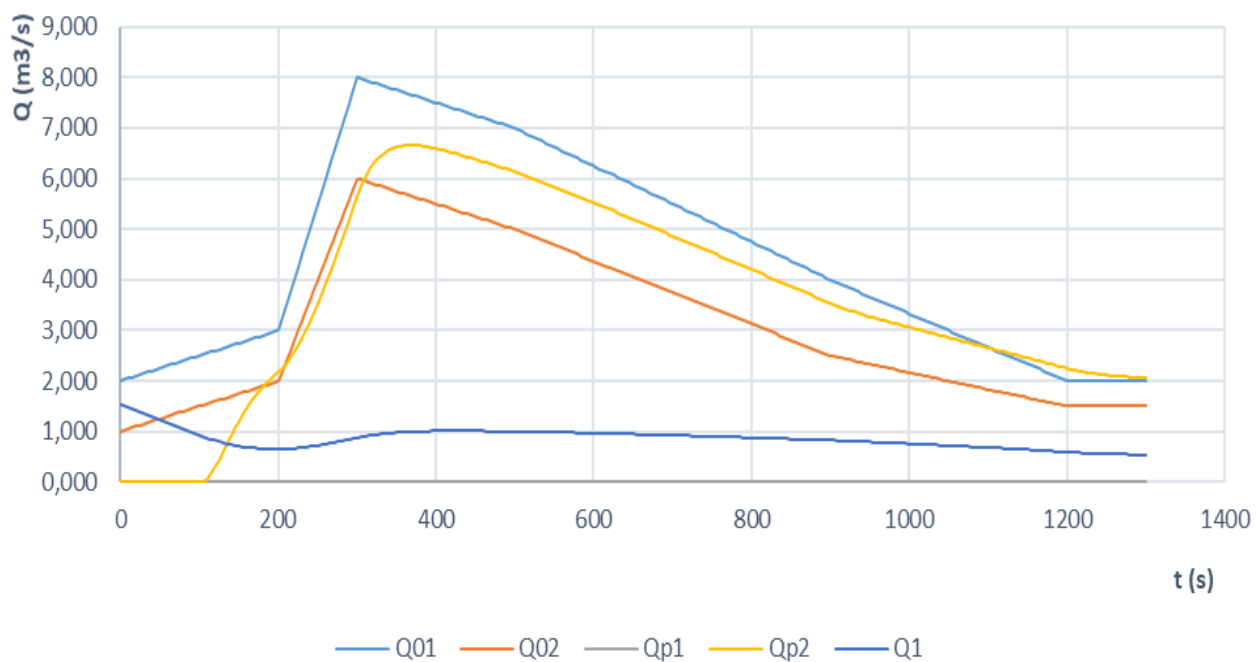

Razina vode u spremnicima za B2=6m

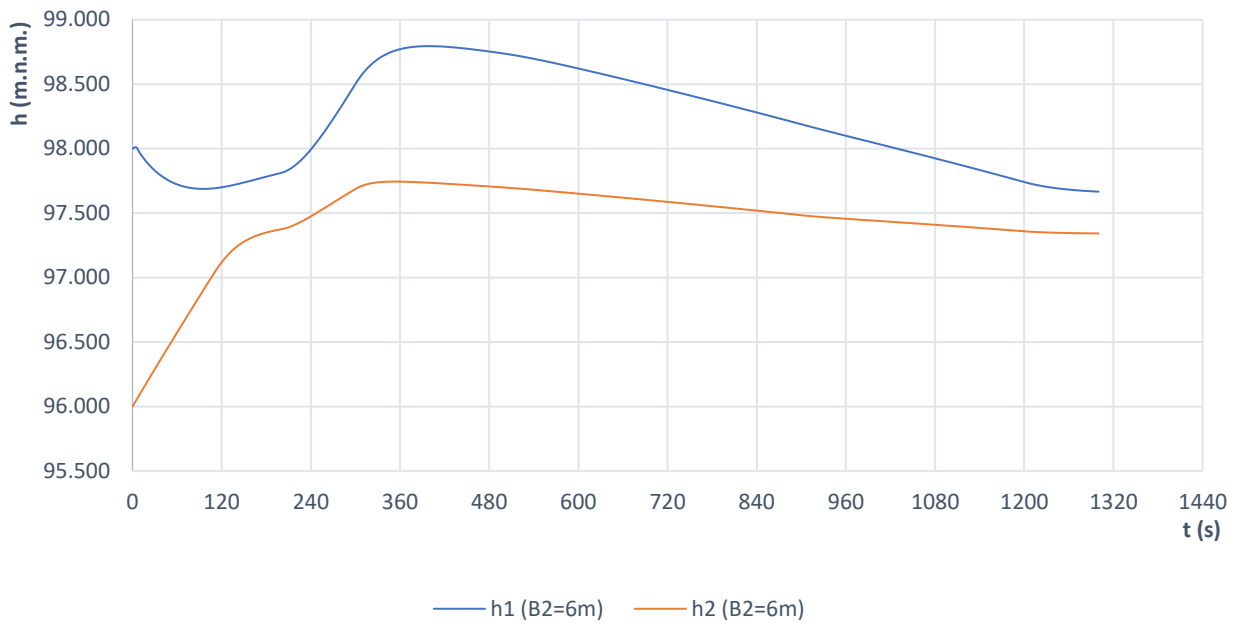

Prikaz dotoka QO, preljevnih protoka Qp i protoka Q

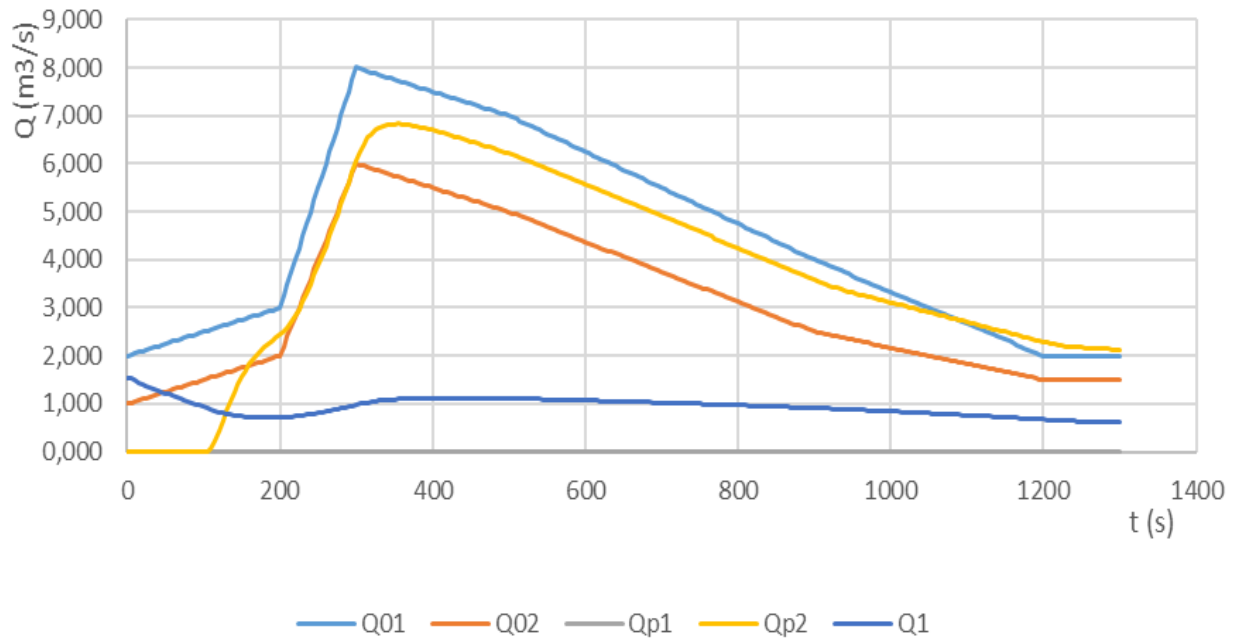

Razina vode u spremnicima za B1=2m i B2=4m

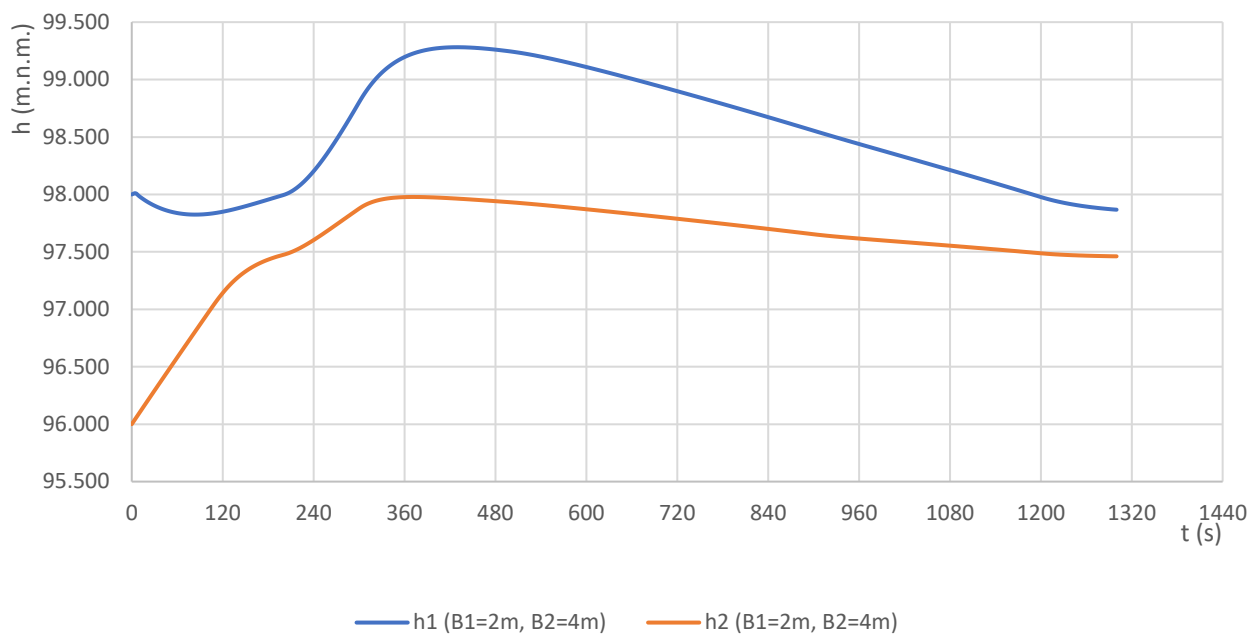

Prikaz dotoka Q0, preljevnih protoka Qp i protoka Q

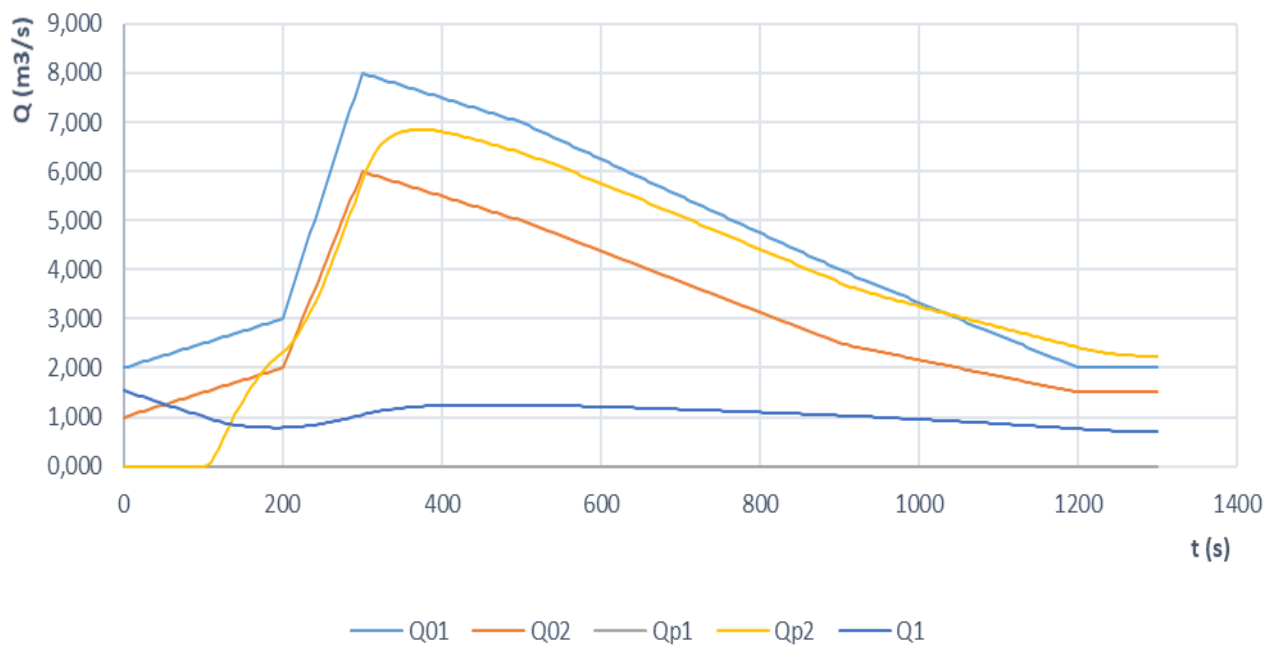

Razina vode u spremnicima za B1=1m i B2=4m

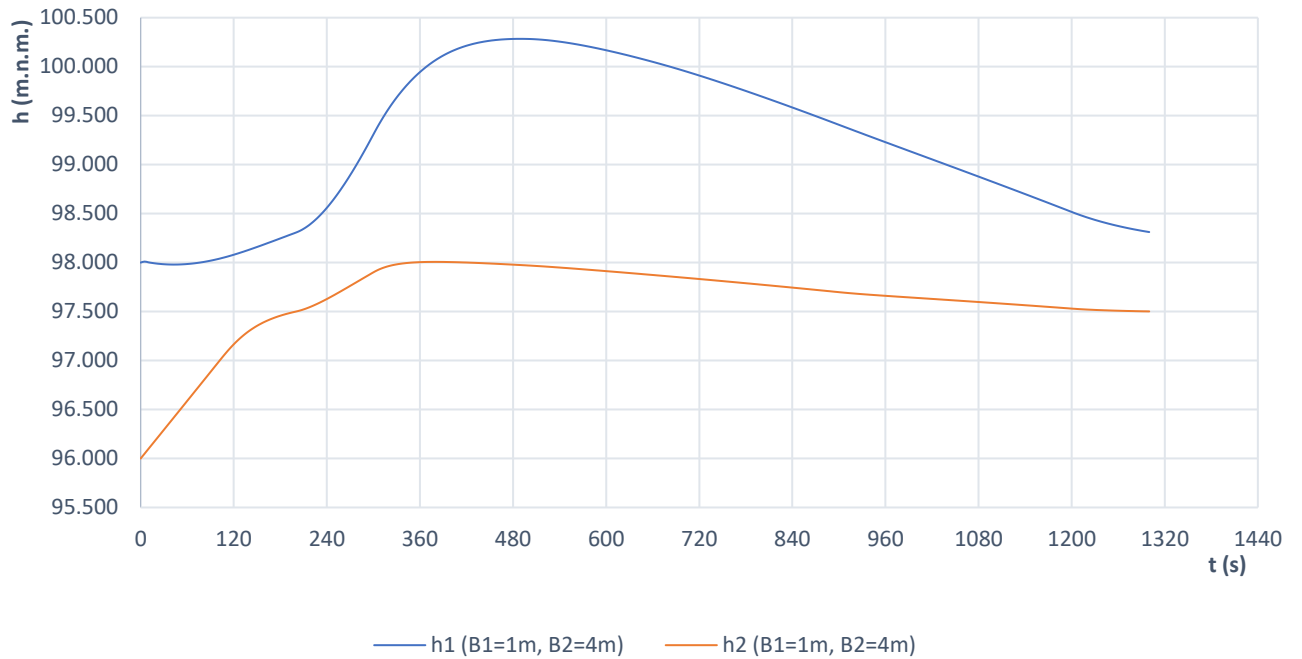

Prikaz dotoka Q01, preljevni protoka Qp i protoka Q

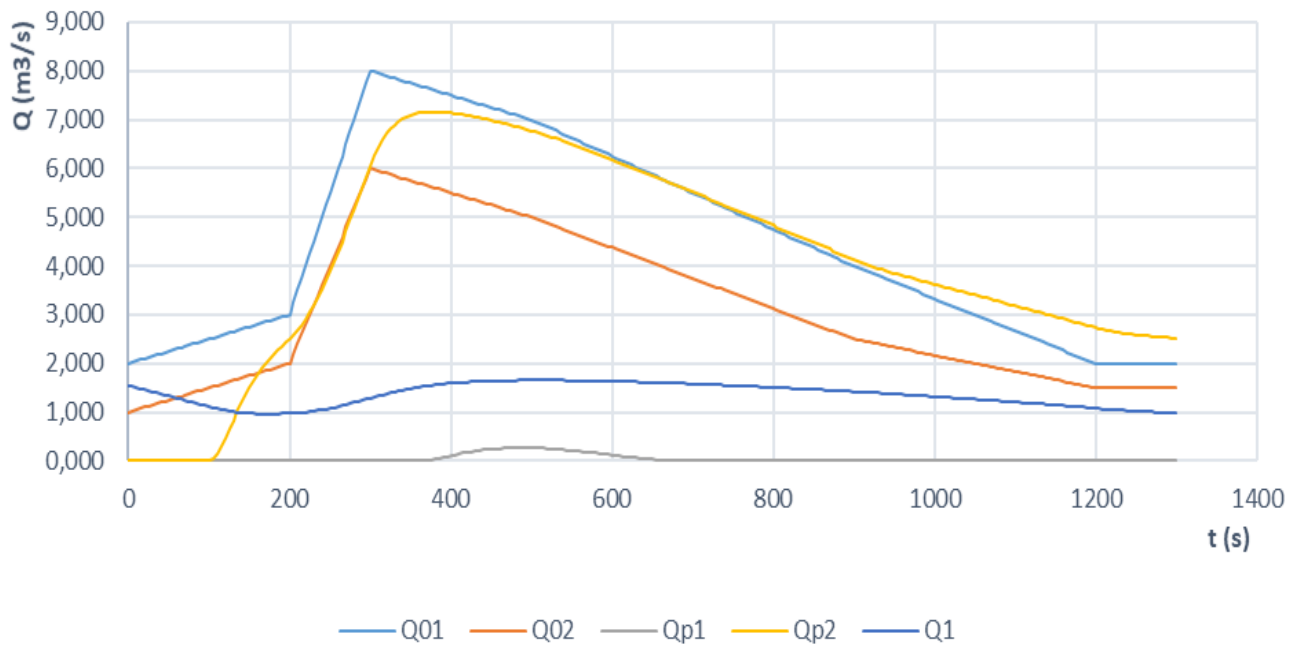

Razina vode u spremnicima za B1=0,5m i B2=2m

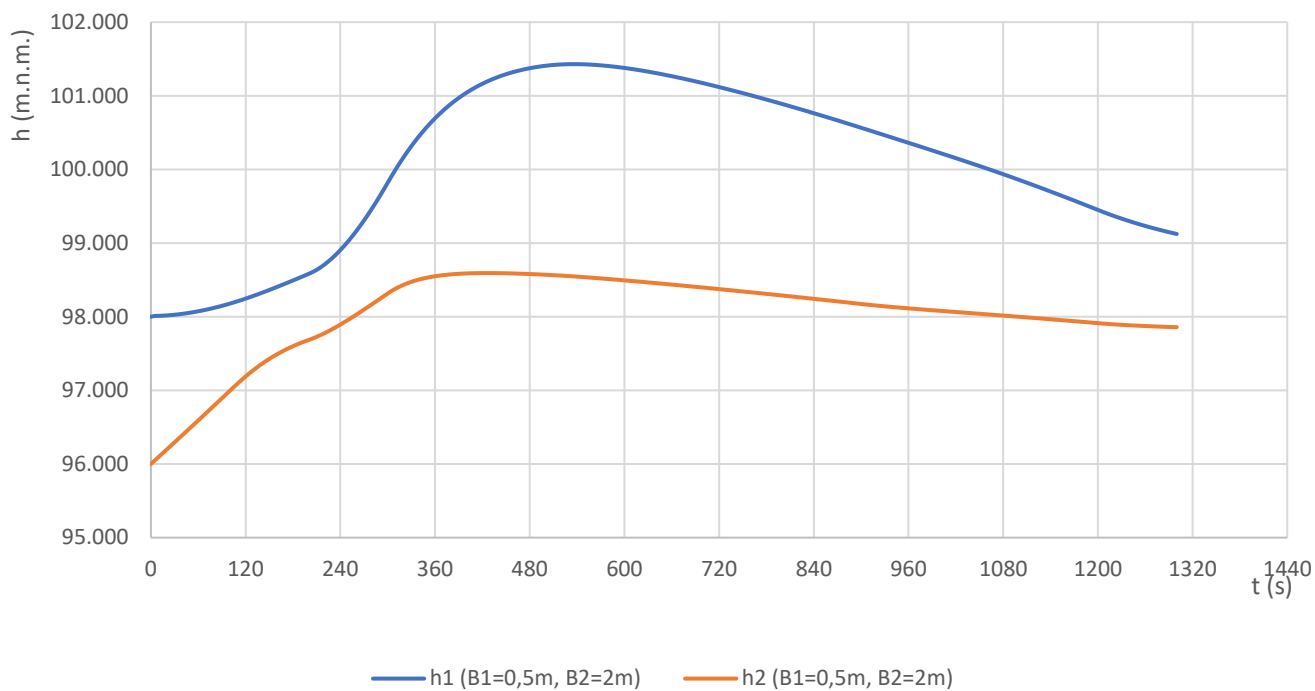

Prikaz dotoka Q0, preljevnih protoka Qp i protoka Q

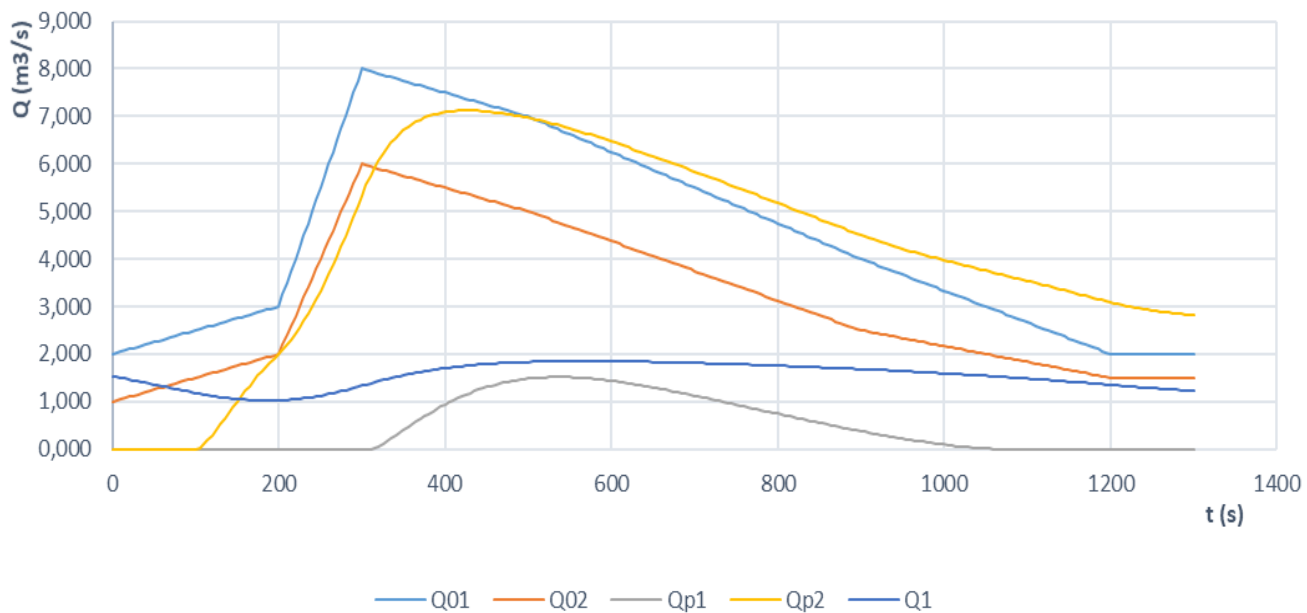

4. ZAKLJUČAK:

Na temelju rezultata proračuna vodnog lica Bernoullijevom jednačbom te pomoću integracije diferencijalne jednačbe vodnog lica, te usporedbom njihovih dijagrama, uočava se da se razlikuju u vrijednostima do nekoliko milimetara. Rezultati proračuna vodnog lica pomoću integracije diferencijalne jednačbe vodnog lica mogu se smatrati točnijima od izračunatog vodnog lica pomoću Bernoullijeve jednačbe.

Razlog je u tome što diferencijalna jednačba vodnog lica uzima u obzir i dodatne otpore u proračun koji nastaju od širenja ili sužavanja kanala, te zato daju točniji prikaz vodnog lica nego što je to kod primjene Bernoullijeve jednačbe. Ipak su razlike u izračunatim dubinama svega nekoliko milimetara.

5. LITERATURA

- [1] D. Bojanić; Hidromehanika, predavanja
- [2] V. Jović; Osnove hidromehanike
- [3] G. Lončar; Mehanika tekućina, skripta
- [4] A. Karač, Numeričke metode u inženjerstvu
- [5] G. Gjetvaj, Hidraulika, skripta
- [6] I. Kolar, G.Volf, Elvis Žic; Analiza protočnosti kanala različitih oblika poprečnih presjeka i obloženosti, stručni rad