

Proračun stambeno poslovne zgrade - ogledni primjer prema EC2

Deur, Luciana

Undergraduate thesis / Završni rad

2021

Degree Grantor / Ustanova koja je dodijelila akademski / stručni stupanj:

University of Split, Faculty of Civil Engineering, Architecture and Geodesy / Sveučilište u Splitu, Fakultet građevinarstva, arhitekture i geodezije

Permanent link / Trajna poveznica: <https://um.nsk.hr/um:nbn:hr:123:648842>

Rights / Prava: [In copyright](#)/[Zaštićeno autorskim pravom.](#)

Download date / Datum preuzimanja: **2024-11-28**



Repository / Repozitorij:

[FCEAG Repository - Repository of the Faculty of Civil Engineering, Architecture and Geodesy, University of Split](#)



UNIVERSITY OF SPLIT



DIGITALNI AKADEMSKI ARHIVI I REPOZITORIJI

**SVEUČILIŠTE U SPLITU
FAKULTET GRAĐEVINARSTVA, ARHITEKTURE I GEODEZIJE**

ZAVRŠNI RAD

Luciana Deur

Split, 2021.

**SVEUČILIŠTE U SPLITU
FAKULTET GRAĐEVINARSTVA, ARHITEKTURE I GEODEZIJE**

**Proračun stambeno poslovne zgrade – ogledni primjer
prema EC2**

Završni rad

Split, 2021.

Proračun stambeno poslovne zgrade – ogledni primjer prema EC2

Sažetak:

U radu je prikazan idejni projekt stambeno poslovne zgrade. Građevina se sastoji od 6 katova. Građevina je izvedena u armiranom betonu monolitnom izvedbom s armirano - betonskim temeljima, zidovima, stupovima i gredama te armirano – betonskim pločama kao međukatnim konstrukcijama. Projekt se sastoji od tehničkog opisa, proračuna nosivih elemenata konstrukcije te od karakterističnih građevinskih nacрта.

Ključne riječi: stambeno poslovna zgrada, armirano betonska konstrukcija, idejni projekt, ploče, grede

Calculation of business and residential building – illustrative example according to EC2

Abstract:

Conceptual design of the business and residential building is presented in this work.

The construction is composed of six floors.

The building is made of reinforced concrete in solid construction with reinforced concrete foundations, walls, columns and beams and reinforced concrete plates as floor slabs.

The projekt includes; a technical descriptions of the construction, calculation of the bearing structural elements and characteristic constructions design.

Keywords: business and residential building, reinforced concrete structure, conceptual desing, plates, beams

**SVEUČILIŠTE U SPLITU
FAKULTET GRAĐEVINARSTVA, ARHITEKTURE I GEODEZIJE**

Split, Matice hrvatske 15

STUDIJ: PREDDIPLOMSKI STRUČNI STUDIJ GRAĐEVINARSTVA

KANDIDAT: Luciana Deur

MATIČNI BROJ (JMBAG): 0083224982

KATEDRA: Katedra za betonske konstrukcije i mostove

PREDMET: Betonske konstrukcije 2

ZADATAK ZA ZAVRŠNI RAD

Tema: Proračun stambeno poslovne zgrade – ogledni primjer prema EC2

Opis zadatka: Na temelju danih arhitektonski podloga iz oglednog primjerka prema EC2, potrebno je izgraditi proračun stambeno poslovne zgrade. Izrađeni proračun mora sadržavati:

- tehnički opis
- proračune
- građevinske nacрте

U Splitu, travanj 2021.

Voditelj Završnog rada:

Dr. dr. sc. Nikola Grgić

Komentor:

Doc. dr. sc. Marina Sunara

Sadržaj:

1.	TEHNIČKI OPIS	1
2.	ANALIZA OPTEREĆENJA	5
2.1.	Vlastita težina	5
2.2.	Pozicija 200 - krovna konstrukcija	5
2.3.	Pozicija 100 – međukatna konstrukcija	7
2.4.	Stubište.....	9
2.5.	Podest stubišta	9
3.	PRORAČUN PLOČA	10
3.1.	Proračun krovne ploče pozicije 200	10
3.1.1.	Momenti savijanja u ploči pozicije 200	10
3.1.2.	Granično stanje nosivosti	13
3.1.3.	Dimenzioniranje krovne ploče pozicije 200	14
3.1.4.	Kontrola graničnog stanja uporabljivosti	17
3.1.5.	Kontrola progiba.....	20
3.2.	Proračun međukatne ploče pozicije 100.....	23
3.2.1.	Momenti savijanja u ploči pozicije 100	23
3.2.2.	Granično stanje nosivosti	26
3.2.3.	Dimenzioniranje ploče pozicije 100	27
3.2.4.	Kontrola graničnog stanja uporabljivosti	29
3.2.5.	Kontrola progiba.....	32
4.	PRORAČUN GREDA.....	35
4.1.	Grede pozicije 200.....	35
4.1.1.	Dimenzioniranje na moment savijanje za gredu G206	36
4.1.2.	Dimenzioniranje na poprečnu silu za gredu G206	37
4.1.3.	Dimenzioniranje na moment savijanje za gredu G218	40
4.1.4.	Dimenzioniranje na poprečnu silu za gredu G218	41
4.1.5.	Kontrola graničnog stanja uporabljivosti	43
	Pukotine:	43
4.2.	Grede pozicije 100.....	46
4.2.1.	Dimenzioniranje na moment savijanje za gredu G120	47
4.2.2.	Dimenzioniranje na poprečnu silu za gredu G120	48
4.2.3.	Dimenzioniranje na moment savijanje za gredu G110	51
4.2.4.	Dimenzioniranje na poprečnu silu za gredu G110	52

4.2.5.	Kontrola graničnog stanja uporabljivosti	54
	Pukotine:	54
5.	DIMENZIONIRANJE STUBIŠTA.....	57
6.	REZULTATI DINAMIČKE ANALIZE	58
7.	PRORAČUN VERTIKALNIH ELEMENATA KONSTRUKCIJE.....	63
7.1.	Proračun stupova	63
7.1.1.	Dimenzioniranje stupova na moment savijanja i uzdužnu silu	68
7.1.2.	Dimenzioniranje na poprečnu silu.....	70
7.2.	PRORAČUN ZIDOVA.....	72
7.2.1.	Dimenzioniranje na poprečnu silu.....	76
8.	PRORAČUN TEMELJA.....	77
8.1.	Temelj samac.....	77
8.1.1.	Dimenzioniranje temelja samca	81
9.	NACRTI.....	83
9.1.	Armatura ploče pozicija 100 Donja zona M 1:100	83
9.2.	Iskaz materijala pozicija 100.....	83
9.3.	Armatura ploče pozicija 100 Gornja zona M 1:100.....	83
9.4.	Iskaz materijala pozicija 100.....	83
9.5.	Armatura ploče pozicija 200 Donja zona M 1:100	83
9.6.	Iskaz materijala pozicija 200.....	83
9.7.	Armatura ploče pozicije 200 Gornja zona – tlačna armature M 1:100.....	83
9.8.	Iskaz materijala pozicija 200	83
9.9.	Armatura ploče pozicija 200 Gornja zona M 1:100.....	83
9.10.	Iskaz materijala pozicija 200.....	83
9.11.	Armatura grede pozicije 206 M 1:20.....	83
9.12.	Armatura grede pozicije 218 M 1:20.....	83
9.13.	Armatura grede pozicije 110 M :20.....	83
9.14.	Armatura grede pozicije 120 M 1:20.....	83
9.15.	Armatura karakterističnog stupa M 1:20	83
9.16.	Armatura karakterističnog stupa M 1:20	83
9.17.	Temelj samac M 1:25	83
9.18.	Armatura stubišta M 1:20	83
10.	LITERATURA.....	84

1. TEHNIČKI OPIS

Predmet ovog završnog rada je proračun međukatnih i krovnih konstrukcija jedne armiranobetonske građevine zadanih tlocrtnih dimenzija 30.30m x 14.25m i zadane visine kata $H_1=3,52$ m i $H_2=2,52$ m. Građevina je stambeno poslovne namjene, a sastoji se od prizemlja i pet katova koji su povezani dvokrakim stubištem. Konstrukcija ploče katova je armirano betonska konstrukcija koja se izvodi lijevanjem na licu mjesta u oplati. Izrađena je od betona C 30/37, debljine 18cm. U proračunu su dane osnovne dimenzije i količine armature za pojedine konstruktivne elemente. Vertikalni nosivi sustavi viših katova i prizemlja čine armirano betonski zidovi debljine 30cm te stupovi u prizemlju konstrukcije kvadratnog poprečnog presjeka dimenzija 50/50cm. U konstruktivnom smislu građevina je armirano betonska konstrukcija. Krov konstrukcije će se izvesti kao ravni prohodni krov.

Temelji konstrukcije će se izvesti kao trakasti temelji ispod zidova.

Međukatne konstrukcije su armirano betonske ploče. Debljina ploče na svim katovima su jednake debljine i iznosi 18cm.

Građevina se nalazi na lokaciji koja prema važećim propisima spada u zonu za koju je zadano projektno ubrzanje tla $a_g= 0.22g$. Konstrukcija seizmičke sile preuzima sustavom armirano betonskih zidova i stupova. Građevina se nalazi na lokaciji koja prema važećim propisima spada u II. zonu opterećenja vjetrom. Predviđena armatura je B 500B (prema Tehničkim propisima za građevinske konstrukcije) za sve elemente, u obliku šipki ili mreža. Za sve betonske radove koristili smo beton C 30/37, osim kod izrade temelja gdje smo koristili beton C 25/30, a sve prema Tehničkim propisima za građevinske konstrukcije. Ovaj rad je izrađen uz korištenje literature (1-14).

Tlocrt objekta:

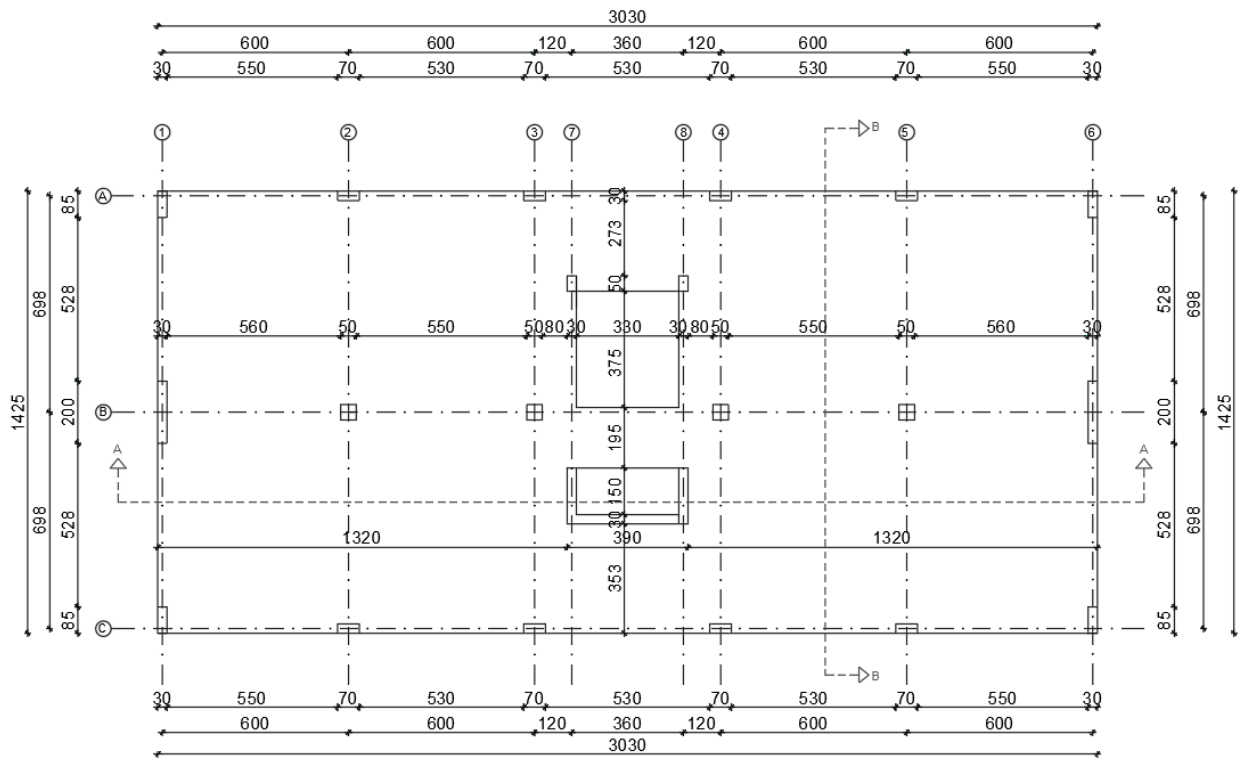

Slika 1.1. Tlocrt zgrade

Presjek A-A:

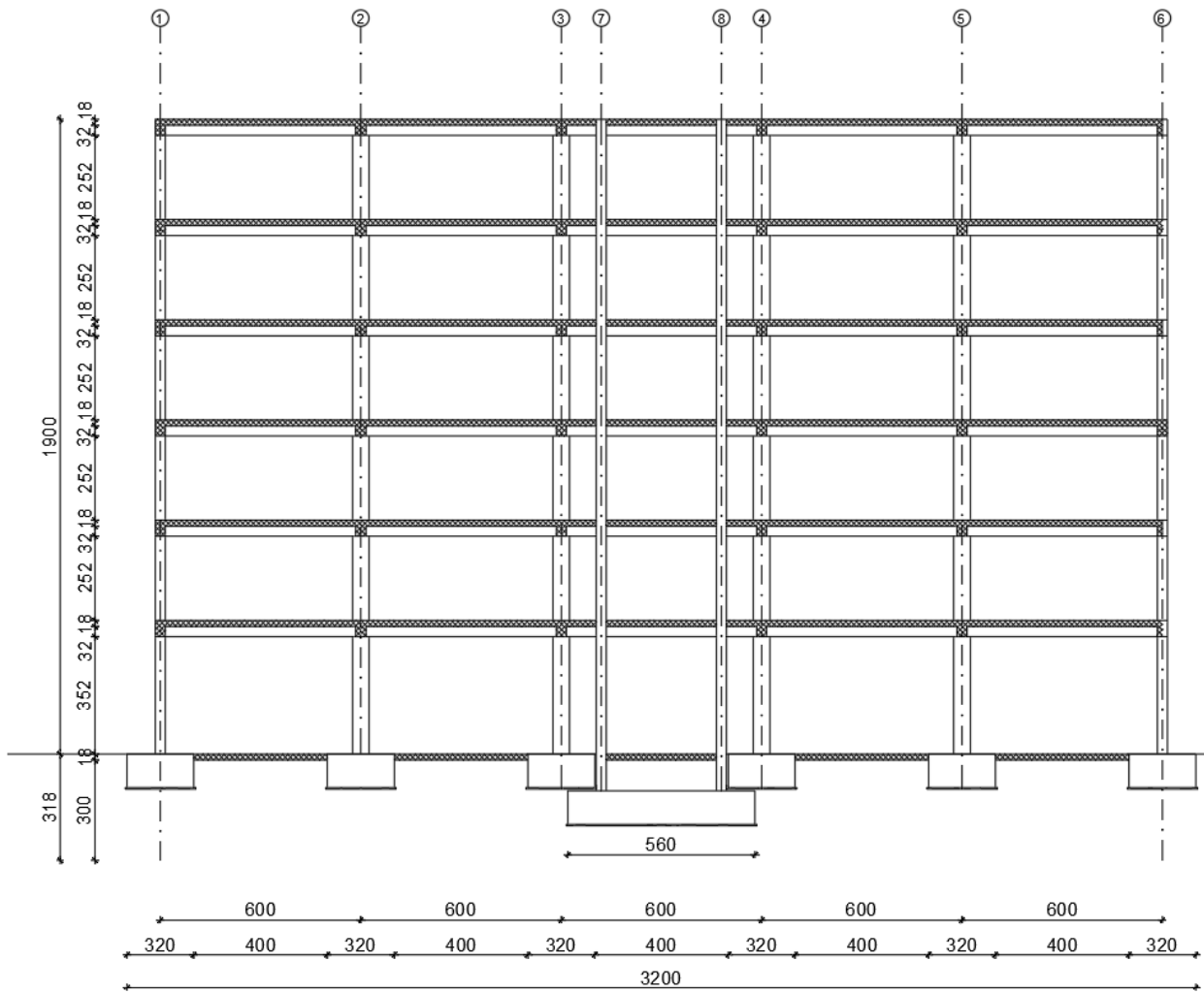

Slika 1.2. Presjek A-A

2. ANALIZA OPTEREĆENJA

2.1. Vlastita težina

Vlastita težina svih konstruktivnih elemenata je automatski uključena kroz računalni program za proračun i modeliranje konstrukcija Autodesk Robot Structural Analysis Professional.

2.2. Pozicija 200 - krovna konstrukcija

Stalno opterećenje

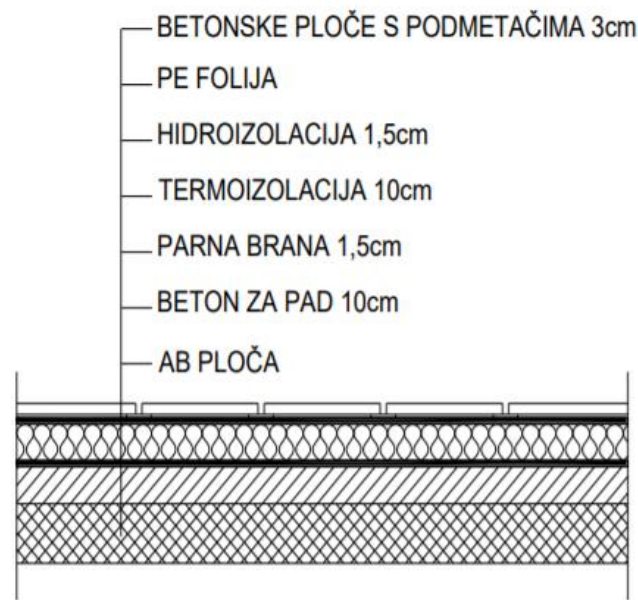

Slika 2.1 Presjek krovne ploče – prikaz slojeva

SLOJEVI RAVNOG KROVA	d(m)	g(kN/m ³)	d·g (kN/m ³)
Betonske ploče s podmetačima	0,03	25,0	0,75
PE folija	-	-	-
Hidroizolacija	0,015	20,0	0,3
Termoizolacija	0,1	2,0	0,2
Parna brana	0,015	0,2	0,00225
Beton za pad	0,1	24,0	2,4
AB ploča	uključena kroz računalni program		
UKUPNO DODATNO STALNO OPTEREĆENJE:			3,65 (kN/m²)

Tablica 2.1 Slojevi krovne ploče sa debljinama i jediničnim težinama

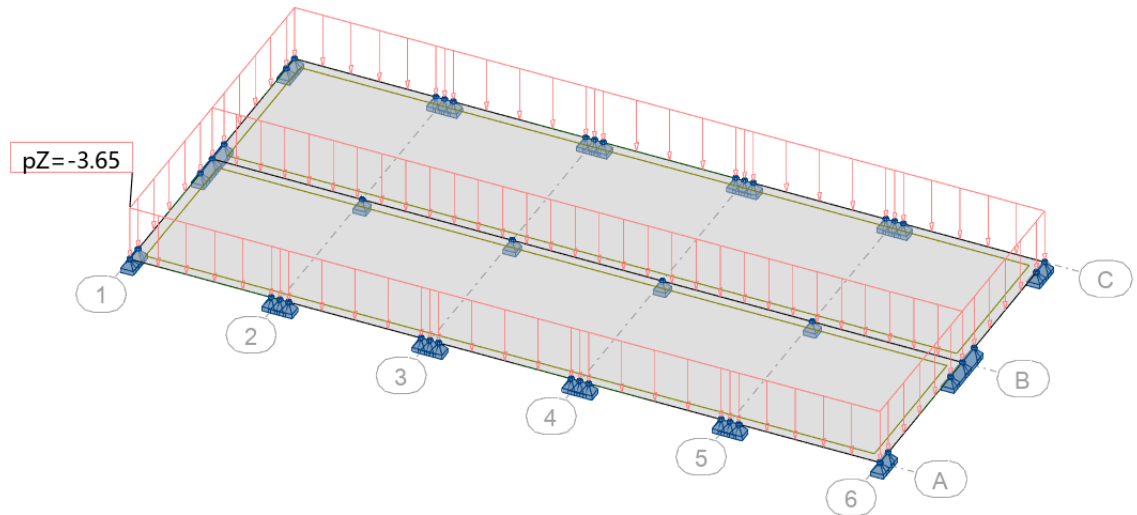
Prikaz opterećenja – dodatno stalno i promjenjivo opterećenje

Slika 2.2. Dodatno stalno opterećenje

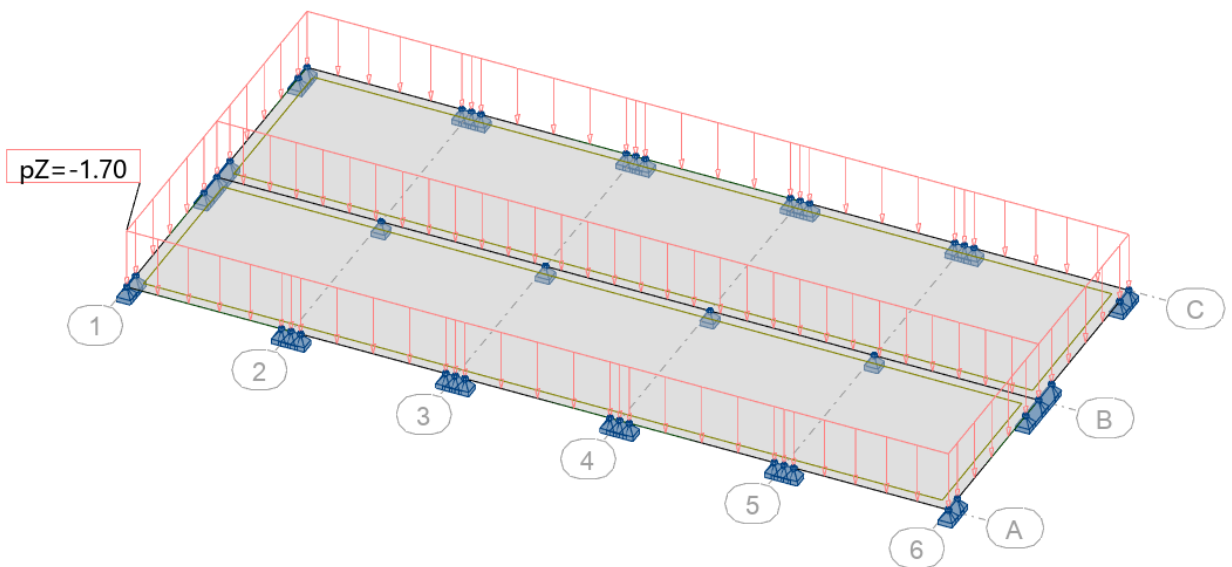

Slika 2.3. Promjenjivo opterećenje

2.3. Pozicija 100 – međukatna konstrukcija

Stalno opterećenje

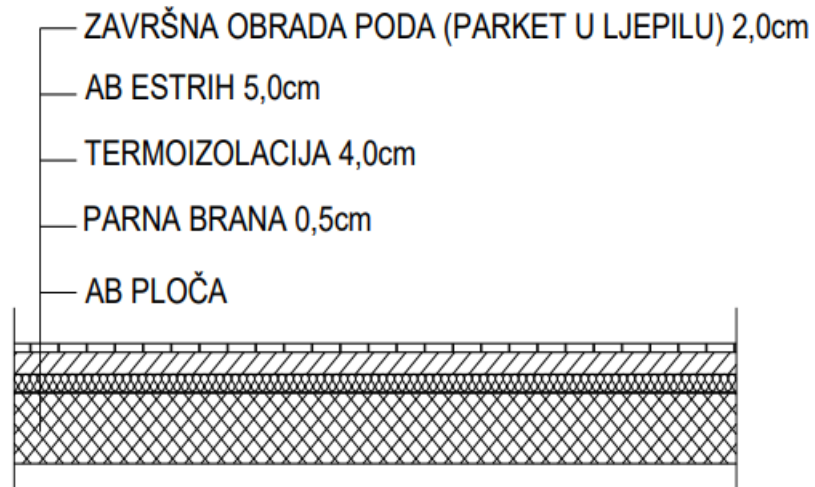

Slika 2.4. Presjek međukatne ploče – prikaz slojeva

SLOJEVI IZMEĐU KATOVA	d(m)	g(kN/m ³)	d·g (kN/m ²)
Završna obrada poda (parket)	0,02	12,0	0,24
Estrih	0,05	25,0	1,25
PE folija	-	-	-
Termoizolacija	0,04	2,0	0,08
Hidroizolacija + parna brana	0,005	20,0	0,1
Pregradni zidovi	1,0 kN/m ²		
AB ploča	uključena kroz računalni program		
UKUPNO DODATNO STALNO OPTEREĆENJE:			2,67 kN/m²

Tablica 2.2. Slojevi međukatne ploče sa debljinama i jediničnim težinama

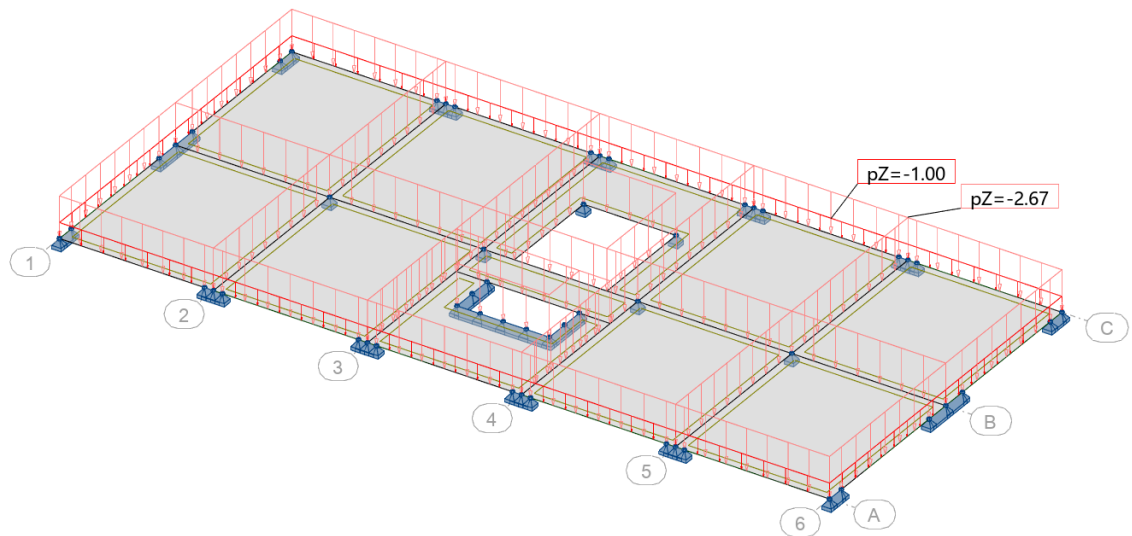
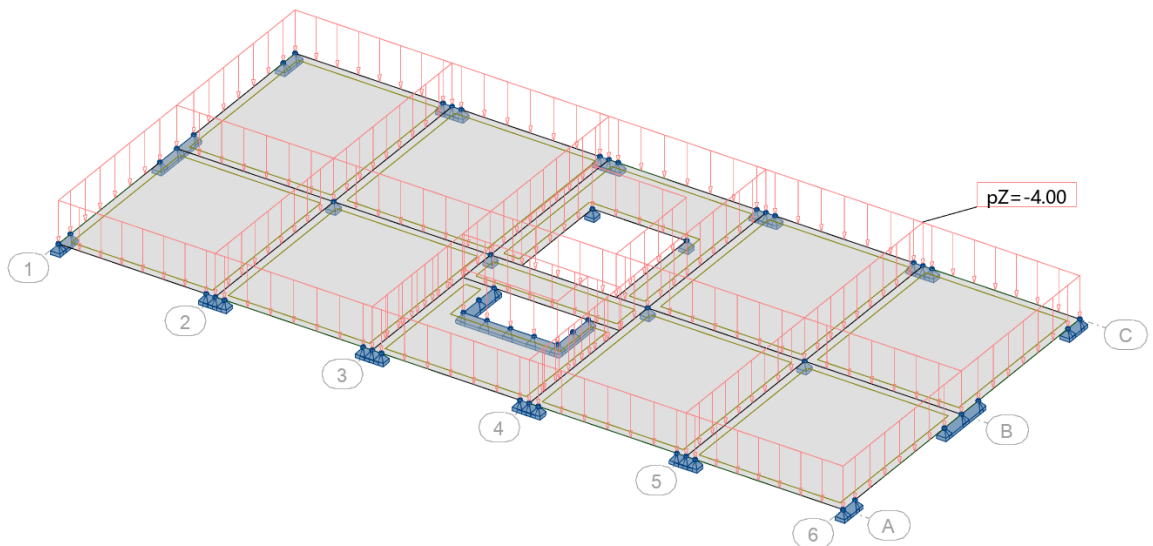
Prikaz opterećenja – dodatno stalno i promjenjivo opterećenje*Slika 2.5. Dodatno stalno opterećenje**Slika 2.6. Promjenjivo opterećenje*

2.4. Stubište

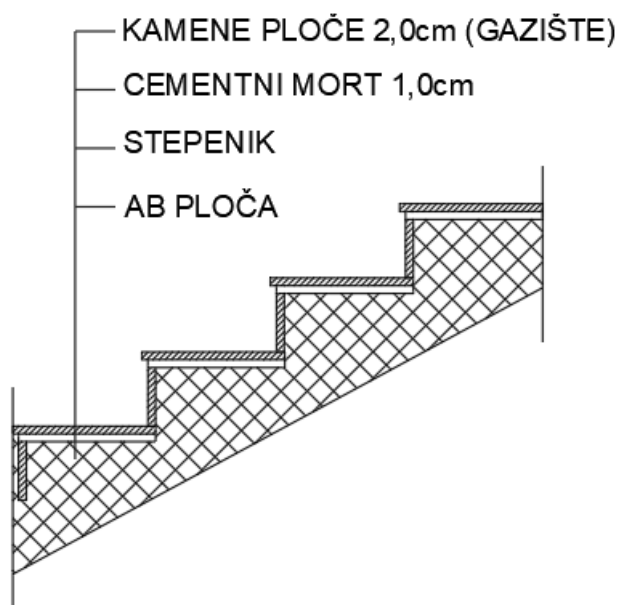

Slika 2.8. Presjek stubišta – prikaz slojeva

SLOJEVI PODA STUBIŠTA	d(m)	g(kN/m ³)	d·g (kN/m ²)
Kamene ploče (gazište)	0,02	28,0	0,56
Cementni mort	0,01	20,0	0,2
Stuba	0,05	24,0	1,2
AB ploča	uključena kroz računalni program		
UKUPNO DODATNO STALNO OPTEREĆENJE:			1,96 kN/m²

2.5. Podest stubišta

SLOJEVI PODESTA STUBIŠTA	d(m)	g(kN/m ³)	d·g (kN/m ²)
Kamene ploče (gazište)	0,02	28,0	0,56
Cementni mort	0,01	20,0	0,2
AB ploča	uključena kroz računalni program		
UKUPNO DODATNO STALNO OPTEREĆENJE:			0,76 kN/m²

3. PRORAČUN PLOČA

3.1. Proračun krovne ploče pozicije 200

3.1.1. Momenti savijanja u ploči pozicije 200

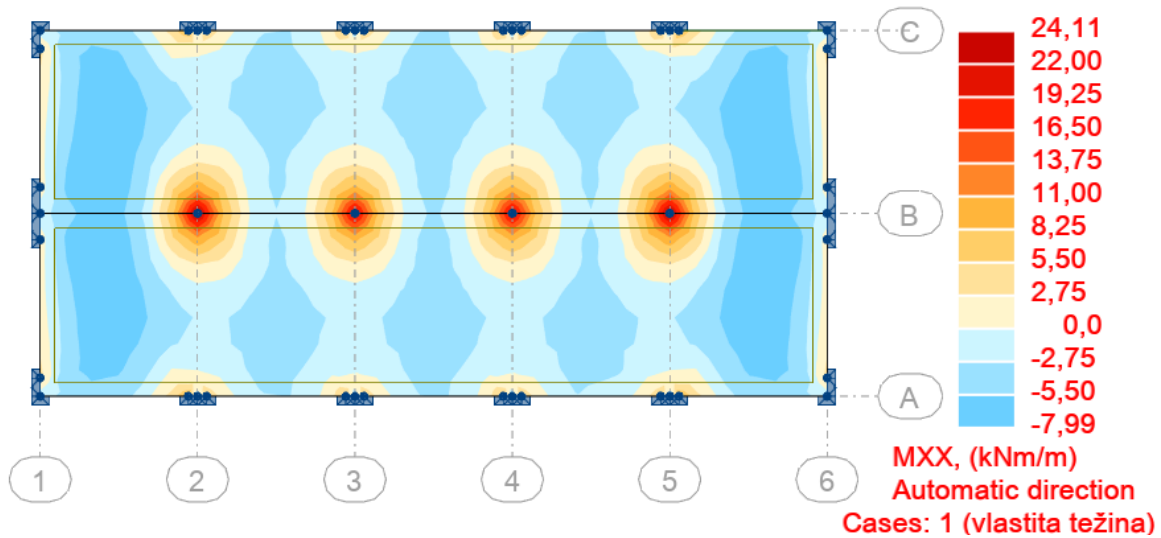

Slika 3.1. Momenti savijanja od vlastite težine u smjeru X

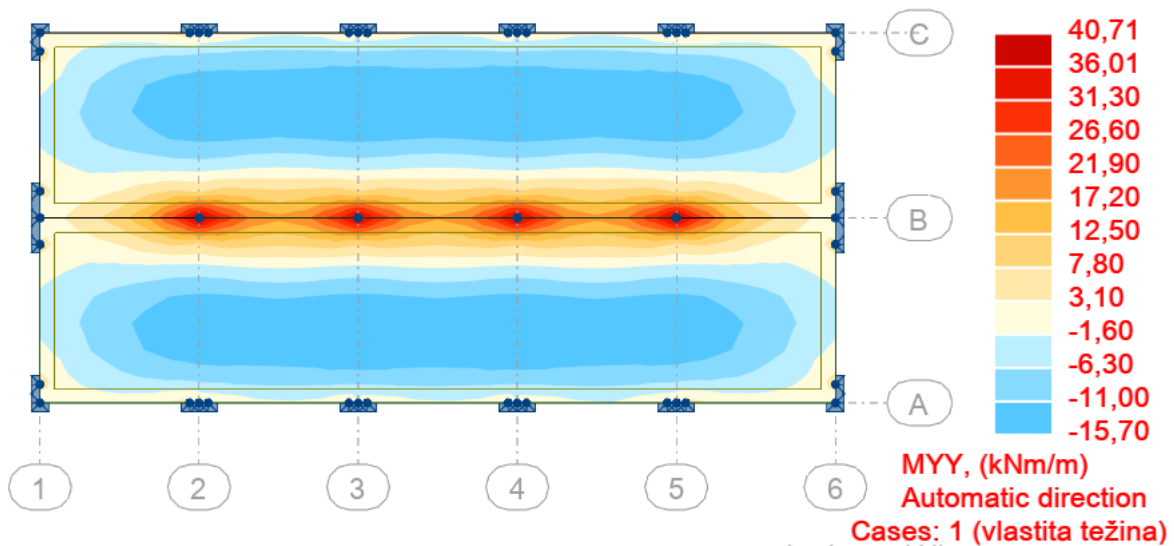

Slika 3.2. Momenti savijanja od vlastite težine u smjeru Y

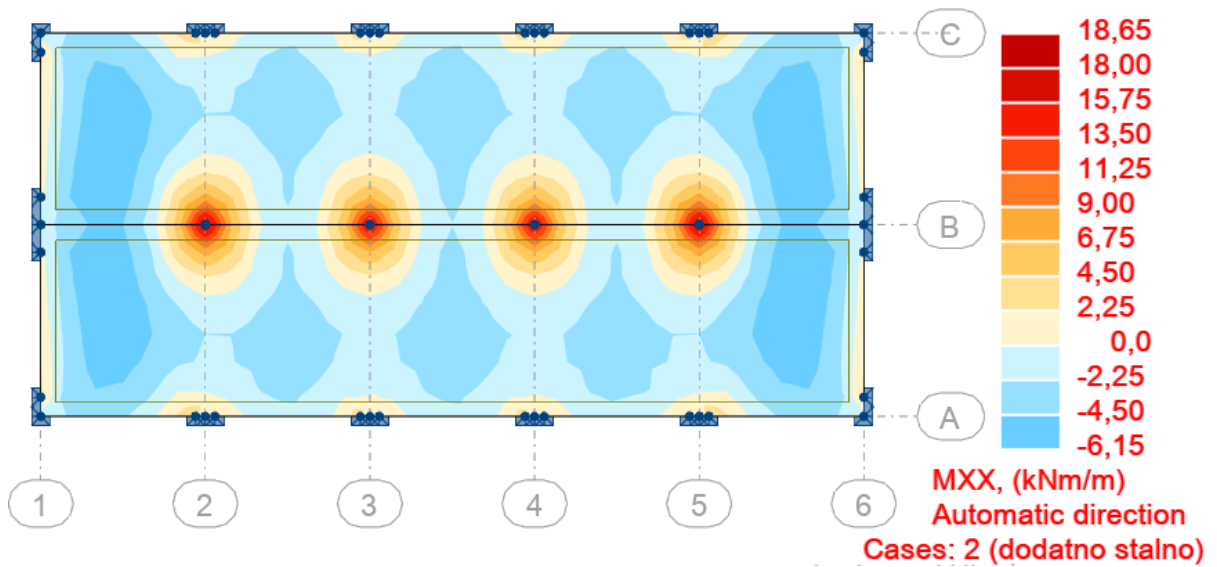

Slika 3.3. Momenti savijanja od dodatnog stalnog opterećenja u smjeru X

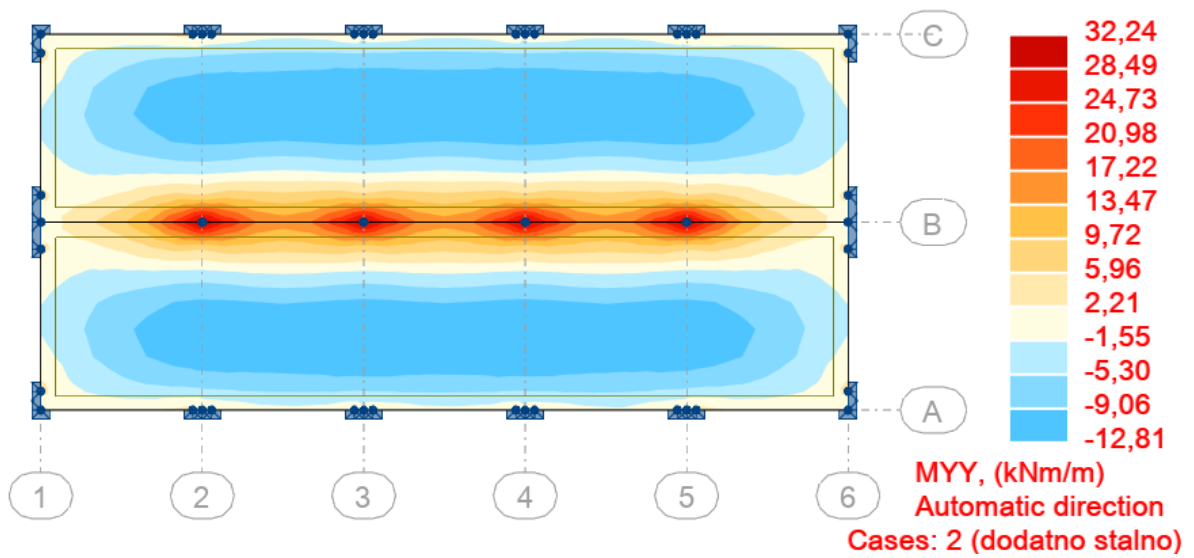

Slika 3.4. Momenti savijanja od dodatnog stalnog opterećenja u smjeru Y

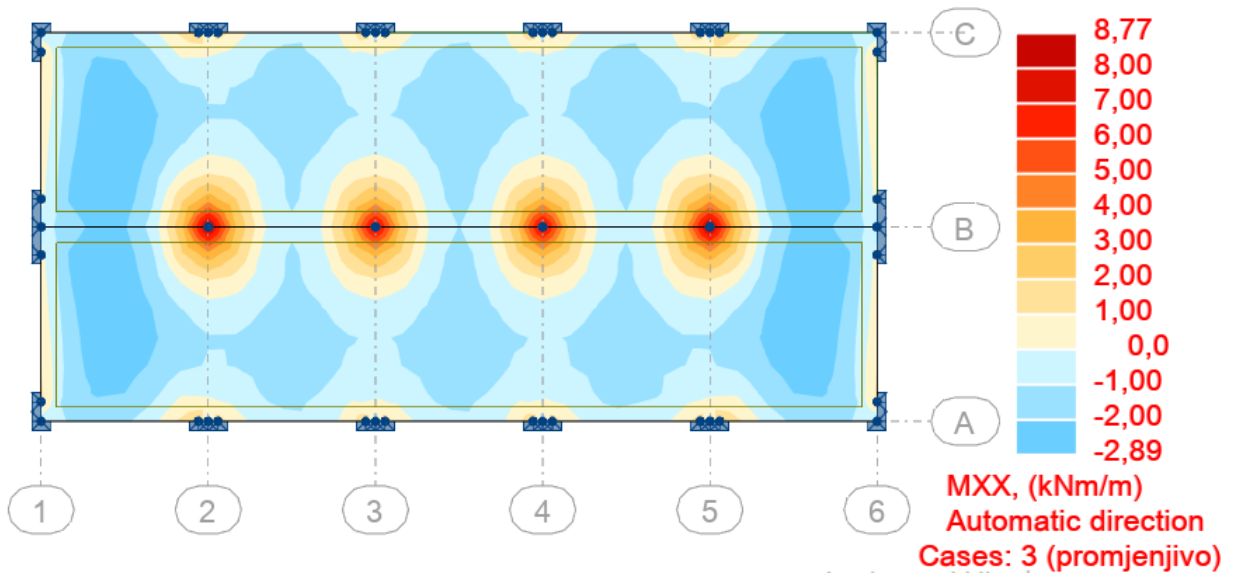

Slika 3.5. Momenti savijanja od promjenjivog opterećenja u smjeru X

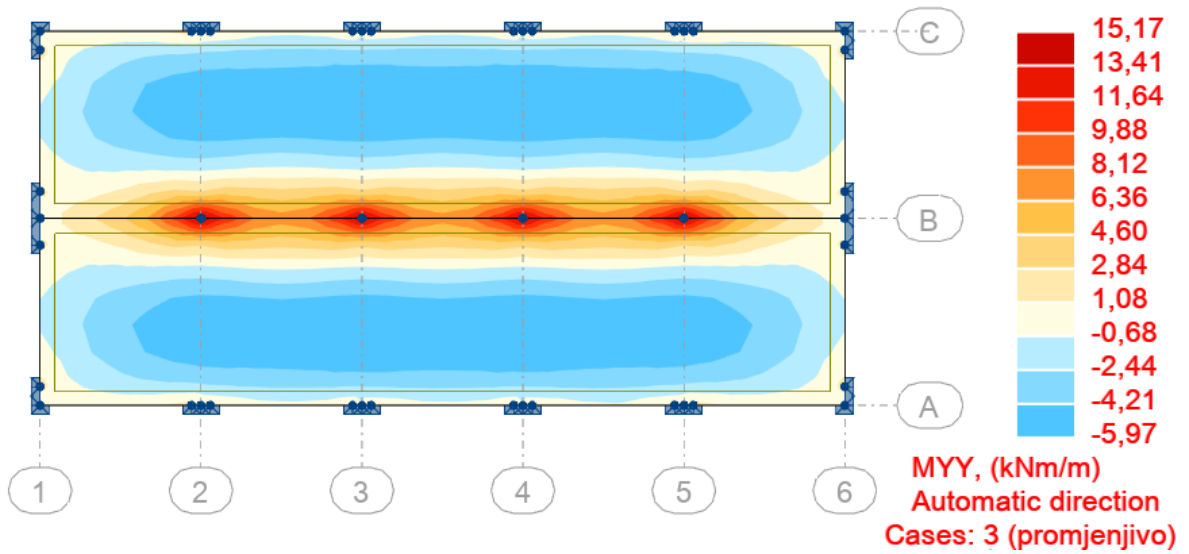

Slika 3.6. Momenti savijanja od korisnog opterećenja u smjeru Y

3.1.2. Granično stanje nosivosti

Mjerodavna kombinacija: $M_{sd}=1,35 \cdot (M_g + M_{\Delta g}) + 1,5 \cdot M_q$

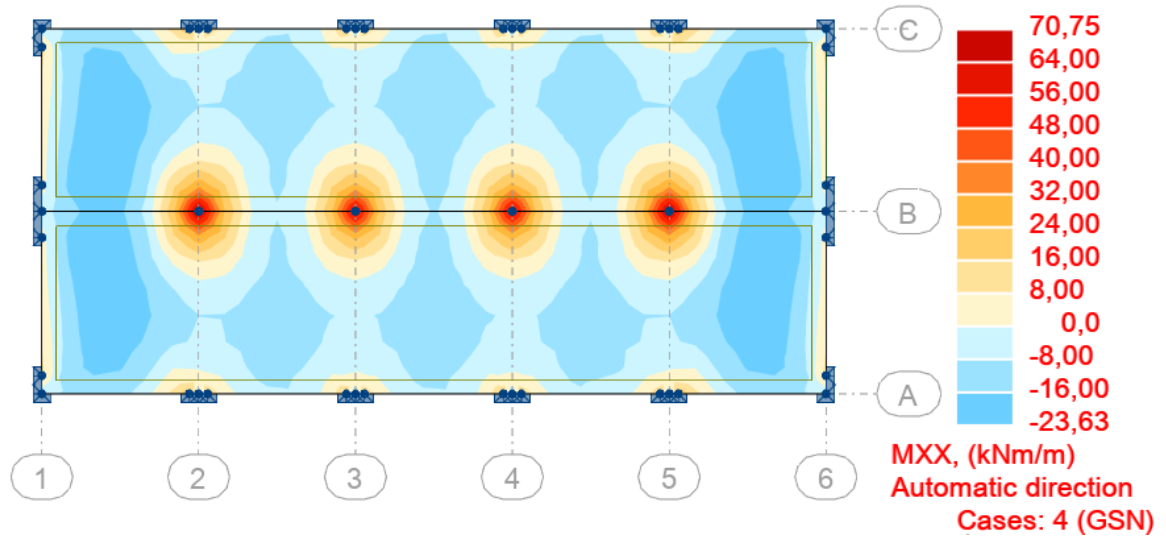

Slika 3.7. Momenti savijanja od mjerodavne kombinacije u smjeru X

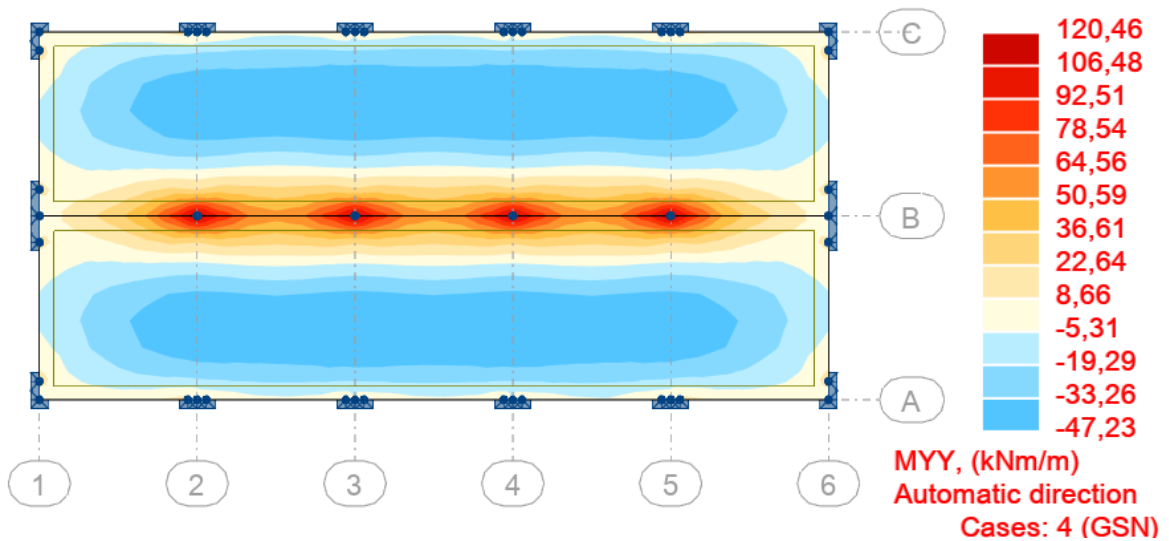

Slika 3.8. Momenti savijanja od mjerodavne kombinacije u smjeru Y

3.1.3. Dimenzioniranje krovne ploče pozicije 200

BETON: C30/37

ARMATURA: B 500B

DEBLJINA PLOČE: $h_{pl} = 18 \text{ cm}$ ZAŠTITNI SLOJ BETONA: $c = 2,0 \text{ cm}$ $d_1 = 3 \text{ cm}, d = 15 \text{ cm}$

$$f_{cd} = \frac{f_{ck}}{\gamma_c} = \frac{30}{1,5} = 2,0 \text{ kN/cm}^2$$

$$f_{yd} = \frac{f_{yd}}{\gamma_s} = \frac{500}{1,15} = 43,48 \text{ kN/cm}^2$$

MINIMALNA ARMATURA:

 $b = 100 \text{ cm}$ $d = 15,0 \text{ cm}$

$$A_{s1,\min} \geq 0,26 \cdot \frac{f_{ct,m}}{f_{yk}} \cdot b_t \cdot d \geq 0,0013 \cdot b_t \cdot d$$

 $f_{ct,m} = 2,9 \text{ N/mm}^2$ za C 30/37

$$A_{s1,\min} \geq 0,26 \cdot 2,9 / 500 \cdot 100 \cdot 15,0 = 2,262 \text{ cm}^2/\text{m}$$

$$A_{s1,\min} \geq 0,0013 \cdot b_t \cdot d = 0,0013 \cdot 100 \cdot 15 = 1,95 \text{ cm}^2/\text{m}$$

POZICIJA POLJE

$$M_x = 23,63 \text{ kNm}$$

$$M_y = 47,23 \text{ kNm}$$

$$\mu_{sd} = \frac{M_{Ed}}{b \cdot d^2 \cdot f_{cd}} = \frac{4723}{100 \cdot 15,0^2 \cdot 2,0} = 0,105 \quad \text{=odabrani } \mu_{sd} = 0,110$$

Očitano: $\varepsilon_{s1} = 10\text{‰}$; $\varepsilon_{c2} = 2,4\text{‰}$; $\xi = 0,194$; $\zeta = 0,925$

$$A_{s1} = \frac{M_{Ed}}{\zeta \cdot d \cdot f_{yd}} = \frac{4723}{0,925 \cdot 15,0 \cdot 43,48} = 7,83 \text{ cm}^2/\text{m}$$

Odabrana armatura: mreža Q-785 (7,85 cm²)

POZICIJA LEŽAJ

$$M_x = 70,76 \text{ kNm}$$

$$M_y = 120,46 \text{ kNm}$$

$$\mu_{sd} = \frac{M_{Ed}}{b \cdot d^2 \cdot f_{cd}} = \frac{12046}{100 \cdot 15,0^2 \cdot 2,0} = 0,268 \quad \text{=odabrani } \mu_{sd} = 0,159$$

Vidljivo je da izračunati μ_{sd} veći od maksimalnog kojeg možemo očitati iz tablica. Presjek je potrebno dvostruko armirati. Računamo moment nosivosti:

$$\text{Očitano: } \varepsilon_{s1} = 10\text{‰}$$

$$\varepsilon_{c2} = 3,5\text{‰}$$

$$\zeta = 0,892$$

$$\xi = 0,259$$

$$M_{Rd,lim} = \mu_{sd,lim} \cdot b d^2 \cdot f_{cd} = 0,159 \cdot b d^2 \cdot f_{cd} = 0,159 \cdot 100 \cdot 15^2 \cdot 2$$

$$M_{Rd,lim} = 7155 \text{ kN/cm} = 71,55 \text{ kN/m}$$

Vlačna armatura:

$$A_{s1} = \frac{M_{Ed,lim}}{\zeta_{lim} \cdot d \cdot f_{yd}} + \frac{M_{Ed} - M_{Rd,lim}}{(d - d_1) \cdot f_{yd}} = \frac{71,55 \cdot 100}{0,892 \cdot 15 \cdot 43,48} + \frac{(120,46 - 71,55) \cdot 100}{(15 - 3) \cdot 43,48}$$

$$A_{s1} = 12,30 + 9,37 = 21,67 \text{ cm}^2/\text{m}'$$

Odabrana armatura: mreža R-785 + 10Ø14 (23,24 cm²)

Tlačna armatura:

$$A_{s2} = \frac{M_{Ed} - M_{Rd,lim}}{(d - d_1) \cdot f_{yd}} = \frac{(120,46 - 71,55) \cdot 100}{(15 - 3) \cdot 43,48} = 9,37 \text{ cm}^2/\text{m}'$$

Odabrana armatura: mreža R-785 + 4Ø10 (10,99 cm²)

3.1.4. Kontrola graničnog stanja uporabljivosti

Pukotine:

Mjerodavni momenti u ploči dobiveni su iz kombinacija za granično stanje uporabljivosti.

Uobičajena kombinacija za dimenzioniranje ploča $\rightarrow 1.35 \cdot g + 1.35 \cdot \Delta g + 1.5 \cdot q$

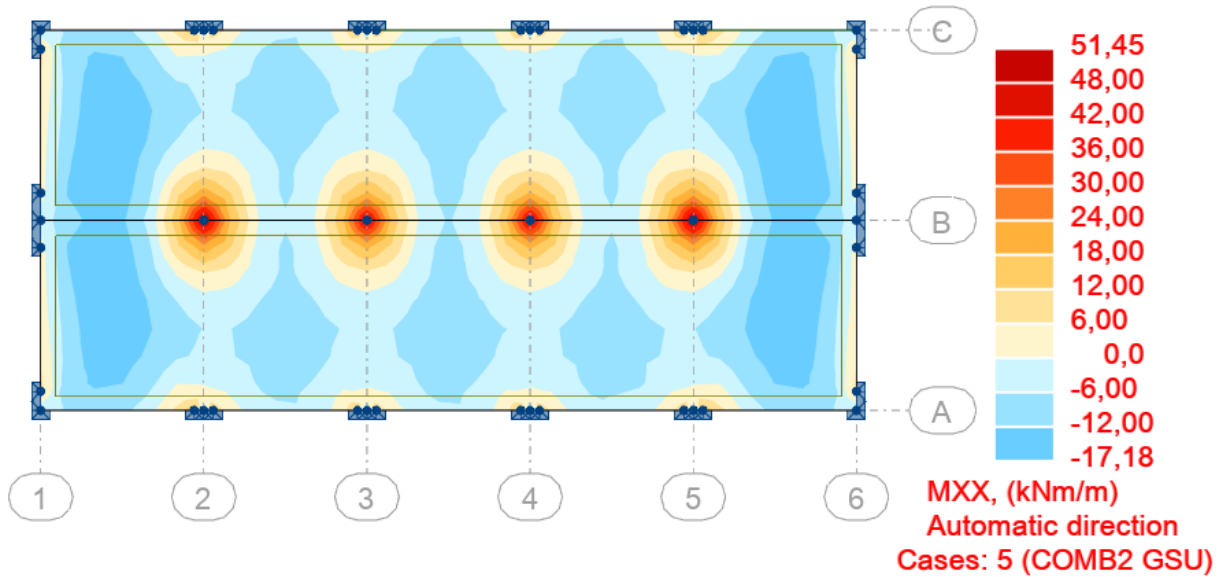

Slika 3.9. Granično stanje uporabljivosti u smjeru M_x

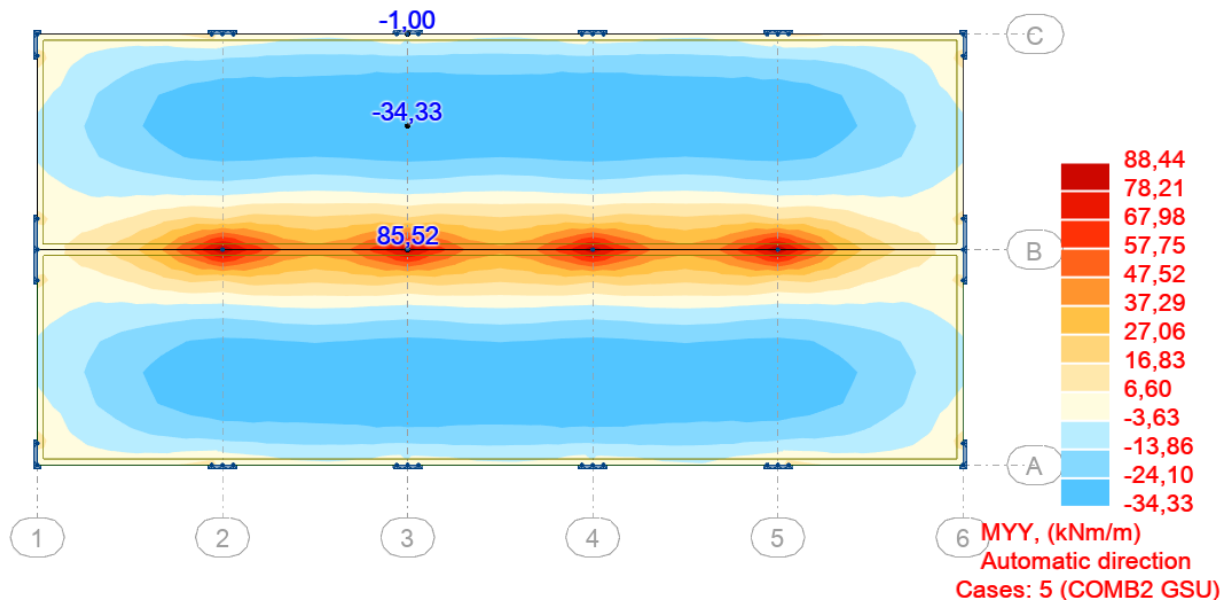

Slika 3.10. Granično stanje uporabljivosti u smjeru M_y

Granična vrijednost širine pukotina: $w_g = 0,3 \text{ mm}$ (EC2)

Proračunska vrijednost širine pukotine: (EC-2): $w_k = S_{r,max} \cdot (\varepsilon_{sm} - \varepsilon_{cm})$

Armatura ploče donje zone Pozicije 100: Q-785 ($A_{s1} = 7,85 \text{ cm}^2$)

$M_{Ed} = 34,33 \text{ kNm}$

Prognozna širina pukotine: $w_k = S_{r,max} \cdot (\varepsilon_{sm} - \varepsilon_{cm})$

Vrijednost $(\varepsilon_{sm} - \varepsilon_{cm})$ određuje se prema izrazu:

$$(\varepsilon_{cm} - \varepsilon_{sm}) = \frac{\sigma_s - k_t \frac{f_{ct,eff}}{\rho_{p,eff}} (1 + \alpha_e \cdot \rho_{p,eff})}{E_s} \geq 0,6 \cdot \frac{\sigma_s}{E_s}$$

$$x = \frac{\alpha_e \cdot A_s}{b} \cdot \left(-1 + \sqrt{1 + \frac{2 \cdot b \cdot d}{\alpha_e \cdot A_s}} \right)$$

$$\sigma_s = \frac{M_{Ed}}{z \cdot A_s} \approx \frac{M_{Ed}}{\left(d - \frac{x}{3}\right)}$$

Za C 30/37 $\rightarrow f_{ct,eff} = 29 \text{ MPa}$

$A_s = Q - 785 = 7,85 \text{ cm}^2$

$\varepsilon_{cm} = 33,0 \text{ GPa} = 33000 \text{ MPa}$ – Modul elastičnosti betona

$\varepsilon_{sm} = 200,0 \text{ GPa} = 33000 \text{ MPa}$ – Modul elastičnosti armature

$k_t = 0,4$ – Dugotrajno opterećenje

$\alpha_e = \frac{E_s}{E_{cm}} = \frac{200}{33} = 6,06$ – Odnos modula elastičnosti armature i betona

Djelotvorni koeficijent armiranja glavnom vlačnom armaturom:

$$\rho_{p,eff} = \frac{A_s}{A_{c,eff}} = \frac{7,85}{100 \cdot (2,5 \cdot 3)} = 0,01046$$

Srednji razmak pukotina:

$$S_{r,max} = k_3 \cdot c + k_1 \cdot k_2 \cdot k_4 \cdot \frac{\emptyset}{\rho_{p,eff}} [\text{mm}]$$

$$\emptyset = 10\text{mm} - (Q - 7,85 \rightarrow \emptyset 10/10)$$

$c = 20\text{ mm}$ – zaštitni sloj uzdužne armature

$k_1 = 0,8$ – rebrasta armatura

$k_2 = 0,5$ – savijanje

$k_3 = 3,4$

$k_4 = 0,425$

$b =$	100,0	cm	$d =$	15,0	cm	$h =$	18,0	cm
$f_{ck} =$	30,0	MN/m ²	$f_{ctm} =$	2,90	MN/m ²	$w_g =$	0,30	mm
$A_{s1} =$	7,85	cm ²	$A_{s2} =$	0,00	cm ²	$d_1 = d_2 =$	3,0	cm
$E_s =$	200,00	GN/m ²	$E_{cm} =$	33,00	GN/m ²	$\alpha_e =$	6,1	
$M_{Ed} =$	34,33	kNm	$k_t =$	0,40		$E_s/E_{cm} =$	6,1	
$\sigma_s =$	314,86	MN/m ²						
$x =$	3,33	cm	$\rho_{p,eff} =$	0,01046				
$(\epsilon_{sm} - \epsilon_{cm}) =$	0,000985	>	$0,6 \cdot \sigma_s / E_s =$	0,000945				
$\emptyset =$	10,0	mm	$c =$	2,00	cm			
$k_1 =$	0,8		$k_2 =$	0,50				
$k_3 =$	3,4		$k_4 =$	0,43				
$s_{r,max} =$	230,52	mm						
$w_k = s_{r,max} \cdot (\epsilon_{sm} - \epsilon_{cm}) =$	0,227	mm	<	w_g				

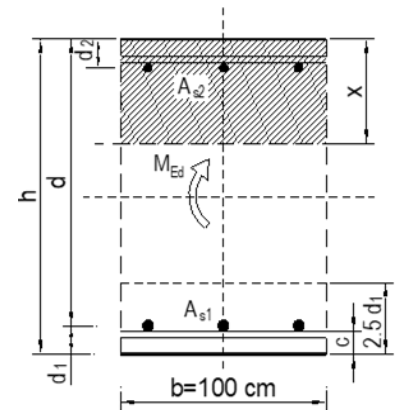

$$w_k = s_{r,max} \cdot (\epsilon_{sm} - \epsilon_{sm}) = 0,227\text{ mm} < w_g = 0,3\text{ mm}$$

Pukotine zadovoljavaju

3.1.5. Kontrola progiba

Mjerodavni progibi ploče su dobiveni kroz numerički model. Koriste se rezultati od kratkotrajnog djelovanja i radne kombinacije opterećenja: GSU : 1,0 (g+Δg) + 1,0q.

Progib kontroliramo za nefaktorizirano opterećenje i bez utjecaja puzanja.

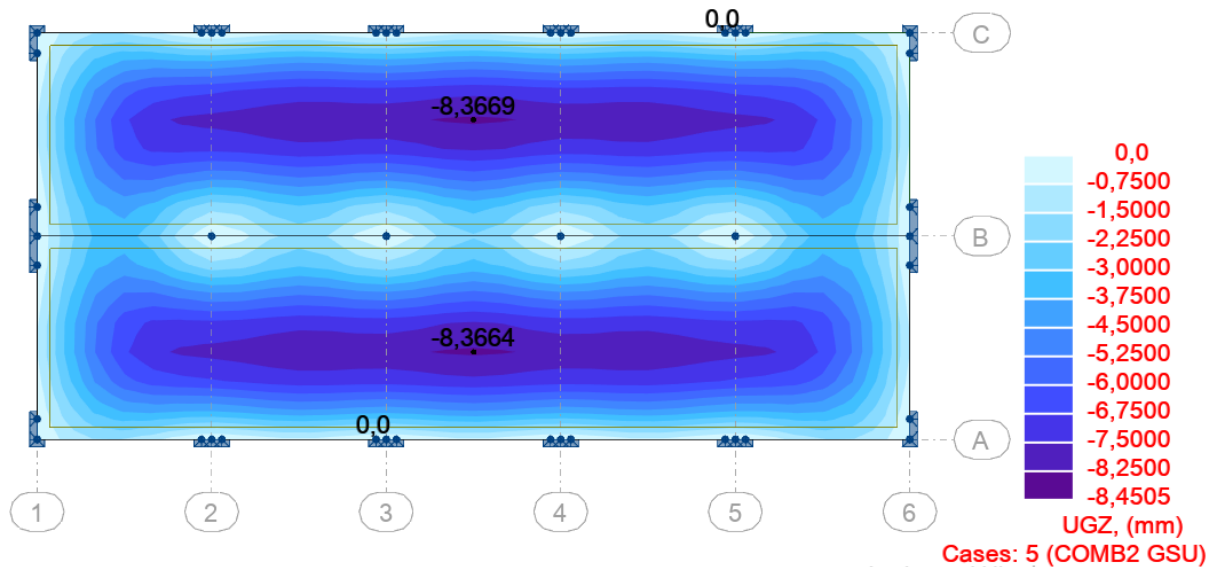

Slika 3.11. Ukupan progib za GSU

-Progib za ploču pozicije 200

$$M_{Ed,polje} = 34,33 \text{ kNm}$$

$$M_{Ed,rub} = 1 \text{ kNm}$$

$$M_{Ed,ležaj} = 85,44 \text{ kNm}$$

$$\text{Granični progib: } f_{p,dop} = \frac{l}{250} = \frac{6980}{250} = 27,92 \text{ mm}$$

$$v_{tot} = k \cdot l^2 \cdot \frac{1}{r_{tot}}$$

$$\beta = \frac{|M_{Ed,rub} + M_{Ed,ležaj}|}{|M_{Ed,polje}|} = \frac{|1,0 + 85,44|}{|34,33|} = 2,52$$

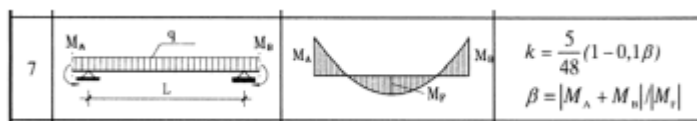

$$k = \frac{5}{48} \cdot (1 - 0,1 \cdot 2,52) = 0,078 \text{ – koeficijent ovisan o statičkom sustavu i opterećenju}$$

$l = 698 \text{ cm}$ raspon elementa

$$\frac{1}{r_{tot}} = \frac{1}{r_m} + \frac{1}{r_{csm}}$$

r_{tot} – ukupna zakrivljenost

r_m – zakrivljenost zbog opterećenja i puzanja

r_{csm} – zakrivljenost zbog skupljanja

$$E_{cm} = 9500 \cdot (f_{ck} + 8)^{\frac{1}{3}} = 9500 \cdot (30 + 8)^{\frac{1}{3}} = 31938,77 \frac{N}{mm^2} - \text{modul elastičnosti betona}$$

$E = 200000N/mm^2$ – modul elastičnosti čelika

$$\alpha_e = \frac{200000}{31938,77} = 6,26 - \text{omjer module elastičnosti i čelika}$$

Moment tromosti za neraspucano stanje:

$$I_i = \frac{b \cdot h^3}{12} + \alpha_e \cdot (A_{S1} \cdot \left(\frac{h}{2} - d_2\right)^2 + A_{S2} \cdot \left(\frac{h}{2} - d_1\right)^2)$$

$$I_i = 48600 + 6,26 \cdot \left(7,85 \cdot \left(\frac{18}{2} - 3\right)^2 + 0 \cdot \left(\frac{18}{2} - 3\right)^2\right) = 50369,08 \text{ cm}^4$$

$$\frac{1}{r_I} = \frac{M_{Ed}}{E_{c,eff} \cdot I_i} = \frac{3433}{3194 \cdot 50369,08} = 0,0000213 \frac{1}{cm}$$

$$x = \frac{\alpha_{el} \cdot A_{S1}}{b} \cdot \left(-1 + \sqrt{1 + \frac{2bd}{\alpha_{el} \cdot A_{S1}}}\right) = 3,33 - \text{položaj neutralne osi}$$

Moment tromosti za raspucalo stanje:

$$I_{II} = \frac{b \cdot x^3}{12} + b \cdot x \cdot \left(\frac{x}{2}\right)^2 + \alpha_e \cdot [A_{S1} \cdot (d - x)^2 + A_{S2} \cdot (x - d_2)^2]$$

$$I_{II} = 307,72 + 923,15 + 6692,46 = 7923,33 \text{ cm}^4$$

$$\frac{1}{r_{II}} = \frac{M_{Ed}}{E_{c,eff} \cdot I_{II}} = \frac{3433}{3194 \cdot 7923,33} = 0,00013 \frac{1}{cm}$$

$$\sigma_{sr} = \frac{M_{cr}}{z \cdot A_s} M_{cr} = f_{ctm} \cdot \frac{b \cdot h^2}{6} f_{ctm} \approx 0,3 \cdot f_{ck}^{\frac{2}{3}} f_{ck} = 30 \text{ MPa}$$

$$f_{ctm} \approx 0,3 \cdot f_{ck}^{\frac{2}{3}} = 0,3 \cdot 30^{\frac{2}{3}} = 2,9 \text{ MPa}$$

$$M_{cr} = f_{ctm} \cdot \frac{b \cdot h^2}{6} = 0,29 \cdot \frac{100 \cdot 18^2}{6} = 1566 \text{ kNcm} = 15,66 \text{ kNm}$$

$$\sigma_{sr} = \frac{M_{cr}}{z \cdot A_s} = \frac{M_{cr}}{\left(d - \frac{x}{3}\right) \cdot A_s} = \frac{1566}{13,9 \cdot 7,85} = 14,35 \text{ kN/cm}^2 = 143,5 \text{ N/m}^2$$

$$\sigma_s = \frac{M_{Ed}}{z \cdot A_{s1}} = \frac{M_{Ed}}{\left(d - \frac{x}{3}\right) \cdot A_{s1}} = \frac{3433}{13,9 \cdot 7,85} = 31,46 \text{ kN/cm}^2 = 314,62 \text{ N/m}^2$$

$$\zeta = 1 - \beta_1 \cdot \beta_2 \cdot \left(\frac{\sigma_{sr}}{\sigma_s}\right)^2 - \text{koeficijent raspodjele}$$

$\beta_1 = 1$ – koeficijent koji uzima u obzir vrstu armature

$\beta_2 = 0,5$ – koeficijent koji uzima u obzir trajanje opterećenja

$$\zeta = 1 - 1 \cdot 0,5 \cdot \left(\frac{143,5}{314,62}\right)^2 = 0,896$$

$$\frac{1}{r_m} = \zeta \cdot \frac{1}{r_I} + (1 - \zeta) \cdot \frac{1}{r_{II}} = 0,896 \cdot 0,0000213 + (1 - 0,896) \cdot 0,00013 = 0,000033 \frac{1}{\text{cm}}$$

$$v_{tot} = k \cdot l^2 \cdot \frac{1}{r_{tot}} = 0,078 \cdot 600^2 \cdot 0,000033 = 0,93 \text{ cm} < v_{lim} = 2,792 \text{ cm}$$

Progibi zadovoljavaju

3.2. Proračun međukatne ploče pozicije 100

3.2.1. Momenti savijanja u ploči pozicije 100

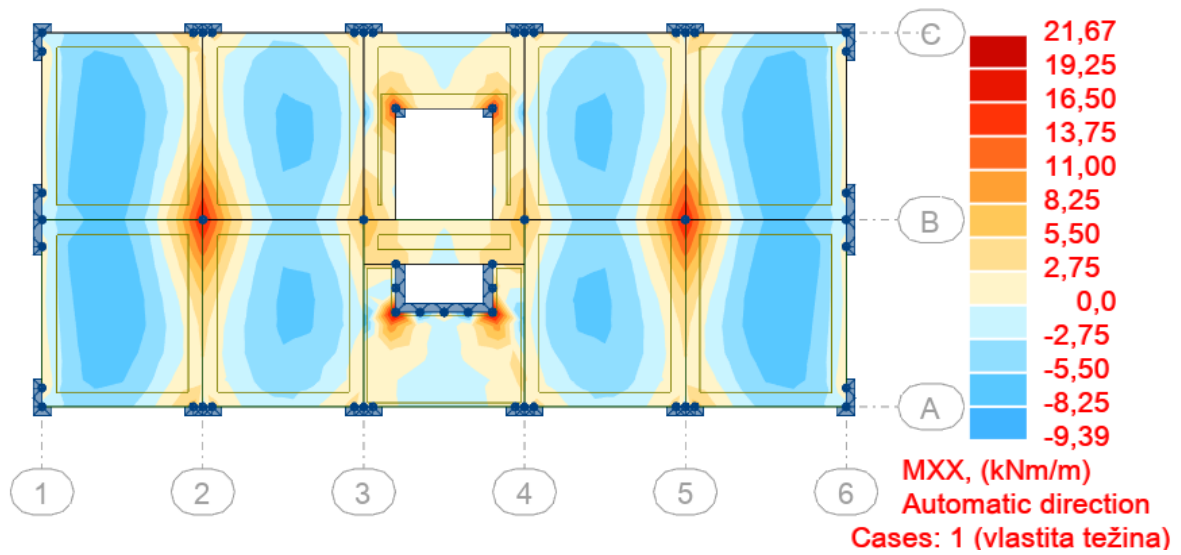

Slika 3.12. Momenti savijanja od vlastite težine u smjeru X

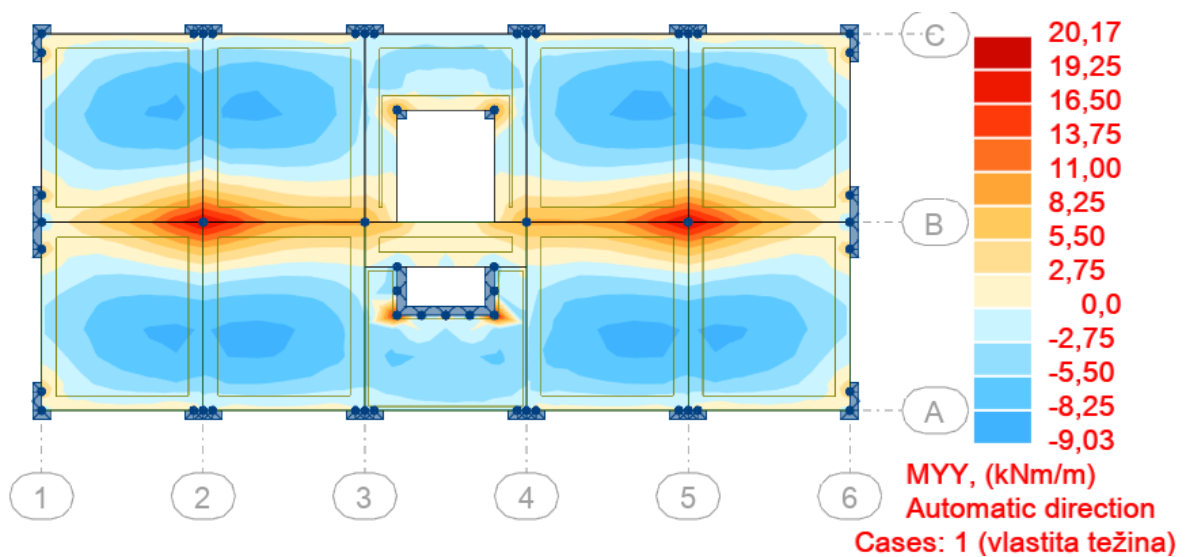

3.13. Momenti savijanja od vlastite težine u smjeru Y

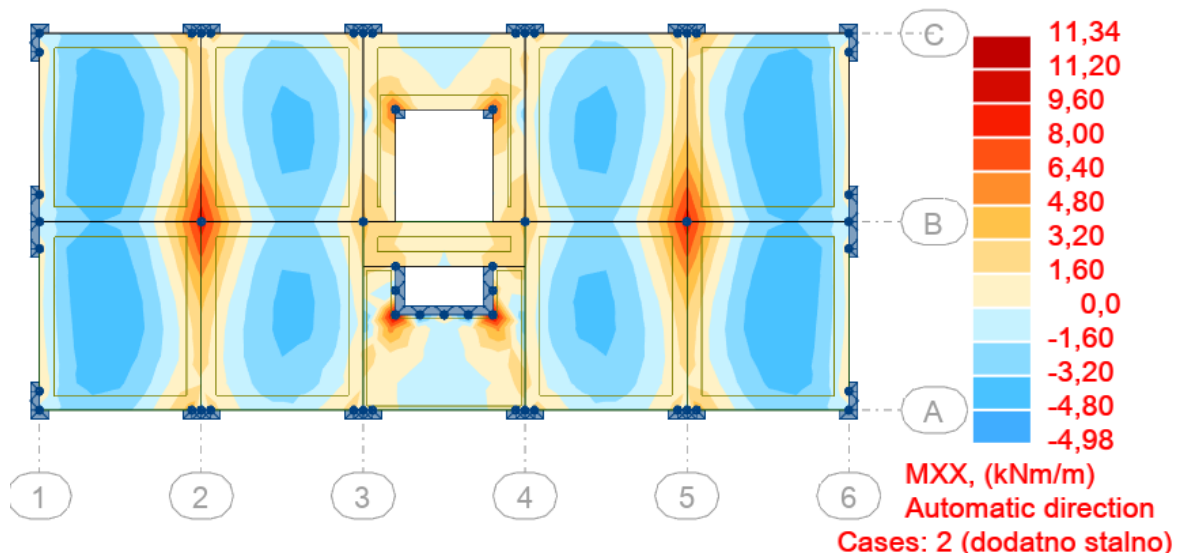

3.14. Momenti savijanja od dodatnog stalnog opterećenja u smjeru X

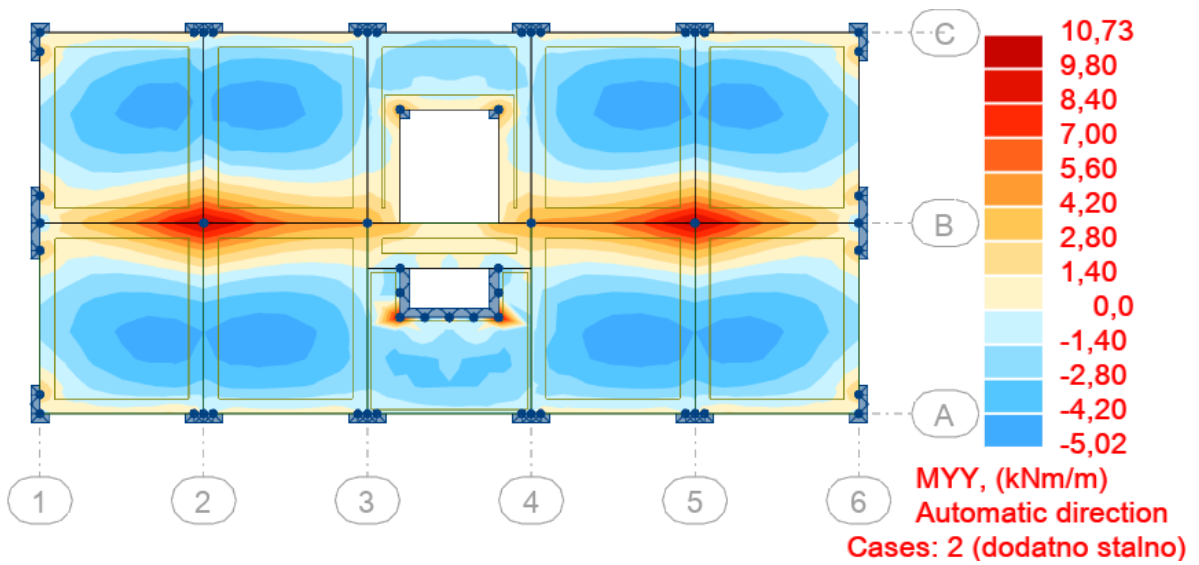

3.15. Momenti savijanja od dodatnog stalnog opterećenja u smjeru Y

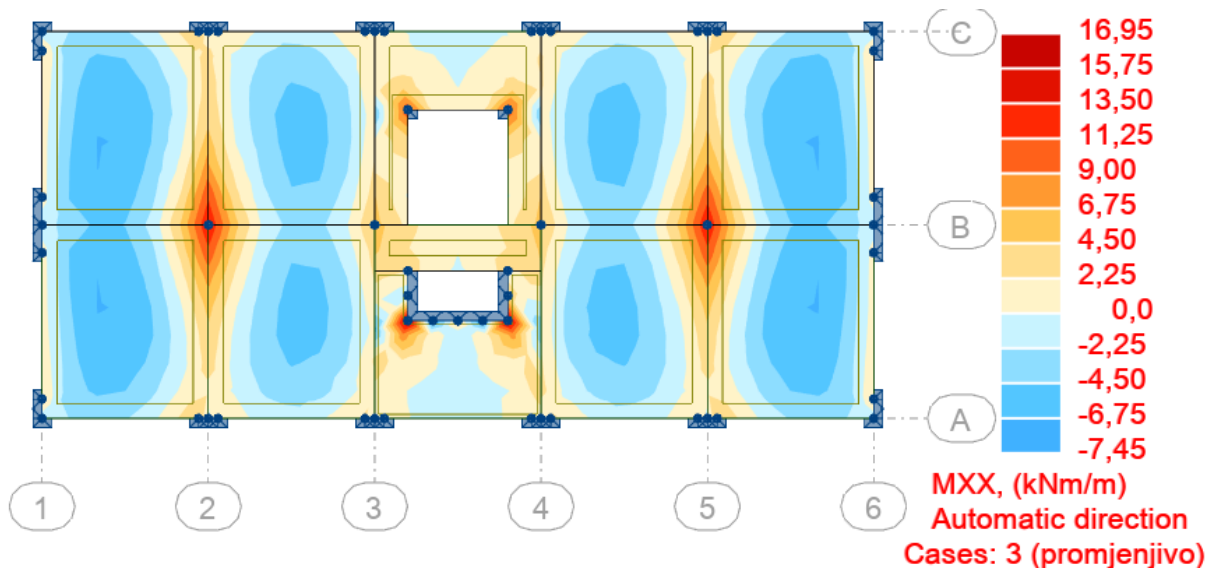

3.16. Momenti savijanja od promjenjivog opterećenja u smjeru X

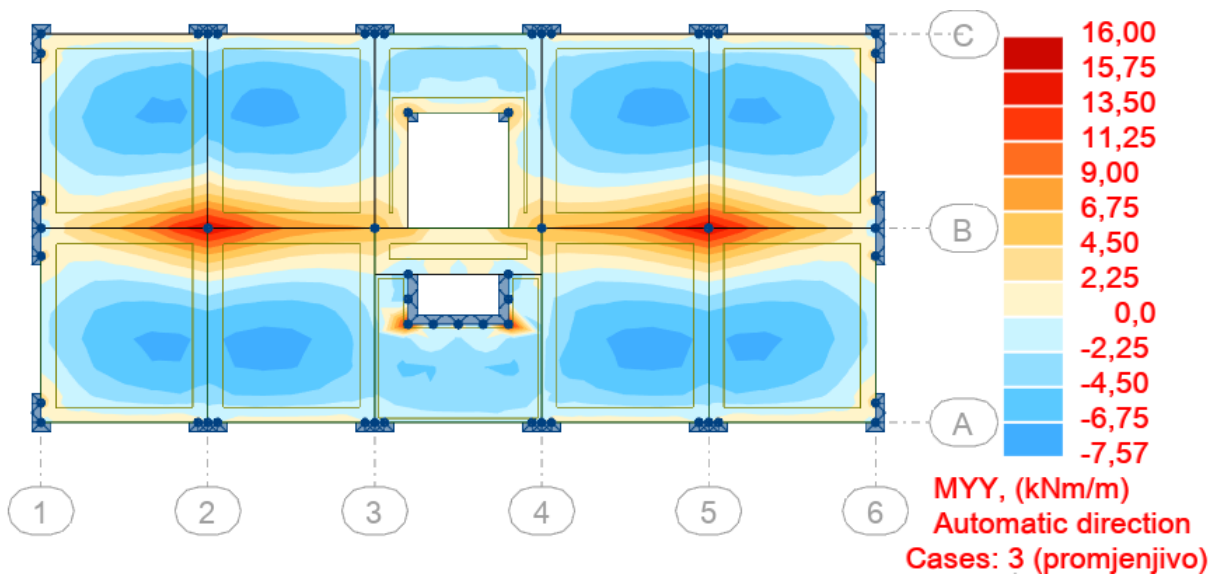

3.17. Momenti savijanja od promjenjivog opterećenja u smjeru Y

3.2.2. Granično stanje nosivosti

Mjerodavna kombinacija: $M_{sd} = 1,35 \cdot (M_g + M_{\Delta g}) + 1,5 \cdot M_q$

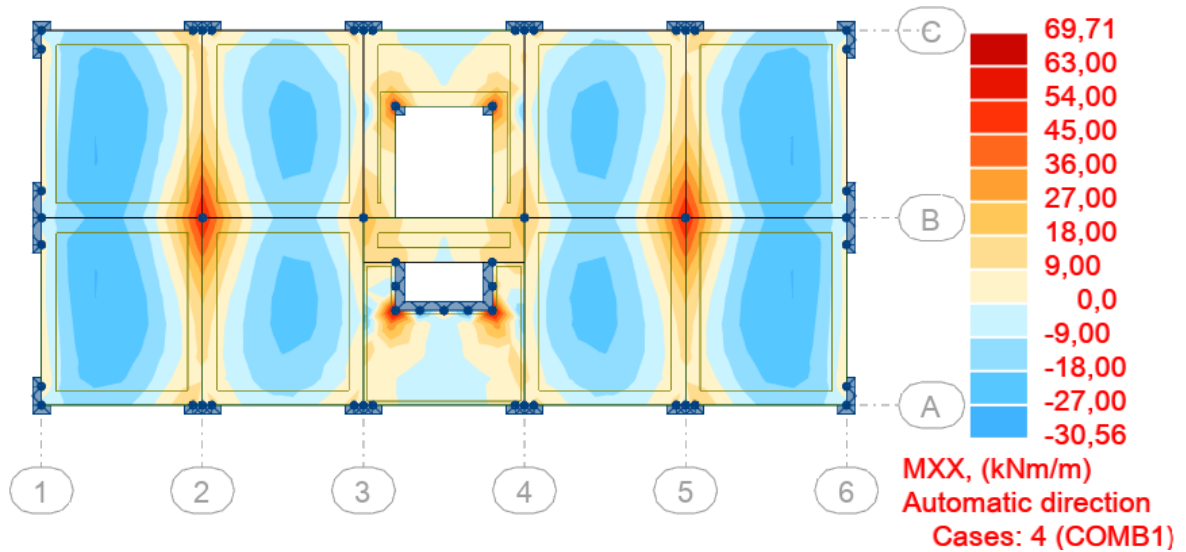

Slika 3.18. Momenti savijanja od mjerodavne kombinacije u smjeru X

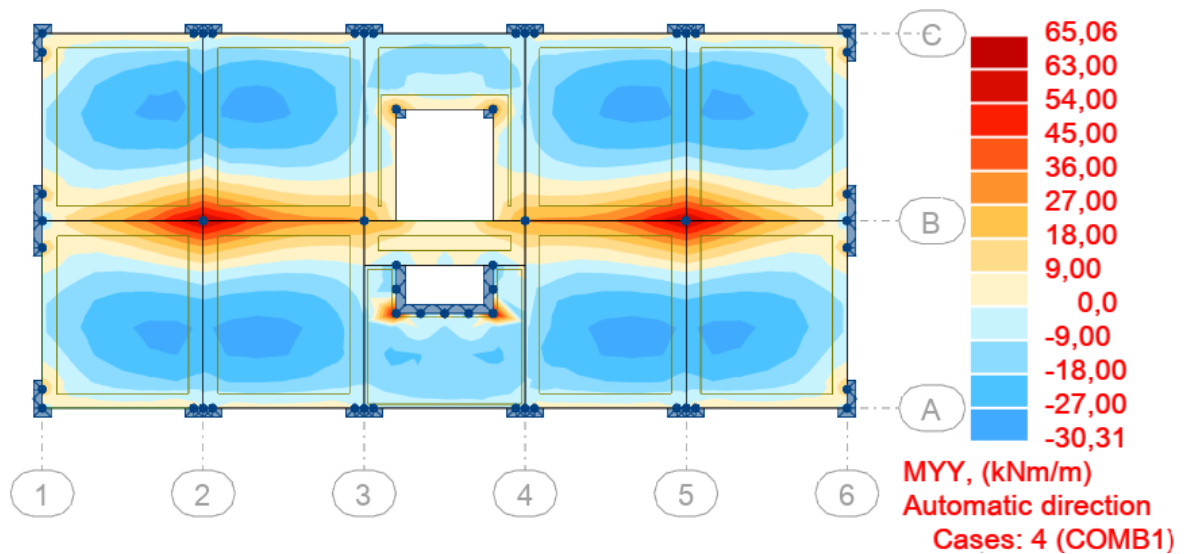

Slika 3.19. Momenti savijanja od mjerodavne kombinacije u smjeru Y

3.2.3. Dimenzioniranje ploče pozicije 100

BETON: C30/37

ARMATURA: B 500B

DEBLJINA PLOČE: $h_{pl} = 18 \text{ cm}$

ZAŠTITNI SLOJ BETONA: $c = 2,0 \text{ cm}$

$d_1 = 3 \text{ cm}$, $d = 15 \text{ cm}$

$$f_{cd} = \frac{f_{ck}}{\gamma_c} = \frac{30}{1,5} = 2,0 \text{ kN/cm}^2$$

$$f_{yd} = \frac{f_{yd}}{\gamma_s} = \frac{500}{1,15} = 43,48 \text{ kN/cm}^2$$

MINIMALNA ARMATURA:

$b = 100 \text{ cm}$

$d = 15,0 \text{ cm}$

$$A_{s1,\min} \geq 0,26 \cdot \frac{f_{ct,m}}{f_{yk}} \cdot b_t \cdot d \geq 0,0013 \cdot b_t \cdot d$$

$f_{ct,m} = 2,9 \text{ N/mm}^2$ za C 30/37

$$A_{s1,\min} \geq 0,26 \cdot 2,9 / 500 \cdot 100 \cdot 15,0 = 2,262 \text{ cm}^2/\text{m}$$

$$A_{s1,\min} \geq 0,0013 \cdot b_t \cdot d = 0,0013 \cdot 100 \cdot 15,0 = 1,95 \text{ cm}^2/\text{m}$$

POZICIJA POLJE

$$M_x = 30,56 \text{ kNm}$$

$$M_y = 30,31 \text{ kNm}$$

$$\mu_{sd} = \frac{M_{Ed}}{b \cdot d^2 \cdot f_{cd}} = \frac{3056}{100 \cdot 15,0^2 \cdot 2,0} = 0,068 \quad \text{= odabrani } \mu_{sd} = 0,071$$

$$\text{Očitano: } \varepsilon_{s1} = 10\text{‰} ; \varepsilon_{c2} = 1,7\text{‰} ; \xi = 0,145 ; \zeta = 0,947$$

$$A_{s1} = \frac{M_{Ed}}{\zeta \cdot d \cdot f_{yd}} = \frac{3056}{0,947 \cdot 15,0 \cdot 43,48} = 4,95 \text{ cm}^2/\text{m}$$

Odabrana armatura: mreža Q-503 (5,03 cm²)

POZICIJA LEŽAJ

$$M_x = 69,71 \text{ kNm}$$

$$M_y = 65,06 \text{ kNm}$$

$$\mu_{sd} = \frac{M_{Ed}}{b \cdot d^2 \cdot f_{cd}} = \frac{6971}{100 \cdot 15,0^2 \cdot 2,0} = 0,155$$

$$\text{Očitano: } \varepsilon_{s1} = 10\text{‰} ; \varepsilon_{c2} = 3,5\text{‰} ; \xi = 0,259 ; \zeta = 0,892$$

$$A_{s1} = \frac{M_{Ed}}{\zeta \cdot d \cdot f_{yd}} = \frac{6971}{0,892 \cdot 15,0 \cdot 43,48} = 11,98 \text{ cm}^2/\text{m}$$

Odabrana armatura: mreža R-785 + 6Ø10 (12,56 cm²)

3.2.4. Kontrola graničnog stanja uporabljivosti

Pukotine:

Mjerodavni momenti u ploči dobiveni su iz kombinacija za granično stanje uporabljivosti.

Uobičajena kombinacija za dimenzioniranje ploča $\rightarrow 1.35 \cdot g + 1.35 \cdot \Delta g + 1.5 \cdot q$

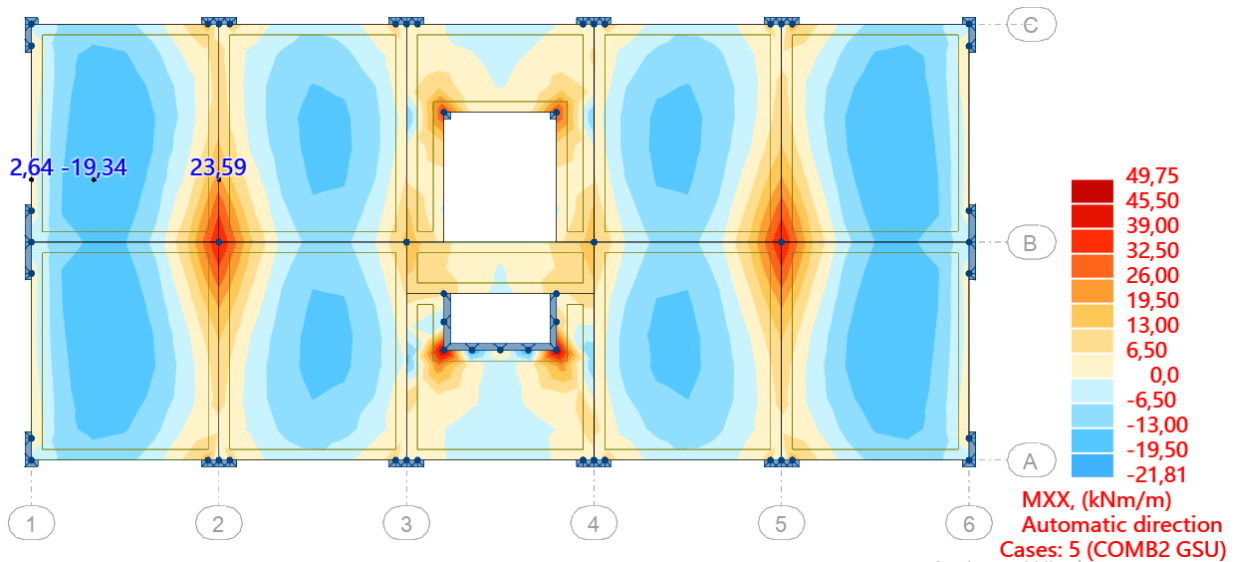

Slika 3.20. Granično stanje uporabljivosti u smjeru M_x

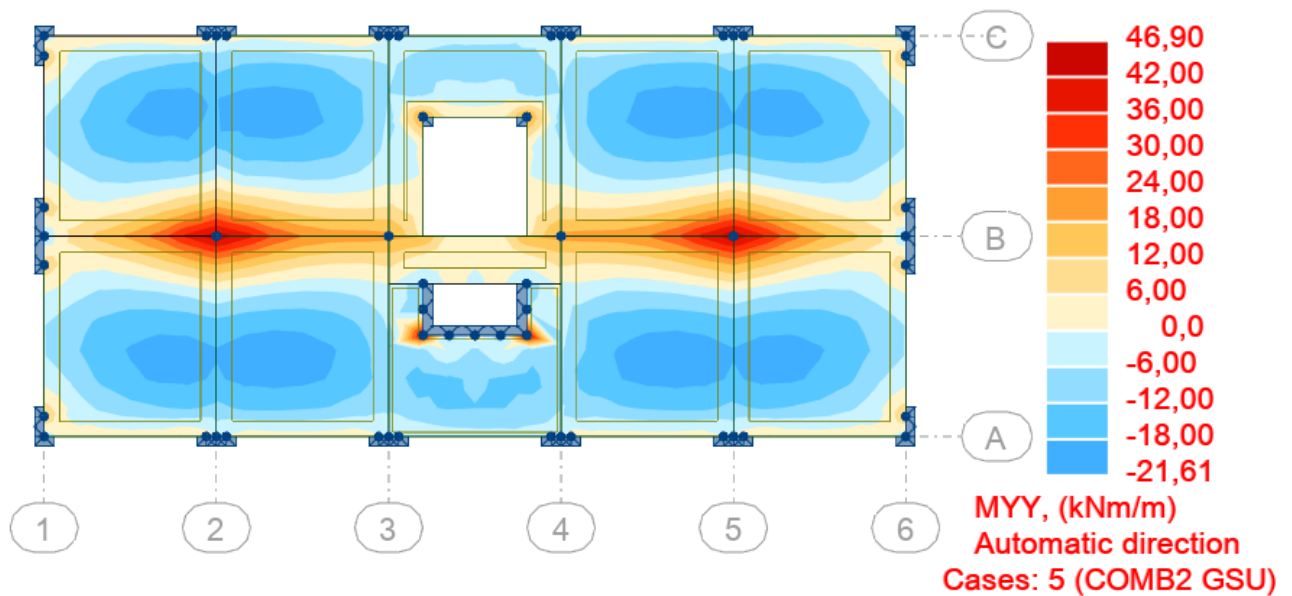

Slika 3.21. Granično stanje uporabljivosti u smjeru M_y

Granična vrijednost širine pukotina: $w_g = 0,3 \text{ mm}$ (EC2)

Proračunska vrijednost širine pukotine: (EC-2): $w_k = S_{r,max} \cdot (\varepsilon_{sm} - \varepsilon_{cm})$

Armatura ploče donje zone Pozicije 100: **Q-636** ($A_{s1} = 6,36 \text{ cm}^2$)

$M_{Ed} = 19,34 \text{ kNm}$

Prognozna širina pukotine: $w_k = S_{r,max} \cdot (\varepsilon_{sm} - \varepsilon_{cm})$

Vrijednost $(\varepsilon_{sm} - \varepsilon_{cm})$ određuje se prema izrazu:

$$(\varepsilon_{cm} - \varepsilon_{sm}) = \frac{\sigma_s - k_t \frac{f_{ct,eff}}{\rho_{p,eff}} (1 + \alpha_e \cdot \rho_{p,eff})}{E_s} \geq 0,6 \cdot \frac{\sigma_s}{E_s}$$

$$x = \frac{\alpha_e \cdot A_s}{b} \cdot \left(-1 + \sqrt{1 + \frac{2 \cdot b \cdot d}{\alpha_e \cdot A_s}} \right)$$

$$\sigma_s = \frac{M_{Ed}}{z \cdot A_s} \approx \frac{M_{Ed}}{\left(d - \frac{x}{3}\right)}$$

Za C 30/37 $\rightarrow f_{ct,eff} = 29 \text{ MPa}$

$A_s = Q - 636 = 6,36 \text{ cm}^2$

$\varepsilon_{cm} = 33,0 \text{ GPa} = 33000 \text{ MPa}$ – Modul elastičnosti betona

$\varepsilon_{sm} = 200,0 \text{ GPa} = 33000 \text{ MPa}$ – Modul elastičnosti armature

$k_t = 0,4$ – Dugotrajno opterećenje

$\alpha_e = \frac{E_s}{E_{cm}} = \frac{200}{33} = 6,06$ – Odnos modula elastičnosti armature i betona

Djelotvorni koeficijent armiranja glavnom vlačnom armaturom:

$$\rho_{p,eff} = \frac{A_s}{A_{c,eff}} = \frac{6,36}{100 \cdot (2,5 \cdot 3)} = 0,00848$$

Srednji razmak pukotina:

$$S_{r,max} = k_3 \cdot c + k_1 \cdot k_2 \cdot k_4 \cdot \frac{\emptyset}{\rho_{p,eff}} [\text{mm}]$$

$$\emptyset = 9\text{mm} - (Q - 6,36 \rightarrow \emptyset 10/10)$$

$c = 20\text{ mm}$ – zaštitni sloj uzdužne armature

$k_1 = 0,8$ – rebrasta armatura

$k_2 = 0,5$ – savijanje

$k_3 = 3,4$

$k_4 = 0,425$

$b =$	100,0	cm	$d =$	15,0	cm	$h =$	18,0	cm
$f_{ck} =$	30,0	MN/m ²	$f_{ctm} =$	2,90	MN/m ²	$w_g =$	0,30	mm
$A_{s1} =$	6,36	cm ²	$A_{s2} =$	0,00	cm ²	$d_1 = d_2 =$	3,0	cm
$E_s =$	200,00	GN/m ²	$E_{cm} =$	33,00	GN/m ²	$\alpha_e =$	6,1	
			$E_s/E_{cm} =$					
$M_{Ed} =$	19,34	kNm	$k_t =$	0,40				
$\sigma_s =$	217,40	MN/m ²						
$x =$	3,04	cm	$\rho_{p,eff} =$	0,00848				
$(\epsilon_{sm} - \epsilon_{cm}) =$	0,000369	<	$0,6 \cdot \sigma_s/E_s =$	0,000652				
$\emptyset =$	9,0	mm	$c =$	2,00	cm			
$k_1 =$	0,8		$k_2 =$	0,50				
$k_3 =$	3,4		$k_4 =$	0,43				
$s_{r,max} =$	248,42	mm						
			$\frac{w_k = s_{r,max}}{(\epsilon_{sm} - \epsilon_{cm})} =$	0,162	mm	<	w_g	

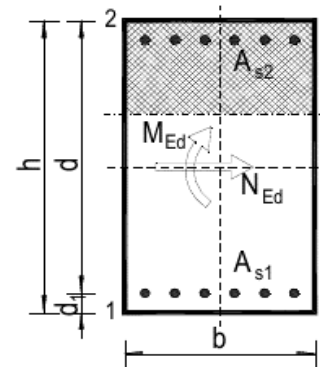

$$w_k = s_{r,max} \cdot (\epsilon_{sm} - \epsilon_{sm}) = 0,162\text{ mm} < w_g = 0,3\text{ mm}$$

Pukotine zadovoljavaju

3.2.5. Kontrola progiba

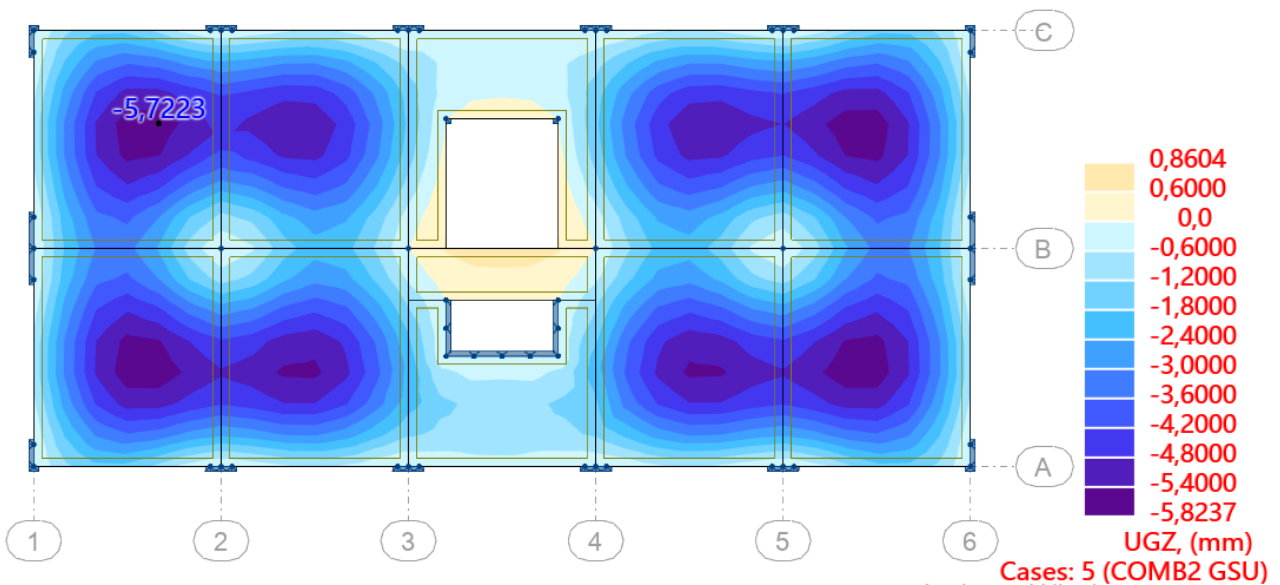

Slika 3.22. Ukupan progib za GSU

-Progib za ploču pozicije 100

$$M_{Ed,polje} = 19,34 \text{ kNm}$$

$$M_{Ed,rub} = 2,64 \text{ kNm}$$

$$M_{Ed,ležaj} = 23,59 \text{ kNm}$$

$$\text{Granični progib: } f_{p,dop} = \frac{l}{250} = \frac{6000}{250} = 24,0 \text{ mm}$$

$$v_{tot} = k \cdot l^2 \cdot \frac{1}{r_{tot}}$$

$$\beta = \frac{|M_{Ed,rub} + M_{Ed,ležaj}|}{|M_{Ed,polje}|} = \frac{|2,64 + 23,59|}{|19,34|} = 1,36$$

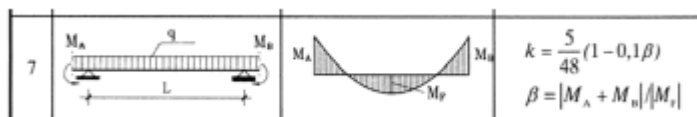

$$k = \frac{5}{48} \cdot (1 - 0,1 \cdot 1,36) = 0,09 \text{ – koeficijent ovisan o statičkom sustavu i opterećenju}$$

$$l = 600 \text{ cm raspon elementa}$$

$$\frac{1}{r_{tot}} = \frac{1}{r_m} + \frac{1}{r_{csm}}$$

r_{tot} – ukupna zakrivljenost

r_m – zakrivljenost zbog opterećenja i puzanja

r_{csm} – zakrivljenost zbog skupljanja

$$E_{cm} = 9500 \cdot (f_{ck} + 8)^{\frac{1}{3}} = 9500 \cdot (30 + 8)^{\frac{1}{3}} = 31938,77 \frac{N}{mm^2} - \text{modul elastičnosti betona}$$

$E = 200000N/mm^2$ – modul elastičnosti čelika

$$\alpha_e = \frac{200000}{31938,77} = 6,26 - \text{omjer module elastičnosti i čelika}$$

Moment tromosti za neraspucano stanje:

$$I_i = \frac{b \cdot h^3}{12} + \alpha_e \cdot (A_{S1} \cdot \left(\frac{h}{2} - d_2\right)^2 + A_{S2} \cdot \left(\frac{h}{2} - d_1\right)^2)$$

$$I_i = 48600 + 6,26 \cdot \left(6,36 \cdot \left(\frac{18}{2} - 3\right)^2 + 0 \cdot \left(\frac{18}{2} - 3\right)^2\right) = 50033,30 \text{ cm}^4$$

$$\frac{1}{r_I} = \frac{M_{Ed}}{E_{c,eff} \cdot I_i} = \frac{1934}{3194 \cdot 50033,30} = 0,0000121 \frac{1}{cm}$$

$$x = \frac{\alpha_{el} \cdot A_{S1}}{b} \cdot \left(-1 + \sqrt{1 + \frac{2bd}{\alpha_{el} \cdot A_{S1}}}\right) = 3,04 - \text{položaj neutralne osi}$$

Moment tromosti za raspucalo stanje:

$$I_{II} = \frac{b \cdot x^3}{12} + b \cdot x \cdot \left(\frac{x}{2}\right)^2 + \alpha_e \cdot [A_{S1} \cdot (d - x)^2 + A_{S2} \cdot (x - d_2)^2]$$

$$I_{II} = 234,12 + 702,36 + 5695,00 = 6631,48 \text{ cm}^4$$

$$\frac{1}{r_{II}} = \frac{M_{Ed}}{E_{c,eff} \cdot I_{II}} = \frac{1934}{3194 \cdot 6631,48} = 0,000091 \frac{1}{cm}$$

$$\sigma_{sr} = \frac{M_{cr}}{z \cdot A_s} M_{cr} = f_{ctm} \cdot \frac{b \cdot h^2}{6} f_{ctm} \approx 0,3 \cdot f_{ck}^{\frac{2}{3}} f_{ck} = 30 \text{ MPa}$$

$$f_{ctm} \approx 0,3 \cdot f_{ck}^{\frac{2}{3}} = 0,3 \cdot 30^{\frac{2}{3}} = 2,9 \text{ MPa}$$

$$M_{cr} = f_{ctm} \cdot \frac{b \cdot h^2}{6} = 0,29 \cdot \frac{100 \cdot 18^2}{6} = 1566 \text{ kNcm} = 15,66 \text{ kNm}$$

$$\sigma_{sr} = \frac{M_{cr}}{z \cdot A_s} = \frac{M_{cr}}{\left(d - \frac{x}{3}\right) \cdot A_s} = \frac{1566}{13,98 \cdot 6,36} = 17,61 \text{ kN/cm}^2 = 176,13 \text{ N/m}^2$$

$$\sigma_s = \frac{M_{Ed}}{z \cdot A_{s1}} = \frac{M_{Ed}}{\left(d - \frac{x}{3}\right) \cdot A_{s1}} = \frac{1934}{13,98 \cdot 6,36} = 21,75 \text{ kN/cm}^2 = 217,52 \text{ N/m}^2$$

$$\zeta = 1 - \beta_1 \cdot \beta_2 \cdot \left(\frac{\sigma_{sr}}{\sigma_s}\right)^2 - \text{koeficijent raspodjele}$$

$\beta_1 = 1$ – koeficijent koji uzima u obzir vrstu armature

$\beta_2 = 0,5$ – koeficijent koji uzima u obzir trajanje opterećenja

$$\zeta = 1 - 1 \cdot 0,5 \cdot \left(\frac{176,13}{217,52}\right)^2 = 0,672$$

$$\frac{1}{r_m} = \zeta \cdot \frac{1}{r_I} + (1 - \zeta) \cdot \frac{1}{r_{II}} = 0,672 \cdot 0,0000121 + (1 - 0,672) \cdot 0,000091 = 0,000038 \frac{1}{\text{cm}}$$

$$v_{tot} = k \cdot l^2 \cdot \frac{1}{r_{tot}} = 0,09 \cdot 600^2 \cdot 0,000038 = 1,23 \text{ cm} < v_{lim} = 2,4 \text{ cm}$$

Progibi zadovoljavaju

4. PRORAČUN GREDA

Grede su u modelu modelirane kao 1D štapni elementi. Grede su poprečnog presjeka 25/50cm različitih duljina. AB grede su napravljene od betona klase C30/37 i armirane armaturom B500B. Zaštitni sloj betona od armature iznosi 5cm. Proračun greda na savijanje i poprečnu silu je prikazan samo za grede G206 (najveći moment u smjeru x) i G218 (najveći moment u smjeru y).

4.1. Grede pozicije 200

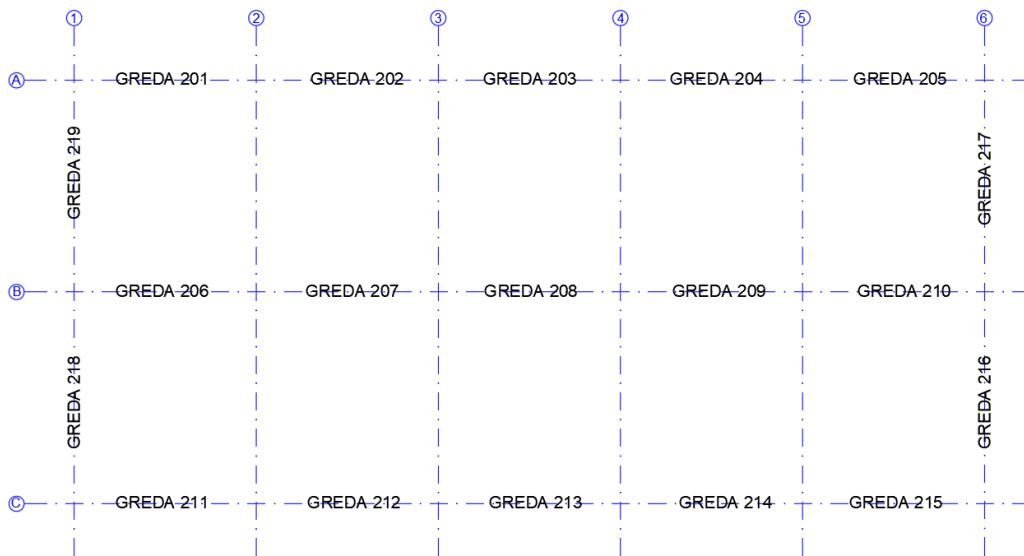

Slika 4.1. Prikaz greda pozicije 200

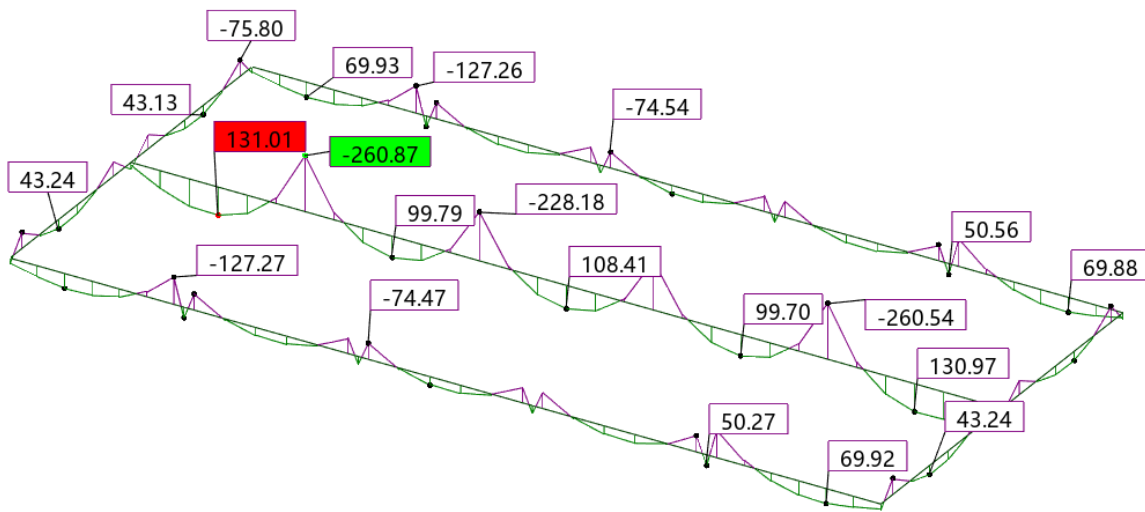

Slika 4.2. Prikaz momenata savijanja M_y

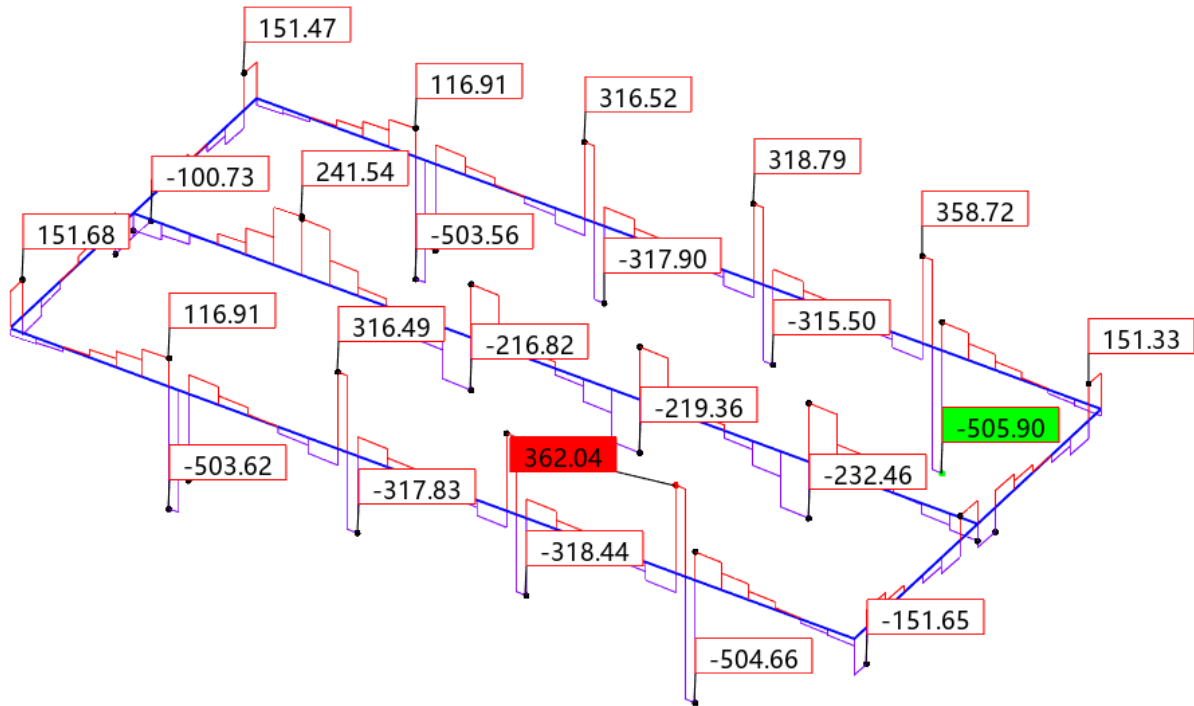
Slika 4.3. Prikaz poprečnih sila F_s

4.1.1. Dimenzioniranje na moment savijanje za gredu G206

Beton: C30/37 $f_{ck} = 30\text{MPa}$ $f_{cd} = \frac{f_{ck}}{1,5} = \frac{30}{1,5} = 20\text{MPa} = 2\text{kN/cm}^2$

Armatura: B500B $f_{yk} = 500\text{MPa}$ $f_{yd} = \frac{f_{yk}}{1,15} = \frac{500}{1,15} = 434,8\text{MPa} = 43,48\text{kN/cm}^2$

Utjecajna širina: $b_{eff} = b_w + \frac{0,85 \cdot L}{5} \leq e \rightarrow b_{eff} = 25 + \frac{0,85 \cdot 600}{5} = 127 \leq 600\text{cm}$

Polje:

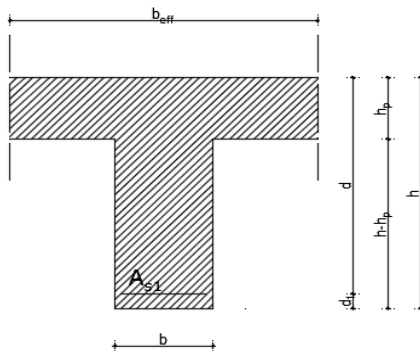

Slika 4.4. Prikaz grede 25x50cm

$$M_{Ed} = 131,01 \text{ kNm}$$

$$\mu_{Ed} = \frac{M_{Ed}}{b_{eff} \cdot d^2 \cdot f_{cd}} = \frac{131,01 \cdot 100}{127 \cdot 45^2 \cdot 2,0} = 0,025$$

$$\text{Za } \varepsilon_{s1} = 10\text{‰}, \quad \varepsilon_{c2} = 0,9\text{‰}, \quad \zeta = 0,971, \quad \xi = 0,083$$

$$x = \xi \cdot d = 0,083 \cdot 45 = 3,74 \text{ cm} < h_{pl}$$

$$A_{S1} = \frac{M_{Ed}}{\zeta \cdot d \cdot f_{yd}} = \frac{131,01 \cdot 100}{0,971 \cdot 45 \cdot 43,48} = 6,90 \text{ cm}^2$$

Odabrana armatura: 4Ø16 (8,04 cm²)

Ležaj:

$$M_{Ed} = 260,87 \text{ kNm}$$

$$\mu_{Ed} = \frac{M_{Ed}}{b \cdot d^2 \cdot f_{cd}} = \frac{260,87 \cdot 100}{127 \cdot 45^2 \cdot 2,0} = 0,051$$

$$\text{Za } \varepsilon_{s1} = 10\text{‰}, \quad \varepsilon_{c2} = 1,4\text{‰}, \quad \zeta = 0,956, \quad \xi = 0,123$$

$$x = \xi \cdot d = 0,123 \cdot 45 = 5,54 \text{ cm} < h_{pl}$$

$$A_{S1} = \frac{M_{Ed}}{\zeta \cdot d \cdot f_{yd}} = \frac{260,87 \cdot 100}{0,956 \cdot 45 \cdot 43,48} = 13,95 \text{ cm}^2$$

Odabrana armatura: 4Ø22 (15,21cm²)

4.1.2. Dimenzioniranje na poprečnu silu za gredu G206

$$\text{Beton: C 30/37} \quad f_{cd} = \frac{f_{ck}}{\gamma_c} = \frac{30}{1,5} = 20 \text{ MPa}; \quad f_{cd} = 2,0 \text{ kN/cm}^2$$

$$\text{Armatura: B 500 B} \quad f_{yd} = \frac{f_{yk}}{\gamma_s} = \frac{500}{1,5} = 333,33 \text{ MPa}; \quad f_{yd} = 43,5 \frac{\text{kN}}{\text{cm}^2}$$

$$\text{Računska poprečna sila: } V_{Ed,max} = 241,54 \text{ kN}$$

$$b_w = 25,0 \text{ cm}, \quad d = 50,0 \text{ cm}$$

$$\sum A_s = 8,04 + 15,21 + 3,08 = 26,33 \text{ cm}^2$$

$$\rho_l = \frac{\sum A_s}{A_c} = \frac{26,33}{25 \cdot 50} = 0,021$$

Poprečna sila koju presjek može preuzeti bez poprečne armature:

$$V_{Rd,c} = \left[C_{Rdc} \cdot k \cdot (100 \cdot \rho_1 \cdot f_{ck})^{\frac{1}{3}} + k_1 \cdot \sigma_{cp} \right] \cdot b_w \cdot d$$

$$k = 1,0 + \sqrt{\frac{200}{d}} = 1,0 + \sqrt{\frac{200}{450}} = 1,67 < 2,0 \rightarrow k = 1,67$$

$$k_1 = 0,15$$

$$\sigma_{cp} = \frac{N_{Ed}}{A_c} = 0,0$$

$$C_{Rdc} = \frac{0,18}{\gamma_c} = \frac{0,18}{1,5} = 0,12$$

$$V_{Rd,c} = \left[0,12 \cdot 1,67 \cdot (100 \cdot 0,021 \cdot 30,0)^{\frac{1}{3}} + 0,15 \cdot 0,0 \right] \cdot 250 \cdot 450 = 89,71 \text{ kN}$$

$$V_{Rd,c} \geq [v_{\min} + k_1 \cdot \sigma_{cp}] \cdot b_w \cdot d$$

$$k_1 = 0,15$$

$$v_{\min} = 0,035 \cdot k^{\frac{3}{2}} \cdot f_{ck}^{\frac{1}{2}} = 0,035 \cdot 1,67^{\frac{3}{2}} \cdot 30,0^{\frac{1}{2}} = 0,413$$

$$\sigma_{cp} = \frac{N_{Ed}}{A_c} = 0,0$$

$$V_{Rd,c} \geq 0,413 \cdot 250 \cdot 450$$

$$V_{Rd,c} \geq 46462,5 \text{ N} = 46,46 \text{ kN}$$

Maksimalna poprečna sila koju se ne smije prijeći (dio poprečne sile koju mogu preuzeti tlačne dijagonale):

$$V_{Rd,max} = 0,5 \cdot v \cdot b_w \cdot d \cdot f_{cd}$$

$$v = 0,6 \cdot \left[1,0 - \frac{f_{ck}}{250} \right] = 0,6 \cdot \left[1,0 - \frac{30}{250} \right] = 0,528$$

$$V_{Rd,max} = 0,5 \cdot 0,528 \cdot 250 \cdot 450 \cdot 20,0 = 594000 \text{ N} = 594 \text{ kN} > V_{Ed,max}$$

$$V_{Ed,max} = 241,54 \text{ kN}$$

$$\frac{V_{Ed,max}}{V_{Rd,max}} = \frac{241,54}{594} \approx 0,41 \rightarrow V_{Ed} = 0,15 \cdot V_{Rd,max}$$

$$s_{\max} = \min\{0,75 \cdot d ; 30,0 \text{ cm}\} = \min\{0,75 \cdot 45 = 33,75 ; 30,0 \text{ cm}\} \rightarrow s_{\max} = 30,0 \text{ cm}$$

$$\rho_{w,\min} = 0,00100$$

Maksimalni razmak spona:

$$s \leq \frac{m \cdot A_{sw}}{\rho_{w,\min} \cdot b_w} = \frac{2 \cdot A_{sw}}{0,00100 \cdot 25} = \frac{2 \cdot 0,79}{0,00100 \cdot 25} = 63,2 \text{ cm}$$

Odabrane spona: $\emptyset 10/30 \text{ cm}$

$$V_{Rd} = V_{Rd,s} = \frac{A_{sw}}{s} \cdot z \cdot f_{yw,d} \cdot m \cdot \text{ctg}\theta$$

$$z = 0,9 \cdot d = 0,9 \cdot 45 = 40,5 \text{ cm}$$

$$V_{Rd,s} = \frac{0,79}{30} \cdot 40,5 \cdot 43,5 \cdot 2 = 92,79 \text{ kN}$$

$$V_{Ed,a} > V_{Rd,s}$$

Kontrola nosivosti betona:

$$V_{Rd,\max} = \frac{\alpha_{cw} \cdot b_w \cdot z \cdot v_1 \cdot f_{cd}}{\tan\theta + \text{ctg}\theta} = \frac{1,0 \cdot 250,0 \cdot 405 \cdot 0,60 \cdot 20,0}{1 + 1} = 607,5 \text{ kN} > V_{Ed,\max}$$

Odabrane spona zadovoljavaju.

$$s_{\text{pot}} \leq \frac{m \cdot A_{sw} \cdot f_{yw,d} \cdot z}{V_{sd}} = \frac{2 \cdot 0,79 \cdot 43,5 \cdot 40,5}{241,54} = 11,52 \text{ cm}$$

Odabrane spona na mjestu maksimalne poprečne sile: $\emptyset 10/10 \text{ cm}$

4.1.3. Dimenzioniranje na moment savijanje za gredu G218

$$\text{Beton: } C30/37 \quad f_{ck} = 30 \text{ MPa} \quad f_{cd} = \frac{f_{ck}}{1,5} = \frac{30}{1,5} = 20 \text{ MPa} = 2 \text{ kN/cm}^2$$

$$\text{Armatura: } B500B \quad f_{yk} = 500 \text{ MPa} \quad f_{yd} = \frac{f_{yk}}{1,15} = \frac{500}{1,15} = 434,8 \text{ MPa} = 43,48 \text{ kN/cm}^2$$

$$\text{Utjecajna širina: } b_{eff} = b_w + \frac{0,85 \cdot L}{5} \leq e \rightarrow b_{eff} = 25 + \frac{0,85 \cdot 698}{5} = 143,6 \leq 600 \text{ cm}$$

Polje:

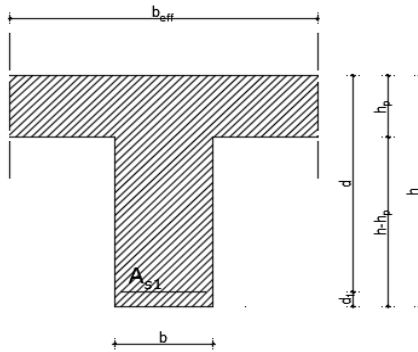

Slika 4.5. Prikaz grede 25x50cm

$$M_{Ed} = 43,24 \text{ kNm}$$

$$\mu_{Ed} = \frac{M_{Ed}}{b_{eff} \cdot d^2 \cdot f_{cd}} = \frac{43,24 \cdot 100}{143,6 \cdot 45^2 \cdot 2,0} = 0,007$$

$$\text{Za } \varepsilon_{s1} = 10\text{‰}, \quad \varepsilon_{c2} = 0,5\text{‰}, \quad \zeta = 0,984, \quad \xi = 0,048$$

$$x = \xi \cdot d = 0,048 \cdot 45 = 2,16 \text{ cm} < h_{pl}$$

$$A_{s1} = \frac{M_{Ed}}{\zeta \cdot d \cdot f_{yd}} = \frac{43,24 \cdot 100}{0,984 \cdot 45 \cdot 43,48} = 2,24 \text{ cm}^2$$

Odabrana armatura: 4Ø14 (6,16 cm²)

Ležaj:

$$M_{Ed} = 75,80 \text{ kNm}$$

$$\mu_{Ed} = \frac{M_{Ed}}{b \cdot d^2 \cdot f_{cd}} = \frac{75,80 \cdot 100}{143,6 \cdot 45^2 \cdot 2,0} = 0,013$$

$$\text{Za } \varepsilon_{s1} = 10\text{‰}, \quad \varepsilon_{c2} = 0,7\text{‰}, \quad \zeta = 0,977, \quad \xi = 0,065$$

$$x = \xi \cdot d = 0,065 \cdot 45 = 2,93 \text{ cm} < h_{pl}$$

$$A_{S1} = \frac{M_{Ed}}{\zeta \cdot d \cdot f_{yd}} = \frac{75,80 \cdot 100}{0,977 \cdot 45 \cdot 43,48} = 3,97 \text{ cm}^2$$

Odabrana armatura: 4Ø16 (8,04 cm²)

4.1.4. Dimenzioniranje na poprečnu silu za gredu G218

Beton: C 30/37 $f_{cd} = \frac{f_{ck}}{\gamma_c} = \frac{30}{1,5} = 20 \text{ MPa}$; $f_{cd} = 2,0 \text{ kN/cm}^2$

Armatura: B 500 B $f_{yd} = \frac{f_{yk}}{\gamma_s} = \frac{500}{1,5} = 333,33 \text{ MPa}$; $f_{yd} = 33,3 \frac{\text{kN}}{\text{cm}^2}$

Računska poprečna sila: $V_{Ed,max} = 151,68 \text{ kN}$

$$b_w = 25,0 \text{ cm}, d = 50,0 \text{ cm}$$

$$\sum A_s = 3,14 + 8,04 + 3,08 = 14,26 \text{ cm}^2$$

$$\rho_l = \frac{\sum A_s}{A_c} = \frac{14,26}{25 \cdot 50} = 0,0114$$

Poprečna sila koju presjek može preuzeti bez poprečne armature:

$$V_{Rd,c} = \left[C_{Rdc} \cdot k \cdot (100 \cdot \rho_l \cdot f_{ck})^{\frac{1}{3}} + k_1 \cdot \sigma_{cp} \right] \cdot b_w \cdot d$$

$$k = 1,0 + \sqrt{\frac{200}{d}} = 1,0 + \sqrt{\frac{200}{450}} = 1,67 < 2,0 \rightarrow k = 1,67$$

$$k_1 = 0,15$$

$$\sigma_{cp} = \frac{N_{Ed}}{A_c} = 0,0$$

$$C_{Rdc} = \frac{0,18}{\gamma_c} = \frac{0,18}{1,5} = 0,12$$

$$V_{Rd,c} = \left[0,12 \cdot 1,67 \cdot (100 \cdot 0,0114 \cdot 30,0)^{\frac{1}{3}} + 0,15 \cdot 0,0 \right] \cdot 250 \cdot 450 = 73,18 \text{ kN}$$

$$V_{Rd,c} \geq [v_{min} + k_1 \cdot \sigma_{cp}] \cdot b_w \cdot d$$

$$k_1 = 0,15$$

$$v_{min} = 0,035 \cdot k^{\frac{3}{2}} \cdot f_{ck}^{\frac{1}{2}} = 0,035 \cdot 1,67^{\frac{3}{2}} \cdot 30,0^{\frac{1}{2}} = 0,413$$

$$\sigma_{cp} = \frac{N_{Ed}}{A_c} = 0,0$$

$$V_{Rd,c} \geq 0,413 \cdot 250 \cdot 450$$

$$V_{Rd,c} \geq 46462,5 \text{ N} = 46,46 \text{ kN}$$

Maksimalna poprečna sila koju se ne smije prijeći (dio poprečne sile koju mogu preuzeti tlačne dijagonale):

$$V_{Rd,max} = 0,5 \cdot v \cdot b_w \cdot d \cdot f_{cd}$$

$$v = 0,6 \cdot \left[1,0 - \frac{f_{ck}}{250} \right] = 0,6 \cdot \left[1,0 - \frac{30}{250} \right] = 0,528$$

$$V_{Rd,max} = 0,5 \cdot 0,528 \cdot 250 \cdot 450 \cdot 20,0 = 594000 \text{ N} = 594 \text{ kN} > V_{Ed,max}$$

$$V_{Ed,max} = 151,68 \text{ kN}$$

$$\frac{V_{Ed,max}}{V_{Rd,max}} = \frac{151,68}{594} \approx 0,26 \rightarrow V_{Ed} = 0,15 \cdot V_{Rd,max}$$

$$s_{max} = \min\{0,75 \cdot d ; 30,0 \text{ cm}\} = \min\{0,75 \cdot 45 = 33,75 ; 30,0 \text{ cm}\} \rightarrow s_{max} = 30,0 \text{ cm}$$

$$\rho_{w,min} = 0,00100$$

Maksimalni razmak spona:

$$s \leq \frac{m \cdot A_{sw}}{\rho_{w,min} \cdot b_w} = \frac{2 \cdot A_{sw}}{0,00100 \cdot 25} = \frac{2 \cdot 0,79}{0,00100 \cdot 25} = 63,2 \text{ cm}$$

Odabrane spona: $\emptyset 10/30 \text{ cm}$

$$V_{Rd} = V_{Rd,s} = \frac{A_{sw}}{s} \cdot z \cdot f_{ywd} \cdot m \cdot \text{ctg}\theta$$

$$z = 0,9 \cdot d = 0,9 \cdot 45 = 40,5 \text{ cm}$$

$$V_{Rd,s} = \frac{0,79}{30} \cdot 40,5 \cdot 43,5 \cdot 2 = 92,79 \text{ kN}$$

$$V_{Ed,a} > V_{Rd,s}$$

Kontrola nosivosti betona:

$$V_{Rd,max} = \frac{\alpha_{cw} \cdot b_w \cdot z \cdot v_1 \cdot f_{cd}}{\tan\theta + \text{ctg}\theta} = \frac{1,0 \cdot 250,0 \cdot 405 \cdot 0,60 \cdot 20,0}{1 + 1} = 607,5 \text{ kN} > V_{Ed,max}$$

Odabrane spona zadovoljavaju.

$$s_{pot} \leq \frac{m \cdot A_{sw} \cdot f_{ywd} \cdot z}{V_{sd}} = \frac{2 \cdot 0,79 \cdot 43,5 \cdot 40,5}{151,68} = 18,35 \text{ cm}$$

Odabrane spona na mjestu maksimalne poprečne sile: $\emptyset 10/15 \text{ cm}$

4.1.5. Kontrola graničnog stanja uporabljivosti

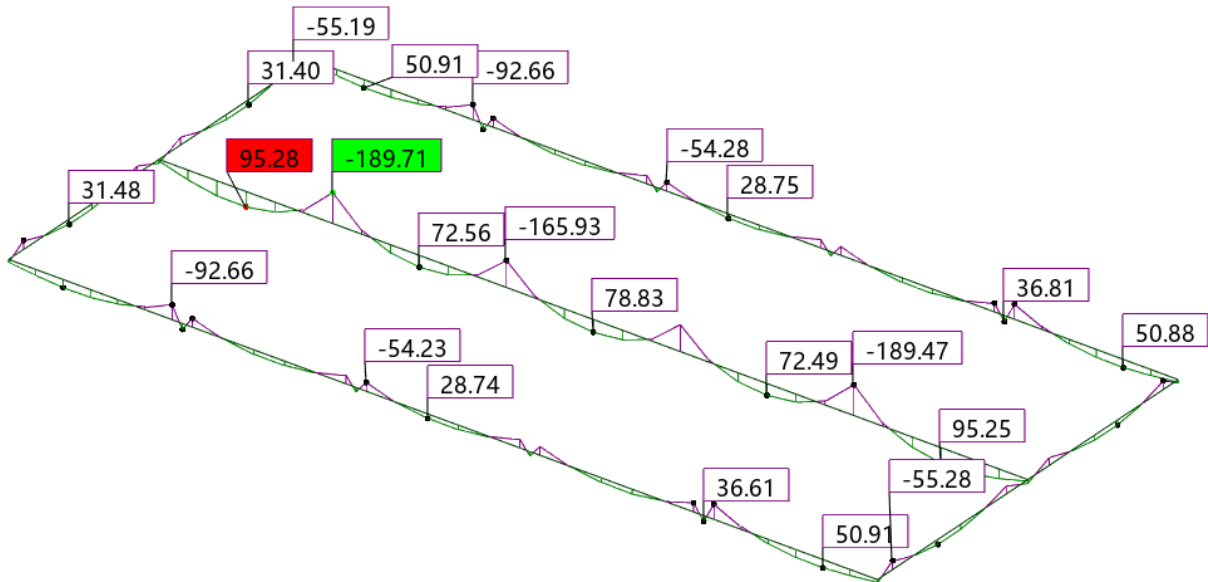

Slika 4.6. Prikaz momenata savijanja M_y za GSU

Pukotine:

Mjerodavni momenti u ploči dobiveni su iz kombinacija za granično stanje uporabljivosti.

Polje:

$$M_{Ed} = 95,28 \text{ kNm}$$

Prognozna širina pukotine: $w_k = s_{r,max} \cdot (\varepsilon_{sm} - \varepsilon_{cm})$

Vrijednost $(\varepsilon_{sm} - \varepsilon_{cm})$ određuje se prema izrazu:

$$(\varepsilon_{cm} - \varepsilon_{sm}) = \frac{\sigma_s - k_t \frac{f_{ct,eff}}{\rho_{p,eff}} (1 + \alpha_e \cdot \rho_{p,eff})}{E_s} \geq 0,6 \cdot \frac{\sigma_s}{E_s}$$

$$x = \frac{\alpha_e \cdot A_s}{b} \cdot \left(-1 + \sqrt{1 + \frac{2 \cdot b \cdot d}{\alpha_e \cdot A_s}} \right)$$

$$\sigma_s = \frac{M_{Ed}}{z \cdot A_s} \approx \frac{M_{Ed}}{\left(d - \frac{x}{3} \right)}$$

Za C 30/37 $\rightarrow f_{ct,eff} = 29 \text{ MPa}$

$A_s = 4\emptyset 16 = 8,04 \text{ cm}^2$

$\varepsilon_{cm} = 33,0 \text{ GPa} = 33000 \text{ MPa}$ – Modul elastičnosti betona

$\varepsilon_{sm} = 200,0 \text{ GPa} = 33000 \text{ MPa}$ – Modul elastičnosti armature

$k_t = 0,4$ – Dugotrajno opterećenje

$$\alpha_e = \frac{E_s}{E_{cm}} = \frac{200}{33} = 6,06 \text{ – Odnos modula elastičnosti armature i betona}$$

Djelotvorni koeficijent armiranja glavnom vlačnom armaturom:

$$\rho_{p,eff} = \frac{A_s}{A_{c,eff}} = \frac{8,04}{25 \cdot (2,5 \cdot 5)} = 0,0257$$

Srednji razmak pukotina:

$$s_{r,max} = k_3 \cdot c + k_1 \cdot k_2 \cdot k_4 \cdot \frac{\emptyset}{\rho_{p,eff}} [mm]$$

$$\emptyset = 16mm \text{ – } (4\emptyset 16)$$

$c = 40$ mm – zaštitni sloj uzdužne armature

$k_1 = 0,8$ – rebrasta armatura

$k_2 = 0,5$ – savijanje

$b =$	25,0	cm	$d =$	45,0	cm	$h =$	50,0	cm
$f_{ck} =$	30,0	MN/m ²	$f_{ctm} =$	2,90	MN/m ²	$w_g =$	0,30	mm
$A_{s1} =$	8,04	cm ²	$A_{s2} =$	0,00	cm ²	$d_1 = d_2 =$	5,0	cm
$E_s =$	200,00	GN/m ²	$E_{cm} =$	33,00	GN/m ²	$\alpha_e =$	6,1	
						$E_s/E_{cm} =$	6,1	
$M_{Ed} =$	95,28	kNm	$k_t =$	0,40				
$\sigma_s =$	287,73	MN/m ²						
$x =$	11,44	cm	$\rho_{p,eff} =$	0,02570				
$(\varepsilon_{sm} - \varepsilon_{cm}) =$	0,001178	>	$0,6 \cdot \sigma_s / E_s =$	0,000863				
$\emptyset =$	16,0	mm	$c =$	4,00	cm			
$k_1 =$	0,8		$k_2 =$	0,50				
$k_3 =$	3,4		$k_4 =$	0,43				
$s_{r,max} =$	241,84	mm						
			$w_k = s_{r,max} \cdot (\varepsilon_{sm} - \varepsilon_{cm}) =$	0,285	mm	<	w_g	

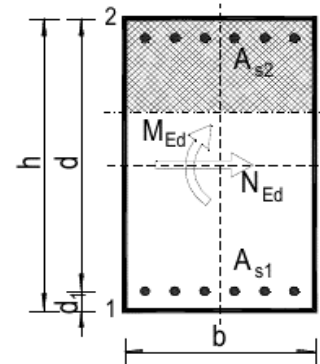

$$w_k = s_{r,max} \cdot (\varepsilon_{sm} - \varepsilon_{sm}) = 0,285 \text{ mm} < w_g = 0,3 \text{ mm}$$

Pukotine zadovoljavaju

Ležaj:

$$M_{Ed} = 189,71 \text{ kNm}$$

$b =$	25,0	cm	$d =$	45,0	cm	$h =$	50,0	cm
$f_{ck} =$	30,0	MN/m ²	$f_{ctm} =$	2,90	MN/m ²	$w_g =$	0,30	mm
$A_{s1} =$	15,21	cm ²	$A_{s2} =$	0,00	cm ²	$d_1 = d_2 =$	5,0	cm
$E_s =$	200,00	GN/m ²	$E_{cm} =$	33,00	GN/m ²	$\alpha_e =$	6,1	
$M_{Ed} =$	189,71	kNm	$k_t =$	0,40		$E_s/E_{cm} =$		
$\sigma_s =$	311,55	MN/m ²						
$x =$	14,90	cm	$\rho_{p,eff} =$	0,04860				
$(\epsilon_{sm} - \epsilon_{cm}) =$	0,001403	>	$0,6 \cdot \sigma_s / E_s =$	0,000935				
$\emptyset =$	22,0	mm	$c =$	4,00	cm			
$k_1 =$	0,8		$k_2 =$	0,50				
$k_3 =$	3,4		$k_4 =$	0,43				
$s_{r,max} =$	212,95	mm						
	$w_k = s_{r,max} \cdot (\epsilon_{sm} - \epsilon_{cm}) =$	0,299	mm	<	w_g			

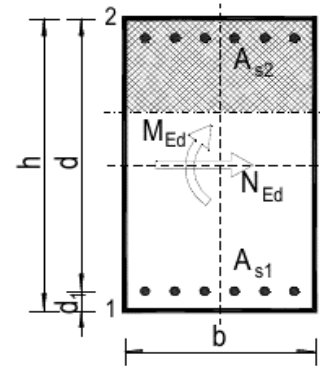

$$w_k = s_{r,max} \cdot (\epsilon_{sm} - \epsilon_{sm}) = 0,29\text{mm} < w_g = 0,3\text{mm}$$

Pukotine zadovoljavaju

4.2. Grede pozicije 100

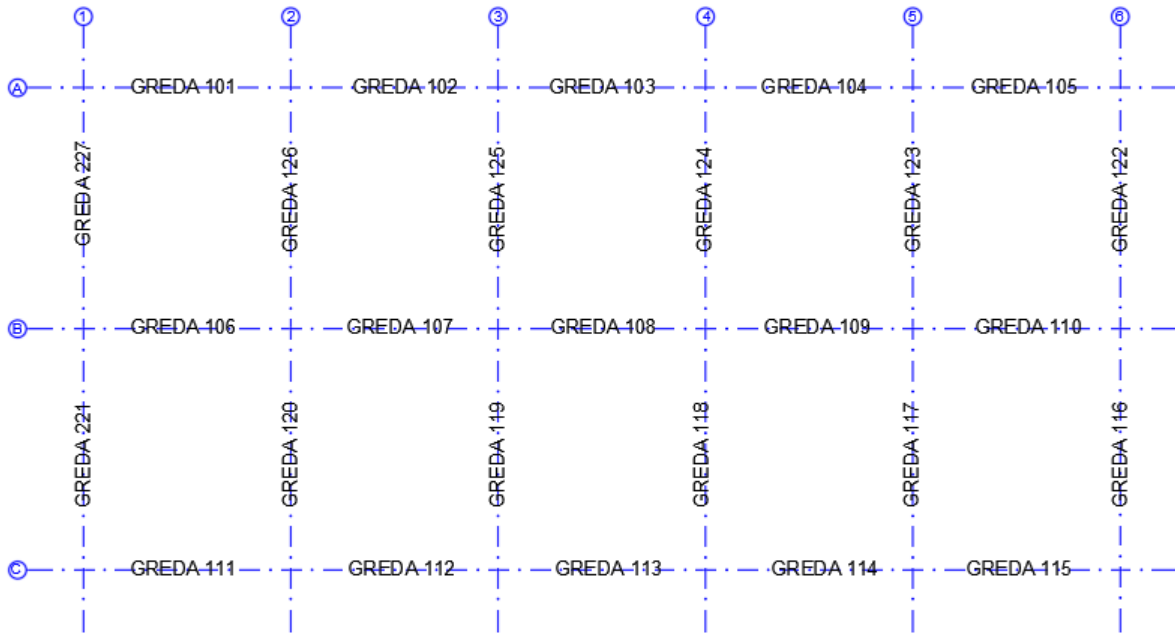

Slika 4.7. Prikaz greda pozicije 100

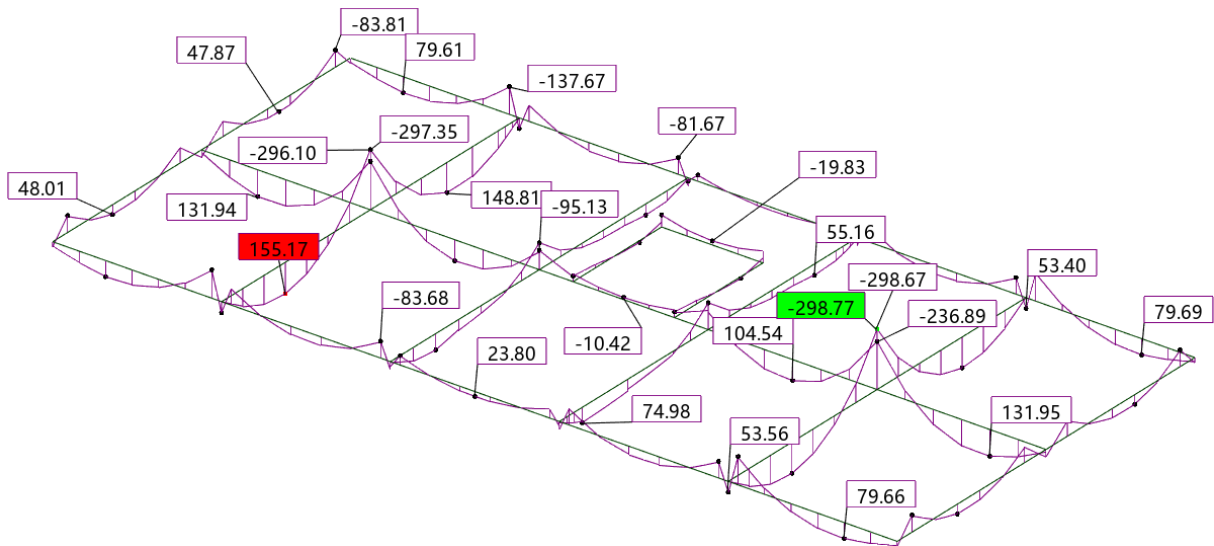

Slika 4.8. Prikaz momenata savijanja My

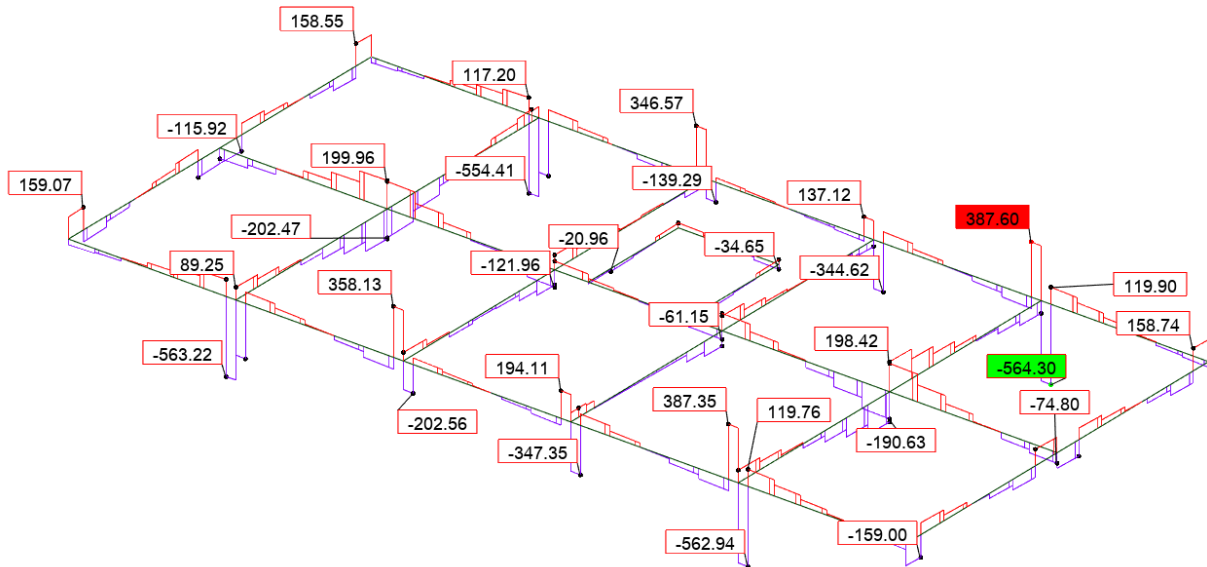
Slika 4.9. Prikaz poprečnih sila F_s

4.2.1. Dimenzioniranje na moment savijanje za gredu G120

$$\text{Beton: } C30/37 \quad f_{ck} = 30 \text{ MPa} \quad f_{cd} = \frac{f_{ck}}{1,5} = \frac{30}{1,5} = 20 \text{ MPa} = 2 \text{ kN/cm}^2$$

$$\text{Armatura: } B500B \quad f_{yk} = 500 \text{ MPa} \quad f_{yd} = \frac{f_{yk}}{1,15} = \frac{500}{1,15} = 434,8 \text{ MPa} = 43,48 \text{ kN/cm}^2$$

$$\text{Utjecajna širina: } b_{eff} = b_w + \frac{0,85 \cdot L}{5} \leq e \rightarrow b_{eff} = 25 + \frac{0,85 \cdot 698}{5} = 143,6 \leq 600 \text{ cm}$$

Polje:

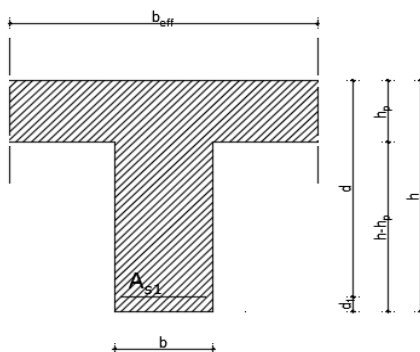

Slika 4.10. Prikaz grede 25x50cm

$$M_{Ed} = 155,17 \text{ kNm}$$

$$\mu_{Ed} = \frac{M_{Ed}}{b_{eff} \cdot d^2 \cdot f_{cd}} = \frac{155,17 \cdot 100}{143,6 \cdot 45^2 \cdot 2,0} = 0,026$$

$$\text{Za } \varepsilon_{s1} = 10\text{‰}, \quad \varepsilon_{c2} = 1,0\text{‰}, \quad \zeta = 0,968, \quad \xi = 0,091$$

$$x = \xi \cdot d = 0,091 \cdot 45 = 4,09 \text{ cm} < h_{pl}$$

$$A_{S1} = \frac{M_{Ed}}{\zeta \cdot d \cdot f_{yd}} = \frac{155,17 \cdot 100}{0,968 \cdot 45 \cdot 43,48} = 8,19 \text{ cm}^2$$

Odabrana armatura: 4Ø18 (10,18 cm²)

Ležaj:

$$M_{Ed} = 297,35 \text{ kNm}$$

$$\mu_{Ed} = \frac{M_{Ed}}{b \cdot d^2 \cdot f_{cd}} = \frac{297,35 \cdot 100}{143,6 \cdot 45^2 \cdot 2,0} = 0,051$$

$$\text{Za } \varepsilon_{s1} = 10\text{‰}, \quad \varepsilon_{c2} = 1,4\text{‰}, \quad \zeta = 0,956, \quad \xi = 0,123$$

$$x = \xi \cdot d = 0,123 \cdot 45 = 5,54 \text{ cm} < h_{pl}$$

$$A_{S1} = \frac{M_{Ed}}{\zeta \cdot d \cdot f_{yd}} = \frac{297,35 \cdot 100}{0,956 \cdot 45 \cdot 43,48} = 15,90 \text{ cm}^2$$

Odabrana armatura: 4Ø25 (19,36cm²)

4.2.2. Dimenzioniranje na poprečnu silu za gredu G120

$$\text{Beton: C 30/37} \quad f_{cd} = \frac{f_{ck}}{\gamma_c} = \frac{30}{1,5} = 20 \text{ MPa} ; f_{cd} = 2,0 \text{ kN/cm}^2$$

$$\text{Armatura: B 500 B} \quad f_{yd} = \frac{f_{yk}}{\gamma_c} = \frac{500}{1,5} = 333,33 \text{ MPa} ; f_{yd} = 43,5 \frac{\text{kN}}{\text{cm}^2}$$

$$\text{Računska poprečna sila: } V_{Ed,max} = 202,47 \text{ kN}$$

$$b_w = 25,0 \text{ cm}, d = 50,0 \text{ cm}$$

$$\sum A_s = 10,18 + 19,36 + 3,08 = 32,62 \text{ cm}^2$$

$$\rho_l = \frac{\sum A_s}{A_c} = \frac{32,62}{25 \cdot 50} = 0,026$$

Poprečna sila koju presjek može preuzeti bez poprečne armature:

$$V_{Rd,c} = \left[C_{Rdc} \cdot k \cdot (100 \cdot \rho_1 \cdot f_{ck})^{\frac{1}{3}} + k_1 \cdot \sigma_{cp} \right] \cdot b_w \cdot d$$

$$k = 1,0 + \sqrt{\frac{200}{d}} = 1,0 + \sqrt{\frac{200}{450}} = 1,67 < 2,0 \rightarrow k = 1,67$$

$$k_1 = 0,15$$

$$\sigma_{cp} = \frac{N_{Ed}}{A_c} = 0,0$$

$$C_{Rdc} = \frac{0,18}{\gamma_c} = \frac{0,18}{1,5} = 0,12$$

$$V_{Rd,c} = \left[0,12 \cdot 1,67 \cdot (100 \cdot 0,026 \cdot 30,0)^{\frac{1}{3}} + 0,15 \cdot 0,0 \right] \cdot 250 \cdot 450 = 96,33 \text{ kN}$$

$$V_{Rd,c} \geq [v_{\min} + k_1 \cdot \sigma_{cp}] \cdot b_w \cdot d$$

$$k_1 = 0,15$$

$$v_{\min} = 0,035 \cdot k^{\frac{3}{2}} \cdot f_{ck}^{\frac{1}{2}} = 0,035 \cdot 1,67^{\frac{3}{2}} \cdot 30,0^{\frac{1}{2}} = 0,413$$

$$\sigma_{cp} = \frac{N_{Ed}}{A_c} = 0,0$$

$$V_{Rd,c} \geq 0,413 \cdot 250 \cdot 450$$

$$V_{Rd,c} \geq 46462,5 \text{ N} = 46,46 \text{ kN}$$

Maksimalna poprečna sila koju se ne smije prijeći (dio poprečne sile koju mogu preuzeti tlačne dijagonale):

$$V_{Rd,max} = 0,5 \cdot v \cdot b_w \cdot d \cdot f_{cd}$$

$$v = 0,6 \cdot \left[1,0 - \frac{f_{ck}}{250} \right] = 0,6 \cdot \left[1,0 - \frac{30}{250} \right] = 0,528$$

$$V_{Rd,max} = 0,5 \cdot 0,528 \cdot 250 \cdot 450 \cdot 20,0 = 594000 \text{ N} = 594 \text{ kN} > V_{Ed,max}$$

$$V_{Ed,max} = 202,47 \text{ kN}$$

$$\frac{V_{Ed,max}}{V_{Rd,max}} = \frac{202,47}{594} \approx 0,34 \rightarrow V_{Ed} = 0,15 \cdot V_{Rd,max}$$

$$s_{\max} = \min\{0,75 \cdot d; 30,0 \text{ cm}\} = \min\{0,75 \cdot 45 = 33,75; 30,0 \text{ cm}\} \rightarrow s_{\max} = 30,0 \text{ cm}$$

$$\rho_{w,\min} = 0,00100$$

Maksimalni razmak spona:

$$s \leq \frac{m \cdot A_{sw}}{\rho_{w,\min} \cdot b_w} = \frac{2 \cdot A_{sw}}{0,00100 \cdot 25} = \frac{2 \cdot 0,79}{0,00100 \cdot 25} = 63,2 \text{ cm}$$

Odabrane spona: $\emptyset 10/30 \text{ cm}$

$$V_{Rd} = V_{Rd,s} = \frac{A_{sw}}{s} \cdot z \cdot f_{yw,d} \cdot m \cdot \text{ctg}\theta$$

$$z = 0,9 \cdot d = 0,9 \cdot 45 = 40,5 \text{ cm}$$

$$V_{Rd,s} = \frac{0,79}{30} \cdot 40,5 \cdot 43,5 \cdot 2 = 92,79 \text{ kN}$$

$$V_{Ed,a} > V_{Rd,s}$$

Kontrola nosivosti betona:

$$V_{Rd,\max} = \frac{\alpha_{cw} \cdot b_w \cdot z \cdot v_1 \cdot f_{cd}}{\tan\theta + \text{ctg}\theta} = \frac{1,0 \cdot 250,0 \cdot 405 \cdot 0,60 \cdot 20,0}{1 + 1} = 607,5 \text{ kN} > V_{Ed,\max}$$

Odabrane spona zadovoljavaju.

$$s_{\text{pot}} \leq \frac{m \cdot A_{sw} \cdot f_{yw,d} \cdot z}{V_{sd}} = \frac{2 \cdot 0,79 \cdot 43,5 \cdot 40,5}{202,47} = 13,75 \text{ cm}$$

Odabrane spona na mjestu maksimalne poprečne sile: $\emptyset 10/10 \text{ cm}$

4.2.3. Dimenzioniranje na moment savijanje za gredu G110

$$\text{Beton: } C30/37 \quad f_{ck} = 30 \text{ MPa} \quad f_{cd} = \frac{f_{ck}}{1,5} = \frac{30}{1,5} = 20 \text{ MPa} = 2 \text{ kN/cm}^2$$

$$\text{Armatura: } B500B \quad f_{yk} = 500 \text{ MPa} \quad f_{yd} = \frac{f_{yk}}{1,15} = \frac{500}{1,15} = 434,8 \text{ MPa} = 43,48 \text{ kN/cm}^2$$

$$\text{Utjecajna širina: } b_{eff} = b_w + \frac{0,85 \cdot L}{5} \leq e \rightarrow b_{eff} = 25 + \frac{0,85 \cdot 600}{5} = 127 \leq 600 \text{ cm}$$

Polje:

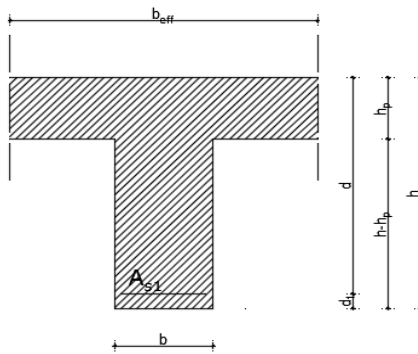

Slika 4.11. Prikaz grede 25x50cm

$$M_{Ed} = 131,95 \text{ kNm}$$

$$\mu_{Ed} = \frac{M_{Ed}}{b_{eff} \cdot d^2 \cdot f_{cd}} = \frac{131,95 \cdot 100}{127 \cdot 45^2 \cdot 2,0} = 0,026$$

$$\text{Za } \varepsilon_{s1} = 10\text{‰}, \quad \varepsilon_{c2} = 1,0\text{‰}, \quad \zeta = 0,968, \quad \xi = 0,091$$

$$x = \xi \cdot d = 0,091 \cdot 45 = 4,09 \text{ cm} < h_{pl}$$

$$A_{s1} = \frac{M_{Ed}}{\zeta \cdot d \cdot f_{yd}} = \frac{131,95 \cdot 100}{0,968 \cdot 45 \cdot 43,48} = 6,97 \text{ cm}^2$$

Odabrana armatura: 4Ø18 (10,18 cm²)

Ležaj:

$$M_{Ed} = 236,89 \text{ kNm}$$

$$\mu_{Ed} = \frac{M_{Ed}}{b \cdot d^2 \cdot f_{cd}} = \frac{236,89 \cdot 100}{127 \cdot 45^2 \cdot 2,0} = 0,046$$

$$\text{Za } \varepsilon_{s1} = 10\text{‰}, \quad \varepsilon_{c2} = 1,3\text{‰}, \quad \zeta = 0,959, \quad \xi = 0,115$$

$$x = \xi \cdot d = 0,115 \cdot 45 = 5,18 \text{ cm} < h_{pl}$$

$$A_{s1} = \frac{M_{Ed}}{\zeta \cdot d \cdot f_{yd}} = \frac{236,89 \cdot 100}{0,959 \cdot 45 \cdot 43,48} = 12,62 \text{ cm}^2$$

Odabrana armatura: 4Ø22 (15,21 cm²)

4.2.4. Dimenzioniranje na poprečnu silu za gredu G110

Beton: C 30/37 $f_{cd} = \frac{f_{ck}}{\gamma_c} = \frac{30}{1,5} = 20 \text{ MPa}$; $f_{cd} = 2,0 \text{ kN/cm}^2$

Armatura: B 500 B $f_{yd} = \frac{f_{yk}}{\gamma_s} = \frac{500}{1,5} = 333,33 \text{ MPa}$; $f_{yd} = 33,3 \frac{\text{kN}}{\text{cm}^2}$

Računska poprečna sila: $V_{Ed,max} = 198,42 \text{ kN}$

$$b_w = 25,0 \text{ cm}, d = 50,0 \text{ cm}$$

$$\sum A_s = 10,18 + 15,21 + 3,08 = 28,47 \text{ cm}^2$$

$$\rho_l = \frac{\sum A_s}{A_c} = \frac{28,47}{25 \cdot 50} = 0,0227$$

Poprečna sila koju presjek može preuzeti bez poprečne armature:

$$V_{Rd,c} = \left[C_{Rdc} \cdot k \cdot (100 \cdot \rho_l \cdot f_{ck})^{\frac{1}{3}} + k_1 \cdot \sigma_{cp} \right] \cdot b_w \cdot d$$

$$k = 1,0 + \sqrt{\frac{200}{d}} = 1,0 + \sqrt{\frac{200}{450}} = 1,67 < 2,0 \rightarrow k = 1,67$$

$$k_1 = 0,15$$

$$\sigma_{cp} = \frac{N_{Ed}}{A_c} = 0,0$$

$$C_{Rdc} = \frac{0,18}{\gamma_c} = \frac{0,18}{1,5} = 0,12$$

$$V_{Rd,c} = \left[0,12 \cdot 1,67 \cdot (100 \cdot 0,0227 \cdot 30,0)^{\frac{1}{3}} + 0,15 \cdot 0,0 \right] \cdot 250 \cdot 450 = 92,07 \text{ kN}$$

$$V_{Rd,c} \geq [v_{min} + k_1 \cdot \sigma_{cp}] \cdot b_w \cdot d$$

$$k_1 = 0,15$$

$$v_{min} = 0,035 \cdot k^{\frac{3}{2}} \cdot f_{ck}^{\frac{1}{2}} = 0,035 \cdot 1,67^{\frac{3}{2}} \cdot 30,0^{\frac{1}{2}} = 0,413$$

$$\sigma_{cp} = \frac{N_{Ed}}{A_c} = 0,0$$

$$V_{Rd,c} \geq 0,413 \cdot 250 \cdot 450$$

$$V_{Rd,c} \geq 46462,5 \text{ N} = 46,46 \text{ kN}$$

Maksimalna poprečna sila koju se ne smije prijeći (dio poprečne sile koju mogu preuzeti tlačne dijagonale):

$$V_{Rd,max} = 0,5 \cdot v \cdot b_w \cdot d \cdot f_{cd}$$

$$v = 0,6 \cdot \left[1,0 - \frac{f_{ck}}{250} \right] = 0,6 \cdot \left[1,0 - \frac{30}{250} \right] = 0,528$$

$$V_{Rd,max} = 0,5 \cdot 0,528 \cdot 250 \cdot 450 \cdot 20,0 = 594000 \text{ N} = 594 \text{ kN} > V_{Ed,max}$$

$$V_{Ed,max} = 198,42 \text{ kN}$$

$$\frac{V_{Ed,max}}{V_{Rd,max}} = \frac{198,42}{594} \approx 0,33 \rightarrow V_{Ed} = 0,30 \cdot V_{Rd,max}$$

$$s_{max} = \min\{0,75 \cdot d ; 30,0 \text{ cm}\} = \min\{0,75 \cdot 45 = 33,75 ; 30,0 \text{ cm}\} \rightarrow s_{max} = 30,0 \text{ cm}$$

$$\rho_{w,min} = 0,00100$$

Maksimalni razmak spona:

$$s \leq \frac{m \cdot A_{sw}}{\rho_{w,min} \cdot b_w} = \frac{2 \cdot A_{sw}}{0,00100 \cdot 25} = \frac{2 \cdot 0,79}{0,00100 \cdot 25} = 63,2 \text{ cm}$$

Odabrane spona: $\emptyset 10/30 \text{ cm}$

$$V_{Rd} = V_{Rd,s} = \frac{A_{sw}}{s} \cdot z \cdot f_{ywd} \cdot m \cdot \text{ctg}\theta$$

$$z = 0,9 \cdot d = 0,9 \cdot 45 = 40,5 \text{ cm}$$

$$V_{Rd,s} = \frac{0,79}{30} \cdot 40,5 \cdot 43,5 \cdot 2 = 92,79 \text{ kN}$$

$$V_{Ed,a} > V_{Rd,s}$$

Kontrola nosivosti betona:

$$V_{Rd,max} = \frac{\alpha_{cw} \cdot b_w \cdot z \cdot v_1 \cdot f_{cd}}{\tan\theta + \text{ctg}\theta} = \frac{1,0 \cdot 250,0 \cdot 405 \cdot 0,60 \cdot 20,0}{1 + 1} = 607,5 \text{ kN} > V_{Ed,max}$$

Odabrane spona zadovoljavaju.

$$s_{pot} \leq \frac{m \cdot A_{sw} \cdot f_{ywd} \cdot z}{V_{sd}} = \frac{2 \cdot 0,79 \cdot 43,5 \cdot 40,5}{198,42} = 14,03 \text{ cm}$$

Odabrane spona na mjestu maksimalne poprečne sile: $\emptyset 10/10 \text{ cm}$

4.2.5. Kontrola graničnog stanja uporabljivosti

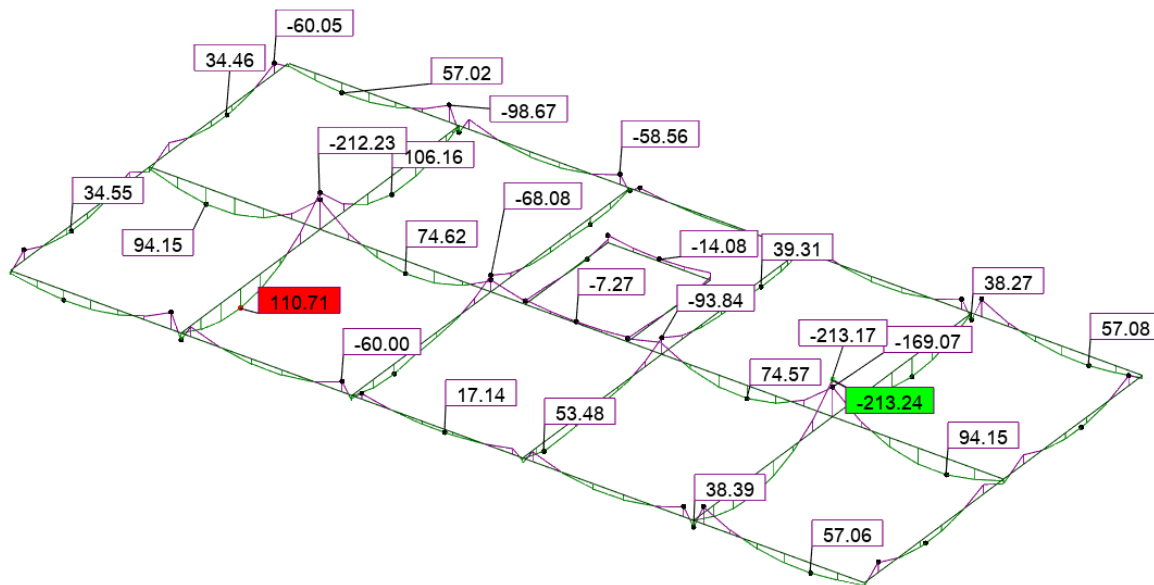

Slika 4.12. Prikaz momenata savijanja M_y za GSU

Pukotine:

Mjerodavni momenti u ploči dobiveni su iz kombinacija za granično stanje uporabljivosti.

Polje:

$$M_{Ed} = 110,71 \text{ kNm}$$

$$\text{Prognozna širina pukotine: } w_k = s_{r,max} \cdot (\varepsilon_{sm} - \varepsilon_{sm})$$

Vrijednost $(\varepsilon_{cm} - \varepsilon_{sm})$ određuje se prema izrazu:

$$(\varepsilon_{cm} - \varepsilon_{sm}) = \frac{\sigma_s - k_t \frac{f_{ct,eff}}{\rho_{p,eff}} (1 + \alpha_e \cdot \rho_{p,eff})}{E_s} \geq 0,6 \cdot \frac{\sigma_s}{E_s}$$

$$x = \frac{\alpha_e \cdot A_s}{b} \cdot \left(-1 + \sqrt{1 + \frac{2 \cdot b \cdot d}{\alpha_e \cdot A_s}} \right)$$

$$\sigma_s = \frac{M_{Ed}}{z \cdot A_s} \approx \frac{M_{Ed}}{\left(d - \frac{x}{3} \right)}$$

$$\text{Za C 30/37} \rightarrow f_{ct,eff} = 29 \text{ MPa}$$

$$A_s = 4\emptyset 18 = 10,18 \text{ cm}^2$$

$$\varepsilon_{cm} = 33,0 \text{ GPa} = 33000 \text{ MPa} - \text{Modul elastičnosti betona}$$

$\varepsilon_{sm} = 200,0 \text{ GPa} = 33000 \text{ MPa}$ – Modul elastičnosti armature

$k_t = 0,4$ – Dugotrajno opterećenje

$$\alpha_e = \frac{E_s}{E_{cm}} = \frac{200}{33} = 6,06 \text{ – Odnos modula elastičnosti armature i betona}$$

Djelotvorni koeficijent armiranja glavnom vlačnom armaturom:

$$\rho_{p,eff} = \frac{A_s}{A_{c,eff}} = \frac{10,18}{25 \cdot (2,5 \cdot 5)} = 0,0325$$

Srednji razmak pukotina:

$$s_{r,max} = k_3 \cdot c + k_1 \cdot k_2 \cdot k_4 \cdot \frac{\phi}{\rho_{p,eff}} [\text{mm}]$$

$$\phi = 18 \text{ mm} \text{ – } (4\phi 18)$$

$c = 40 \text{ mm}$ – zaštitni sloj uzdužne armature

$k_1 = 0,8$ – rebrasta armatura

$k_2 = 0,5$ – savijanje

$b =$	25,0	cm	$d =$	45,0	cm	$h =$	50,0	cm
$f_{ck} =$	30,0	MN/m ²	$f_{ctm} =$	2,90	MN/m ²	$w_g =$	0,30	mm
$A_{s1} =$	10,18	cm ²	$A_{s2} =$	0,00	cm ²	$d_1 = d_2 =$	5,0	cm
$E_s =$	200,00	GN/m ²	$E_{cm} =$	33,00	GN/m ²	$\frac{\alpha_e}{E_s/E_{cm}} =$	6,1	
$M_{Ed} =$	110,71	kNm	$k_t =$	0,40				
$\sigma_s =$	266,63	MN/m ²						
$x =$	12,64	cm	$\rho_{p,eff} =$	0,0325				
$(\varepsilon_{sm} - \varepsilon_{cm}) =$	0,001120	>	$0,6 \cdot \sigma_s / E_s =$	0,000800				
$\phi =$	18,0	mm	$c =$	4,00	cm			
$k_1 =$	0,8		$k_2 =$	0,50				
$k_3 =$	3,4		$k_4 =$	0,43				
$s_{r,max} =$	230,15	mm						

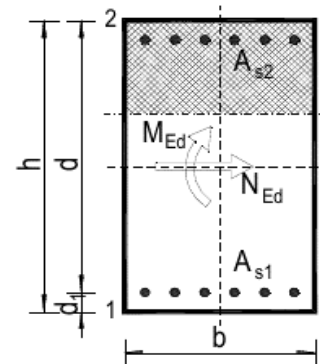

$$w_k = s_{r,max} \cdot (\varepsilon_{sm} - \varepsilon_{cm}) = 0,258 \text{ mm} < w_g = 0,3 \text{ mm}$$

$$w_k = s_{r,max} \cdot (\varepsilon_{sm} - \varepsilon_{sm}) = 0,258 \text{ mm} < w_g = 0,3 \text{ mm}$$

Pukotine zadovoljavaju

Ležaj:

$$M_{Ed} = 213,23 \text{ kNm}$$

$b =$	25,0	cm	$d =$	45,0	cm	$h =$	50,0	cm
$f_{ck} =$	30,0	MN/m ²	$f_{ctm} =$	2,90	MN/m ²	$w_g =$	0,30	mm
$A_{s1} =$	15,21	cm ²	$A_{s2} =$	0,00	cm ²	$d_1 = d_2 =$	5,0	cm
$E_s =$	200,00	GN/m ²	$E_{cm} =$	33,00	GN/m ²	$\alpha_e =$	6,1	
$M_{Ed} =$	213,23	kNm	$k_t =$	0,40		$E_s/E_{cm} =$		
$\sigma_s =$	350,18	MN/m ²						
$x =$	14,90	cm	$\rho_{p,eff} =$	0,1217				
$(\epsilon_{sm} - \epsilon_{cm}) =$	0,001668	>	$0,6 \cdot \sigma_s/E_s =$	0,001051				
$\emptyset =$	22,0	mm	$c =$	4,00	cm			
$k_1 =$	0,8		$k_2 =$	0,50				
$k_3 =$	3,4		$k_4 =$	0,43				
$s_{r,max} =$	166,73	mm						
	$w_k = s_{r,max} \cdot (\epsilon_{sm} - \epsilon_{cm}) =$	0,278	mm	<	w_g			

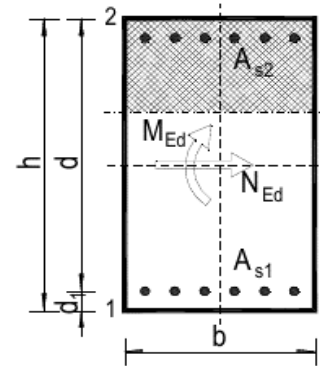

$$w_k = s_{r,max} \cdot (\epsilon_{sm} - \epsilon_{sm}) = 0,278 \text{ mm} < w_g = 0,3 \text{ mm}$$

Pukotine zadovoljavaju

5. DIMENZIONIRANJE STUBIŠTA

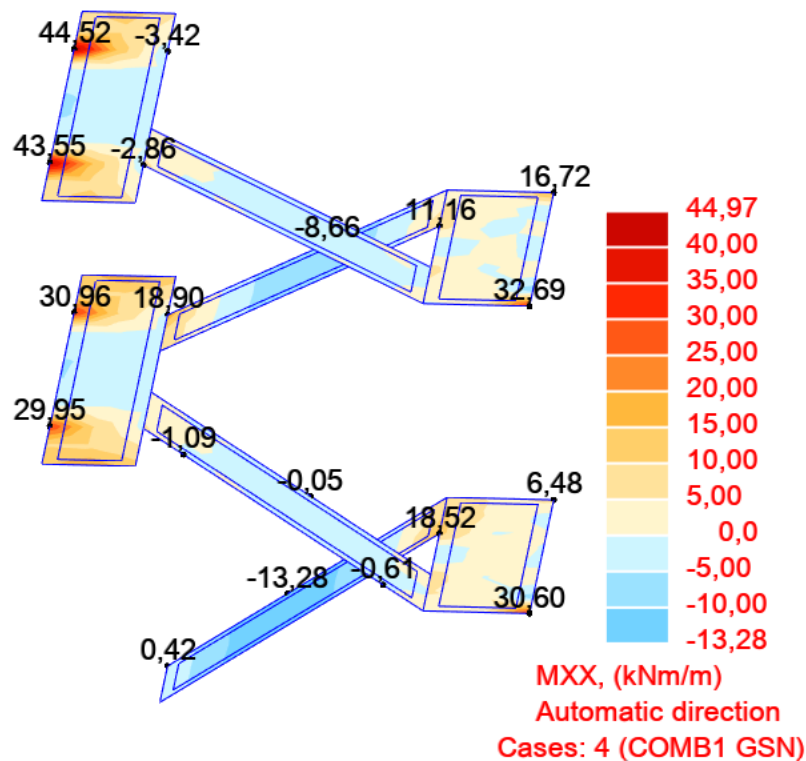

Polje:

$$\mu_{sd} = \frac{M_{Ed}}{b \cdot d^2 \cdot f_{cd}} = \frac{1328}{100 \cdot 15,0^2 \cdot 2,0} = 0,0295 = \text{odabrani } \mu_{sd} = 0,031$$

Očitano: $\epsilon_{s1} = 10\text{‰}$; $\epsilon_{c2} = 1,0\text{‰}$; $\xi = 0,091$; $\zeta = 0,968$

$$A_{s1} = \frac{M_{Ed}}{\zeta \cdot d \cdot f_{yd}} = \frac{1328}{0,968 \cdot 15,0 \cdot 43,48} = 2,01 \text{ cm}^2/\text{m}$$

Odabrana armatura: mreža Q-385 (3,85 cm²)

Ležaj

$$\mu_{sd} = \frac{M_{ed}}{b \cdot d^2 \cdot f_{cd}} = \frac{1890}{100 \cdot 15,0^2 \cdot 2,0} = 0,042 = \text{odabrani } \mu_{sd} = 0,031$$

Očitano: $\epsilon_{s1} = 10\text{‰}$; $\epsilon_{c2} = 1,3\text{‰}$; $\xi = 0,115$; $\zeta = 0,959$

$$A_{s1} = \frac{M_{Ed}}{\zeta \cdot d \cdot f_{yd}} = \frac{1890}{0,959 \cdot 15,0 \cdot 43,48} = 3,02 \text{ cm}^2/\text{m}$$

Odabrana armatura: mreža R-503 (5,03 cm²)

6. REZULTATI DINAMIČKE ANALIZE

Mod 1:

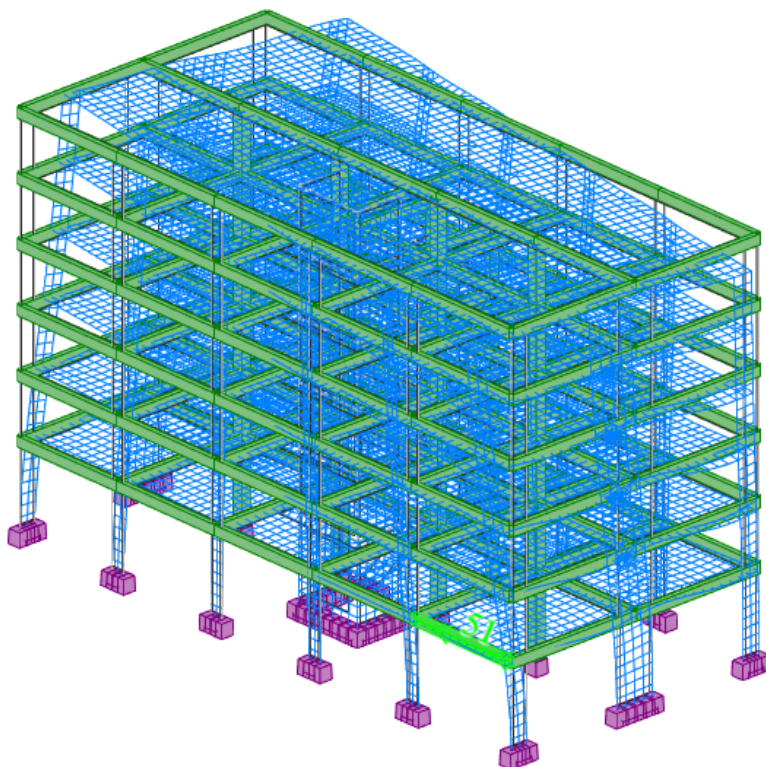

Slika 6.1. Mod 1 Uvrtnje u smjeru globalne osi z

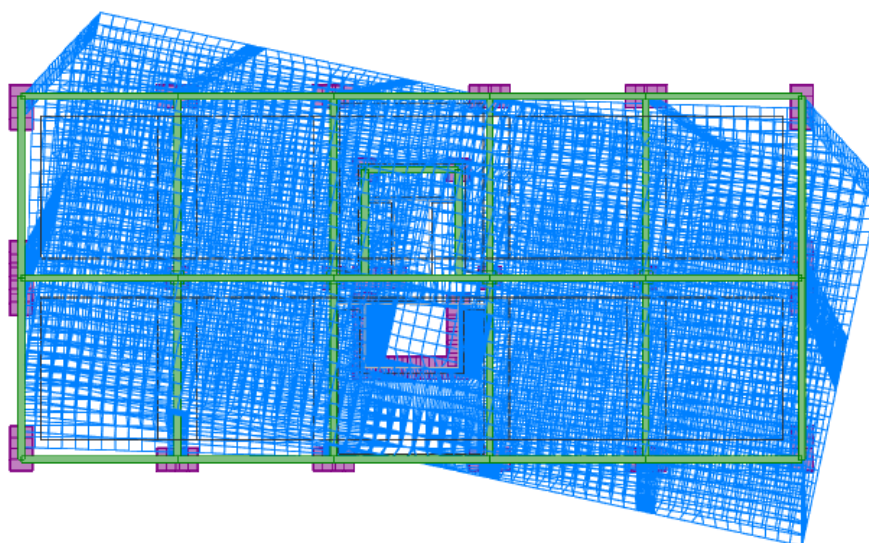

Slika 6.2. Mod 1 Uvrtnje u smjeru globalne osi z

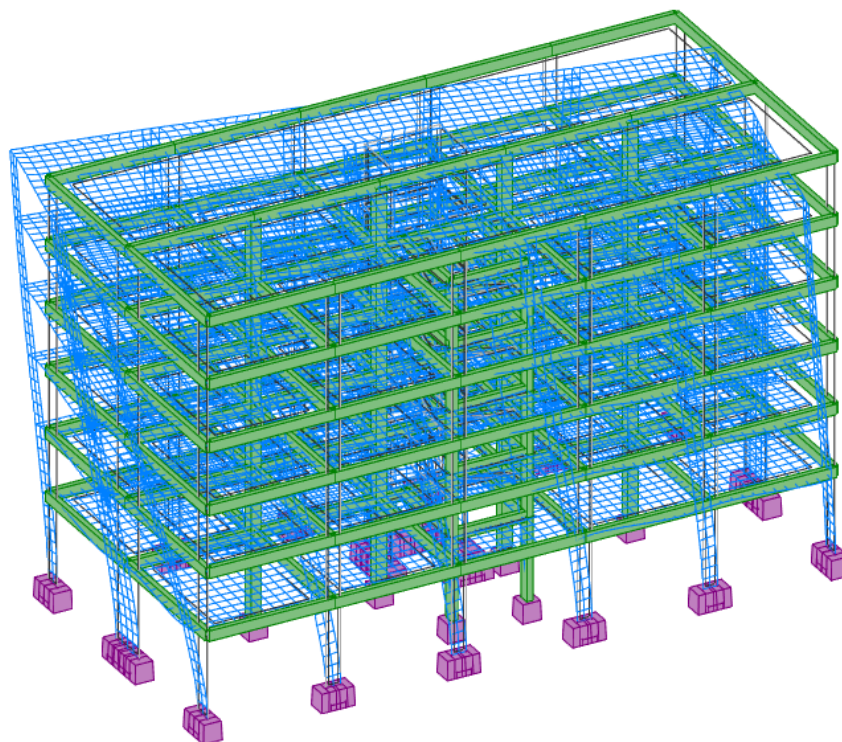

Slika 6.3. Mod 1 uvrtnje u smjeru globalne osi z

Mod 2:

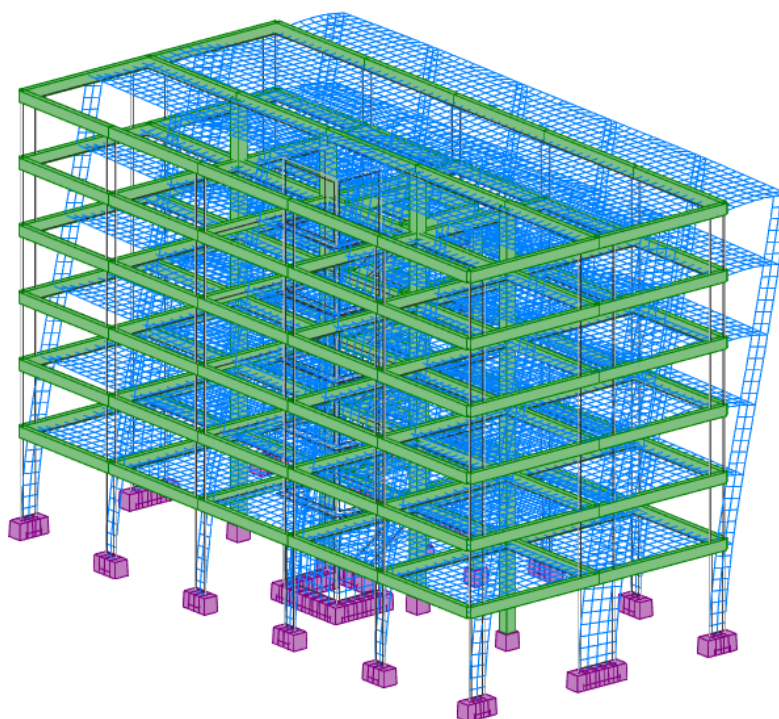

Slika 6.4. Mod 2 translacija u smjeru globalne osi y

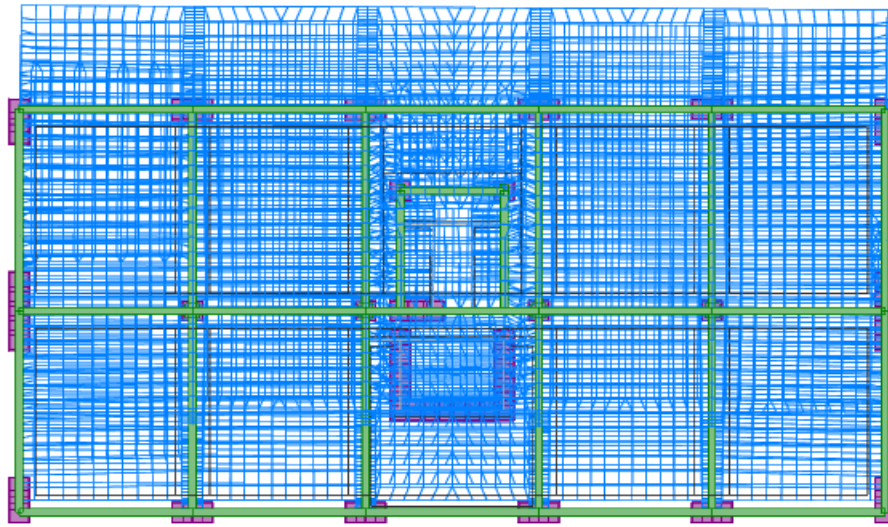

Slika 6.5. Mod 2 translacija u smjeru globalne osi y

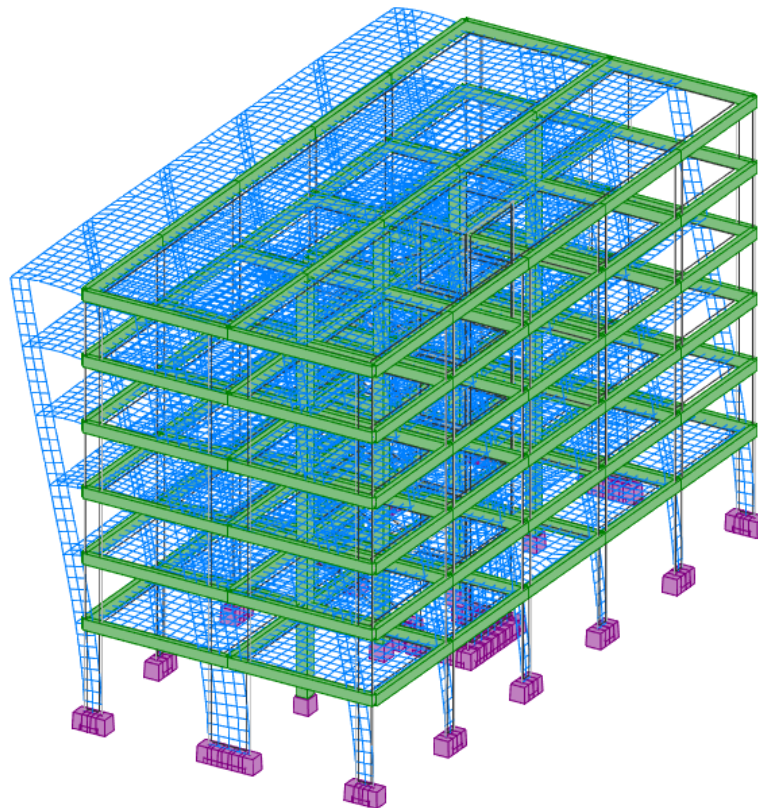

Slika 6.6. Mod 2 translacija u smjeru globalne osi y

Mod 3:

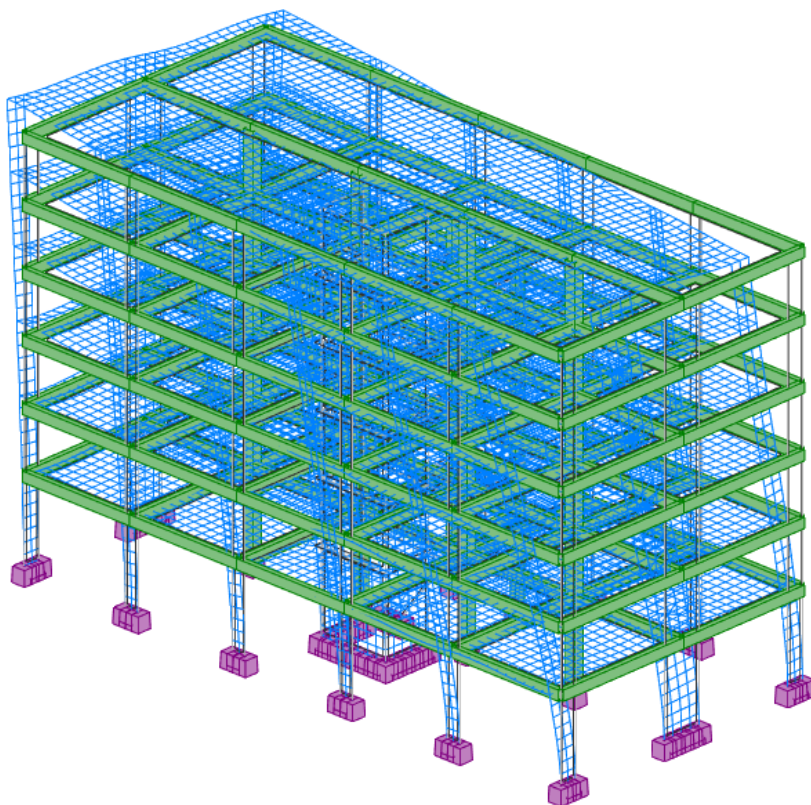

Slika 6.7. Mod 3 translacija u smjeru globalne osi x

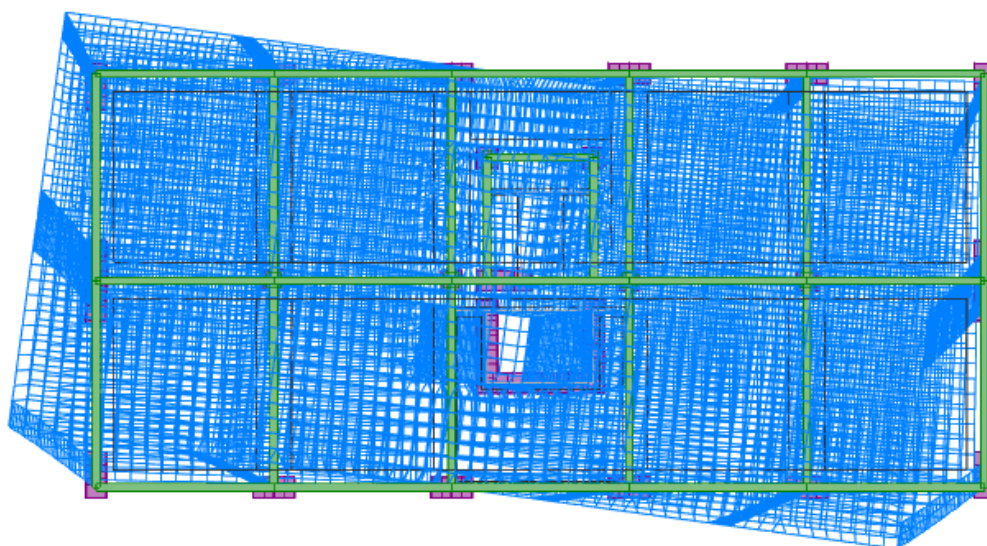

Slika 6.8. Mod 3 translacija u smjeru globalne osi x

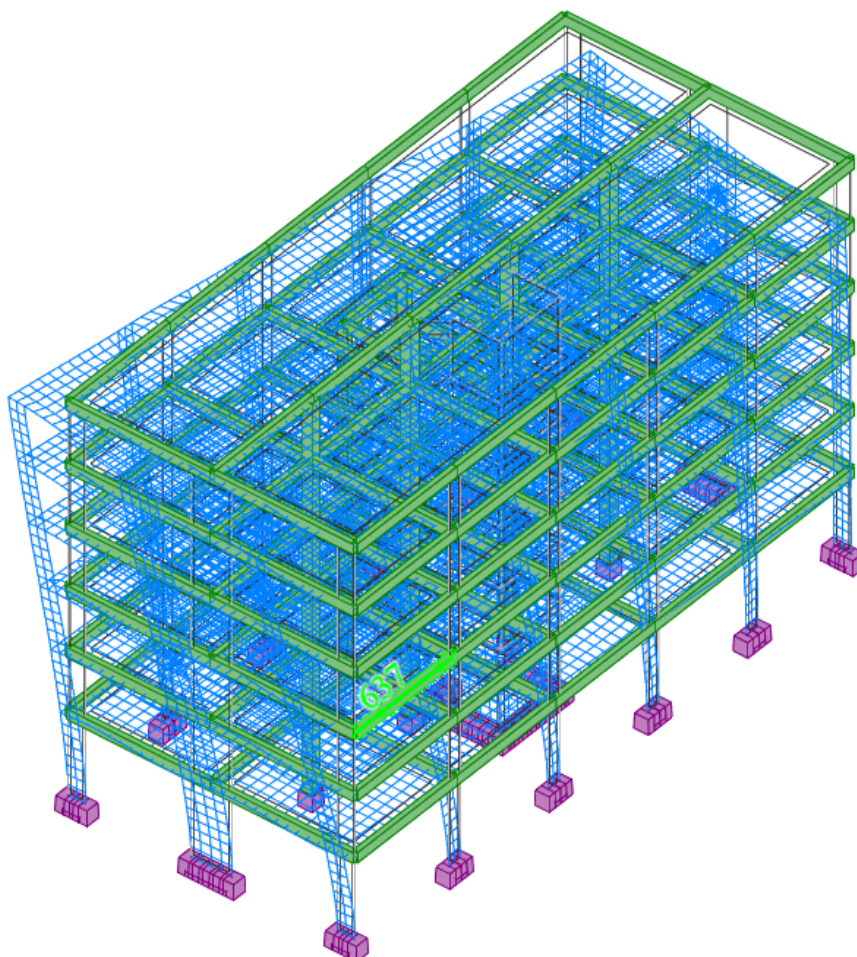

Slika 6.9. Mod 3 translacija u smjeru globalne osi x

Prikaz aktivacije mase pri potresnom opterećenju:

Case/Mode	Frequency (Hz)	Period (sec)	Rel.mas.UX (%)	Rel.mas.UY (%)	Rel.mas.UZ (%)	Cur.mas.UX (%)	Cur.mas.UY (%)	Cur.mas.UZ (%)	Total mass UX (kg)	Total mass UY (kg)	Total mass UZ (kg)
5/ 1	1,51	0,66	25,74	0,03	0,00	25,74	0,03	0,00	2974212,85	2974212,85	2974212,85
5/ 2	1,66	0,60	25,75	75,68	0,01	0,01	75,65	0,01	2974212,85	2974212,85	2974212,85
5/ 3	2,12	0,47	77,18	75,68	0,01	51,43	0,00	0,00	2974212,85	2974212,85	2974212,85
5/ 4	5,28	0,19	82,25	75,68	0,01	5,07	0,00	0,00	2974212,85	2974212,85	2974212,85
5/ 5	6,22	0,16	82,25	91,06	0,31	0,00	15,38	0,31	2974212,85	2974212,85	2974212,85

7. PRORAČUN VERTIKALNIH ELEMENATA KONSTRUKCIJE

7.1. Proračun stupova

Stupovi su u modelu modelirani kao 1D štapni elementi. Prostorni model je proračunat na uobičajne i izvanredne kombinacije iz kojih su izvučene maksimalne rezne sile. Stupovi su visine 252cm i kvadratnog poprečnog presjeka dimenzija 50/50cm. AB stupovi su napravljeni od betona klase C30/37 i armirani armaturom B500B. Zaštitni sloj betona do armature iznosi 5cm. Stupovi se izvode monolitno na licu mjesta u oplati. Proračun stupova proveden je pomoću programskog paketa AspalathosSectionDesign. Pretpostavimo armaturu u stupu i za nekoliko različitih profila izračunamo graničnu nosivost stupa za odabrani poprečni presjek i odabranu armaturu.

$$M_{računski} = M_{očitani}$$

Proračun stupova

Rezne sile

Uobičajna kombinacija

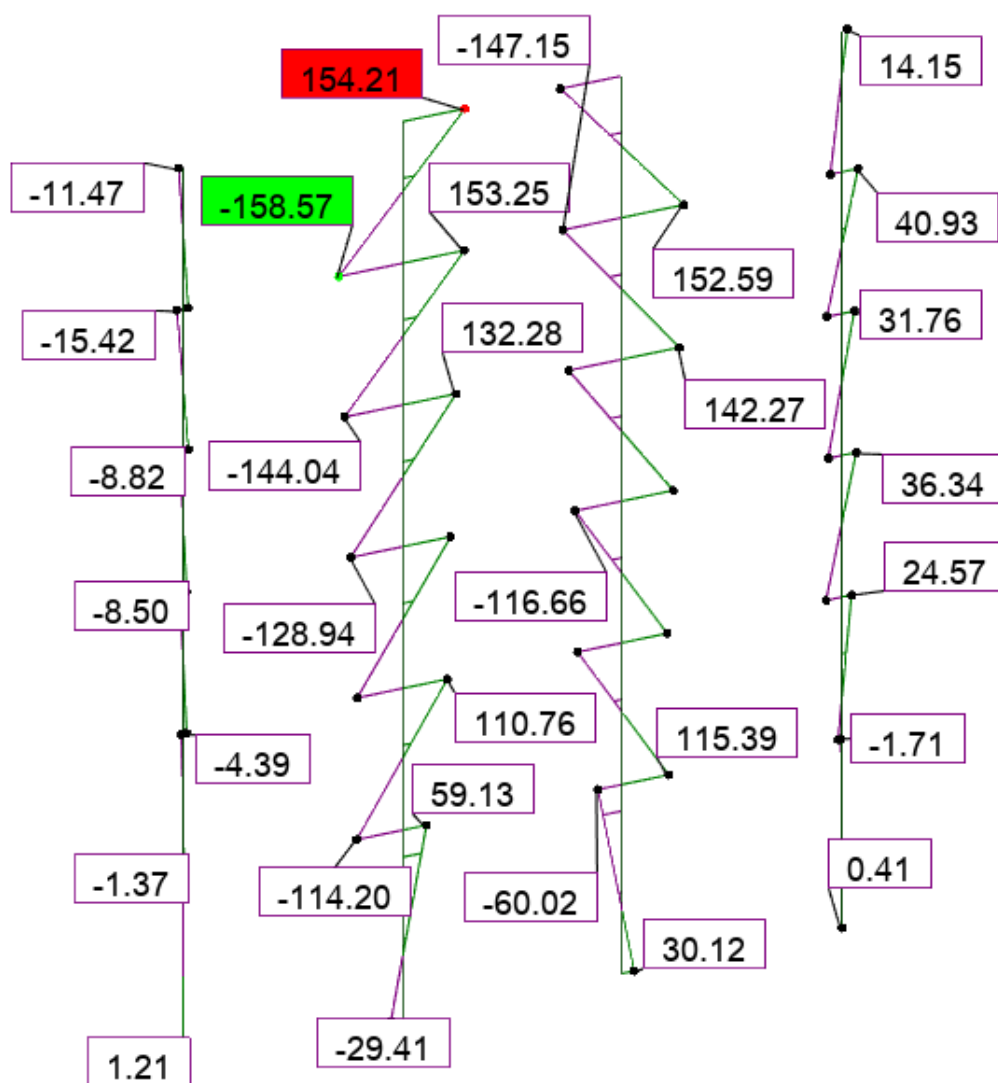

Slika 7.1. Moment savijanja

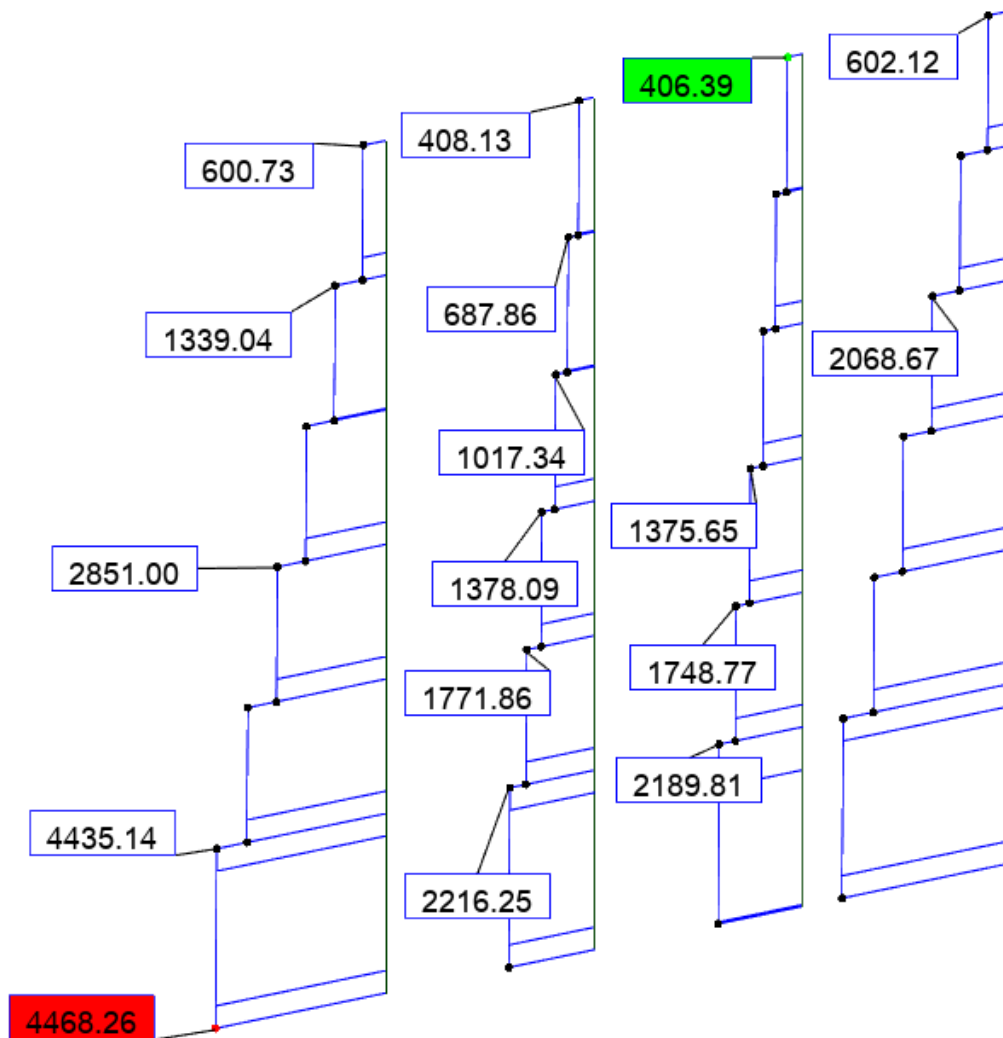

Slika 7.2. Uzdužne sile

Izvanredna kombinacija

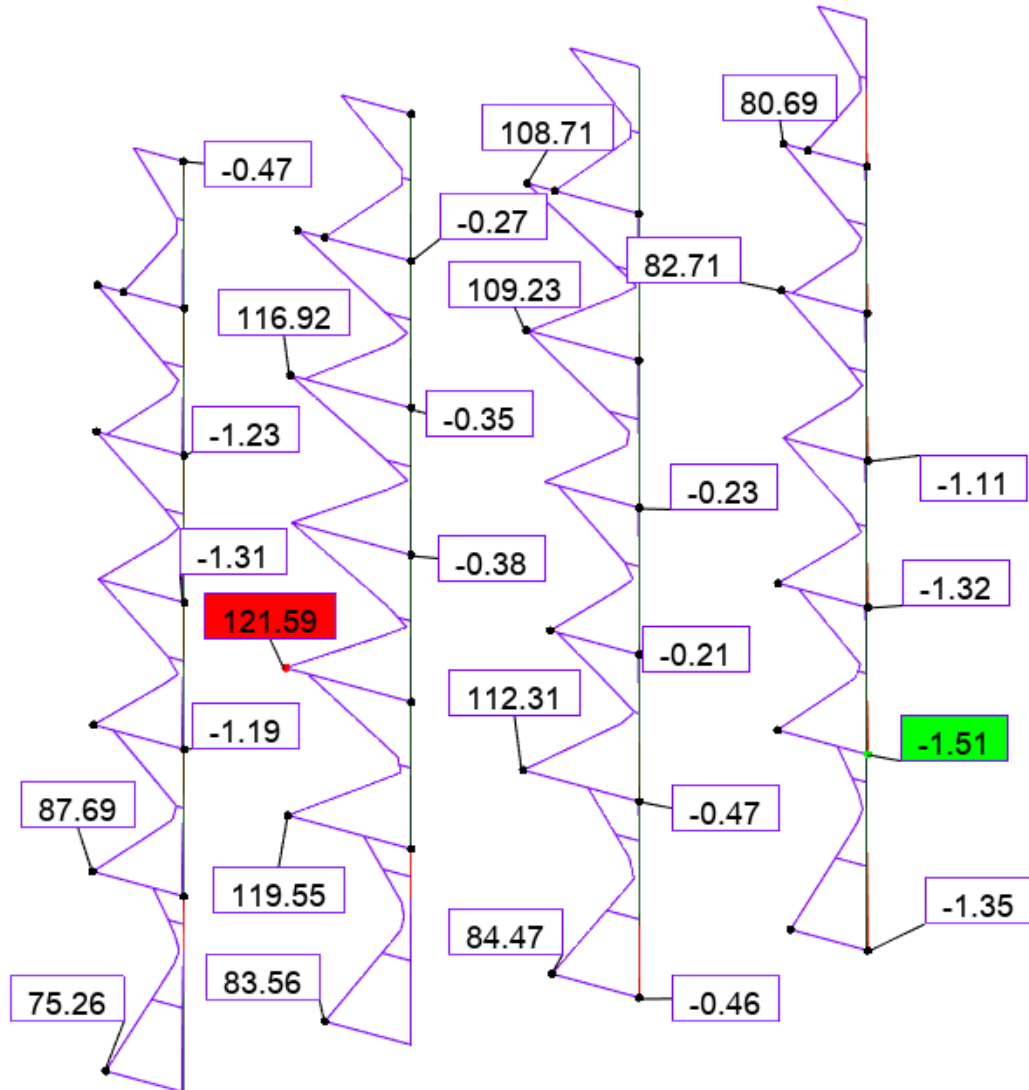

Slika 7.3. Moment savijanja

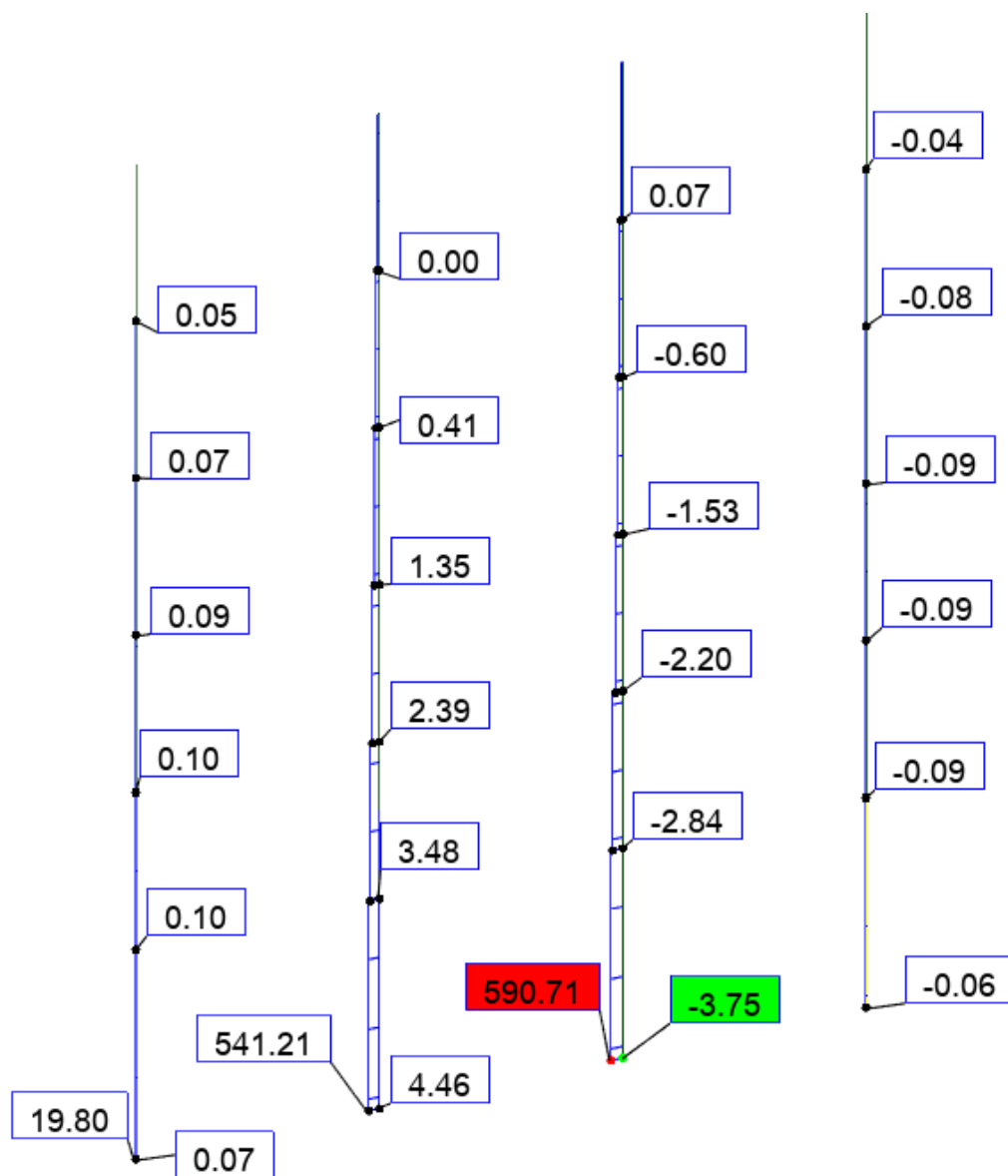

Slika 7.4. Uzdužne sile

7.1.1. Dimenzioniranje stupova na moment savijanja i uzdužnu silu

Uobičajna kombinacija	N	M _{očitano}	M _{računski}
	(kN)	(kNm)	(kNm)
N _{max} M _{prip}	-4468,26	1,21	1,21
N _{prip} M _{max}	-687,86	158,57	158,57
Izvanredna kombinacija	N	M _{očitano}	M _{računski}
	(kN)	(kNm)	(kNm)
N _{max} M _{prip}	-590,71	84,47	2,42
N _{prip} M _{max}	-2,39	121,59	121,59

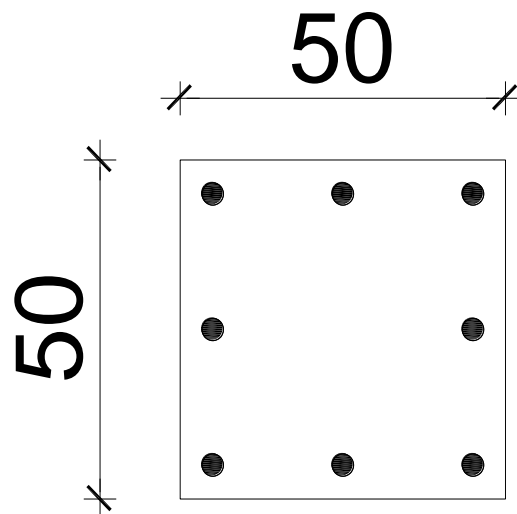

Slika 7.5. Poprečni presjek stupa

Ø14		Ø16		Ø18	
M	N	M	N	M	N
0	-535,44	0	-699,35	0	-885,11
115,55	0	149	0	186,34	0
191,17	382,33	240,68	481,35	294,9	589,79
257,05	771,16	304,36	913,09	344,89	1034,66
301,13	1204,53	337,24	1348,95	374,29	1497,16
328,18	1640,89	358,38	1791,9	389,57	1947,84
335,04	2010,22	354,55	2127,31	375,05	2250,29
325,49	2278,44	342	2394	359,72	2518,05
313,91	2511,3	328,11	2625,72	343,83	2750,64
301,22	2710,96	313,91	2825,16	327,93	2951,34
288,115	2881,5	299,59	2995,94	312,38	3123,77
0	4785,4	0	4949,34	0	5135,11

Talica 12.3. Prikaz vrijednosti za dijagram nosivosti stupova

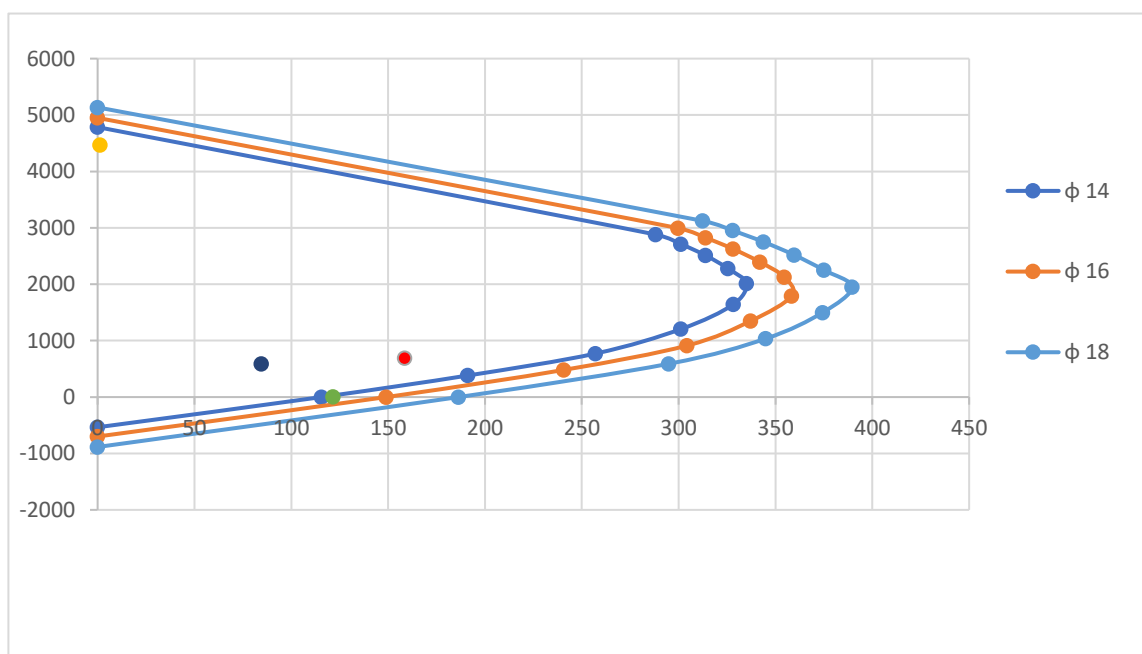

Slika Dijagram nosivosti stupova

Odabrana armatura stupova: 8Ø16 (16,08 cm²)

$$A_{s,min} = 0,1\% \cdot A_c = 0,1\% \cdot 50 \cdot 50 = 2,5\text{cm}^2$$

$$A_{s,max} = 2,0\% \cdot A_c = 2,0\% \cdot 50 \cdot 50 = 50,0\text{cm}^2$$

7.1.2. Dimenzioniranje na poprečnu silu

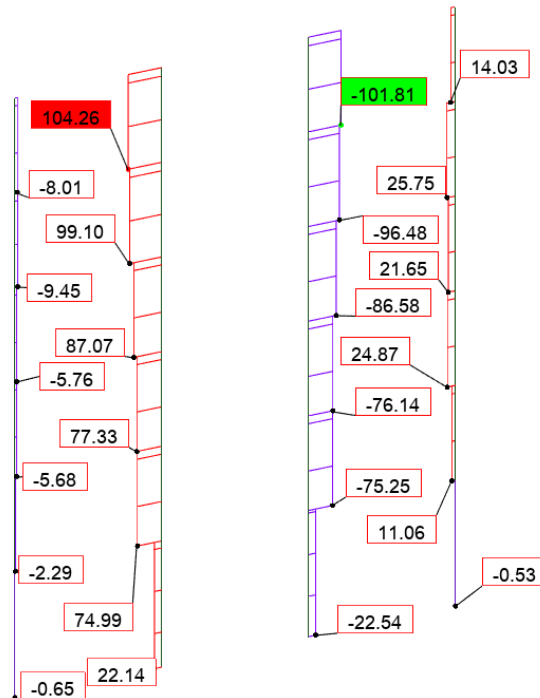

Slika 7.6. Poprečne sile

Beton: C 30/37 $f_{cd} = \frac{f_{ck}}{\gamma_c} = \frac{30}{1,5} = 20 \text{ MPa}$; $f_{cd} = 2,0 \text{ kN/cm}^2$

Armatura: B 500 B $f_{yd} = \frac{f_{yk}}{\gamma_c} = \frac{500}{1,5} = 434,78 \text{ MPa}$; $f_{yd} = 43,5 \frac{\text{kN}}{\text{cm}^2}$

Računska poprečna sila: $V_{Ed, \max} = 104,26 \text{ kN}$

$$\sum A_s = 16,08 \text{ cm}^2$$

$$\rho_l = \frac{\sum A_s}{A_c} = \frac{16,08}{50 \cdot 50} = 0,006$$

Poprečna sila koju presjek može preuzeti bez poprečne armature:

$$V_{Rd,c} = \left[C_{Rd,c} \cdot k \cdot (100 \cdot \rho_l \cdot f_{ck})^{\frac{1}{3}} + k_1 \cdot \sigma_{cp} \right] \cdot b_w \cdot d$$

$$k = 1,0 + \sqrt{\frac{200}{d}} = 1,0 + \sqrt{\frac{200}{450}} = 1,67 < 2,0 \rightarrow k = 1,67$$

$$k_1 = 0,15$$

$$\sigma_{cp} = \frac{N_{Ed}}{A_c} = 0,0$$

$$C_{Rdc} = \frac{0,18}{\gamma_c} = \frac{0,18}{1,5} = 0,12$$

$$V_{Rd,c} = \left[0,12 \cdot 1,67 \cdot (100 \cdot 0,006 \cdot 30,0)^{\frac{1}{3}} + 0,15 \cdot 0,0 \right] \cdot 450 \cdot 500 = 118,17 \text{ kN}$$

$$V_{Rd,c} \geq [v_{\min} + k_1 \cdot \sigma_{cp}] \cdot b_w \cdot d$$

$$k_1 = 0,15$$

$$v_{\min} = 0,035 \cdot k^{\frac{3}{2}} \cdot f_{ck}^{\frac{1}{2}} = 0,035 \cdot 1,67^{\frac{3}{2}} \cdot 30,0^{\frac{1}{2}} = 0,414$$

$$\sigma_{cp} = \frac{N_{Ed}}{A_c} = 0,0$$

$$V_{Rd,c} \geq 0,414 \cdot 450 \cdot 500$$

$$V_{Rd,c} \geq 93150 \text{ N} = 93,15 \text{ kN}$$

Maksimalna poprečna sila koju se ne smije prijeći (dio poprečne sile koju mogu preuzeti tlačne dijagonale):

$$V_{Rd,max} = 0,5 \cdot v \cdot b_w \cdot d \cdot f_{cd}$$

$$v = 0,6 \cdot \left[1,0 - \frac{f_{ck}}{250} \right] = 0,6 \cdot \left[1,0 - \frac{30}{250} \right] = 0,528$$

$$V_{Rd,max} = 0,5 \cdot 0,528 \cdot 500 \cdot 450 \cdot 20,0 = 1188000 \text{ N} = 1188,0 \text{ kN} > V_{Ed,max}$$

$$V_{Ed,max} = 104,26 \text{ kN} < V_{Rd,c}$$

Nije potreban proračun poprečne armature, usvojiti ćemo minimalnu poprečnu armaturu.

$$s_{\max} = \min\{0,75 \cdot d ; 30,0 \text{ cm}\} = \min\{0,75 \cdot 45 = 33,75 ; 30,0 \text{ cm}\} \rightarrow s_{\max} = 30,0 \text{ cm}$$

$$\rho_{w,\min} = 0,001$$

Maksimalni razmak spona:

$$s \leq \frac{m \cdot A_{sw}}{\rho_{w,\min} \cdot b_w} = \frac{2 \cdot A_{sw}}{0,00100 \cdot 50} = \frac{2 \cdot 0,5}{0,00100 \cdot 50} = 20,0 \text{ cm}$$

Odabrane spona: Ø10/20cm

7.2. PRORAČUN ZIDOVA

Proračun zidova je proveden po Eurocodu 8. Proračun provodimo za 1 vanjski zid konstrukcije u smjeru y. Njihova debljina je 30cm. Izvedeni su iz betona klase C30/37, a armirani armaturom B500B. Proračun je proveden za uobičajne i seizmičke kombinacije te su iz modela izvedeni M, N i V dijagrami.

Uobičajna kombinacija:

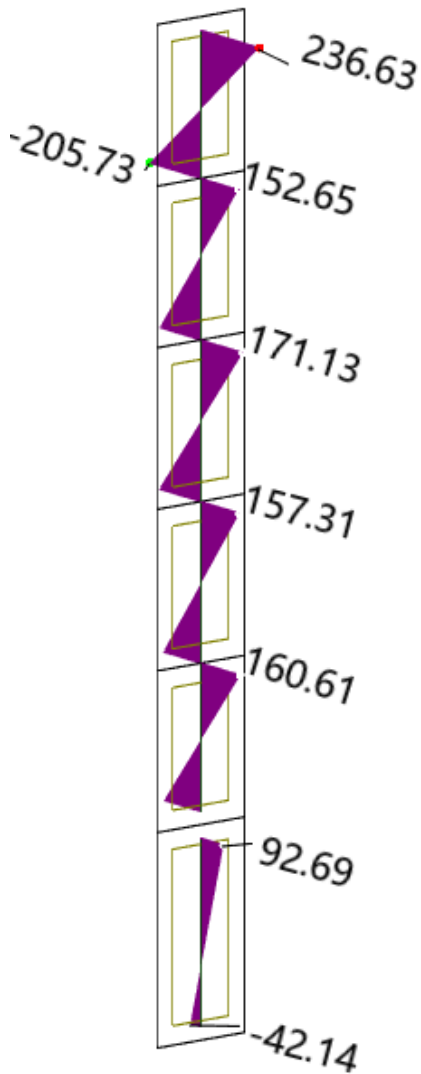

Slika 7.7. M

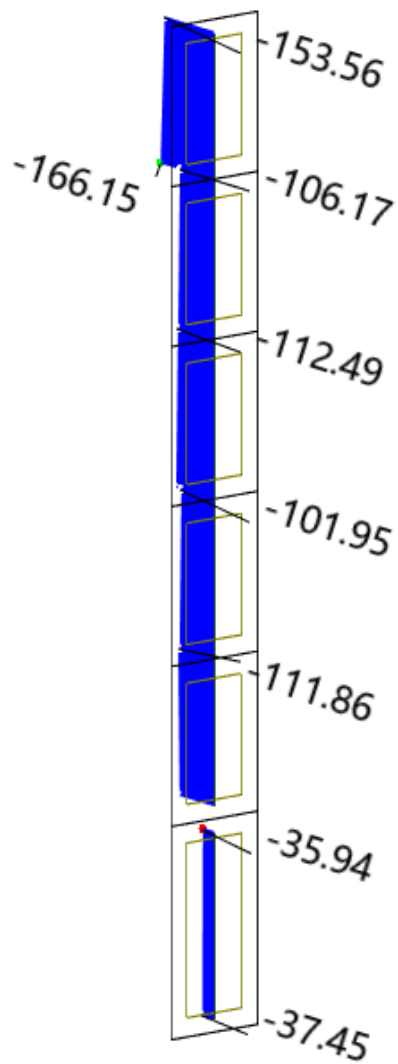

Slika 7.8. V

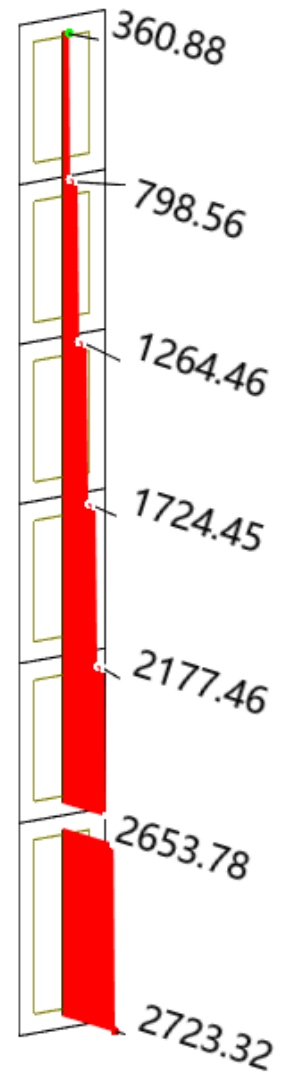

Slika 7.9. N

Izvanredna kombinacija:

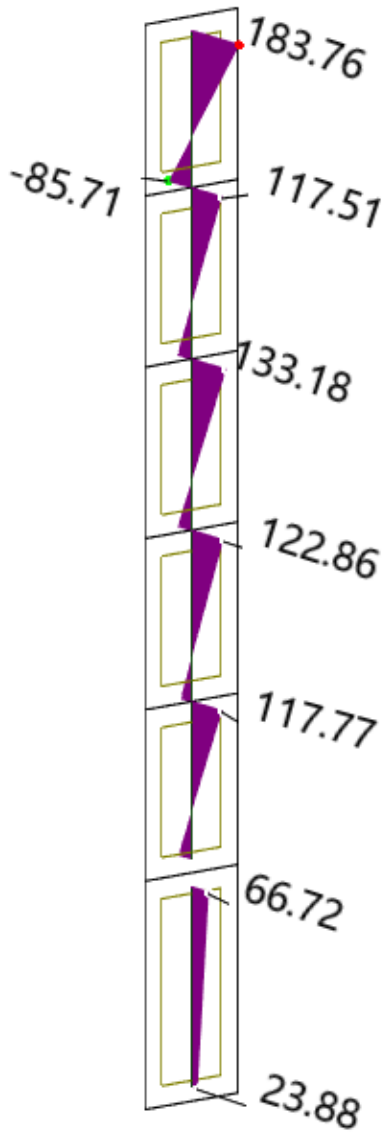

Slika 7.10. M

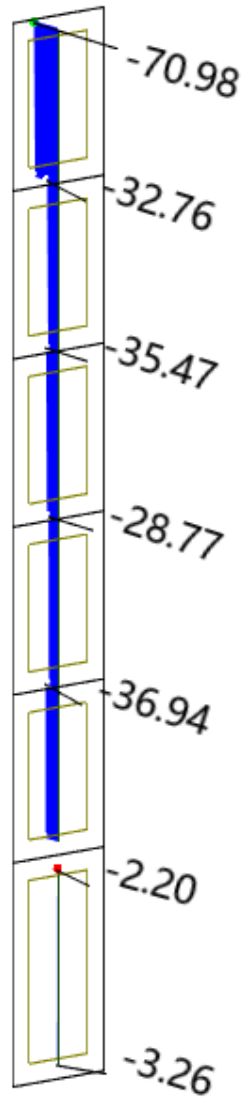

Slika 7.11. V

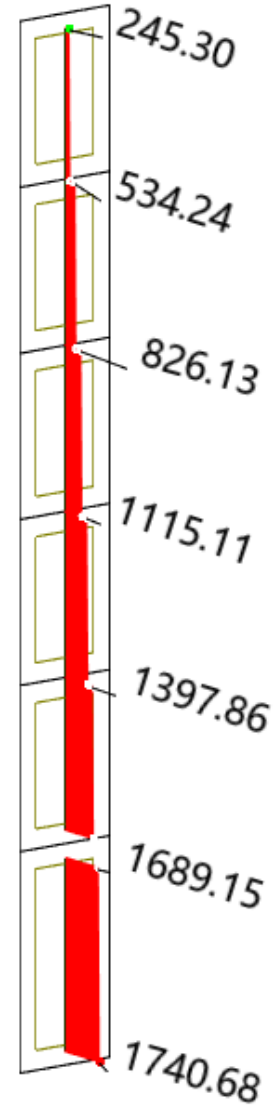

Slika 7.12. N

Rezne sile

$$M_{Ed} = 236,63 \text{ kNm}$$

$$N_{Ed} = 2723,32 \text{ kN}$$

Dimenzioniranje zidova provodi se pomoću dijagrama interakcije.

$$\mu_{sd} = \frac{M_{Ed}}{b \cdot h^2 \cdot f_{cd}} = \frac{236,63 \cdot 100}{30 \cdot 200^2 \cdot 2,0} = 0,0099$$

$$V_{Ed} = \frac{N_{Ed}}{b \cdot h^2 \cdot f_{cd}} = \frac{2723,32 \cdot 100}{30 \cdot 200^2 \cdot 2,0} = 0,113$$

Iz dijagrama interakcije za omjer armature (α) i omjer d_1/l_w , d_2/l_w (β) očitamo mehanički koeficijent armiranja (ω)

$$\alpha = \frac{A_{s2}}{A_{s1}} = 1,0$$

$$\beta = \frac{d_1}{h} = \frac{d_2}{h} = \frac{5,0}{200} = 0,025$$

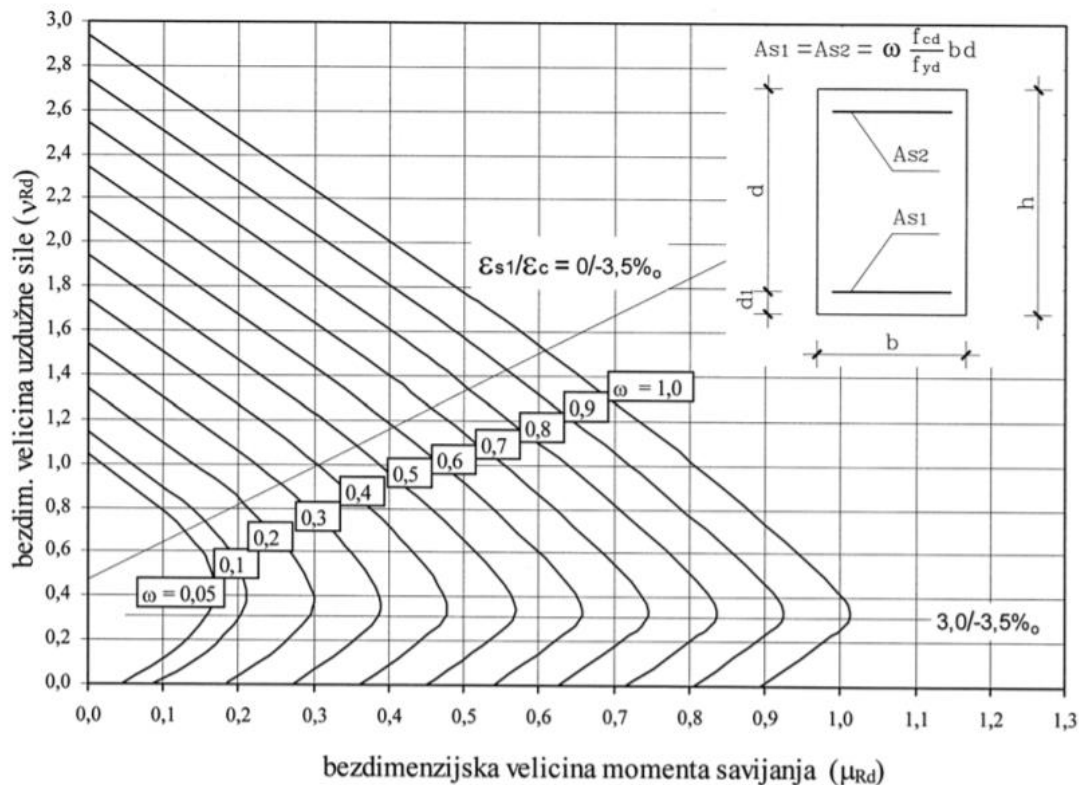

Slika Dijagram za armiranje simetrično armiranih pravokutnih presjeka –
postupak Wuczowskog

Očitano: $\omega = 0,05$

$$A_{s1} = \omega \cdot b \cdot h \cdot \frac{f_{cd}}{f_{yd}}$$

$$A_{s, \min} = 0,1\% \cdot b \cdot h = 0,001 \cdot 30 \cdot 200 = 6,0 \text{ cm}^2$$

$$A_{s, \max} = 4,0\% \cdot b \cdot h = 0,040 \cdot 30 \cdot 200 = 240 \text{ cm}^2$$

$$A_{s1} = 0,05 \cdot b \cdot h \cdot \frac{f_{cd}}{f_{yd}} = 0,05 \cdot 30 \cdot 200 \cdot \frac{2,0}{43,48} = 13,80 \text{ cm}^2$$

Usvojena poprečna armature: 8Ø18 (20,36 cm²)

Za stvarno armirani presjek tražimo moment nosivosti:

$$A_{s1} = 20,36 \text{ cm}^2$$

$$\omega = \frac{A_{s1} \cdot f_{yd}}{b \cdot h \cdot f_{cd}} = \frac{20,36 \cdot 43,48}{30 \cdot 200 \cdot 2,0} = 0,074$$

$$N_{\max} = 1740,68 \text{ kN}$$

$$V_{Ed} = \frac{N_{Ed}}{b \cdot h \cdot f_{cd}} = \frac{1740,68}{30 \cdot 200 \cdot 2,0} = 0,145$$

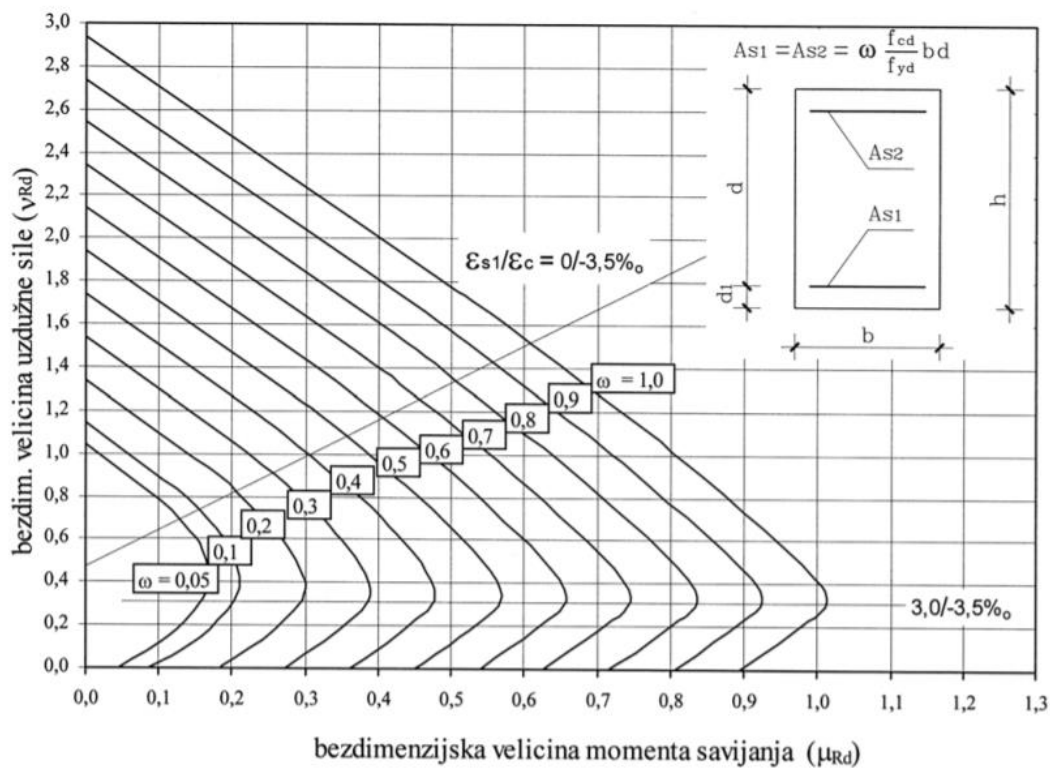

Slika Dijagram za armiranje simetrično armiranih pravokutnih presjeka –

postupak Wuczkowskog

Iz dijagrama interkacije očitano: $\mu_{sd} = 0,1$

Proračunska otpornost na savijanje u podnožju zida:

$$M_{Rd} = \mu_{sd} \cdot b \cdot h^2 \cdot f_{cd} = (0,1 \cdot 30 \cdot 200^2 \cdot 2) / 100 = 2400 \text{ kNm}$$

7.2.1. Dimenzioniranje na poprečnu silu

Rezne sile

$$V_{Ed} = 153,56 \text{ kN}$$

$$A_{s,min} = 0,2\% \cdot d \cdot 100 = \frac{0,2}{100} \cdot 30 \cdot 100 = 6,0 \text{ cm}^2 / \text{m}$$

Odabrano: Q-785 ($A_s = 7,85 \text{ cm}^2/\text{m}$) obostrano

8. PRORAČUN TEMELJA

8.1. Temelj samac

Rezne sile

Uobičajna kombinacija

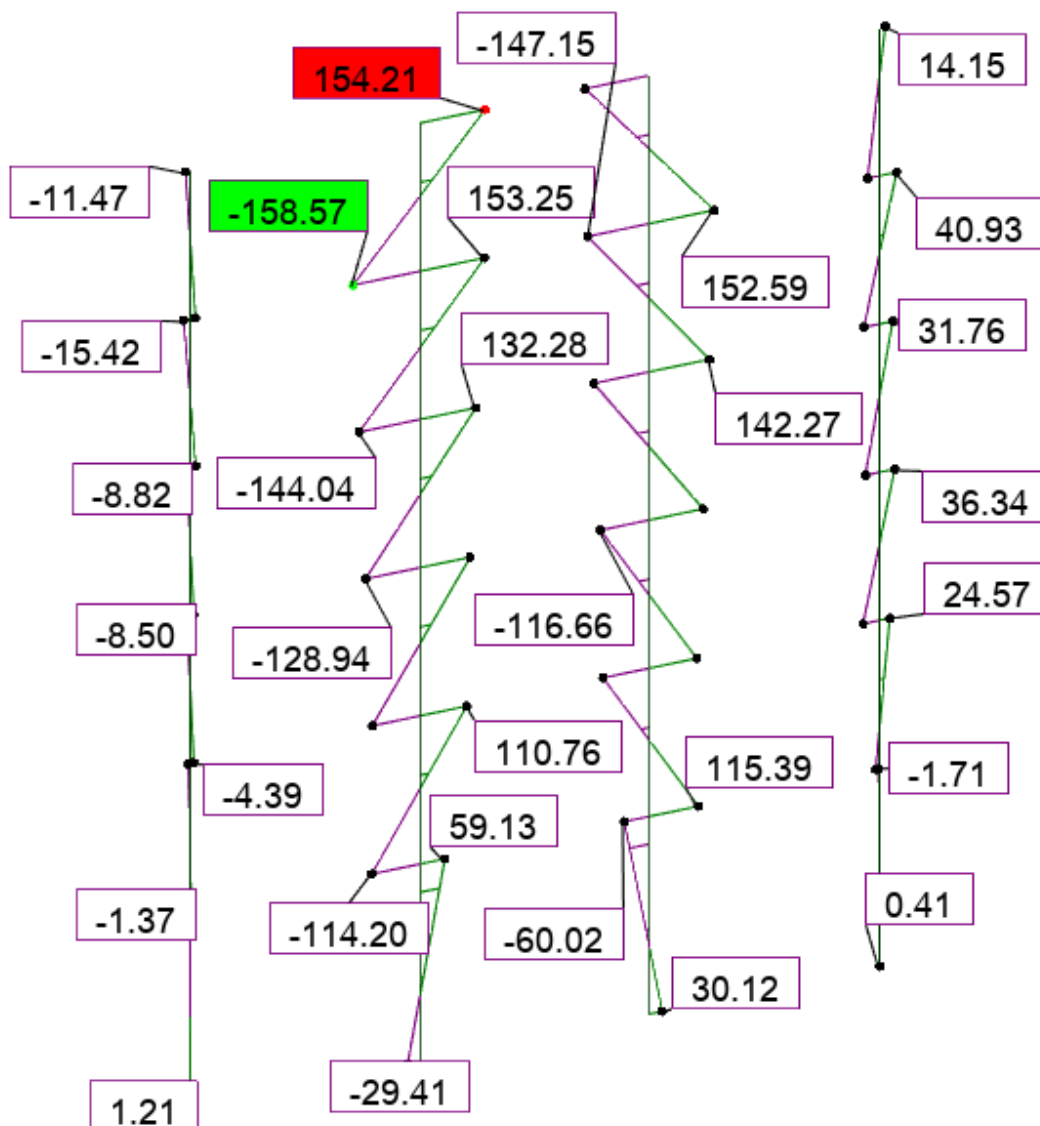

Slika 8.1. Moment savijanja

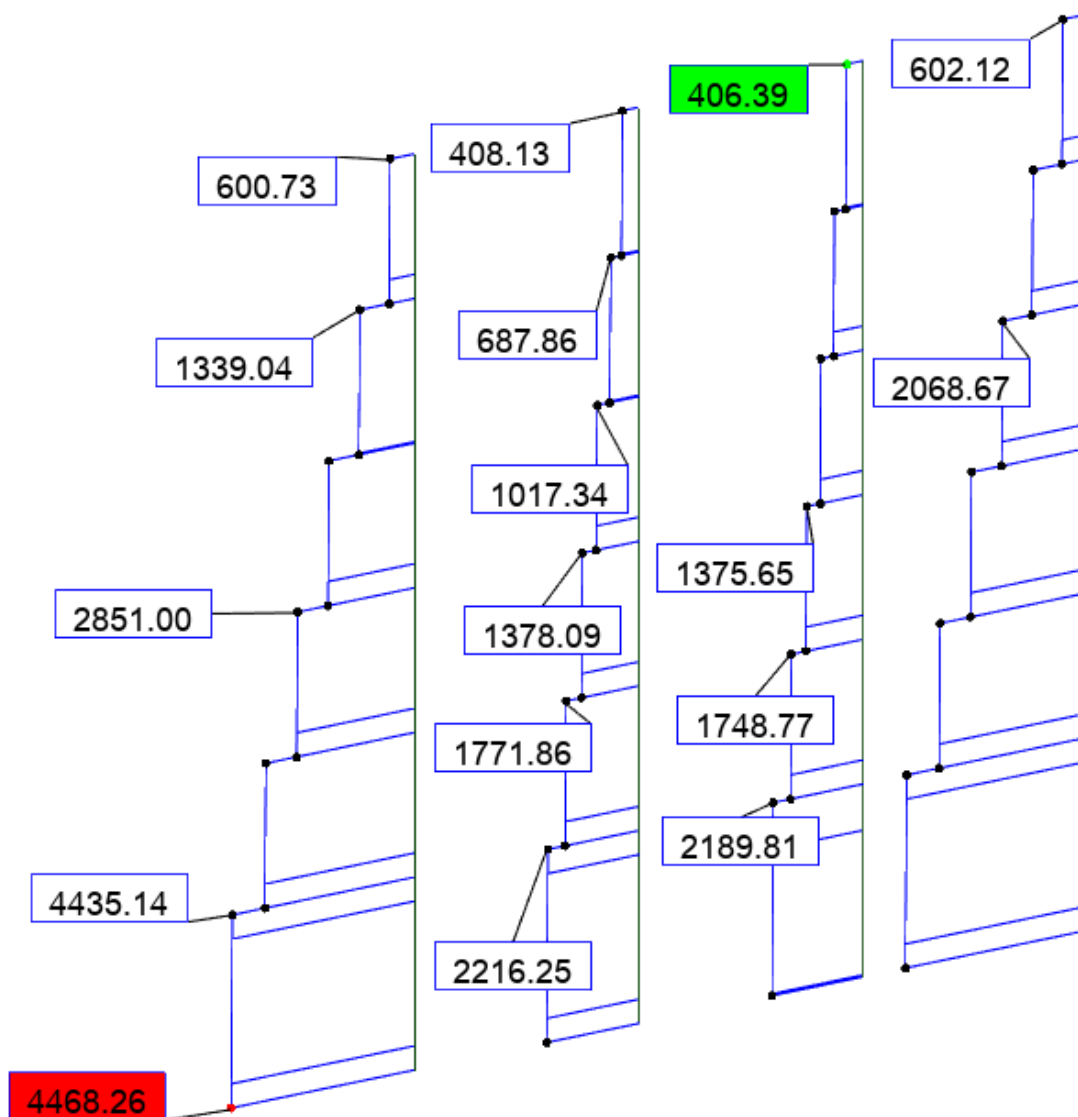

Slika 8.2. Uzdužne sile

Izvanredna kombinacija

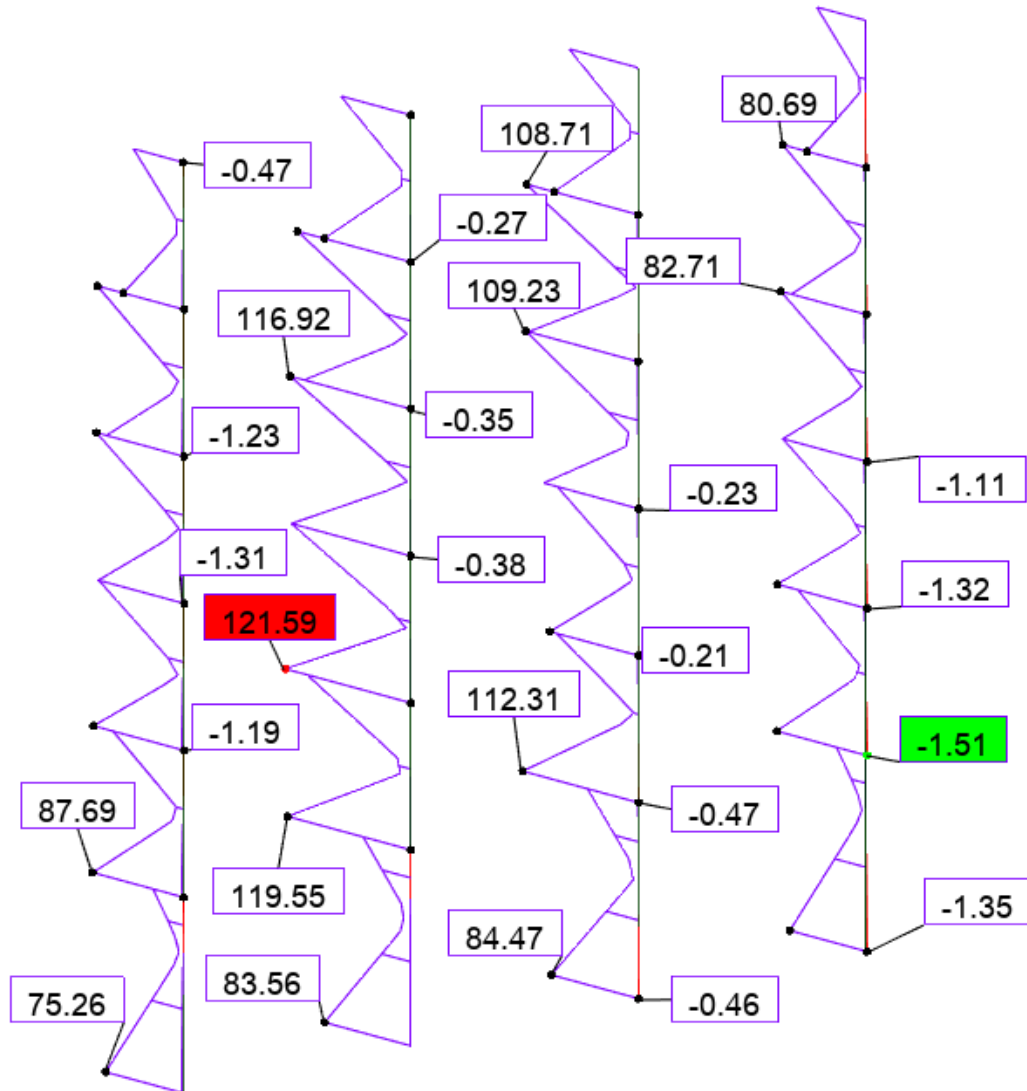

Slika 8.3. Moment savijanja

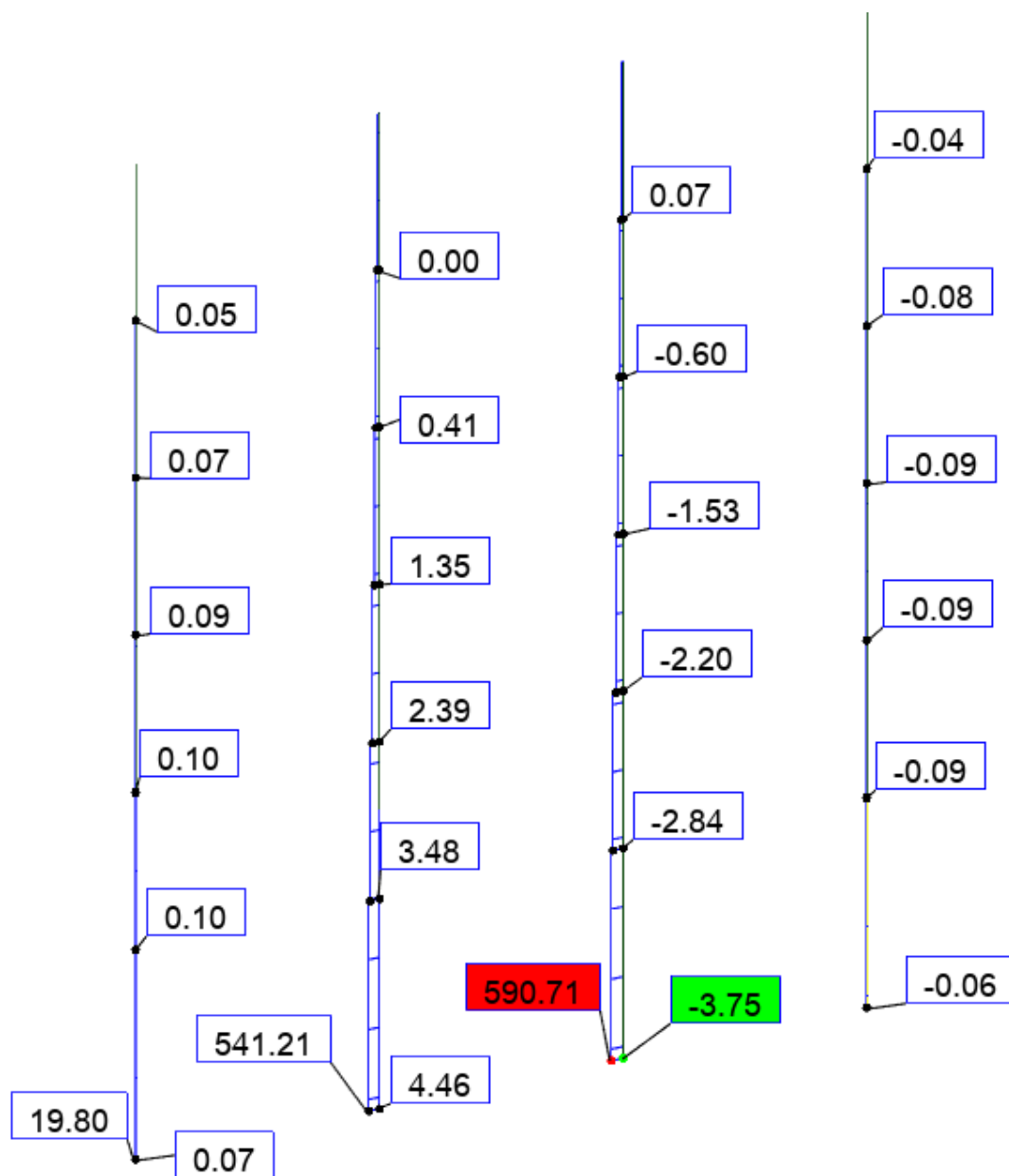

Slika 8.4. Uzdužne sile

8.1.1. Dimenzioniranje temelja samca

Temelj je centrično opterećen zbog čega odabiremo kvadratni poprečni presjek.

Dopuštena naprezanja u tlu:

$$\sigma_{dop} = 0,5 \text{ MN/m}^2$$

Širina i duljina temelja:

$$a = \sqrt{\frac{N}{\sigma_{dop}}} = \sqrt{\frac{4468,26}{500}} = 2,98 \text{ m}$$

Usvojena širina i duljina temelja:

$$a = 3,2 \text{ m}$$

Visina temelja:

$$v = 1,5 \cdot a_{stup} = 1,5 \cdot 0,50 = 0,75 \text{ m}$$

Usvojena visina temelja

$$v = 80 \text{ cm}$$

Težina temelja:

$$N_t = 3,2 \cdot 3,2 \cdot 0,80 \cdot 25 = 204,8 \text{ kN}$$

$$\sigma_{1,2} = \frac{N}{A} \pm \frac{M}{W}$$

$$A = 3,2 \cdot 3,2 = 10,24 \text{ m}^2$$

$$W = \frac{bh^2}{6} = \frac{3,2 \cdot 3,2^2}{6} = 5,46 \text{ m}^3$$

Prva kombinacija:

$$N_{max} = 4468,26 \text{ kN} \quad \rightarrow \quad N_{Ed} = N_{max} + N_t = 4468,26 + 204,8 = 4673,06 \text{ kN}$$

$$M_{prirpadno} = 1,21 \text{ kNm}$$

$$\sigma_{1,2} = \frac{N}{A} \pm \frac{M}{W} = \frac{4673,06}{10,24} \pm \frac{1,21}{5,46} = 456,35 \pm 0,22$$

$$\sigma_1 = 456,57 \text{ kN/m}^2 < \sigma_{t,dop} = 500 \text{ kN/m}^2$$

$$\sigma_2 = 456,35 \text{ kN/m}^2 < \sigma_{t,dop} = 500 \text{ kN/m}^2$$

Druga kombinacija:

$$M_{max} = 158,57 \text{ kNm}$$

$$N_{prirpadno} = 687,86 \text{ kN} \quad \rightarrow \quad N_{Ed} = N_{prir} + N_t = 687,86 + 204,8 = 892,66 \text{ kN}$$

$$\sigma_{1,2} = \frac{N}{A} \pm \frac{M}{W} = \frac{892,66}{10,24} \pm \frac{158,57}{5,46} = 87,17 \pm 29,04$$

$$\sigma_1 = 116,21 \text{ kN/m}^2 < \sigma_{t,dop} = 500 \text{ kN/m}^2$$

$$\sigma_2 = 58,13 \text{ kN/m}^2 < \sigma_{t,dop} = 500 \text{ kN/m}^2$$

Prva kombinacija:

$$M'_{Ed} = \sigma' \cdot \frac{b'^2}{2} \cdot 1,0 + (\sigma_1 - \sigma') \cdot \frac{2 \cdot b'^2 \cdot 1,0}{6}$$

$$M'_{Ed} = 456 \cdot \frac{1,35^2}{2} \cdot 1,0 + (456,57 - 456) \cdot \frac{2 \cdot 1,35^2 \cdot 1,0}{6} = 415,87 \text{ kNm}$$

Druga kombinacija:

$$M'_{Ed} = \sigma' \cdot \frac{b'^2}{2} \cdot 1,0 + (\sigma_1 - \sigma') \cdot \frac{2 \cdot b'^2 \cdot 1,0}{6}$$

$$M'_{Ed} = 92 \cdot \frac{1,35^2}{2} \cdot 1,0 + (116,21 - 92) \cdot \frac{2 \cdot 1,35^2 \cdot 1,0}{6} = 98,54 \text{ kNm}$$

$$\mu_{sds} = \frac{M_{Ed}}{b \cdot d^2 \cdot f_{cd}} = \frac{415,87 \cdot 100}{320 \cdot 77^2 \cdot 1,67} = 0,01$$

$$\text{Za } \varepsilon_{s1} = 10\text{‰}, \quad \varepsilon_{c2} = 0,6\text{‰}, \quad \zeta = 0,981 \quad \xi = 0,057$$

$$A_{s1} = \frac{M_{Ed}}{\zeta \cdot d \cdot f_{yd}} = \frac{415,87 \cdot 100}{0,981 \cdot 77 \cdot 43,48} = 12,66 \text{ cm}^2$$

$$A_{s1,min} = 0,1\% \cdot b \cdot h = 0,001 \cdot 320 \cdot 80 = 25,6 \text{ cm}^2$$

$$A_{s1,max} = 2,0\% \cdot b \cdot h = 0,02 \cdot 320 \cdot 80 = 512 \text{ cm}^2$$

Odabrana armatura 10Ø20 (31,42 cm²)

9. NACRTI

9.1. Armatura ploče pozicija 100 Donja zona M 1:100

9.2. Iskaz materijala pozicija 100

9.3. Armatura ploče pozicija 100 Gornja zona M 1:100

9.4. Iskaz materijala pozicija 100

9.5. Armatura ploče pozicija 200 Donja zona M 1:100

9.6. Iskaz materijala pozicija 200

9.7. Armatura ploče pozicije 200 Gornja zona – tlačna armature M 1:100

9.8. Iskaz materijala pozicija 200

9.9. Armatura ploče pozicija 200 Gornja zona M 1:100

9.10. Iskaz materijala pozicija 200

9.11. Armatura grede pozicije 206 M 1:20

9.12. Armatura grede pozicije 218 M 1:20

9.13. Armatura grede pozicije 110 M :20

9.14. Armatura grede pozicije 120 M 1:20

9.15. Armatura karakterističnog stupa M 1:20

9.16. Armatura karakterističnog stupa M 1:20

9.17. Temelj samac M 1:25

9.18. Armatura stubišta M 1:20

10.LITERATURA

- 1) I. Tomičić : *Betonske konstrukcije -3. izmijenjeno i dopunjeno izdanje*, Zagreb 1996
- 2) A. Harapin, J.Radnić: *Osnove betonskih konstrukcija, interna skripta- zapisi s predavanja; Fakultet građevinarstva, arhitekture i geodezije Split*
- 3) EN 1998:2008 Eurokod 8 –*Projektiranje konstrukcija otpornih na potres-1.dio*
- 4) Dio 1-1 :*Opća pravila i pravila za zgrade*
- 5) EN 1991: Eurokod 1 – *Djelovanja na konstrukciju*
- 6) EN 1992-1-1:2008 Eurokod 2 – *Projektiranje betonskih konstrukcija*
- 7) EN 1990:2008 Eurokod- *osnove projektiranja konstrukcija (EN1990:2008+A1:2005+AC:2008)*
- 8) F. Biasioli, G. mancini, M. Just, M. Curbach, J. Walraven, S. Gmainer, J. Arrieta. R. Frank, C. Morin, F. Robert: *EUROCODE 2: Background & applications design of concrete buildings*
- 9) Sunara Kusić, Marina; Radnić, Jure; Grgić, Nikola; Harapin, Alen *Fluid Structure Interaction Analysis of Liquid Tanks by the Coupled SPH - FEM Method with Experimental Verification. // Defect and Diffusion Forum, 391 (2019), 152-173 doi:10.4028/www.scientific.net/ddf.391.152 (međunarodna recenzija, članak, znanstveni)*
- 10) Buzov, Ante; Radnić, Jure; Grgić, Nikola *Effects of the drum height, joint type and bolts on the bearing capacity of composite multi-drum stone columns under static and earthquake loads. // Engineering Structures, 237 (2021), 112230, 19 doi:10.1016/j.engstruct.2021.112230 (međunarodna recenzija, članak, znanstveni)*
- 11) Banović, Ivan; Radnić, Jure; Grgić, Nikola *NUMERICAL MODEL FOR DYNAMIC ANALYSIS OF STRUCTURES WITH SEISMIC BASE ISOLATION USING A LAYER OF STONE PEBBLES. // Ingegneria Sismica, 38 (2021), 1; 37-65 (međunarodna recenzija, članak, znanstveni)*

12. Baloevic, Goran; Radnić, Jure; Grgic, Nikola.
Numerical model for dynamic analysis of masonry- infilled steel and concrete frames.
// *Materialwissenschaft und Werkstofftechnik*, 50 (2019), 5; 519-532
doi:10.1002/mawe.201900006 (međunarodna recenzija, članak, znanstveni)
13. Radnić, Jure; Baloević, Goran; Matešan, Domagoj; Smilović, Marija
On a numerical model for static and dynamic analysis of in-plane masonry infilled steel frames. // *Materialwissenschaft und Werkstofftechnik*, 44 (2013), 5; 423-430
doi:10.1002/mawe.201300146 (međunarodna recenzija, članak, znanstveni)
14. Radnić, Jure; Matešan, Domagoj
Ispitivanje armiranobetonske ploče pod dugotrajnim opterećenjem i rasterećenjem. // *Građevinar*, 59 (2007), 967-973 (podatak o recenziji nije dostupan, prethodno priopćenje, znanstveni)

Armatura ploče pozicija 100

DONJA ZONA

M 1:100

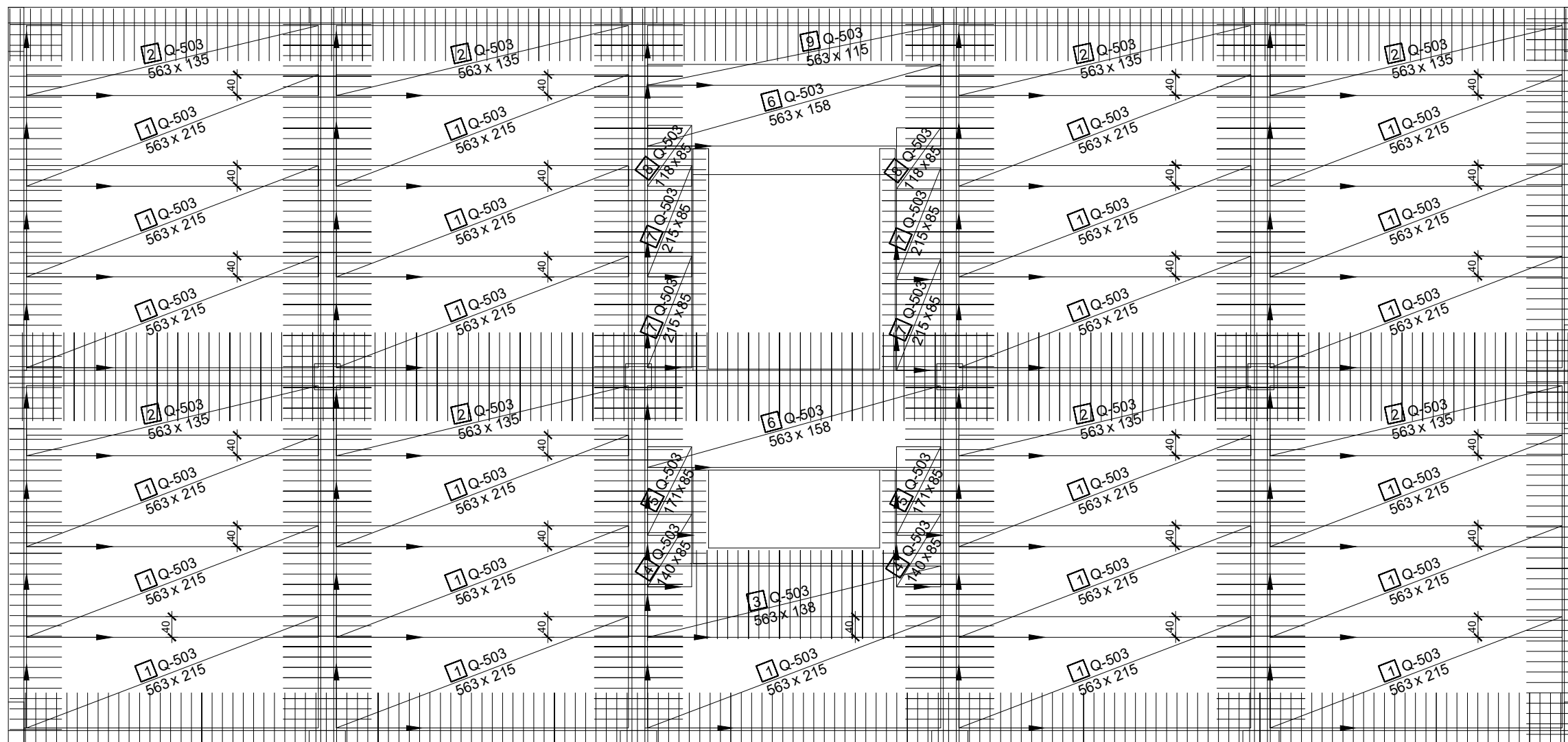

 <p>SVEUČILIŠTE U SPLITU, FAKULTET GRAĐEVINARSTVA, ARHITEKTURE I GEODEZIJE 21000 SPLIT, MATICE HRVATSKE 15 MB 3149463, tel. + 385 (0)21 303333; fax + 385 (0)21 465117</p>	INVESTITOR / NARUČITELJ: FGAG, Matice hrvatske 15, 21000 Split	MJERILO: 1:100
	GRADEVINA: Poslovno-stambena zgrada	DATUM: rujan, 2021.
	VRSTA PROJEKTA: Projekt konstrukcije	BROJ PROJEKTA: kk-07-2021.
	RAZINA PROJEKTA: IDEJNI PROJEKT	PROJEKTANT: Luciana Deur
	SADRŽAJ: Armaturni plan pozicija 100	BROJ PRILOGA: 1

ISKAZ MREŽASTE ARMATURE

Čelik B500B

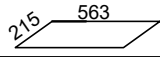
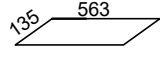
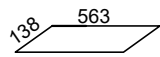
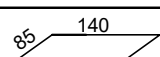
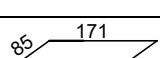
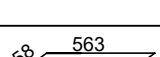
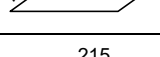
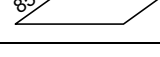
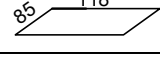
POZ.	TIP MREŽE	OBLIK	DIMENZIJE (cm)	KOM.	MASA (kg/m ²)	UKUPNA MASA
1	Q-503		563x215	25	8.03	2429.98
2	Q-503		563x135	8	8.03	488.26
3	Q-503		563x138	1	8.03	62.39
4	Q-503		140x85	2	8.03	19.11
5	Q-503		171x85	2	8.03	23.34
6	Q-503		563x158	2	8.03	142.86
7	Q-503		215x85	4	8.03	58.70
8	Q-503		118x85	2	8.03	16.11
9	Q-503		563x115	1	8.03	51.10
UKUPNO: (KG)...						3291.85

ISKAZ REBRASTE ARMATURE

Čelik B500B

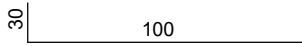
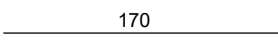
POZ.	OBLIK	Ø	JED. MASA (kg/m)	KOM.	L(cm)	MASA (kg)
1		10	0,617	446	130	373.78
2		10	0,617	664	170	696.47
UKUPNO: (KG)						1054.21

 <p>SVEUČILIŠTE U SPLITU, FAKULTET GRAĐEVINARSTVA, ARHITEKTURE I GEODEZIJE 21000 SPLIT, MATICE HRVATSKE 15 MB 3149463; tel: + 385 (0)21 303333; fax: + 385 (0)21 465117</p>	INVESTITOR / NARUČITELJ: FGAG, Matice hrvatske 15, 21000 Split	MJERILO: 1:100
	GRADEVINA: Poslovno-stambena zgrada	DATUM: rujan, 2021.
	VRSTA PROJEKTA: Projekt konstrukcije	BROJ PROJEKTA: kk-07-2021.
	RAZINA PROJEKTA: IDEJNI PROJEKT	PROJEKTANT: Luciana Deur
	SADRŽAJ: Iskaz materijala pozicija 100	BROJ PRILOGA: 2

Armatura ploče pozicija 100

GORNJA ZONA

M 1:100

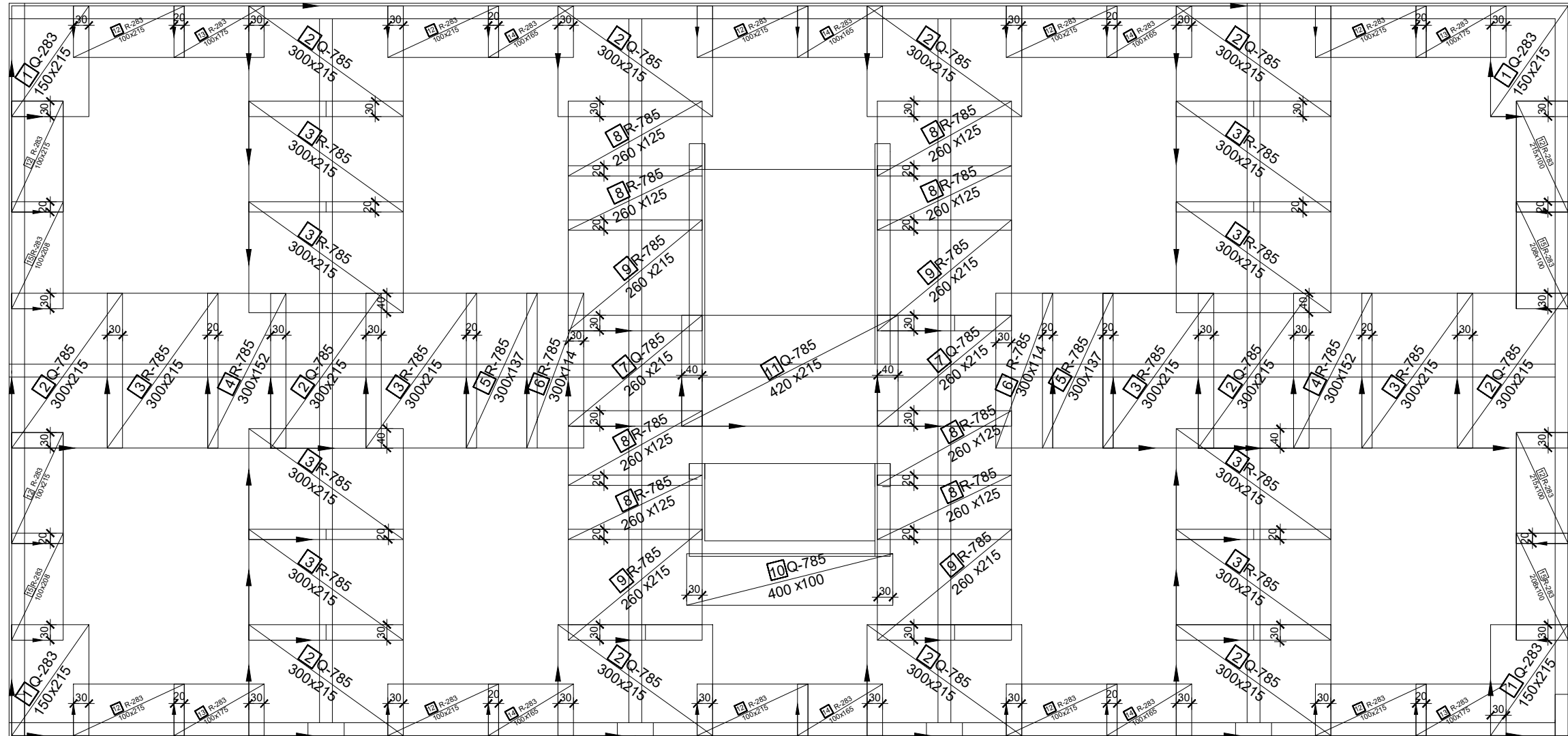

 <p>SVEUČILIŠTE U SPLITU FAKULTET GRAĐEVINARSTVA, ARHITEKTURE I GEODEZIJE 21000 SPLIT, MATICE HRVATSKE 15 MB 3149463, tel. +385 (0)21 303333; fax +385 (0)21 465117</p>	INVESTITOR / NARUČITELJ: FGAG, Matice hrvatske 15, 21000 Split	MJERILO: 1:100
	GRADEVINA: Poslovno-stambena zgrada	DATUM: rujan, 2021.
	VRSTA PROJEKTA: Projekt konstrukcije	BROJ PROJEKTA: kk-07-2021.
	RAZINA PROJEKTA: IDEJNI PROJEKT	PROJEKTANT: Luciana Deur
	SADRŽAJ: Armaturni plan pozicija 100	BROJ PRILOGA: 3

ISKAZ MREŽASTE ARMATURE

Čelik B500B

POZ.	TIP MREŽE	OBLIK	DIMENZIJE (cm)	KOM.	MASA (kg/m ²)	UKUPNA MASA
1	Q-283		150x215	4	4.48	57.80
2	Q-785		300x215	12	12.46	964.40
3	R-785		300x215	12	7.35	568.89
4	R-785		300x152	2	7.35	67.03
5	R-785		300x137	2	7.35	60.42
6	R-785		300x114	2	7.35	50.27
7	Q-785		260x215	2	12.46	139.30
8	R-785		260x125	8	7.35	191.1
9	R-785		260x215	4	7.35	164.35
10	Q-785		400x100	1	12.46	52.33
11	Q-785		420x215	1	12.46	112.51
12	R-283		100x215	14	2.77	83.38
13	R-283		100x175	4	2.77	19.39
14	R-283		100x165	6	2.77	27.42
15	R-283		100x208	4	2.77	23.05

UKUPNO: (KG)... 2575.64

 SVEUČILIŠTE U SPLITU, FAKULTET GRAĐEVINARSTVA, ARHITEKTURE I GEODEZIJE 21000 SPLIT, MATICE HRVATSKE 15 MB 3149463; tel: + 385 (0)21 303333; fax: + 385 (0)21 465117	INVESTITOR / NARUČITELJ: FGAG, Matice hrvatske 15, 21000 Split	MJERILO: 1:100
	GRADEVINA: Poslovno-stambena zgrada	DATUM: rujan, 2021.
	VRSTA PROJEKTA: Projekt konstrukcije	BROJ PROJEKTA: kk-07-2021.
	RAZINA PROJEKTA: IDEJNI PROJEKT	PROJEKTANT: Luciana Deur
	SADRŽAJ: Iskaz materijala pozicija 100	BROJ PRILOGA: 4

Armatura ploče pozicija 200

DONJA ZONA

M 1:100

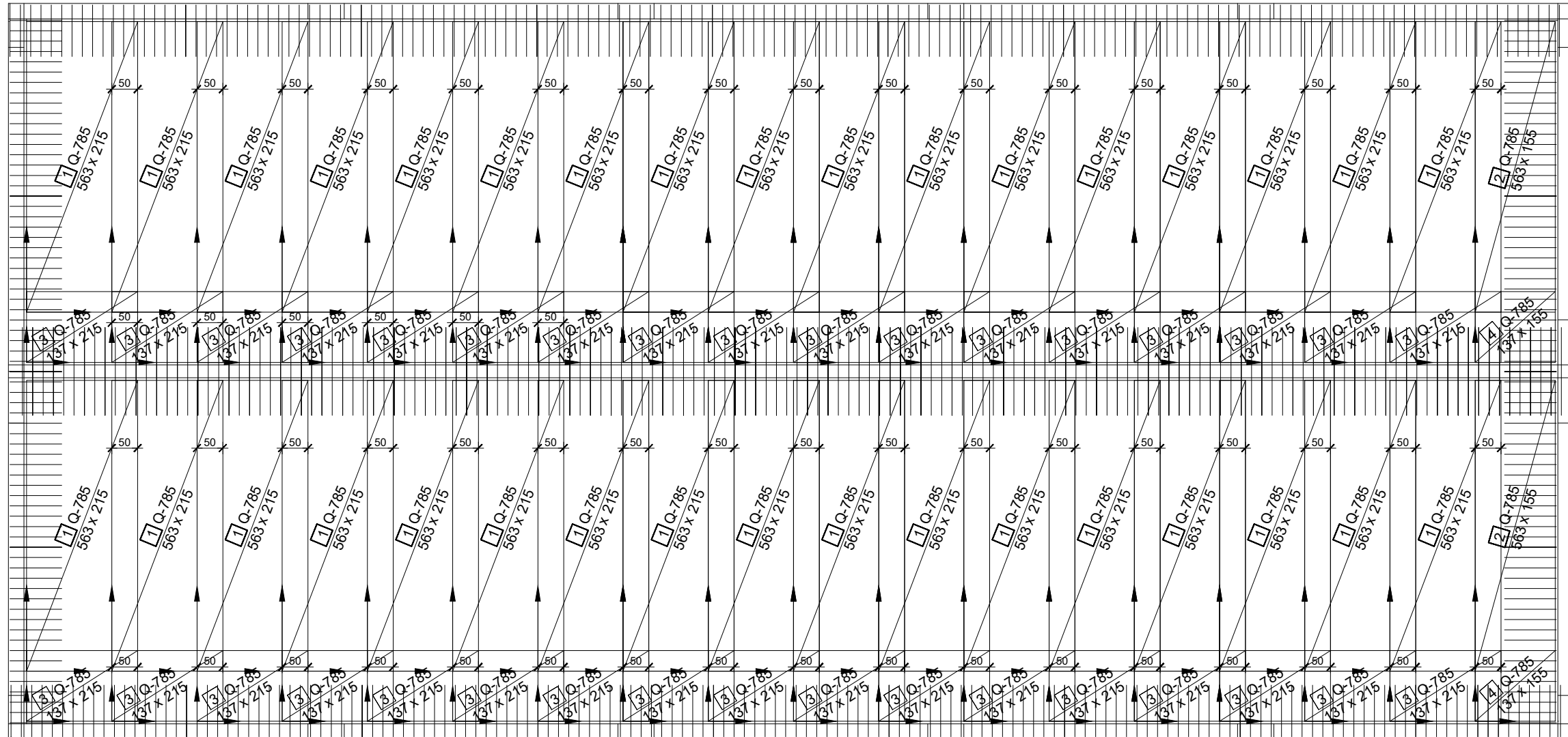

 <p>SVEUČILIŠTE U SPLITU, FAKULTET GRAĐEVINARSTVA, ARHITEKTURE I GEODEZIJE 21000 SPLIT, MATICE HRVATSKE 15 MB 3149463, tel: +385 (0)21 303333; fax: +385 (0)21 465117</p>	INVESTITOR / NARUČITELJ: FGAG, Matice hrvatske 15, 21000 Split	MJERILO: 1:100
	GRADEVINA: Poslovno-stambena zgrada	DATUM: rujan, 2021.
	VRSTA PROJEKTA: Projekt konstrukcije	BROJ PROJEKTA: kk-07-2021.
	RAZINA PROJEKTA: IDEJNI PROJEKT	PROJEKTANT: Luciana Deur
	SADRŽAJ: Armaturni plan pozicija 200	BROJ PRILOGA: 5

ISKAZ MREŽASTE ARMATURE

Čelik B500B

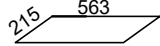
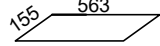
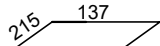
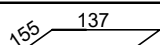
POZ.	TIP MREŽE	OBLIK	DIMENZIJE (cm)	KOM.	MASA (kg/m ²)	UKUPNA MASA
1	Q-785		563x215	34	12.46	5127.95
2	Q-785		563x155	2	12.46	217.46
3	Q-785		137x215	34	12.46	1247.83
4	Q-785		137x155	2	12.46	52.91
UKUPNO: (KG)...						6646.15

ISKAZ REBRASTE ARMATURE

Čelik B500B

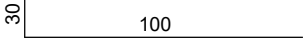
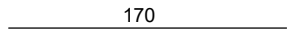
POZ.	OBLIK	Ø	JED. MASA (kg/m)	KOM.	L(cm)	MASA (kg)
1		10	0,617	466	130	373.78
2		10	0,617	234	170	245.44
UKUPNO: (KG)						619.22

 <p>SVEUČILIŠTE U SPLITU, FAKULTET GRAĐEVINARSTVA, ARHITEKTURE I GEODEZIJE 21000 SPLIT, MATICE HRVATSKE 15 MB 3149463; tel: + 385 (0)21 303333; fax: + 385 (0)21 465117</p>	INVESTITOR / NARUČITELJ: FGAG, Matice hrvatske 15, 21000 Split	MJERILO: 1:100
	GRADEVINA: Poslovno-stambena zgrada	DATUM: rujan, 2021.
	VRSTA PROJEKTA: Projekt konstrukcije	BROJ PROJEKTA: kk-07-2021.
	RAZINA PROJEKTA: IDEJNI PROJEKT	PROJEKTANT: Luciana Deur
	SADRŽAJ: Iskaz materijala pozicija 200	BROJ PRILOGA: 6

Armatura ploče pozicija 200 GORNJA ZONA - tlačna armatura M 1:100

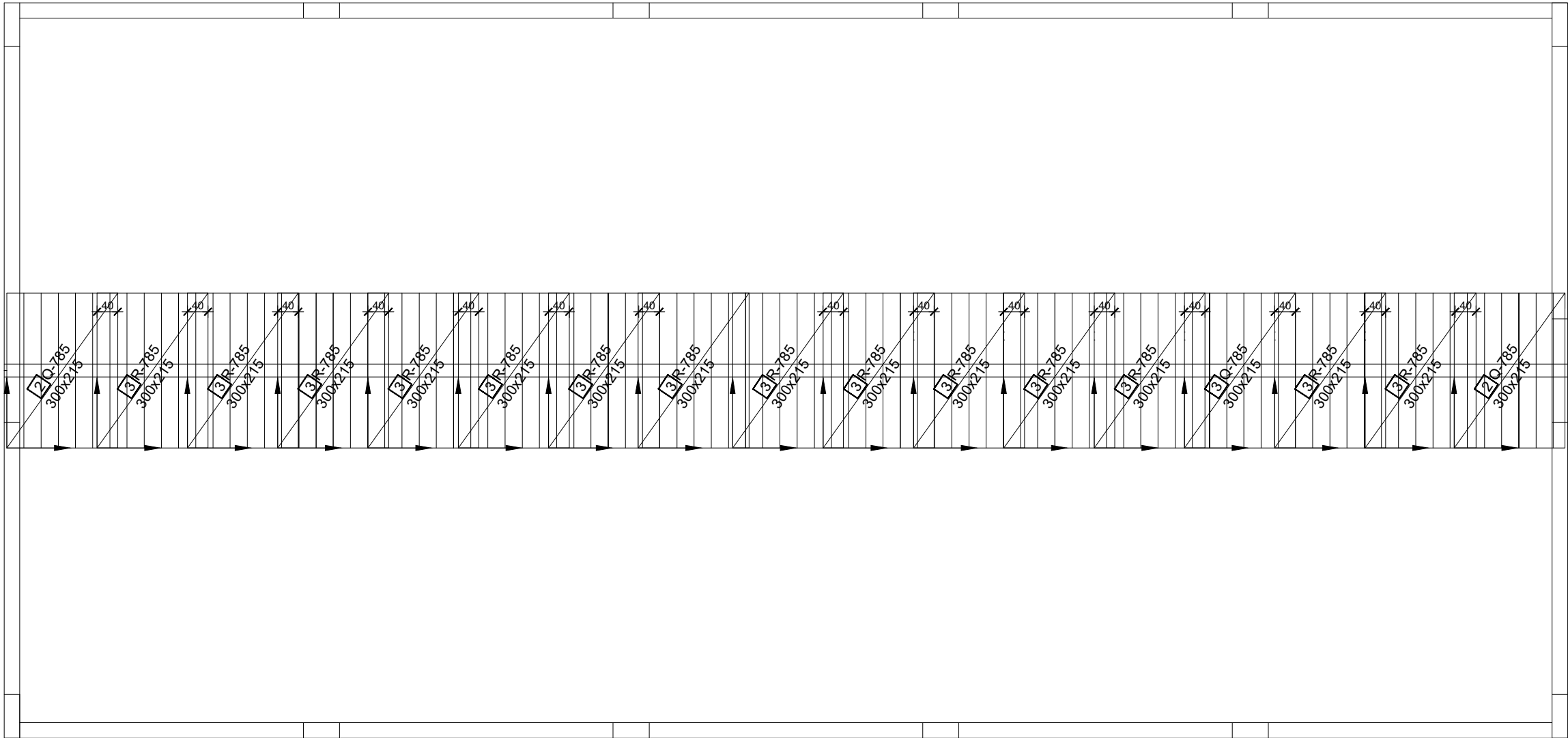

 <p style="font-size: small;">SVEUČILIŠTE U SPLITU FAKULTET GRAĐEVINARSTVA, ARHITEKTURE I GEODEZIJE 21000 SPLIT, MATICE HRVATSKE 15 MB 3149463, tel: +385 (0)21 303333; fax: +385 (0)21 465117</p>	INVESTITOR / NARUČITELJ: FGAG, Matice hrvatske 15, 21000 Split	MJERILO: 1:100
	GRADEVINA: Poslovno-stambena zgrada	DATUM: rujan, 2021.
	VRSTA PROJEKTA: Projekt konstrukcije	BROJ PROJEKTA: kk-07-2021.
	RAZINA PROJEKTA: IDEJNI PROJEKT	PROJEKTANT: Luciana Deur
	SADRŽAJ: Armaturni plan pozicija 200	BROJ PRILOGA: 7

ISKAZ MREŽASTE ARMATURE

Čelik B500B

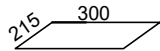
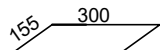
POZ.	TIP MREŽE	OBLIK	DIMENZIJE (cm)	KOM.	MASA (kg/m ²)	UKUPNA MASA
2	Q-785		300x215	2	12.46	160.73
3	R-785		300x215	15	7.35	711.11
UKUPNO: (KG)...						871.84

ISKAZ REBRASTE ARMATURE

Čelik B500B

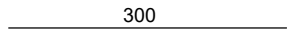
POZ.	OBLIK	Ø	JED. MASA (kg/m)	KOM.	L(cm)	MASA (kg)
1		10	0,617	104	300	555.3
UKUPNO: (KG)						555.3

 <p>SVEUČILIŠTE U SPLITU, FAKULTET GRAĐEVINARSTVA, ARHITEKTURE I GEODEZIJE 21000 SPLIT, MATICE HRVATSKE 15 MB 3149463; tel: + 385 (0)21 303333; fax: + 385 (0)21 465117</p>	INVESTITOR / NARUČITELJ: FGAG, Matice hrvatske 15, 21000 Split	MJERILO: 1:100
	GRAĐEVINA: Poslovno-stambena zgrada	DATUM: rujan, 2021.
	VRSTA PROJEKTA: Projekt konstrukcije	BROJ PROJEKTA: kk-07-2021.
	RAZINA PROJEKTA: IDEJNI PROJEKT	PROJEKTANT: Luciana Deur
	SADRŽAJ: Iskaz materijala pozicija 200	BROJ PRILOGA: 8

Armatura ploče pozicija 200

GORNJA ZONA

M 1:100

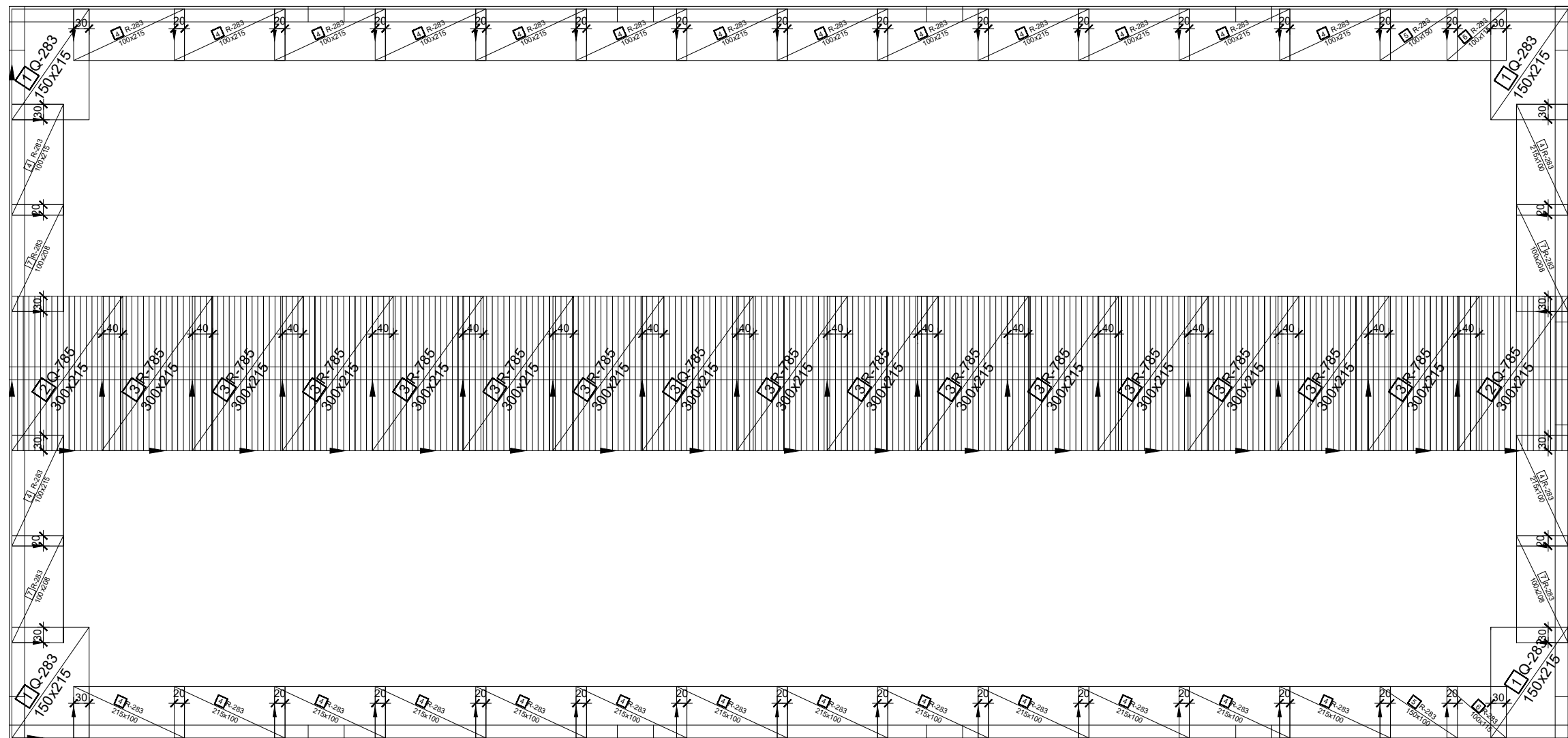

 <p>SVEUČILIŠTE U SPLITU FAKULTET GRAĐEVINARSTVA, ARHITEKTURE I GEODEZIJE 21000 SPLIT, MATICE HRVATSKE 15 MB 3149463, tel. + 385 (0)21 303333, fax + 385 (0)21 465117</p>	INVESTITOR / NARUČITELJ: FGAG, Matice hrvatske 15, 21000 Split	MJERILO: 1:100
	GRADEVINA: Poslovno-stambena zgrada	DATUM: rujan, 2021.
	VRSTA PROJEKTA: Projekt konstrukcije	BROJ PROJEKTA: kk-07-2021.
	RAZINA PROJEKTA: IDEJNI PROJEKT	PROJEKTANT: Luciana Deur
	SADRŽAJ: Armaturni plan pozicija 200	BROJ PRILOGA: 9

ISKAZ MREŽASTE ARMATURE

Čelik B500B

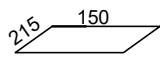
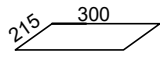
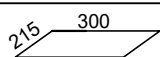
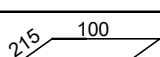
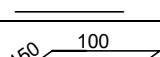
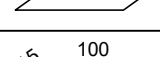
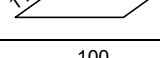
POZ.	TIP MREŽE	OBLIK	DIMENZIJE (cm)	KOM.	MASA (kg/m ²)	UKUPNA MASA
1	Q-283		150x215	4	4.48	57.79
2	Q-785		300x215	2	12.46	160.73
3	R-785		300x215	15	7.35	711.11
4	R-283		100x215	30	2.77	178.67
5	R-283		100x150	2	2.77	8.3
6	R-283		100x115	2	2.77	6.37
7	R-283		100x208	4	2.77	11.97
UKUPNO: (KG)...						1134.94

ISKAZ REBRASTE ARMATURE

Čelik B500B

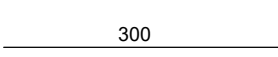
POZ.	OBLIK	Ø	JED. MASA (kg/m)	KOM.	L(cm)	MASA (kg)
1		14	1,250	309	300	1158.75
UKUPNO: (KG)						1158.75

 <p>SVEUČILIŠTE U SPLITU, FAKULTET GRAĐEVINARSTVA, ARHITEKTURE I GEODEZIJE 21000 SPLIT, MATICE HRVATSKE 15 MB 3149463; tel: + 385 (0)21 303333; fax: + 385 (0)21 465117</p>	INVESTITOR / NARUČITELJ: FGAG, Matice hrvatske 15, 21000 Split	MJERILO: 1:100
	GRADEVINA: Poslovno-stambena zgrada	DATUM: rujan, 2021.
	VRSTA PROJEKTA: Projekt konstrukcije	BROJ PROJEKTA: kk-07-2021.
	RAZINA PROJEKTA: IDEJNI PROJEKT	PROJEKTANT: Luciana Deur
	SADRŽAJ: Iskaz materijala pozicija 200	BROJ PRILOGA: 10

Armatura grede pozicije 206 M 1:20

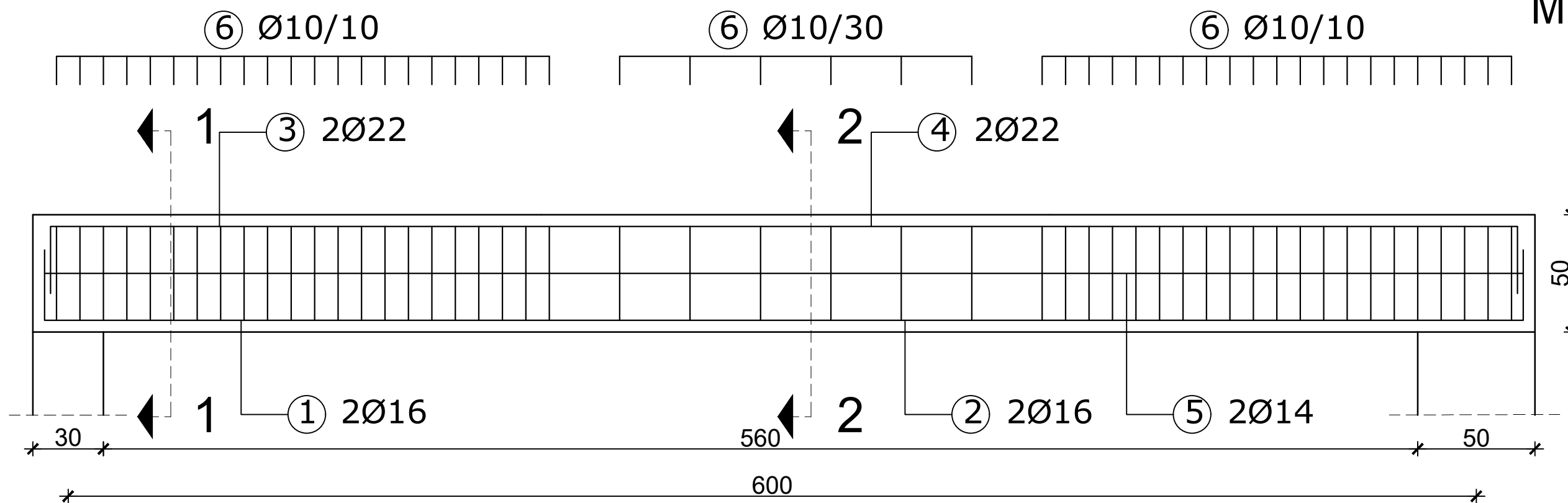

Presjek 1-1

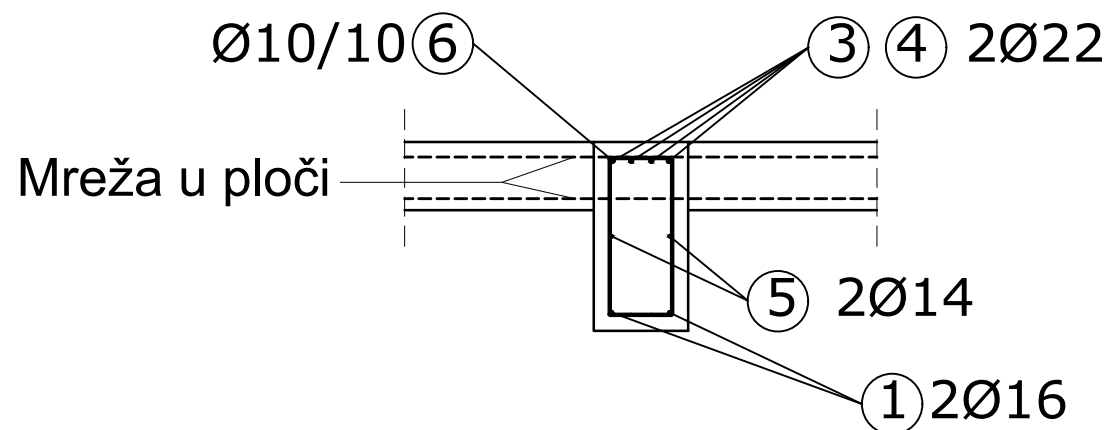

Presjek 2-2

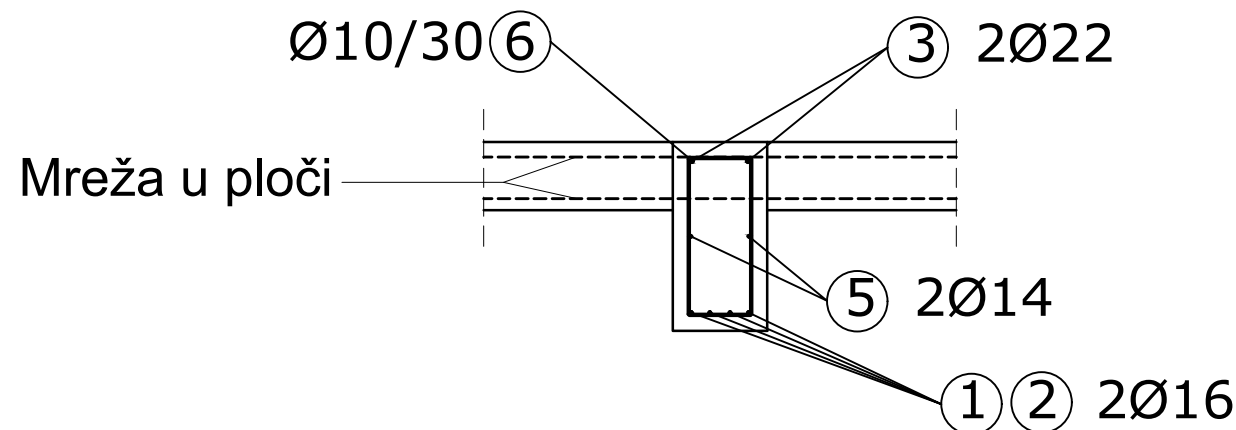

<p>SVEUČILIŠTE U SPLITU FAKULTET GRAĐEVINARSTVA, ARHITEKTURE I GEODEZIJE 21000 SPLIT, MATICE HRVATSKE 15 MB 3149463, tel: +385 (0)21 303333; fax: +385 (0)21 465117</p>	INVESTITOR / NARUČITELJ: FGAG, Matice hrvatske 15, 21000 Split	MJERILO: 1:200
	GRAĐEVINA: Poslovno-stambena zgrada	DATUM: rujan, 2021.
	VRSTA PROJEKTA: Projekt konstrukcije	BROJ PROJEKTA: kk-07-2021.
	RAZINA PROJEKTA: IDEJNI PROJEKT	PROJEKTANT: Luciana Deur
	SADRŽAJ: Armatura grede pozicije 206	BROJ PRILOGA: 11

Armatura grede
pozicije 218
M 1:20

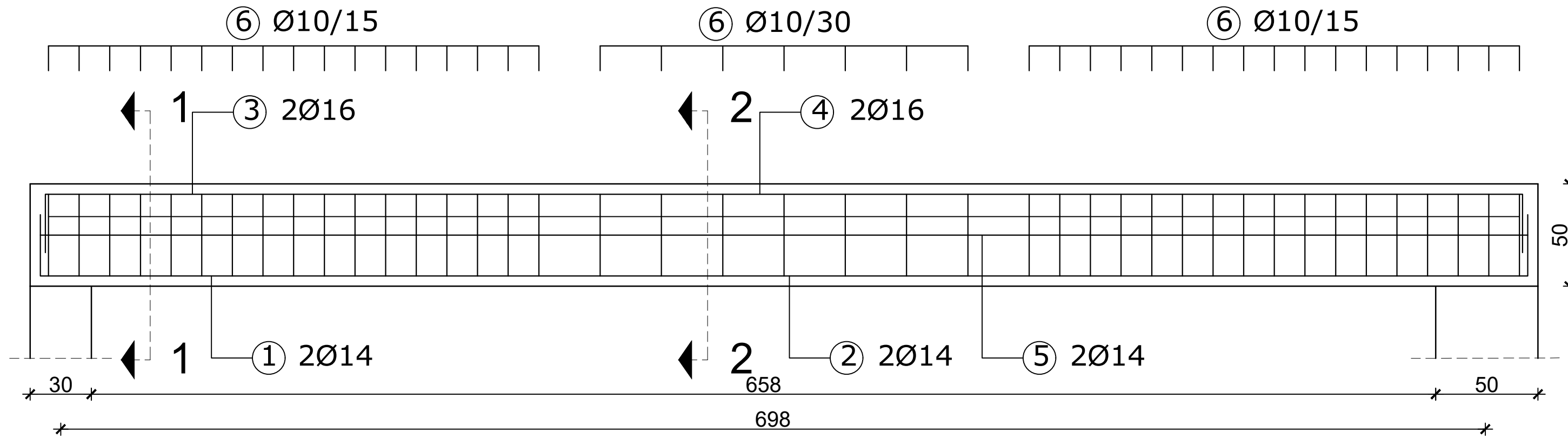

Presjek 1-1

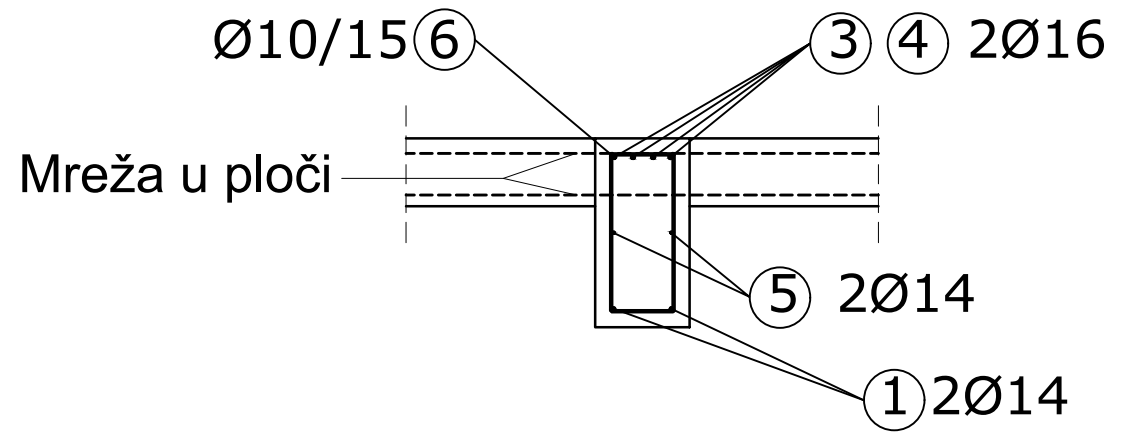

Presjek 2-2

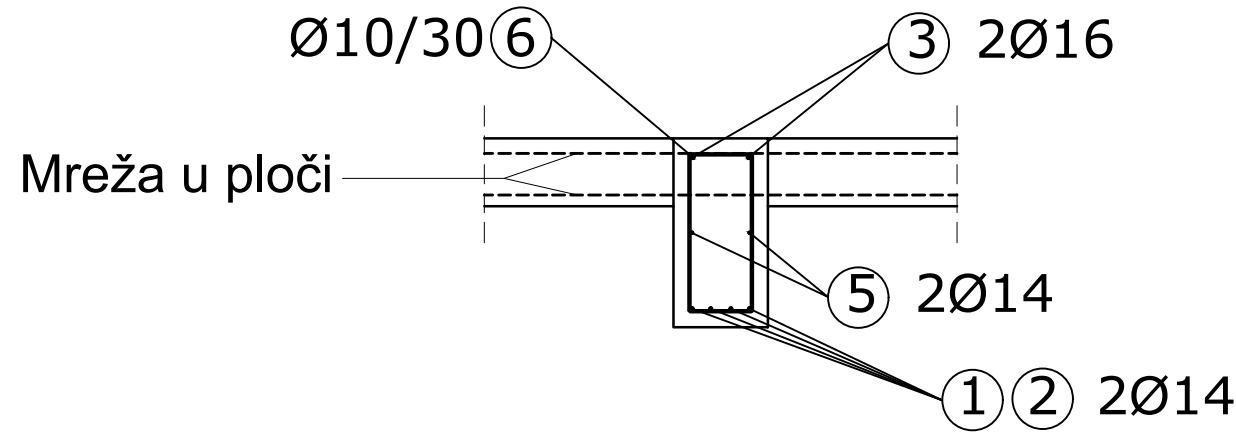

 <p>SVEUČILIŠTE U SPLITU FAKULTET GRAĐEVINARSTVA, ARHITEKTURE I GEODEZIJE 21000 SPLIT, MATICE HRVATSKE 15 MB 3149463, tel: +385 (0)21 303333, fax: +385 (0)21 465117</p>	INVESTITOR / NARUČITELJ: FGAG, Matice hrvatske 15, 21000 Split	MJERILO: 1:200
	GRADJEVINA: Poslovno-stambena zgrada	DATUM: rujan, 2021.
	VRSTA PROJEKTA: Projekt konstrukcije	BROJ PROJEKTA: kk-07-2021.
	RAZINA PROJEKTA: IDEJNI PROJEKT	PROJEKTANT: Luciana Deur
	SADRŽAJ: Armatura grede pozicije 218	BROJ PRILOGA: 12

Armatura grede pozicije 110 M 1:20

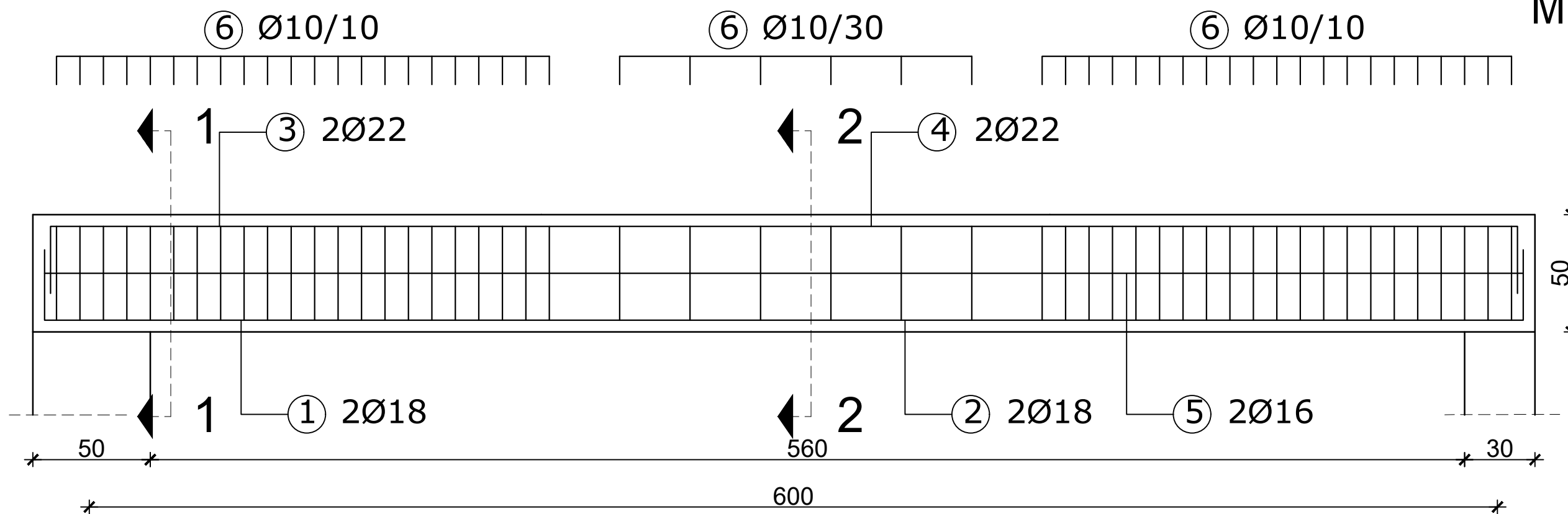

Presjek 1-1

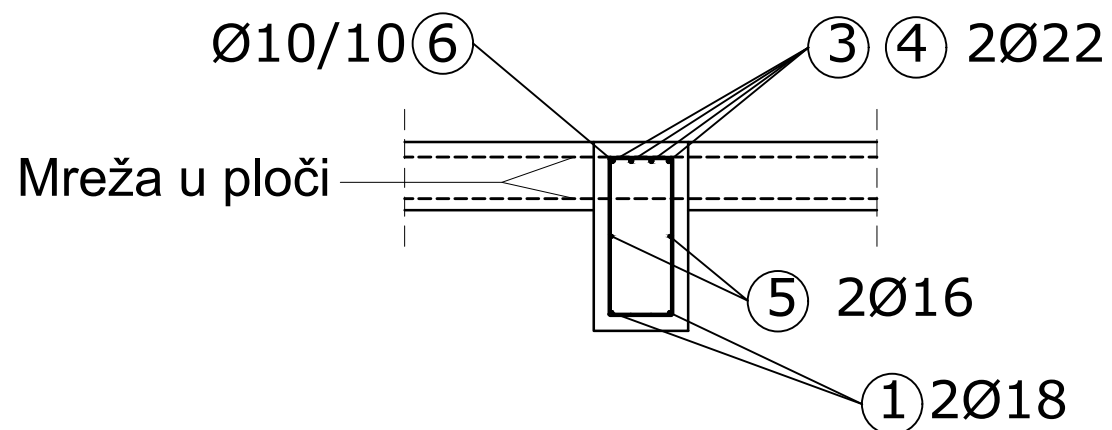

Presjek 2-2

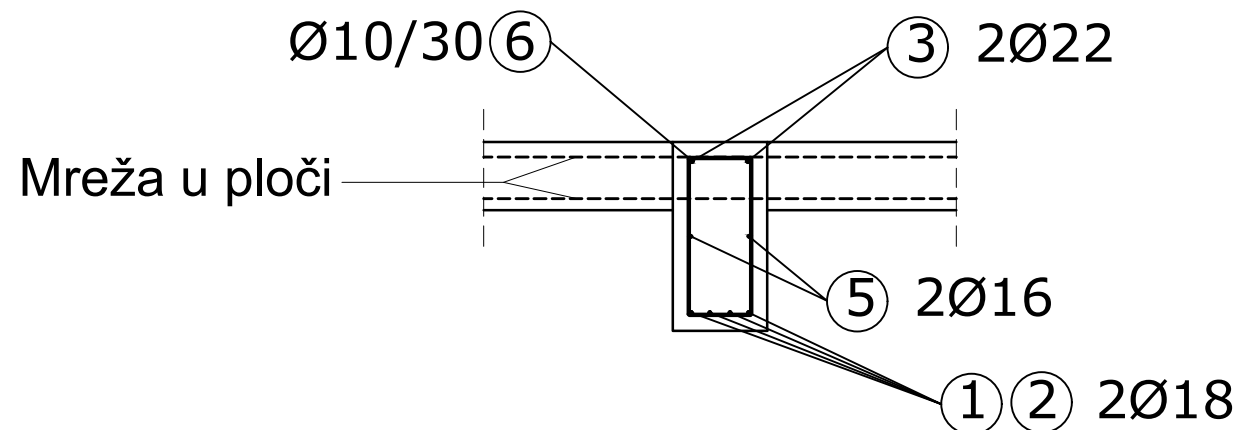

<p>SVEUČILIŠTE U SPLITU FAKULTET GRAĐEVINARSTVA, ARHITEKTURE I GEODEZIJE 21000 SPLIT, MATICE HRVATSKE 15 MB 3149463, tel: +385 (0)21 303333; fax: +385 (0)21 465117</p>	INVESTITOR / NARUČITELJ: FGAG, Matice hrvatske 15, 21000 Split	MJERILO: 1:200
	GRAĐEVINA: Poslovno-stambena zgrada	DATUM: rujan, 2021.
	VRSTA PROJEKTA: Projekt konstrukcije	BROJ PROJEKTA: kk-07-2021.
	RAZINA PROJEKTA: IDEJNI PROJEKT	PROJEKTANT: Luciana Deur
	SADRŽAJ: Armatura grede pozicije 110	BROJ PRILOGA: 13

Armatura grede
pozicije 120
M 1:20

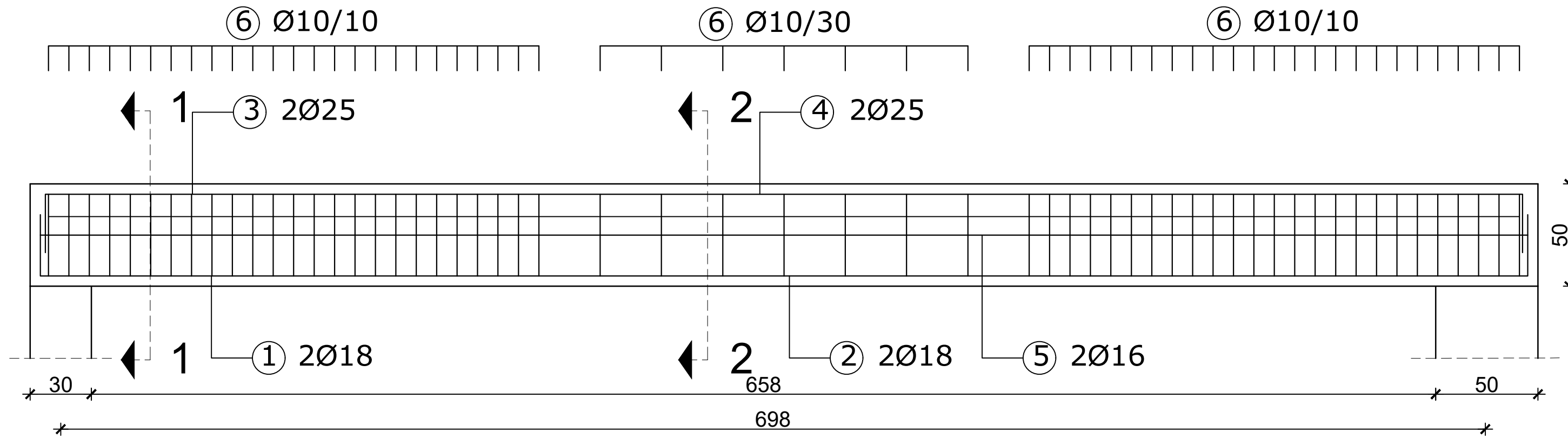

Presjek 1-1

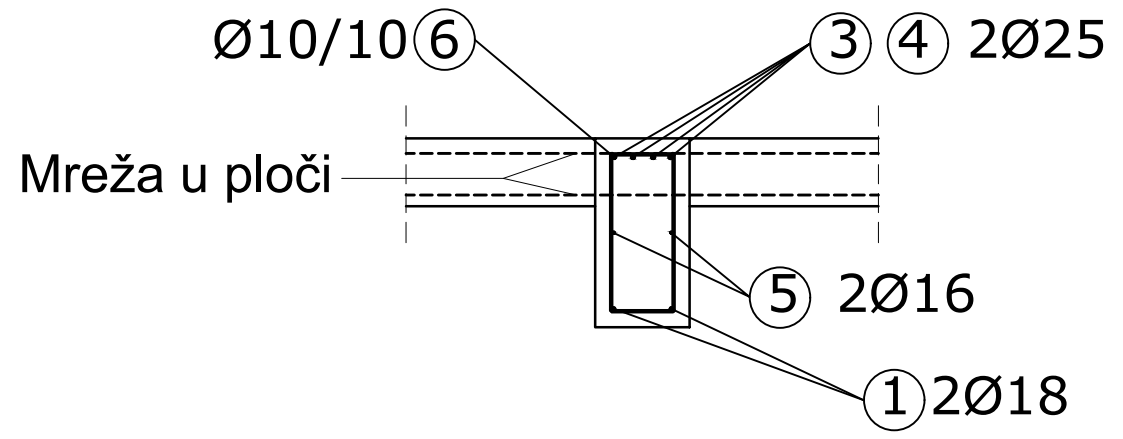

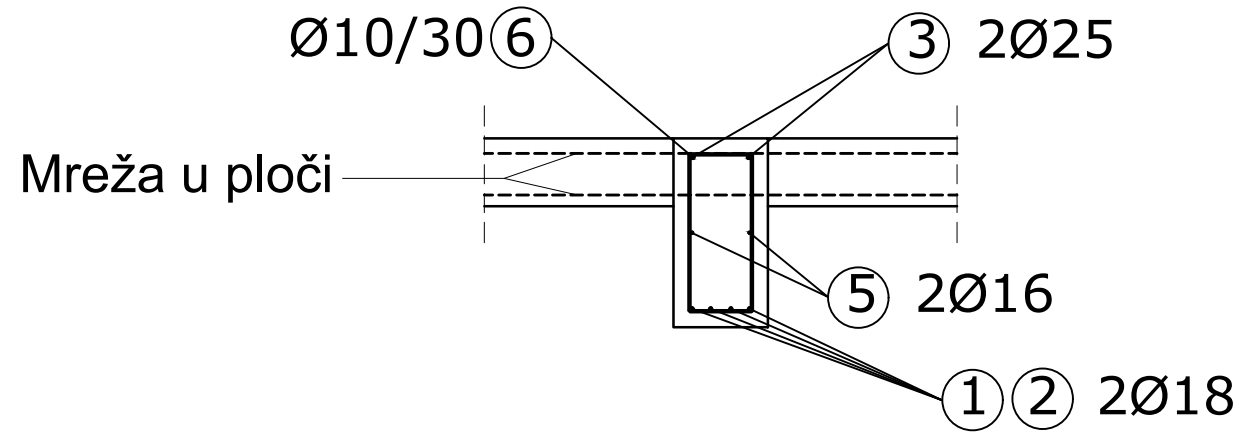

Presjek 2-2

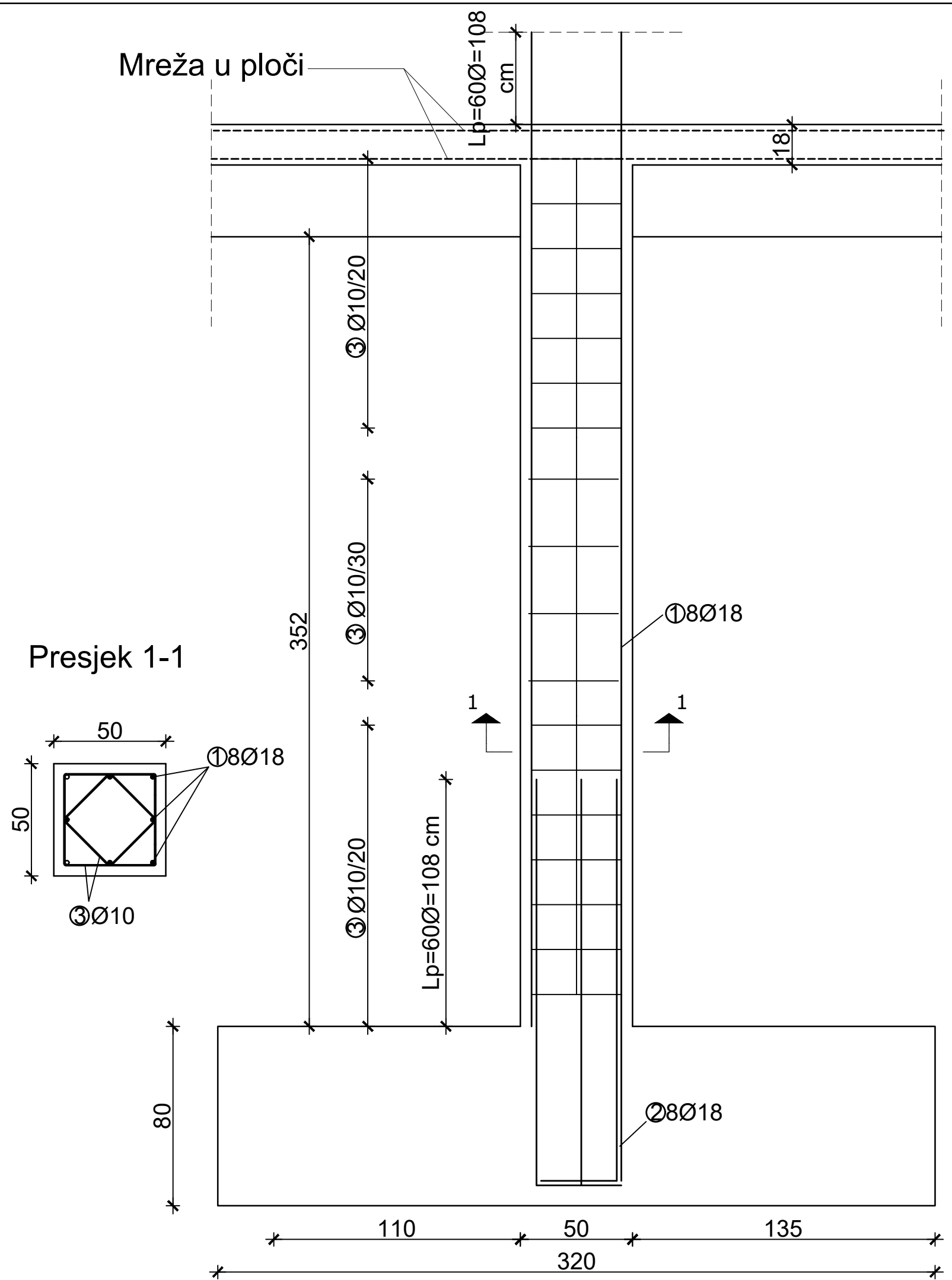

<p>SVEUČILIŠTE U SPLITU FAKULTET GRAĐEVINARSTVA, ARHITEKTURE I GEODEZIJE 21000 SPLIT, MATICE HRVATSKE 15 MB 3149463, tel: +385 (0)21 303333, fax: +385 (0)21 465117</p>	INVESTITOR / NARUČITELJ: FGAG, Matice hrvatske 15, 21000 Split	MJERILO: 1:200
	GRADEVINA: Poslovno-stambena zgrada	DATUM: rujan, 2021.
	VRSTA PROJEKTA: Projekt konstrukcije	BROJ PROJEKTA: kk-07-2021.
	RAZINA PROJEKTA: IDEJNI PROJEKT	PROJEKTANT: Luciana Deur
	SADRŽAJ: Armatura grede pozicije 120	BROJ PRILOGA: 14

Armatura karakterističnog stupa M 1:20



 <p>SVEUČILIŠTE U SPLITU FAKULTET GRAĐEVINARSTVA, ARHITEKTURE I GEODEZIJE 21000 SPLIT, MATICE HRVATSKE 15 MB 3149463; tel. + 385 (0)21 303333; fax + 385 (0)21 465117</p>	INVESTITOR / NARUČITELJ: FGAG, Matice hrvatske 15, 21000 Split	MJERILO: 1:200
	GRADEVINA: Poslovno-stambena zgrada	DATUM: rujan, 2021.
	VRSTA PROJEKTA: Projekt konstrukcije	BROJ PROJEKTA: kk-07-2021.
	RAZINA PROJEKTA: IDEJNI PROJEKT	PROJEKTANT: Luciana Deur
	SADRŽAJ: Armatura stupa	BROJ PRILOGA: 15

Temelj samac T1 M 1:25

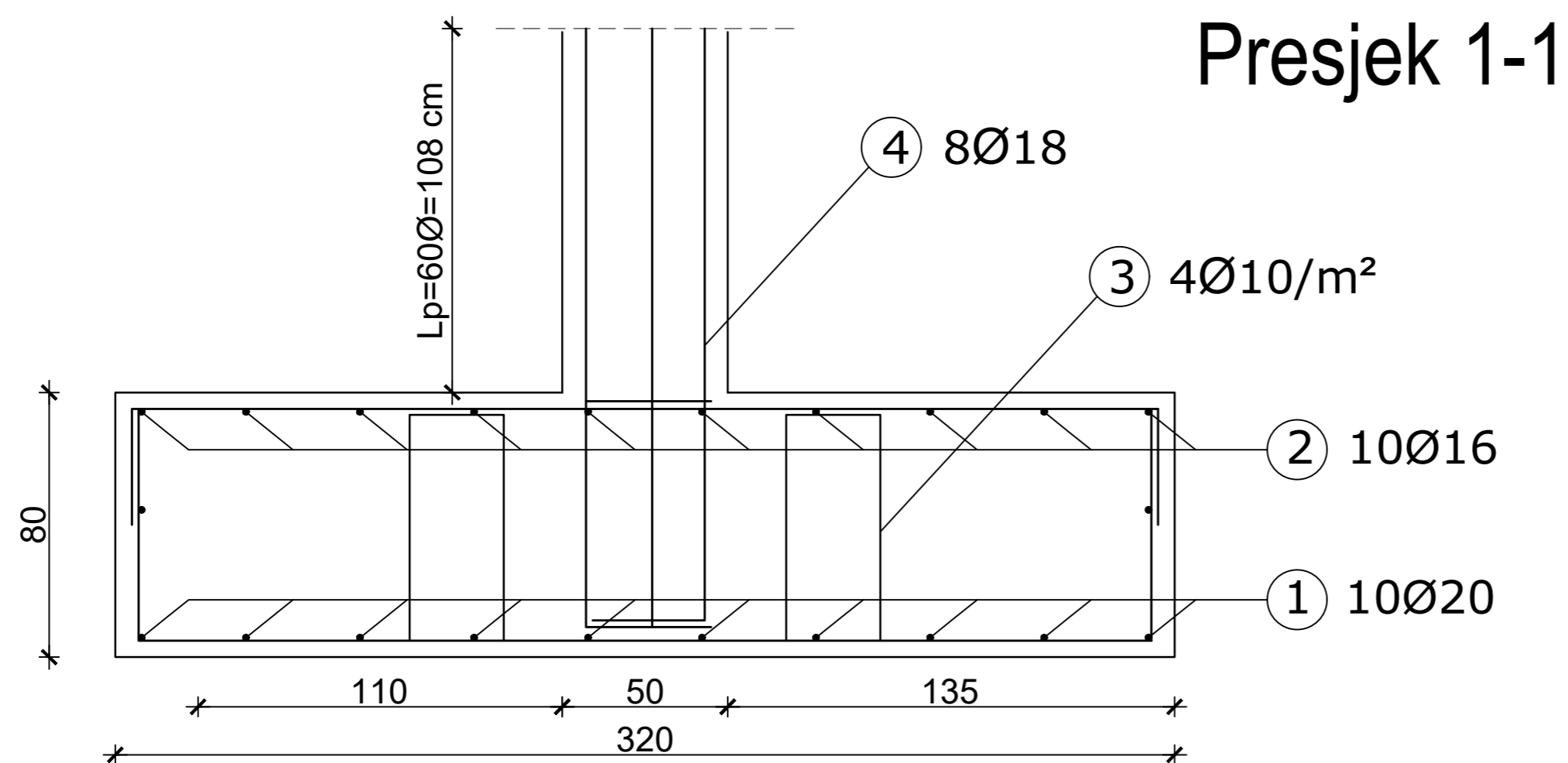
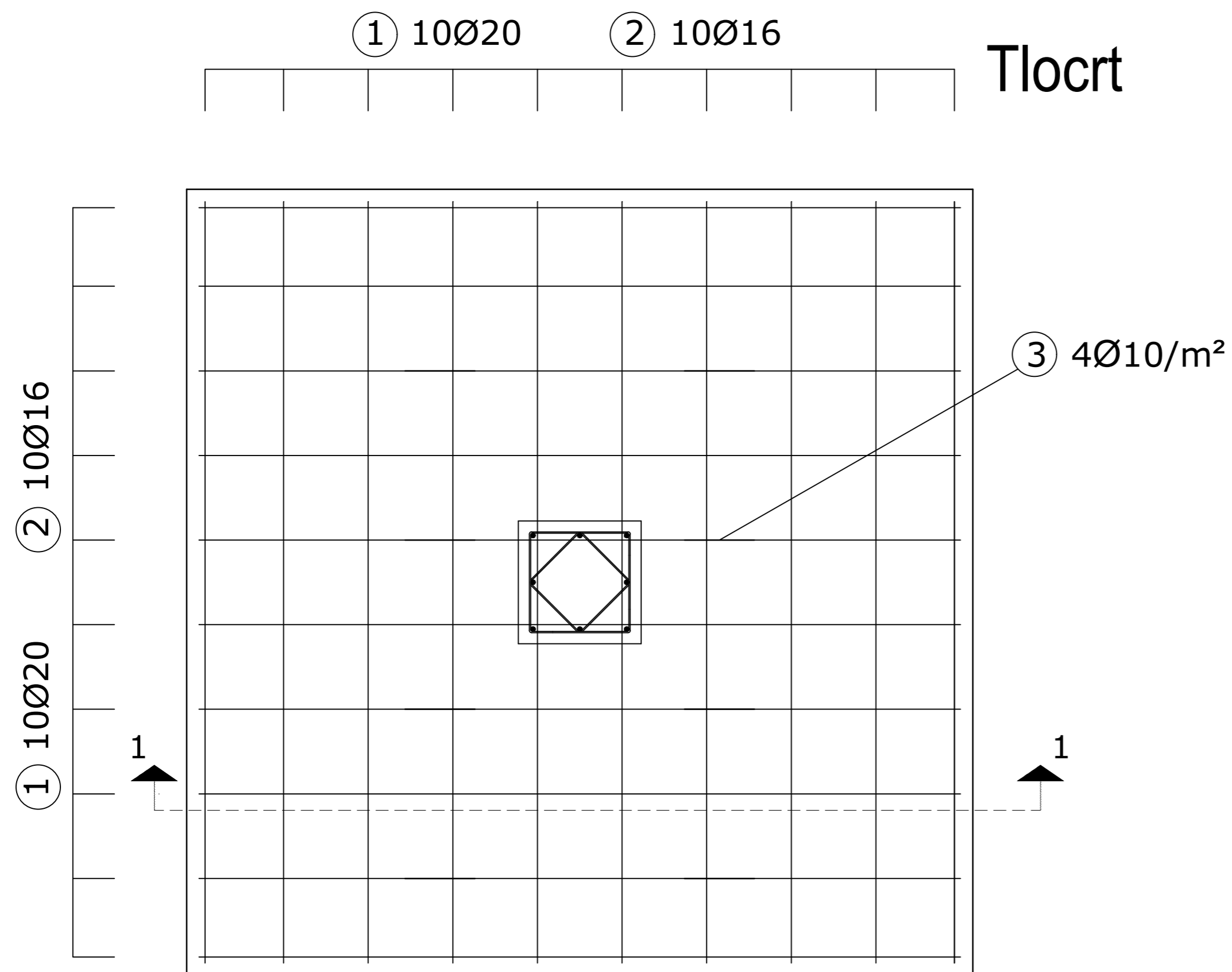

 <small>SVEUČILIŠTE U SPLITU, FAKULTET GRAĐEVINARSTVA, ARHITEKTURE I GEODEZIJE 21000 SPLIT, MATICE HRVATSKE 15 MB 3149493, tel. +385 (0)21 303333, fax +385 (0)21 485117</small>	INVESTITOR / NARUČITELJ: FGAG, Matice hrvatske 15, 21000 Split	MJERILO: 1:200
	GRAĐEVINA: Poslovno-stambena zgrada	DATUM: rujan, 2021.
	VRSTA PROJEKTA: Projekt konstrukcije	BROJ PROJEKTA: kk-07-2021.
	RAZINA PROJEKTA: IDEJNI PROJEKT	PROJEKTANT: Luciana Deur
	SADRŽAJ: Armatura temelja	BROJ PRILOGA: 17

Armatura stubišta M 1:20

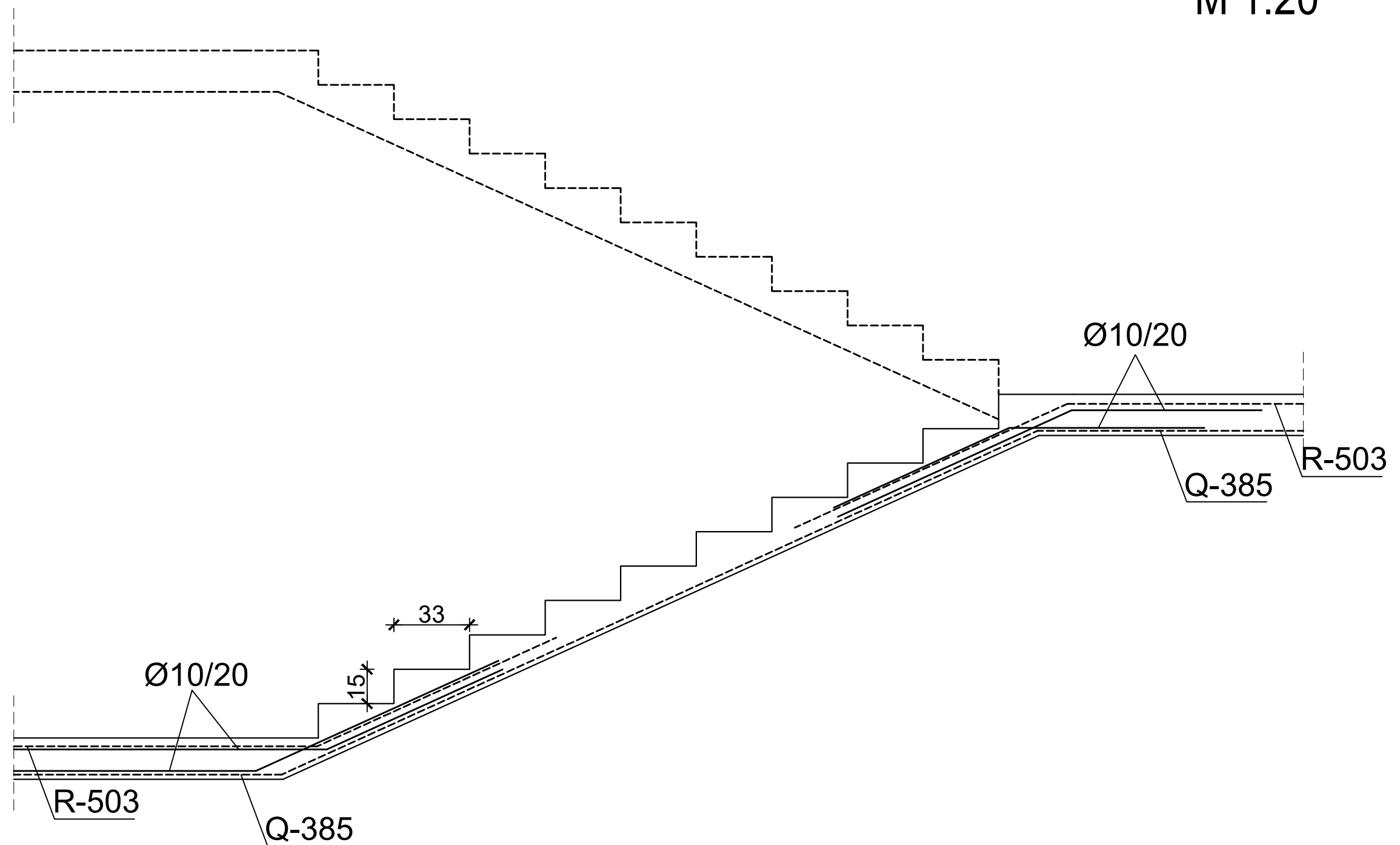

 SVEUČILIŠTE U SPLITU, FAKULTET GRAĐEVINARSTVA, ARHITEKTURE I GEODEZIJE 21000 SPLIT, MATICE HRVATSKE 15 MB 3149463; tel + 385 (0)21 303333; fax + 385 (0)21 465117	INVESTITOR / NARUČITELJ: FGAG, Matice hrvatske 15, 21000 Split	MJERILO: 1:200
	GRADEVINA: Poslovno-stambena zgrada	DATUM: rujan, 2021.
	VRSTA PROJEKTA: Projekt konstrukcije	BROJ PROJEKTA: kk-07-2021.
	RAZINA PROJEKTA: IDEJNI PROJEKT	PROJEKTANT: Luciana Deur
	SADRŽAJ: Armatura stubišta	BROJ PRILOGA: 18