

Transformacija punte Zenta

Grubišić, Hrvoje

Supplement / Prilog

Publication year / Godina izdavanja: **2015**

Permanent link / Trajna poveznica: <https://urn.nsk.hr/urn:nbn:hr:123:771122>

Rights / Prava: [In copyright](#)/[Zaštićeno autorskim pravom.](#)

Download date / Datum preuzimanja: **2024-07-11**



Repository / Repozitorij:

[FCEAG Repository - Repository of the Faculty of Civil Engineering, Architecture and Geodesy, University of Split](#)

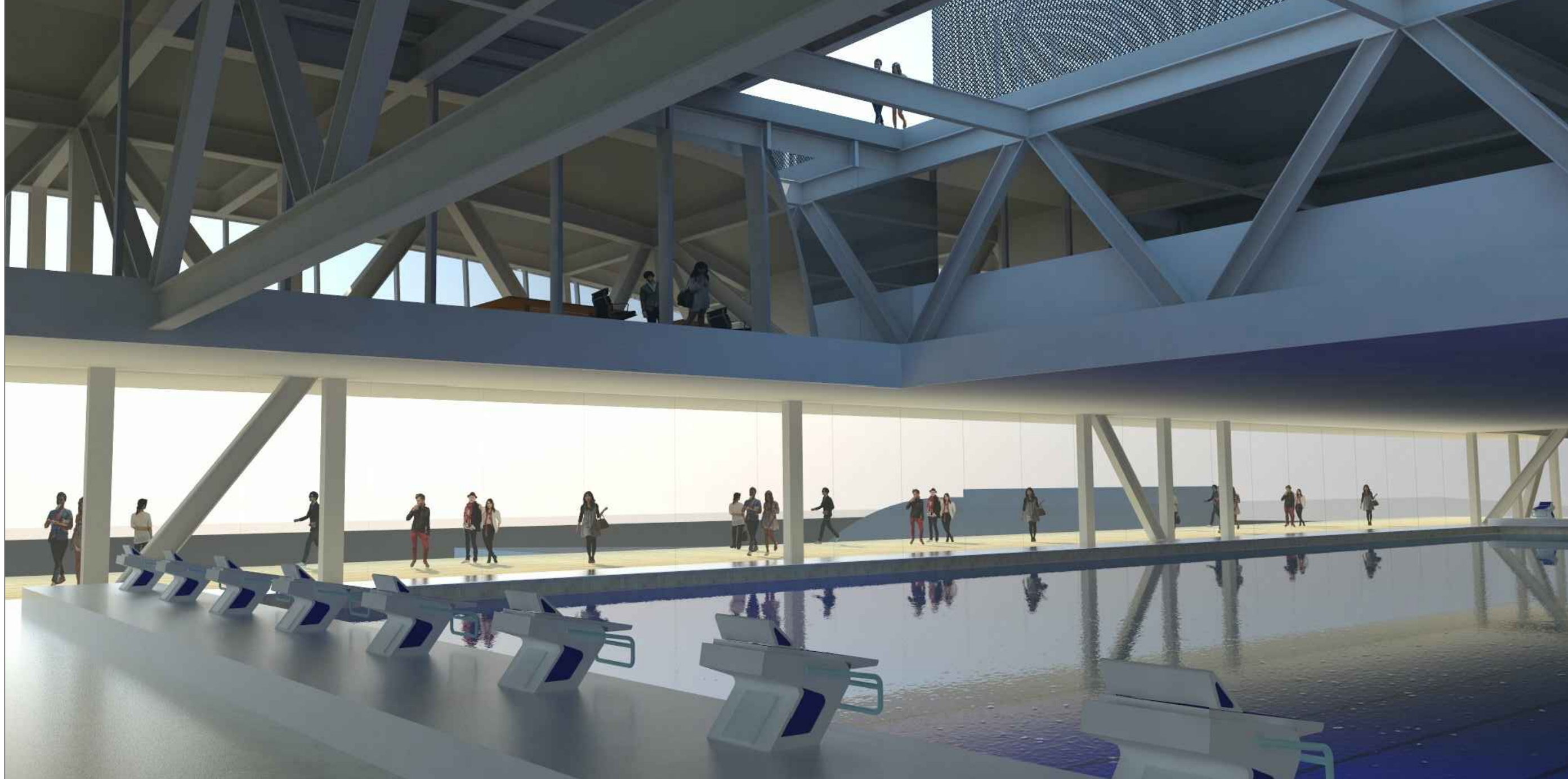

aksonometrija

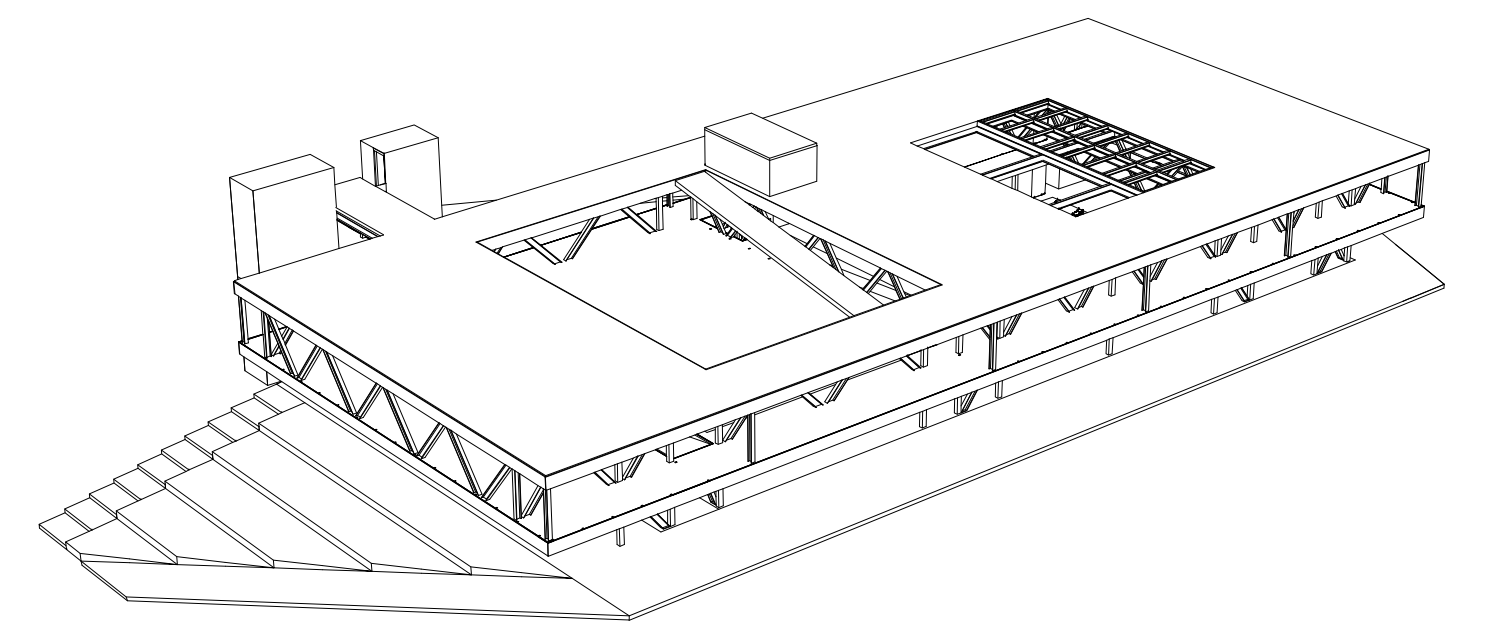

nosiva etažna konstrukcija

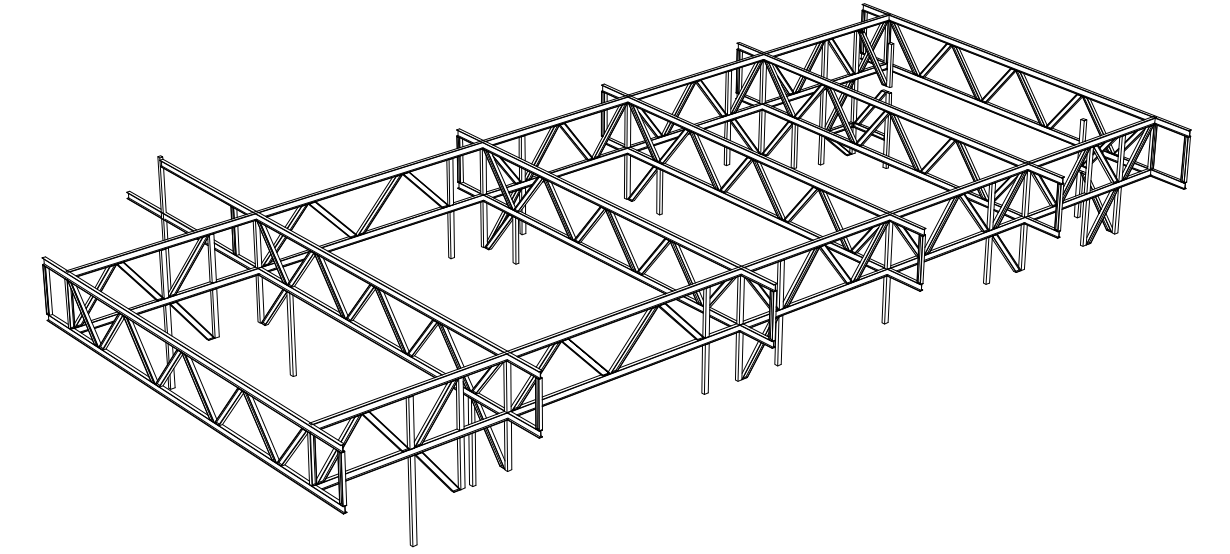

javna pješačka paluba

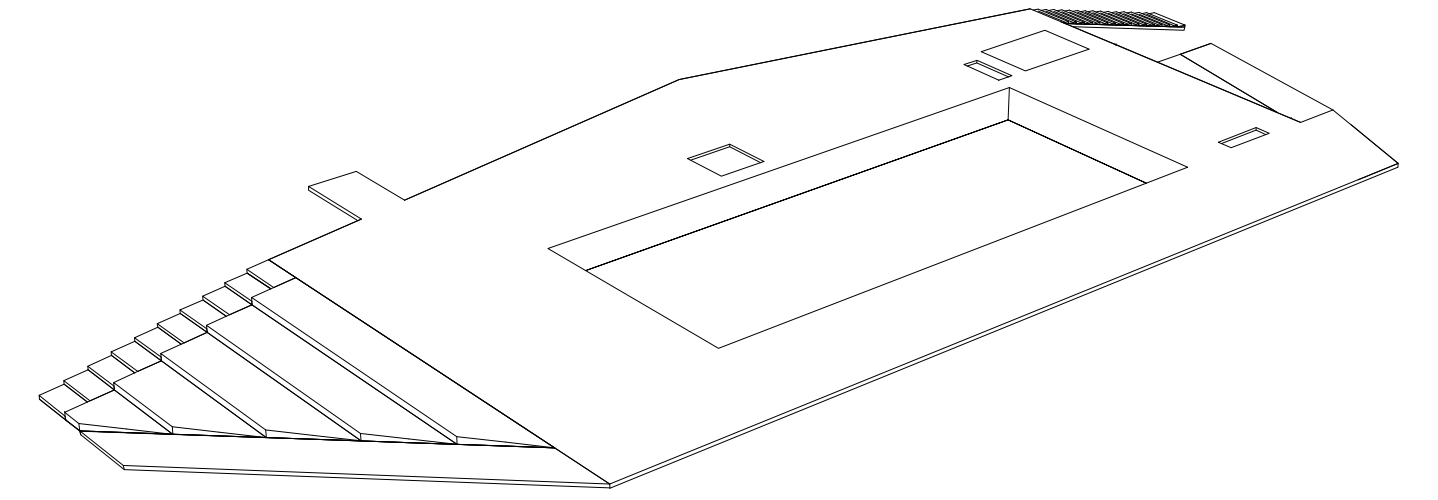

garaža i servisni sadržaj bazena

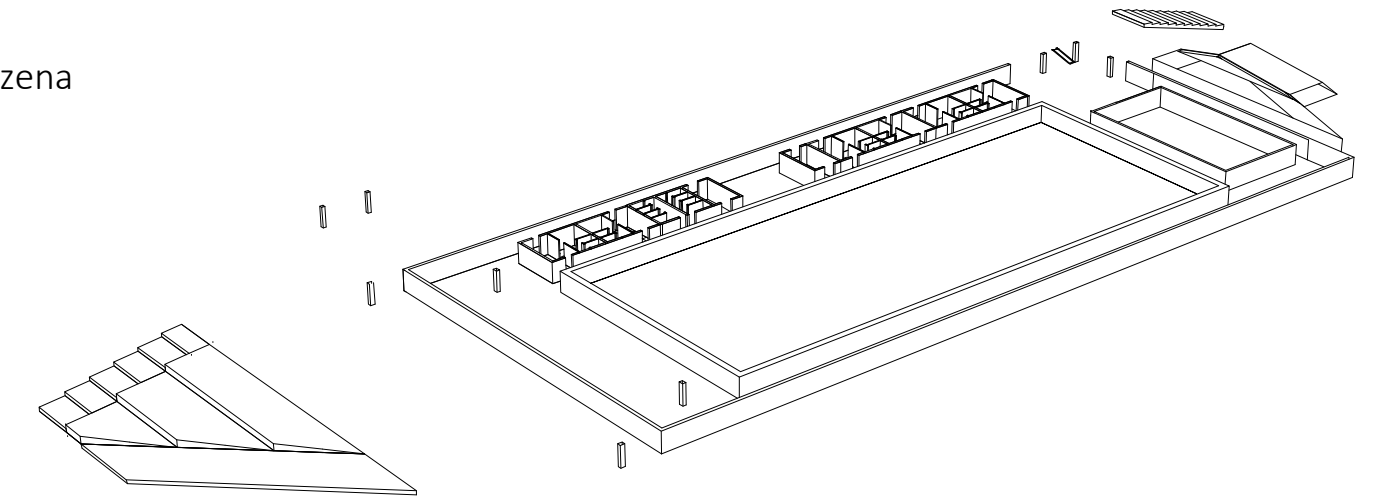

Košarka - terasa O Hara

O Hara koncert na otvorenom

O Hara caffe bar

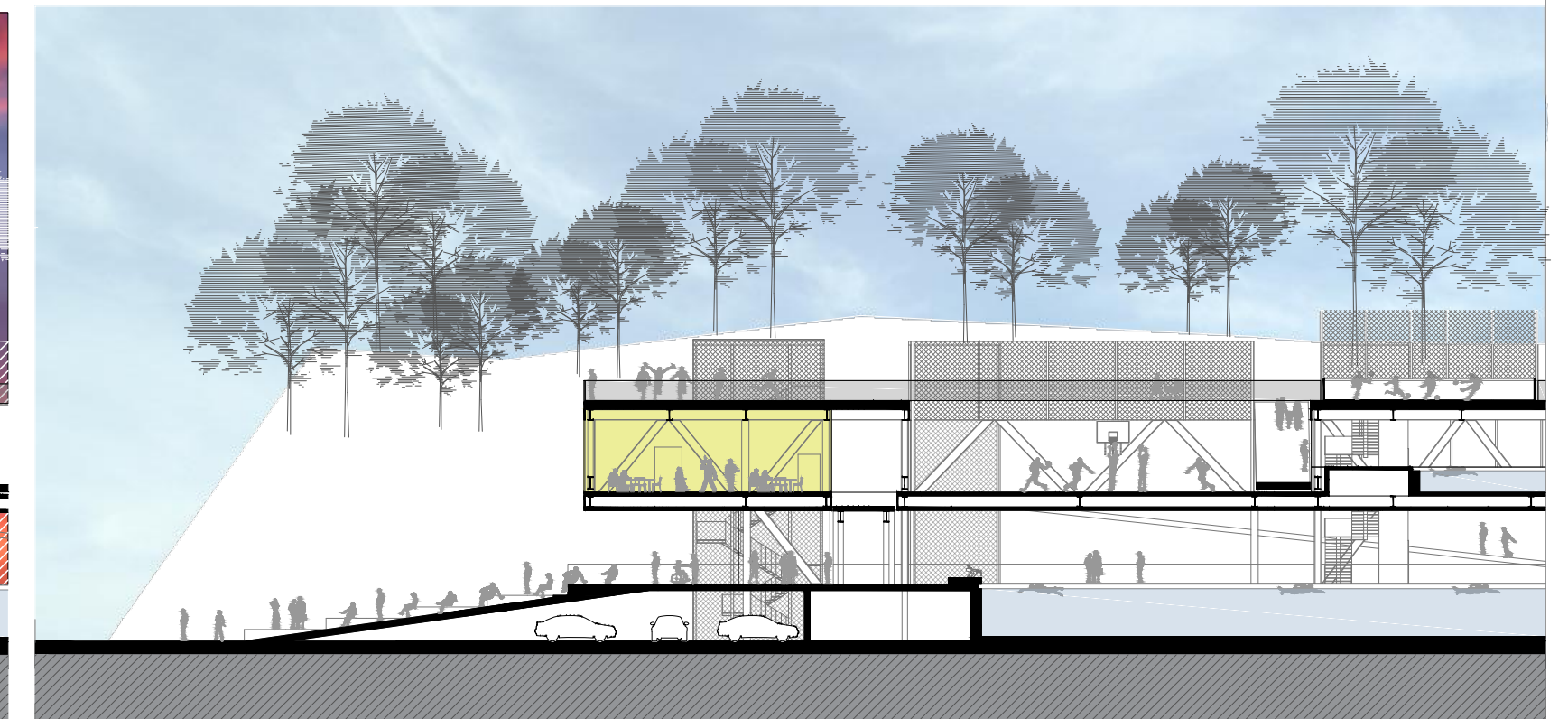
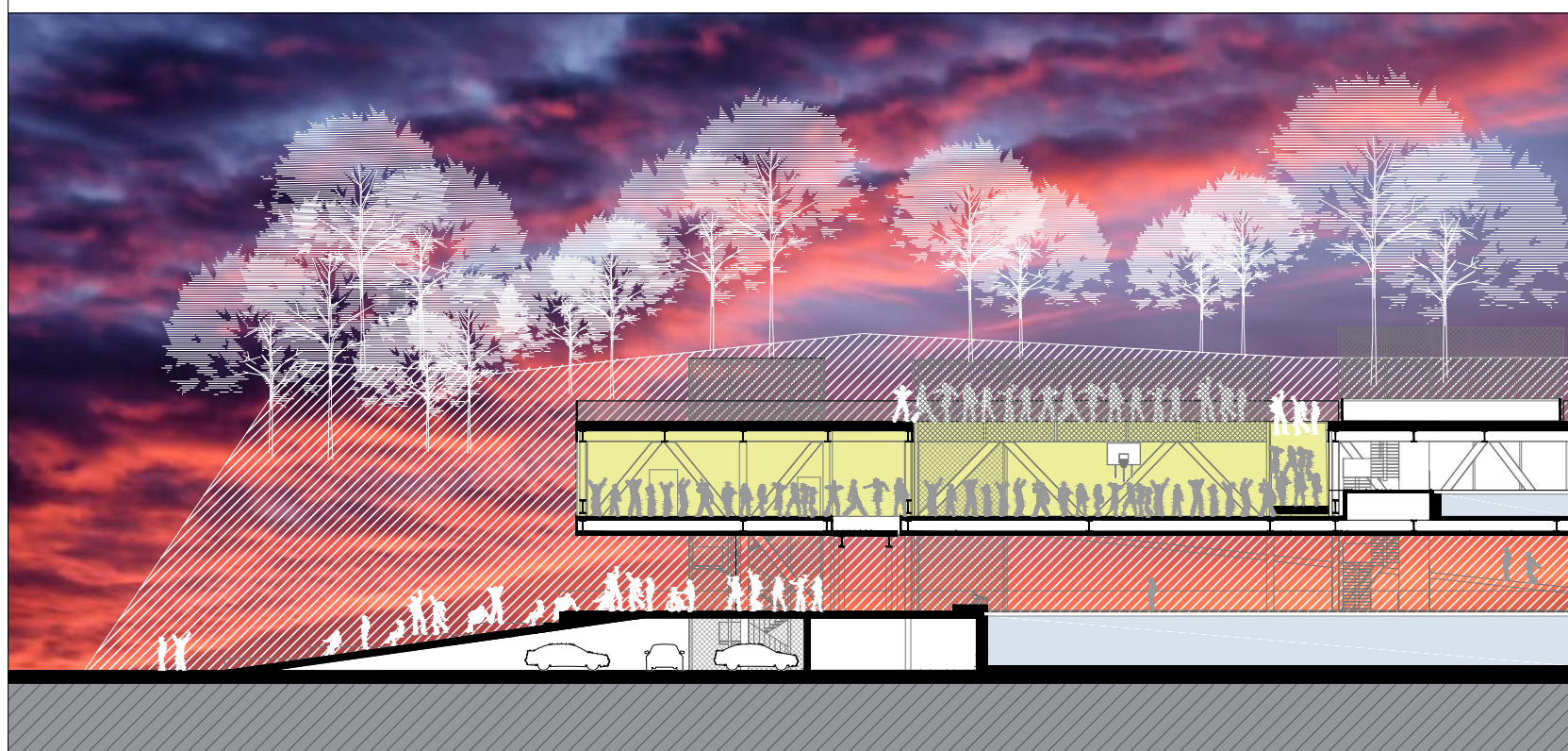

IME I PREZIME

HRVOJE GRUBIŠIĆ

NASLOV DIPLOMSKOG RADA TRANSFORMACIJA PUNTE ZENTA

AKADEMSKA GODINA

2014 / 2015

MENTOR

Red. prof. ANTE KUZMANIĆ

KOMENTOR

Doc. SNJEŽANA PEROJEVIĆ

Punta Zenta je spoj raznih načina korištenja i sadržaja pa je tim i vrlo značajna lokacija grada Splita. S obzirom na svoj smještaj i prostorne mogućnosti može udomiti veliku količinu ljudi, sadržaja i događanja. To je mjesto koje ima duboku sentimentalnu važnost za građane Splita, kako za starije tako i za mlađe generacije. Transformacija punte Zenta predstavlja transformaciju starog sadržaja u novi i konstantne transformacije novoga sadržaja tijekom dana, tjedna, mjeseca i godine.

