

Projekt konstrukcije - most preko Rječine

Vrdoljak, Stipe

Master's thesis / Diplomski rad

2024

Degree Grantor / Ustanova koja je dodijelila akademski / stručni stupanj:

University of Split, Faculty of Civil Engineering, Architecture and Geodesy / Sveučilište u Splitu, Fakultet građevinarstva, arhitekture i geodezije

Permanent link / Trajna poveznica: <https://um.nsk.hr/um:nbn:hr:123:500745>

Rights / Prava: [In copyright](#)/[Zaštićeno autorskim pravom.](#)

Download date / Datum preuzimanja: **2024-12-01**



Repository / Repozitorij:

[FCEAG Repository - Repository of the Faculty of Civil Engineering, Architecture and Geodesy, University of Split](#)



UNIVERSITY OF SPLIT



SVEUČILIŠTE U SPLITU

FAKULTET GRAĐEVINARSTVA, ARHITEKTURE I GEODEZIJE

Diplomski rad

Stipe Vrdoljak

Split, 2024.

SVEUČILIŠTE U SPLITU

FAKULTET GRAĐEVINARSTVA, ARHITEKTURE I GEODEZIJE

Stipe Vrdoljak

Projekt konstrukcije - most preko Rječine

Diplomski rad

Split, 2024.

Projekt konstrukcije - most preko Rječine

Sažetak:

Prema osnovnim projektnim podacima projekta Most preko Rječine izrađen je numerički model konstrukcije. Ukupni slobodni profil (razmak između ograda mosta) iznosi 8,50 m. Duljina mosta iznosi 31,00 m. Nosivu konstrukciju pristupnog mosta čini donji ustroj sa betonskim upornjacima te gornji ustroj koji čini rasponska konstrukcija koja se sastoji od kontinuirane armiranobetonske ploče. Usvojena visina rešetkastog nosača je $H=3,50$ m, nosač ima osam polja konstantne dužine 3,875 m. Elementi čelične konstrukcije rešetki izvode se u zavarenoj izvedbi od čelika S355. Kontinuirana armiranobetonska kolnička konstrukcija predviđena je od betona klase čvrstoće C35/45 i armaturom B500B. Nakon proračuna čelične konstrukcije u računalnom programu, izvršena je provjera na granična stanja te provjera stabilnosti. Spojevi su proračunati nakon definiranja konačnih profila. Svi proračuni su izvedeni prema HRN EN 1991, HRN EN 1992, HRN EN 1993.

Ključne riječi:

Most preko Rječine, konstrukcija, čelik, proračun

Construction project of Rječina bridge

Abstract:

According to basic design data of the project Rječina bridge a numerical model of the structure was created. The total free profile (the distance between the bridge fences) is 8.50 m. The length of the bridge is 31.00 m. The load-bearing structure of the access bridge consists of a lower structure with concrete abutments and an upper structure that consists of a span structure consisting of a continuous reinforced concrete slab. The adopted height of the lattice girder is $H=3.50$ m, the girder has eight fields of constant length of 3.875 m. The elements of the steel structure of the gratings are made of welded steel S355. The continuous reinforced concrete pavement construction is made of concrete strength class C35/45 and B500B reinforcement. After calculating the steel structure in the computer program, a limit state check and a stability check were performed. Steel connections are calculated after defining the final profiles. All calculations were performed according to HRN EN 1991, HRN EN 1992, HRN EN 1993.

Keywords:

Rječina bridge, structure, steel, calculation

SVEUČILIŠTE U SPLITU

FAKULTET GRAĐEVINARSTVA, ARHITEKTURE I GEODEZIJE

STUDIJ: DIPLOMSKI SVEUČILIŠNI STUDIJ GRAĐEVINARSTVA

KANDIDAT: Stipe Vrdoljak

MATIČNI BROJ (JMBAG): 0083221996

KATEDRA: Katedra za metalne i drvene konstrukcije

PREDMET: Metalne konstrukcije I

ZADATAK ZA DIPLOMSKI RAD

Tema: Projekt konstrukcije - Most preko Rječine

Opis zadatka: Na temelju osnovnih projektnih podataka potrebno je izraditi projekt konstrukcije - Most preko Rječine. U sklopu projekta potrebno je postaviti nosivu konstrukciju te dokazati mehaničku otpornost i stabilnost iste.

U Splitu, 15. Ožujka 2024.

Voditelj Diplomskog rada:

Prof. dr. sc. Ivica Boko

Predsjednik Povjerenstva

za završne i diplomske ispite:

izv. prof. dr. sc. Ivan Balić

S a d r Ź a j

1. TEHNIČKI OPIS	8
1.1 Opis	8
1.2 Konstrukcija mosta	10
1.3 Materijal za izradu konstrukcije	11
1.4 Radionička izrada i montaža čelične konstrukcije	11
1.5 Zaštita čelične konstrukcije od korozije	13
1.6 Razredi izloženosti za pojedine dijelove konstrukcije	14
2. NUMERIČKI MODEL KONSTRUKCIJE	15
3. ANALIZA DJELOVANJA NA NOSIVU KONSTRUKCIJU	16
3.1 Vlastita težina	16
3.2 Promjenjivo opterećenje - prometno opterećenje	16
3.3 Promjenjivo opterećenje – horizontalno pokretno opterećenje.....	17
3.4 Promjenjivo opterećenje – potresno opterećenje	17
3.5 Promjenjivo opterećenje – opterećenje vjetrom	18
3.6 Slijeganje oslonaca	21
3.7 Stalno opterećenje - opterećenje tlom	21
4. KOMBINACIJE OPTEREĆENJA	23
5. DIMENZIONIRANJE ELEMENATA KONSTRUKCIJE	24
5.1 Ulazni podaci	24
6. ANALIZA OPTEREĆENJA.....	27
6.1 Dodatno stalno opterećenje	27
6.1.1 Betonska ploča.....	27
6.1.2 Grede	29
6.2 Promjenjivo opterećenje	30
6.3 Rezultati - rezne sile	37
7. IZLAZNI PODACI	41
7.1 Dimenzioniranje gornjeg ustroja	41
7.1.1 Gornji pojas	41
7.1.2 Donji pojas	46
7.1.3 Rubne dijagonale.....	51

7.1.4 Unutarnje dijagonale	56
7.1.5 Armirano betonska ploča	61
7.1.6 Armirano betonska ploča - potrebna armatura	63
7.2 Dimenzioniranje donjeg ustroja.....	65
7.3 Provjera graničnog stanja uporabivosti (GSU).....	81
8. PRORAČUN SPOJEVA.....	82
8.1 Spoj D1 (Donji pojas - unutarnje dijagonale).....	82
8.2 Spoj D2 (Gornji pojas - unutarnje dijagonale)	88
8.3 Spoj D3 (Gornji pojas - rubne dijagonale)	91
8.4 Spoj D4 (Donji pojas - rubne dijagonale).....	96
9. PRILOZI	100
10. POPIS SLIKA.....	108
11. POPIS TABLICA.....	111
12. LITERATURA	112

1. TEHNIČKI OPIS

1.1 Opis

Projektom je predviđena izgradnja pristupnog mosta na lokaciji željezničkog mosta koji je uklonjen 2013. godine. Uklonjeni most se oslanjao na tlo preko drvenih pilota i naglavne (armirano)betonske grede. Prema podacima iz nacрта "Most preko Rječine br. II" - JŽ Direkcija Karlovac, 1955. postojeći temelji datiraju iz početka 20. st., a ispod svake naglavnice postavljeno je 54 pilota \varnothing 30 cm. Novi most nalazi se na identičnoj poziciji na kojoj je bio uklonjeni most. Predviđena širina kolnika mosta iznosi 6,0 m, a pješačke staze s obje strane širine su 1,25 m. Ukupni slobodni profil (razmak između ograda mosta) iznosi 8,5 m. Duljina mosta iznosi 31,00 m, a ukupna duljina 40,60 m. Podatak o vodostaju 100-godišnjoj velikoj vodi odgovara koti 0,95 m n.m.. Kota donjeg ruba rasponske konstrukcije predviđena je na koti 1,20 m n.m., kota gornjeg ruba rasponske konstrukcije predviđena je na koti 5,47 m n.m. Most je predviđen sa prijelaznim napravama, prijelaznom pločom, pješačkom i odbojnom ogradom. Nosivu konstrukciju pristupnog mosta čini donji ustroj sa betonskim upornjacima te gornji ustroj koji čini rasponska konstrukcija koja se sastoji od kontinuirane armiranobetonske ploče koja se oslanja na čeličnu rešetkastu konstrukciju raspona 31,0 m. Postojeća konstrukcija naglavnih greda se uklanja. Postojeći temelj se reprofilira i proširuje sa svake strane cca 120 cm. Oštećeni dijelovi se obnavljaju injektiranjem i sanacijskim mortom, a gornja površina u debljini od 30 cm se potpuno uklanja nakon čega se reparira. Na tako pripremljenu podlogu izvode se nova krila upornjaka i nadtemeljna greda završno sa ležajevima. Sukladno lokaciji odnosno maloj slobodnoj visini iznad upornjaka, most je sustav dviju bočnih rešetki povezanih poprečnim nosačima i armiranobetonskom pločom. Usvojena visina rešetkastog nosača je $H = 3,50$ m, nosač ima osam polja konstantne dužine 3,875 m, rešetke se postavljaju na osnom razmaku 9,02 m. Krajnje dijagonale rešetkaste konstrukcije su zavareni sandučasti presjeci dimenzija 400x250x16 mm, unutarnje dijagonale su zavareni 'T' profili dimenzija 400x250x16 mm, gornji pojas je zavareni sandučasti presjek dimenzija 550x450x30(16) mm, a donji pojas je zavareni sandučasti presjek dimenzija 400x500x18 mm. Spajanje štapova ispune sa pojasima vrši se preko čvornih limova i zavara. Elementi čelične konstrukcije rešetki izvode se u zavarenoj izvedbi od čelika S355. Kontinuirana armiranobetonska kolnička konstrukcija predviđena je od betona klase čvrstoće C35/45 i armaturom B500B. Armirano betonska ploča

je $d=20$ cm. Poprečni nosači su predviđeni od čelika S355. Glavni nosači se oslanjaju na upornjake preko lončastih ležajeva prema „HRN EN 1337-5:2005“. Razred izloženosti objekta je XS3 pri čemu je najmanja zahtijevana tlačna čvrstoća betona C35/45. Zbog samoga položaja mosta koji je neposredno uz more, obavezna je antikorozivna zaštita. Most je izložen djelovanju soli iz zraka i kloridima iz mora. Antikorozivna zaštita treba imati visoku trajnost zaštite sukladno HRN EN ISO 12944-1, što daje naznaku da bi se prvi veći radovi na obnavljanju zaštite trebali izvoditi nakon 15 god.

1.2 Konstrukcija mosta

Za proračun mjerodavnih sila i deformacija konstrukcije korišten je računalni program SCIA Engineer 2021,a za potrebne radioničke nacрте korišten je AutoCAD 2018.

Accurate (FEM) metoda ili metoda konačnih elemenata diskretizira promatrani prostor u određenom broju konačnih elemenata koji su mjerodavni za rješenje, što znači da metoda konačnih elemenata ne daje u potpunosti točne rezultate, ali su isti dovoljno precizni i zadovoljavajući za praktičnu upotrebu.

Za proračun spojeva korišten je računalni program IDEA StatiCa 2023 gdje se po mjerodavnim silama proračunava broj potrebnih vijaka , debljina zavara i pločice.

Proračuni su izvedeni po Eurocodu i to: Eurocode 1, Eurocode 2, Eurocode 3.

Za proračun konstrukcije bitno je reći da se izveo proračun na stalna, promjenjiva i dinamička opterećenja.

Nakon dobijenih rezultata u računalnom programu , prvobitno su se kontrolirali progibi na GSU (Granično stanje uporabljivosti) te mjerodavne sile na GSN (Granično stanje nosivosti) preko mjerodavnih kombinacija.

1.3 Materijal za izradu konstrukcije

Beton za temelje mosta je XC2, C30/37

Beton za uporanjak (greda i krila) je XS3, C35/45

Beton za monolitnu ploču mosta je XS3, C35/45

Armatura je B 500B

Čelik:

Toplovaljani presjeci, S355 J2 prema HRN EN 10025-2:2019

Tolpovaljani čelični limovi, S355 J2 prema HRN EN 10029:2010

1.4 Radionička izrada i montaža čelične konstrukcije

Radionička izrada i montaža čelične konstrukcije treba biti u skladu sa HRN EN 1090-1 i HRN EN 1090-2.

Razred posljedica	Opis	Primjeri zgrada i inženjerskih građevina
CC3	Velike posljedice gubitka ljudskih života // vrlo velike ekonomske i društvene posljedice i posljedice po okoliš	Stadioni, javne zgrade s velikim posljedicama sloma (npr. koncertna dvorana)
CC2	Srednje posljedice gubitka ljudskih života i znatne ekonomske i društvene posljedice i posljedice po okoliš	Stambene i uredske zgrade, javne zgrade sa srednjim posljedicama sloma (npr. uredska zgrada)
CC1	Male posljedice gubitka ljudskih života / male ili zanemarive ekonomske i društvene posljedice i posljedice po okoliš	Poljoprivredne zgrade u kojima obično nema ljudi (npr. skladišta), staklenici

Tablica 1. Definicija razreda posljedica

Razred pouzdanosti (RC) ili razred posljedica (CC)	Vrsta opterećenja	
	Statičko, nazovistatičko ili potresno uz DCL ^a	Zamor ^b ili potresno uz DCM ili DCH ^a
RC3 ili CC3	EXC3 ^c	EXC3 ^c
RC2 ili CC2	EXC2	EXC3
RC1 ili CC1	EXC1	EXC2

^a Razredi potresne duktilnosti definirani su u normi EN 1998-1: mala duktilnost = DCL; umjerena ili srednja duktilnost = DCM; velika duktilnost = DCH.

^b Vidjeti normu EN 1993-1-9.

^c Razred EXC4 smije se odrediti za konstrukcije s ekstremnim posljedicama konstrukcijskoga sloma.

Tablica 2. Odabir razreda izvedbe

Klasa izvođenja s obzirom na odabrane parametre se definira kao EXC3.

U skladu sa propisanom klasom izvođenja potrebno je provoditi sve radnje kod radioničke izrade i montaže čelične konstrukcije, te kontrolu izrade i montaže čelične konstrukcije.

1.5 Zaštita čelične konstrukcije od korozije

Zaštitu čelične konstrukcije od korozije treba provesti u skladu sa Tehničkim propisom za konstrukcije. Prema HRN ISO 12944-2, građevina se nalazi u sredini s atmosferskim uvjetima koji spadaju u C4 kategoriju. Propisuje se trajnost zaštite: visoka(H) 15-25 g., sukladno HRN EN ISO 12944-1.

Priprema površine na kvalitetu Sa 2 ½ prema HRN EN ISO 8501-1:2007 na automatskoj sačmarilici. Sekundarna priprema površine na gradilištu na mjestima gradilišnih zavara (prije aplikacije cjelokupnog sustava) izvodi se na kvalitetu St 3 prema ISO 8501-1:2007.

Premaze je potrebno nanositi sukladno preporuci proizvođača premaza i sukladno specifikaciji bojanja i to uvijek na isključivo čistu i suhu površinu na temperaturi minimalno 3 stupnja iznad točke rosišta.

Od velike je važnosti da se sva oštećena mjesta i nedostaci poprave bilo da se radi o većim ili manjim oštećenjima.

Prijedlog sustava:

- Temeljni premaz (primer) konstrukcije Zn cink, debljine min. 180 mikrona (NDFT)
- Završni premaz dvokomponentni fleksibilni poliuretanski premaz sa visokim udjelom suhe tvari, otpornim na udarce, debljine 60mikrona (NDFT).

Ukupna debljina suhog filma je min 240 mikrona.

1.6 Razredi izloženosti za pojedine dijelove konstrukcije

Oznaka razreda	Opis okoliša	Informativni primjeri moguće pojave razreda izloženosti
1 Nema rizika od korozije		
X0	Za beton bez armature ili ugrađenog metala; sve izloženosti osim onih u kojima postoji zamrzavanje/odmrzavanje, abrazija ili kemijska agresivnost. Za beton s armaturom ili ugrađenim metalom: vrlo suho.	Beton unutar zgrada s vrlo malom vlažnošću zraka
2 Korozija uzrokovana karbonatizacijom		
XC1	Suho ili trajno vlažno	Beton unutar zgrada s malom vlažnošću zraka Beton stalno uronjen u vodu
XC2	Vlažno, rijetko suho	Površine betona izložene dugotrajnom kontaktu s vodom Mnogi temelji
XC3	Umjerenom vlažnost	Beton unutar zgrada s umjerenom ili velikom vlažnošću zraka Vanjski beton zaštićen od kiše
XC4	Ciklički vlažno i suho	Površine betona izložene kontaktu s vodom koje ne pripadaju razredu izloženosti XC2
3 Korozija uzrokovana kloridima		
XD1	Umjerenom vlažnost	Površine betona izložene kloridima iz zraka
XD2	Vlažno, rijetko suho	Bazeni za privanje Elementi betona izloženi industrijskim vodama koje sadržavaju kloride
XD3	Ciklički vlažno i suho	Dijelovi mostova izloženi prskanju vode koja sadržava kloride Pločnici – kolničke konstrukcije Ploče javnih garaža
4 Korozija uzrokovana kloridima iz morske vode		
XS1	Izložen solima iz zraka, ali ne u izravnom dodiru s morskom vodom	Konstrukcije u blizini ili na obali
XS2	Stalno uronjeno	Dijelovi pomorskih konstrukcija
XS3	U područjima plime i oseke i prskanja vode	Dijelovi pomorskih konstrukcija
5 Korozija uzrokovana zamrzavanjem i odmrzavanjem		
XF1	Umjerenom zasićenje vodom, bez sredstva za odmrzavanje	Vertikalne površine betona izložene kiši i zamrzavanju
XF2	Umjerenom zasićenje vodom, sa sredstvom za odmrzavanje	Vertikalne površine betona cestovnih konstrukcija izložene zamrzavanju i sredstvima za odmrzavanje
XF3	Jako zasićenje vodom, bez sredstva za odmrzavanje	Horizontalne površine betona izložene kiši i zamrzavanju
XF4	Jako zasićenje vodom, sa sredstvom za odmrzavanje	Ceste i kolnici mostova izloženi sredstvima za odmrzavanje Betonske površine izložene izravnom prskanju vode koja sadržava sredstva za odmrzavanje i izložene zamrzavanju Područja plime i oseke kod pomorskih konstrukcija izloženih zamrzavanju
6 Kemijska korozija		
XA1	Slabo kemijski agresivni okoliš prema normi EN 206-1, tablica 2	Prirodno tlo i podzemna voda
XA2	Umjerenom kemijski agresivni okoliš prema normi EN 206-1, tablica 2	Prirodno tlo i podzemna voda
XA3	Jako kemijski agresivni okoliš prema normi EN 206-1, tablica 2	Prirodno tlo i podzemna voda

Tablica 3. Razredi izloženosti u odnosu na uvjete okoliša u skladu s normom

2. NUMERIČKI MODEL KONSTRUKCIJE

3D model konstrukcije je izrađen u računalnom programu Scia Engineer 2021.

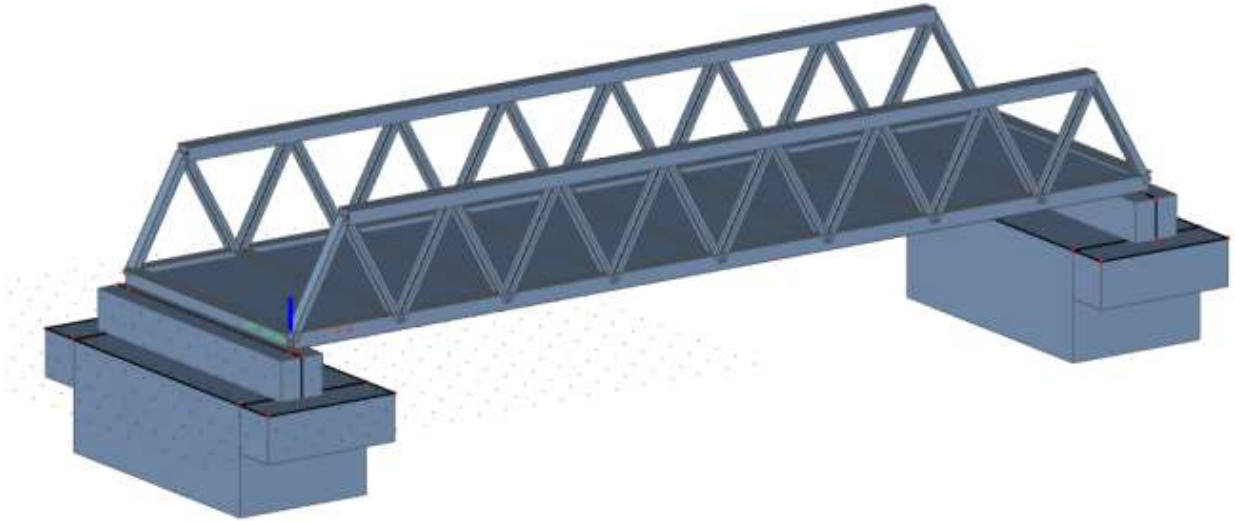

Slika 1. Izometrijski prikaz 3D modela

3. ANALIZA DJELOVANJA NA NOSIVU KONSTRUKCIJU

3.1 Vlastita težina

Vlastitu težinu nosivog dijela konstrukcije računalni program određuje na temelju dimenzija i zapreminske težine pojedinih konstrukcijskih elemenata

3.1.1 Dodatno stalno opterećenje

	G_K (kN/m ³)	G_K (kN/m ²)	G_K (kN/m')
PJEŠAČKA STAZA: površina betonske staze Abs [m ²] = 0,311	24	6	
KOLNIČKA KONSTRUKCIJA: debljina konstrukcije D _{kk} [m] = 0,08-0,14	24	2-3	

Tablica 4. Dodatno stalno opterećenje

3.2 Promjenjivo opterećenje - prometno opterećenje

Za prometno opterećenje koristi se Model 1. Glavni sustav opterećenja od koncentriranog i kontinuiranog opterećenja koje pokriva utjecaje od teških i osobnih vozila. Svaka prometna traka opterećuje se sa dva osovinska opterećenja Q_{ik} na razmaku 1,20m s razmakom kotača od 2,00m te se opterećuje i sa kontinuiranim opterećenjem q_{ik} . Površina nalijezanja kotača je 40x40cm. Preostala cijela površina opterećuje se sa kontinuiranim opterećenjem q_{ik} .

Osovinsko opterećenje za dvije trake uzeto u ovom slučaju je $Q_{1k}=300\text{kN}$ i $Q_{2k}=200\text{kN}$

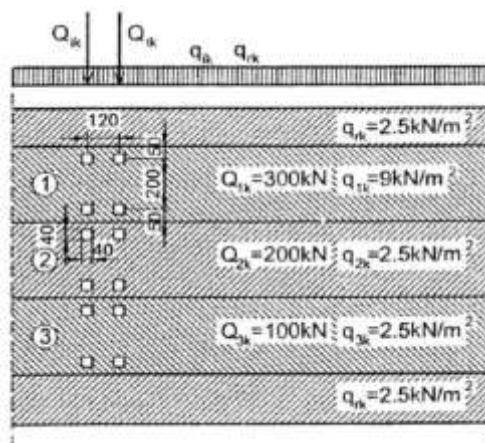

Slika 2. Prometno opterećenje

3.3 Promjenjivo opterećenje – horizontalno pokretno opterećenje

Horizontalno pokretno opterećenje predstavljaju kočne sile te sile pri pokretanju vozila. Intenzitet ovih sila se određuje kao 60% osovinskog prometnog opterećenja i kao 10 % ravnomjerno raspodjeljenog opterećenja sa gornjom i donjom granicom od 900 kN, odnosno 180 kN. Sila kočenja i sila pri pokretanju automobila jednakog su intenziteta, ali različitog smjera.

$$Q_{1k} = 0,6 * 2 * 300 + 0,1 * 1 * 9 * 31 * 3 = 443,7 \text{ kN}$$

$$180 \text{ kN} < Q_{1k} < 900 \text{ kN}$$

$$180 \text{ kN} < 443,7 < 900 \text{ kN}$$

$$Q_{1k} / (L * B) = 443,7 / (3 * 31) = 4,77 \text{ kN/m}^2$$

3.4 Promjenjivo opterećenje – potresno opterećenje

Potresno opterećenje se određuje prema HRN EN 1991-1-4:2012 i NA. S obzirom na lokaciju građevine očitava se vrijednost maksimalnog vršnog ubrzanja tla s karte potresnih područja Republike Hrvatske:

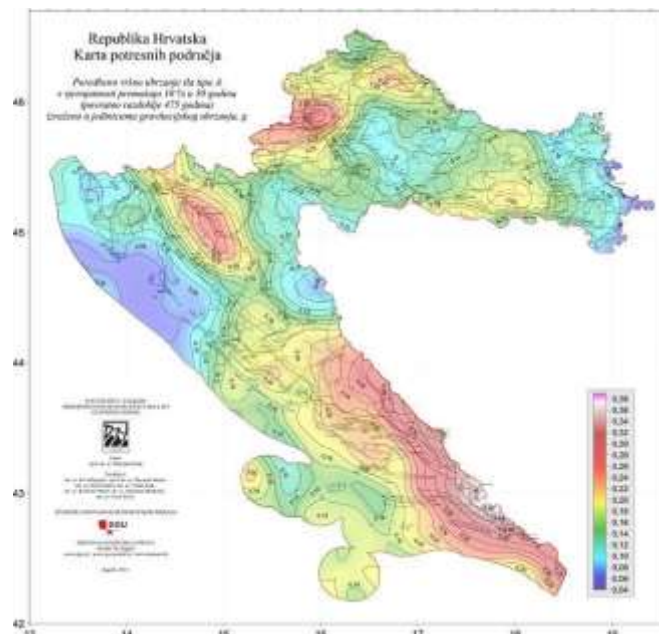

Slika 3. Zemljovid područja potresnog opterećenja



Slika 4. Vrijednosti preuzete iz baze

3.5 Promjenjivo opterećenje – opterećenje vjetrom

Mjerodavna računaska visina “Z” podvožnjaka usvaja se u iznosu od 7,00 m.

Sila vjetra koja djeluje na konstrukciju:

$$F_{w,y} = 0,5 * \rho * v^2 b * C * A_{ref,x}$$

Usvojena je vrijednost za referentnu brzinu vjetra za lokaciju na kojoj je smješten objekt sa referentne karte Republike Hrvatske:

$$V_b = 25,0 \text{ m/s (slika 5.)}$$

Gustoća zraka:

$$\rho = 1,25 \text{ kg/m}^3$$

Faktor opterećenja vjetrom:

$$C = c_e * c_{f,x} * c_d$$

Faktor izloženosti za $Z = 7,00 \text{ m}$ i I kategoriju hrapavosti terena:

Očitano iz dijagrama - $c_e = 2,50$ (slika 6.)

Dinamički koeficijent sile vjetra (samo za rasponsku konstrukciju):

Očitano iz dijagrama - $c_d = 0,97$ (slika 7.)



Slika 5. Karta osnovne brzine vjetra

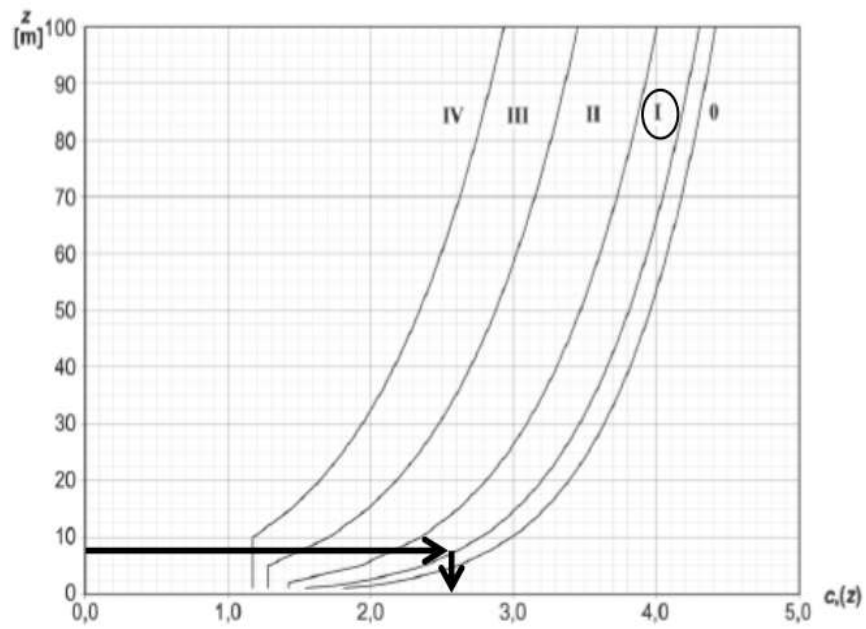

Slika 6. Dijagram - faktor izloženosti

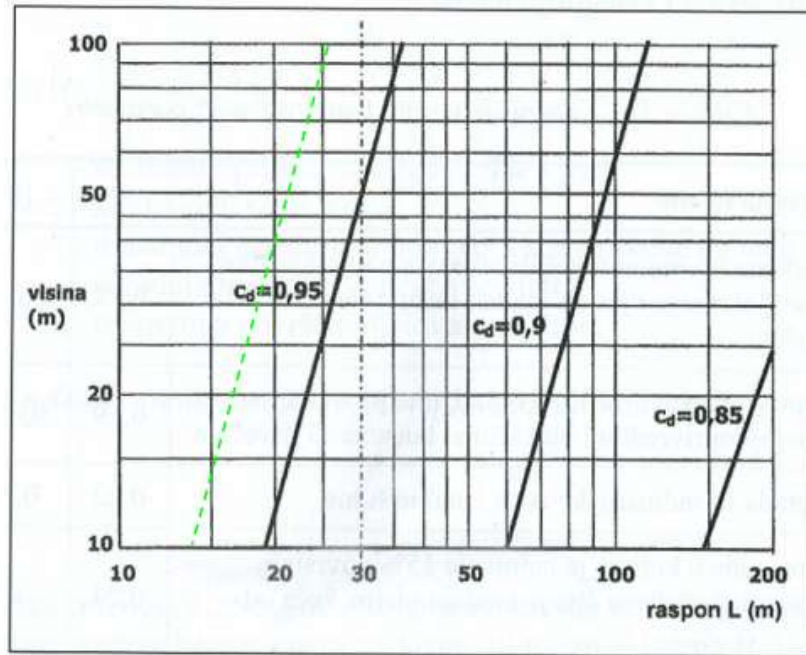

Slika 7. Dijagram - dinamički koeficijent

Iz čega slijedi da je faktor opterećenja vjetrom:

$$C = c_e * c_{f,x} * c_d$$

$$C = 2,50 * 1,70 * 0,97 = 4,12$$

3.5.1 Računska površina okomito na os mosta

Tip ograde	na jednoj strani	na obje strane
Otvorena ograda ili otvorena zaštitna ograda	$d+0.30m$	$d+0.60m$
Puna ograda ili puna zaštitna ograda	$d+d_1$	$d+2d_1$
Otvorena ograda i otvorena zaštitna ograda	$d+0.60m$	$d+1.2m$

Tablica 2. - računaska površina okomito na os mosta

Za neopterećeni most:

$$A_{ref,y} = 1.20 \text{ m}^2/\text{m}' + 2 * 2.65 \text{ m}^2/\text{m}' = 6.50 \text{ m}^2/\text{m}'$$

Za opterećeni most:

$$A_{ref,y} = 1.20 \text{ m}^2/\text{m}' + 2.65 \text{ m}^2/\text{m}' + 3.8 \text{ m}^2/\text{m}' = 7.65 \text{ m}^2/\text{m}'$$

3.5.2 Sila vjetra po metru mosta okomito na os - smjer Y

$$F_{w,x} = 0.5 * \rho * v^2 b * C * A_{ref,x}$$

Za neopterećeni most:

$$F_{w,y} = 0.5 * 1.25 \text{kg/m}^3 * (25.0 \text{m/s})^2 * 4.12 * 7.65 \text{m}^2 = 12312 \text{N/m}' = 12.3 \text{kN/m}'$$

Za opterećeni most:

$$F_{w,y} = 0.5 * 1.25 \text{kg/m}^3 * (25.0 \text{m/s})^2 * 4.12 * 6.50 \text{m}^2 = 10461 \text{N/m}' = 10.5 \text{kN/m}'$$

3.6 Slijeganje oslonaca

Slijeganje oslonaca ne uzrokuje dodatna naprezanja u konstrukcijskim elementima zbog rubnih uvjeta koji dozvoljavaju uzdužni pomak i rotaciju gornjeg ustroja.

3.7 Stalno opterećenje - opterećenje tlom

3.7.1 Najveći vertikalni pritisak tla na temelje

$$H_{\max} = 2,30 \text{m}$$

$$q = h_{\max} * \gamma = 2,30 * 20 = 46 \text{ kN/m}^2$$

Horizontalni pritisak tla na konstrukciju uvodi se kao linearno promjenjivo površinsko opterećenje.

$$\varphi_k = 39^\circ, \gamma = 20 \text{ kN/m}^3$$

$$\varphi_d = \arctg(\text{tg}(\varphi_k)/1,25)^\circ = 32,9^\circ$$

3.7.2 Najveći vertikalni pritisak tla na temelje

$$k_0 = 1 - \sin \varphi = 0,45$$

Na vrhu zida: $h_0 = 0 \text{m}$

$$p_1 = k_0 * h_1 * \gamma = 0,45 * 0,0 * 20 = 0 \text{ kN/m}^2$$

Na dnu zida: $h_{\max} = 2,30\text{m}$

$$p_2 = k_0 * h_2 * \gamma = 0,45 * 2,30 * 20 = 20,7 \text{ kN/m}^2$$

Na zid djeluje horizontalna komponenta pritiska od vozila iza upornjaka. Razmatrana su sva tri slučaja, gdje se glavno vozilo nalazi na početku, u sredini i na kraju zida.

3.7.3 Horizontalni pritisak od osovinskog opterećenja na vrhu i dnu zida upornjaka

$$Q_{1k} = 300 \text{ kN}$$

$$p_{h=0, (Q_{1k})} = (1 - \sin\phi) * 2 * 300 / (5,0 * 3,0) = 0,45 * 40 = 18,0 \text{ kN/m}^2$$

$$p_{h=2,30, (Q_{1k})} = (1 - \sin\phi) * 2 * 300 / ((3,0 + 2,30 * \text{tg}(30^\circ)) * (5,0 + 2 * 2,30 * \text{tg}(30^\circ))) = 8,15 \text{ kN/m}^2$$

$$Q_{2k} = 200 \text{ kN}$$

$$p_{h=0, (Q_{2k})} = (1 - \sin\phi) * 2 * 200 / (5,0 * 3,0) = 0,45 * 40 = 12,0 \text{ kN/m}^2$$

$$p_{h=2,30, (Q_{2k})} = (1 - \sin\phi) * 2 * 200 / ((3,0 + 2,30 * \text{tg}(30^\circ)) * (5,0 + 2 * 2,30 * \text{tg}(30^\circ))) = 5,43 \text{ kN/m}^2$$

3.7.4 Horizontalni pritisak od kontinuiranog opterećenja prometa na vrhu i dnu zida upornjaka

$$q_1 = 9,0 \text{ kN/m}^2$$

$$p_{h=0, (q_{1k})} = (1 - \sin\phi) * 9 = 0,45 * 9 = 4,05 \text{ kN/m}^2$$

$$p_{h=2,30, (q_{1k})} = (1 - \sin\phi) * 9 * 5 * 3 / ((3,0 + 2,30 * \text{tg}(30^\circ)) * (5,0 + 2 * 2,30 * \text{tg}(30^\circ))) = 1,83 \text{ kN/m}^2$$

$$q_2 = 2,5 \text{ kN/m}^2$$

$$p_{h=0, (q_{2k})} = (1 - \sin\phi) * 9 = 0,45 * 2,5 = 1,13 \text{ kN/m}^2$$

$$p_{h=2,30, (q_{2k})} = (1 - \sin\phi) * 2,5 * 5 * 3 / ((3,0 + 2,30 * \text{tg}(30^\circ)) * (5,0 + 2 * 2,30 * \text{tg}(30^\circ))) = 0,51 \text{ kN/m}^2$$

4. KOMBINACIJE OPTEREĆENJA

Navedeni su parcijalni koeficijenti sigurnosti za djelovanja i koeficijenti kombinacije

Djelovanje	Tip	Parcijalni koeficijenti sigurnosti		Koeficijenti kombinacije			
		Nepovoljna $\gamma_{1,isp}$	Povoljna $\gamma_{1,inf}$	Rijetka ψ_0	Učestala ψ_1	Nazovistalna ψ_2	Neučestala ψ_3
Vlastita težina	G_1	1.35	1.00	1.00	1.00	1.00	0
Dodatno stalno	G_2	1.35	1.00	1.00	1.00	1.00	0
Puzanje +Skupljanje	C_s	1.00	1.00	1.00	1.00	1.00	0
Prometno osovinsko opterećenje	Q_{osov}	1.50	0	0.75	0.75	0.20	0.80
Prometno kontinuirano opterećenje	Q_{kont}	1.50	0	0.40	0.40	0.20	0.80
Kočna sila	Q_1	1.50	0	0.40	0.40	0.20	0.80
Vjetar poprečno	F_{vkt}	1.50	0	0.30	0.50	0.00	0.60
Temperatura	T	1.50	0	0.00	0.60	0.50	0.60
Potres	A_E	1.00	0	0	0	0	0

Tablica 3. - parcijalni koeficijenti sigurnosti i koeficijenti kombinacije

Name	Description
	Spec
LC1	Self weight
LC2	dG_ploca
LC3	dG_grede
LC4	Q1_ploca_sve_sredina
LC5	Q2_ploca_sve_rub
LC6	Q_grede_povrsinsko
LC7	Q1_grede_konc_sredina
LC8	Q2_grede_konc_rub
LC9	Q_pjesaci_5kN
LC10	T_jedn_grijanje
LC11	T_jedn_hladjenje
LC12	T_nejedn_+ gore
LC13	T_nejedn_+ dole
LC14	Q_kocenje
LC15	skupljanje i puzanje
LC16	vjetar za neoptereceni
LC17	vjetar za optereceni
LC18	EQ_X
LC19	EQ_Y
LC20	EQ_Z

Slika 8. Slučajevi opterećenja nanošeni u software-u SCIA Engineer 2021

5. DIMENZIONIRANJE ELEMENATA KONSTRUKCIJE

5.1 Ulazni podaci

poprečni_rubni II500		
Type	Box fl	
Detailed	500; 28; 444; 15; 220	
Item material	S 355	
Fabrication	rolled	
Flexural buckling y-y, Flexural buckling z-z	b	b
A [m ²]	4,0876e-02	
A _v [m ²], A _z [m ²]	2,3448e-02	1,4718e-02
I _y [m ⁴], I _z [m ⁴]	1,7728e-03	7,6057e-04
W _{el,y} [m ³], W _{el,z} [m ³]	7,0914e-03	3,0423e-03
W _{pl,y} [m ³], W _{pl,z} [m ³]	8,0372e-03	5,0097e-03
I _w [m ⁶], I _t [m ⁴]	1,8840e-05	6,0695e-04
d _y [mm], d _z [mm]	0	0
c _{y,ucs} [mm], c _{z,ucs} [mm]	250	250
α [deg]	0,00	
M _{pl,y,+} [Nm], M _{pl,y,-} [Nm]	2853218,78	2853218,78
M _{pl,z,+} [Nm], M _{pl,z,-} [Nm]	1778447,40	1778447,40
A _L [m ² /m], A _D [m ² /m]	2,5020e+00	3,8300e+00

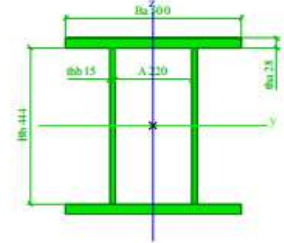

Slika 9. Poprečni presjek rubnog elementa

poprečni_sredina H500		
Type	Iw	
Detailed	500; 18; 500; 30; 440; 0	
Item material	S 355	
Fabrication	rolled	
Flexural buckling y-y, Flexural buckling z-z	b	c
A [m ²]	3,7920e-02	
A _v [m ²], A _z [m ²]	2,7146e-02	9,2337e-03
I _y [m ⁴], I _z [m ⁴]	1,7868e-03	6,2521e-04
W _{el,y} [m ³], W _{el,z} [m ³]	7,1471e-03	2,5009e-03
W _{pl,y} [m ³], W _{pl,z} [m ³]	7,9212e-03	3,7856e-03
I _w [m ⁶], I _t [m ⁴]	3,4516e-05	9,9137e-06
d _y [mm], d _z [mm]	0	0
c _{y,ucs} [mm], c _{z,ucs} [mm]	250	250
α [deg]	0,00	
M _{pl,y,+} [Nm], M _{pl,y,-} [Nm]	2812026,00	2812026,00
M _{pl,z,+} [Nm], M _{pl,z,-} [Nm]	1343902,20	1343902,20
A _L [m ² /m], A _D [m ² /m]	2,9640e+00	2,9640e+00

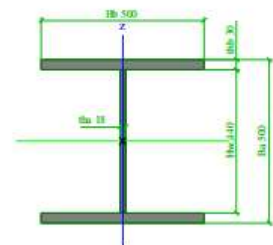

Slika 10. Poprečni presjek središnjeg elementa

dijagonale_rubne		
Type	Box web	
Detailed	250; 16; 384; 16; 218; 16; 0	
Item material	S 355	
Fabrication	welded	
Flexural buckling y-y, Flexural buckling z-z	b	b
A [m ²]	1,9776e-02	
A _y [m ²], A _z [m ²]	7,9996e-03	1,2376e-02
I _y [m ⁴], I _z [m ⁴]	4,2798e-04	2,0312e-04
W _{el,y} [m ³], W _{el,z} [m ³]	2,1399e-03	1,6250e-03
W _{pl,y} [m ³], W _{pl,z} [m ³]	2,6194e-03	1,8778e-03
I _w [m ⁶], I _t [m ⁴]	2,1230e-07	4,1981e-04
d _y [mm], d _z [mm]	0	0
C _{y,ucs} [mm], C _{z,ucs} [mm]	125	200
α [deg]	0,00	
M _{pl,y,+} [Nm], M _{pl,y,-} [Nm]	929884,16	929884,16
M _{pl,z,+} [Nm], M _{pl,z,-} [Nm]	666616,16	666616,16
A _L [m ² /m], A _D [m ² /m]	1,3000e+00	2,4720e+00

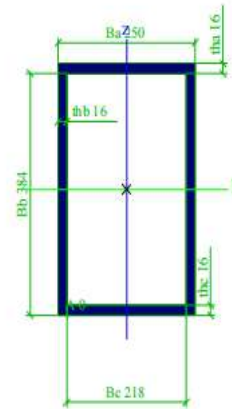

Slika 11. Poprečni presjek rubne dijagonale

dijagonale_sredina I432		
Type	Iw	
Detailed	400; 12; 250; 16; 368; 0	
Item material	S 355	
Fabrication	welded	
Flexural buckling y-y, Flexural buckling z-z	b	c
A [m ²]	1,2416e-02	
A _y [m ²], A _z [m ²]	7,3088e-03	4,8267e-03
I _y [m ⁴], I _z [m ⁴]	3,4492e-04	4,1720e-05
W _{el,y} [m ³], W _{el,z} [m ³]	1,7246e-03	3,3376e-04
W _{pl,y} [m ³], W _{pl,z} [m ³]	1,9423e-03	5,1325e-04
I _w [m ⁶], I _t [m ⁴]	1,5360e-06	9,0385e-07
d _y [mm], d _z [mm]	0	0
C _{y,ucs} [mm], C _{z,ucs} [mm]	125	200
α [deg]	0,00	
M _{pl,y,+} [Nm], M _{pl,y,-} [Nm]	689506,56	689506,56
M _{pl,z,+} [Nm], M _{pl,z,-} [Nm]	182203,04	182203,04
A _L [m ² /m], A _D [m ² /m]	1,7760e+00	1,7760e+00

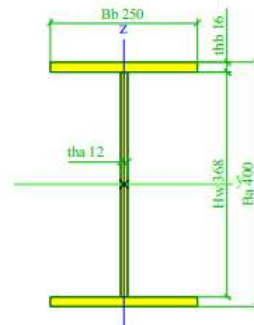

Slika 12. Poprečni presjek središnje dijagonale

gornji pojas		
Type	Box web	
Detailed	550; 16; 434; 30; 490; 30; 0	
Item material	S 355	
Fabrication	welded	
Flexural buckling y-y, Flexural buckling z-z	b	b
A [m ²]	4,9540e-02	
A _y [m ²], A _z [m ²]	2,5040e-02	2,6549e-02
I _y [m ⁴], I _z [m ⁴]	1,4356e-03	2,2782e-03
W _{el,y} [m ³], W _{el,z} [m ³]	5,6749e-03	8,2844e-03
W _{pl,y} [m ³], W _{pl,z} [m ³]	7,6297e-03	9,7812e-03
I _w [m ⁶], I _t [m ⁴]	4,0744e-06	2,5320e-03
d _y [mm], d _z [mm]	0	-45
C _{y,ucs} [mm], C _{z,ucs} [mm]	275	197
α [deg]	0,00	
M _{pl,y,+} [Nm], M _{pl,y,-} [Nm]	2708542,91	2708542,91
M _{pl,z,+} [Nm], M _{pl,z,-} [Nm]	3472308,25	3472308,25
A _L [m ² /m], A _D [m ² /m]	2,0000e+00	3,7880e+00

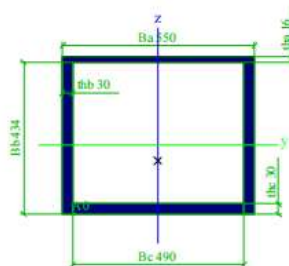

Slika 13. Poprečni presjek gornjeg pojasa

gornji pojas		
Type	Box web	
Detailed	550; 16; 434; 30; 490; 30; 0	
Item material	S 355	
Fabrication	welded	
Flexural buckling y-y, Flexural buckling z-z	b	b
A [m ²]	4,9540e-02	
A _y [m ²], A _z [m ²]	2,5040e-02	2,6549e-02
I _y [m ⁴], I _z [m ⁴]	1,4356e-03	2,2782e-03
W _{el,y} [m ³], W _{el,z} [m ³]	5,6749e-03	8,2844e-03
W _{pl,y} [m ³], W _{pl,z} [m ³]	7,6297e-03	9,7812e-03
I _w [m ⁶], I _t [m ⁴]	4,0744e-06	2,5320e-03
d _y [mm], d _z [mm]	0	-45
C _{y,UCS} [mm], C _{z,UCS} [mm]	275	197
α [deg]	0,00	
M _{pl,y,+} [Nm], M _{pl,y,-} [Nm]	2708542,91	2708542,91
M _{pl,z,+} [Nm], M _{pl,z,-} [Nm]	3472308,25	3472308,25
A _L [m ² /m], A _D [m ² /m]	2,0000e+00	3,7880e+00

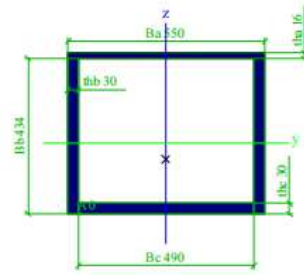

Slika 14. Poprečni presjek donjeg pojasa

6. ANALIZA OPTEREĆENJA

6.1 Dodatno stalno opterećenje

6.1.1 Betonska ploča

Name	Description	Action type	Load group
	Spec	Load type	
LC2	dG_ploca	Permanent	LG1
		Standard	

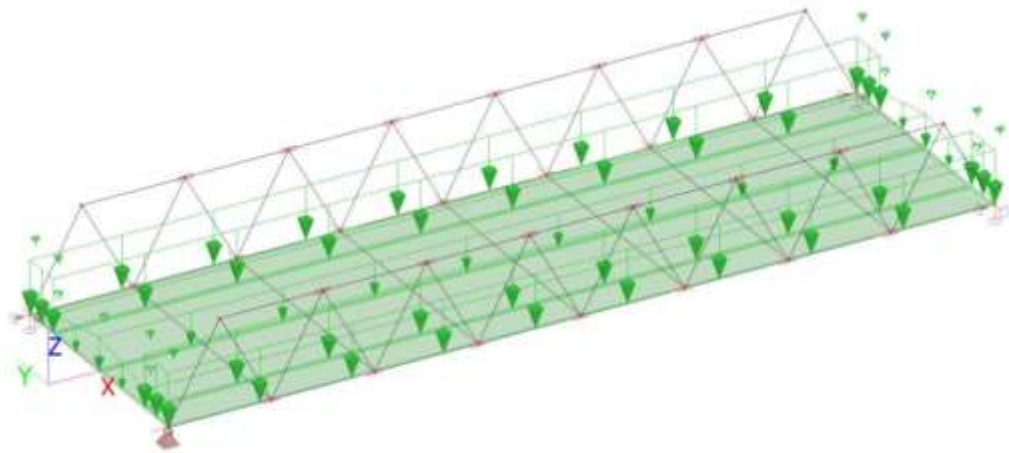

Slika 15. Dodatno stalno opterećenje - betonska ploča

Name	Description	Action type	Load group	Duration	Master load case
	Spec	Load type			
LC4	Q1_ploca_sve_sredina Standard	Variable Static	Construction	Short	None

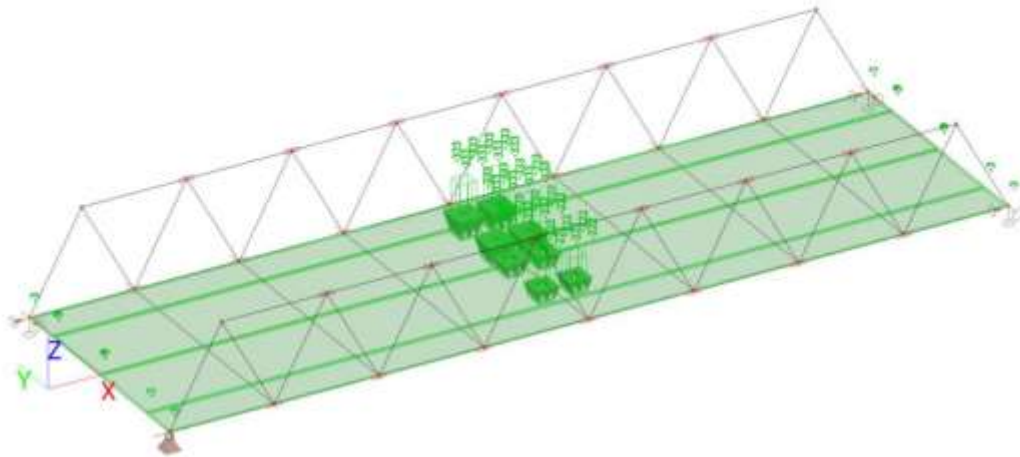

Slika 16. Dodatno stalno opterećenje - djelovanje ploče koncentrirano u sredini

Name	Description	Action type	Load group	Duration	Master load case
	Spec	Load type			
LC5	Q2_ploca_sve_rub Standard	Variable Static	Construction	Short	None

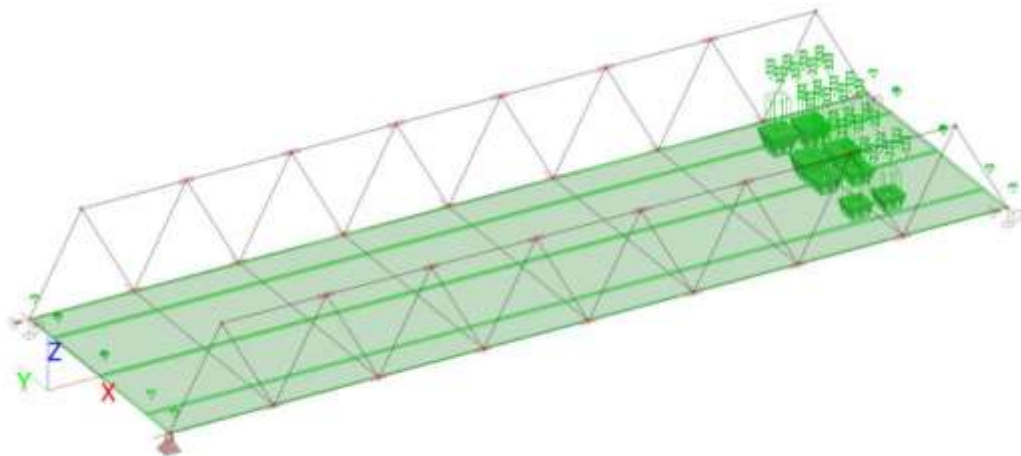

Slika 17. Dodatno stalno opterećenje - djelovanje ploče koncentrirano na rubu

6.1.2 Grede

Name	Description	Action type	Load group	Duration	Master load case
	Spec	Load type			
LC3	dG_grede	Variable	Construction	Short	None
	Standard	Static			

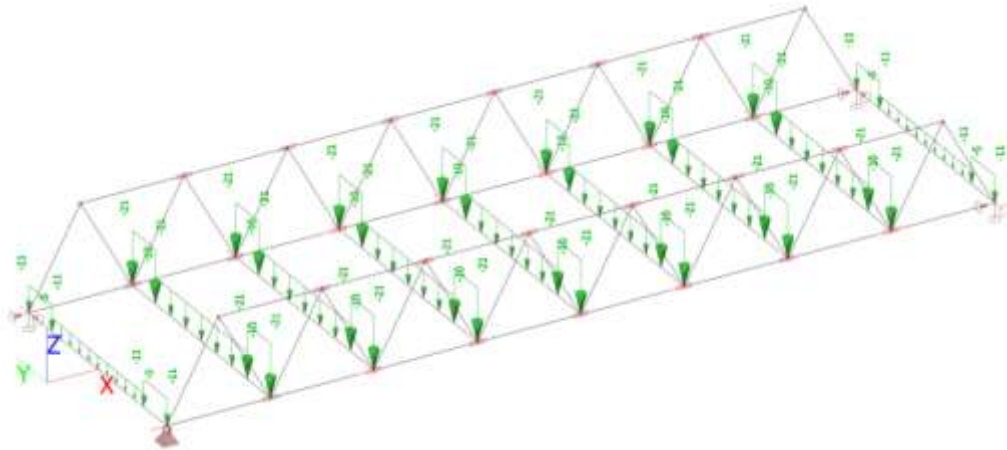

Slika 18. Dodatno stalno opterećenje - grede

Name	Description	Action type	Load group	Duration	Master load case
	Spec	Load type			
LC7	Q1_grede_konc_sredina	Variable	Construction	Short	None
	Standard	Static			

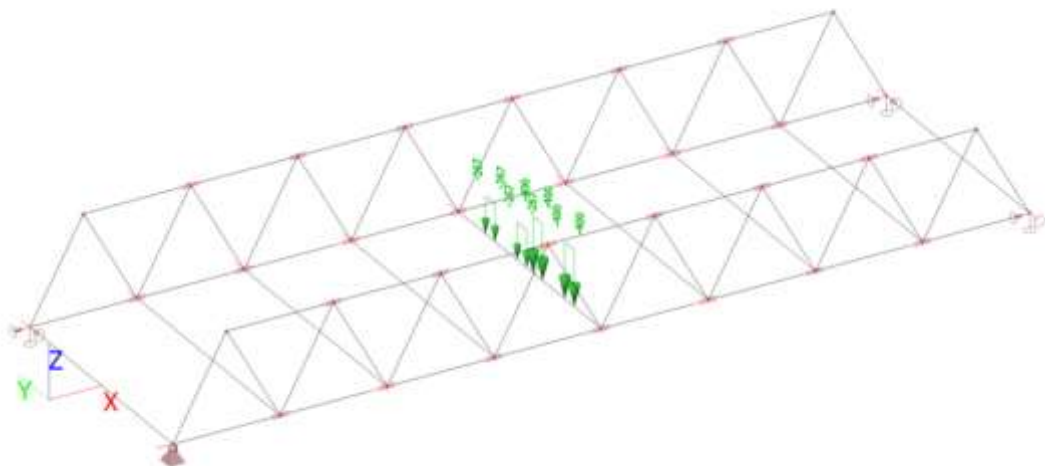

Slika 19. Dodatno stalno opterećenje - djelovanje greda koncentrirano u sredini

Name	Description	Action type	Load group	Duration	Master load case
	Spec	Load type			
LC8	Q2_grede_konc_rub	Variable	Construction	Short	None
	Standard	Static			

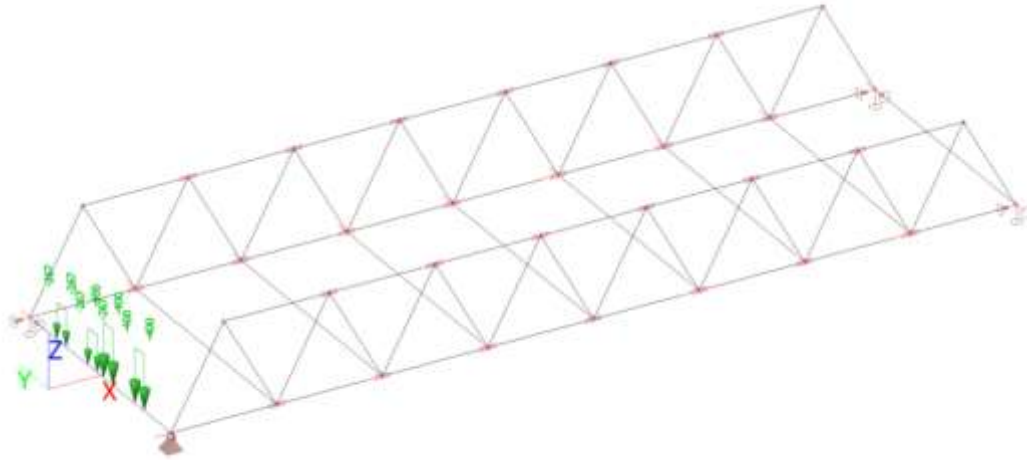

Slika 20. Dodatno stalno opterećenje - djelovanje greda koncentrirano na rubu

6.2 Promjenjivo opterećenje

6.2.1 Pješaci

Name	Description	Action type	Load group	Duration	Master load case
	Spec	Load type			
LC9	Q_pjesaci_5kN	Variable	Construction	Short	None
	Standard	Static			

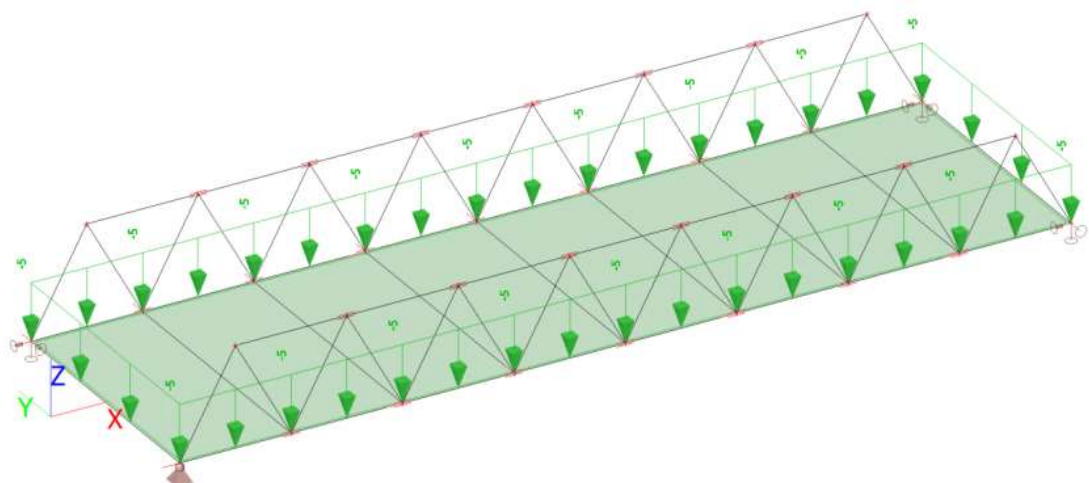

Slika 21. Promjenjivo opterećenje - prelazak pješaka preko mosta

6.2.2 Temperaturno opterećenje

Name	Description	Action type	Load group	Master load case
	Spec	Load type		
LC10	T_jedn_grijanje Temperature	Variable Static	Construction	None

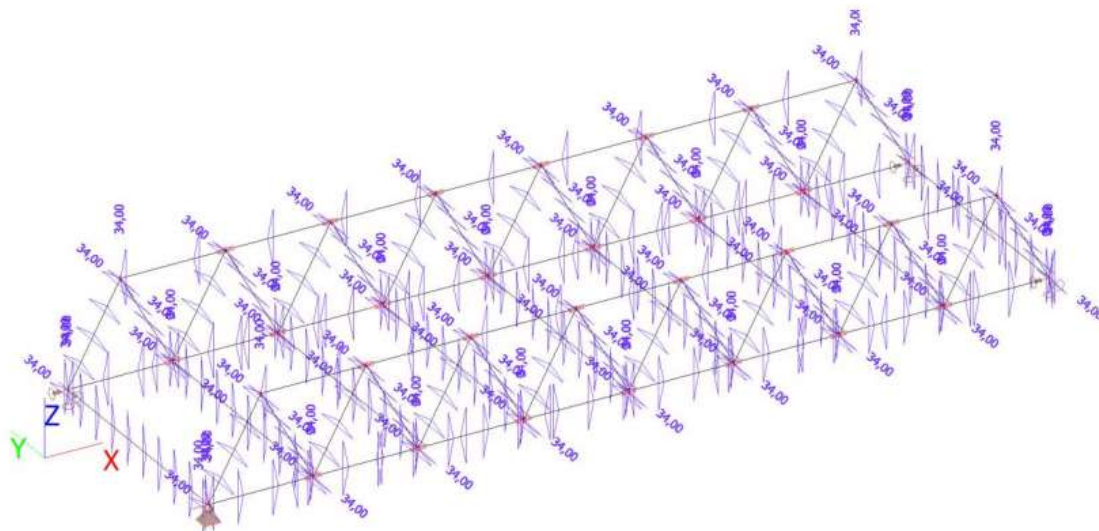

Slika 22. Promjenjivo opterećenje - djelovanje temperature kod jednolikog zagrijavanja

Name	Description	Action type	Load group	Master load case
	Spec	Load type		
LC11	T_jedn_hladjenje Temperature	Variable Static	Construction	None

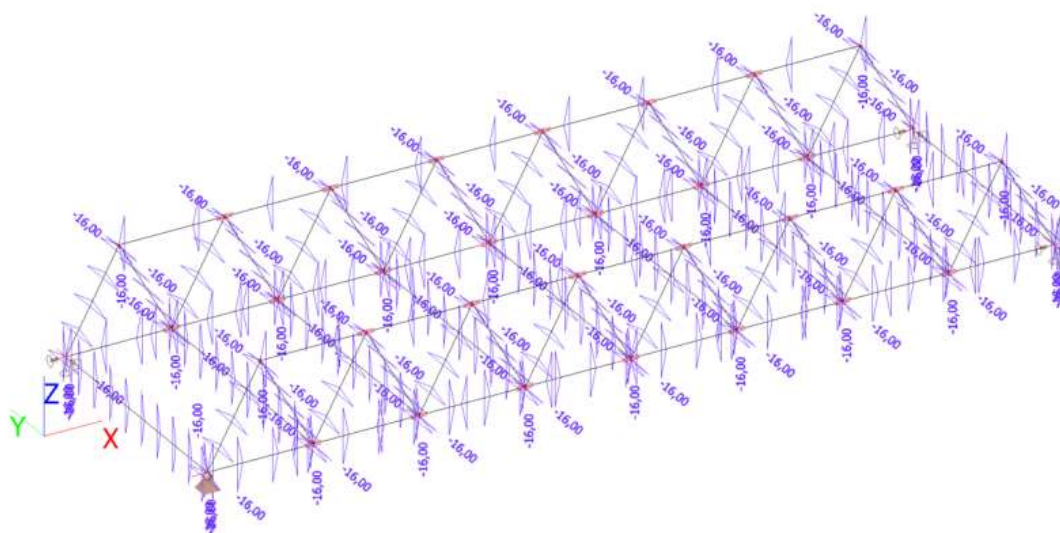

Slika 23. Promjenjivo opterećenje - djelovanje temperature kod jednolikog hlađenja

6.2.3 Kočna sila

Name	Description	Action type	Load group	Duration	Master load case
	Spec	Load type			
LC14	Q_kocenje Standard	Variable Static	Construction	Short	None

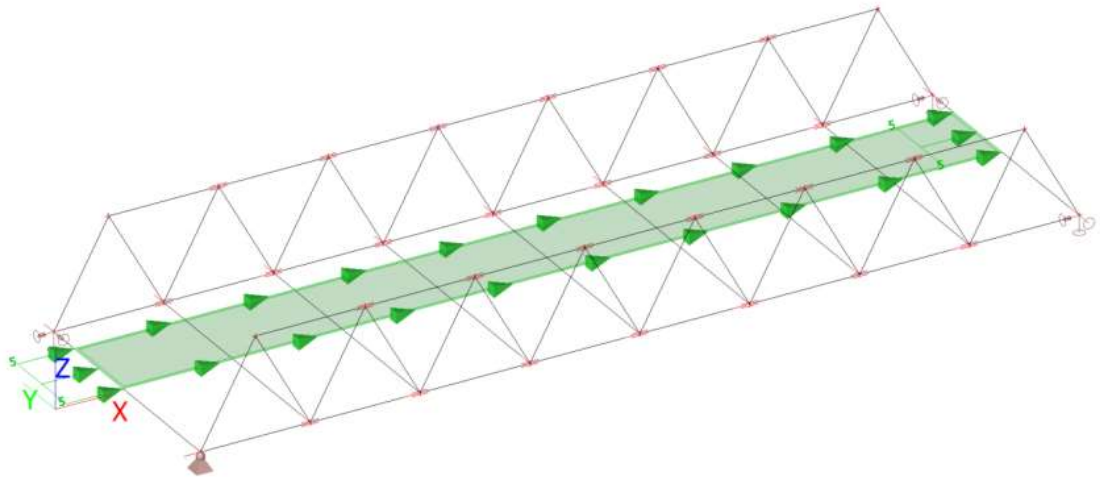

Slika 24. Promjenjivo opterećenje - djelovanje kočne sile

6.2.4 Skupljanje i puzanje materijala

Name	Description	Action type	Load group	Master load case
	Spec	Load type		
LC15	skupljanje i puzanje Temperature	Variable Static	Construction	None

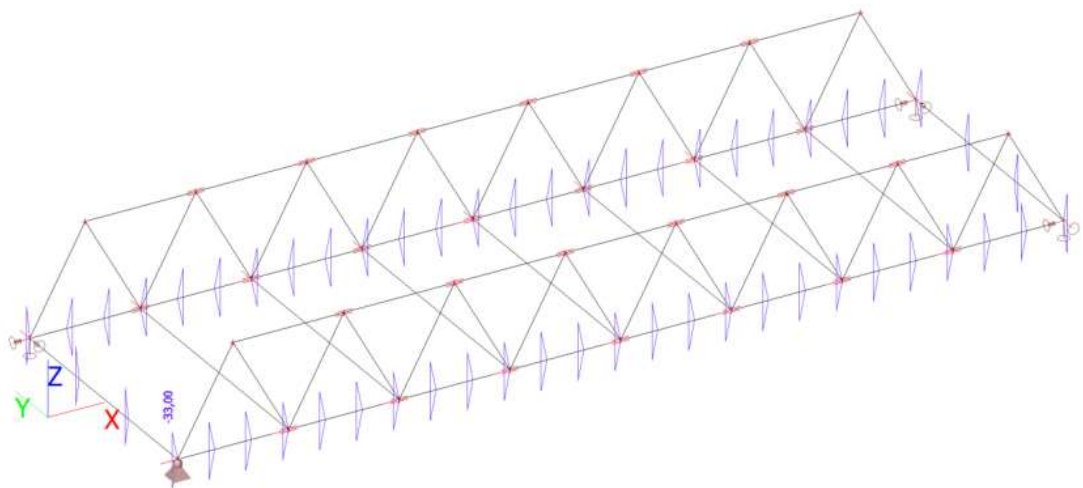

Slika 25. Promjenjivo opterećenje - djelovanje skupljanja i puzanja

6.2.5 Opterećenje vjetrom

Name	Description	Action type	Load group	Duration	Master load case
	Spec	Load type			
LC16	vjetar za neopterećeni	Variable	Construction	Short	None
	Standard	Static			

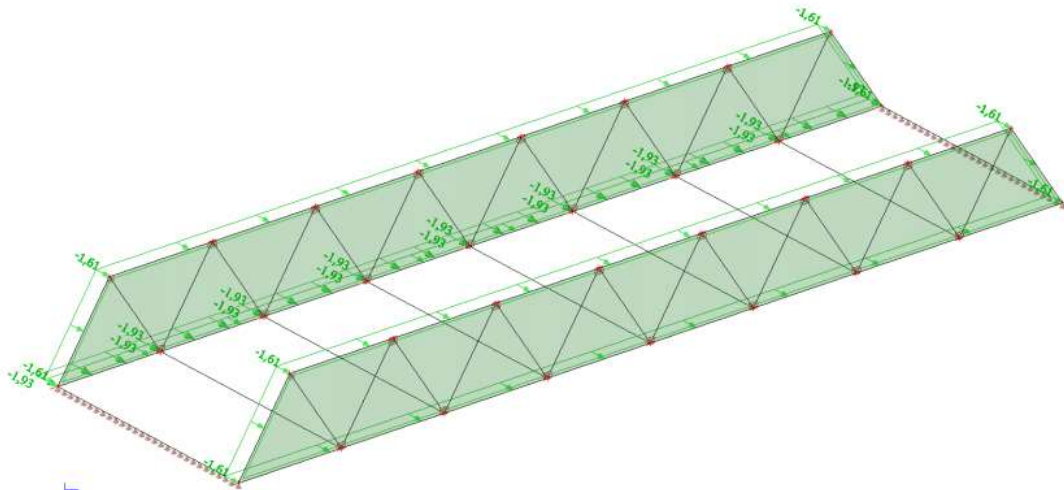

Slika 26. Promjenjivo opterećenje - djelovanje vjetra na neopterećenu konstrukciju

Name	Description	Action type	Load group	Duration	Master load case
	Spec	Load type			
LC17	vjetar za opterećeni	Variable	Construction	Short	None
	Standard	Static			

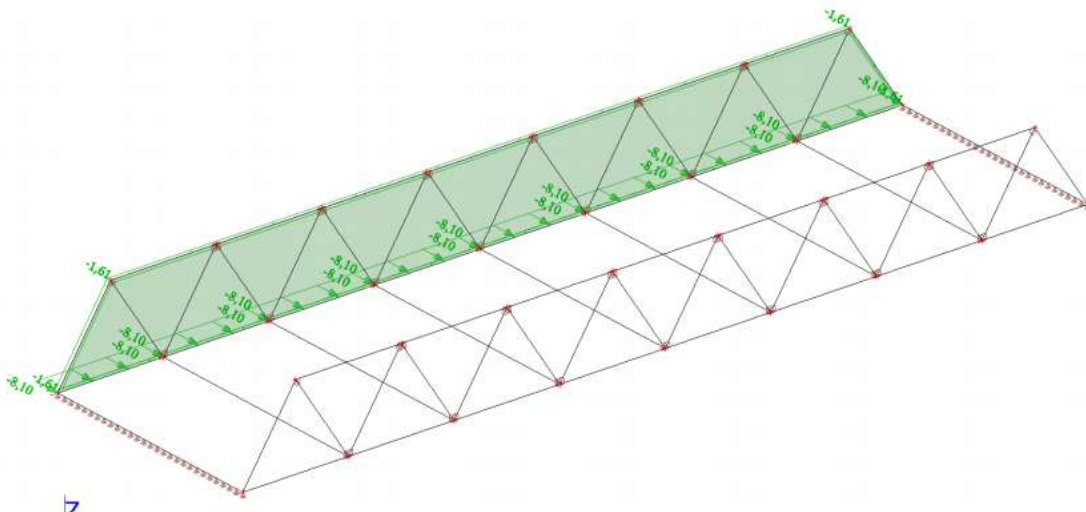

Slika 27. Promjenjivo opterećenje - djelovanje vjetra na opterećenu konstrukciju

6.2.6 Potresno opterećenje

Seismic spectrums

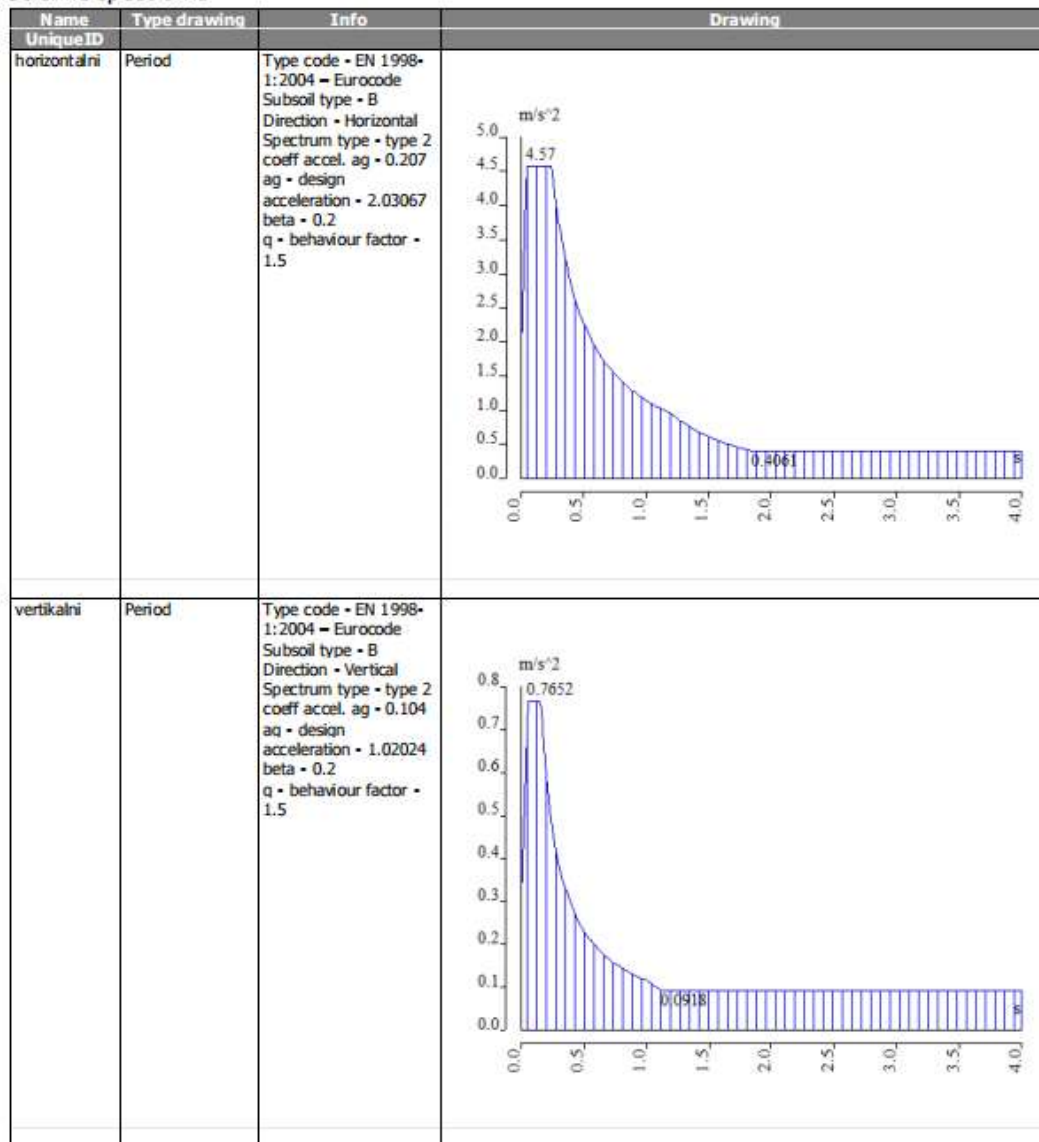

Slika 28. Seizmički spektar

Mass groups

Name	Load case
VT	LC1 - Self weight
dG	LC3 - dG_grede
pjesaci 5kN	LC9 - Q_pjesad_5kN
Q_9kN	LC6 - Q_grede_povrsinsko
Q_300kN	LC7 - Q1_grede_konc_sredina

Combination of mass groups

Name	Mass group	Coeff. [-]
CM1	VT	1,000
	dG	1,000
	Q_9kN	0,200
	Q_300kN	0,200
CM2	VT	1,000
	dG	1,000
	pjesad 5kN	0,300

Calculation protocol

Solution of Free vibration

Number of 2D elements	2912
Number of 1D elements	704
Number of mesh nodes	3259
Number of equations	19554
Combination of mass groups	MC1 CM1
Modification group	None
Number of frequencies	100
Method	Lanczos
Bending theory	Mindlin
Type of analysis model	Standard
Start of calculation	25.04.2023 10:31
End of calculation	25.04.2023 10:31

Sum of masses

	Mass type	X [kg]	Y [kg]	Z [kg]
1	Moving mass	331552,08	331552,08	331552,08
1	Total mass	332525,07	332525,07	332525,07

Relative modal masses

Mode	Omega [rad/s]	Period [s]	Freq. [Hz]	W _x /W _{tot}	W _y /W _{tot}	W _z /W _{tot}
1	12,1455	0,52	1,93	0,0000	0,0000	0,0007
2	12,4453	0,50	1,98	0,0000	0,0780	0,0000
3	27,618	0,23	4,40	0,0000	0,0000	0,7768
4	35,4656	0,18	5,64	0,0000	0,0000	0,0000
5	37,9615	0,17	6,04	0,0000	0,0000	0,0000
6	43,2036	0,15	6,88	0,0005	0,0000	0,0000
7	47,0904	0,13	7,49	0,0000	0,0000	0,0766
8	49,7014	0,13	7,91	0,0000	0,0045	0,0000
9	55,3171	0,11	8,80	0,0000	0,0000	0,0178
10	57,9007	0,11	9,22	0,0000	0,0102	0,0000
95	420,896	0,01	66,99	0,0000	0,0000	0,0000
96	423,272	0,01	67,37	0,0000	0,0000	0,0000
97	429,476	0,01	68,35	0,0000	0,0000	0,0000
98	430,421	0,01	68,50	0,0000	0,0000	0,0000
99	431,865	0,01	68,73	0,0000	0,0000	0,0000
100	437,095	0,01	69,57	0,0000	0,0000	0,0007
				0,9620	0,9266	0,9774

Values: U_{total}
 Modal shapes are normalized, so that the generalized modal mass of each mode is equal to 1kg.
 Mass combination: CM1/S9 - 32,54
 Selection: All
 Location: In nodes avg., System: Global

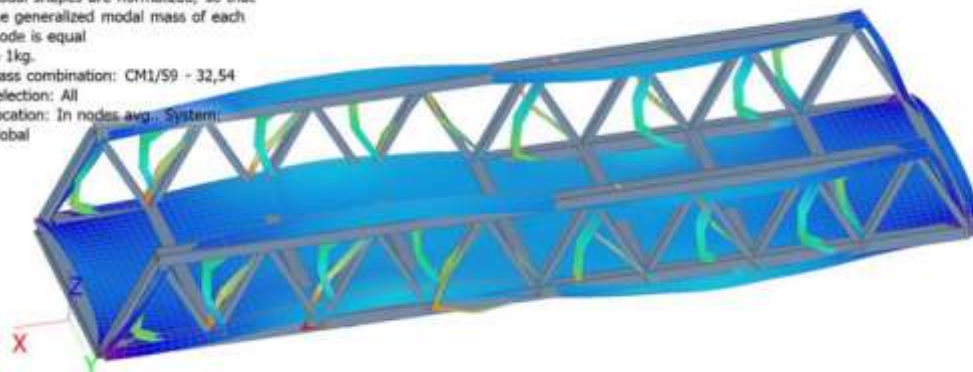

Slika 29. Vlastiti vektor konstrukcije u X smjeru

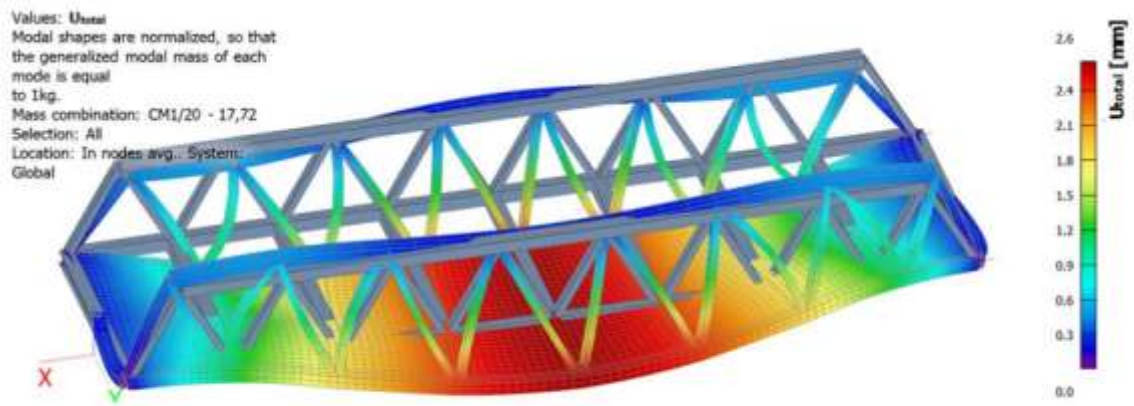

Slika 30. Vlastiti vektor konstrukcije u Y smjeru

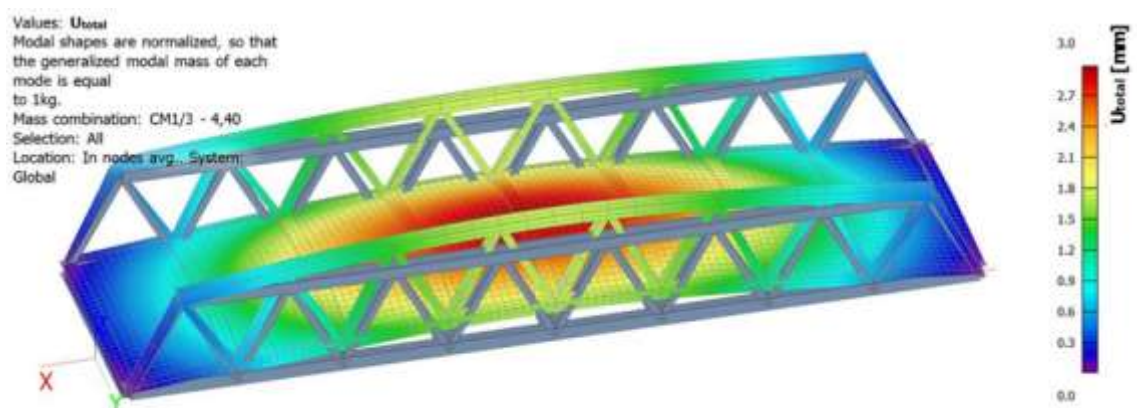

Slika 31. Vlastiti vektor konstrukcije u XY smjeru - Torzija

6.3 Rezultati - rezne sile

6.3.1 Ispuna rešetke

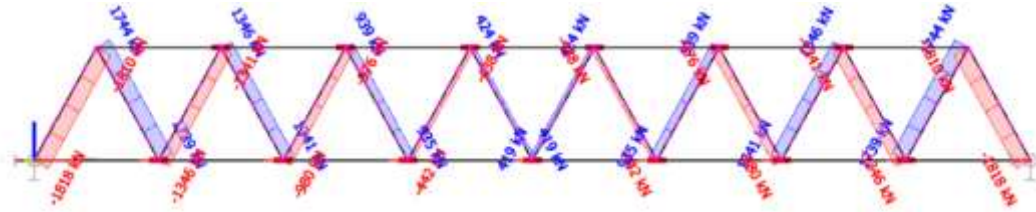

Slika 32. Uzdužne sile N

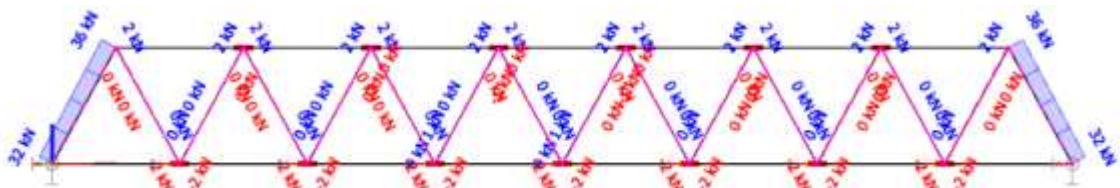

Slika 33. Poprečna sila V_y

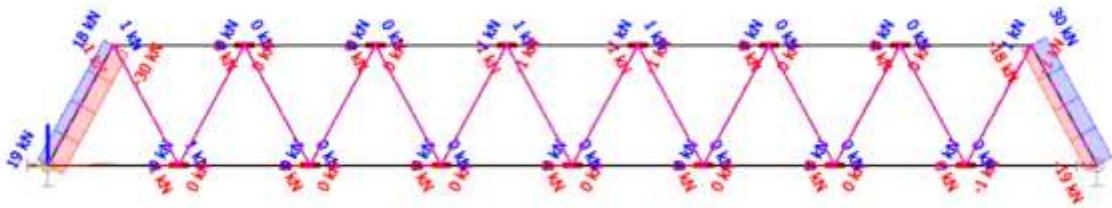

Slika 34. Poprečna sila V_z

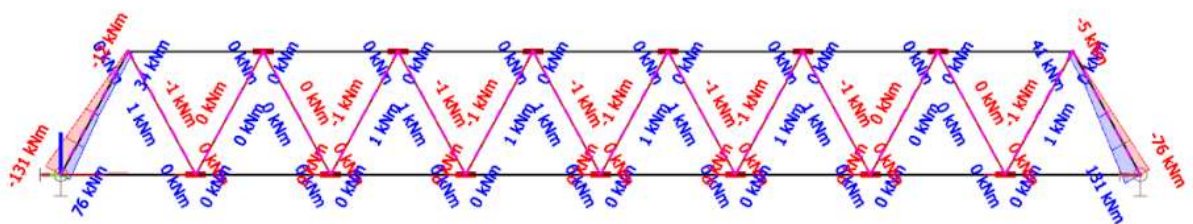

Slika 35. Moment savijanja M_y

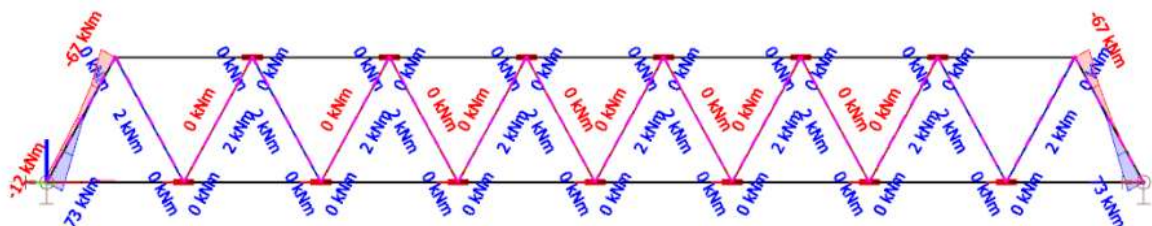

Slika 36. Moment savijanja M_z

6.3.2 Pojasevi rešetke

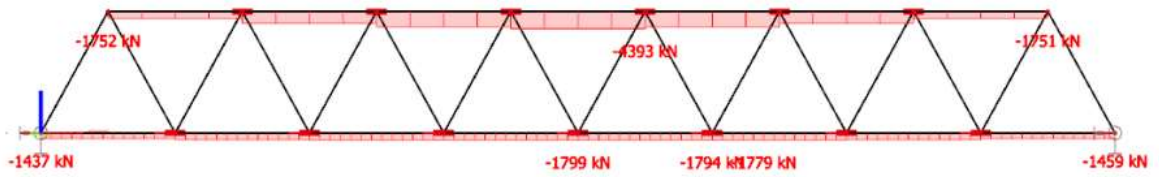

Slika 37. Uzdužne sile N

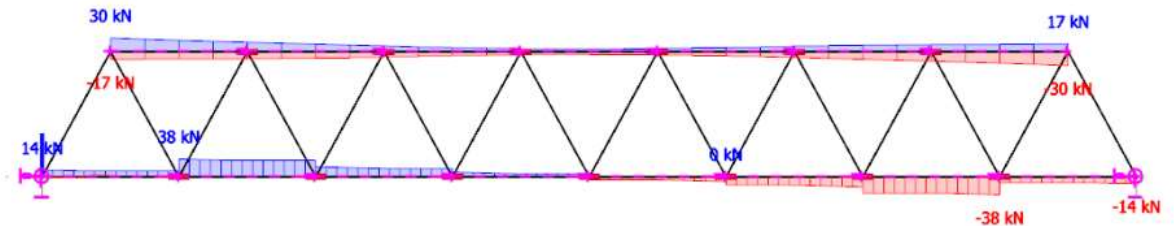

Slika 38. Poprečna sila V_y

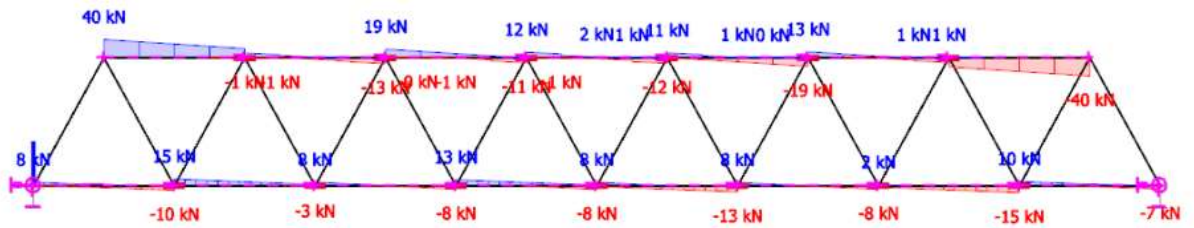

Slika 39. Poprečna sila V_z

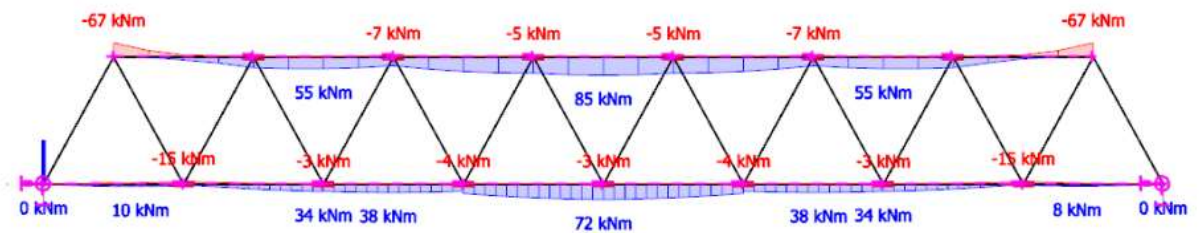

Slika 40. Moment savijanja M_y

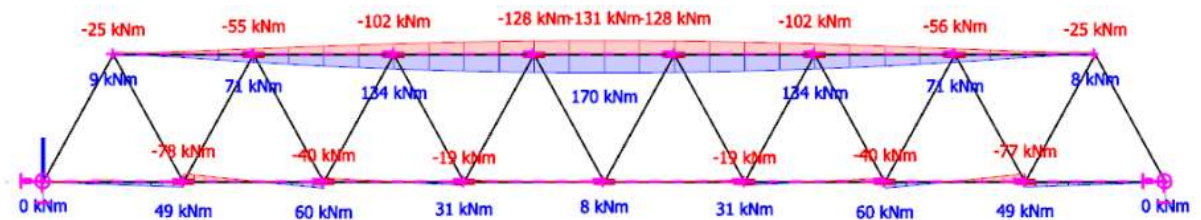

Slika 41. Moment savijanja M_z

6.3.3 Poprečne grede

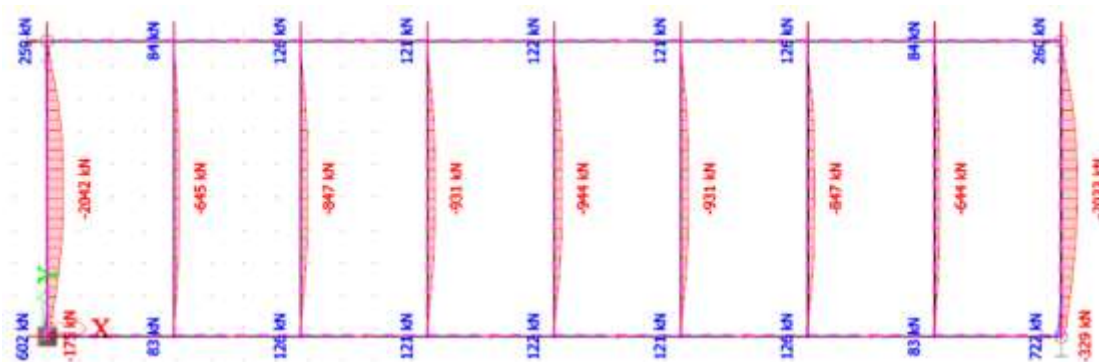

Slika 42. Uzdužne sile N

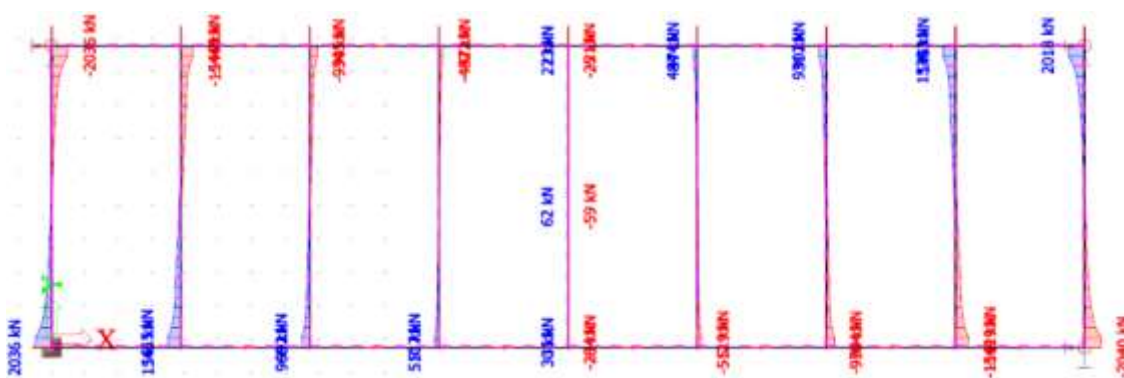

Slika 43. Poprečna sila V_y

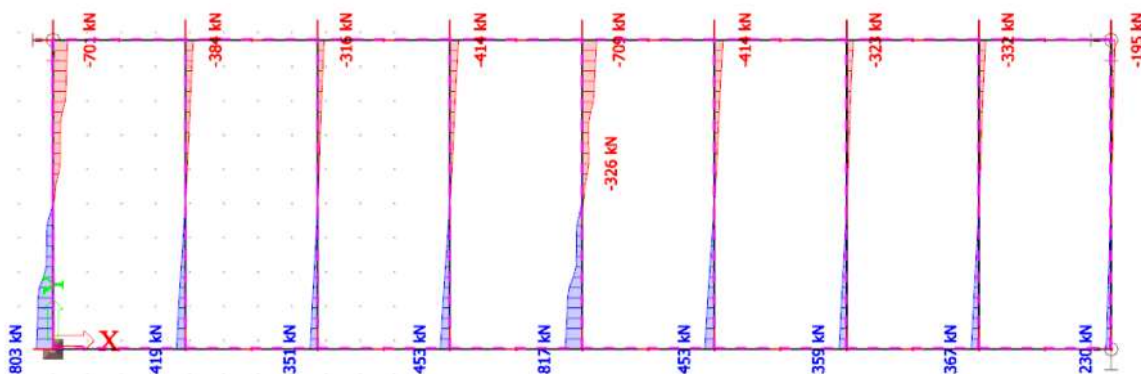

Slika 44. Poprečna sila V_z

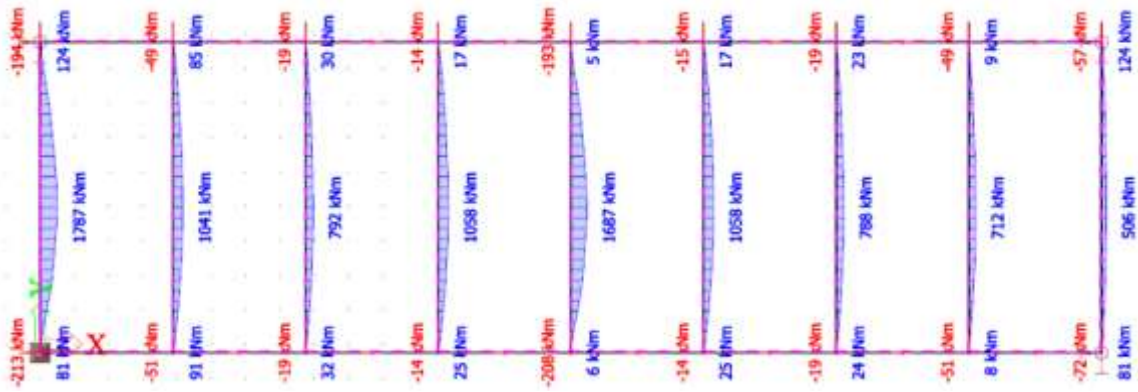

Slika 45. Moment savijanja M_y

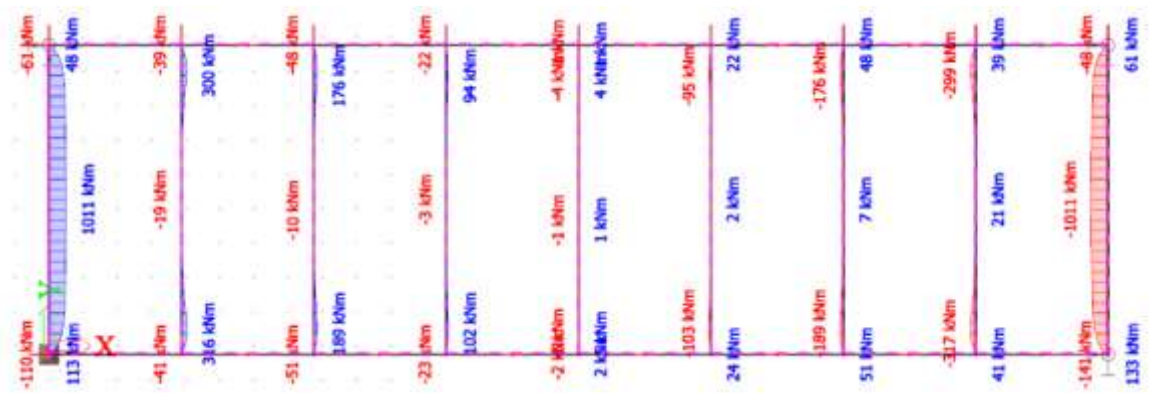

Slika 46. Moment savijanja M_z

7. IZLAZNI PODACI

7.1 Dimenzioniranje gornjeg ustroja

7.1.1 Gornji pojas

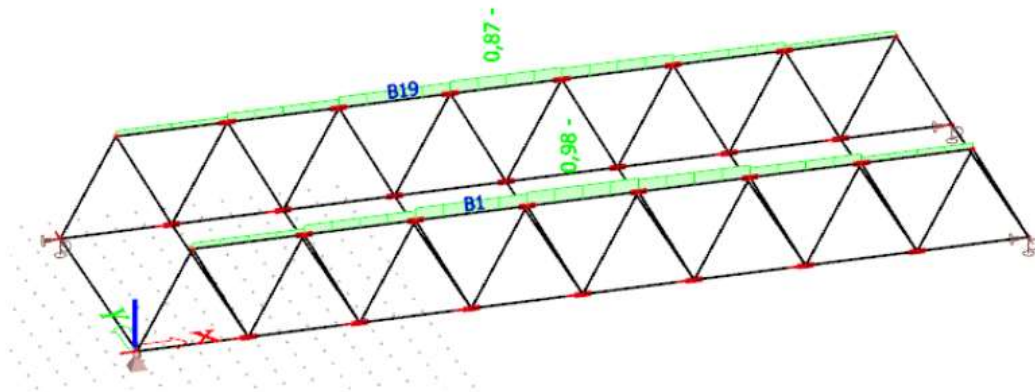

Slika 47. Gornji pojas

EC-EN 1993 Steel check ULS

Class: GSN_sve

Filter: Cross-section = gornji pojas - Box web (550; 16; 434; 30; 490; 30; 0)

Overall Unity Check

Name	dx [m]	Case	Cross-section	Material	UC _{Overall} [-]	UC _{Sec} [-]	UC _{Stab} [-]
B1	13,563-	GSN_CO5/1	gornji pojas - Box web (550; 16; 434; 30; 490; 30; 0)	S 355	0,98	0,39	0,98
B19	13,563-	GSN_CO5/1	gornji pojas - Box web (550; 16; 434; 30; 490; 30; 0)	S 355	0,87	0,35	0,87

Name	Combination key
GSN_CO5/1	1.35*LC1 + 1.35*LC3 + 1.50*LC6 + 1.50*LC7 + LC15 + 0.75*LC16

Member B1	13,563 / 27,125 m	Box web (550; 16; 434; 30; 490; 30; 0)	Welded	S 355	GSN_sve	0,98 -
------------------	--------------------------	---	---------------	--------------	----------------	---------------

Combination key
GSN_sve / 1.35*LC1 + 1.35*LC3 + 1.50*LC6 + 1.50*LC7 + LC15 + 0.75*LC16

Partial safety factors		
Resistance of cross-sections	γ_{M0}	1,00
Resistance to instability	γ_{M1}	1,10
Resistance of net sections	γ_{M2}	1,25

Material			
Yield strength	f_y	355,0	MPa
Ultimate strength	f_u	490,0	MPa

....SECTION CHECK:....

The critical check is on position 13,563 m

Axis definition :

- principal y- axis in this code check is referring to the principal z axis in SCIA Engineer
- principal z- axis in this code check is referring to the principal y axis in SCIA Engineer

Internal forces		Calculated	Unit
Normal force	N_{Ed}	-4858	kN
Shear force	$V_{y,Ed}$	0	kN
Shear force	$V_{z,Ed}$	0	kN
Torsion	T_{Ed}	0	kNm
Bending moment	$M_{y,Ed}$	187	kNm
Bending moment	$M_{z,Ed}$	93	kNm

Classification for cross-section design

Classification according to EN 1993-1-1 article 5.5.2

Classification of Internal and Outstand parts according to EN 1993-1-1 Table 5.2 Sheet 1 & 2

Id	Type	c [mm]	t [mm]	σ_1 [kN/m ²]	σ_2 [kN/m ²]	Ψ [-]	k_σ [-]	α [-]	c/t [-]	Class 1 Limit [-]	Class 2 Limit [-]	Class 3 Limit [-]	Class
1	UO	15	16	132461,454	131274,049	1,0	0,4	1,0	0,9	7,3	8,1	11,2	1
2	I	419	30	89613,528	63575,641	0,7		1,0	14,0	22,8	27,7	34,4	1
3	I	419	30	130776,906	104739,019	0,8		1,0	14,0	22,8	27,7	33,2	1
4	I	490	30	103551,613	64763,046	0,6		1,0	16,3	22,8	27,7	35,5	1
5	UO	15	16	90110,672	88923,267	1,0	0,4	1,0	0,9	7,3	8,1	11,3	1
6	I	8	30	89613,528	90110,672	1,0		1,0	0,3	22,8	27,7	31,0	1
7	I	520	16	131274,049	90110,672	0,7		1,0	32,5	22,8	27,7	34,7	3
8	I	8	30	130776,906	131274,049	1,0		1,0	0,3	22,8	27,7	31,0	1
9	UO	15	30	63575,641	62643,497	1,0	0,4	1,0	0,5	7,3	8,1	11,3	1
10	I	15	30	64763,046	63575,641	1,0		1,0	0,5	22,8	27,7	31,1	1
11	UO	15	30	104739,019	103806,875	1,0	0,4	1,0	0,5	7,3	8,1	11,3	1
12	I	15	30	103551,613	104739,019	1,0		1,0	0,5	22,8	27,7	31,0	1

Note: The Classification limits have been set according to Semi-Comp+.
The cross-section is classified as Class 3

Compression check

According to EN 1993-1-1 article 6.2.4 and formula (6.9)

Cross-section area	A	4,9540e-02	m ²
Compression resistance	$N_{c,Rd}$	17587	kN
Unity check		0,28	-

Bending moment check for M_y

According to EN 1993-1-1 article 6.2.5 and formula (6.12),(6.14)

Elastic section modulus	$W_{el,y,min}$	8,2844e-03	m ³
Elastic bending moment	$M_{el,y,Rd}$	2941	kNm
Unity check		0,06	-

Bending moment check for M_z

According to EN 1993-1-1 article 6.2.5 and formula (6.12),(6.14)

Elastic section modulus	$W_{el,z,min}$	5,6749e-03	m ³
Elastic bending moment	$M_{el,z,Rd}$	2015	kNm
Unity check		0,05	-

Torsion check

According to EN 1993-1-1 article 6.2.7 and formula (6.23)

Index of fibre	Fibre	3	
Total torsional moment	T_{Ed}	0,0	MPa
Elastic shear resistance	T_{Rd}	205,0	MPa
Unity check		0,00	-

Note: The unity check for torsion is lower than the limit value of 0,05. Therefore torsion is considered as insignificant and is ignored in the combined checks.

Combined bending, axial force and shear force check

According to EN 1993-1-1 article 6.2.9.2 and formula (6.42)

Normal stresses			
Index of fibre	Fibre	2	
Normal stress due to the normal force N	$\sigma_{N,Ed}$	98,1	MPa
Normal stress due to the bending moment M_y	$\sigma_{M_y,Ed}$	22,6	MPa
Normal stress due to the bending moment M_z	$\sigma_{M_z,Ed}$	16,4	MPa
Total longitudinal stress	$\sigma_{tot,Ed}$	137,0	MPa
Unity check		0,39	-

The member satisfies the section check.

...:STABILITY CHECK:...:

Classification for member buckling design

Decisive position for stability classification: 13,563 m

Decisive utilisation factor η : 0,39

Classification according to EN 1993-1-1 article 5.5.2

Classification of Internal and Outstand parts according to EN 1993-1-1 Table 5.2 Sheet 1 & 2

Id	Type	c [mm]	t [mm]	σ_1 [kN/m ²]	σ_2 [kN/m ²]	Ψ [-]	k_{σ} [-]	α [-]	c/t [-]	Class 1 Limit [-]	Class 2 Limit [-]	Class 3 Limit [-]	Class
1	UO	15	16	132461,454	131274,049	1,0	0,4	1,0	0,9	7,3	8,1	11,2	1
2	I	419	30	89613,528	63575,641	0,7		1,0	14,0	22,8	27,7	34,4	1
3	I	419	30	130776,906	104739,019	0,8		1,0	14,0	22,8	27,7	33,2	1
4	I	490	30	103551,613	64763,046	0,6		1,0	16,3	22,8	27,7	35,5	1
5	UO	15	16	90110,672	88923,267	1,0	0,4	1,0	0,9	7,3	8,1	11,3	1
6	I	8	30	89613,528	90110,672	1,0		1,0	0,3	22,8	27,7	31,0	1
7	I	520	16	131274,049	90110,672	0,7		1,0	32,5	22,8	27,7	34,7	3
8	I	8	30	130776,906	131274,049	1,0		1,0	0,3	22,8	27,7	31,0	1
9	UO	15	30	63575,641	62643,497	1,0	0,4	1,0	0,5	7,3	8,1	11,3	1
10	I	15	30	64763,046	63575,641	1,0		1,0	0,5	22,8	27,7	31,1	1
11	UO	15	30	104739,019	103806,875	1,0	0,4	1,0	0,5	7,3	8,1	11,3	1
12	I	15	30	103551,613	104739,019	1,0		1,0	0,5	22,8	27,7	31,0	1

Note: The Classification limits have been set according to Semi-Comp+.

The cross-section is classified as Class 3

Note: The decisive position for the stability classification is based on the utilisation factor η according to Semi-Comp+.

Flexural Buckling check

According to EN 1993-1-1 article 6.3.1.1 and formula (6.46)

Buckling parameters		yy	zz	
Sway type		non-sway	non-sway	
System length	L	27,125	3,875	m
Buckling factor	k	0,84	0,96	
Buckling length	l_{cr}	22,674	3,707	m
Critical Euler load	N_{cr}	9185	216548	kN
Slenderness	λ	105,73	21,78	
Relative slenderness	λ_{rel}	1,38	0,28	
Limit slenderness	$\lambda_{rel,0}$	0,20	0,20	
Buckling curve		b	b	
Imperfection	α	0,34	0,34	
Reduction factor	χ	0,39	0,97	
Buckling resistance	$N_{b,Rd}$	6213	15502	kN

Flexural Buckling verification			
Cross-section area	A	4,9540e-02	m ²
Buckling resistance	$N_{b,Rd}$	6213	kN
Unity check		0,78	-

Torsional(-Flexural) Buckling check

According to EN 1993-1-1 article 6.3.1.1 and formula (6.46)

Torsional buckling length	l_{cr}	27,125	m
Elastic critical load	$N_{cr,T}$	2655597	kN
Elastic critical load	$N_{cr,TF}$	9184	kN
Relative slenderness	$\lambda_{rel,T}$	1,38	
Limit slenderness	$\lambda_{rel,0}$	0,20	
Buckling curve		b	
Imperfection	α	0,34	
Reduction factor	χ	0,39	
Cross-section area	A	4,9540e-02	m ²
Buckling resistance	$N_{b,Rd}$	6213	kN
Unity check		0,78	-

Lateral Torsional Buckling check

According to EN 1993-1-1 article 6.3.2.1 & 6.3.2.2 and formula (6.54)

LTB parameters			
Method for LTB curve		General case	
Elastic section modulus	$W_{el,y}$	8,2844e-03	m ³
Elastic critical moment	M_{cr}	32411	kNm
Relative slenderness	$\lambda_{rel,LT}$	0,30	
Limit slenderness	$\lambda_{rel,LT,0}$	0,20	

Note: The slenderness or bending moment is such that Lateral Torsional Buckling effects may be ignored according to EN 1993-1-1 article 6.3.2.2(4).

M_{cr} parameters			
LTB length	l_{LT}	27,125	m
Influence of load position		no influence	
Correction factor	k	1,00	
Correction factor	k_w	1,00	
LTB moment factor	C_1	1,13	
LTB moment factor	C_2	0,45	
LTB moment factor	C_3	0,53	
Shear centre distance	d_z	0	mm
Distance of load application	z_0	0	mm
Mono-symmetry constant	β_y	0	mm
Mono-symmetry constant	z_1	0	mm

Note: C parameters are determined according to ECCS 119 2006 / Galea 2002.

Bending and axial compression check

According to EN 1993-1-1 article 6.3.3 and formula (6.61),(6.62)

Bending and axial compression check parameters			
Interaction method		alternative method 1	
Cross-section area	A	4,9540e-02	m ²
Elastic section modulus	$W_{el,y}$	8,2844e-03	m ³
Elastic section modulus	$W_{el,z}$	5,6749e-03	m ³
Design compression force	N_{Ed}	4858	kN
Design bending moment (maximum)	$M_{y,Ed}$	187	kNm
Design bending moment (maximum)	$M_{z,Ed}$	93	kNm
Characteristic compression resistance	N_{Rk}	17587	kN
Characteristic moment resistance	$M_{y,Rk}$	2941	kNm
Characteristic moment resistance	$M_{z,Rk}$	2015	kNm
Reduction factor	χ_y	0,39	
Reduction factor	χ_z	0,39	
Reduction factor	χ_{LT}	1,00	
Interaction factor	k_{yy}	1,27	
Interaction factor	k_{yz}	0,61	
Interaction factor	k_{zy}	2,15	
Interaction factor	k_{zz}	1,03	

Maximum moment $M_{y,Ed}$ is derived from beam B1 position 13,563 m.

Maximum moment $M_{z,Ed}$ is derived from beam B1 position 13,563 m.

Interaction method 1 parameters			
Critical Euler load	$N_{cr,y}$	9185	kN
Critical Euler load	$N_{cr,z}$	216548	kN
Elastic critical load	$N_{cr,T}$	2655597	kN
Elastic section modulus	$W_{el,y}$	8,2844e-03	m ³
Second moment of area	I_y	2,2782e-03	m ⁴
Second moment of area	I_z	1,4356e-03	m ⁴
Torsional constant	I_t	2,5320e-03	m ⁴
Method for equivalent moment factor $C_{my,0}$		Table A.2 Line 2 (General)	
Design bending moment (maximum)	$M_{y,Ed}$	187	kNm
Maximum relative deflection	δ_z	-29,9	mm
Equivalent moment factor	$C_{my,0}$	1,01	
Method for equivalent moment factor $C_{mz,0}$		Table A.2 Line 2 (General)	
Design bending moment (maximum)	$M_{z,Ed}$	93	kNm
Maximum relative deflection	δ_y	-0,6	mm
Equivalent moment factor	$C_{mz,0}$	1,00	
Factor	μ_y	0,59	
Factor	μ_z	1,00	
Factor	ϵ_y	0,23	
Factor	a_{LT}	0,00	
Critical moment for uniform bending	$M_{\sigma,0}$	28759	kNm
Relative slenderness	$\lambda_{rel,0}$	0,32	
Limit relative slenderness	$\lambda_{rel,0,lim}$	0,21	
Equivalent moment factor	C_{my}	1,01	
Equivalent moment factor	C_{mz}	1,00	
Equivalent moment factor	C_{mLT}	1,00	

Unity check (6.61) = 0,78 + 0,09 + 0,03 = 0,90 -

Unity check (6.62) = 0,78 + 0,15 + 0,05 = 0,98 -

The member satisfies the stability check.

7.1.2 Donji pojas

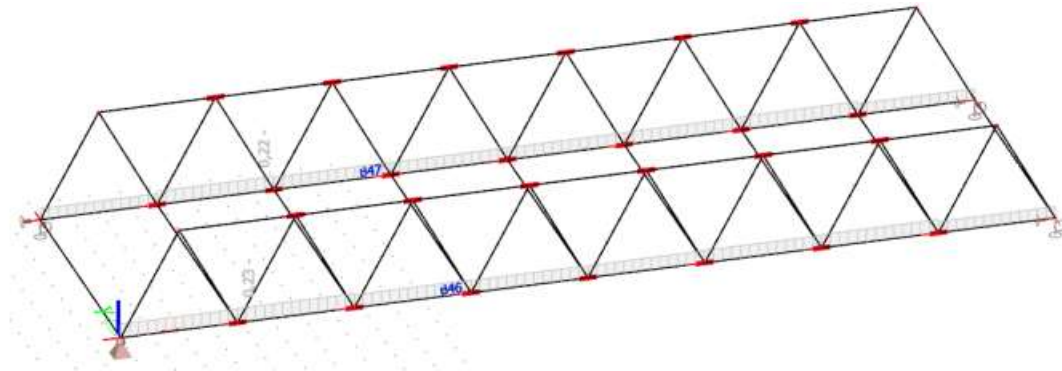

Slika 48. Donji pojas

EC-EN 1993 Steel check ULS

Linear calculation
 Class: GSN_sve
 Coordinate system: Principal
 Extreme 1D: Member
 Selection: All
 Filter: Cross-section = donji pojas - Box web (400; 16; 484; 18; 364; 16; 0)
Overall Unity Check

Name	dx [m]	Case	Cross-section	Material	UC _{Overall} [-]	UC _{Sec} [-]	UC _{Stab} [-]
B46	3,875+	GSN_CO11/1	donji pojas - Box web (400; 16; 484; 18; 364; 16; 0)	S 355	0,23	0,21	0,23
B47	7,750-	GSN_CO11/1	donji pojas - Box web (400; 16; 484; 18; 364; 16; 0)	S 355	0,22	0,18	0,22

Name	Combination key
GSN_CO11/1	LC1 + LC3 + 0.50*LC10 + LC15 - LC18 - 0.30*LC19 - LC20

EN 1993-1-1 Code Check

National annex: Standard EN

Member B46	3,875 / 31,000 m	Box web (400; 16; 484; 18; 364; 16; 0)	Welded	S 355	GSN_sve	0,23 -
-------------------	-------------------------	---	---------------	--------------	----------------	---------------

Combination key
GSN_sve / LC1 + LC3 + 0.50*LC10 + LC15 - LC18 - 0.30*LC19 - LC20

Partial safety factors		
Resistance of cross-sections	γ_{M0}	1,00
Resistance to instability	γ_{M1}	1,10
Resistance of net sections	γ_{M2}	1,25

Material			
Yield strength	f_y	355,0	MPa
Ultimate strength	f_u	490,0	MPa

....:SECTION CHECK:....

The critical check is on position 3,875 m

Internal forces		Calculated	Unit
Normal force	N_{Ed}	-1924	kN
Shear force	$V_{y,Ed}$	-22	kN
Shear force	$V_{z,Ed}$	5	kN
Torsion	T_{Ed}	-5	kNm
Bending moment	$M_{y,Ed}$	-19	kNm
Bending moment	$M_{z,Ed}$	31	kNm

Classification for cross-section design

Classification according to EN 1993-1-1 article 5.5.2

Classification of Internal and Outstand parts according to EN 1993-1-1 Table 5.2 Sheet 1 & 2

Id	Type	c [mm]	t [mm]	σ_1 [kN/m ²]	σ_2 [kN/m ²]	ψ [-]	k_σ [-]	α [-]	c/t [-]	Class 1 Limit [-]	Class 2 Limit [-]	Class 3 Limit [-]	Class
1	UO	9	16	67157,835	66812,431	1,0	0,4	1,0	0,6	7,3	8,1	11,2	1
2	I	476	18	52290,240	60516,904	0,9		1,0	26,4	22,8	27,7	32,4	2
3	I	476	18	66950,695	75177,359	0,9		1,0	26,4	22,8	27,7	32,1	2
4	I	364	16	74831,955	60862,307	0,8		1,0	22,8	22,8	27,7	33,1	1
5	UO	9	16	52151,977	51806,573	1,0	0,4	1,0	0,6	7,3	8,1	11,2	1
6	I	8	18	52290,240	52151,977	1,0		1,0	0,4	22,8	27,7	30,9	1
7	I	382	16	66812,431	52151,977	0,8		1,0	23,9	22,8	27,7	33,5	2
8	I	8	18	66950,695	66812,431	1,0		1,0	0,4	22,8	27,7	30,9	1
9	UO	8	18	60516,904	60655,167	1,0	0,4	1,0	0,4	7,3	8,1	11,2	1
10	I	9	16	60862,307	60516,904	1,0		1,0	0,6	22,8	27,7	31,0	1
11	UO	8	18	75177,359	75315,622	1,0	0,4	1,0	0,4	7,3	8,1	11,2	1
12	I	9	16	74831,955	75177,359	1,0		1,0	0,6	22,8	27,7	31,0	1

Note: The Classification limits have been set according to Semi-Comp+.

The cross-section is classified as Class 2

Compression check

According to EN 1993-1-1 article 6.2.4 and formula (6.9)

Cross-section area	A	2,9648e-02	m ²
Compression resistance	$N_{c,Rd}$	10525	kN
Unity check		0,18	-

Bending moment check for M_y

According to EN 1993-1-1 article 6.2.5 and formula (6.12),(6.13)

Plastic section modulus	$W_{pl,y}$	5,0688e-03	m ³
Plastic bending moment	$M_{pl,y,Rd}$	1799	kNm
Unity check		0,01	-

Bending moment check for M_z

According to EN 1993-1-1 article 6.2.5 and formula (6.12),(6.13)

Plastic section modulus	$W_{pl,z}$	4,4980e-03	m ³
Plastic bending moment	$M_{pl,z,Rd}$	1597	kNm
Unity check		0,02	-

Shear check for V_y

According to EN 1993-1-1 article 6.2.6 and formula (6.17)

Shear correction factor	η	1,20	
Shear area	A_v	1,2680e-02	m ²
Plastic shear resistance for V_y	$V_{pl,y,Rd}$	2599	kN
Unity check		0,01	-

Note: The shear area is taken from the cross-section properties.

Shear check for V_z

According to EN 1993-1-1 article 6.2.6 and formula (6.17)

Shear correction factor	η	1,20	
Shear area	A_v	1,7691e-02	m ²
Plastic shear resistance for V_z	$V_{pl,z,Rd}$	3626	kN
Unity check		0,00	-

Note: The shear area is taken from the cross-section properties.

Torsion check

According to EN 1993-1-1 article 6.2.7 and formula (6.23)

Index of fibre	Fibre	11	
Total torsional moment	T_{Ed}	0,9	MPa
Elastic shear resistance	T_{Rd}	205,0	MPa
Unity check		0,00	-

Note: The unity check for torsion is lower than the limit value of 0,05. Therefore torsion is considered as insignificant and is ignored in the combined checks.

Combined bending, axial force and shear force check

According to EN 1993-1-1 article 6.2.1 and formula (6.2)

Plastic tension resistance	$N_{pl,Rd}$	10525	kN
Plastic bending moment	$M_{pl,y,Rd}$	1799	kNm
Plastic bending moment	$M_{pl,z,Rd}$	1597	kNm

Unity check (6.2) = $0,18 + 0,01 + 0,02 = 0,21$ -

Note: No specific interaction formulae according to EN 1993-1-1 article 6.2.9.1 apply.

Therefore the plastic linear summation according to EN 1993-1-1 article 6.2.1(7) is verified.

Note: Since the shear forces are less than half the plastic shear resistances their effect on the moment resistances is neglected.

The member satisfies the section check.

.....STABILITY CHECK:....

Classification for member buckling design

Decisive position for stability classification: 3,875 m

Decisive utilisation factor η : 0,21

Classification according to EN 1993-1-1 article 5.5.2

Classification of Internal and Outstand parts according to EN 1993-1-1 Table 5.2 Sheet 1 & 2

Id	Type	c [mm]	t [mm]	σ_1 [kN/m ²]	σ_2 [kN/m ²]	Ψ [-]	k_σ [-]	α [-]	c/t [-]	Class 1 Limit [-]	Class 2 Limit [-]	Class 3 Limit [-]	Class
1	UO	9	16	67157,835	66812,431	1,0	0,4	1,0	0,6	7,3	8,1	11,2	1
2	I	476	18	52290,240	60516,904	0,9		1,0	26,4	22,8	27,7	32,4	2
3	I	476	18	66950,695	75177,359	0,9		1,0	26,4	22,8	27,7	32,1	2
4	I	364	16	74831,955	60862,307	0,8		1,0	22,8	22,8	27,7	33,1	1
5	UO	9	16	52151,977	51806,573	1,0	0,4	1,0	0,6	7,3	8,1	11,2	1
6	I	8	18	52290,240	52151,977	1,0		1,0	0,4	22,8	27,7	30,9	1
7	I	382	16	66812,431	52151,977	0,8		1,0	23,9	22,8	27,7	33,5	2
8	I	8	18	66950,695	66812,431	1,0		1,0	0,4	22,8	27,7	30,9	1
9	UO	8	18	60516,904	60655,167	1,0	0,4	1,0	0,4	7,3	8,1	11,2	1
10	I	9	16	60862,307	60516,904	1,0		1,0	0,6	22,8	27,7	31,0	1
11	UO	8	18	75177,359	75315,622	1,0	0,4	1,0	0,4	7,3	8,1	11,2	1
12	I	9	16	74831,955	75177,359	1,0		1,0	0,6	22,8	27,7	31,0	1

Note: The Classification limits have been set according to Semi-Comp+.

The cross-section is classified as Class 2

Note: The decisive position for the stability classification is based on the utilisation factor η according to Semi-Comp+.

Flexural Buckling check

According to EN 1993-1-1 article 6.3.1.1 and formula (6.46)

Buckling parameters			
		yy	zz
Sway type		non-sway	non-sway
System length	L	3,875	3,875
Buckling factor	k	1,00	1,00
Buckling length	l_{cr}	3,875	3,875
Critical Euler load	N_{cr}	145954	108458
Slenderness	λ	20,52	23,80
Relative slenderness	λ_{rel}	0,27	0,31
Limit slenderness	$\lambda_{rel,0}$	0,20	0,20

Note: The slenderness or compression force is such that Flexural Buckling effects may be ignored according to EN 1993-1-1 article 6.3.1.2(4).

Torsional(-Flexural) Buckling check

According to EN 1993-1-1 article 6.3.1.1 and formula (6.46)

Torsional buckling length	l_{cr}	3,875	m
Elastic critical load	$N_{cr,T}$	1753783	kN
Elastic critical load	$N_{cr,TF}$	108458	kN
Relative slenderness	$\lambda_{rel,T}$	0,31	
Limit slenderness	$\lambda_{rel,0}$	0,20	

Note: The slenderness or compression force is such that Torsional(-Flexural) Buckling effects may be ignored according to EN 1993-1-1 article 6.3.1.2(4).

Lateral Torsional Buckling check

According to EN 1993-1-1 article 6.3.2.1 & 6.3.2.2 and formula (6.54)

LTB parameters			
Method for LTB curve		General case	
Plastic section modulus	$W_{pl,y}$	5,0688e-03	m ³
Elastic critical moment	M_{cr}	250222	kNm
Relative slenderness	$\lambda_{rel,LT}$	0,08	
Limit slenderness	$\lambda_{rel,LT,0}$	0,20	

Note: The slenderness or bending moment is such that Lateral Torsional Buckling effects may be ignored according to EN 1993-1-1 article 6.3.2.2(4).

M_{cr} parameters			
LTB length	l_{LT}	3,875	m
Influence of load position		no influence	
Correction factor	k	1,00	
Correction factor	k_w	1,00	
LTB moment factor	C_1	2,30	
LTB moment factor	C_2	0,19	
LTB moment factor	C_3	1,00	
Shear centre distance	d_x	0	mm
Distance of load application	z_g	0	mm
Mono-symmetry constant	β_y	0	mm
Mono-symmetry constant	z_j	0	mm

Note: C parameters are determined according to ECCS 119 2006 / Galea 2002.

Bending and axial compression check

According to EN 1993-1-1 article 6.3.3 and formula (6.61),(6.62)

Bending and axial compression check parameters			
Interaction method		alternative method 1	
Cross-section area	A	2,9648e-02	m ²
Plastic section modulus	$W_{pl,y}$	5,0688e-03	m ³
Plastic section modulus	$W_{pl,z}$	4,4980e-03	m ³
Design compression force	N_{Ed}	1924	kN
Design bending moment (maximum)	$M_{y,Ed}$	-19	kNm
Design bending moment	$M_{z,Ed}$	-34	kNm

Bending and axial compression check parameters			
(maximum)			
Characteristic compression resistance	N_{Rk}	10525	kN
Characteristic moment resistance	$M_{y,Rk}$	1799	kNm
Characteristic moment resistance	$M_{z,Rk}$	1597	kNm
Reduction factor	χ_y	1,00	
Reduction factor	χ_z	1,00	
Reduction factor	χ_{LT}	1,00	
Interaction factor	k_{yy}	0,95	
Interaction factor	k_{yz}	0,57	
Interaction factor	k_{zy}	0,58	
Interaction factor	k_{zz}	0,97	

Maximum moment $M_{y,Ed}$ is derived from beam B46 position 3,875 m.

Maximum moment $M_{z,Ed}$ is derived from beam B46 position 7,750 m.

Interaction method 1 parameters			
Critical Euler load	$N_{\sigma,y}$	145954	kN
Critical Euler load	$N_{\sigma,z}$	108458	kN
Elastic critical load	$N_{\sigma,T}$	1753783	kN
Plastic section modulus	$W_{pl,y}$	5,0688e-03	m ³
Elastic section modulus	$W_{el,y}$	4,2296e-03	m ³
Plastic section modulus	$W_{pl,z}$	4,4980e-03	m ³
Elastic section modulus	$W_{el,z}$	3,9288e-03	m ³
Second moment of area	I_y	1,0574e-03	m ⁴
Second moment of area	I_z	7,8575e-04	m ⁴
Torsional constant	I_t	1,3497e-03	m ⁴
Method for equivalent moment factor $C_{my,0}$		Table A.2 Line 2 (General)	
Design bending moment (maximum)	$M_{y,Ed}$	-19	kNm
Maximum relative deflection	δ_z	0,0	mm
Equivalent moment factor	$C_{my,0}$	0,99	
Method for equivalent moment factor $C_{mz,0}$		Table A.2 Line 2 (General)	
Design bending moment (maximum)	$M_{z,Ed}$	-34	kNm
Maximum relative deflection	δ_y	-0,1	mm
Equivalent moment factor	$C_{mz,0}$	0,99	
Factor	μ_y	1,00	
Factor	μ_z	1,00	
Factor	E_T	0,07	
Factor	a_{LT}	0,00	
Critical moment for uniform bending	$M_{\sigma,0}$	108725	kNm
Relative slenderness	$\lambda_{rel,0}$	0,13	
Limit relative slenderness	$\lambda_{rel,0,lim}$	0,30	
Equivalent moment factor	C_{my}	0,99	
Equivalent moment factor	C_{mz}	0,99	
Equivalent moment factor	C_{mLT}	1,00	
Factor	b_{LT}	0,00	
Factor	c_{LT}	0,00	
Factor	d_{LT}	0,00	
Factor	e_{LT}	0,00	
Factor	w_y	1,20	
Factor	w_z	1,14	
Factor	η_{pl}	0,20	
Maximum relative slenderness	$\lambda_{rel,max}$	0,31	
Factor	C_{yy}	1,06	
Factor	C_{yz}	1,04	
Factor	C_{zy}	1,06	
Factor	C_{zz}	1,04	

Unity check (6.61) = 0,20 + 0,01 + 0,01 = 0,23 -

Unity check (6.62) = 0,20 + 0,01 + 0,02 = 0,23 -

The member satisfies the stability check.

7.1.3 Rubne dijagonale

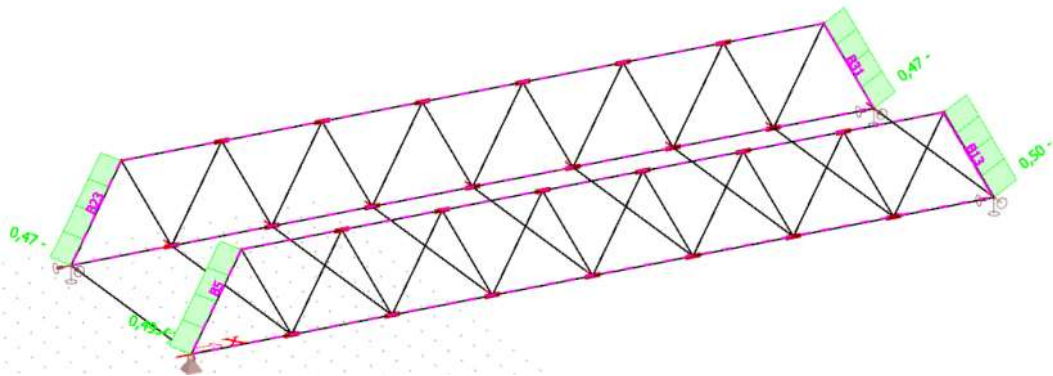

Slika 49. Rubne dijagonale

EC-EN 1993 Steel check ULS

Linear calculation

Class: GSN_sve

Filter: Cross-section = dijagonale_rubne - Box web (250; 16; 384; 16; 218; 16; 0)

Overall Unity Check

Name	dx [m]	Case	Cross-section	Material	UC _{Overall} [-]	UC _{Sec} [-]	UC _{Stab} [-]
B5	4,000	GSN_CO5/1	dijagonale_rubne - Box web (250; 16; 384; 16; 218; 16; 0)	S 355	0,49	0,49	0,47
B13	4,000	GSN_CO5/1	dijagonale_rubne - Box web (250; 16; 384; 16; 218; 16; 0)	S 355	0,50	0,49	0,50
B23	4,000	GSN_CO5/1	dijagonale_rubne - Box web (250; 16; 384; 16; 218; 16; 0)	S 355	0,47	0,47	0,45
B31	4,000	GSN_CO5/1	dijagonale_rubne - Box web (250; 16; 384; 16; 218; 16; 0)	S 355	0,47	0,47	0,45

Name	Combination key
GSN_CO5/1	1.35*LC1 + 1.35*LC3 + 1.50*LC6 + 1.50*LC7 + LC15 + 0.75*LC16

Member B13	4,000 / 4,000 m	Box web (250; 16; 384; 16; 218; 16; 0)	Welded	S 355	GSN_sve	0,50 -
-------------------	------------------------	---	---------------	--------------	----------------	---------------

Combination key
GSN_sve / 1.35*LC1 + 1.35*LC3 + 1.50*LC6 + 1.50*LC7 + LC15 + 0.75*LC16

Partial safety factors			
Resistance of cross-sections	γ _{M0}	1,00	
Resistance to instability	γ _{M1}	1,10	
Resistance of net sections	γ _{M2}	1,25	

Material			
Yield strength	f _y	355,0	MPa
Ultimate strength	f _u	490,0	MPa

...:SECTION CHECK::...

The critical check is on position 4,000 m

Internal forces		Calculated	Unit
Normal force	N_{Ed}	-1984	kN
Shear force	$V_{y,Ed}$	26	kN
Shear force	$V_{z,Ed}$	30	kN
Torsion	T_{Ed}	-7	kNm
Bending moment	$M_{y,Ed}$	122	kNm
Bending moment	$M_{z,Ed}$	50	kNm

Classification for cross-section design

Classification according to EN 1993-1-1 article 5.5.2

Classification of Internal and Outstand parts according to EN 1993-1-1 Table 5.2 Sheet 1 & 2

Id	Type	c [mm]	t [mm]	σ_1 [kN/m ²]	σ_2 [kN/m ²]	Ψ [-]	k_σ [-]	α [-]	c/t [-]	Class 1 Limit [-]	Class 2 Limit [-]	Class 3 Limit [-]	Class
1	UO	8	16	180097,163	178189,046	1,0	0,4	1,0	0,5	7,3	8,1	11,2	1
2	I	376	16	120189,848	17411,398	0,1		1,0	23,5	22,8	27,7	44,0	2
3	I	376	16	176002,270	73223,820	0,4		1,0	23,5	22,8	27,7	38,8	2
4	I	218	16	71315,703	19319,515	0,3		1,0	13,6	22,8	27,7	41,4	1
5	UO	8	16	122376,624	120468,507	1,0	0,4	1,0	0,5	7,3	8,1	11,3	1
6	I	8	16	120189,848	122376,624	1,0		1,0	0,5	22,8	27,7	31,1	1
7	I	234	16	178189,046	122376,624	0,7		1,0	14,6	22,8	27,7	34,7	1
8	I	8	16	176002,270	178189,046	1,0		1,0	0,5	22,8	27,7	31,0	1
9	UO	8	16	17411,398	15224,622	0,9	0,5	1,0	0,5	7,3	8,1	11,8	1
10	I	8	16	19319,515	17411,398	0,9		1,0	0,5	22,8	27,7	32,0	1
11	UO	8	16	73223,820	71037,044	1,0	0,4	1,0	0,5	7,3	8,1	11,3	1
12	I	8	16	71315,703	73223,820	1,0		1,0	0,5	22,8	27,7	31,2	1

Note: The Classification limits have been set according to Semi-Comp+.
The cross-section is classified as Class 2

Compression check

According to EN 1993-1-1 article 6.2.4 and formula (6.9)

Cross-section area	A	1,9776e-02	m ²
Compression resistance	$N_{c,Rd}$	7020	kN
Unity check		0,28	-

Bending moment check for M_y

According to EN 1993-1-1 article 6.2.5 and formula (6.12),(6.13)

Plastic section modulus	$W_{pl,y}$	2,6194e-03	m ³
Plastic bending moment	$M_{pl,y,Rd}$	930	kNm
Unity check		0,13	-

Bending moment check for M_z

According to EN 1993-1-1 article 6.2.5 and formula (6.12),(6.13)

Plastic section modulus	$W_{pl,z}$	1,8778e-03	m ³
Plastic bending moment	$M_{pl,z,Rd}$	667	kNm
Unity check		0,08	-

Shear check for V_y

According to EN 1993-1-1 article 6.2.6 and formula (6.17)

Shear correction factor	η	1,20	
Shear area	A_v	7,9996e-03	m ²
Plastic shear resistance for V_y	$V_{pl,y,Rd}$	1640	kN
Unity check		0,02	-

Note: The shear area is taken from the cross-section properties.

Shear check for V_z

According to EN 1993-1-1 article 6.2.6 and formula (6.17)

Shear correction factor	η	1,20	
Shear area	A_w	1,2376e-02	m ²
Plastic shear resistance for V_z	$V_{pl,z,Rd}$	2537	kN
Unity check		0,01	-

Note: The shear area is taken from the cross-section properties.**Torsion check**

According to EN 1993-1-1 article 6.2.7 and formula (6.23)

Index of fibre	Fibre	1	
Total torsional moment	T_{Ed}	2,6	MPa
Elastic shear resistance	T_{Rd}	205,0	MPa
Unity check		0,01	-

Note: The unity check for torsion is lower than the limit value of 0,05. Therefore torsion is considered as insignificant and is ignored in the combined checks.**Combined bending, axial force and shear force check**

According to EN 1993-1-1 article 6.2.1 and formula (6.2)

Plastic tension resistance	$N_{pl,Rd}$	7020	kN
Plastic bending moment	$M_{pl,y,Rd}$	930	kNm
Plastic bending moment	$M_{pl,z,Rd}$	667	kNm

Unity check (6.2) = 0,28 + 0,13 + 0,08 = 0,49 -

Note: No specific interaction formulae according to EN 1993-1-1 article 6.2.9.1 apply.

Therefore the plastic linear summation according to EN 1993-1-1 article 6.2.1(7) is verified.

Note: Since the shear forces are less than half the plastic shear resistances their effect on the moment resistances is neglected.

The member satisfies the section check.

...::STABILITY CHECK::...**Classification for member buckling design**

Decisive position for stability classification: 4,000 m

Decisive utilisation factor η : 0,49

Classification according to EN 1993-1-1 article 5.5.2

Classification of Internal and Outstand parts according to EN 1993-1-1 Table 5.2 Sheet 1 & 2

Id	Type	c [mm]	t [mm]	σ_1 [kN/m ²]	σ_2 [kN/m ²]	Ψ [-]	k_σ [-]	α [-]	c/t [-]	Class 1 Limit [-]	Class 2 Limit [-]	Class 3 Limit [-]	Class
1	UO	8	16	180097,163	178189,046	1,0	0,4	1,0	0,5	7,3	8,1	11,2	1
2	I	376	16	120189,848	17411,398	0,1		1,0	23,5	22,8	27,7	44,0	2
3	I	376	16	176002,270	73223,820	0,4		1,0	23,5	22,8	27,7	38,8	2
4	I	218	16	71315,703	19319,515	0,3		1,0	13,6	22,8	27,7	41,4	1
5	UO	8	16	122376,624	120468,507	1,0	0,4	1,0	0,5	7,3	8,1	11,3	1
6	I	8	16	120189,848	122376,624	1,0		1,0	0,5	22,8	27,7	31,1	1
7	I	234	16	178189,046	122376,624	0,7		1,0	14,6	22,8	27,7	34,7	1
8	I	8	16	176002,270	178189,046	1,0		1,0	0,5	22,8	27,7	31,0	1
9	UO	8	16	17411,398	15224,622	0,9	0,5	1,0	0,5	7,3	8,1	11,8	1
10	I	8	16	19319,515	17411,398	0,9		1,0	0,5	22,8	27,7	32,0	1
11	UO	8	16	73223,820	71037,044	1,0	0,4	1,0	0,5	7,3	8,1	11,3	1
12	I	8	16	71315,703	73223,820	1,0		1,0	0,5	22,8	27,7	31,2	1

Note: The Classification limits have been set according to Semi-Comp+.

The cross-section is classified as Class 2

Note: The decisive position for the stability classification is based on the utilisation factor η according to Semi-Comp+.

Flexural Buckling check

According to EN 1993-1-1 article 6.3.1.1 and formula (6.46)

Buckling parameters		yy	zz	
Sway type		non-sway	non-sway	
System length	L	4,000	4,000	m
Buckling factor	k	0,76	0,74	
Buckling length	l_{cr}	3,030	2,948	m
Critical Euler load	N_{cr}	96647	48448	kN
Slenderness	λ	20,59	29,09	
Relative slenderness	λ_{rel}	0,27	0,38	
Limit slenderness	$\lambda_{rel,0}$	0,20	0,20	
Buckling curve		b	b	
Imperfection	α	0,34	0,34	
Reduction factor	χ	0,98	0,93	
Buckling resistance	$N_{b,Rd}$	6224	5959	kN

Flexural Buckling verification			
Cross-section area	A	1,9776e-02	m ²
Buckling resistance	$N_{b,Rd}$	5959	kN
Unity check		0,33	-

Torsional(-Flexural) Buckling check

According to EN 1993-1-1 article 6.3.1.1 and formula (6.46)

Torsional buckling length	l_{cr}	4,000	m
Elastic critical load	$N_{cr,T}$	1063381	kN
Elastic critical load	$N_{cr,TF}$	48448	kN
Relative slenderness	$\lambda_{rel,T}$	0,38	
Limit slenderness	$\lambda_{rel,0}$	0,20	
Buckling curve		b	
Imperfection	α	0,34	
Reduction factor	χ	0,93	
Cross-section area	A	1,9776e-02	m ²
Buckling resistance	$N_{b,Rd}$	5959	kN
Unity check		0,33	-

Lateral Torsional Buckling check

According to EN 1993-1-1 article 6.3.2.1 & 6.3.2.2 and formula (6.54)

LTB parameters			
Method for LTB curve		General case	
Plastic section modulus	$W_{pl,y}$	2,6194e-03	m ³
Elastic critical moment	M_{cr}	52011	kNm
Relative slenderness	$\lambda_{rel,LT}$	0,13	
Limit slenderness	$\lambda_{rel,LT,0}$	0,20	

Note: The slenderness or bending moment is such that Lateral Torsional Buckling effects may be ignored according to EN 1993-1-1 article 6.3.2.2(4).

M_{cr} parameters			
LTB length	l_{LT}	4,000	m
Influence of load position		no influence	
Correction factor	k	1,00	
Correction factor	k_w	1,00	
LTB moment factor	C_1	1,74	
LTB moment factor	C_2	0,00	
LTB moment factor	C_3	1,00	
Shear centre distance	d_z	0	mm
Distance of load application	z_0	0	mm
Mono-symmetry constant	β_y	-1	mm
Mono-symmetry constant	z_1	0	mm

Note: C parameters are determined according to ECCS 119 2006 / Galea 2002.

Bending and axial compression check - According to EN 1993-1-1 article 6.3.3 and formula (6.61),(6.62)

Bending and axial compression check parameters			
Interaction method		alternative method 1	
Cross-section area	A	1,9776e-02	m ²
Plastic section modulus	W _{pl,y}	2,6194e-03	m ³
Plastic section modulus	W _{pl,z}	1,8778e-03	m ³
Design compression force	N _{Ed}	1984	kN
Design bending moment (maximum)	M _{y,Ed}	122	kNm
Design bending moment (maximum)	M _{z,Ed}	-64	kNm
Characteristic compression resistance	N _{Rk}	7020	kN
Characteristic moment resistance	M _{y,Rk}	930	kNm
Characteristic moment resistance	M _{z,Rk}	667	kNm
Reduction factor	χ _y	0,98	
Reduction factor	χ _z	0,93	
Reduction factor	χ _{LT}	1,00	
Interaction factor	k _{yy}	0,73	
Interaction factor	k _{yz}	0,56	
Interaction factor	k _{zy}	0,45	
Interaction factor	k _{zz}	0,95	

Maximum moment M_{y,Ed} is derived from beam B13 position 4,000 m; Maximum moment M_{z,Ed} is derived from beam B13 position 0,000 m.

Interaction method 1 parameters			
Critical Euler load	N _{cr,y}	96647	kN
Critical Euler load	N _{cr,z}	48448	kN
Elastic critical load	N _{cr,T}	1063381	kN
Plastic section modulus	W _{pl,y}	2,6194e-03	m ³
Elastic section modulus	W _{el,y}	2,1399e-03	m ³
Plastic section modulus	W _{pl,z}	1,8778e-03	m ³
Elastic section modulus	W _{el,z}	1,6250e-03	m ³
Second moment of area	I _y	4,2798e-04	m ⁴
Second moment of area	I _z	2,0312e-04	m ⁴
Torsional constant	I _t	4,1981e-04	m ⁴
Method for equivalent moment factor C _{my,0}		Table A.2 Line 1 (Linear)	
Ratio of end moments	ψ _y	0,03	
Equivalent moment factor	C _{my,0}	0,79	
Method for equivalent moment factor C _{mz,0}		Table A.2 Line 2 (General)	
Design bending moment (maximum)	M _{z,Ed}	-64	kNm
Maximum relative deflection	δ _y	0,5	mm
Equivalent moment factor	C _{mz,0}	0,97	
Factor	μ _y	1,00	
Factor	μ _z	1,00	
Factor	ε _y	0,57	
Factor	a _{LT}	0,02	
Critical moment for uniform bending	M _{cr,0}	29884	kNm
Relative slenderness	λ _{rel,0}	0,18	
Limit relative slenderness	λ _{rel,0,lim}	0,26	
Equivalent moment factor	C _{my}	0,79	
Equivalent moment factor	C _{mz}	0,97	
Equivalent moment factor	C _{mLT}	1,00	
Factor	b _{LT}	0,00	
Factor	c _{LT}	0,00	
Factor	d _{LT}	0,00	
Factor	e _{LT}	0,01	
Factor	w _y	1,22	
Factor	w _z	1,16	
Factor	η _{pl}	0,31	
Maximum relative slenderness	λ _{rel,max}	0,38	
Factor	C _{yy}	1,11	
Factor	C _{yz}	1,05	
Factor	C _{zy}	1,11	
Factor	C _{zz}	1,06	

Unity check (6.61) = 0,32 + 0,11 + 0,06 = 0,48 -

Unity check (6.62) = 0,33 + 0,07 + 0,10 = 0,50 -

The member satisfies the stability check.

7.1.4 Unutarnje dijagonale

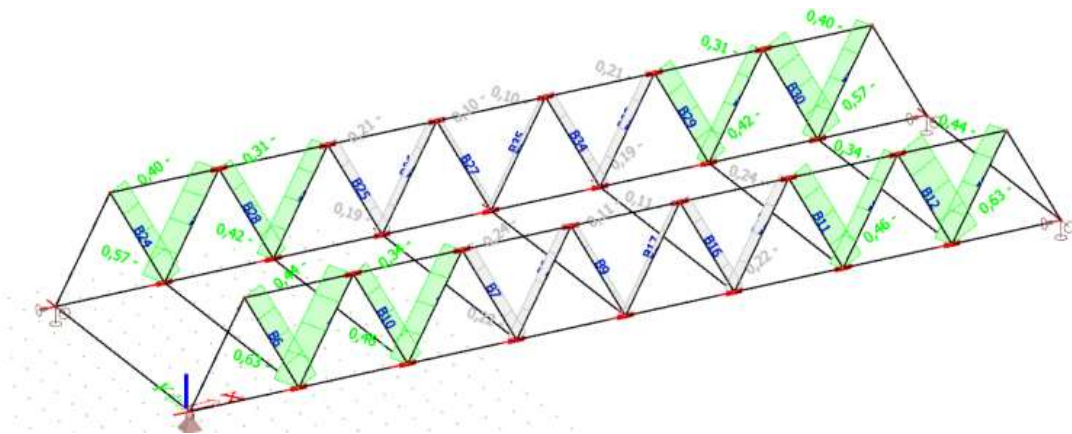

Slika 50. Unutarnje dijagonale

EC-EN 1993 Steel check ULS

Class: GSN_sve

Filter: Cross-section = dijagonale_sredina I432 - Iw (400; 12; 250; 16; 368; 0)

Overall Unity Check

Name	dx [m]	Case	Cross-section	Material	UC _{Overall} [-]	UC _{Sec} [-]	UC _{Stab} [-]
B3	4,000	GSN_CO4/1	dijagonale_sredina I432 - Iw (400; 12; 250; 16; 368; 0)	S 355	0,46	0,25	0,46
B4	4,000	GSN_CO3/2	dijagonale_sredina I432 - Iw (400; 12; 250; 16; 368; 0)	S 355	0,63	0,34	0,63
B6	0,000	GSN_CO4/1	dijagonale_sredina I432 - Iw (400; 12; 250; 16; 368; 0)	S 355	0,44	0,44	0,00
B7	0,000	GSN_CO1/3	dijagonale_sredina I432 - Iw (400; 12; 250; 16; 368; 0)	S 355	0,24	0,24	0,00
B8	4,000	GSN_CO3/2	dijagonale_sredina I432 - Iw (400; 12; 250; 16; 368; 0)	S 355	0,22	0,11	0,22
B9	0,000	GSN_CO2/4	dijagonale_sredina I432 - Iw (400; 12; 250; 16; 368; 0)	S 355	0,11	0,11	0,00
B10	0,000	GSN_CO5/5	dijagonale_sredina I432 - Iw (400; 12; 250; 16; 368; 0)	S 355	0,34	0,34	0,00
B11	4,000	GSN_CO4/1	dijagonale_sredina I432 - Iw (400; 12; 250; 16; 368; 0)	S 355	0,46	0,25	0,46
B12	4,000	GSN_CO3/2	dijagonale_sredina I432 - Iw (400; 12; 250; 16; 368; 0)	S 355	0,63	0,34	0,63
B14	0,000	GSN_CO4/1	dijagonale_sredina I432 - Iw (400; 12; 250; 16; 368; 0)	S 355	0,44	0,44	0,00
B15	0,000	GSN_CO1/3	dijagonale_sredina I432 - Iw (400; 12; 250; 16; 368; 0)	S 355	0,24	0,24	0,00
B16	4,000	GSN_CO3/2	dijagonale_sredina I432 - Iw (400; 12; 250; 16; 368; 0)	S 355	0,22	0,11	0,22
B17	0,000	GSN_CO1/3	dijagonale_sredina I432 - Iw (400; 12; 250; 16; 368; 0)	S 355	0,11	0,11	0,00
B18	0,000	GSN_CO5/5	dijagonale_sredina I432 - Iw (400; 12;	S 355	0,34	0,34	0,00

Name	dx [m]	Case	Cross-section	Material	UC _{Overall} [-]	UC _{Sec} [-]	UC _{Stab} [-]
B21	4,000	GSN_CO4/1	250; 16; 368; 0) dijagonale_sredina I432 - Iw (400; 12; 250; 16; 368; 0)	S 355	0,42	0,22	0,42
B22	4,000	GSN_CO3/2	dijagonale_sredina I432 - Iw (400; 12; 250; 16; 368; 0)	S 355	0,57	0,31	0,57
B24	0,000	GSN_CO4/1	dijagonale_sredina I432 - Iw (400; 12; 250; 16; 368; 0)	S 355	0,40	0,40	0,00
B25	0,000	GSN_CO5/5	dijagonale_sredina I432 - Iw (400; 12; 250; 16; 368; 0)	S 355	0,21	0,21	0,00
B26	4,000	GSN_CO3/2	dijagonale_sredina I432 - Iw (400; 12; 250; 16; 368; 0)	S 355	0,19	0,10	0,19
B27	0,000	GSN_CO5/5	dijagonale_sredina I432 - Iw (400; 12; 250; 16; 368; 0)	S 355	0,10	0,10	0,00
B28	0,000	GSN_CO4/1	dijagonale_sredina I432 - Iw (400; 12; 250; 16; 368; 0)	S 355	0,31	0,31	0,00
B29	4,000	GSN_CO4/1	dijagonale_sredina I432 - Iw (400; 12; 250; 16; 368; 0)	S 355	0,42	0,22	0,42
B30	4,000	GSN_CO3/2	dijagonale_sredina I432 - Iw (400; 12; 250; 16; 368; 0)	S 355	0,57	0,31	0,57
B32	0,000	GSN_CO4/1	dijagonale_sredina I432 - Iw (400; 12; 250; 16; 368; 0)	S 355	0,40	0,40	0,00
B33	0,000	GSN_CO5/5	dijagonale_sredina I432 - Iw (400; 12; 250; 16; 368; 0)	S 355	0,21	0,21	0,00
B34	4,000	GSN_CO3/2	dijagonale_sredina I432 - Iw (400; 12; 250; 16; 368; 0)	S 355	0,19	0,10	0,19
B35	0,000	GSN_CO5/5	dijagonale_sredina I432 - Iw (400; 12; 250; 16; 368; 0)	S 355	0,10	0,10	0,00
B36	0,000	GSN_CO2/4	dijagonale_sredina I432 - Iw (400; 12; 250; 16; 368; 0)	S 355	0,31	0,31	0,00

Name	Combination key
GSN_CO4/1	1.35*LC1 + 1.35*LC3 + 1.50*LC6 + 1.50*LC7 + 0.90*LC13 + LC15
GSN_CO3/2	1.35*LC1 + 1.35*LC3 + 1.50*LC6 + 1.50*LC7 + 0.90*LC12 + LC15
GSN_CO1/3	1.35*LC1 + 1.35*LC3 + 1.50*LC6 + 1.50*LC7 + 0.90*LC10 + LC15
GSN_CO2/4	1.35*LC1 + 1.35*LC3 + 1.50*LC6 + 1.50*LC7 + 0.90*LC11 + LC15
GSN_CO5/5	1.35*LC1 + 1.35*LC3 + 1.50*LC6 + 1.50*LC7 + LC15 + 0.75*LC16

EN 1993-1-1 Code Check

National annex: Standard EN

Member B4	4,000 / 4,000 m	Iw (400; 12; 250; 16; 368; 0)	Welded	S 355	GSN_sve	0,63 -
------------------	------------------------	--------------------------------------	---------------	--------------	----------------	---------------

Combination key
GSN_sve / 1.35*LC1 + 1.35*LC3 + 1.50*LC6 + 1.50*LC7 + 0.90*LC12 + LC15

Partial safety factors		
Resistance of cross-sections	γ_{M0}	1,00
Resistance to instability	γ_{M1}	1,10
Resistance of net sections	γ_{M2}	1,25

Material			
Yield strength	f_y	355,0	MPa
Ultimate strength	f_u	490,0	MPa

...::SECTION CHECK::...

The critical check is on position 4,000 m

Internal forces		Calculated	Unit
Normal force	N_{Ed}	-1490	kN
Shear force	$V_{y,Ed}$	-1	kN
Shear force	$V_{z,Ed}$	0	kN
Torsion	T_{Ed}	0	kNm
Bending moment	$M_{y,Ed}$	0	kNm
Bending moment	$M_{z,Ed}$	0	kNm

Classification for cross-section design

Classification according to EN 1993-1-1 article 5.5.2

Classification of Internal and Outstand parts according to EN 1993-1-1 Table 5.2 Sheet 1 & 2

Id	Type	c [mm]	t [mm]	σ_1 [kN/m ²]	σ_2 [kN/m ²]	ψ [-]	k_{σ} [-]	α [-]	c/t [-]	Class 1 Limit [-]	Class 2 Limit [-]	Class 3 Limit [-]	Class
1	SO	119	16	119995,550	119995,550	1,0	0,4	1,0	7,4	7,3	8,1	11,4	2
3	SO	119	16	119995,550	119995,550	1,0	0,4	1,0	7,4	7,3	8,1	11,4	2
4	I	368	12	119995,550	119995,550	1,0		1,0	30,7	22,8	27,7	30,9	3
5	SO	119	16	119995,550	119995,550	1,0	0,4	1,0	7,4	7,3	8,1	11,4	2
7	SO	119	16	119995,550	119995,550	1,0	0,4	1,0	7,4	7,3	8,1	11,4	2

Note: The Classification limits have been set according to Semi-Comp+.

The cross-section is classified as Class 3

Semi-Comp+ properties			
Material coefficient	ϵ	0,81	
Flange class 2 slenderness limit	$\beta_{2,z,f}$	8,14	
Flange class 3 slenderness limit	$\beta_{3,z,f}$	13,02	
Web slenderness ratio	c/t_w	30,67	
Flange slenderness ratio	c/t_f	7,44	
Reference slenderness ratio	$c/t_{ref,z}$	0,00	
Interpolated section modulus	$W_{3,z}$	5,1325e-04	m ³

Note: The resistance for this semi-compact section has been calculated according to Semi-Comp+.**Compression check**

According to EN 1993-1-1 article 6.2.4 and formula (6.9)

Cross-section area	A	1,2416e-02	m ²
Compression resistance	$N_{c,Rd}$	4408	kN
Unity check		0,34	-

Shear check for V_y

According to EN 1993-1-1 article 6.2.6 and formula (6.17)

Shear correction factor	η	1,20	
Shear area	A_v	8,0000e-03	m ²
Plastic shear resistance for V_y	$V_{pl,y,Rd}$	1640	kN
Unity check		0,00	-

Torsion check

According to EN 1993-1-1 article 6.2.7 and formula (6.23)

Index of fibre	Fibre	18	
Total torsional moment	T_{Ed}	0,2	MPa
Elastic shear resistance	T_{Rd}	205,0	MPa
Unity check		0,00	-

Note: The unity check for torsion is lower than the limit value of 0,05. Therefore torsion is considered as insignificant and is ignored in the combined checks.

The member satisfies the section check.

...:STABILITY CHECK:...:**Classification for member buckling design**

Decisive position for stability classification: 2,000 m

Decisive utilisation factor η : 0,34

Classification according to EN 1993-1-1 article 5.5.2

Classification of Internal and Outstand parts according to EN 1993-1-1 Table 5.2 Sheet 1 & 2

Id	Type	c [mm]	t [mm]	σ_1 [kN/m ²]	σ_2 [kN/m ²]	Ψ [-]	k_σ [-]	α [-]	c/t [-]	Class 1 Limit [-]	Class 2 Limit [-]	Class 3 Limit [-]	Class
1	SO	119	16	119633,752	116066,571	1,0	0,4	1,0	7,4	7,3	8,1	11,3	2
3	SO	119	16	119993,468	123560,649	1,0	0,4	1,0	7,4	7,3	8,1	11,2	2
4	I	368	12	119813,610	119813,610	1,0		1,0	30,7	22,8	27,7	30,9	3
5	SO	119	16	119993,468	123560,649	1,0	0,4	1,0	7,4	7,3	8,1	11,2	2
7	SO	119	16	119633,752	116066,571	1,0	0,4	1,0	7,4	7,3	8,1	11,3	2

Note: The Classification limits have been set according to Semi-Comp+.

The cross-section is classified as Class 3

Note: The decisive position for the stability classification is based on the utilisation factor η according to Semi-Comp+.

Flexural Buckling check

According to EN 1993-1-1 article 6.3.1.1 and formula (6.46)

Buckling parameters		yy	zz	
Sway type		non-sway	non-sway	
System length	L	4,000	4,000	m
Buckling factor	k	1,00	1,00	
Buckling length	l_{cr}	4,000	4,000	m
Critical Euler load	N_{cr}	44672	5403	kN
Slenderness	λ	24,00	69,01	
Relative slenderness	λ_{rel}	0,31	0,90	
Limit slenderness	$\lambda_{rel,0}$	0,20	0,20	
Buckling curve		b	c	
Imperfection	α	0,34	0,49	
Reduction factor	χ	0,96	0,60	
Buckling resistance	$N_{b,Rd}$	3842	2396	kN

Flexural Buckling verification			
Cross-section area	A	1,2416e-02	m ²
Buckling resistance	$N_{b,Rd}$	2396	kN
Unity check		0,62	-

Torsional(-Flexural) Buckling check

According to EN 1993-1-1 article 6.3.1.1 and formula (6.46)

Note: For this I-section the Torsional(-Flexural) buckling resistance is higher than the resistance for Flexural buckling. Therefore Torsional(-Flexural) buckling is not printed on the output.

Bending and axial compression check

According to EN 1993-1-1 article 6.3.3 and formula (6.61),(6.62)

Bending and axial compression check parameters			
Interaction method		alternative method 1	
Cross-section area	A	1,2416e-02	m ²
Interpolated section modulus	W _{3,z}	5,1325e-04	m ³
Design compression force	N _{Ed}	1490	kN
Design bending moment (maximum)	M _{y,Ed}	0	kNm
Design bending moment (maximum)	M _{z,Ed}	1	kNm
Characteristic compression resistance	N _{Rk}	4408	kN
Characteristic moment resistance	M _{z,Rk}	182	kNm
Reduction factor	χ _y	0,96	
Reduction factor	χ _z	0,60	
Modified reduction factor	χ _{L,T,mod}	1,00	
Interaction factor	k _{yz}	0,89	
Interaction factor	k _{zz}	1,18	

Maximum moment M_{y,Ed} is derived from beam B4 position 0,000 m.

Maximum moment M_{z,Ed} is derived from beam B4 position 2,000 m.

Interaction method 1 parameters			
Critical Euler load	N _{cr,y}	44672	kN
Critical Euler load	N _{cr,z}	5403	kN
Elastic critical load	N _{cr,T}	8732	kN
Interpolated section modulus	W _{3,y}	1,9423e-03	m ³
Elastic section modulus	W _{el,y}	1,7246e-03	m ³
Interpolated section modulus	W _{3,z}	5,1325e-04	m ³
Elastic section modulus	W _{el,z}	3,3376e-04	m ³
Second moment of area	I _y	3,4492e-04	m ⁴
Second moment of area	I _z	4,1720e-05	m ⁴
Torsional constant	I _t	9,0385e-07	m ⁴
Method for equivalent moment factor C _{mz,0}		Table A.2 Line 4 (Line load)	
Equivalent moment factor	C _{mz,0}	1,01	
Factor	μ _y	1,00	
Factor	μ _z	0,87	
Factor	a _{LT}	1,00	
Critical moment for uniform bending	M _{cr,0}	1212	kNm
Relative slenderness	λ _{rel,0}	0,75	
Equivalent moment factor	C _{mz}	1,01	
Factor	c _{LT}	0,00	
Factor	e _{LT}	0,00	
Factor	w _y	1,13	
Factor	w _z	1,50	
Factor	η _{pl}	0,37	
Maximum relative slenderness	λ _{rel,max}	0,90	
Factor	C _{yz}	1,09	
Factor	C _{zz}	1,03	

Unity check (6.61) = 0,39 + 0,00 + 0,01 = 0,39 -

Unity check (6.62) = 0,62 + 0,00 + 0,01 = 0,63 -

The member satisfies the stability check.

7.1.5 Armirano betonska ploča

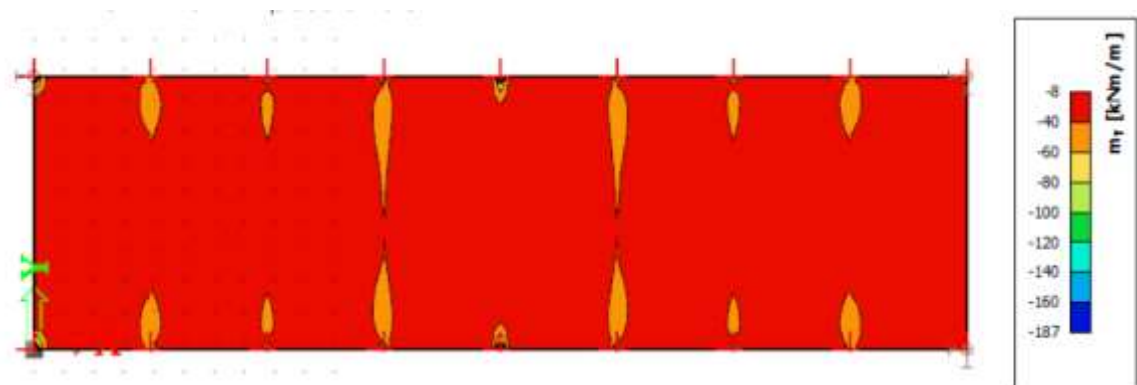
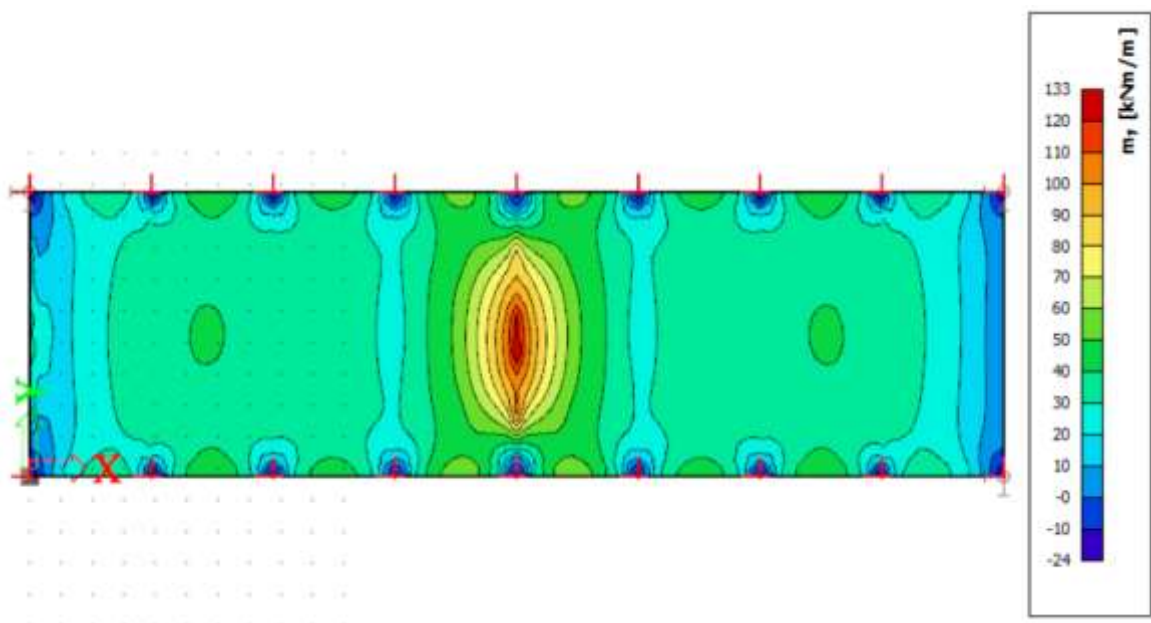
Slika 51. Moment savijanja uzdužno na most - $M_{x,min}$ Slika 52. Moment savijanja uzdužno na most - $M_{x,max}$

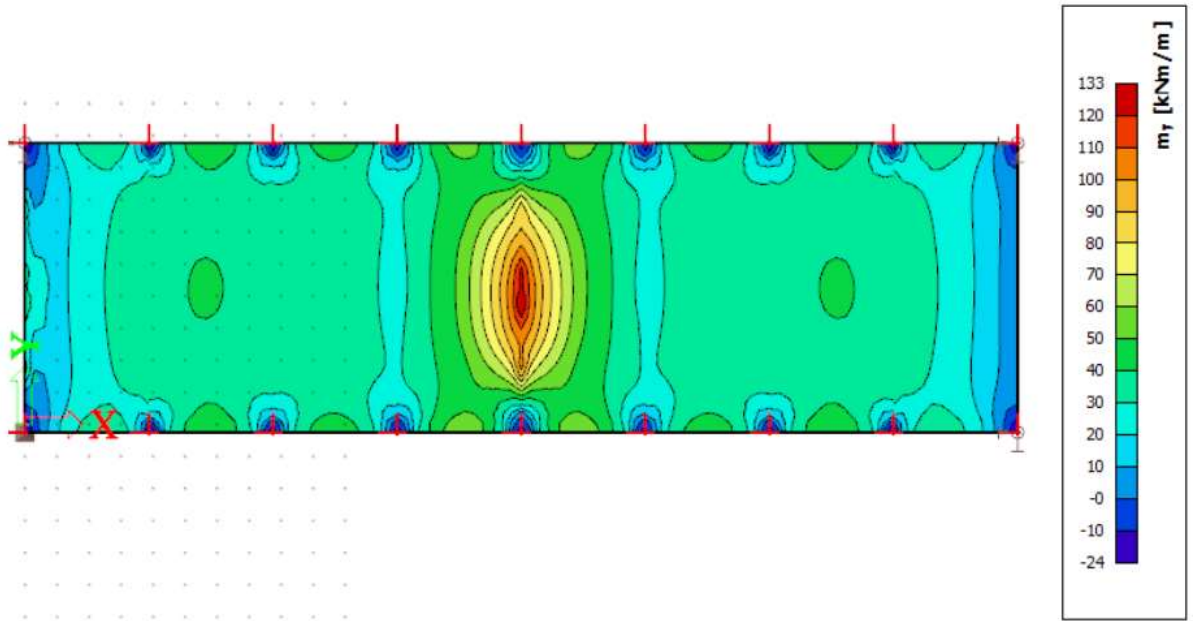

Slika 53. Moment savijanja okomito na most - $M_{y,min}$

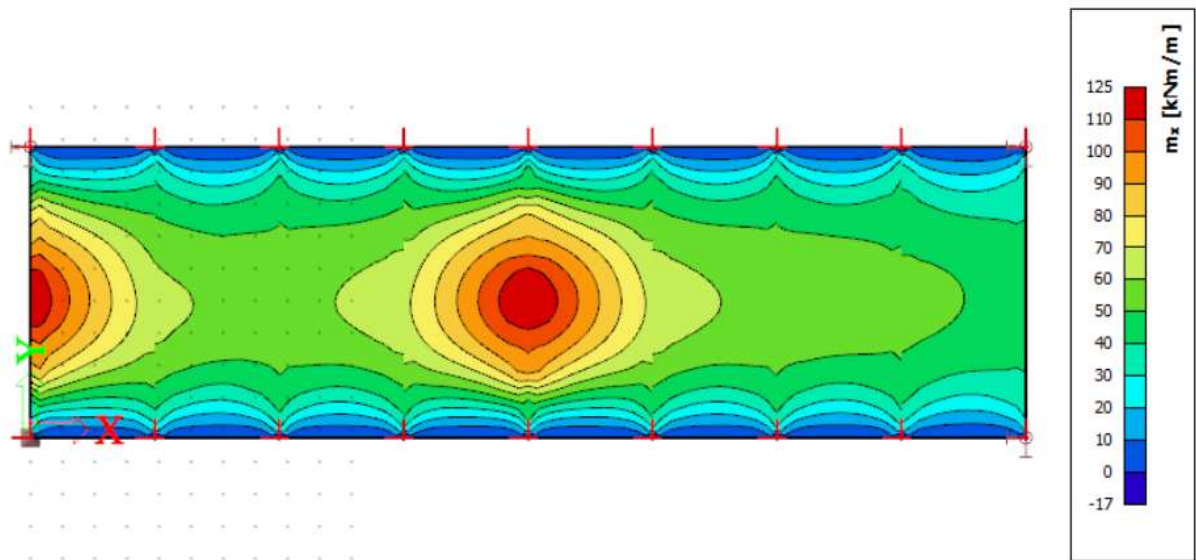

Slika 54. Moment savijanja okomito na most - $M_{y,max}$

7.1.6 Armirano betonska ploča - potrebna armatura

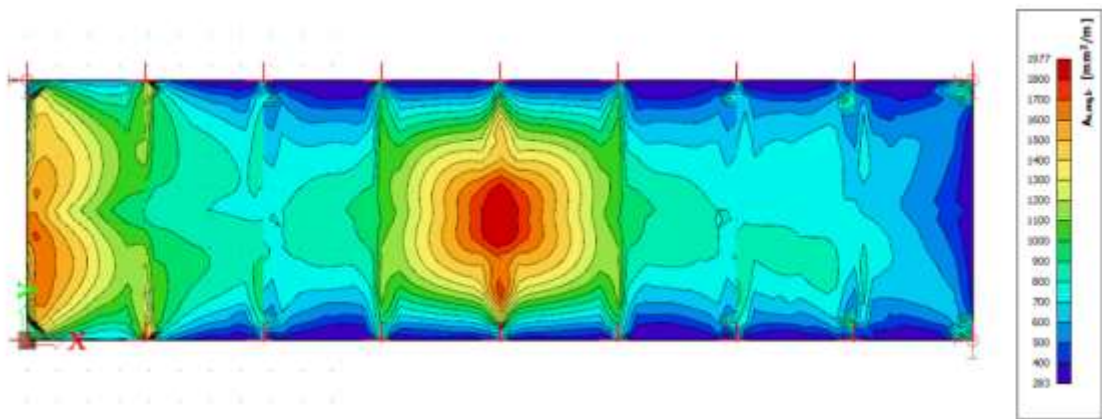

Slika 55. Donja zona - okomito na most

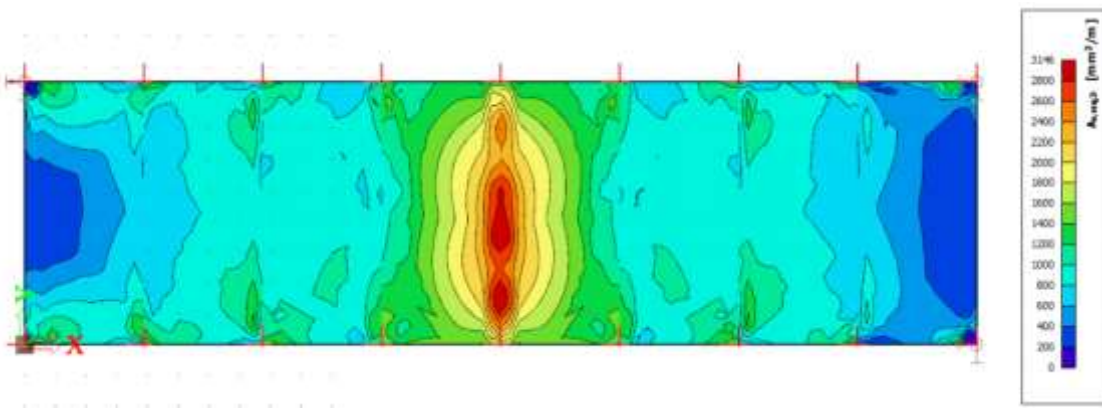

Slika 56. Donja zona - uzdužno na most

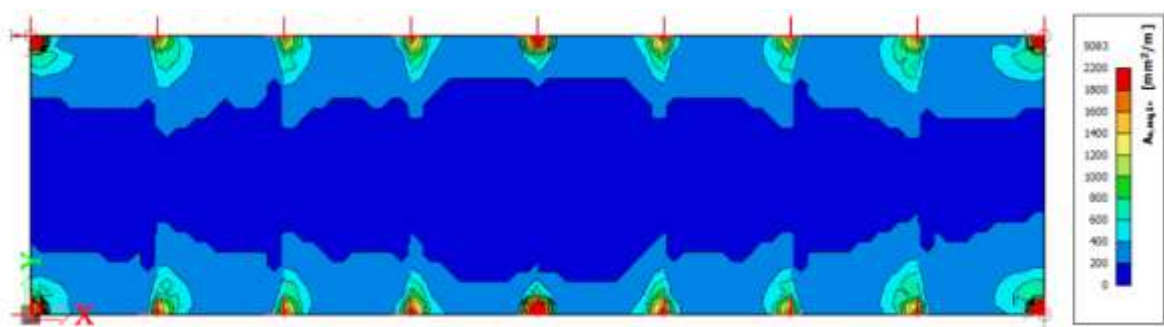

Slika 57. Gornja zona - okomito na most

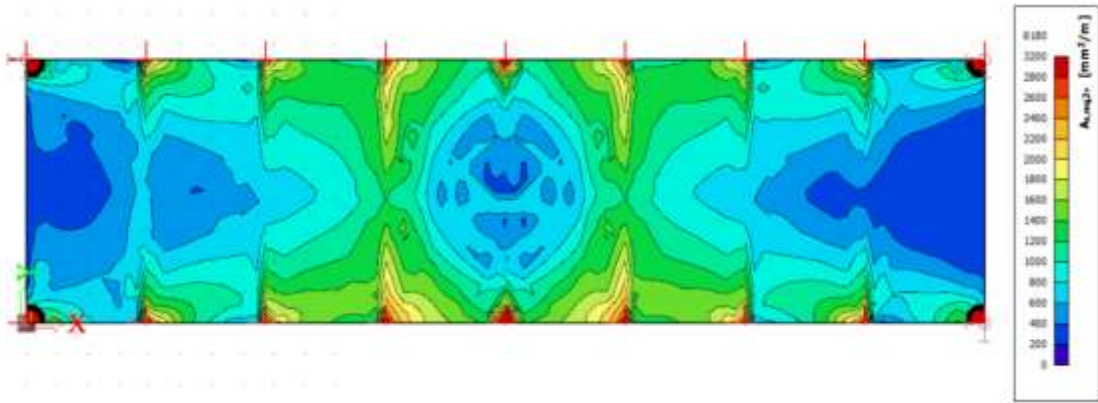

Slika 58. Gornja zona - uzdužno na most

Odabrana armatura:

-Donja zona:

Okomito na most: $\Phi 18/10$

Uzdužno na most: $\Phi 20/10$

-Gornja zona:

Okomito na most: $\Phi 18/10$

Uzdužno na most: $\Phi 20/10$

PLOČA		Minimalna armatura		Maksimalna armatura
C 30/37	$f_{yk}=500 \text{ N/mm}^2$	$A_{s1,min} = 0,26 \cdot b \cdot d \cdot \frac{f_{ctm}}{f_{yk}}$	$A_{s1,min} = 0,0013 \cdot b \cdot d$	$A_{s1,max} = 0,031 \cdot A_e$
$b = 100,0 \text{ cm}$ $h = 20,0 \text{ cm}$	$c = 3,0 \text{ cm}$ $d = 17,0 \text{ cm}$	$A_{s1,min} = 2,56 \text{ cm}^2/\text{m}$	$A_{s1,min} = 2,21 \text{ cm}^2/\text{m}$	$A_{s1,max} = 62,00 \text{ cm}^2/\text{m}$

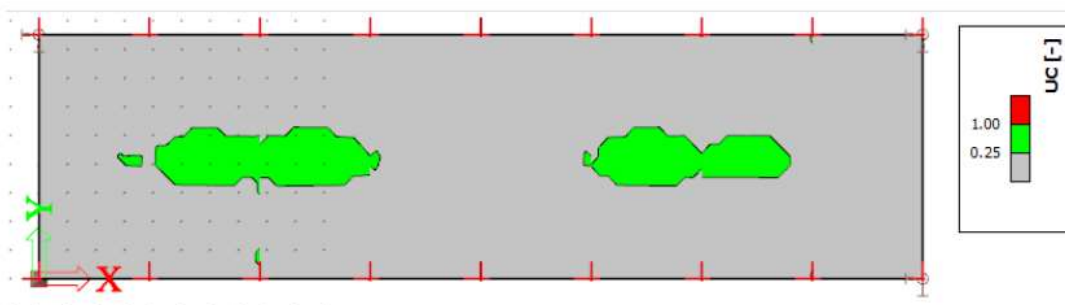

Slika 59. GSU anvelopa - provjera uvjeta minimalne i maksimalne armature

7.2 Dimenzioniranje donjeg ustroja

7.2.1 Proračun potrebne armature u donjoj i gornjoj zoni

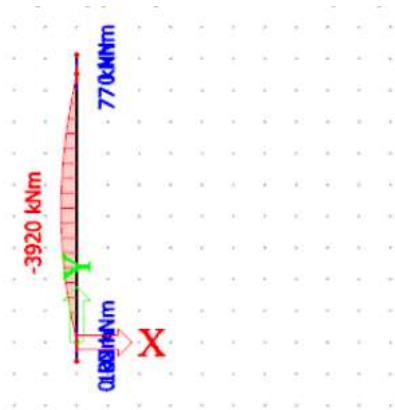
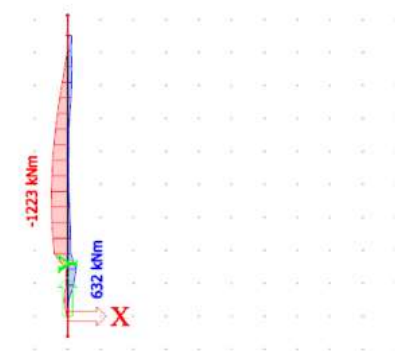
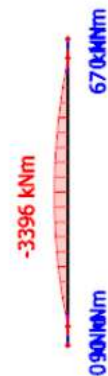
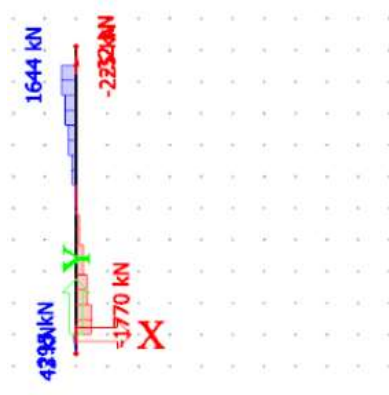
Slika 60. Moment savijanja M_y Slika 61. Moment savijanja M_z Slika 62. Poprečne sile V_z 



Slika 63. Poprečne sile V_y



Slika 64. Uzdužne sile N



Slika 65. Potrebna uzdužna armatura



Slika 66. Potrebna poprečna armatura

7.2.2 Proračun potrebne armature na licima zida

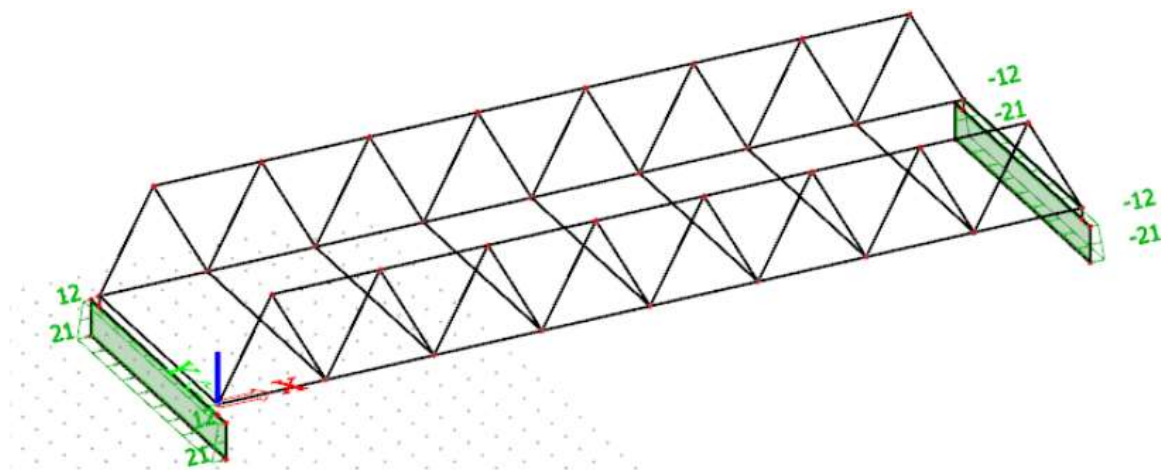

Slika 67. Opterećenje tlom

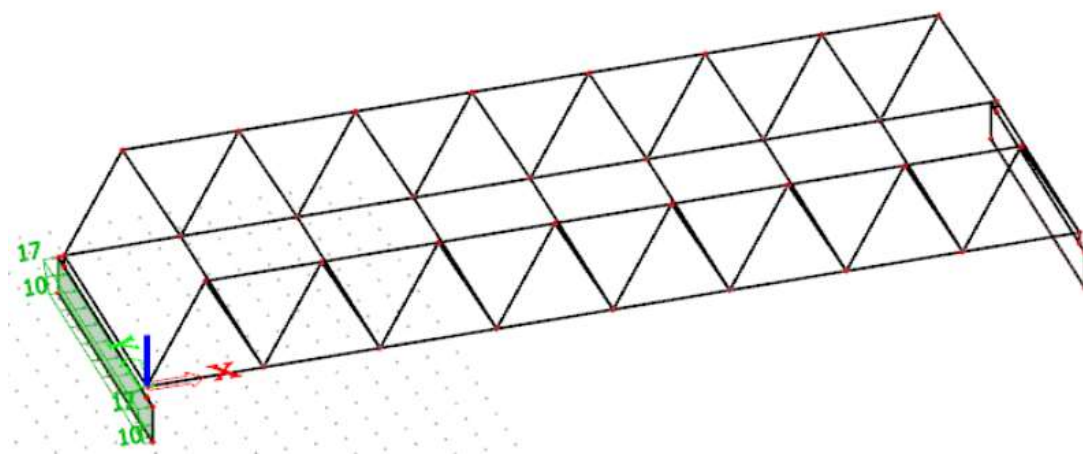

Slika 68. Pritisak tla od vozila

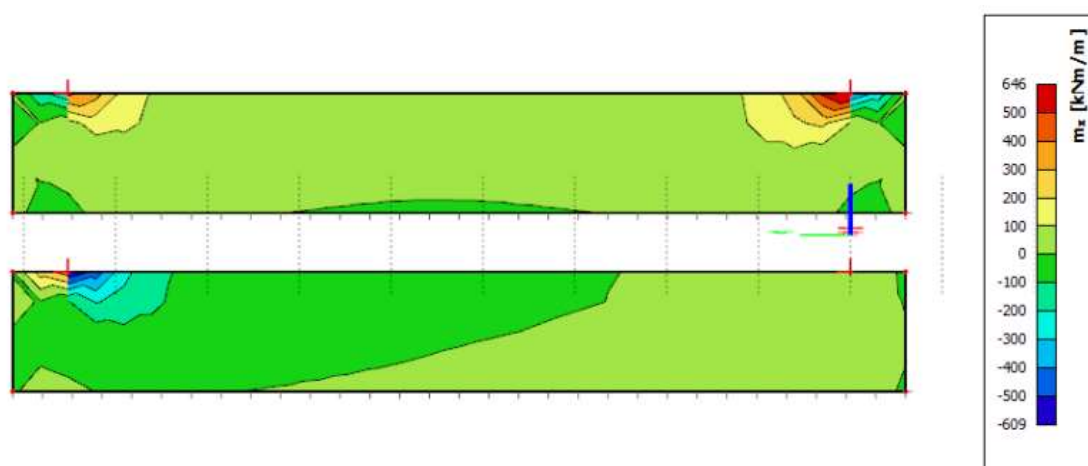
Slika 69. Moment savijanja M_x

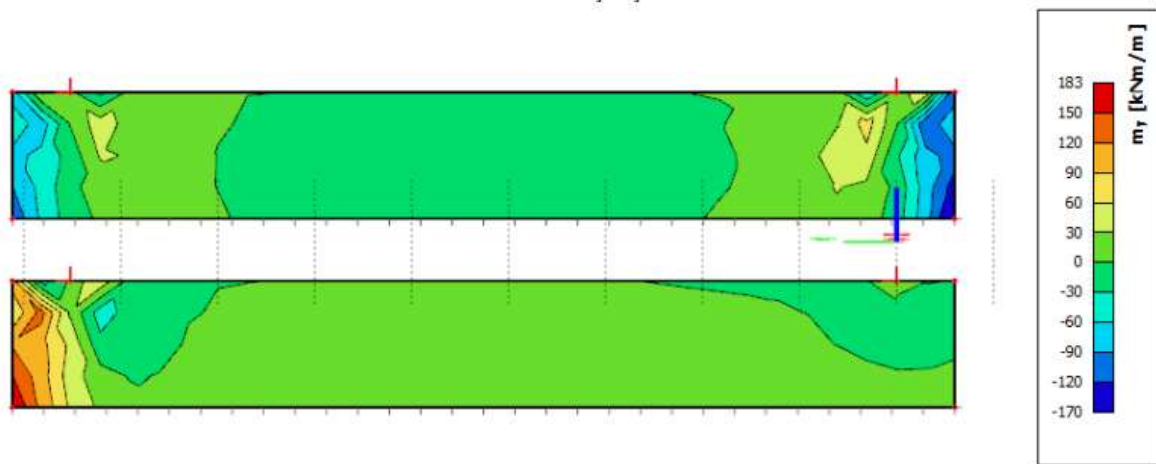

Slika 70. Moment savijanja M_y

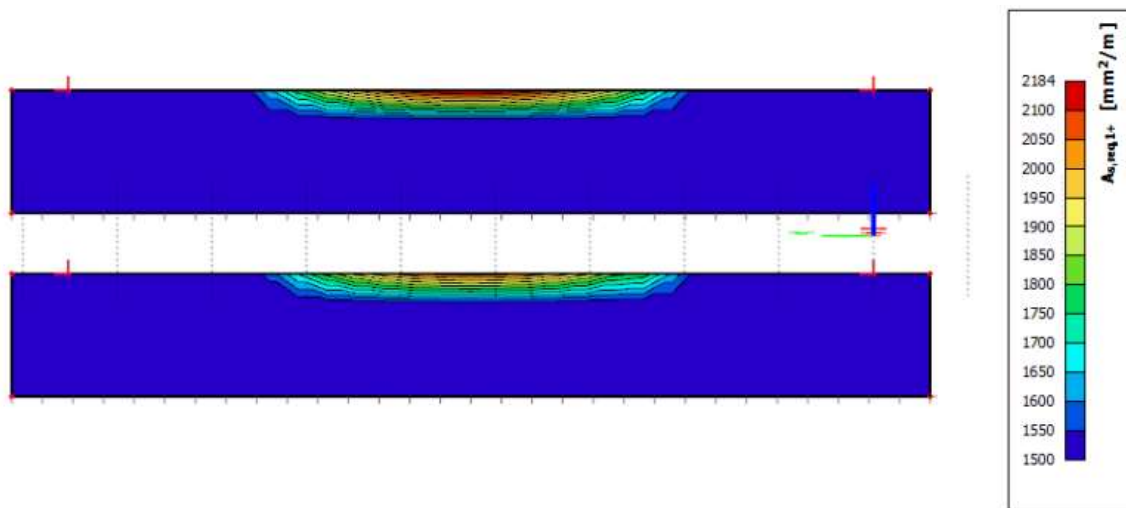

Slika 71. Potrebna horizontalna armatura prema nasipu

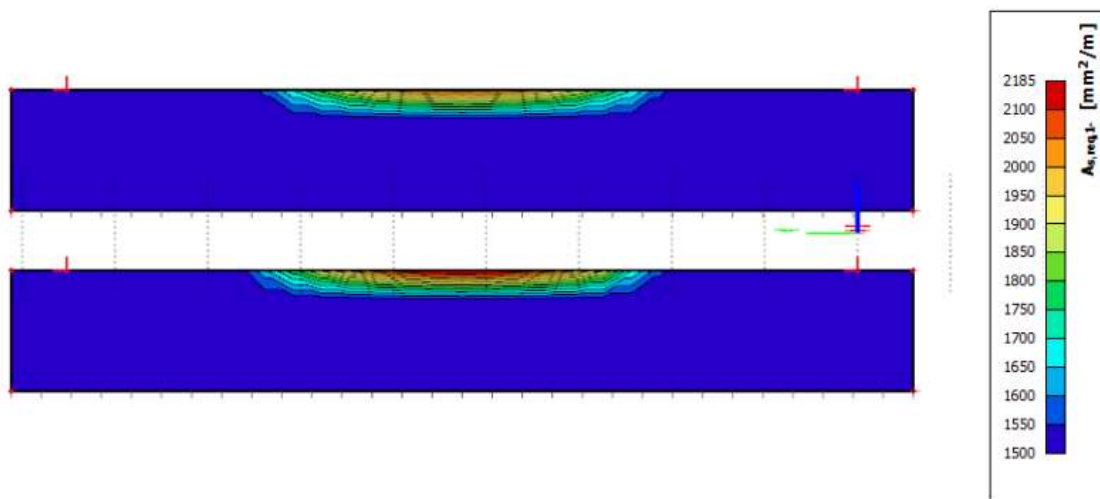

Slika 72. Potrebna horizontalna armatura prema van



Slika 73. Potrebna vertikalna armatura prema nasipu

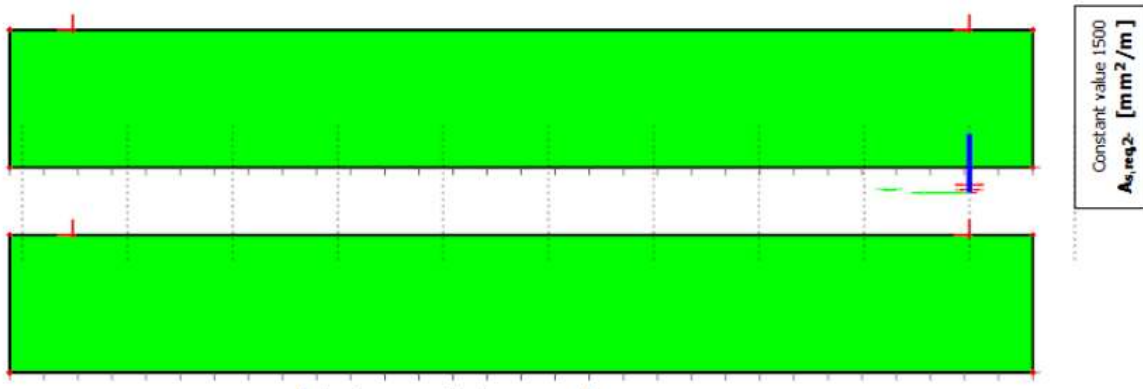

Slika 74. Potrebna vertikalna armatura prema van

Odabrana armatura zida upornjaka:

-Donja zona:

14 Φ 20 (ili Φ 20/10, širina upornjaka 150 cm), $A_{s,1} = 43,98 \text{ cm}^2$

-Gornja zona:

14 Φ 25 (ili Φ 25/10, širina upornjaka 150 cm), $A_{s,2} = 68,72 \text{ cm}^2$

-Vilice:

14 Φ 25 (ili Φ 25/10, širina upornjaka 150 cm), $A_{s,2} = 68,72 \text{ cm}^2$

Uzdužna armatura po visini: 7 Φ 20

Ankeri za sidrenje u postojeći temelj: Φ 20/20 ($L_{\text{sidrenja}} = 1\text{m}$)

TEMELJNA GREDA		Minimalna armatura		Maksimalna armatura
C 45/55	$f_{yk}=500 \text{ N/mm}^2$	$A_{s1,min} = 0,26 \cdot b \cdot d \cdot \frac{f_{ctm}}{f_{yk}}$	$A_{s1,min} = 0,0013 \cdot b \cdot d$	$A_{s1,max} = 0,031 \cdot A_c$
b = 150,0 cm h = 130,0 cm	c = 5,0 cm d = 125,0 cm	As1,min = 37,05 cm²/m	As1,min = 24,38 cm²/m	As1,max = 604,50 cm²/m
ZID		Minimalna armatura		Maksimalna armatura
C 45/55	Vertikalna armatura 1 zona:	$A_{sv,min} = 0,001 \cdot t \cdot L$		$A_{sv,max} = 0,02 \cdot t \cdot L$
t = 150,0 cm l = 100,0 cm	Horizontalna armatura 1 zona:	$A_{sh,min} = 0,0005 \cdot t \cdot L$	$A_{sh,min} = 0,25 \cdot A_{sv,min}$	$A_{sh,max} = 0,02 \cdot t \cdot L$
		Ash1,min = 7,50 cm²/m	Ash1,min = 3,75 cm²/m	Ash1,max = 300,00 cm²/m

Slika 75. Provjera uvjeta minimalne i maksimalne armature

Odabrana armatura se nalazi između dozvoljene minimalne i maksimalne armature.

7.2.3 Proračun krila i prsnog zida upornjaka

Inercijalna sila upornjaka:

$$F_i = kh \cdot dz_{ID} \cdot g = 0,21 \cdot 0,30 \cdot 25 = 1,58 \text{ kN/m}^2 \text{ (prсни zid upornjaka)}$$

$$F_i = kh \cdot dz_{ID} \cdot g = 0,21 \cdot 1,50 \cdot 25 = 7,88 \text{ kN/m}^2 \text{ (tijelo upornjaka - vrh)}$$

$$F_i = kh \cdot dz_{ID} \cdot g = 0,21 \cdot 0,30 \cdot 25 = 1,58 \text{ kN/m}^2 \text{ (krilo upornjaka)}$$

Dinamička sila na dnu prouzročena tlakom zemlje na zid:

$$E_{din} = \alpha \cdot S \cdot g \cdot h = 0,21 \cdot 1,5 \cdot 20 \cdot 2,30 = 14,50 \text{ kN/m}^2$$

Ukupna sila koja djeluje na element konstrukcije prilikom potresa:

$$F_i + E_{din}$$

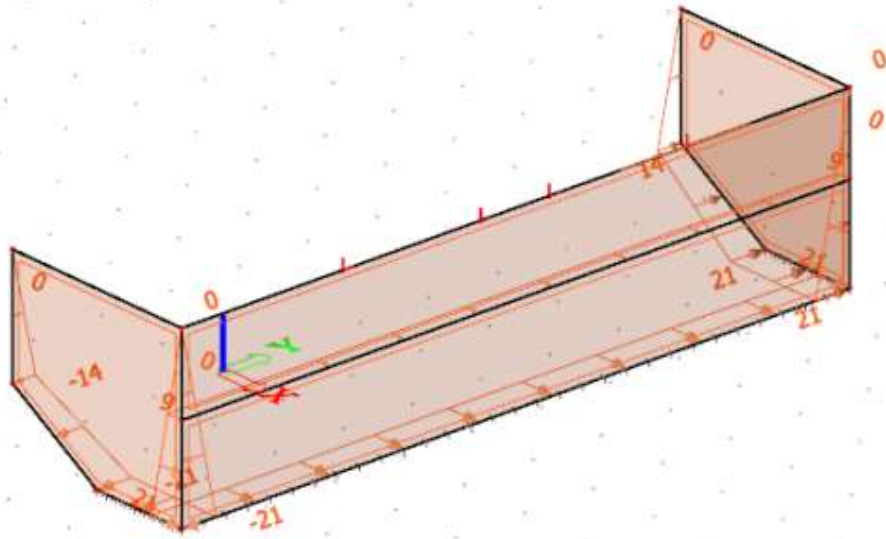

Slika 78. Pritisak tla i vozila

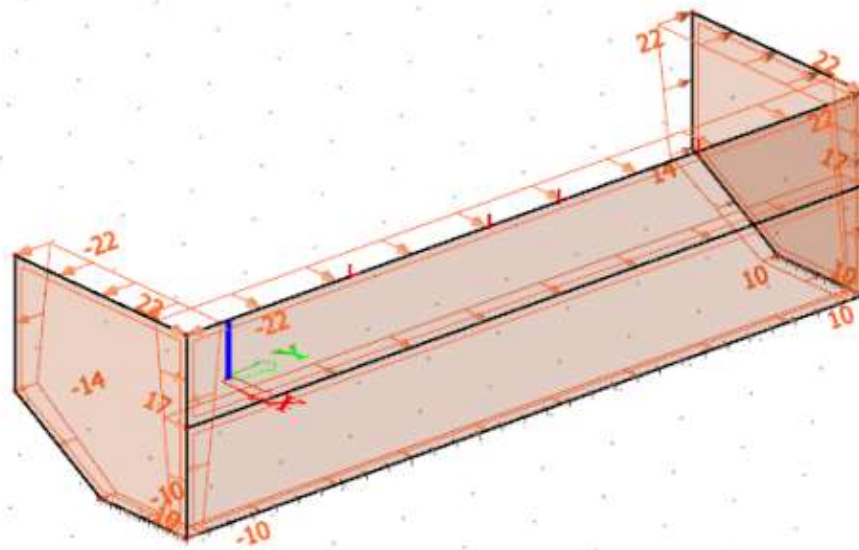

Slika 79. Potresno opterećenje

7.2.4 Prsni zid upornjaka - rezne sile

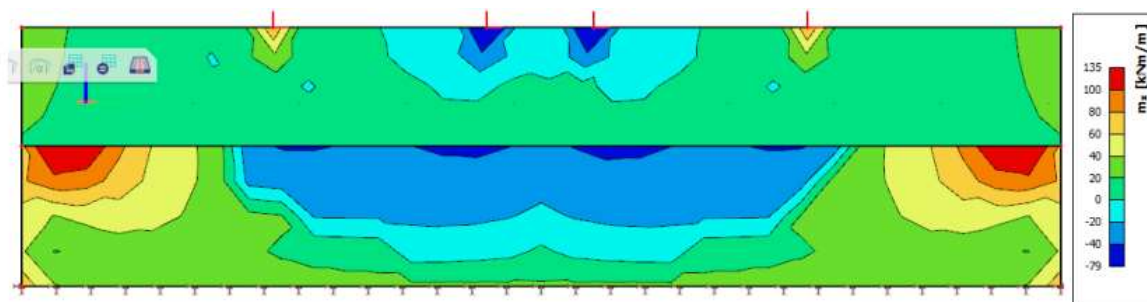

Slika 80. Moment savijanja M_x

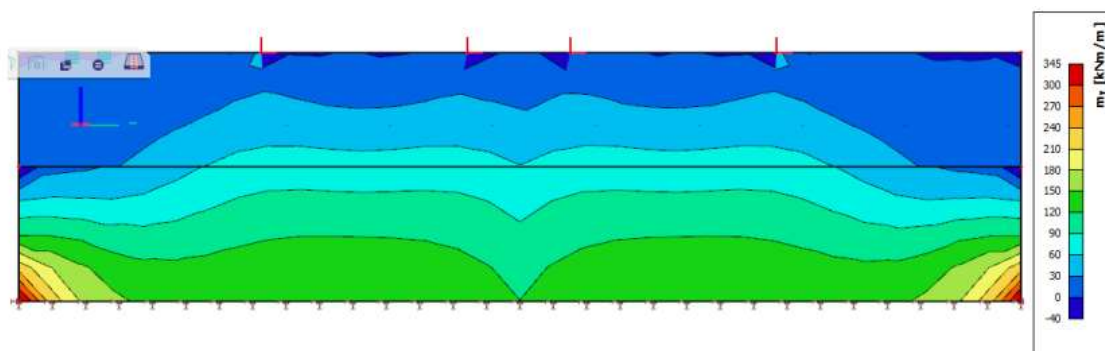

Slika 81. Moment savijanja M_y

7.2.5 Krila - rezne sile

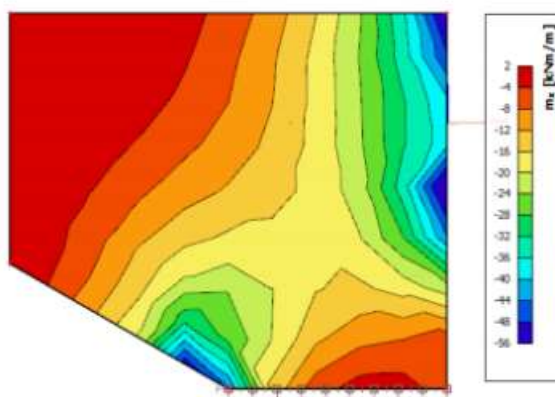

Slika 82. Moment savijanja M_x

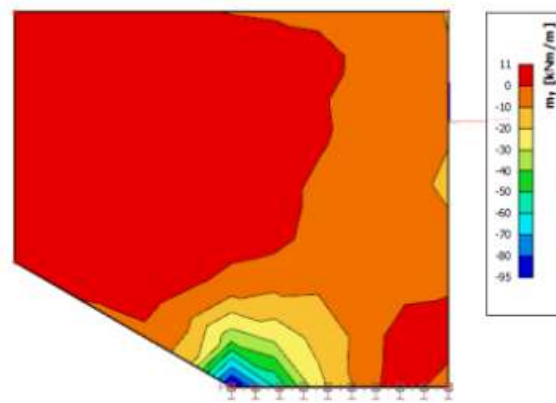
Slika 83. Moment savijanja M_y

7.2.6 Proračun potrebne armature prsnog zida

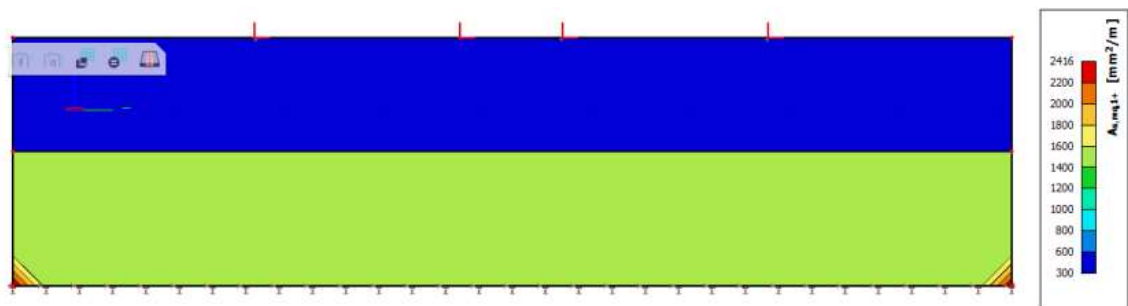

Slika 84. Horizontalna armatura prema van

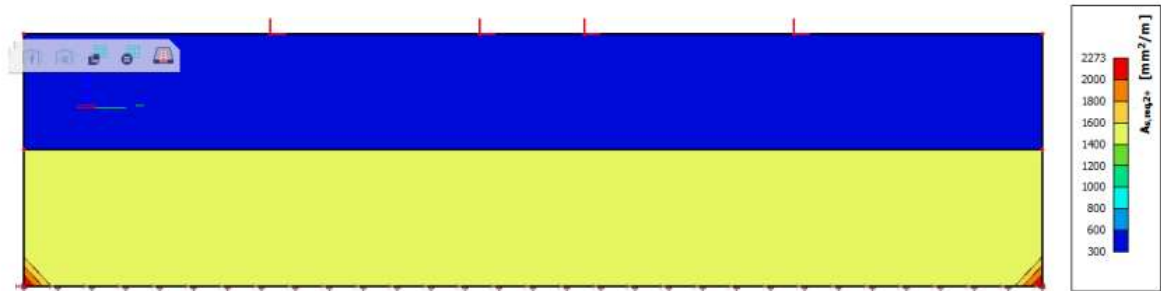

Slika 85. Vertikalna armatura prema van

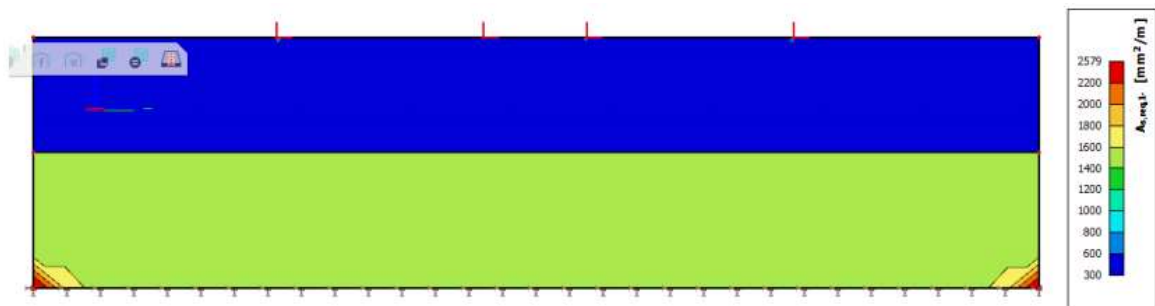

Slika 86. Horizontalna armatura prema nasipu

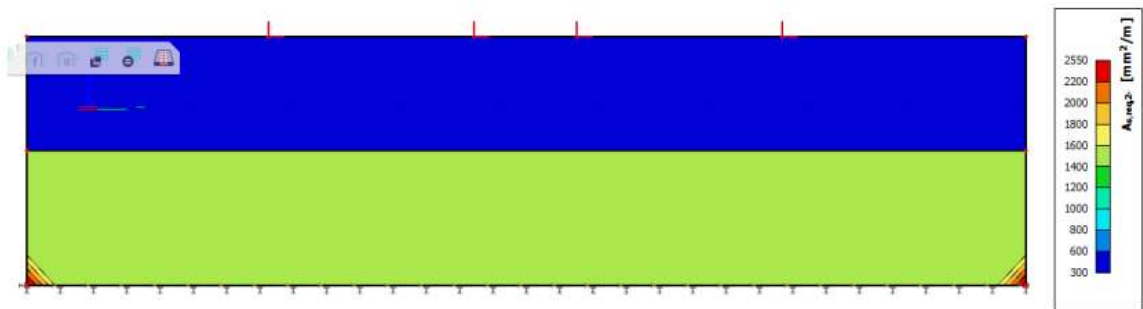

Slika 87. Vertikalna armatura prema nasipu

7.2.7 Proračun potrebne armature krila

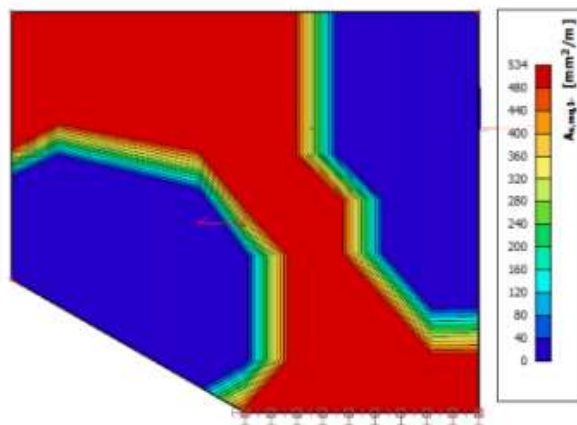

Slika 88. Horizontalna armatura prema van

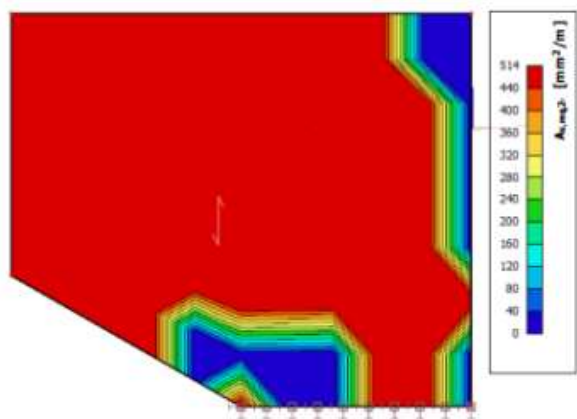

Slika 89. Vertikalna armatura prema van

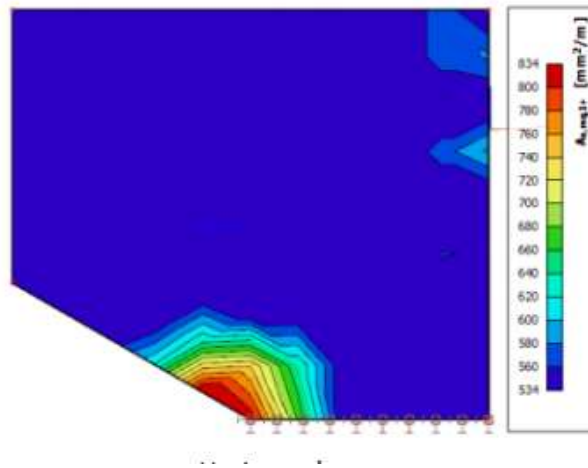

Slika 90. Horizontalna armatura prema nasipu

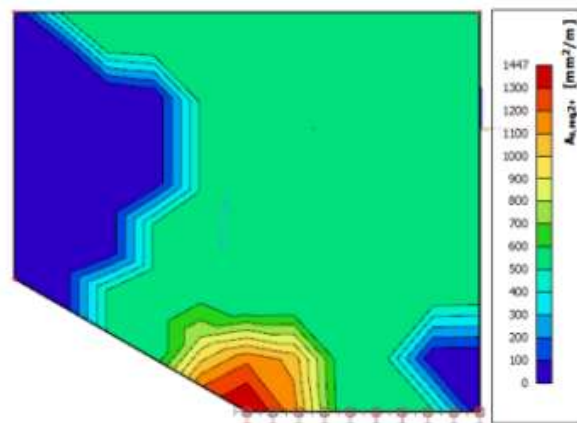

Slika 91. Vertikalna armatura prema nasipu

Odabrana armatura prsnog zida:

-Vertikalna:

$\Phi 12/10$, $A_s = 11,30 \text{ cm}^2$

-Horizontalna:

$\Phi 10/10$, $A_s = 7,85 \text{ cm}^2$

Odabrana armatura krila:

-Vertikalna:

$\Phi 16/15$ $A_s = 13,39 \text{ cm}^2$ – oba lica (ankeri $\Phi 20/15$)

$\Phi 12/10$ $A_s = 11,30 \text{ cm}^2$ – prema van

-Horizontalna:

$\Phi 12/10$ $A_s = 11,30 \text{ cm}^2$ – prema nasipu

$\Phi 10/10$ $A_s = 7,85 \text{ cm}^2$ – prema van

7.2.8 Proračun postojeće temeljne ploče

Model temelja je modeliran pločama debljine 320cm (C20/25) za postojeću i 150cm (C30/37) za nadograđenu.

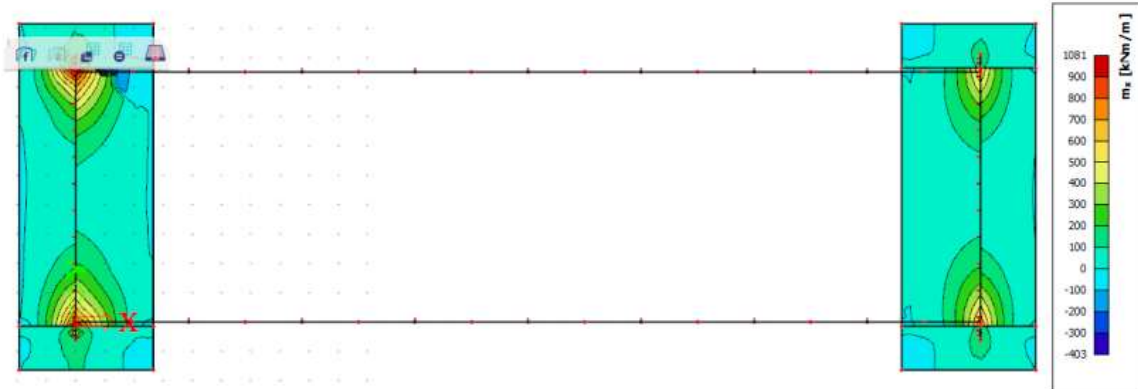

Slika 92. Moment savijanja uzdužno na most - M_x

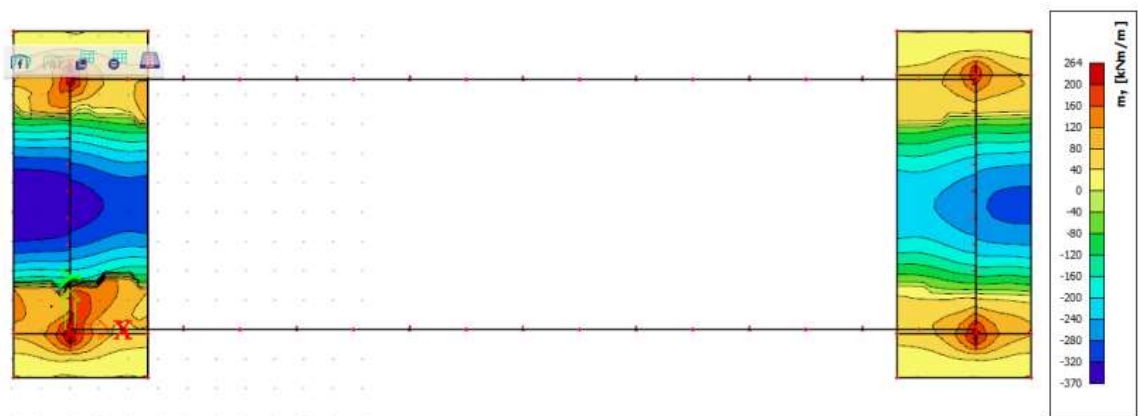

Slika 93. Moment savijanja poprečno na most - M_y

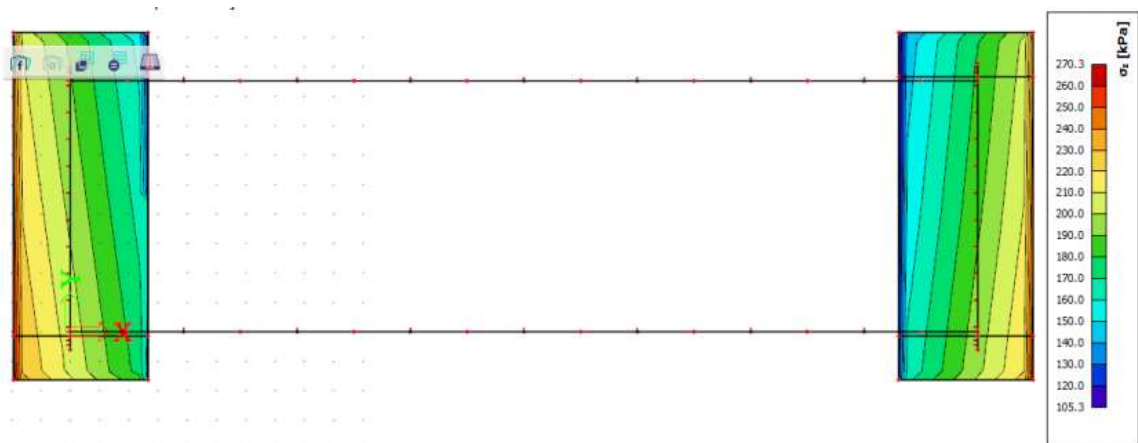

Slika 94. Anvelopa GSN - kontaktna naprezanja

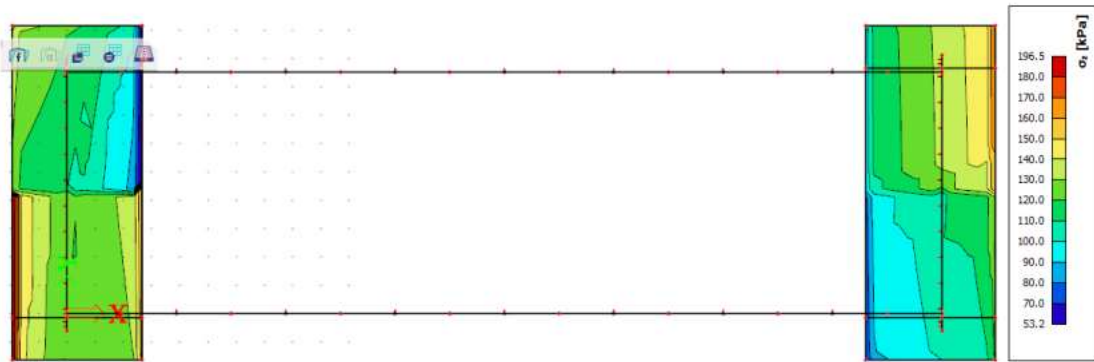

Slika 95. Anvelopa potres - kontaktna naprezanja

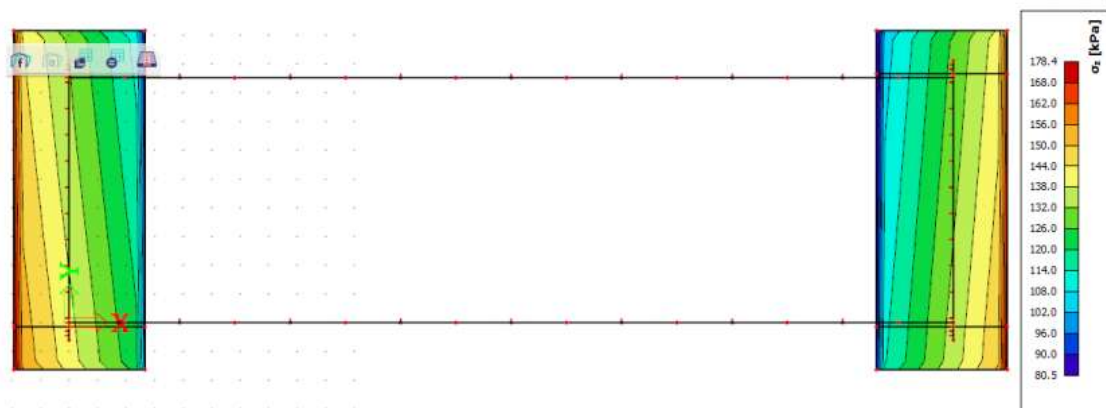

Slika 96. Anvelopa GSU - kontaktna naprezanja

7.2.9 Proračun potrebne armature postojeće ploče

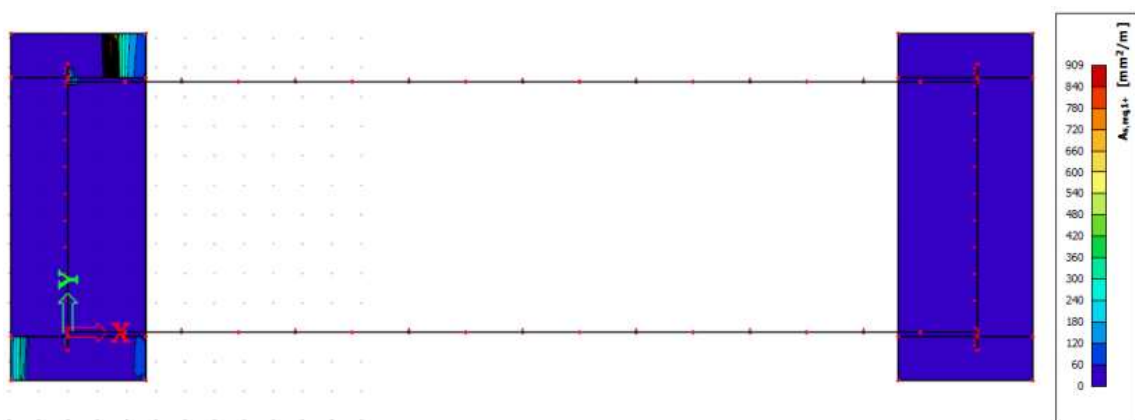

Slika 97. Gornja zona - uzdužno na most

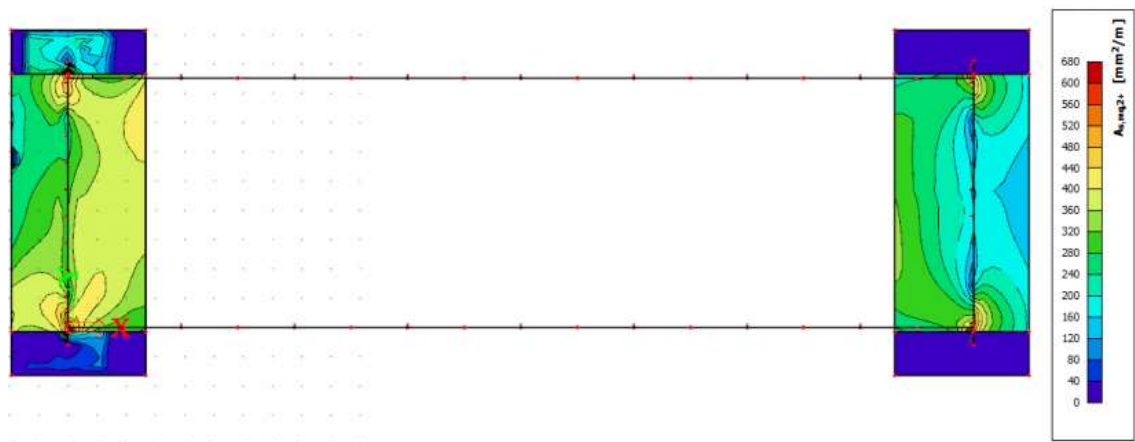

Slika 98. Gornja zona - poprečno na most

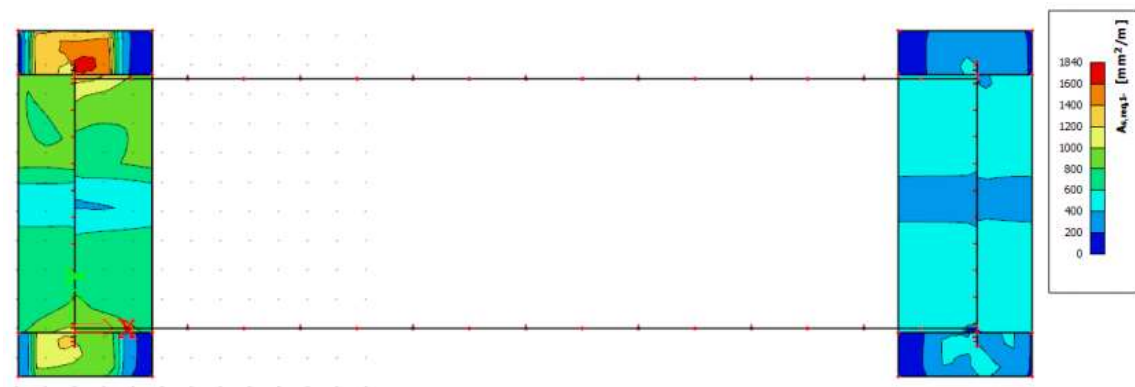

Slika 99. Donja zona - uzdužno na most

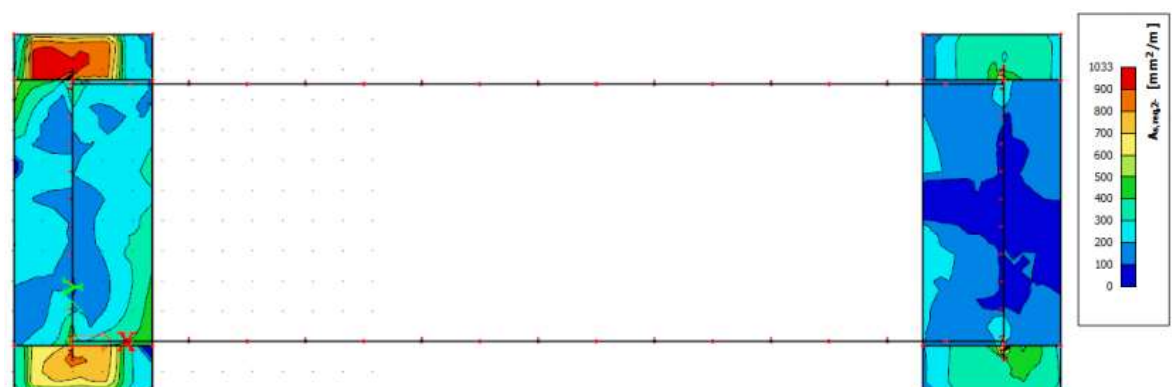

Slika 100. Donja zona - poprečno na most

PLOČA		Minimalna armatura		Maksimalna armatura
C 30/37	$f_{yk}=500 \text{ N/mm}^2$	$A_{s1,min} = 0,26 \cdot b \cdot d \cdot \frac{f_{ctm}}{f_{yk}}$	$A_{s1,min} = 0,0013 \cdot b \cdot d$	$A_{s1,max} = 0,031 \cdot A_c$
$b = 100,0 \text{ cm}$ $h = 150,0 \text{ cm}$	$c = 5,0 \text{ cm}$ $d = 145,0 \text{ cm}$	$A_{s1,min} = 21,87 \text{ cm}^2/\text{m}$	$A_{s1,min} = 18,85 \text{ cm}^2/\text{m}$	$A_{s1,max} = 465,00 \text{ cm}^2/\text{m}$

Slika 101. Provjera uvjeta minimalne i maksimalne armature

Odabrana armatura:

- $\Phi 20/15$ u obje zone i smjera

Ankeri za povezivanje sa starim temeljem

- $\Phi 28/30$ u gornjoj i donjoj zoni

- $\Phi 20/30$ po visini na horizontalnim razmacima 150 cm

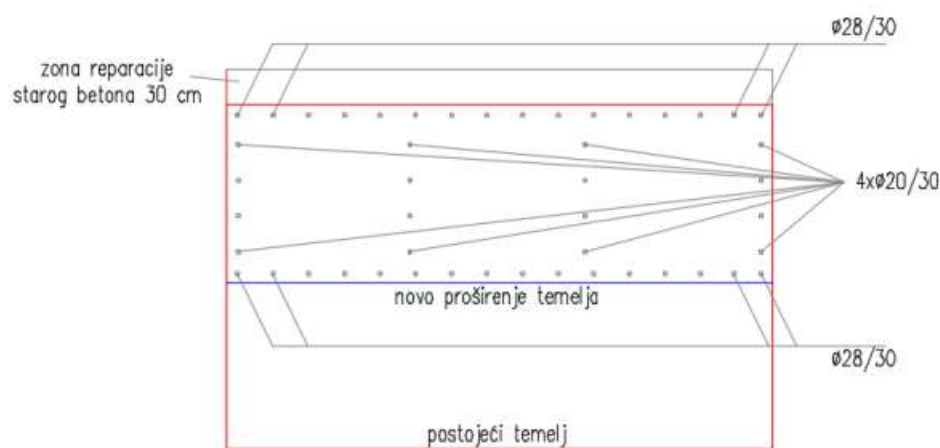

Slika 102. Shema armature proširenja postojećeg temelja

7.3 Provjera graničnog stanja uporabivosti (GSU)

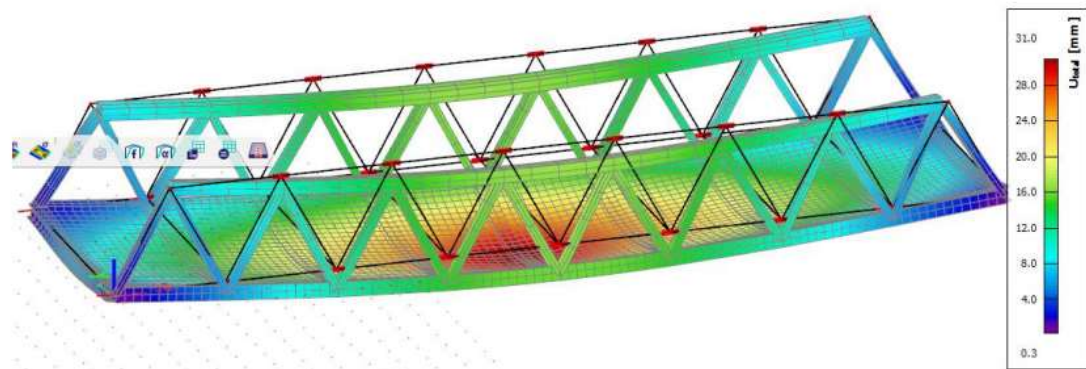

Slika 103. Granično stanje uporabivosti

$$U_{z,max} = 31,00 \text{ mm}$$

$$U_{z,dop} = 31\,000 / 500 = 62 \text{ mm}$$

KONSTRUKCIJA ZADOVOLJAVA GRANIČNO STANJE UPORABIVOSTI.

8. PRORAČUN SPOJEVA

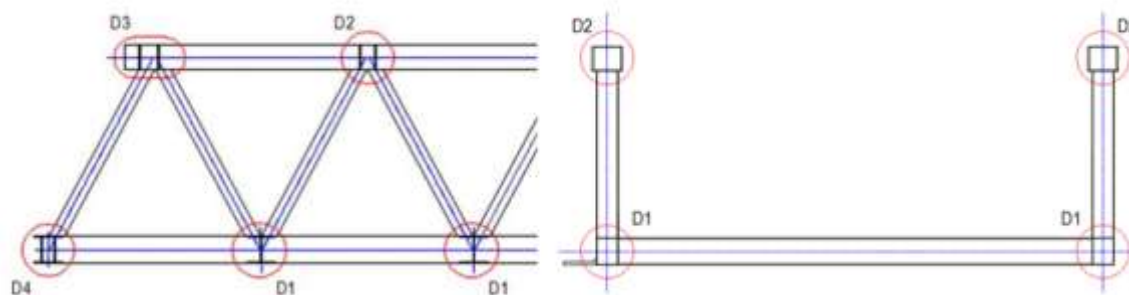

Slika 104. Oznake spojeva

8.1 Spoj D1 (Donji pojas - unutarnje dijagonale)

Geometry

Name	Cross-section	β - Direction [°]	γ - Pitch [°]	α - Rotation [°]	Offset e_x [mm]	Offset e_y [mm]	Offset e_z [mm]
B27	1 - I400	0,0	-61,0	90,0	0	-10	0
B35	1 - I400	-180,0	-61,0	90,0	0	-10	0
B47	4 - donji pojas(500/400) (BoxWeb500x(400/400))	0,0	0,0	0,0	0	0	0
B60	3 - I500	90,0	0,0	0,0	0	0	0

Supports and forces

Name	Support	Forces in	X [mm]
B27 / begin		Position	0
B35 / begin		Position	0
B47 / begin	N-Vy-Vz-Mx-My-Mz	Position	0
B47 / end		Position	0
B60 / begin		Position	698

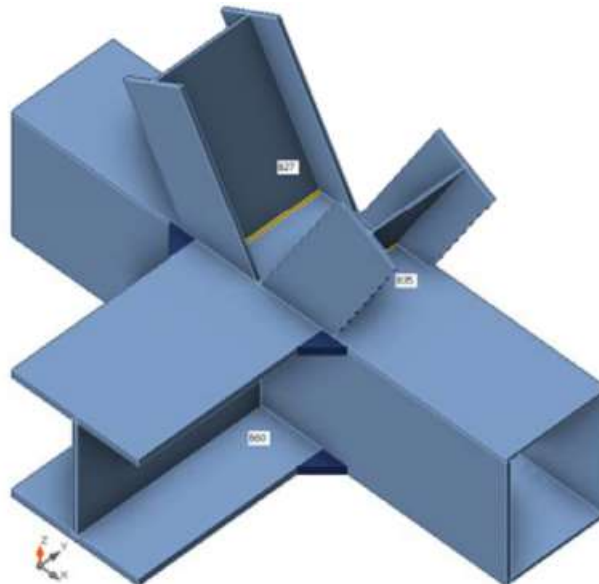

Slika 105. Prikaz modela D1

Cross-sections

Name	Material
1 - I400	S 355
4 - donji pojasx(500/400) (BoxWeb500x(400/400))	S 355
3 - I500	S 355

Load effects

Name	Member	N [kN]	Vy [kN]	Vz [kN]	Mx [kNm]	My [kNm]	Mz [kNm]
Reference	B27 / Begin	-97,9	-0,9	0,0	0,0	0,0	0,0
	B35 / Begin	-97,9	-0,9	0,0	0,0	0,0	0,0
	B47 / Begin	-348,1	2,1	-4,2	-0,1	22,7	-2,5
	B47 / End	348,2	2,1	-4,2	-0,1	-22,7	2,5
	B60 / Begin	-5,2	0,1	-157,5	0,0	-5,4	0,0
zamor	B27 / Begin	-234,1	-0,9	0,0	0,0	0,0	0,0
	B35 / Begin	-234,2	-0,9	0,0	0,0	0,0	0,0
	B47 / Begin	-529,4	3,4	-0,5	-38,7	48,2	-4,0
	B47 / End	531,9	3,6	-0,5	-38,8	-48,2	4,3
	B60 / Begin	-8,4	2,2	-390,3	0,0	-90,3	-0,1

Check

Summary

Name	Value	Check status
Plates	0,0 < 5,0%	OK

Plates

Name	t_p [mm]	Loads	σ_{Ed} [MPa]	ϵ_{pl} [%]	$\sigma_{c,Ed}$ [MPa]	Elastic	Status
B27-bfl 1	16,0	zamor	66,2	0,0	0,0	OK	OK
B27-tfl 1	16,0	zamor	53,8	0,0	0,0	OK	OK
B27-w 1	12,0	zamor	56,1	0,0	0,0	OK	OK
B35-bfl 1	16,0	zamor	47,9	0,0	0,0	OK	OK
B35-tfl 1	16,0	zamor	49,3	0,0	0,0	OK	OK
B35-w 1	12,0	zamor	42,0	0,0	0,0	OK	OK
B47-tfl 1	16,0	zamor	115,6	0,0	0,0	OK	OK
B47-bfl 1	16,0	zamor	130,7	0,0	0,0	OK	OK
B47-w 1	18,0	zamor	111,1	0,0	0,0	OK	OK
B47-w 2	18,0	zamor	101,3	0,0	0,0	OK	OK
B60-bfl 1	30,0	zamor	70,1	0,0	0,0	OK	OK
B60-tfl 1	30,0	zamor	88,9	0,0	0,0	OK	OK
B60-w 1	18,0	zamor	88,2	0,0	0,0	OK	OK
SP1	25,0	zamor	126,3	0,0	0,0	OK	OK
WID2a	30,0	zamor	125,2	0,0	0,0	OK	OK
WID2b	30,0	zamor	84,0	0,0	0,0	OK	OK
WID2c	30,0	zamor	157,4	0,0	0,0	OK	OK
WID2d	30,0	zamor	117,4	0,0	0,0	OK	OK
SP7	25,0	zamor	152,5	0,0	0,0	OK	OK

Design data

Material	f_y [MPa]	ϵ_{lim} [%]
S 355	355,0	5,0

Symbol explanation

t_p	Plate thickness
σ_{Ed}	Equivalent stress
ϵ_{pl}	Plastic strain
$\sigma_{c,Ed}$	Contact stress
f_y	Yield strength
ϵ_{lim}	Limit of plastic strain

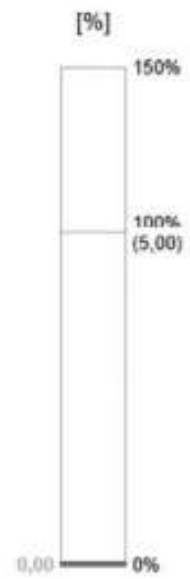
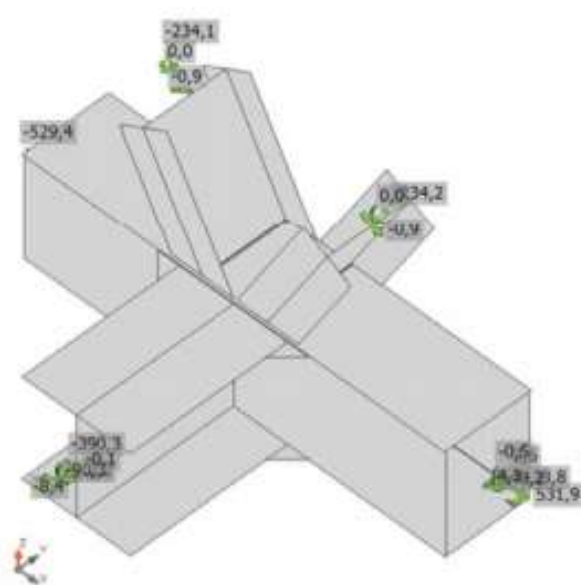
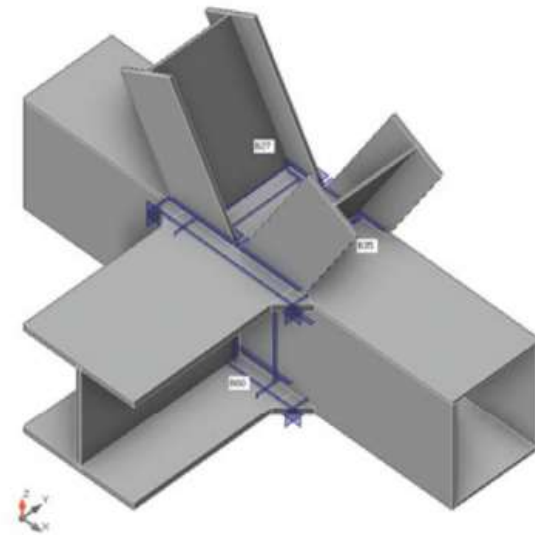

Strain check, zamor

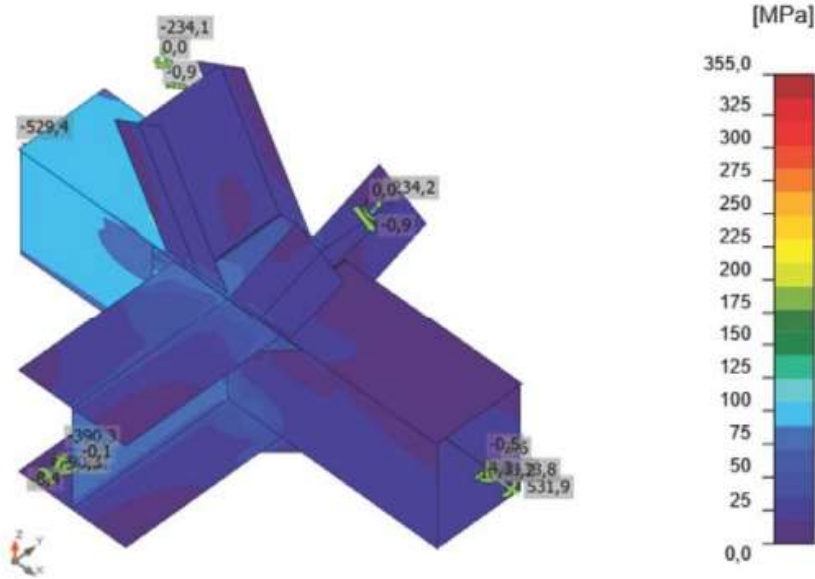

Welds

Item	Edge	Section	T _H [mm]	L [mm]	Loads	σ _{max} [MPa]	τ [MPa]	τ _{max} [MPa]	σ [MPa]	Elastic
B47-tfl 1	B27-bfl 1	B47-tfl 1	16,0	286	zamor	8,9	-28,7	-29,2	8,4	OK
B47-tfl 1	B27-bfl 1	B27-bfl 1	16,0	286	zamor	31,3	-5,6	-9,8	29,5	OK
B47-tfl 1	B27-tfl 1	B27-tfl 1	16,0	286	zamor	23,7	-7,7	-8,5	11,9	OK
B47-tfl 1	B27-w 1	B47-tfl 1	4,0	384	zamor	-6,8	20,3	21,4	-3,3	OK
B47-tfl 1	B27-w 1	B27-w 1	4,0	384	zamor	28,0	12,5	12,5	28,0	OK
B47-w 1	SP1	B47-w 1	25,0	408	zamor	21,6	-1,1	-10,8	12,9	OK
B47-w 1	SP1	SP1	25,0	408	zamor	-28,5	8,4	14,3	-18,8	OK
B47-tfl 1	SP1	B47-tfl 1	25,0	304	zamor	-3,1	5,0	5,8	-0,6	OK
B47-tfl 1	SP1	SP1	25,0	304	zamor	6,1	-10,7	-10,7	6,1	OK
B47-w 2	SP1	B47-w 2	25,0	408	zamor	17,4	6,2	6,3	17,3	OK
B47-w 2	SP1	SP1	25,0	408	zamor	6,8	7,6	10,7	0,0	OK
B47-tfl 1	B35-bfl 1	B47-tfl 1	16,0	286	zamor	40,1	-8,8	-8,8	40,1	OK
B47-tfl 1	B35-bfl 1	B35-bfl 1	16,0	286	zamor	18,8	-8,0	-9,0	10,2	OK
B47-tfl 1	B35-tfl 1	B35-tfl 1	16,0	286	zamor	18,4	-11,4	-11,4	18,4	OK
B47-tfl 1	B35-w 1	B47-tfl 1	4,0	384	zamor	6,5	2,6	5,6	2,5	OK
B47-tfl 1	B35-w 1	B35-w 1	4,0	384	zamor	24,1	-11,4	-11,4	24,1	OK
B47-w 1	B60-bfl 1	B47-w 1	30,0	500	zamor	33,2	-24,6	-35,7	4,4	OK
B47-w 1	B60-bfl 1	B60-bfl 1	30,0	500	zamor	-45,0	8,3	8,3	-45,0	OK
B47-w 1	B60-tfl 1	B60-tfl 1	30,0	500	zamor	57,1	-16,4	-16,4	57,1	OK
B47-w 1	B60-w 1	B47-w 1	18,0	469	zamor	34,8	26,2	26,2	34,8	OK
B47-w 1	B60-w 1	B60-w 1	18,0	469	zamor	29,4	26,5	28,6	10,0	OK
B47-w 1	WID2a	B47-w 1	30,0	100	zamor	4,2	-35,8	-35,9	3,5	OK
B47-w 1	WID2a	WID2a	30,0	100	zamor	-39,0	15,6	20,3	-23,8	OK
B60-bfl 1	WID2a	WID2a	30,0	100	zamor	-17,7	-20,2	-20,2	-17,7	OK
B47-w 1	WID2b	WID2b	30,0	100	zamor	-24,7	10,2	13,2	-14,8	OK
B60-bfl 1	WID2b	B60-bfl 1	30,0	100	zamor	12,3	0,9	1,4	-3,3	OK
B60-bfl 1	WID2b	WID2b	30,0	100	zamor	-10,8	-12,0	-12,0	-10,8	OK
B47-w 1	WID2c	WID2c	30,0	100	zamor	50,7	-22,0	-25,4	33,2	OK
B60-tfl 1	WID2c	B60-tfl 1	30,0	100	zamor	11,8	9,5	9,5	11,7	OK
B60-tfl 1	WID2c	WID2c	30,0	100	zamor	20,0	21,2	26,8	15,1	OK
B47-w 1	WID2d	B47-w 1	30,0	100	zamor	8,8	4,7	4,7	6,3	OK
B47-w 1	WID2d	WID2d	30,0	100	zamor	37,9	-17,9	-20,0	26,6	OK
B60-tfl 1	WID2d	WID2d	30,0	100	zamor	15,2	15,7	15,7	15,2	OK
B47-w 1	SP7	B47-w 1	25,0	408	zamor	23,9	25,2	29,9	-7,7	OK
B47-w 1	SP7	SP7	25,0	408	zamor	-36,6	9,0	16,1	-25,0	OK
B47-tfl 1	SP7	B47-tfl 1	25,0	304	zamor	6,8	16,5	23,4	-2,6	OK
B47-tfl 1	SP7	SP7	25,0	304	zamor	8,0	-9,3	-12,1	7,0	OK
B47-w 2	SP7	B47-w 2	25,0	408	zamor	20,0	-9,0	-14,2	4,6	OK
B47-w 2	SP7	SP7	25,0	408	zamor	11,4	7,6	11,3	5,6	OK

Symbol explanation

T_h	Throat thickness of weld
L	Length of weld
σ_{max}	Maximum normal stress
τ	Shear stress corresponding to maximum normal stress
τ_{max}	Maximum shear stress
σ	Normal stress corresponding to maximum shear stress

Welds

Item	Edge	T_h [mm]	L [mm]	Loads	$\sigma_{wf, max}$ [MPa]	τ_{wf} [MPa]	$\tau_{wf, max}$ [MPa]	σ_{wf} [MPa]	Elastic
B47-tfl 1	B27-w 1	4,0	384	zamor	14,3	9,1	14,0	11,0	OK
		4,0	384	zamor	22,7	-12,1	19,6	3,6	OK
B47-tfl 1	B35-w 1	4,0	384	zamor	15,8	-6,2	-6,6	11,3	OK
		4,0	384	zamor	18,4	15,7	-21,1	15,6	OK

Symbol explanation

T_h	Throat thickness of weld
L	Length of weld
$\sigma_{wf, max}$	Maximum normal stress transverse to the axis of the weld
τ_{wf}	Corresponding shear stress longitudinal to the axis of the weld
$\tau_{wf, max}$	Maximum shear stress longitudinal to the axis of the weld
σ_{wf}	Corresponding normal stress transverse to the axis of the weld

Welds

Item	Edge	T_w [mm]	L [mm]	Loads	$\sigma_{w,Ed}$ [MPa]	ϵ_{PI} [%]	σ_{\perp} [MPa]	τ_{\perp} [MPa]	τ_{\parallel} [MPa]	Ut [%]	Ut _c [%]	Status
B47-tfl 1	B27-bfl 1	-	286	-	-	-	-	-	-	-	-	OK
B47-tfl 1	B27-tfl 1	-	286	-	-	-	-	-	-	-	-	OK
B47-tfl 1	B27-w 1	▲ 4,0 ▲	383	zamor	48,7	0,0	8,9	17,4	-21,4	11,2	10,3	OK
		▲ 4,0 ▲	383	zamor	74,2	0,0	8,3	-32,1	-28,0	17,0	13,9	OK
B47-w 1	SP1	-	408	-	-	-	-	-	-	-	-	OK
B47-tfl 1	SP1	-	304	-	-	-	-	-	-	-	-	OK
B47-w 2	SP1	-	408	-	-	-	-	-	-	-	-	OK
B47-tfl 1	B35-bfl 1	-	286	-	-	-	-	-	-	-	-	OK
B47-tfl 1	B35-tfl 1	-	286	-	-	-	-	-	-	-	-	OK
B47-tfl 1	B35-w 1	▲ 4,0 ▲	383	zamor	36,7	0,0	20,4	15,7	-7,9	8,4	8,4	OK
		▲ 4,0 ▲	383	zamor	72,8	0,0	12,6	-23,2	-34,3	16,7	13,9	OK
B47-w 1	B60-bfl 1	-	500	-	-	-	-	-	-	-	-	OK
B47-w 1	B60-tfl 1	-	500	-	-	-	-	-	-	-	-	OK
B47-w 1	R60-w 1	-	469	-	-	-	-	-	-	-	-	OK
B47-w 1	WD2a	-	100	-	-	-	-	-	-	-	-	OK
B60-bfl 1	WD2a	-	100	-	-	-	-	-	-	-	-	OK
B47-w 1	WD2b	-	100	-	-	-	-	-	-	-	-	OK
B60-bfl 1	WD2b	-	100	-	-	-	-	-	-	-	-	OK
B47-w 1	WD2c	-	100	-	-	-	-	-	-	-	-	OK
B60-tfl 1	WD2c	-	100	-	-	-	-	-	-	-	-	OK
B47-w 1	WD2d	-	100	-	-	-	-	-	-	-	-	OK
B60-tfl 1	WD2d	-	100	-	-	-	-	-	-	-	-	OK
B47-w 1	SP7	-	408	-	-	-	-	-	-	-	-	OK
B47-tfl 1	SP7	-	304	-	-	-	-	-	-	-	-	OK
B47-w 2	SP7	-	408	-	-	-	-	-	-	-	-	OK

Design data

Material	f_u [MPa]	β_w [-]	$\sigma_{w,Rd}$ [MPa]	$0,9 \sigma$ [MPa]
S 355	0,0	-	-	-
S 355	490,0	0,90	435,6	352,8

8.2 Spoj D2 (Gornji pojas - unutarnje dijagonale)

Geometry

Name	Cross-section	β - Direction [°]	γ - Pitch [°]	α - Rotation [°]	Offset e_x [mm]	Offset e_y [mm]	Offset e_z [mm]
B19	3 - BoxWeb450x(450/550) (BoxWeb450x(550/550))	0,0	0,0	0,0	0	0	0
B34	4 - Iw400x250	0,0	-61,0	90,0	0	30	0
B35	4 - Iw400x250	-180,0	-61,0	90,0	0	30	0

Supports and forces

Name	Support	Forces in	X [mm]
B19 / begin	N-Vy-Vz-Mx-My-Mz	Position	0
B19 / end		Position	0
B34 / end		Position	0
B35 / end		Position	0

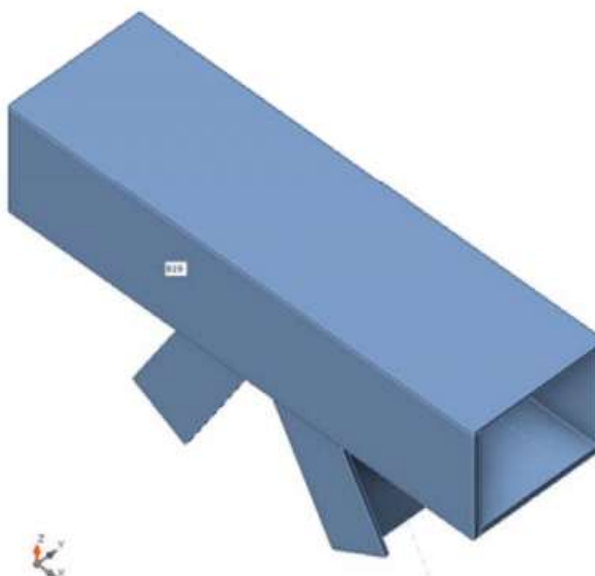

Slika 106. Prikaz modela D2

Cross-sections

Name	Material
3 - BoxWeb450x(450/550) (BoxWeb450x(550/550))	S 355
4 - Iw400x250	S 355

Load effects

Name	Member	N [kN]	Vy [kN]	Vz [kN]	Mx [kNm]	My [kNm]	Mz [kNm]
GSN2(2)	B34 / End	-288,0	-0,9	0,0	0,0	0,0	0,0
	B35 / End	272,6	-0,9	0,0	0,0	0,0	0,0
GSN1(3)	B34 / End	-445,8	-0,9	0,0	0,0	0,0	0,0
	B35 / End	439,2	-0,9	0,0	-0,1	0,0	0,0

Check

Summary

Name	Value	Check status
Plates	0,0 < 5,0%	OK

Plates

Name	t_p [mm]	Loads	σ_{Ed} [MPa]	ϵ_{pl} [%]	$\sigma_{c,Ed}$ [MPa]	Elastic	Status
B19-tfl 1	16,0	GSN1(3)	18,8	0,0	0,0	OK	OK
B19-bfl 1	30,0	GSN1(3)	39,4	0,0	0,0	OK	OK
B19-w 1	30,0	GSN1(3)	35,2	0,0	0,0	OK	OK
B19-w 2	30,0	GSN1(3)	35,2	0,0	0,0	OK	OK
B34-tfl 1	16,0	GSN1(3)	64,3	0,0	0,0	OK	OK
B34-bfl 1	16,0	GSN1(3)	63,7	0,0	0,0	OK	OK
B34-w 1	12,0	GSN1(3)	37,5	0,0	0,0	OK	OK
B35-tfl 1	16,0	GSN1(3)	62,2	0,0	0,0	OK	OK
B35-bfl 1	16,0	GSN1(3)	61,0	0,0	0,0	OK	OK
B35-w 1	12,0	GSN1(3)	36,8	0,0	0,0	OK	OK
SP1	20,0	GSN1(3)	33,5	0,0	0,0	OK	OK
SP2	20,0	GSN1(3)	34,8	0,0	0,0	OK	OK

Design data

Material	f_y [MPa]	ϵ_{lim} [%]
S 355	355,0	5,0

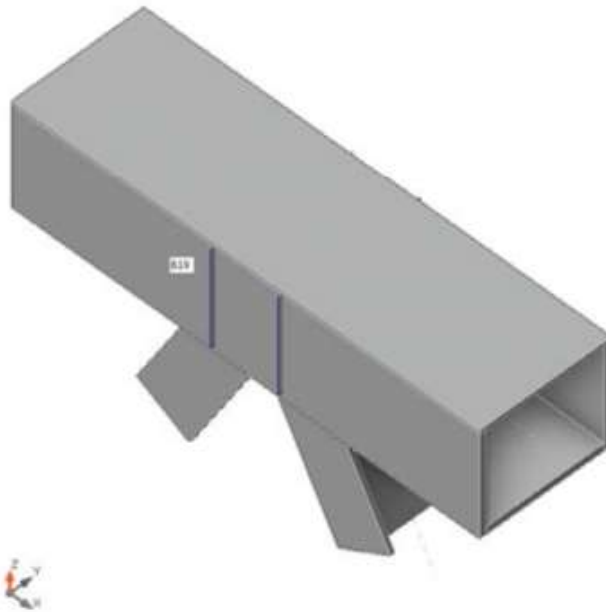

Overall check, GSN1(3)

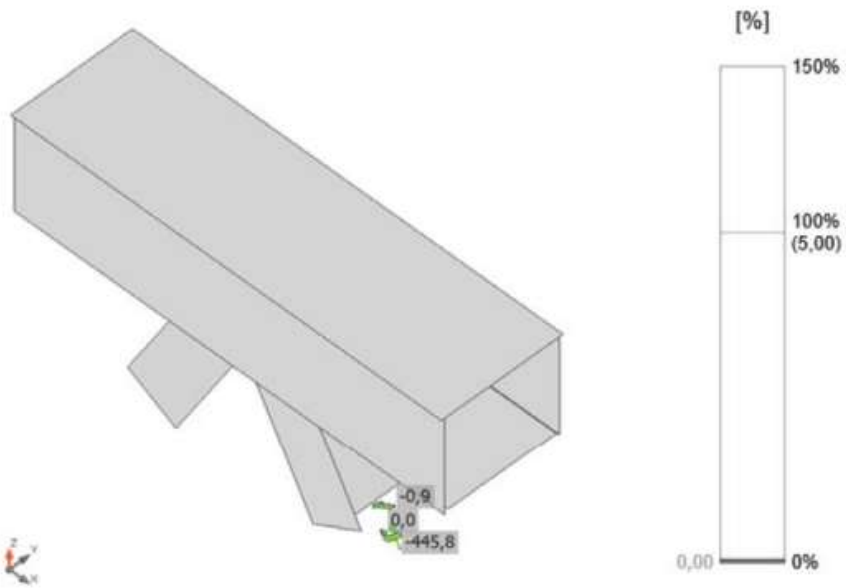

Strain check, GSN1(3)

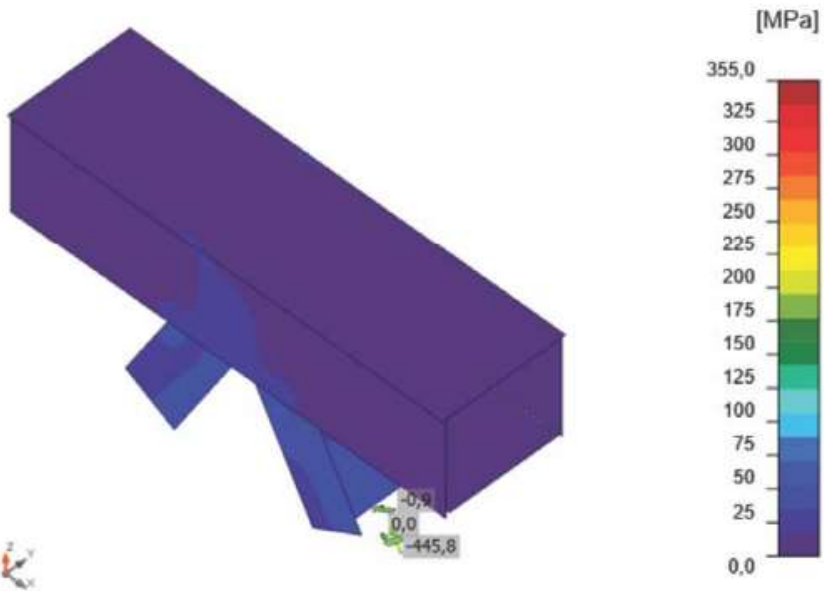

Equivalent stress, GSN1(3)

Welds

Item	Edge	Section	T _h [mm]	L [mm]	Loads	σ _{max} [MPa]	τ [MPa]	T _{max} [MPa]	σ [MPa]	Elastic
B19-bfl 1	B34-tfl 1	B19-bfl 1	5,0	286	GSN1(3)	-8,7	0,4	0,5	-6,3	OK
B19-bfl 1	B34-tfl 1	B34-tfl 1	5,0	286	GSN1(3)	-17,7	-12,3	-12,9	-17,6	OK
B19-bfl 1	B34-bfl 1	B19-bfl 1	5,0	286	GSN1(3)	-9,2	-0,4	-0,5	-5,9	OK
B19-bfl 1	B34-bfl 1	B34-bfl 1	5,0	286	GSN1(3)	-17,3	-12,1	-12,6	-17,2	OK
B19-bfl 1	B34-w 1	B19-bfl 1	4,0	368	GSN1(3)	-3,3	0,6	-1,0	-2,4	OK
B19-bfl 1	B34-w 1	B34-w 1	4,0	368	GSN1(3)	-12,3	0,3	-3,0	-11,4	OK
B19-bfl 1	B35-tfl 1	B19-bfl 1	4,0	286	GSN1(3)	8,7	-0,5	-0,5	8,7	OK
B19-bfl 1	B35-tfl 1	B35-tfl 1	4,0	286	GSN1(3)	17,8	12,9	13,9	17,5	OK
B19-bfl 1	B35-bfl 1	B19-bfl 1	4,0	286	GSN1(3)	9,6	0,6	0,6	9,5	OK
B19-bfl 1	B35-bfl 1	B35-bfl 1	4,0	286	GSN1(3)	16,8	12,2	13,1	16,3	OK
B19-bfl 1	B35-w 1	B19-bfl 1	4,0	368	GSN1(3)	-4,4	-0,2	2,6	-4,0	OK
B19-bfl 1	B35-w 1	B35-w 1	4,0	368	GSN1(3)	13,0	-0,4	3,2	12,2	OK
B19-bfl 1	SP1	B19-bfl 1	4,0	490	GSN1(3)	-3,9	-1,4	4,5	-1,2	OK
B19-bfl 1	SP1	SP1	4,0	490	GSN1(3)	10,9	3,6	5,6	7,0	OK
B19-w 1	SP1	B19-w 1	4,0	404	GSN1(3)	-7,0	-2,0	-3,5	-1,3	OK
B19-w 1	SP1	SP1	4,0	404	GSN1(3)	6,1	2,5	6,3	1,8	OK
B19-w 2	SP1	B19-w 2	4,0	404	GSN1(3)	-7,1	-1,9	-3,4	-1,4	OK
B19-w 2	SP1	SP1	4,0	404	GSN1(3)	6,3	-2,5	-6,3	1,8	OK
B19-bfl 1	SP2	B19-bfl 1	4,0	490	GSN1(3)	-5,1	1,6	1,6	-5,1	OK
B19-bfl 1	SP2	SP2	4,0	490	GSN1(3)	-9,8	3,7	5,7	-6,1	OK
B19-w 1	SP2	B19-w 1	4,0	404	GSN1(3)	-3,5	-3,7	-3,7	-3,5	OK
B19-w 1	SP2	SP2	4,0	404	GSN1(3)	-4,0	-1,6	-6,2	-1,3	OK
B19-w 2	SP2	B19-w 2	4,0	404	GSN1(3)	-3,5	-3,8	-3,8	-3,5	OK
B19-w 2	SP2	SP2	4,0	404	GSN1(3)	-4,0	1,6	6,2	-1,3	OK

8.3 Spoj D3 (Gornji pojas - rubne dijagonale)

Members

Geometry

Name	Cross-section	β - Direction [°]	γ - Pitch [°]	α - Rotation [°]	Offset ex [mm]	Offset ey [mm]	Offset ez [mm]
B19	4 - BoxFI450x(550/550)	0,0	0,0	0,0	-550	0	0
B23	5 - BoxFI400x(250/250)	-180,0	-61,0	90,0	0	30	0
B24	3 - I400	0,0	-61,0	90,0	0	30	0

Supports and forces

Name	Support	Forces in	X [mm]
B19 / end	N-Vy-Vz-Mx-My-Mz	Position	0
B23 / end		Position	0
B24 / end		Position	0

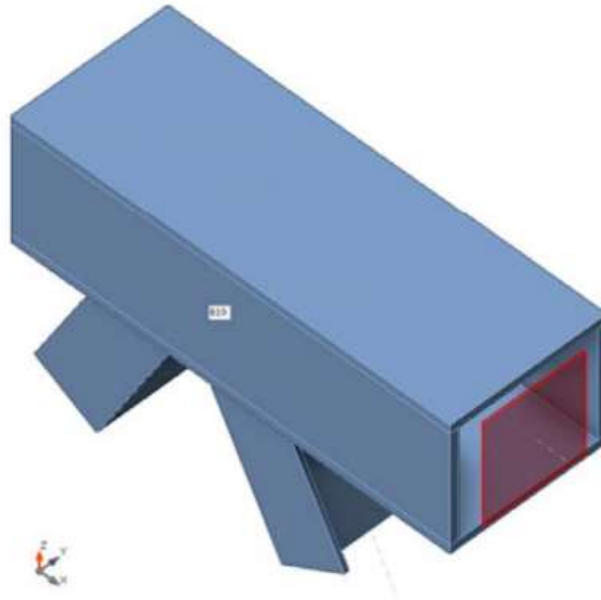

Slika 107. Prikaz modela D3

Cross-sections

Name	Material
4 - BoxFI450x(550/550)	S 355
5 - BoxFI400x(250/250)	S 355
3 - I400	S 355

Load effects

Name	Member	N [kN]	Vy [kN]	Vz [kN]	Mx [kNm]	My [kNm]	Mz [kNm]
Reference	B19 / End	-751,9	0,0	-22,4	0,0	26,8	-1,7
	B23 / End	-780,8	-14,9	0,0	-1,4	0,8	-26,8
	B24 / End	746,5	-0,9	0,0	0,0	0,0	0,0
zamor	B19 / End	-1027,3	0,0	-26,8	0,0	35,3	-2,1
	B23 / End	-1065,2	-18,8	0,0	-1,9	1,1	-35,3
	B24 / End	1023,6	-0,9	0,0	0,0	0,0	0,0

Check

Summary

Name	Value	Check status
Plates	0,0 < 5,0%	OK

Plates

Name	t_p [mm]	Loads	σ_{Ed} [MPa]	ϵ_{p1} [%]	$\sigma_{c,Ed}$ [MPa]	Elastic	Status
B19-tfl 1	30,0	zamor	33,8	0,0	0,0	OK	OK
B19-bfl 1	30,0	zamor	75,3	0,0	0,0	OK	OK
B19-w 1	30,0	zamor	72,2	0,0	0,0	OK	OK
B19-w 2	30,0	zamor	71,6	0,0	0,0	OK	OK
B23-tfl 1	16,0	zamor	133,8	0,0	0,0	OK	OK
B23-bfl 1	16,0	zamor	135,4	0,0	0,0	OK	OK
B23-w 1	16,0	zamor	127,2	0,0	0,0	OK	OK
B23-w 2	16,0	zamor	53,9	0,0	0,0	OK	OK
B24-bfl 1	16,0	zamor	149,6	0,0	0,0	OK	OK
B24-tfl 1	16,0	zamor	151,9	0,0	0,0	OK	OK
B24-w 1	12,0	zamor	98,7	0,0	0,0	OK	OK
SP1	25,0	zamor	42,5	0,0	0,0	OK	OK
SP2	25,0	zamor	108,7	0,0	0,0	OK	OK
SP3	25,0	zamor	75,9	0,0	0,0	OK	OK

Design data

Material	f_y [MPa]	ϵ_{lim} [%]
S 355	355,0	5,0

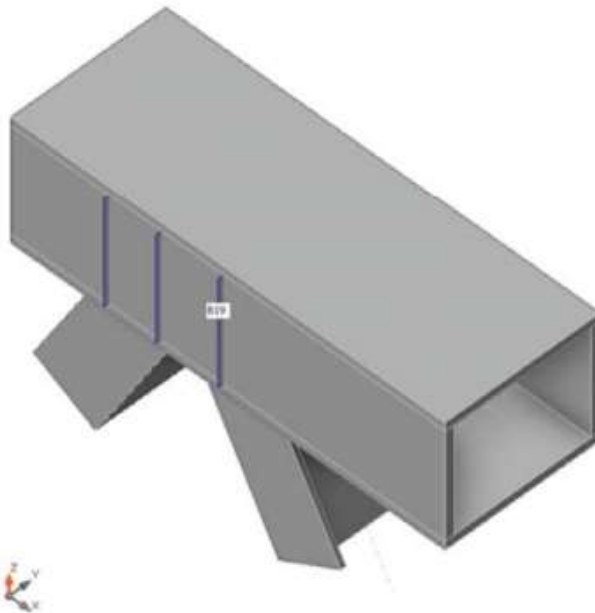

Overall check, zamor

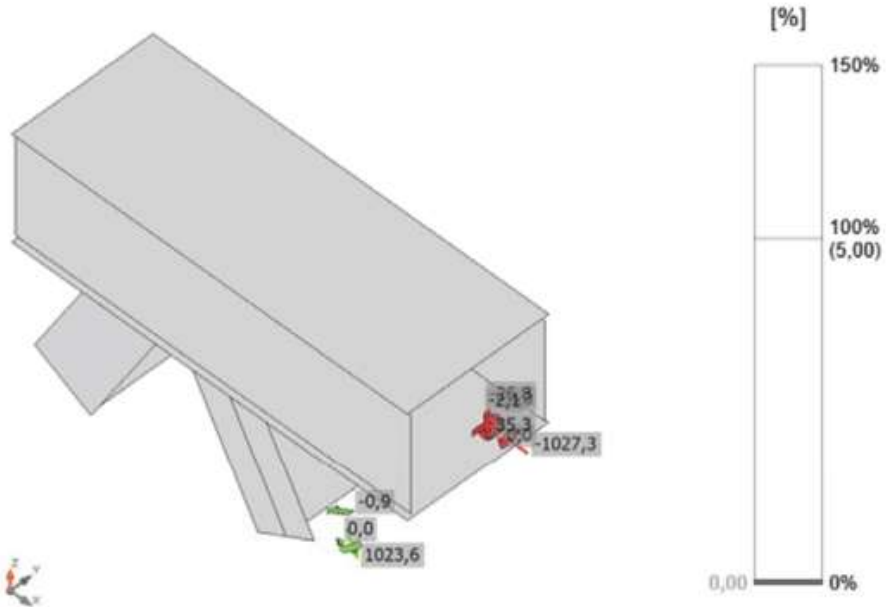

Strain check, zamor

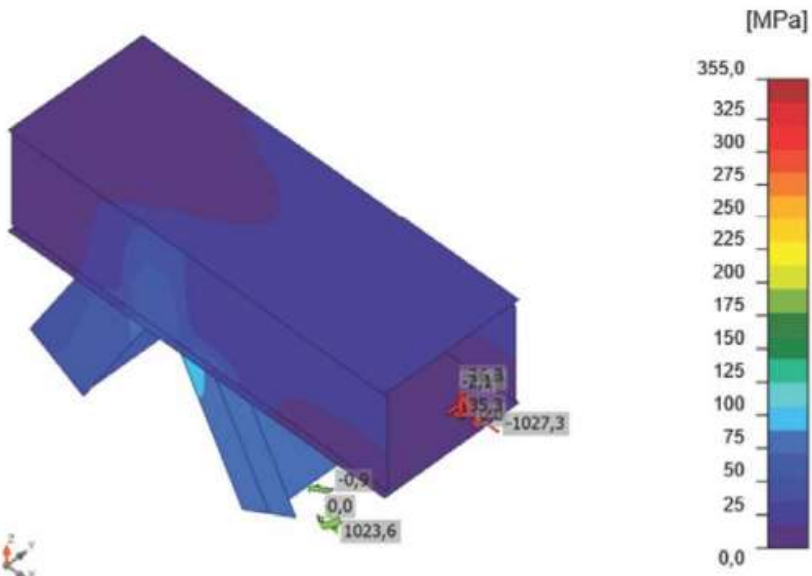

Equivalent stress, zamor

Welds

Item	Edge	Section	T _h [mm]	L [mm]	Loads	σ _{max} [MPa]	τ [MPa]	τ _{max} [MPa]	σ [MPa]	Elastic
B19-bfl 1	B23-tfl 1	B19-bfl 1	16,0	286	zamor	-4,8	-3,6	-3,6	-4,8	OK
B19-bfl 1	B23-tfl 1	B23-tfl 1	16,0	286	zamor	-23,8	-14,7	-14,7	-23,8	OK
B19-bfl 1	B23-bfl 1	B19-bfl 1	16,0	286	zamor	-6,7	1,8	3,2	-5,0	OK
B19-bfl 1	B23-bfl 1	B23-bfl 1	16,0	286	zamor	-24,6	-14,9	-14,9	-24,6	OK
B19-bfl 1	B23-w 1	B19-bfl 1	16,0	368	zamor	-16,9	0,0	2,5	-7,3	OK
B19-bfl 1	B23-w 1	B23-w 1	16,0	368	zamor	-31,2	7,8	7,8	-31,2	OK
B19-bfl 1	B23-w 2	B19-bfl 1	16,0	368	zamor	-2,0	-1,2	-1,2	-2,0	OK
B19-bfl 1	B23-w 2	B23-w 2	16,0	368	zamor	-13,2	4,5	5,4	-12,9	OK
B19-bfl 1	B24-bfl 1	B19-bfl 1	16,0	286	zamor	13,0	0,4	2,2	8,2	OK
B19-bfl 1	B24-bfl 1	B24-bfl 1	16,0	286	zamor	28,9	14,5	14,8	21,6	OK
B19-bfl 1	B24-tfl 1	B19-bfl 1	16,0	286	zamor	7,2	1,3	2,8	4,2	OK
B19-bfl 1	B24-tfl 1	B24-tfl 1	16,0	286	zamor	29,6	14,8	15,1	22,0	OK
B19-bfl 1	B24-w 1	B19-bfl 1	12,0	384	zamor	-10,7	0,0	-6,3	-4,8	OK
B19-bfl 1	B24-w 1	B24-w 1	12,0	384	zamor	28,0	-7,1	8,6	27,2	OK
B19-bfl 1	SP1	B19-bfl 1	25,0	470	zamor	-4,3	-3,4	-3,4	-4,3	OK
B19-bfl 1	SP1	SP1	25,0	470	zamor	-7,6	-1,8	4,4	-2,5	OK
B19-w 1	SP1	B19-w 1	25,0	384	zamor	-4,7	3,1	3,8	-2,4	OK
B19-w 1	SP1	SP1	25,0	384	zamor	-2,4	-1,3	-3,6	-0,1	OK
B19-w 2	SP1	B19-w 2	25,0	384	zamor	-4,6	3,0	3,7	-2,3	OK
B19-w 2	SP1	SP1	25,0	384	zamor	-2,6	1,3	3,6	0,0	OK
B19-bfl 1	SP2	B19-bfl 1	25,0	470	zamor	-10,5	0,0	-7,4	-3,2	OK
B19-bfl 1	SP2	SP2	25,0	470	zamor	17,6	3,2	-6,6	8,6	OK
B19-w 1	SP2	B19-w 1	25,0	384	zamor	-8,5	1,4	3,2	-2,4	OK
B19-w 1	SP2	SP2	25,0	384	zamor	6,8	6,5	6,5	6,8	OK
B19-w 2	SP2	B19-w 2	25,0	384	zamor	-8,4	1,4	3,2	-2,3	OK
B19-w 2	SP2	SP2	25,0	384	zamor	6,5	-6,5	-6,5	6,5	OK
B19-bfl 1	SP3	B19-bfl 1	25,0	470	zamor	-14,9	-0,9	3,9	-10,8	OK
B19-bfl 1	SP3	SP3	25,0	470	zamor	-10,3	-1,9	5,1	-4,3	OK
B19-w 1	SP3	B19-w 1	25,0	384	zamor	-4,5	9,6	10,3	-3,9	OK
B19-w 1	SP3	SP3	25,0	384	zamor	-5,2	-4,0	-4,2	-3,1	OK
B19-w 2	SP3	B19-w 2	25,0	384	zamor	-4,2	9,5	10,3	-3,7	OK
B19-w 2	SP3	SP3	25,0	384	zamor	-5,2	3,9	4,2	-2,5	OK

Welds

Item	Edge	T _w [mm]	L [mm]	Loads	σ _{w,Ed} [MPa]	ε _{pI} [%]	σ _⊥ [MPa]	τ _⊥ [MPa]	τ [MPa]	Ut [%]	Ut _c [%]	Detailing	Status
B19-bfl 1	B23-tfl 1	-	286	-	-	-	-	-	-	-	-	OK	OK
B19-bfl 1	B23-bfl 1	-	286	-	-	-	-	-	-	-	-	OK	OK
B19-bfl 1	B23-w 1	-	368	-	-	-	-	-	-	-	-	OK	OK
B19-bfl 1	B23-w 2	-	368	-	-	-	-	-	-	-	-	OK	OK
B19-bfl 1	B24-bfl 1	-	286	-	-	-	-	-	-	-	-	OK	OK
B19-bfl 1	B24-tfl 1	-	286	-	-	-	-	-	-	-	-	OK	OK
B19-bfl 1	B24-w 1	-	384	-	-	-	-	-	-	-	-	OK	OK
B19-bfl 1	SP1	-	470	-	-	-	-	-	-	-	-	OK	OK
B19-w 1	SP1	-	384	-	-	-	-	-	-	-	-	OK	OK
B19-w 2	SP1	-	384	-	-	-	-	-	-	-	-	OK	OK
B19-bfl 1	SP2	-	470	-	-	-	-	-	-	-	-	OK	OK
B19-w 1	SP2	-	384	-	-	-	-	-	-	-	-	OK	OK
B19-w 2	SP2	-	384	-	-	-	-	-	-	-	-	OK	OK
B19-bfl 1	SP3	-	470	-	-	-	-	-	-	-	-	OK	OK
B19-w 1	SP3	-	384	-	-	-	-	-	-	-	-	OK	OK
B19-w 2	SP3	-	384	-	-	-	-	-	-	-	-	OK	OK

Design data

Material	f _u [MPa]	β _w [-]	σ _{w,Rd} [MPa]	0,9 σ [MPa]
S 355	0,0	-	-	-

8.4 Spoj D4 (Donji pojas - rubne dijagonale)

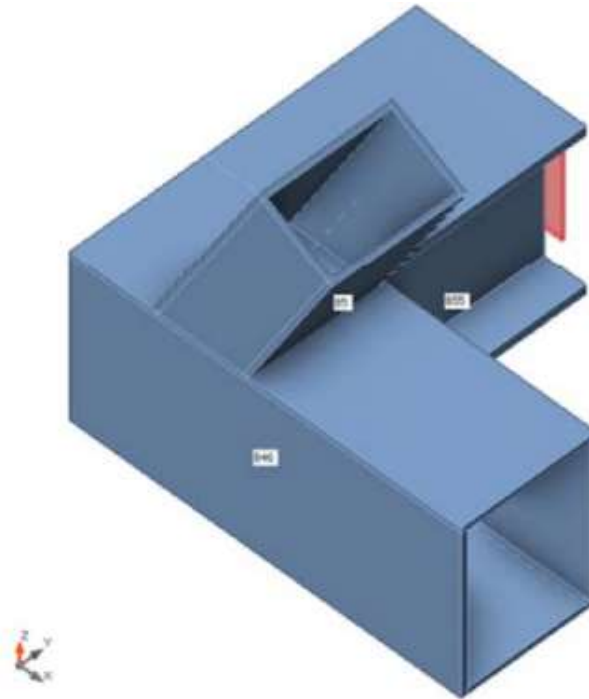

Slika 108. Prikaz modela D4

Cross-sections

Name	Material
7 - BoxWeb400x(250/250)	S 355
4 - donji pojas(500/400) (BoxWeb500x(400/400))	S 355
6 - BoxFI500x(500/500)	S 355

Load effects

Name	Member	N [kN]	V _y [kN]	V _z [kN]	M _x [kNm]	M _y [kNm]	M _z [kNm]
Reference	B5 / Begin	786,1	11,9	0,0	-1,4	0,8	-26,9
	B46 / End	122,7	3,5	-6,1	-13,7	0,0	0,0
	B55 / End	31,4	-232,9	-88,0	4,3	-13,2	4,5
zamor	B5 / Begin	1020,1	15,1	0,0	-2,0	1,2	-32,7
	B46 / End	178,1	4,7	-6,2	-17,9	0,0	0,0
	B55 / End	58,6	-329,0	-98,5	7,7	-17,5	2,5

Check

Summary

Name	Value	Check status
Plates	0,0 < 5,0%	OK

Plates

Name	t_p [mm]	Loads	σ_{Ed} [MPa]	ϵ_{pI} [%]	$\sigma_{c,Ed}$ [MPa]	Elastic	Status
B5-tfl 1	16,0	zamor	142,0	0,0	0,0	OK	OK
B5-bfl 1	16,0	zamor	76,2	0,0	0,0	OK	OK
B5-w 1	16,0	zamor	73,1	0,0	0,0	OK	OK
B5-w 2	16,0	zamor	102,3	0,0	0,0	OK	OK
B46-tfl 1	16,0	zamor	111,1	0,0	0,0	OK	OK
B46-bfl 1	16,0	zamor	145,7	0,0	0,0	OK	OK
B46-w 1	18,0	zamor	124,8	0,0	0,0	OK	OK
B46-w 2	18,0	zamor	147,3	0,0	0,0	OK	OK
B55-tfl 1	28,0	zamor	184,9	0,0	0,0	OK	OK
B55-bfl 1	28,0	zamor	187,4	0,0	0,0	OK	OK
B55-w 1	15,0	zamor	138,7	0,0	0,0	OK	OK
B55-w 2	15,0	zamor	158,7	0,0	0,0	OK	OK
SP2	25,0	zamor	292,5	0,0	0,0	OK	OK
SP3	25,0	zamor	69,6	0,0	0,0	OK	OK

Design data

Material	f_y [MPa]	ϵ_{lim} [%]
S 355	355,0	5,0

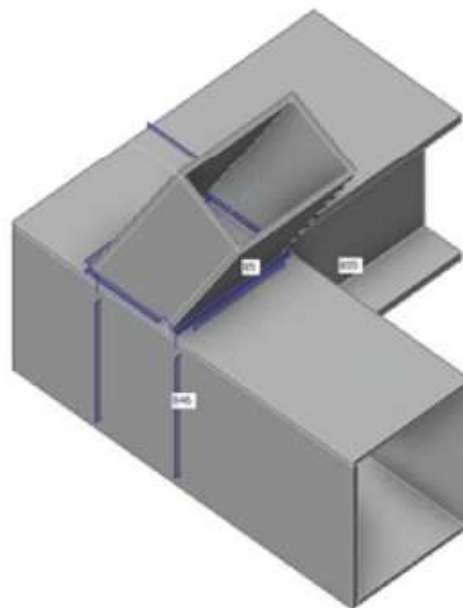

Overall check, zamor

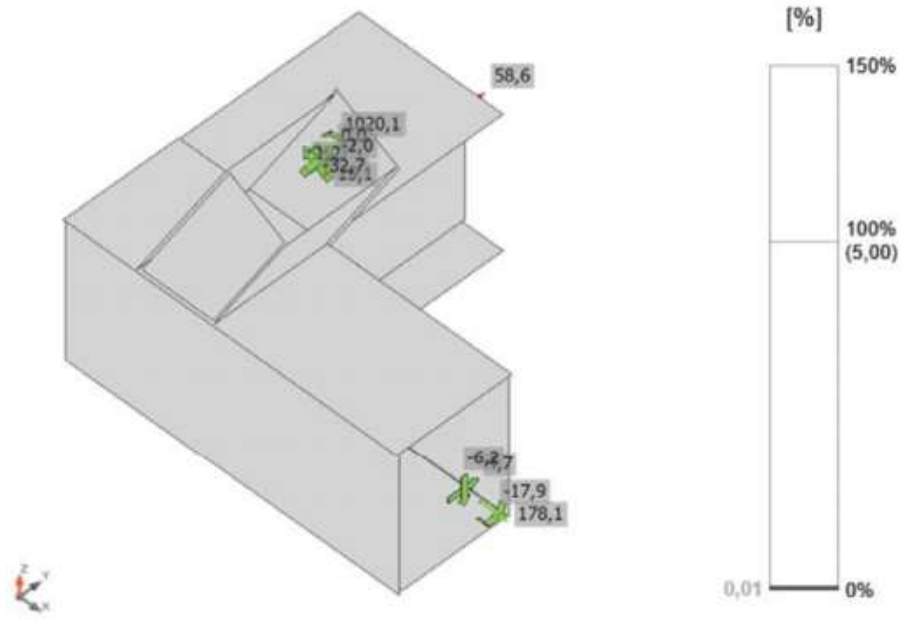

Strain check, zamor

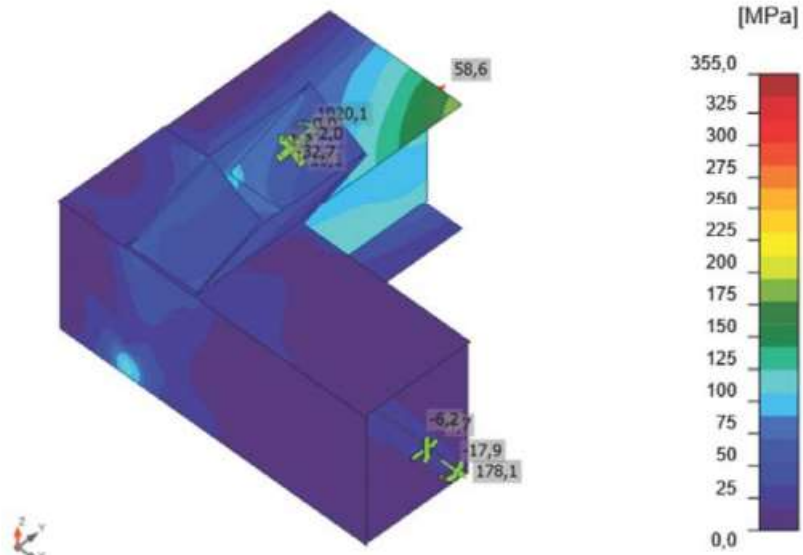

Equivalent stress, zamor

Welds

Item	Edge	Section	T_h [mm]	L [mm]	Loads	σ_{max} [MPa]	τ [MPa]	τ_{max} [MPa]	σ [MPa]	Elastic
B46-tfl 1	B5-tfl 1	B5-tfl 1	16,0	286	zamor	-18,6	11,5	11,5	-18,6	OK
B46-tfl 1	B5-bfl 1	B46-tfl 1	16,0	249	zamor	2,3	-0,1	2,9	1,5	OK
B46-tfl 1	B5-bfl 1	B5-bfl 1	16,0	249	zamor	-12,6	4,2	5,8	-11,5	OK
B46-tfl 1	B5-w 1	B46-tfl 1	16,0	384	zamor	7,6	-0,8	-1,3	2,9	OK
B46-tfl 1	B5-w 1	B5-w 1	16,0	384	zamor	-19,1	-0,8	2,5	-5,5	OK
B46-tfl 1	B5-w 2	B46-tfl 1	16,0	384	zamor	-5,7	-5,5	-7,8	0,2	OK
B46-tfl 1	B5-w 2	B5-w 2	16,0	384	zamor	-24,8	1,6	-1,8	-13,8	OK
B46-w 2	B55-tfl 1	B55-tfl 1	28,0	500	zamor	21,0	-0,2	5,8	11,6	OK
B46-w 2	B55-bfl 1	B46-w 2	28,0	500	zamor	-21,9	-4,6	-10,4	-11,8	OK
B46-w 2	B55-bfl 1	B55-bfl 1	28,0	500	zamor	-28,7	2,8	5,2	-5,0	OK
B46-w 2	B55-w 1	B46-w 2	4,0	444	zamor	10,8	4,6	4,6	10,5	OK
B46-w 2	B55-w 1	B55-w 1	4,0	444	zamor	-8,0	-12,5	-12,5	-7,3	OK
B46-w 2	B55-w 2	B46-w 2	4,0	444	zamor	8,8	-0,2	13,7	0,3	OK
B46-w 2	B55-w 2	B55-w 2	4,0	444	zamor	-12,6	-14,9	-16,8	-2,6	OK
B46-w 1	SP2	B46-w 1	25,0	408	zamor	-8,2	0,9	5,2	-7,7	OK
B46-w 1	SP2	SP2	25,0	408	zamor	10,1	-5,4	-8,0	4,7	OK
B46-tfl 1	SP2	B46-tfl 1	25,0	304	zamor	3,7	-3,7	-7,6	0,3	OK
B46-tfl 1	SP2	SP2	25,0	304	zamor	-9,3	12,9	12,9	-9,3	OK
B46-w 2	SP2	B46-w 2	25,0	408	zamor	9,1	1,8	-7,3	2,6	OK
B46-w 2	SP2	SP2	25,0	408	zamor	-17,8	-9,2	-13,7	-14,1	OK
B46-w 1	SP3	B46-w 1	25,0	408	zamor	3,4	-0,7	1,1	-1,7	OK
B46-w 1	SP3	SP3	25,0	408	zamor	3,6	-0,6	-1,1	1,8	OK
B46-tfl 1	SP3	B46-tfl 1	25,0	304	zamor	6,4	-1,0	-1,5	1,4	OK
B46-tfl 1	SP3	SP3	25,0	304	zamor	-6,8	0,0	4,2	-2,5	OK
B46-w 2	SP3	B46-w 2	25,0	408	zamor	9,1	-0,7	1,5	8,5	OK
B46-w 2	SP3	SP3	25,0	408	zamor	-4,6	-3,2	-4,6	-3,2	OK

Welds

Item	Edge	T_w [mm]	L [mm]	Loads	$\sigma_{w,Ed}$ [MPa]	ϵ_{pl} [%]	σ_{\perp} [MPa]	τ_{\perp} [MPa]	τ_{\parallel} [MPa]	Ut [%]	Ut _c [%]	Status
B46-tfl 1	B5-tfl 1	-	286	-	-	-	-	-	-	-	-	OK
B46-tfl 1	B5-bfl 1	-	249	-	-	-	-	-	-	-	-	OK
B46-tfl 1	B5-w 1	-	384	-	-	-	-	-	-	-	-	OK
B46-tfl 1	B5-w 2	-	384	-	-	-	-	-	-	-	-	OK
B46-w 2	B55-tfl 1	-	500	-	-	-	-	-	-	-	-	OK
B46-w 2	B55-bfl 1	-	500	-	-	-	-	-	-	-	-	OK
B46-w 2	B55-w 1	▲ 4,0 ▼	443	zamor	179,5	0,0	2,2	2,0	-103,6	41,2	22,5	OK
		▲ 4,0 ▼	443	zamor	186,9	0,0	-29,5	14,1	105,6	42,9	34,4	OK
B46-w 2	B55-w 2	▲ 4,0 ▼	443	zamor	261,0	0,0	-5,3	-9,8	-150,4	59,9	44,0	OK
		▲ 4,0 ▼	443	zamor	295,7	0,0	2,0	-2,7	170,7	67,9	37,4	OK
B46-w 1	SP2	-	408	-	-	-	-	-	-	-	-	OK
B46-tfl 1	SP2	-	304	-	-	-	-	-	-	-	-	OK
B46-w 2	SP2	-	408	-	-	-	-	-	-	-	-	OK
B46-w 1	SP3	-	408	-	-	-	-	-	-	-	-	OK
B46-tfl 1	SP3	-	304	-	-	-	-	-	-	-	-	OK
B46-w 2	SP3	-	408	-	-	-	-	-	-	-	-	OK

9. PRILOZI

1. Prilog 1 - Uzdužni presjek
2. Prilog 2 - Tlocrt mosta
3. Prilog 3 - Proširenje temelja - tlocrt
4. Prilog 4 - Detalj D1
5. Prilog 5 - Detalj D2
6. Prilog 6 - Detalj D3
7. Prilog 7 - Detalj D4

elementi

pozicija	poprečni presjek	materijal	širina mm	visina mm	hrbat mm	pojasnica mm	
gornji pojas		S355 A2	550	450	450	30	gornja - 16 donja - 30
donji pojas			400	500	500	18	400
rubna dijagonala			400	250	400	16	250
dijagonala			250	400	400	12	250
središnji poprečni nosač			500	500	500	18	500
rubni poprečni nosač			500	500	444	14.5	500

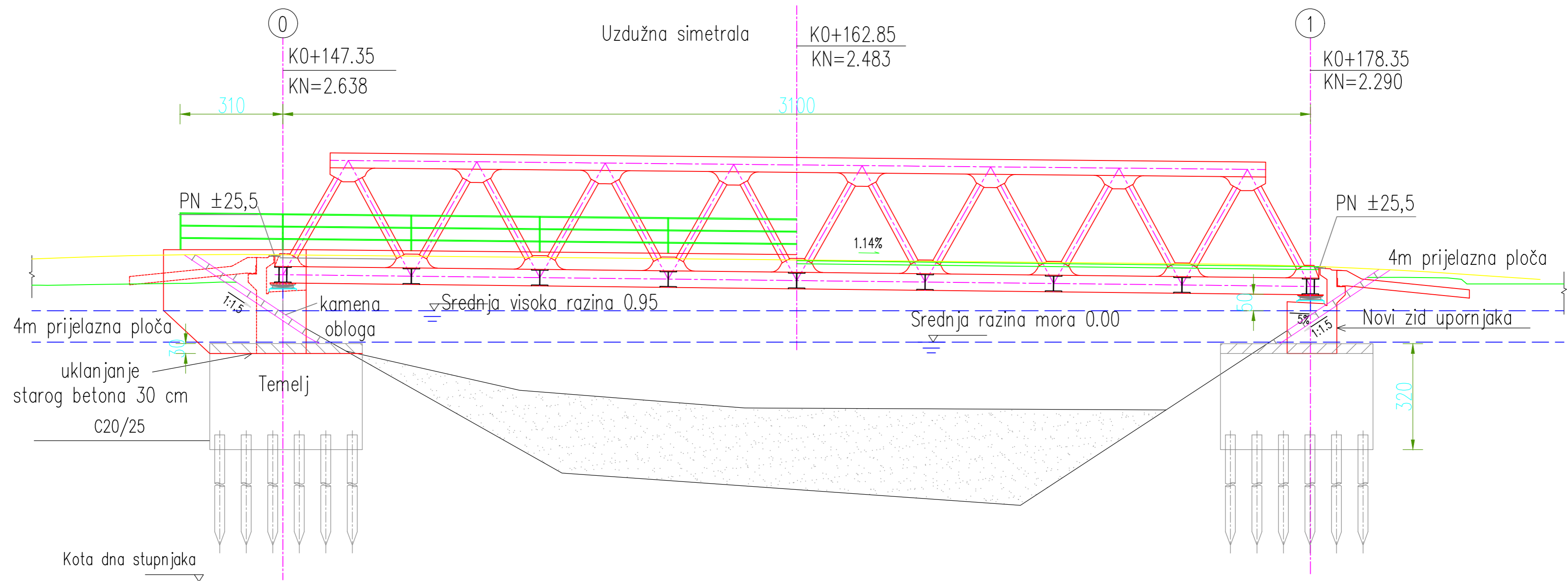

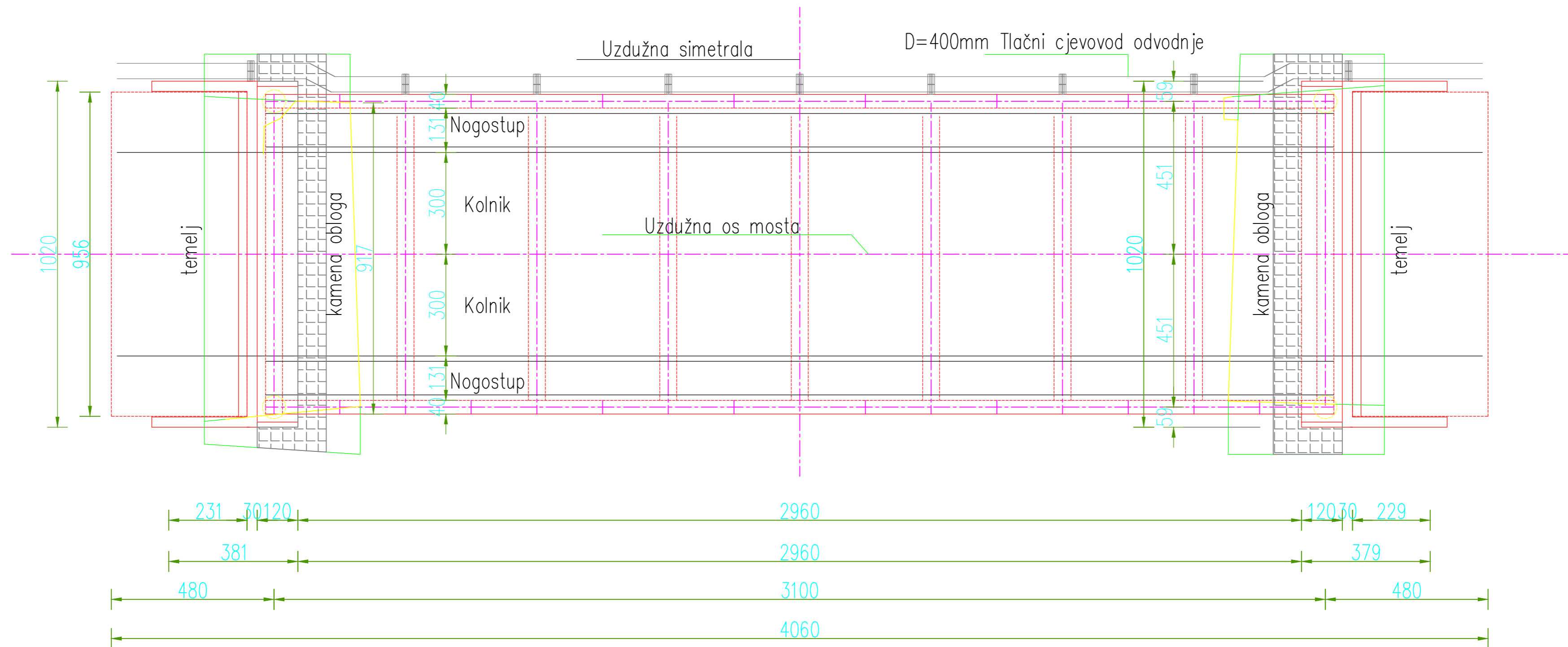

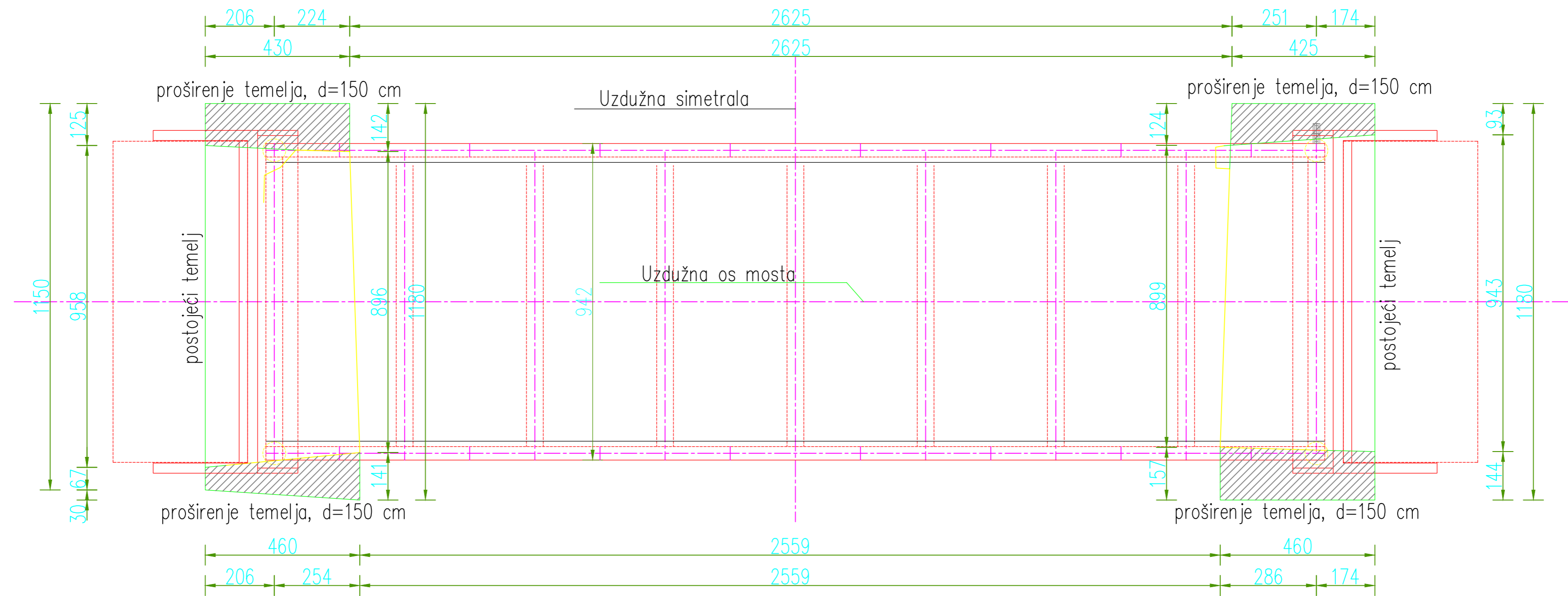

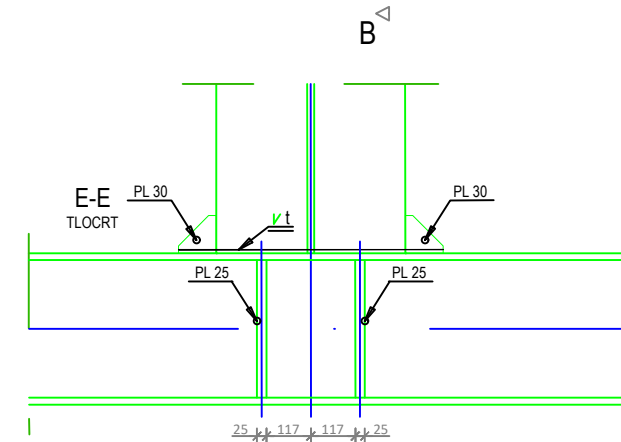
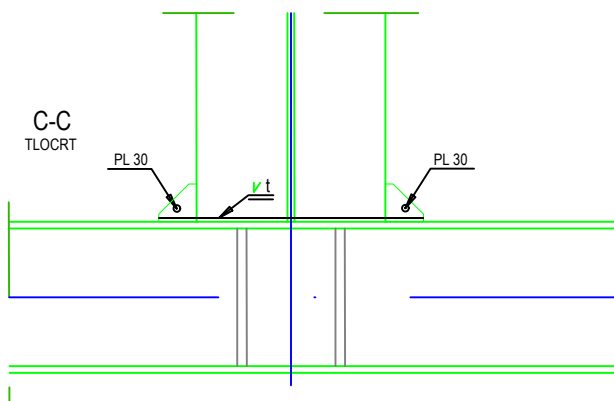
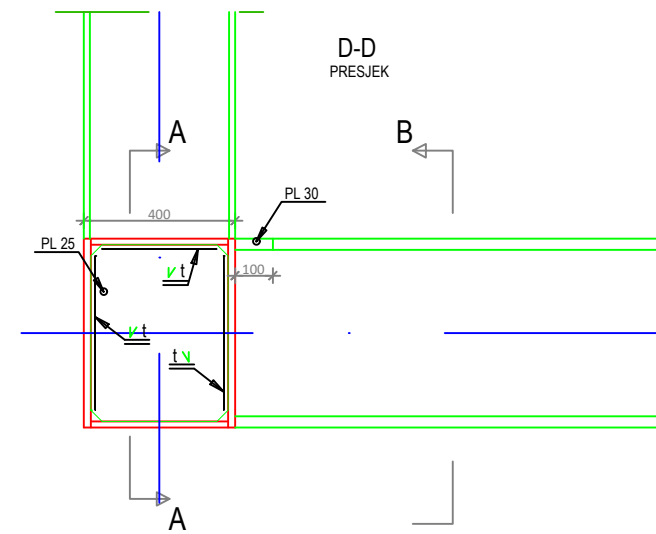
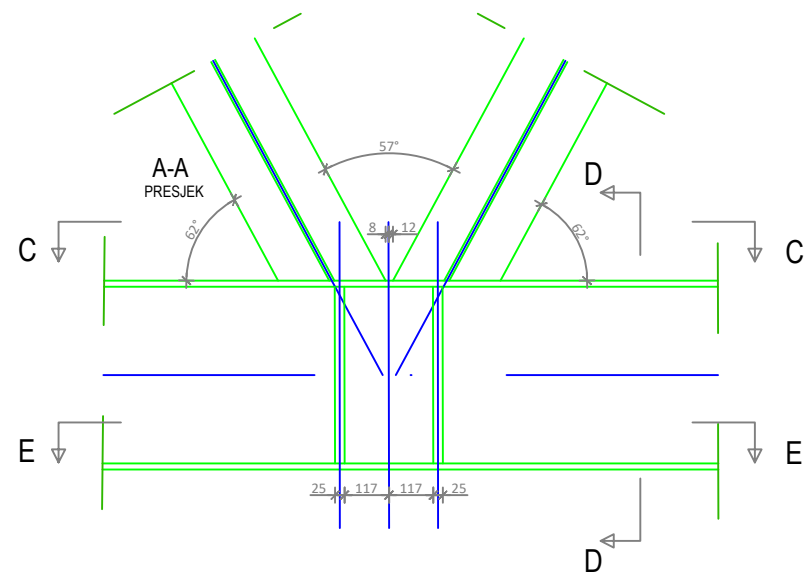

B-B PRESJEK
SPOJ POPREČNOG NOSAČA NA DONJI POJAS

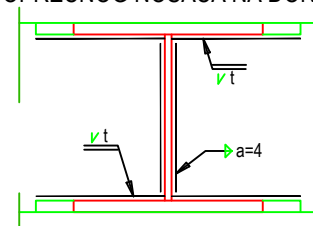

P25,0x468-364 (S 355)

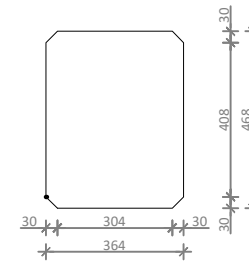

P30,0x100-100 (S 355)

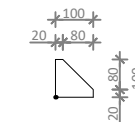

SVEUČILIŠTE U SPLITU
FAKULTET GRAĐEVINARSTVA, ARHITEKTURE I
GEODEZIJE
21000 SPLIT, MATICE HRVATSKE 15

Diplomski rad

Projekt konstrukcije Most preko Rječine

STUDENT	MENTOR	SADRŽAJ
Stipe Vrdoljak	Dr. sc. Ivica Boko	Detalj D1
DATUM		MJERILO
2023. / 2024.		1:20
		BROJ PRILOGA
		4

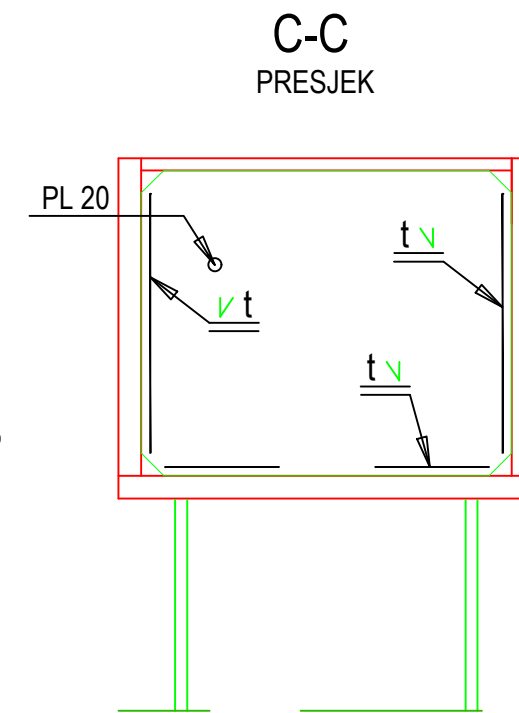
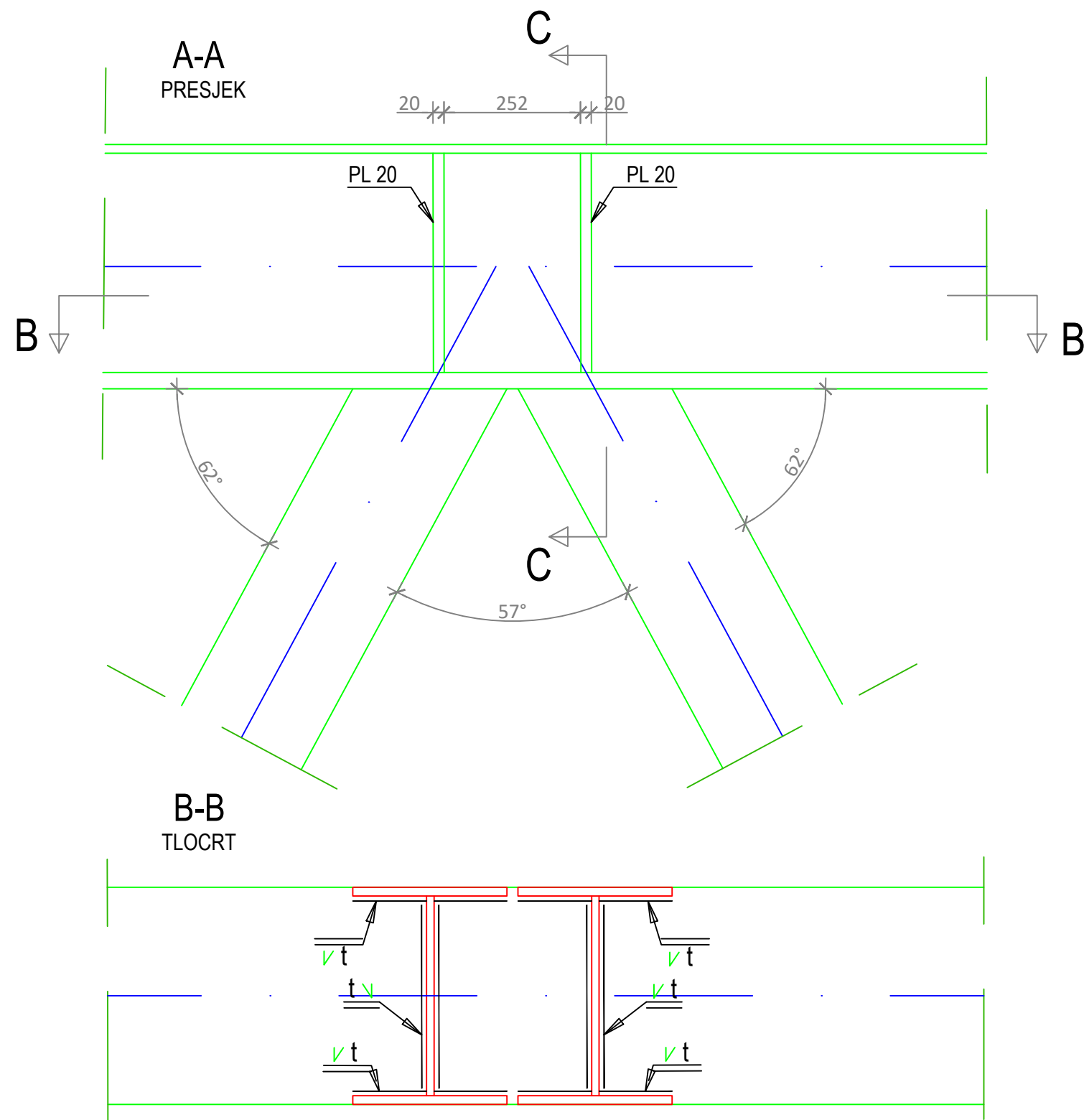

P20,0x490-404 (S 355)

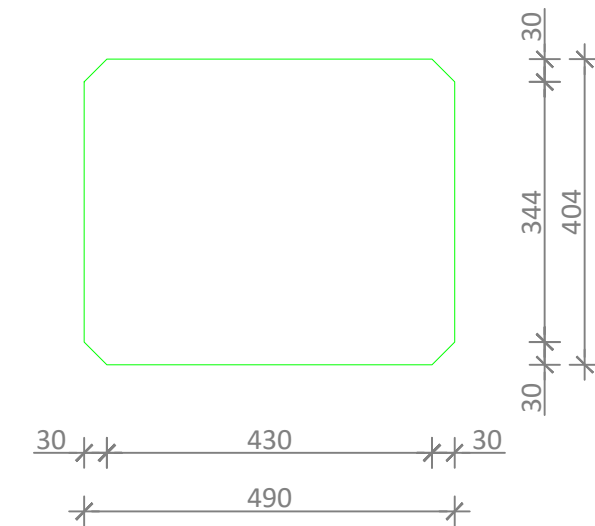

 <p>SVEUČILIŠTE U SPLITU FAKULTET GRAĐEVINARSTVA, ARHITEKTURE I GEODEZIJE 21000 SPLIT, MATICE HRVATSKE 15</p>	Diplomski rad		
	Projekt konstrukcije Most preko Rječine		
	STUDENT	MENTOR	SADRŽAJ
	Stipe Vrdoljak	Dr. sc. Ivica Boko	Detalj D1
			MJERILO
			1:10
DATUM	2023. / 2024.	BROJ PRILOGA	5

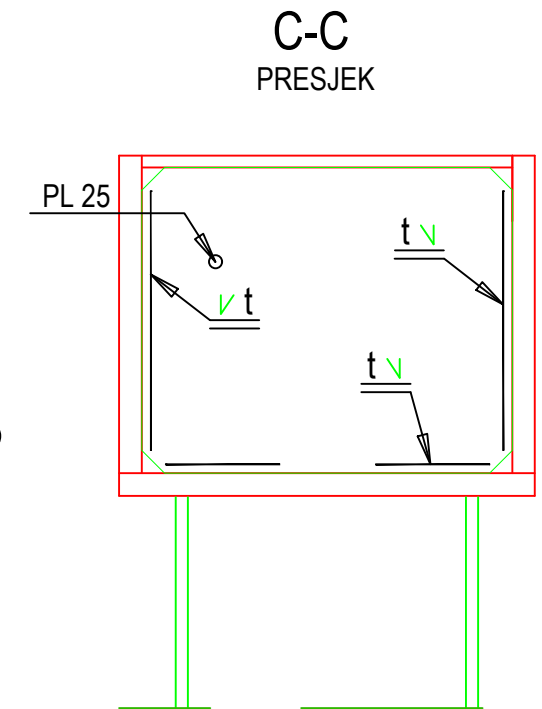
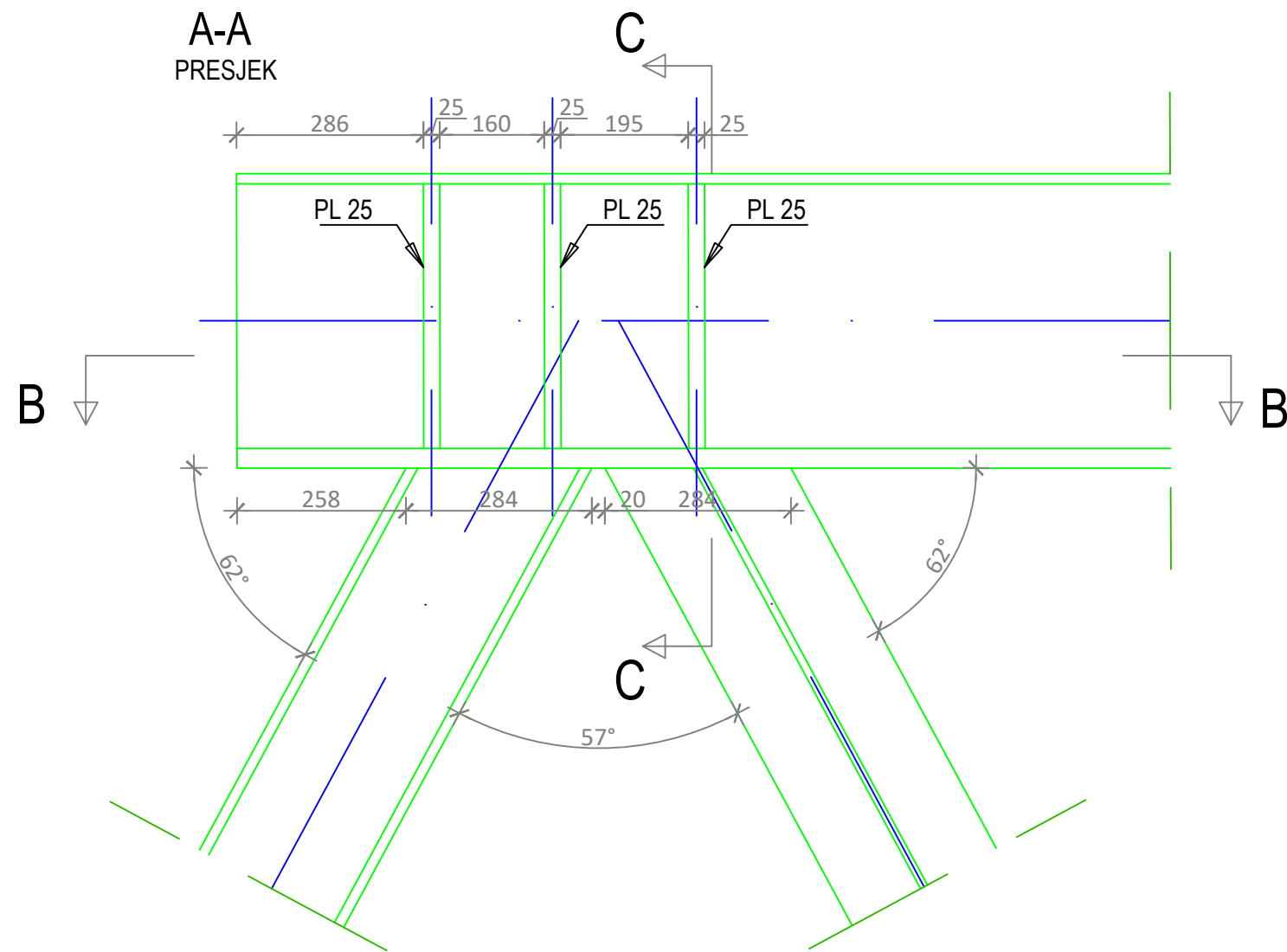

P25,0x490-404 (S 355)

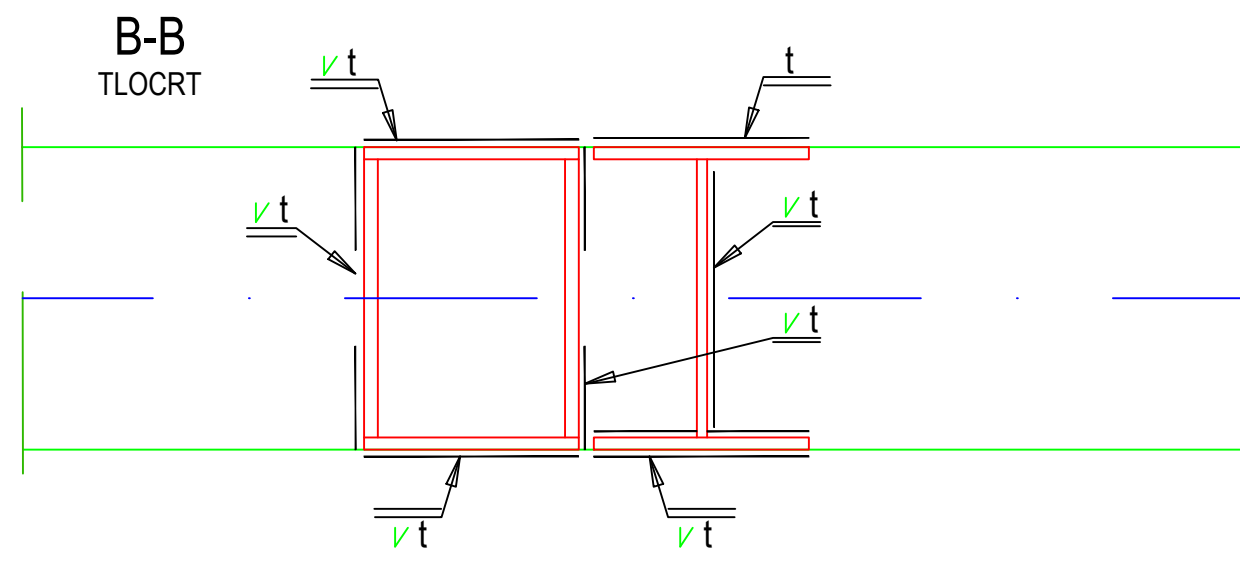
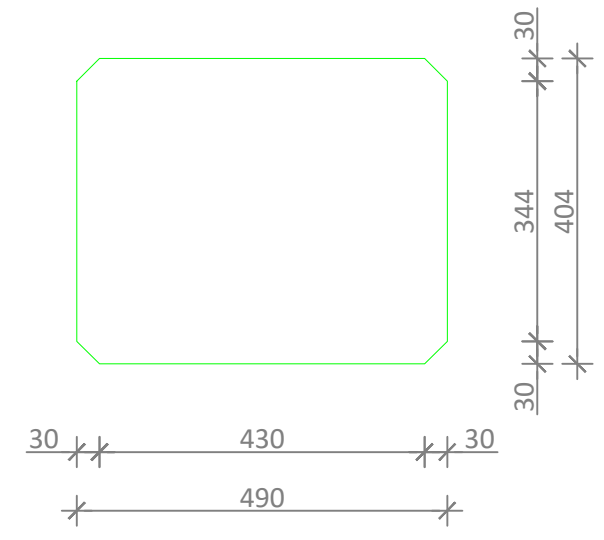

 SVEUČILIŠTE U SPLITU FAKULTET GRAĐEVINARSTVA, ARHITEKTURE I GEODEZIJE 21000 SPLIT, MATICE HRVATSKE 15	Diplomski rad		
	Projekt konstrukcije Most preko Rječine		
	STUDENT	MENTOR	SADRŽAJ
	Stipe Vrdoljak	Dr. sc. Ivica Boko	Detalj D1
DATUM	2023. / 2024.	MJERILO	1:10
		BROJ PRILOGA	6

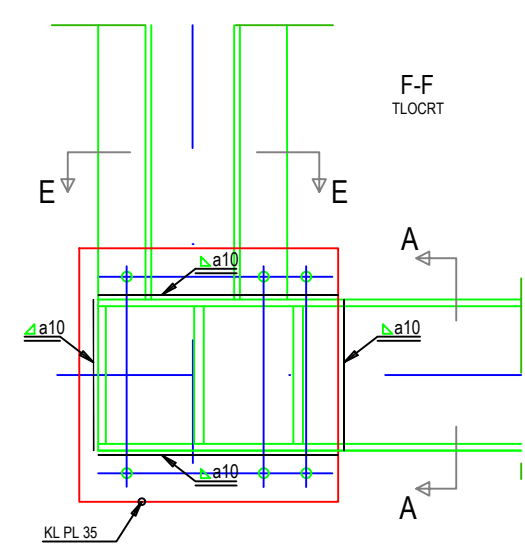
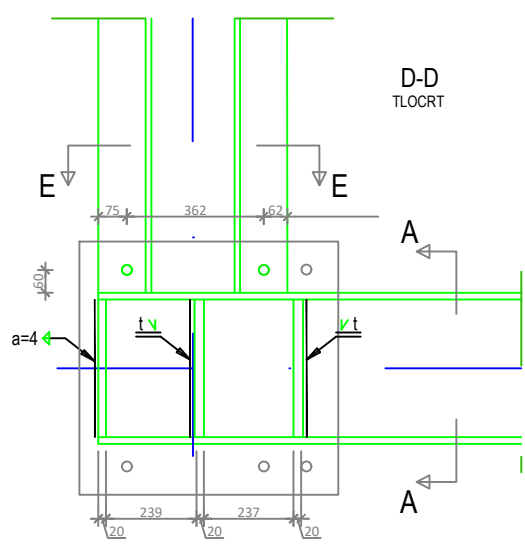
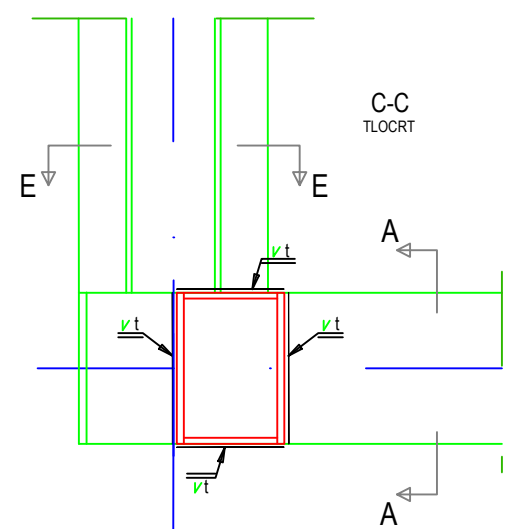
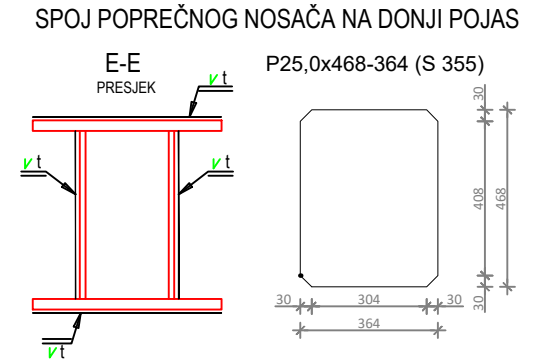
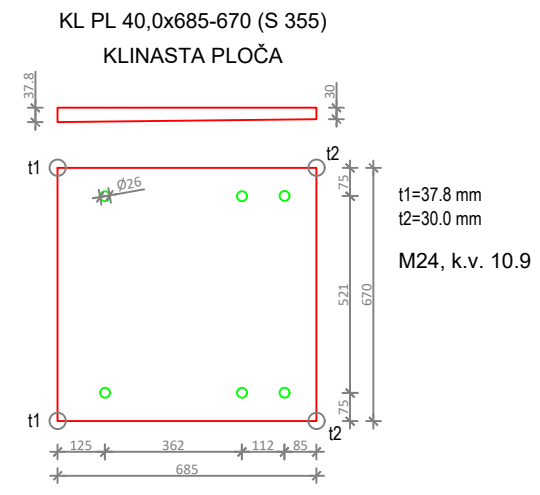
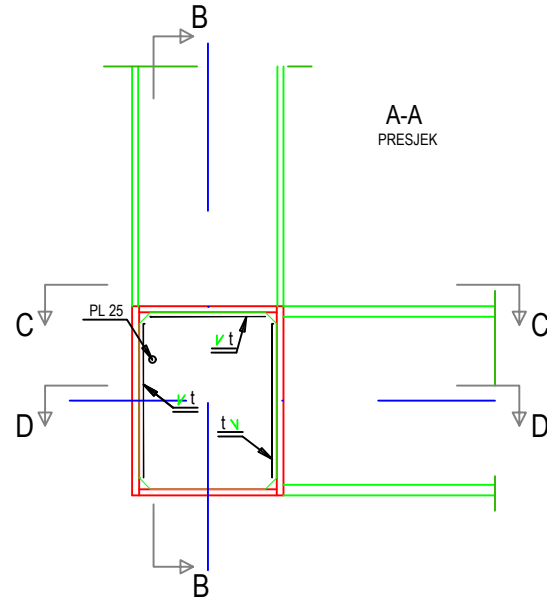
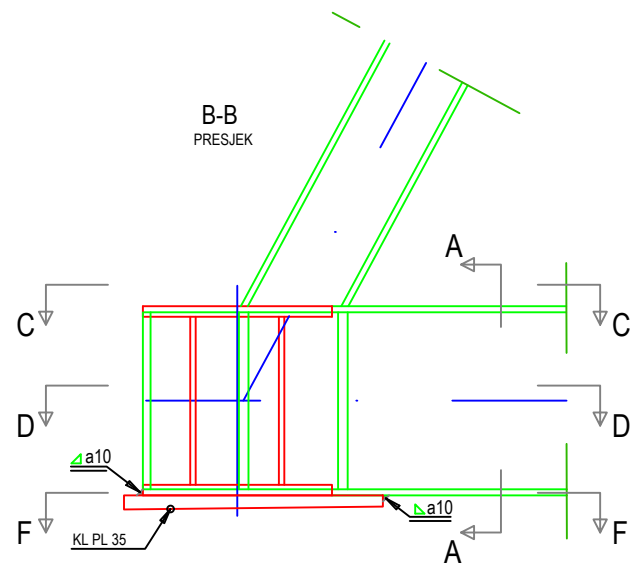

 SVEUČILIŠTE U SPLITU FAKULTET GRAĐEVINARSTVA, ARHITEKTURE I GEODEZIJE 21000 SPLIT, MATICE HRVATSKE 15	Diplomski rad		
	Projekt konstrukcije Most preko Rječine		
	STUDENT	MENTOR	SADRŽAJ
	Stipe Vrdoljak	Dr. sc. Ivica Boko	Detalj D1
DATUM	2023. / 2024.	MJERILO	1:20
		BROJ PRILOGA	7

10. POPIS SLIKA

<i>Slika 1. Izometrijski prikaz 3D modela</i>	<i>15</i>
<i>Slika 2. Prometno opterećenje.....</i>	<i>16</i>
<i>Slika 3. Zemljovid područja potresnog opterećenja</i>	<i>17</i>
<i>Slika 4. Vrijednosti preuzete iz baze</i>	<i>18</i>
<i>Slika 5. Karta osnovne brzine vjetra</i>	<i>19</i>
<i>Slika 6. Dijagram - faktor izloženosti.....</i>	<i>19</i>
<i>Slika 7. Dijagram - dinamički koeficijent</i>	<i>20</i>
<i>Slika 8. Slučajevi opterećenja nanošeni u software-u SCIA Engineer 2021.....</i>	<i>23</i>
<i>Slika 9. Poprečni presjek rubnog elementa</i>	<i>24</i>
<i>Slika 10. Poprečni presjek središnjeg elementa</i>	<i>24</i>
<i>Slika 11. Poprečni presjek rubne dijagonale</i>	<i>25</i>
<i>Slika 12. Poprečni presjek središnje dijagonale</i>	<i>25</i>
<i>Slika 13. Poprečni presjek gornjeg pojasa</i>	<i>25</i>
<i>Slika 14. Poprečni presjek donjeg pojasa.....</i>	<i>26</i>
<i>Slika 15. Dodatno stalno opterećenje - betonska ploča</i>	<i>27</i>
<i>Slika 16. Dodatno stalno opterećenje - djelovanje ploče koncentrirano u sredini.....</i>	<i>28</i>
<i>Slika 17. Dodatno stalno opterećenje - djelovanje ploče koncentrirano na rubu.....</i>	<i>28</i>
<i>Slika 18. Dodatno stalno opterećenje - grede</i>	<i>29</i>
<i>Slika 19. Dodatno stalno opterećenje - djelovanje greda koncentrirano u sredini</i>	<i>29</i>
<i>Slika 20. Dodatno stalno opterećenje - djelovanje greda koncentrirano na rubu</i>	<i>30</i>
<i>Slika 21. Promjenjivo opterećenje - prelazak pješaka preko mosta</i>	<i>30</i>
<i>Slika 22. Promjenjivo opterećenje - djelovanje temperature kod jednolikog zagrijavanja... 31</i>	
<i>Slika 23. Promjenjivo opterećenje - djelovanje temperature kod jednolikog hlađenja</i>	<i>31</i>
<i>Slika 24. Promjenjivo opterećenje - djelovanje kočne sile.....</i>	<i>32</i>
<i>Slika 25. Promjenjivo opterećenje - djelovanje skupljanja i puzanja</i>	<i>32</i>
<i>Slika 26. Promjenjivo opterećenje - djelovanje vjetra na neopterećenu konstrukciju.....</i>	<i>33</i>
<i>Slika 27. Promjenjivo opterećenje - djelovanje vjetra na opterećenu konstrukciju</i>	<i>33</i>
<i>Slika 28. Seizmički spektar</i>	<i>34</i>
<i>Slika 29. Vlastiti vektor konstrukcije u X smjeru</i>	<i>35</i>
<i>Slika 30. Vlastiti vektor konstrukcije u Y smjeru.....</i>	<i>36</i>
<i>Slika 31. Vlastiti vektor konstrukcije u XY smjeru - Torzija.....</i>	<i>36</i>
<i>Slika 32. Uzdužne sile N.....</i>	<i>37</i>
<i>Slika 33. Poprečna sila Vy</i>	<i>37</i>
<i>Slika 34. Poprečna sila Vz.....</i>	<i>37</i>

Slika 35. Moment savijanja M_y	37
Slika 36. Moment savijanja M_z	37
Slika 37. Uzdužne sile N	38
Slika 38. Poprečna sila V_y	38
Slika 39. Poprečna sila V_z	38
Slika 40. Moment savijanja M_y	38
Slika 41. Moment savijanja M_z	38
Slika 42. Uzdužne sile N	39
Slika 43. Poprečna sila V_y	39
Slika 44. Poprečna sila V_z	39
Slika 45. Moment savijanja M_y	40
Slika 46. Moment savijanja M_z	40
Slika 47. Gornji pojas.....	41
Slika 48. Donji pojas.....	46
Slika 49. Rubne dijagonale.....	51
Slika 50. Unutarnje dijagonale.....	56
Slika 51. Moment savijanja uzdužno na most - M_x, \min	61
Slika 52. Moment savijanja uzdužno na most - M_x, \max	61
Slika 53. Moment savijanja okomito na most - M_y, \min	62
Slika 54. Moment savijanja okomito na most - M_y, \max	62
Slika 55. Donja zona - okomito na most.....	63
Slika 56. Donja zona - uzdužno na most.....	63
Slika 57. Gornja zona - okomito na most.....	63
Slika 58. Gornja zona - uzdužno na most.....	64
Slika 59. GSU anvelopa - provjera uvjeta minimalne i maksimalne armature.....	64
Slika 60. Moment savijanja M_y	65
Slika 61. Moment savijanja M_z	65
Slika 62. Poprečne sile V_z	65
Slika 63. Poprečne sile V_y	66
Slika 64. Uzdužne sile N	66
Slika 65. Potrebna uzdužna armatura.....	66
Slika 66. Potrebna poprečna armatura.....	66
Slika 67. Opterećenje tlom.....	67
Slika 68. Pritisak tla od vozila.....	67
Slika 69. Moment savijanja M_x	67
Slika 70. Moment savijanja M_y	68
Slika 71. Potrebna horizontalna armatura prema nasipu.....	68

Slika 72. Potrebna horizontalna armatura prema van.....	68
Slika 73. Potrebna vertikalna armatura prema nasipu	69
Slika 74. Potrebna vertikalna armatura prema van.....	69
Slika 75. Provjera uvjeta minimalne i maksimalne armature	70
Slika 76. Aksonometrijski prikaz modela	71
Slika 77. Pritisak tla.....	71
Slika 78. Pritisak tla i vozila	72
Slika 79. Potresno opterećenje	72
Slika 80. Moment savijanja M_x	73
Slika 81. Moment savijanja M_y	73
Slika 82. Moment savijanja M_x	73
Slika 83. Moment savijanja M_y	74
Slika 84. Horizontalna armatura prema van.....	74
Slika 85. Vertikalna armatura prema van.....	74
Slika 86. Horizontalna armatura prema nasipu	74
Slika 87. Vertikalna armatura prema nasipu	75
Slika 88. Horizontalna armatura prema van.....	75
Slika 89. Vertikalna armatura prema van.....	75
Slika 90. Horizontalna armatura prema nasipu	76
Slika 91. Vertikalna armatura prema nasipu	76
Slika 92. Moment savijanja uzdužno na most - M_x	77
Slika 93. Moment savijanja poprečno na most - M_y	77
Slika 94. Anvelopa GSN - kontaktna naprezanja.....	77
Slika 95. Anvelopa potres - kontaktna naprezanja.....	78
Slika 96. Anvelopa GSU - kontaktna naprezanja	78
Slika 97. Gornja zona - uzdužno na most.....	78
Slika 98. Gornja zona - poprečno na most.....	79
Slika 99. Donja zona - uzdužno na most	79
Slika 100. Donja zona - poprečno na most	79
Slika 101. Provjera uvjeta minimalne i maksimalne armature	80
Slika 102. Shema armature proširenja postojećeg temelja.....	80
Slika 103. Granično stanje uporabivosti	81
Slika 104. Oznake spojeva.....	82
Slika 105. Prikaz modela D1	83
Slika 106. Prikaz modela D2	88
Slika 107. Prikaz modela D3	92
Slika 108. Prikaz modela D4.....	96

11. POPIS TABLICA

<i>Tablica 1. Definicija razreda posljedica.....</i>	<i>11</i>
<i>Tablica 2. Odabir razreda izvedbe</i>	<i>12</i>
<i>Tablica 3. Razredi izloženosti u odnosu na uvjete okoliša u skladu s normo.....</i>	<i>14</i>
<i>Tablica 4. Dodatno stalno opterećenje</i>	<i>16</i>

12. LITERATURA

- [1] Primjena metode konačnih elemenata u građevinarstvu Mirković V. Užar J. 2012.
- [2] Dr.sc. Ivica Boko, Osnove metalnih konstrukcija – Predavanja i vježbe
- [3] Dr.sc. Alen Harapin, Dr.sc. Jure Radnić, Dr.sc. Nikola Grgić, Dr.sc. Marija Smilović Zulim, Dr.sc. Marina Sunara, Dr.sc. Ante Buzov, Osnove betonskih konstrukcija: interna skripta
- [4] Dr.sc. Željana Nikolić, Dinamika konstrukcija i potresno inženjerstvo – Predavanja i vježbe
- [5] Sveučilište u Splitu, Građevinsko - arhitektonski fakultet, Katedra za betonske konstrukcije i mostove: Interna skripta, radna verzija
- [6] Eurocode EN 1991
- [7] Eurocode EN 1992
- [8] Eurocode EN 1993