

Projekt nosive armiranobetonske konstrukcije poslovnog objekta

Dodig, Šime

Undergraduate thesis / Završni rad

2017

Degree Grantor / Ustanova koja je dodijelila akademski / stručni stupanj:

University of Split, Faculty of Civil Engineering, Architecture and Geodesy / Sveučilište u Splitu, Fakultet građevinarstva, arhitekture i geodezije

Permanent link / Trajna poveznica: <https://urn.nsk.hr/urn:nbn:hr:123:347545>

Rights / Prava: [In copyright](#)/[Zaštićeno autorskim pravom.](#)

Download date / Datum preuzimanja: **2024-12-18**



Repository / Repozitorij:

[FCEAG Repository - Repository of the Faculty of Civil Engineering, Architecture and Geodesy, University of Split](#)



UNIVERSITY OF SPLIT



SVEUČILIŠTE U SPLITU
FAKULTET GRAĐEVINARSTVA, ARHITEKTURE I GEODEZIJE

ZAVRŠNI RAD

Dodig Šime

Split, 2017.

SVEUČILIŠTE U SPLITU
FAKULTET GRAĐEVINARSTVA, ARHITEKTURE I GEODEZIJE

**Projekt nosive armiranobetonske konstrukcije
poslovnog objekta**

Završni rad

Split, 2017.

SVEUČILIŠTE U SPLITU
FAKULTET GRAĐEVINARSTVA, ARHITEKTURE I GEODEZIJE

Split, Matice hrvatske 15

STUDIJ: **STRUČNI STUDIJ GRAĐEVINARSTVA**
KANDIDAT: Šime Dodig
BROJ INDEKSA: 1562
KATEDRA: **Katedra za betonske konstrukcije i mostove**
PREDMET: Betonske konstrukcije 1

ZADATAK ZA ZAVRŠNI RAD

Tema: Projekt nosive armiranobetonske konstrukcije poslovnog objekta

Opis zadatka:

Zadana je shema nosive konstrukcije armiranobetonskog objekta poslovne namjene, sa svim potrebnim dimenzijama (prilog zadatku). Također su zadana djelovanja na konstrukciju. Potrebno je proračunati nosivu konstrukciju, te za neke elemente nacrtati planove oplata i armature. Statički proračun i armaturne planove izraditi sukladno propisima i pravilima struke.

U Splitu, 28.10.2016.

Voditelj Završnog rada:

.dr.sc. Nikola Grgić

PRILOG:

Na priloženim skicama dana je shema nosive armiranobetonske konstrukcije objekta. U tablici su zadane sve potrebne dimenzije i djelovanja na konstrukciju.

Oznaka	Veličina	Jedinica	Opis
L_1	6,5	(m)	„raster“ u uzdužnom smjeru
L_2	6,0	(m)	„raster“ u poprečnom smjeru
H	3,5	(m)	visina etaža
q	3,7	(kN/m ²)	uporabno opterećenje
Z_v	II		zona vjetra
a_g	0,25g	(m/s ²)	proračunsko ubrzanje tla
S	B 450 BC		armatura
C	C 30/37		klasa betona

(i) Presjek

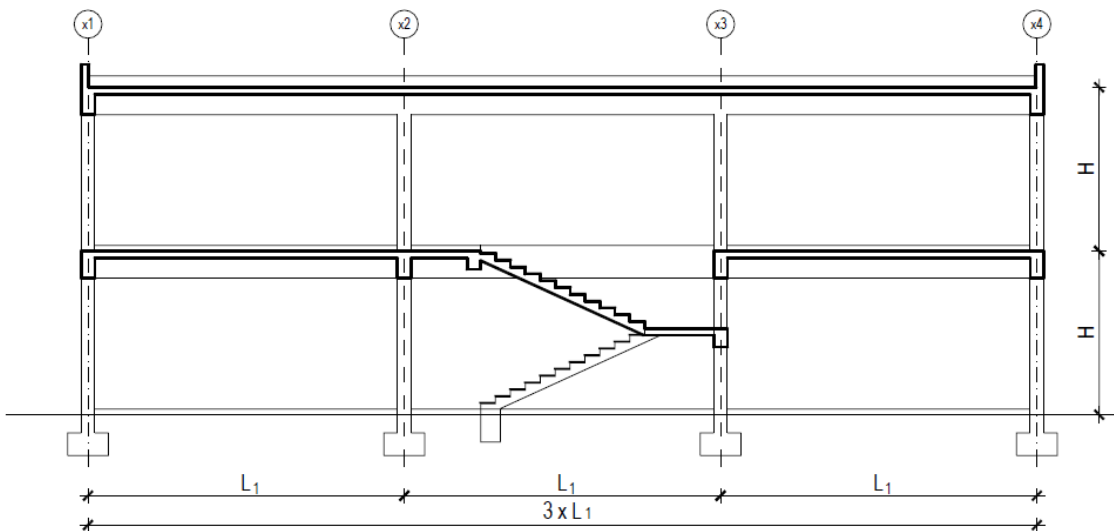

(ii) Međuetáže

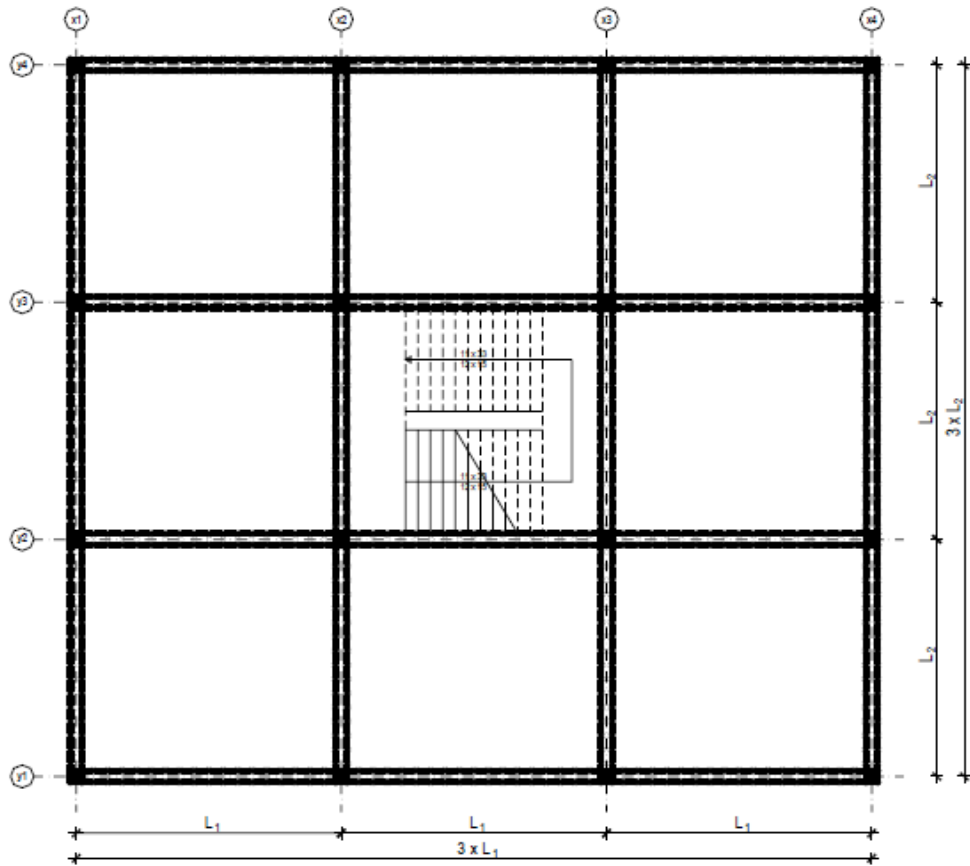

(iii) Krovna konstrukcija

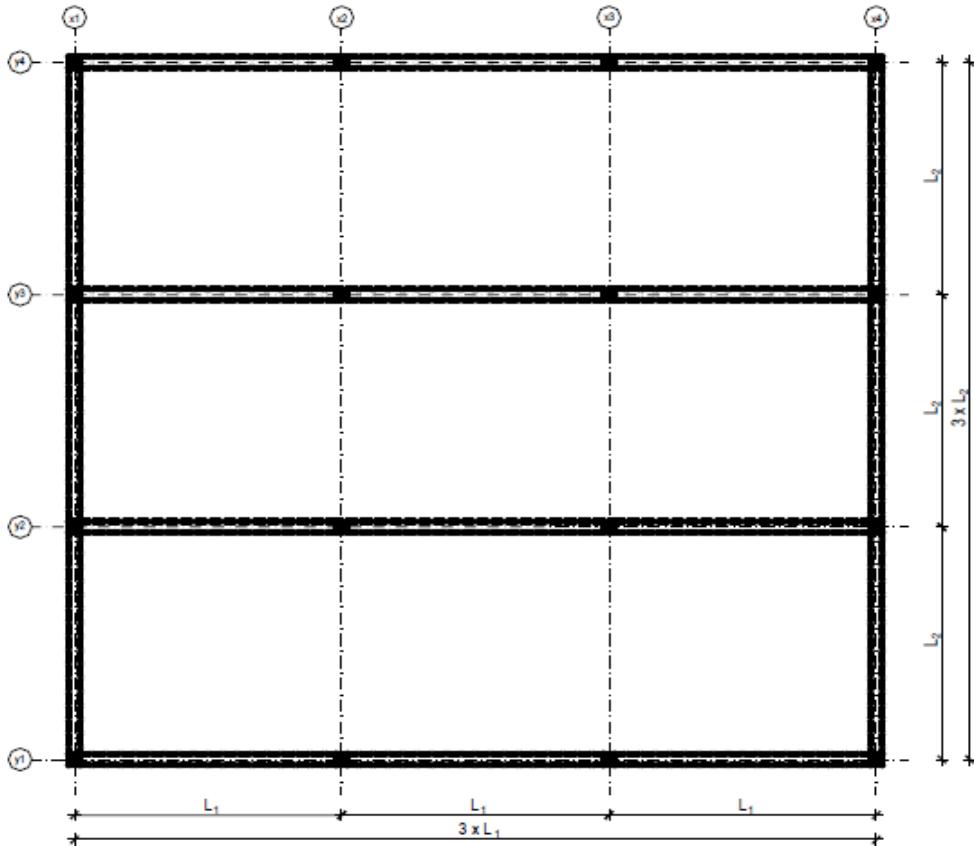

SAŽETAK:

Zadana je shema nosive konstrukcije armiranobetonskog objekta poslovne namjene sa svim potrebnim dimenzijama (prilog zadatku). Također su zadana djelovanja na konstrukciju, te za neke elemente nacrtati planove oplata i armature. Statički proračun i armaturne planove izraditi sukladno propisima i pravilima struke.

KLJUČNE RIJEČI:

Armiranobetonski objekt poslovne namjene, numerički model, statički proračun, plan armature.

ABSTRACT:

The default scheme bearing structures reinforced concrete facility for business purposes, with all the required dimensions (Annex task). Also the default action on the structure, and for some elements draw plans and reinforcement. Structural analysis and reinforcement plans develop in accordance with the regulations and rules of the profession.

KEYWORDS:

Reinforced concrete building for business purposes , numerical model , static analysis , reinforcement plan

SADRŽAJ:

1. TEHNIČKI OPIS	1
2. GEOMETRIJSKE KARAKTERISTIKE NOSIVIH ELEMENATA	2
3. ANALIZA OPTEREĆENJA	4
3.1. POZICIJA 200 – KROV	4
3.1.1. <i>Stalno opterećenje</i>	4
3.1.2. <i>Uporabno opterećenje</i>	4
3.2. POZICIJA 100 – ETAŽE	6
3.2.1. <i>Stalno opterećenje</i>	6
3.2.2. <i>Uporabno opterećenje</i>	6
3.3. STUBIŠTE	11
3.3.1. <i>Stalno opterećenje</i>	11
3.3.2. <i>Uporabno opterećenje</i>	12
3.4. OPTEREĆENJE VJETROM.....	13
4. PRORAČUN PLOČA POZICIJE 200.....	19
4.1. MOMENTI SAVIJANJA U PLOČI POZICIJE 200	19
4.1.1. <i>Vlastita težina</i>	19
4.1.2. <i>Dodatno stalno opterećenje</i>	21
4.1.3. <i>Uporabno opterećenje</i>	22
4.1.4. <i>Granično stanje nosivosti</i>	23
4.2. DIMENZIONIRANJE PLOČA POZICIJE 200	24
5. PRORAČUN PLOČA POZICIJE 100.....	27
5.1. MOMENTI SAVIJANJA U PLOČI POZICIJE 100	27
5.1.1. <i>Vlastita težina</i>	27
5.1.2. <i>Dodatno stalno opterećenje</i>	29
5.1.3. <i>Uporabno opterećenje shema 1 (max momenti na ležajevima)</i>	30
5.1.4. <i>Uporabno-opterećenje shema 2(max momenti u krajnjim poljima)</i>	31
5.1.5. <i>Uporabnoopterećenje shema 3 (max momenti u srednjem polju)</i>	32
5.1.6. <i>GSN za ležajeve</i>	33
5.1.7. <i>GSN za krajnja polja</i>	34
5.1.8. <i>GSN za srednje polje</i>	36
5.2. DIMENZIONIRANJE PLOČA POZICIJE 100	37
6. PRORAČUN KONTINUIRANOG NOSAČA POZICIJE 200	41
6.1. MOMENTI SAVIJANJA I POPREČNE SILE GREDE POZICIJE 200.....	41

6.1.1.	<i>Vlastita težina</i>	41
6.1.2.	<i>Dodatno stalno opterećenje</i>	42
6.1.3.	<i>Uporabnoopterećenje</i>	43
6.1.4.	<i>Granično stanje nosivosti</i>	44
6.2.	DIMENZIONIRANJE GREDE NA MOMENT SAVIJANJA	45
6.3.	DIMENZIONIRANJE GREDE NA POPREČNU SILU	47
6.4.	KONTROLA PUKOTINA GREDE POZICIJE 200.....	51
6.5.	KONTROLA PROGIBA GREDE POZICIJE 200	55
7.	PRORAČUN KONTINUIRANOG NOSAČA POZICIJE 100	58
7.1.	MOMENTI SAVIJANJA I POPREČNE SILE GREDE POZICIJE 100.....	58
7.1.1.	<i>Vlastita težina</i>	58
7.1.2.	<i>Dodatno stalno opterećenje</i>	59
7.1.3.	<i>Uporabno opterećenje shema 4 (max sile u krajnjim poljima)</i>	60
7.1.4.	<i>Uporabno opterećenje shema 5 (max sile u srednjem polju)</i>	61
7.1.5.	<i>Uporabno opterećenje shema 6 (max sile na ležaju)</i>	62
7.1.6.	<i>GSN za kranjapolja</i>	63
7.1.7.	<i>GSN za srednje polje</i>	64
7.1.8.	<i>GSN za ležaj</i>	65
7.2.	DIMENZIONIRANJE GREDE NA MOMENT SAVIJANJA	66
7.3.	DIMENZIONIRANJE GREDE NA POPREČNU SILU	68
7.4.	KONTROLA PUKOTINA GREDE POZICIJE 100.....	72
7.5.	KONTROLA PROGIBA GREDE POZICIJE 100	76
8.	PRORAČUN STUBIŠTA	79
8.1.	MJERODAVNE REZNE SILE	79
8.2.	DIMENZIONIRANJE STUBIŠTA	80
9.	PRORAČUN STUPOVA	81
9.1.	MOMENTI SAVIJANJA I UZDUŽNE SILE STUPOVA	81
9.1.1.	<i>Kombinacija 1</i>	81
9.1.2.	<i>Kombinacija 2</i>	82
9.2.	DIMENZIONIRANJE STUPA	83
9.2.1.	<i>Određivanje dimenzija stupova</i>	83
9.2.2.	<i>Dimenzioniranje pomoću dijagrama interakcije</i>	84
9.2.3.	<i>Proračun poprečne armature stupa</i>	85
10.	PRORAČUN TEMELJA SAMCA ISPOD STUPA	85
10.1.	DIMENZIONIRANJE TEMELJA.....	85

10.1.1.	<i>Preliminarno određivanje dimenzija temelja</i>	86
10.2.	NAPREZANJA NA DODIRNOJ PLOHI TEMELJ – TLO.....	87
10.3.	PRORAČUN ARMATURE TEMELJA	88
11.	PRILOZI	90
11.1.	ARMATURA PLOČE POZICIJA 100- DONJA ZONA	90
11.2.	ARMATURA PLOČE POZICIJA 100- GORNJA ZONA.....	90
11.3.	ARMATURA PLOČE POZICIJA 200- DONJA ZONA.....	90
11.4.	ARMATURA PLOČE POZICIJA 200- GORNJA ZONA.....	90
11.5.	ARMATURNI PLAN GREDE POZICIJE 100.....	90
11.6.	ARMATURNI PLAN GREDE POZICIJE 200.....	90
11.7.	ARMATURNI PLAN STUBIŠTA	90
11.8.	ARMATURNI PLAN STUPA.....	90
12.	LITERATURA	91

1. TEHNIČKI OPIS

Predmet ovog rada je projekt armiranobetonske nosive konstrukcije poslovnog objekta. Predmetna građevina sastoji se od prizemlja i kata. Završna ploča kata je ujedno i ravni krov građevine.

Visina građevine iznosi 7,00 m, a tlocrtna površina građevine iznosi 19,50 x 18,00 m.

Nosiva konstrukcija objekta je okvirna, a čine je stupovi i grede iznad koje su armiranobetonske ploče. Stupovi se oslanjaju na temelje samce. Rezne sile u pločama i gredama dobivene su pomoću programa *AspalathosLinear*, a korišten je ravninski model. Sve armiranobetonske ploče su debljine $d=18.0\text{cm}$. Poprečne grede su dimenzija $b/h=30/60\text{ cm}$, a uzdužne grede dimenzija $b/h=30/60\text{ cm}$. Rezne sile u stupovima za različite kombinacije opterećenja dobivene su pomoću programa *AspalathosLinear*, a korišten je prostorni model (okvir). Odabrane su dimenzije stupova $35/35\text{ cm}$ i temelji samci $190\times 190\times 70\text{ cm}$. Za vertikalnu komunikaciju između katova predviđeno je armiranobetonsko stepenište debljine nosive ploče $d=18.0\text{ cm}$.

Izračunato stalno opterećenje za poziciju 200(krov) iznosi $8,30\text{ kN/m}^2$, a uporabno opterećenje (prema propisima) iznosi $1,0\text{ kN/m}^2$. Zadano je uporabno opterećenje za poziciju 100 (međukatne konstrukcije) i iznosi $3,7\text{ kN/m}^2$, a stalno opterećenje je $7,70\text{ kN/m}^2$. Građevina se nalazi u II. vjetrovnoj zoni s osnovnom brzinom vjetra $v_{b0}=30\text{ m/s}$.

Dozvoljeno naprezanje u tlu na dubini temeljenja iznosi $\sigma_{\text{dop}} = 0.50\text{ Ma}$.

Za nosivu armiranobetonsku konstrukciju odabran je beton C 30/37 i čelik za armiranje B 450BC.

Za sve armiranobetonske nosive elemente izvršen je proračun za granično stanje nosivosti, a za neke elemente izvršena je provjera graničnog stanja uporabljivosti. Na osnovi proračunskih vrijednosti momenata i dobivenih površina armature, odabrana je armatura (mreže i šipki) te su napravljeni armaturni planovi za neke elemente konstrukcije. Svi nacrti i prikazi krojenja armaturnih mreža ploče, grede i stupova nacrtani su pomoću programa AutoCAD priloženi su u radu.

Statički sustav i armaturni planovi izrađeni su sukladno propisima i pravilima struke.

2. GEOMETRIJSKE KARAKTERISTIKE NOSIVIHELEMENATA

-visina ploče:

$$d_{pl} = \frac{L_2}{35} = \frac{600}{35} = 17,14$$

⇒ odabrano: $d_{pl} = 18 \text{ cm}$

visina grede:

$$\frac{L_0}{12} = \frac{L_1}{12} = \frac{650}{12} = 54,2 \text{ cm}$$

odabrano : $h_{G1} = 60,0 \text{ cm}$

$$\frac{L_0}{12} = \frac{L_1}{12} = \frac{600}{12} = 50,0 \text{ cm}$$

odabrano : $h_{G1} = 60,0 \text{ cm}$

-širina grede:

$$\frac{h_{G1}}{2} = \frac{60}{2} = 30 \text{ cm}$$

odabrano : $b_{G1} = 30 \text{ cm}$

$$\frac{h_{G2}}{2} = \frac{60}{2} = 30 \text{ cm}$$

odabrano : $b_{G2} = 30 \text{ cm}$

PRESJEK 1

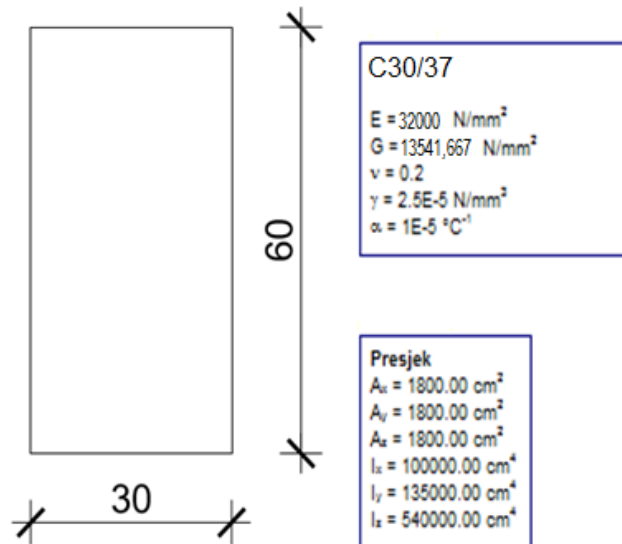

Slika 2.1. Poprečni presjek grede

- Za sve nosive elemente u x i y smjeru na pozicijama 100 i 200 odabran je isti presjek grede, dimenzija 60x30 cm.

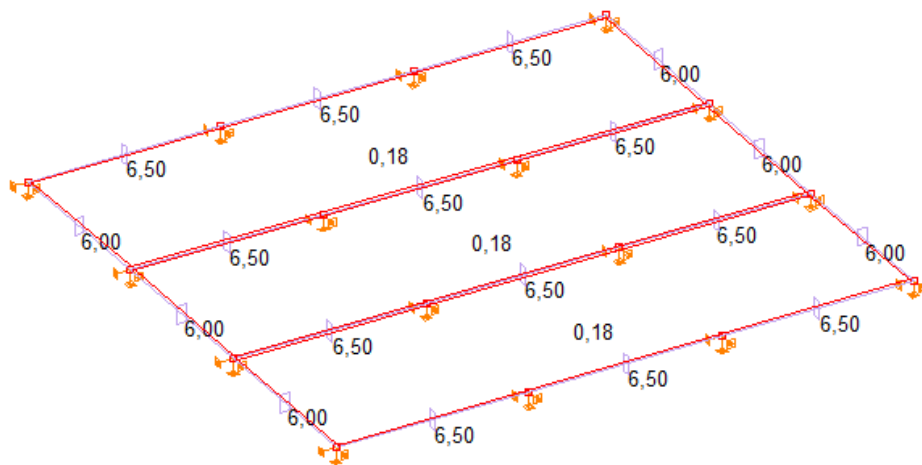

Slika 2.2. Prikaz dimenzija greda i ploča poz. 200

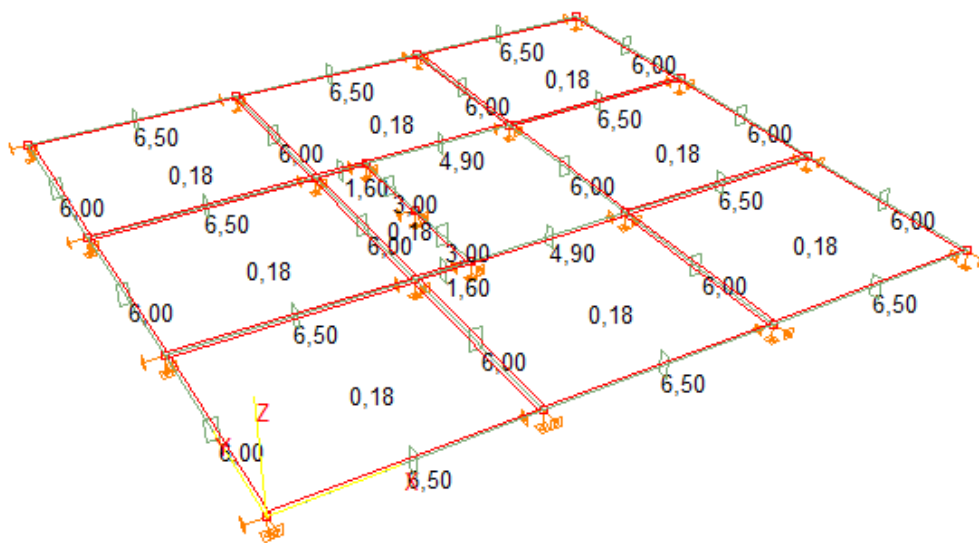

Slika 2.3. Prikaz dimenzija greda i ploča poz. 100

3. ANALIZA OPTEREĆENJA

3.1. POZICIJA 200 – KROV

3.1.1. Stalno opterećenje

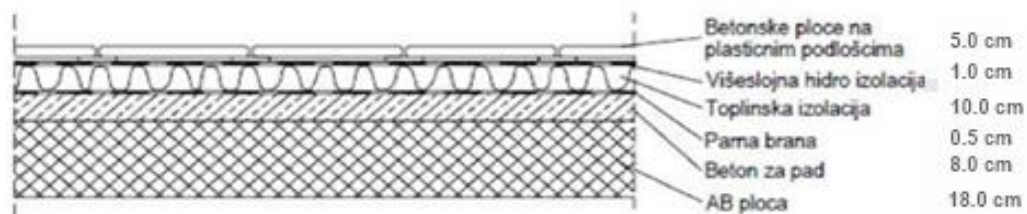

Slika 3.1. Presjek ploče poz. 200

Tablica 3.1. Stalno opterećenje poz.200

	d (m)	γ (kN/m ³)	d· γ (kN/m ²)
Betonske ploče na plastičnim podlošcima	0.05	25.0	1.25
Hidroizolacija + parna brana	0.01	20.0	0.20
Toplinska izolacija	0.10	5.0	0.50
Beton za pad	0.08	24.0	1.92
AB ploča	0.18	25.0	4.5

Ukupno stalno opterećenje: $g_{200} = 8.30$ (kN/m²)

3.1.2. Uporabno opterećenje

Za uporabno opterećenje uzima se opterećenje snijegom i vjetrom. Opterećenje snijegom za ravne krovove, u područjima gdje je snijeg rijedak (prema pravilniku) iznosi 0.50 kN/m², pa se za uporabno opterećenje neprohodnih ravnih krovova može uzeti zamjenjujuća vrijednost:

$$q_{200} = s + w \approx 1.0 \text{ kN/m}^2$$

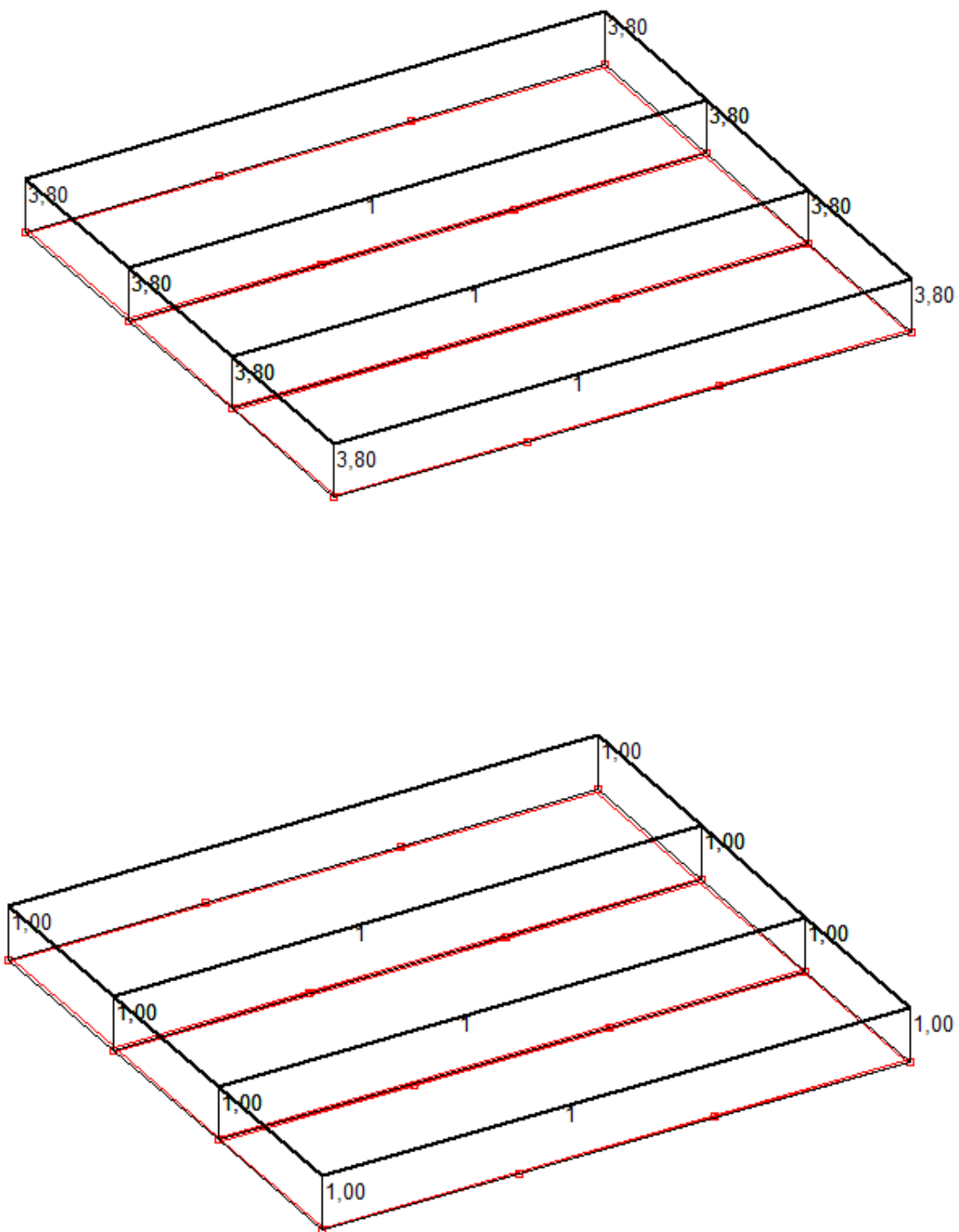

Slika 3.2. Prikaz dodatnog stalnog opterećenja G_0 i uporabnog opterećenja Q

3.2. POZICIJA 100 – ETAŽE

3.2.1. Stalno opterećenje

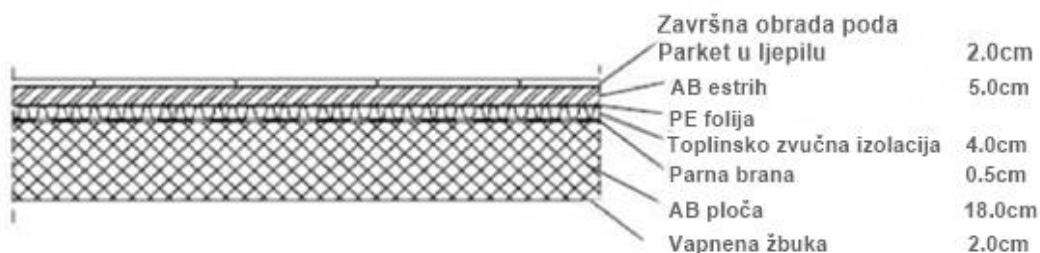

Slika 3.3. Presjek ploče poz. 100

Tablica 3.2. Stalno opterećenje poz. 100

	d (m)	γ (kN/m ³)	d· γ (kN/m ²)
Pregrade			1.00
Završna obrada poda-parket	0.02	12.0	0.24
AB estrih	0.05	25.0	1.25
Toplinska izolacija	0.04	5.0	0.20
Hidroizolacija	0.005	20.0	0.10
AB. Ploča	0.18	25.0	4.50
Pogled (vapnena žbuka)	0,02	19,00	0,38

Ukupno stalno opterećenje $g_{100} = 7,70$ (kN/m²)

3.2.2. Uporabno opterećenje

Uporabno opterećenje se uzima prema pravilniku: HRN EN 1991-2-1.

U našem slučaju, zadano je zadatkom $q_{100} = 3.7$ kN/m²

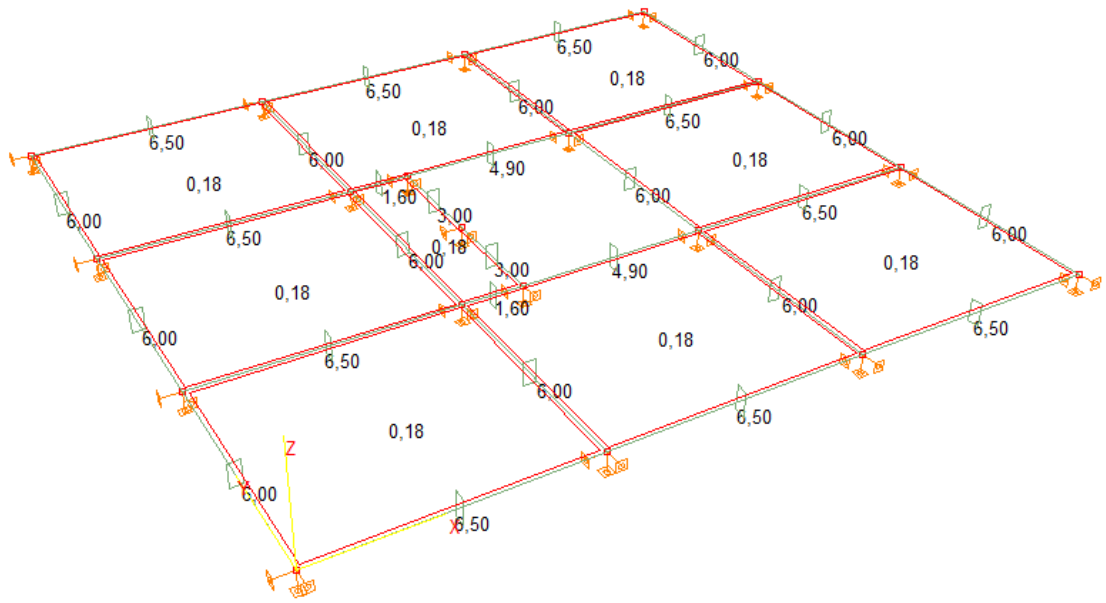

Slika 3.4. Geometrija etaže 100

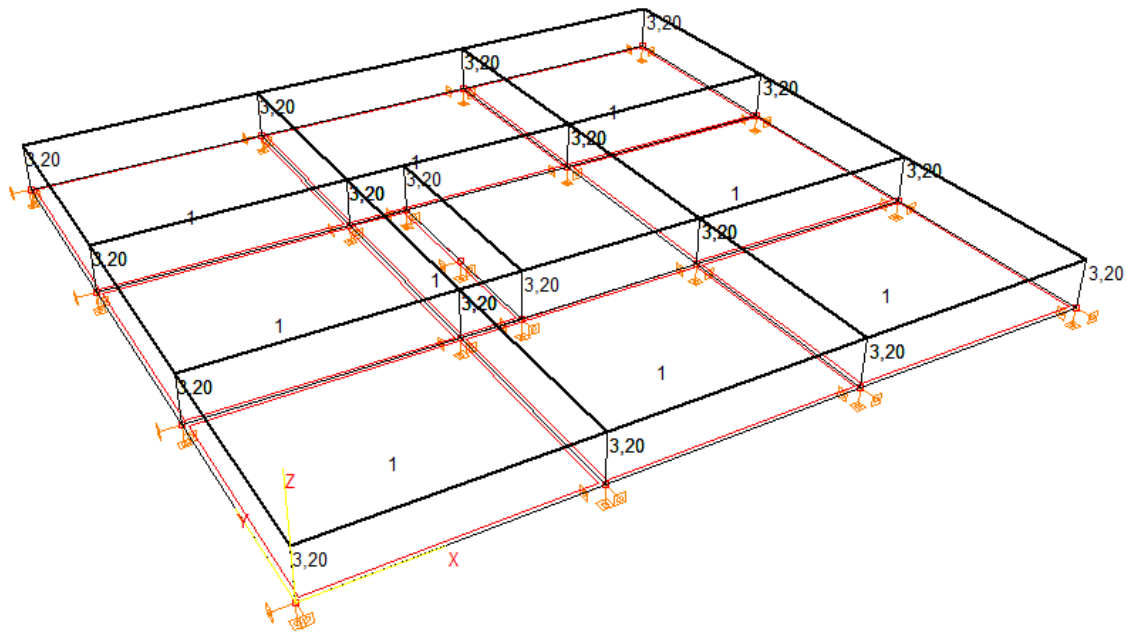

Slika 3.5 Prikaz dodatnog stalnog opterećenja G_0

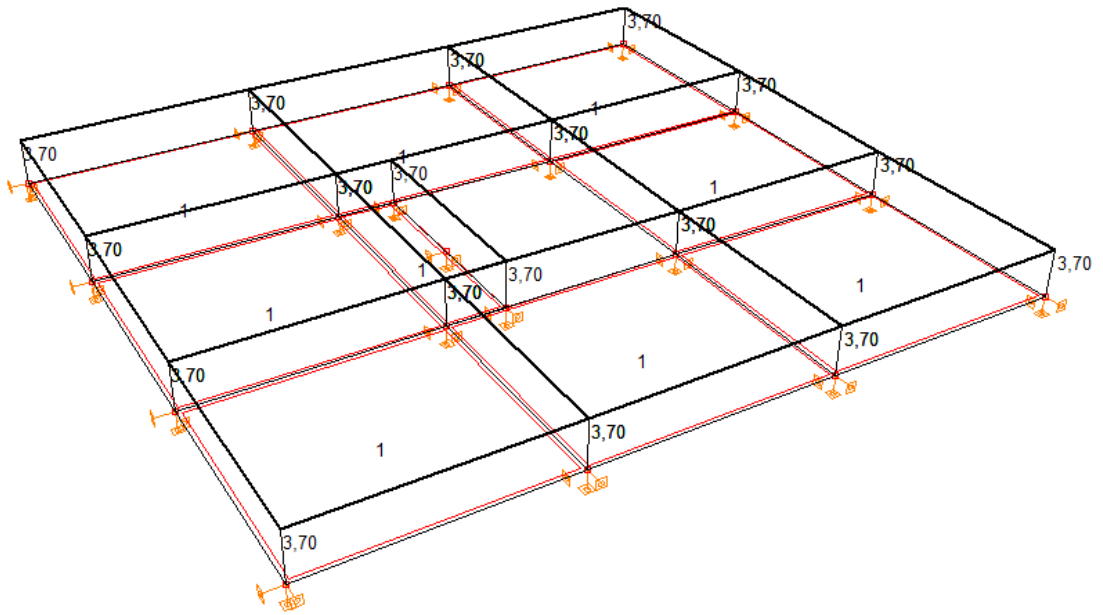

Slika 3.6 Prikaz uporabnog opterećenja shema 1 (max sile na ležajevima kod ploča)

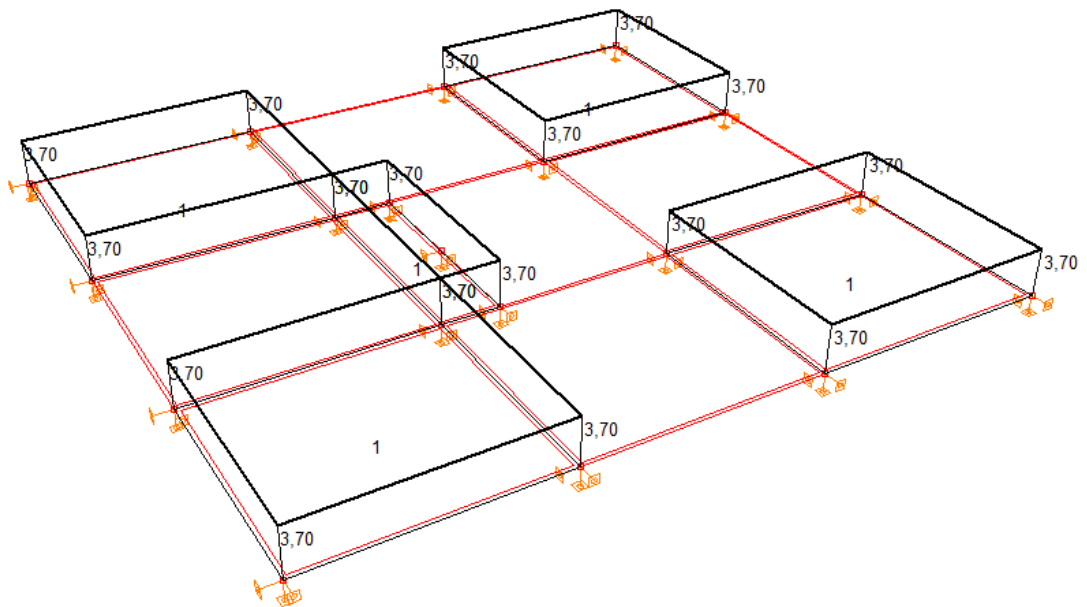

Slika 3.7. Prikaz uporabnog opterećenja shema 2(max sile u krajnjim poljima kod ploča)

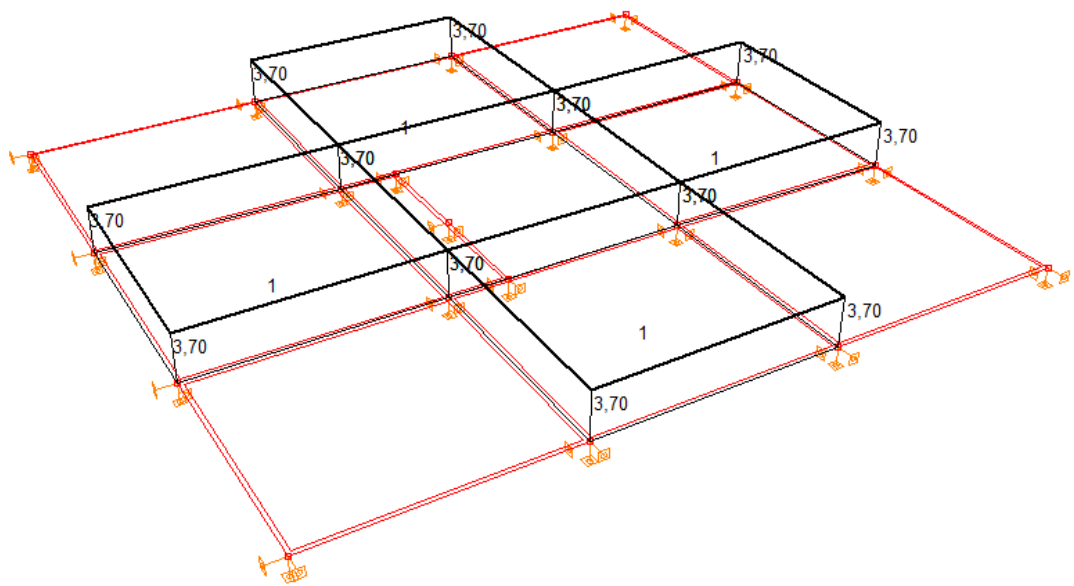

Slika 3.8. Prikaz uporabnog opterećenja shema 3(max sile u srednjem polju kod ploča)

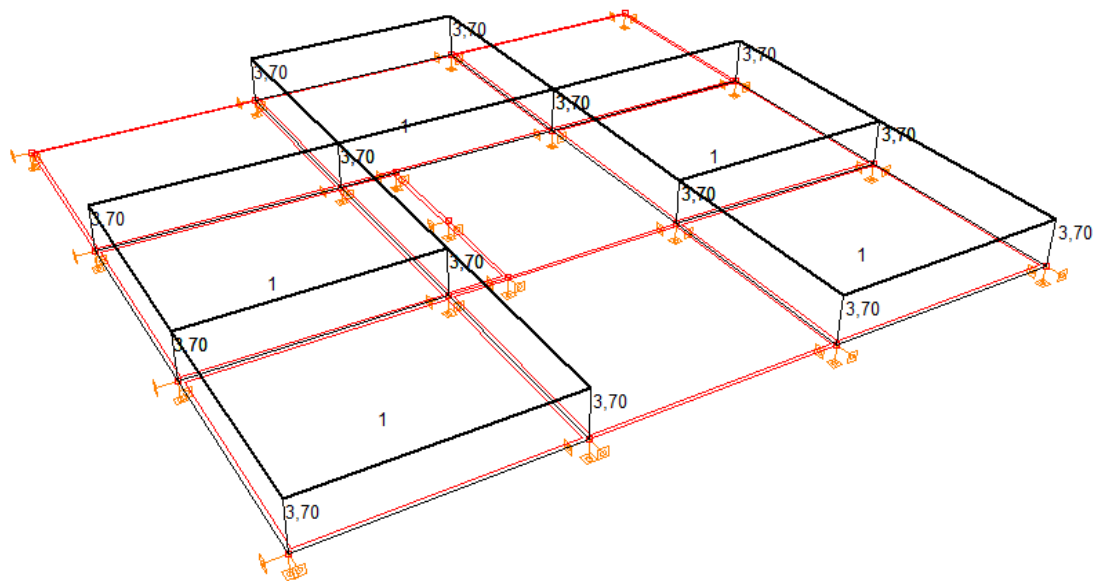

Slika 3.9. Prikaz uporabnog opterećenja shema 4(max sile u krajnjem polju kod grede)

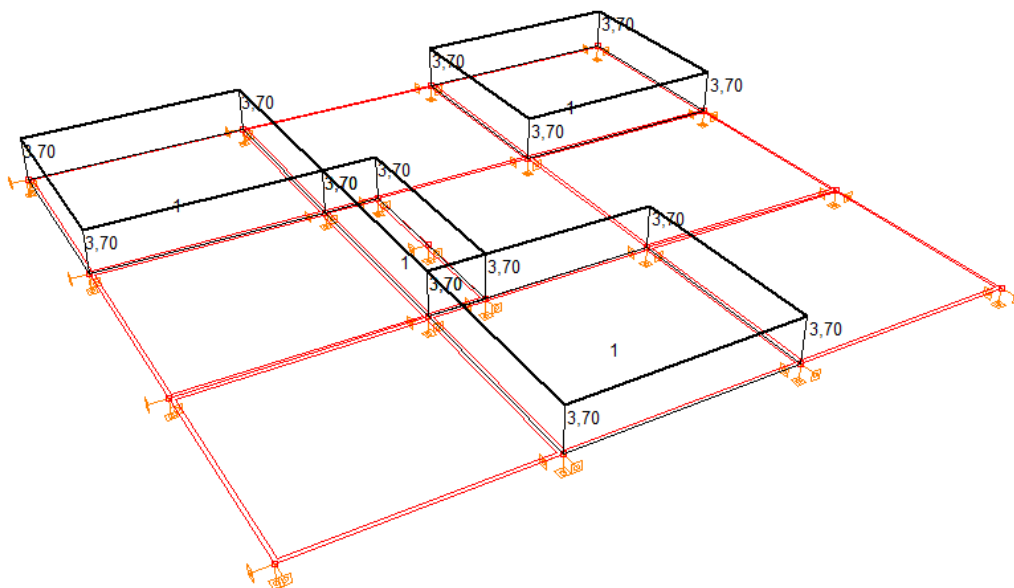

Slika 3.10. Prikaz uporabnog opterećenja shema 5 (max sile u srednjem polju kod grede)

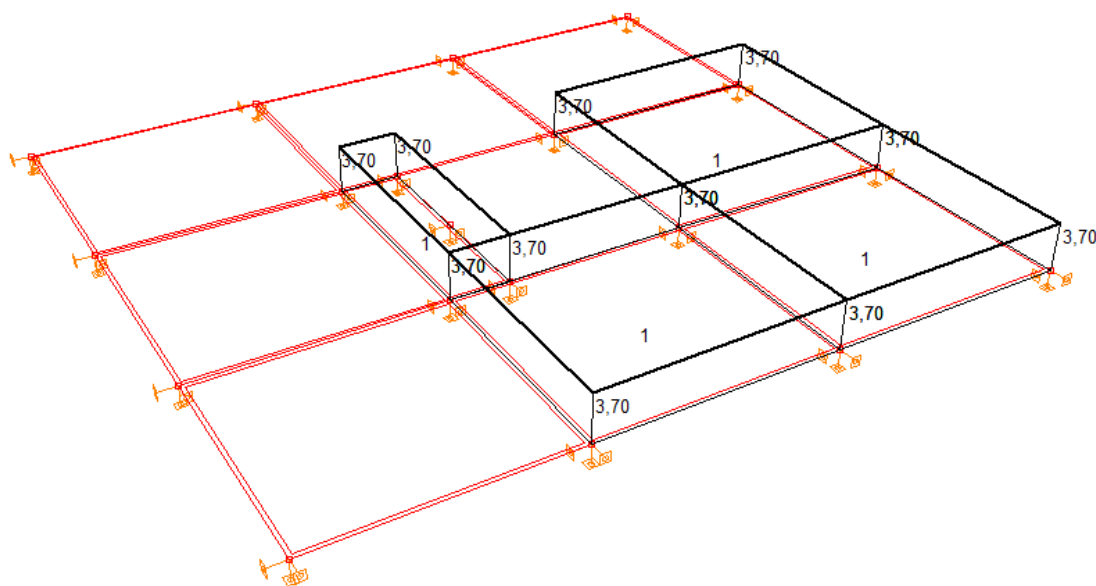

Slika 3.11. Prikaz uporabnog opterećenja shema 6(max sile na ležaju kod grede)

3.3. STUBIŠTE

3.3.1. Stalno opterećenje

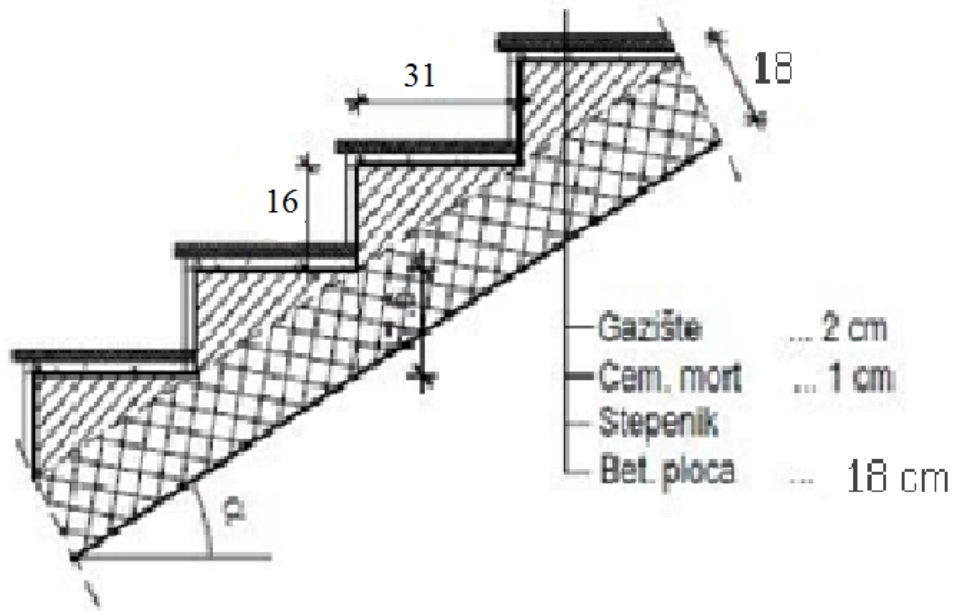

Slika 3.12. Presjek stubišta

- Broj stuba (za jedan stubišni krak):

$$n_s = H/2 \cdot v = 3,50/2 \cdot 0,1 = 11 \text{ stuba}$$

- Širina stuba:

$$2 \cdot v_s + \text{šs} = 63 \Rightarrow \text{šs} = 63 - 2 \cdot 0,16 = 31 \text{ cm}$$

- Duljina kraka:

$$L_k = n_s \cdot \text{šs} = 11 \cdot 31 = 340 \text{ cm}$$

- Kut α :

$$\text{tg} \alpha = 0,5 \cdot H/L_k = 1,75 \cdot 3,4 = 0,595 \Rightarrow$$

$$\alpha = 30,75^\circ$$

- Odabrana duljina podesta:

$$L_p \geq 1,20 \text{ m} \quad L_p = (L - L_k)/2 = (6,5 - 3,4)/2 = 1,6 \text{ m}$$

$$h' = \frac{h}{\cos \alpha} = \frac{18}{\cos 30,75} = 20,95 \text{ cm}$$

Tablica 3.3. Stalno opterećenje stubišta

	d (m)	γ (kN/m ³)	d· γ (kN/m ²)
Završna obrada gazišta – kamena ploča	0.02	28.0	0.56
Cementni namaz (max. 1,0 cm)	0.01	20.0	0.20
Stuba	0.075	24.0	1.80
AB ploča (h'=20,95 cm)	0.21	25.0	5,25

Ukupno stalno opterećenje : $g_{st} = 7,81$ (kN/m²)

3.3.2. *Uporabno opterećenje*

Uporabno opterećenje se uzima prema pravilniku: HRN EN 1991-2-1.

U našem slučaju, uzet ćemo ga jednako kao na pločama:

$q_{st} = 5,25$ (kN/m²)

3.4. OPTEREĆENJE VJETROM

Dimenzije zgrade su: $L_1=6.5\text{m}, L_2=6.0\text{m}, H=3.5\text{m}$.

Objekt se nalazi u II. vjetrovnoj zoni, na visini od 150 m.n.m

Osnovna brzina vjetra: $v_{b,0} = 30 \text{ m/s}$ (za II. Zonu)

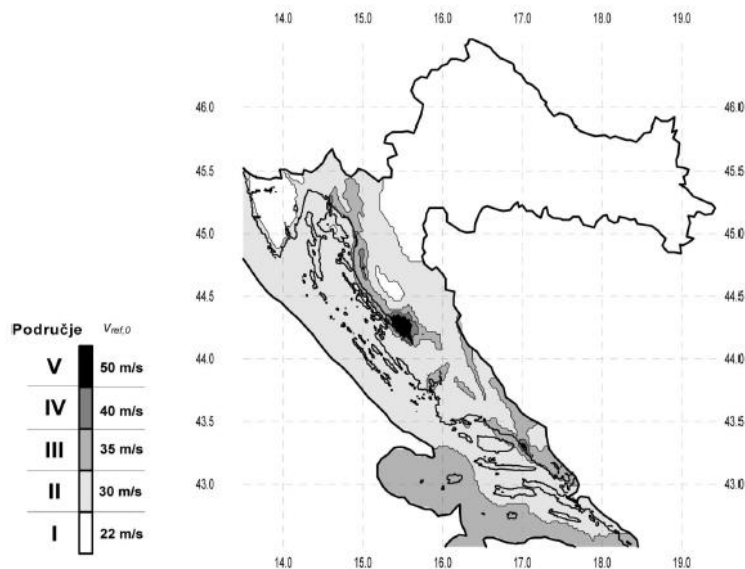

Slika 3.13. Zemljovid područja opterećenja vjetrom

Referentna brzina vjetra: $v_b = c_{DIR} \cdot c_{TEM} \cdot c_{ALT} \cdot v_{b,0}$

c_{DIR} - koeficijent smjera vjetra $\rightarrow c_{DIR} = 1.0$

c_{TEM} - koeficijent ovisan o godišnjem dobu $\rightarrow c_{TEM} = 1.0$

c_{ALT} - koeficijent nadmorske visine $\rightarrow c_{ALT} = 1 + 0,0001 \cdot a_s$

$$c_{ALT} = 1 + 0,0001 \cdot 150 = 1,015$$

$$v_b = 1,00 \cdot 1,00 \cdot 1,015 \cdot 30 = 30,45 \text{ m/s}$$

Zgrada ima veću širinu od visine, a za mjerodavnu visinu uzimamo ukupnu visinu.

Pretpostavimo da je na vrhu izgrađen AB parapet visine 0,5 m, mjerodavna visina tada iznosi:

$$z_e = 2 \cdot 3,5 + 0,5 = 7,5 \text{ m}$$

Mjerodavna visina je veća od minimalne (2,00 m), pa je koeficijent hrapavosti:

$$c_{r(z)} = k_r \cdot \ln\left(\frac{z_e}{z_0}\right)$$

Koeficijent terena k_r određuje se iz odgovarajuće tablice ovisno o kategoriji zemljišta.

Odabiremo III. kategoriju zemljišta.

Tablica 3.4. Kategorije terena i pripadni parametri

Kategorija terena	Opis	K_r	z_0 [m]	Z_{min} [m]
0	More ili područje uz more otvoreno prema moru	0.156	0.003	1
I	Uzburkano otvoreno more ili jezero, s najmanje 5 km dužine navjetrine i gladak ravan teren bez prepreka	0.170	0.01	1
II	Poljoprivredno zemljište s ogradama, povremenim malim poljoprivrednim objektima, kućama ili drvećem	0.190	0.05	2
III	Predgrađa ili industrijske zone i stalne šume	0.215	0.30	5
IV	Urbane zone u kojima je najmanje 15% površine pokriveno zgradama čija je srednja visina veća od 15 m	0.234	1.00	10

$$k_r = 0,215 \rightarrow c_r(z) = 0,215 \cdot \ln\left(\frac{7,5}{0,30}\right) = 0,762$$

Srednja brzina vjetra tako iznosi: $V_m(z) = C_r(z) \cdot C_0(z) \cdot V_b$

C_0 - koeficijent topografije (uglavnom se uzima 1.0)

$$v_m = 0,762 \cdot 1,0 \cdot 30,45 = 23,20 \text{ m/s}$$

Turbulencija:

$$I_v(z) = \frac{1}{c_0(z) \cdot \ln\left(\frac{z_e}{z_0}\right)} = \frac{1}{1,0 \cdot \ln\left(\frac{7,5}{0,30}\right)} = 0,282$$

Maksimalni tlak pri vršnoj brzini $q_p(z_e)$:

$$\rho_{zr} = 1,25 \text{ kg/m}^3$$

$$q_p(z) = [1 + 7 \cdot I_v(z)] \cdot \frac{\rho_{zr}}{2} \cdot v_m^2(z) = c_e(z) \cdot v_b(z)$$

$$q_p(z) = [1 + 7 \cdot 0,282] \cdot \frac{1,25}{2} \cdot 23,20^2 = 1000,45 \frac{\text{N}}{\text{m}^2} = 1,00 \frac{\text{kN}}{\text{m}^2}$$

Djelovanje na zgradu:

$$w_{1,e} = 0,8 \cdot q_p(z) = 0,8 \cdot 1,00 = 0,80 \frac{kN}{m^2}$$

$$w_{2,e} = 0,5 \cdot q_p(z) = 0,5 \cdot 1,00 = 0,50 \frac{kN}{m^2}$$

$$w_{1,I} = 0,75 \cdot w_{1,e} = 0,75 \cdot 0,80 = 0,60 \frac{kN}{m^2}$$

$$w_{2,I} = 0,75 \cdot w_{2,e} = 0,75 \cdot 0,50 = 0,375 \frac{kN}{m^2}$$

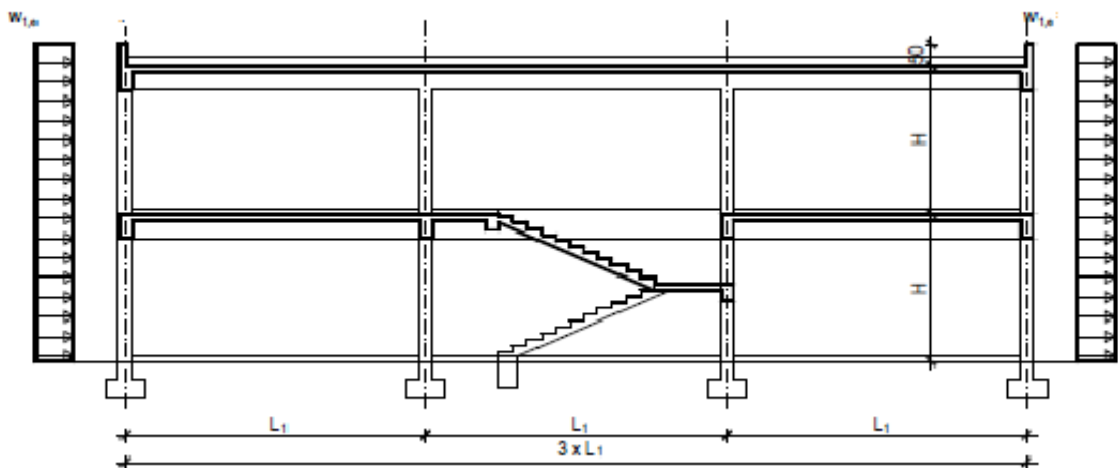

Slika 3.14. Opterećenje vjetrom

Silu vjetra zadajemo u čvorovima modela. Određivanje sila u čvorovima modela vršimo prema utjecajnim površinama djelovanja vjetra.

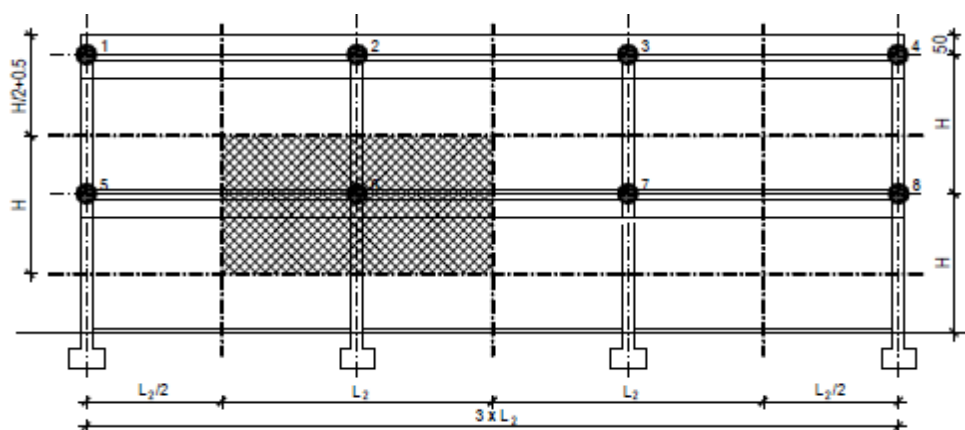

Slika 3.15. Utjecajne površine djelovanja vjetra

➤ **X smjer**

Tablica 3.5. Lijevi bok

Čvor	Utjecajna površina			Tlak vjetra(kN/m ²)	Sila u čvoru(kN)
	Širina(m)	Visina(m)	Površina(m ²)		
1	3.0	2.25	6.75	0.80	5,40
2	6.0	2.25	13.50	0.80	10,80
3	6.0	2.25	13.50	0.80	10,80
4	3.0	2.25	6.75	0.80	5,40
5	3.0	3.5	10.50	0.80	8,40
6	6.0	3.5	21.0	0.80	16,80
7	6.0	3.5	21.0	0.80	16.80
8	3.0	3.5	10.50	0.80	8.40

Tablica 3.6. Desni bok

Čvor	Utjecajna površina			Tlak vjetra(kN/m ²)	Sila u čvoru(kN)
	Širina(m)	Visina(m)	Površina(m ²)		
1	3.0	2.25	6.75	0.50	3.375
2	6.0	2.25	13.50	0.50	6,75
3	6.0	2.25	13.50	0.50	6,75
4	3.0	2.25	6.75	0.50	3.375
5	3.0	3.5	10.50	0.50	5.25
6	6.0	3.5	21.0	0.50	10.50
7	6.0	3.5	21.0	0.50	10.50
8	3.0	3.5	10.50	0.50	5.25

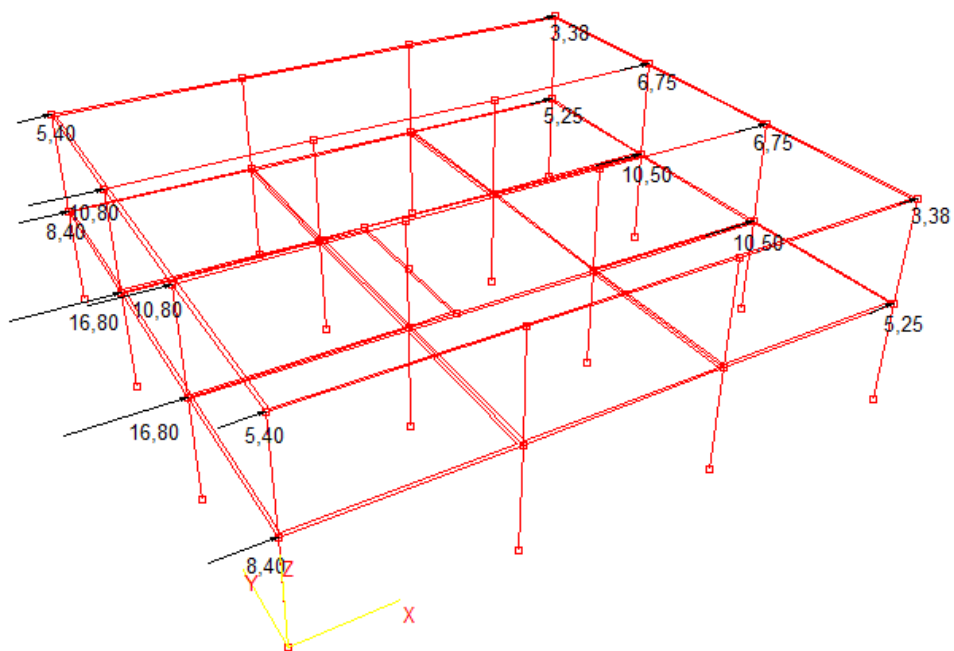

Slika 3.16. Djelovanje vjetra u X smjeru (sile u kN)

➤ **Y smjer**

Tablica 3.7. Prednja strana

Čvor	Utjecajna površina			Tlak vjetra(kN/m ²)	Sila u čvoru(kN)
	Širina(m)	Visina(m)	Površina(m ²)		
1	3.25	2.25	7,313	0.80	5,85
2	6.50	2.25	14,63	0.80	11,70
3	6.50	2.25	14,63	0.80	11,70
4	3.25	2.25	7,313	0.80	5,85
5	3.25	3.5	11,38	0.80	9,10
6	6.50	3.5	22,75	0.80	18,20
7	6.50	3.5	22,75	0.80	18.20
8	3.25	3.5	11,38	0.80	9.10

Tablica 3.8. Stražnja strana

Čvor	Utjecajna površina			Tlak vjetra(kN/m ²)	Sila u čvoru(kN)
	Širina(m)	Visina(m)	Površina(m ²)		
1	3.25	2.25	7,313	0.50	3,66
2	6.50	2.25	14,63	0.50	7.32
3	6.50	2.25	14,63	0.50	7.32
4	3.25	2.25	7,313	0.50	3.66
5	3.25	3.5	11,38	0.50	5.69
6	6.50	3.5	22,75	0.50	11,38
7	6.50	3.5	22,75	0.50	11,38
8	3.25	3.5	11,38	0.50	5.69

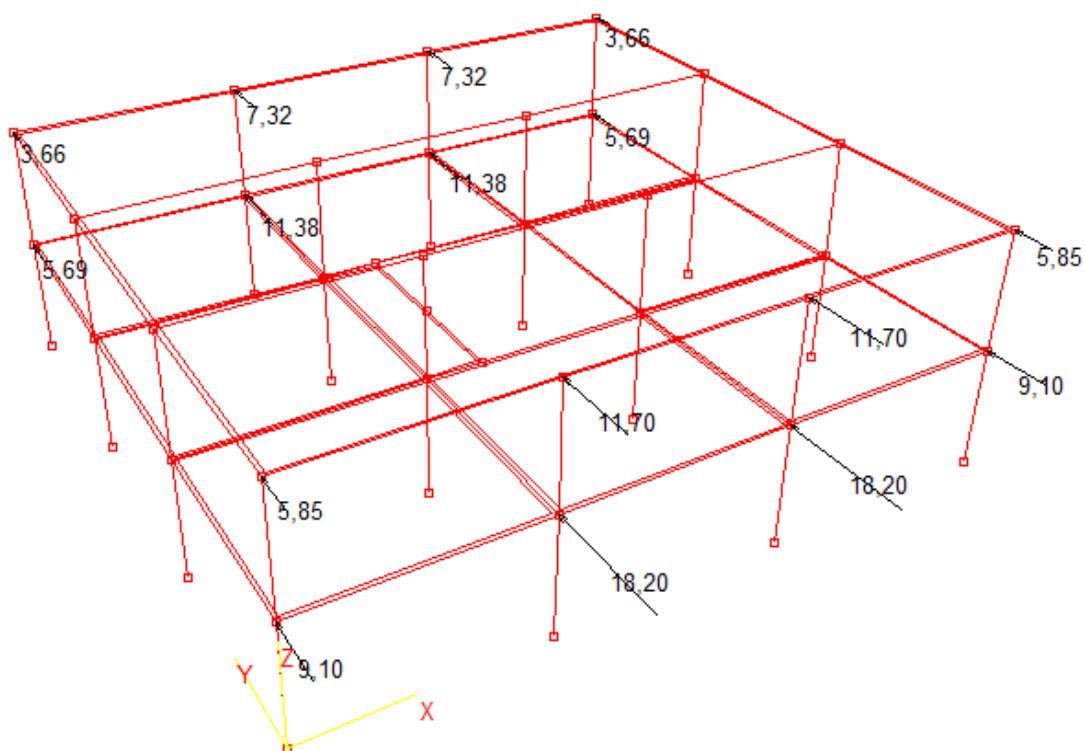

Slika 3.17. Djelovanje vjetra u Y smjeru (sile u kN)

4. PRORAČUN PLOČA POZICIJE 200

- Proračun reznih sila vršio se kompjuterskim programom *AspalathosLinear*. Prikaz rezultata dan je odvojeno za ploče i grede.

4.1. MOMENTI SAVIJANJA U PLOČI POZICIJE 200

4.1.1. Vlastita težina

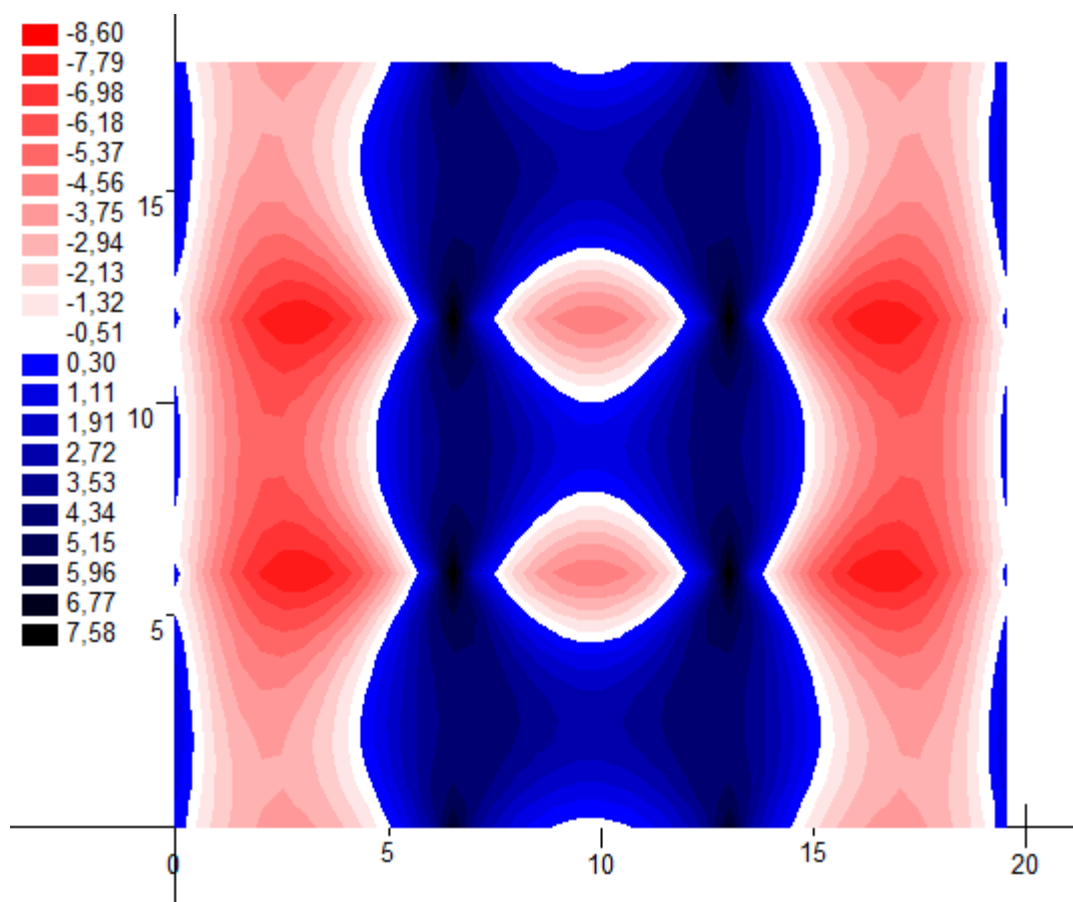

Slika 4.1. Momenti M_x (kNm)

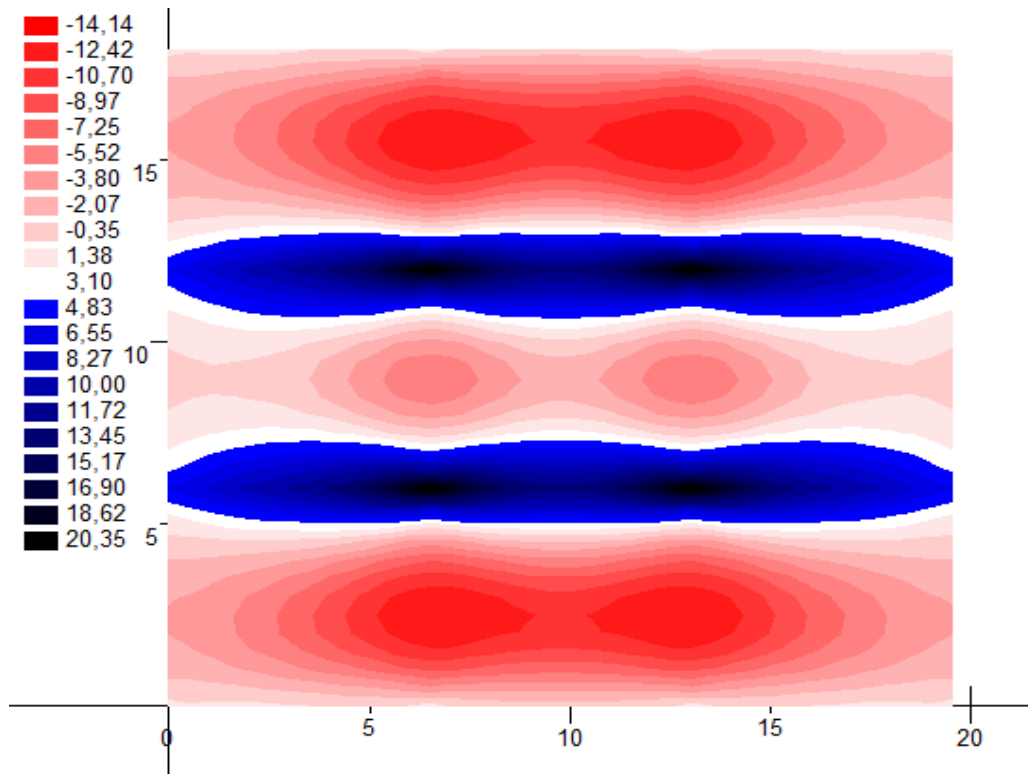

Slika 4.2. Momenti M_y (kNm)

4.1.2. Dodatno stalno opterećenje

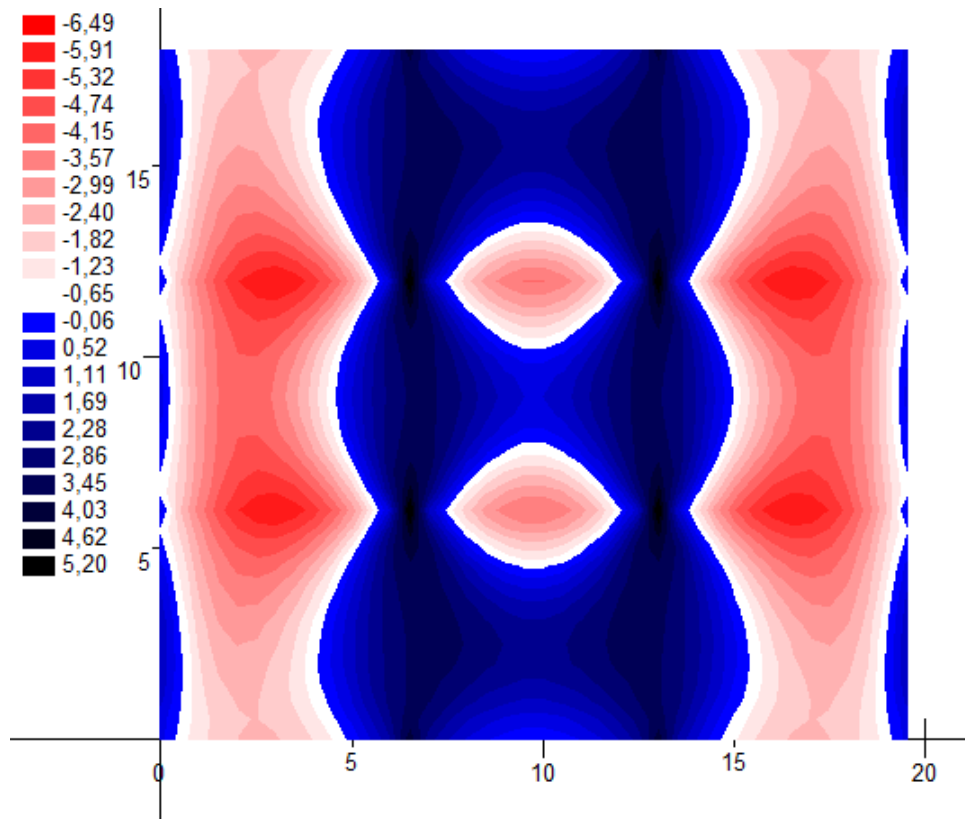

Slika 4.3. Momenti M_x (kNm)

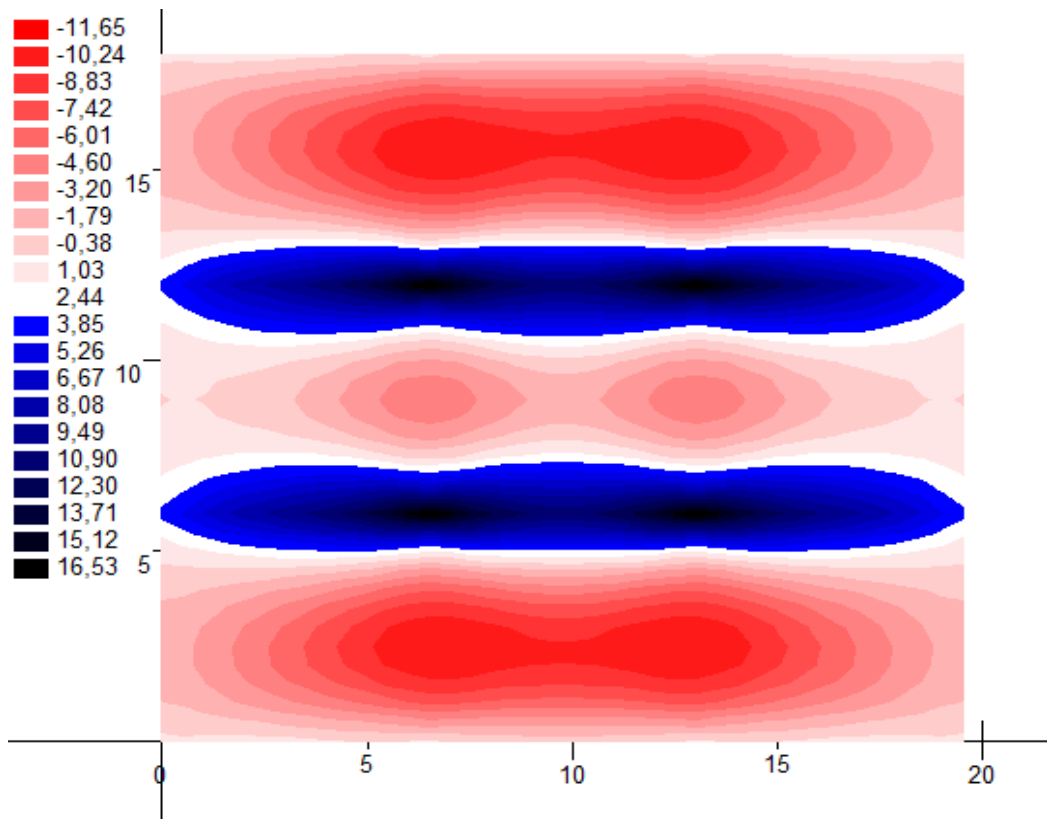

Slika 4.4. Momenti M_y (kNm)

4.1.3. Uporabnoopterećenje

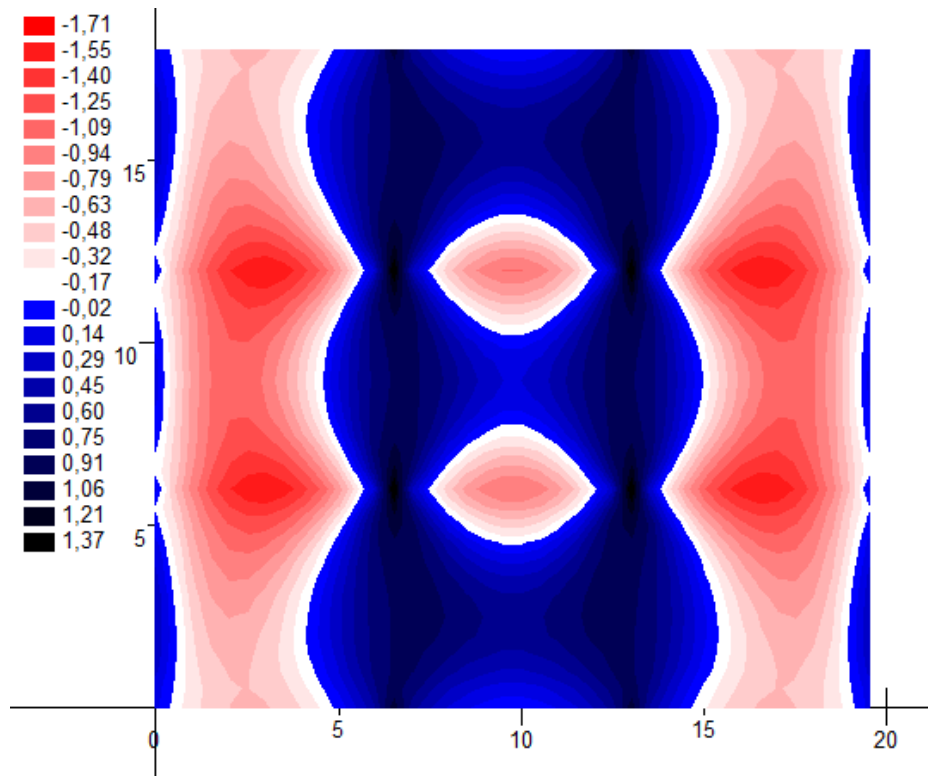

Slika 4.5. Momenti M_x (kNm)

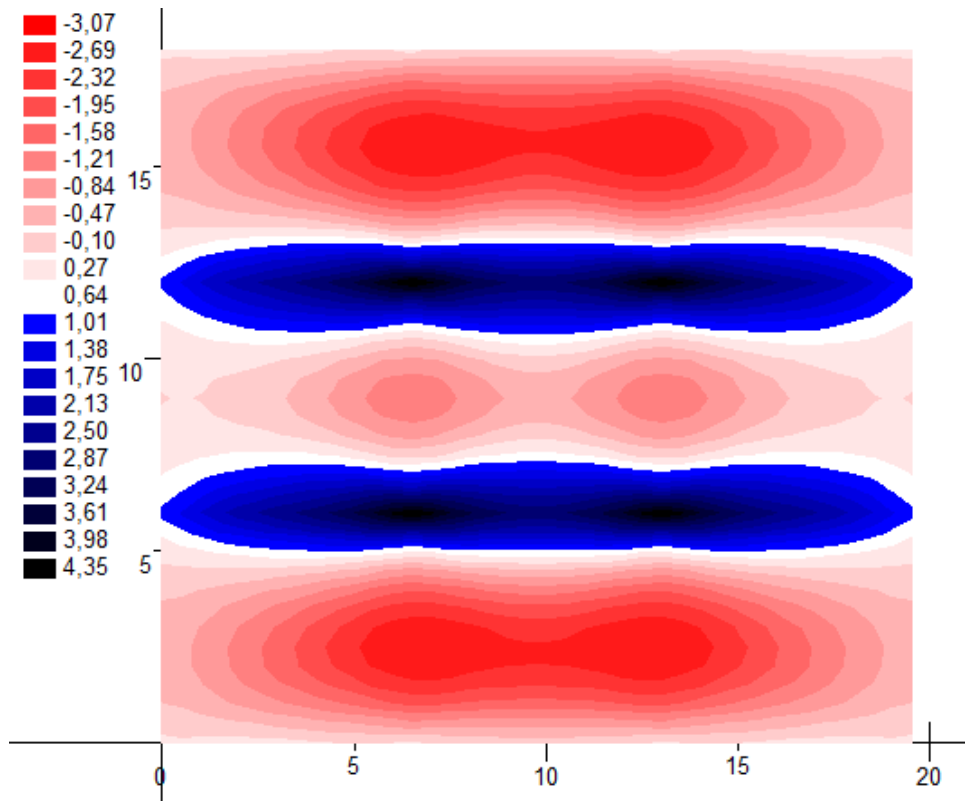

Slika 4.6. Momenti M_y (kNm)

4.1.4. Granično stanje nosivosti

Mjerodavna kombinacija: $M_{ed}=1,35*(M_g+M_{\Delta g})+1,5*M_q$

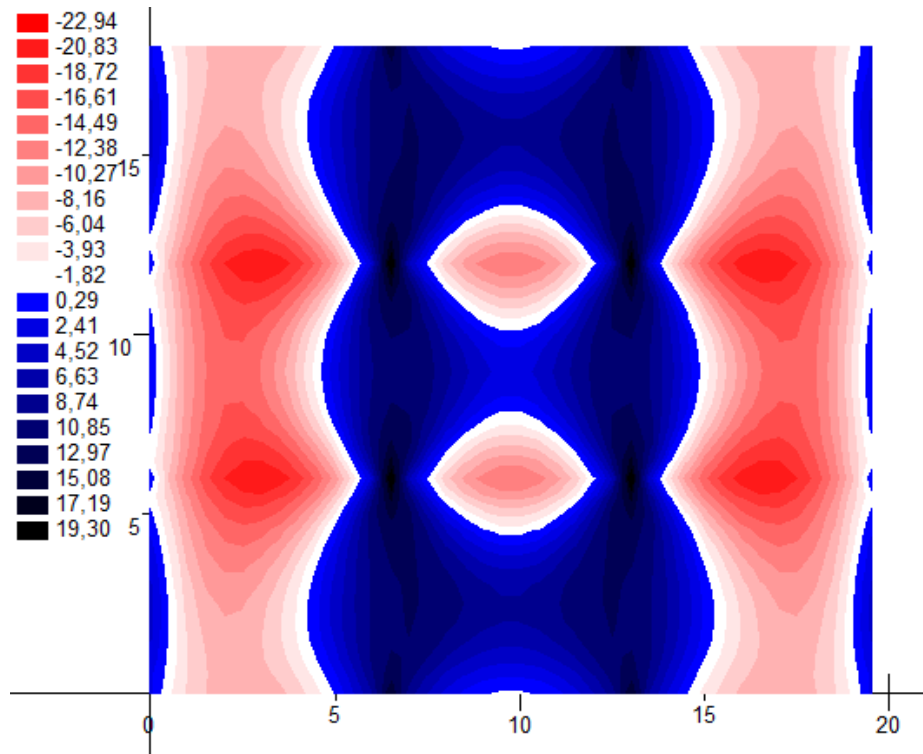

Slika 4.7. Momenti M_x (kNm)

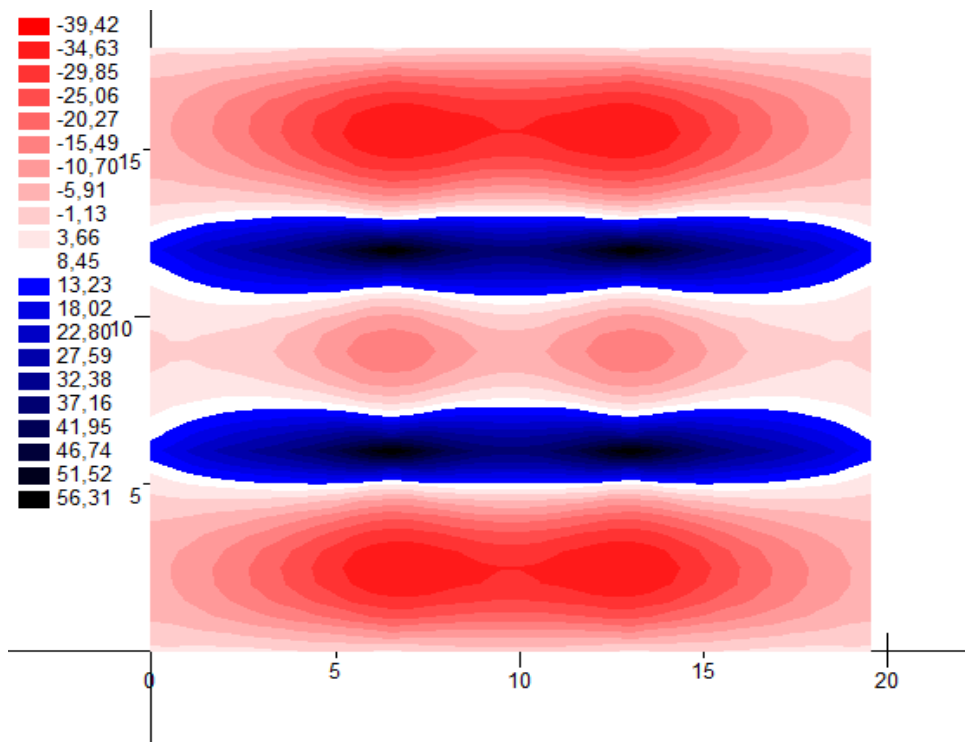

Slika 4.8. Momenti M_y (kNm)

4.2. DIMENZIONIRANJE PLOČA POZICIJE 200

BETON:C 30/37;

$$f_{ck} = 30,0 \text{ MPa} = 30 \text{ N/mm}^2; \gamma_c = 1,5$$

$$f_{cd} = f_{ck}/\gamma_c = 30,0/1,5 = 20,0 \text{ MPa} = 20,0 \text{ N/mm}^2 = 2,0 \text{ kN/cm}^2$$

ARMATURA:B 450 BC;

$$f_{yk} = 450,0 \text{ MPa} = 450 \text{ N/mm}^2; \gamma_s = 1,15$$

$$f_{yd} = f_{yk}/\gamma_s = 450,0/1,15 = 391,3 \text{ MPa} = 391,3 \text{ N/mm}^2 = 39,13 \text{ kN/cm}^2$$

DEBLJINA PLOČE: $h=18 \text{ cm}$

ZAŠTITNI SLOJ: $c=3 \text{ cm}$

STATIČKA VISINA PLOČE:

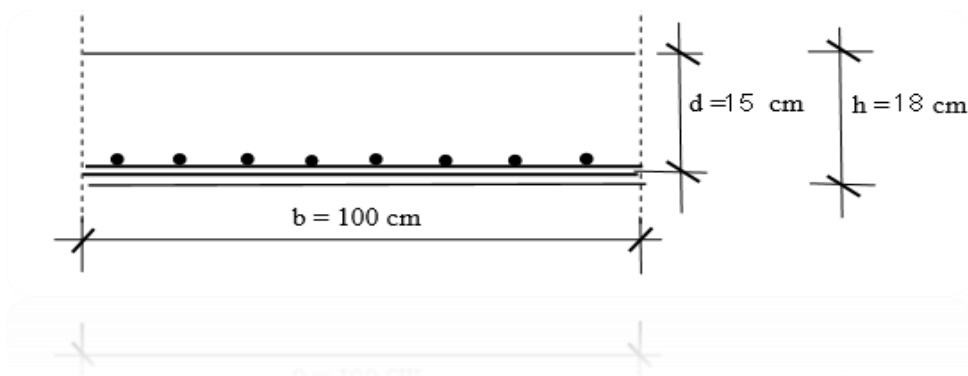

Slika 4.9. Poprečni presjek ploče

$$d = h - d_1$$

$$d_1 = c + \frac{\emptyset}{2} = 2,5 + 0,5 = 3 \text{ cm}$$

$c \rightarrow$ zaštitni sloj

STATIČKA VISINA PLOČE:

$$d = 18 - 3 = 15 \text{ cm}$$

Za sve presjeka odabrana je statička visina ploče $d=15 \text{ cm}$. Izvršen je proračun armature za kombinaciju :

$$1.35 \times \text{vl.težina} + 1.35 \times \text{dodatno stalno} + 1.5 \times \text{uporabno}$$

Ploča 201 – Polje

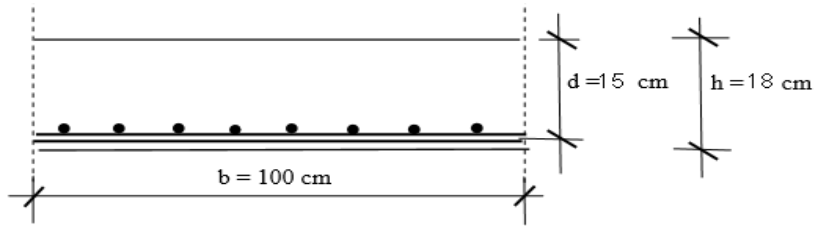

$$M_{ed} = 39,42 \text{ kNm/m}$$

$$\mu_{sd} = \frac{M_{ed}}{b_{eff} \cdot d^2 \cdot f_{cd}} = \frac{3942}{100 \cdot 15^2 \cdot 2,0} = 0,088$$

$$\text{Očitano: } \varepsilon_{s1} = 10,0 \text{ ‰} \quad \varepsilon_{c2} = 2,0 \text{ ‰} \quad \zeta = 0,938 \quad \xi = 0,167$$

$$A_{s1} = \frac{M_{ed}}{\zeta \cdot d \cdot f_{yd}} = \frac{3942}{0,938 \cdot 15 \cdot 39,13} = 7,15 \text{ cm}^2/\text{m}$$

ODABRANO: **R-785** ($A_s = 7,85 \text{ cm}^2/\text{m}$)

Ploča 202 - Polje

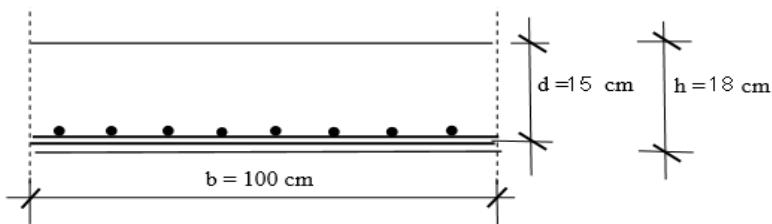

$$M_{ed} = 19,30 \text{ kNm/m}$$

$$\mu_{sd} = \frac{M_{ed}}{b_{eff} \cdot d^2 \cdot f_{cd}} = \frac{1930}{100 \cdot 15^2 \cdot 2,0} = 0,042$$

$$\text{Očitano: } \varepsilon_{s1} = 10,0 \text{ ‰} \quad \varepsilon_{c2} = 1,3 \text{ ‰} \quad \zeta = 0,959 \quad \xi = 0,048$$

$$A_{s1} = \frac{M_{ed}}{\zeta \cdot d \cdot f_{yd}} = \frac{1930}{0,959 \cdot 15 \cdot 39,13} = 3,43 \text{ cm}^2/\text{m}$$

ODABRANO: **R-385** ($A_s = 3,85 \text{ cm}^2/\text{m}$)

Ležaj 201-202

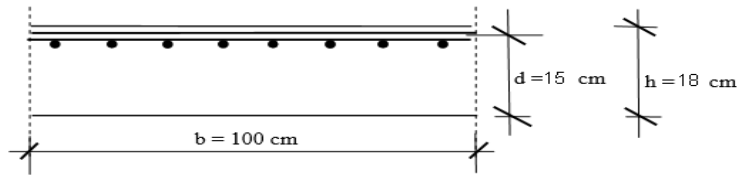

$$M_{ed} = 56,31 \text{ kNm/m}$$

$$\mu_{sd} = \frac{M_{ed}}{b_{eff} \cdot d^2 \cdot f_{cd}} = \frac{5631}{100 \cdot 15^2 \cdot 2,0} = 0,125$$

$$\text{Očitano: } \varepsilon_{s1} = 10,0 \text{ ‰} \quad \varepsilon_{c2} = 2,7 \text{ ‰} \quad \zeta = 0,916 \quad \xi = 0,136$$

$$A_{s1} = \frac{M_{ed}}{\zeta \cdot d \cdot f_{yd}} = \frac{5631}{0,916 \cdot 15 \cdot 39,13} = 10,4 \text{ cm}^2/\text{m}$$

ODABRANO: **R-785** ($A_s = 7,85 \text{ cm}^2/\text{m}$) + preklop povećan na 80 cm

$$A'_{s1} = A_{s1} \cdot \frac{\check{s}_m + p_m}{\check{s}_m} = 7,85 \cdot \frac{215 + 80}{215} = 10,8 \text{ cm}^2/\text{m}$$

Minimalna armatura:

$$A_{s1, \min} \geq 0,26 \cdot [f_{ct,m} / f_{yk}] \cdot b \cdot d \geq 0,0011 \cdot b \cdot d$$

b – širina vlačne zone

d – statička visina presjeka

f_{yk} – karakt. granica popuštanja čelika u N/mm²

[$f_{yk} = 450 \text{ N/mm}^2$ za čelik B 450 BC]

$f_{ct,m}$ - srednja vlačna čvrstoća betona (iz tablice)

[$f_{ct,m} = 2,9 \text{ N/mm}^2$ za C 30/37]

$$A_{s1, \min} \geq 0,26 \cdot 2,9 / 450 \cdot 100 \cdot 15,0 = 2,51 \text{ cm}^2 / \text{m}$$

$$A_{s1, \min} \geq 0,0011 \cdot b \cdot d = 0,0011 \cdot 100 \cdot 15,0 = 1,65 \text{ cm}^2 / \text{m}$$

5. PRORAČUN PLOČA POZICIJE 100

5.1. MOMENTI SAVIJANJA U PLOČI POZICIJE 100

5.1.1. Vlastita težina

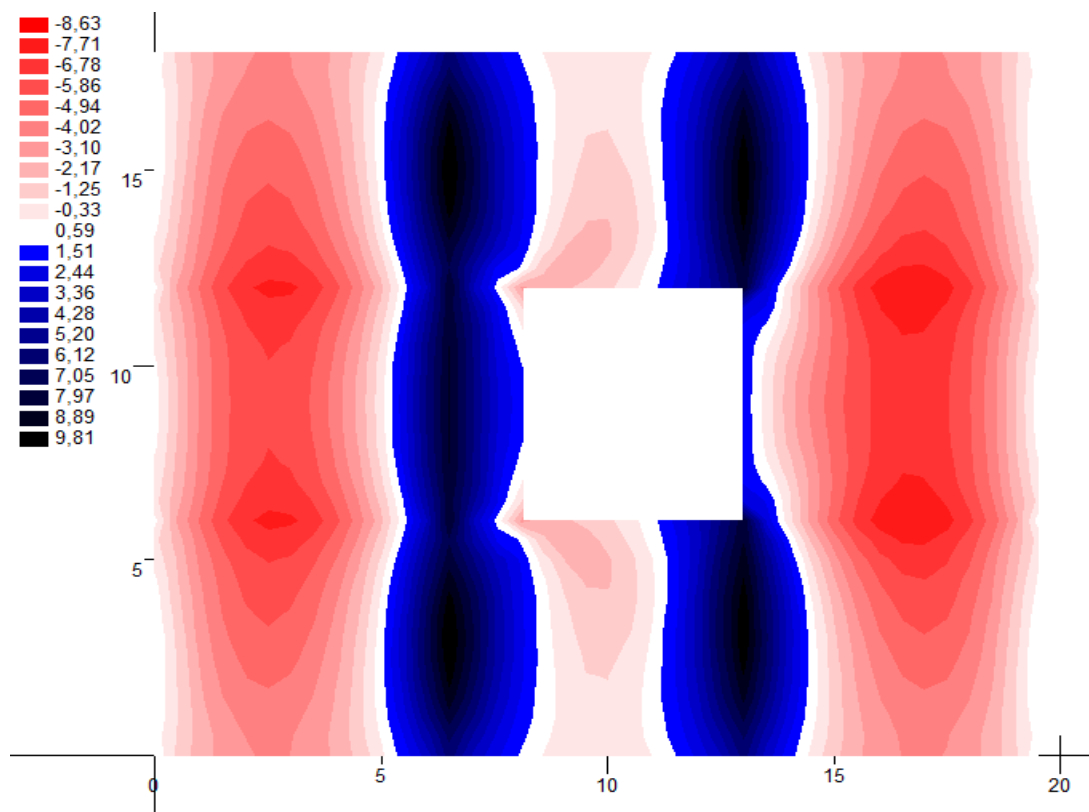

Slika 5.1. Momenti M_x (kNm)

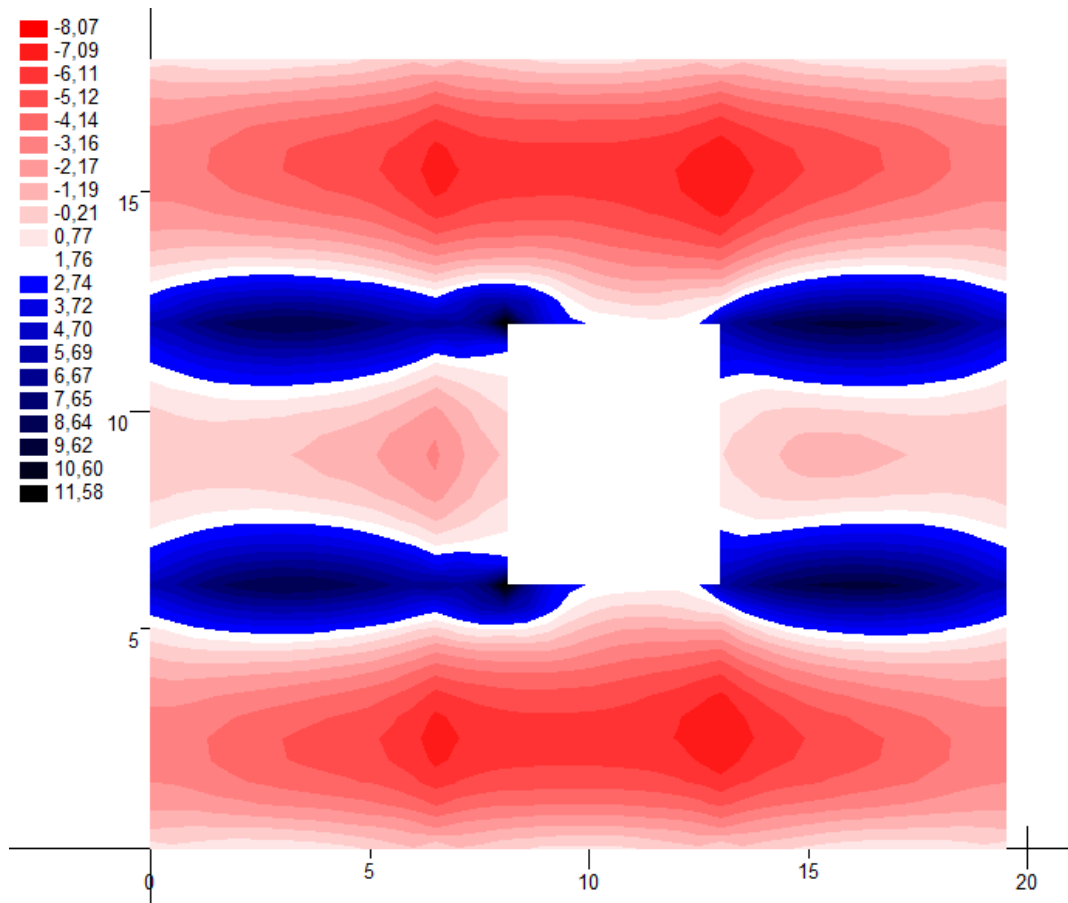

Slika 5.2. Momenti M_y (kNm)

5.1.2. Dodatno stalno opterećenje

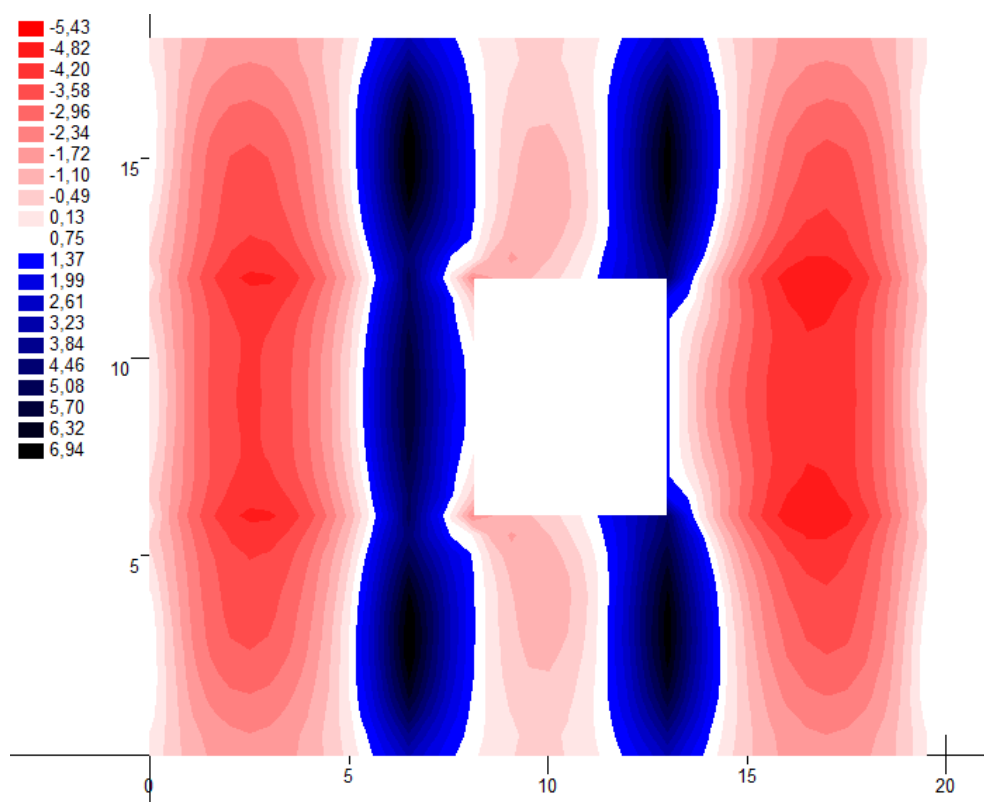

Slika 5.3. Momenti M_x (kNm)

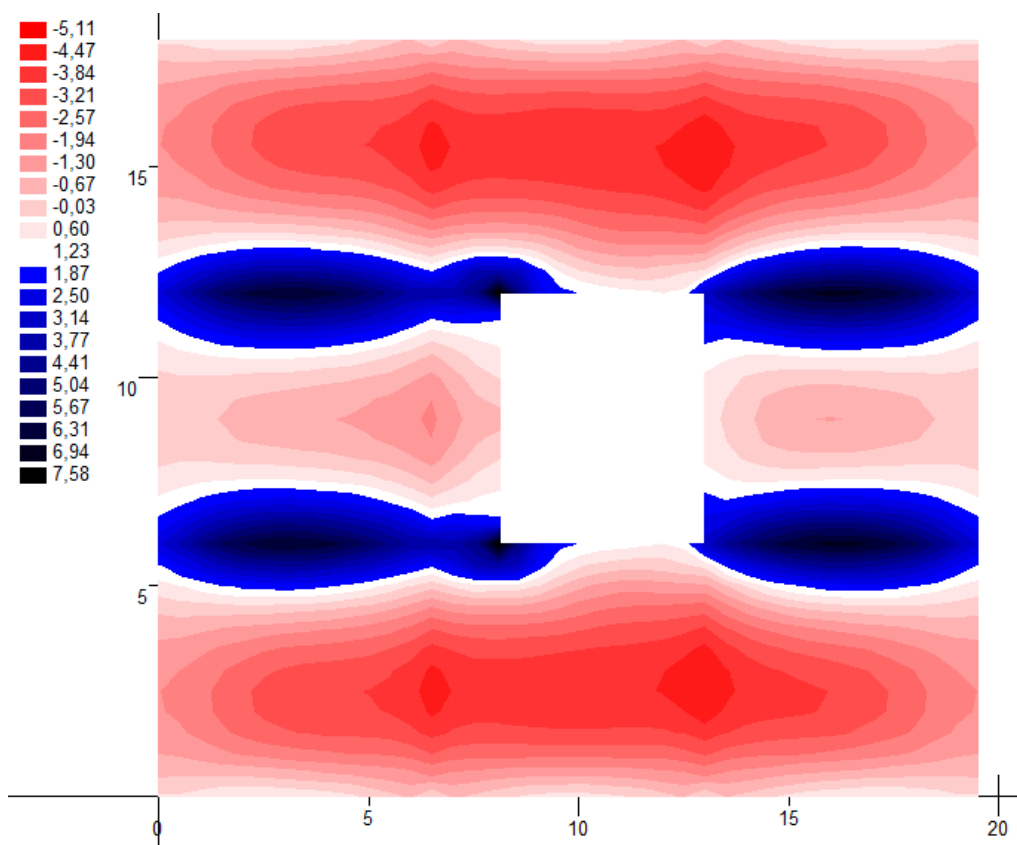

Slika 5.4. Momenti M_y (kNm)

5.1.3. Uporabno opterečenje shema 1 (max momenti na ležajevima)

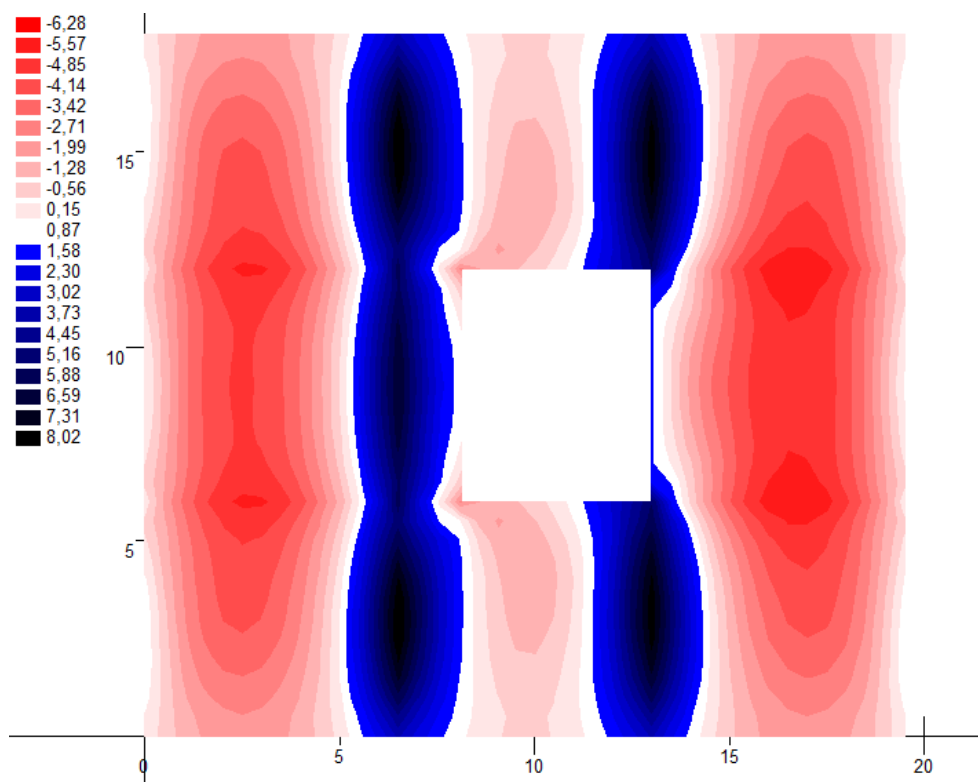

Slika 5.5. Momenti M_x (kNm)

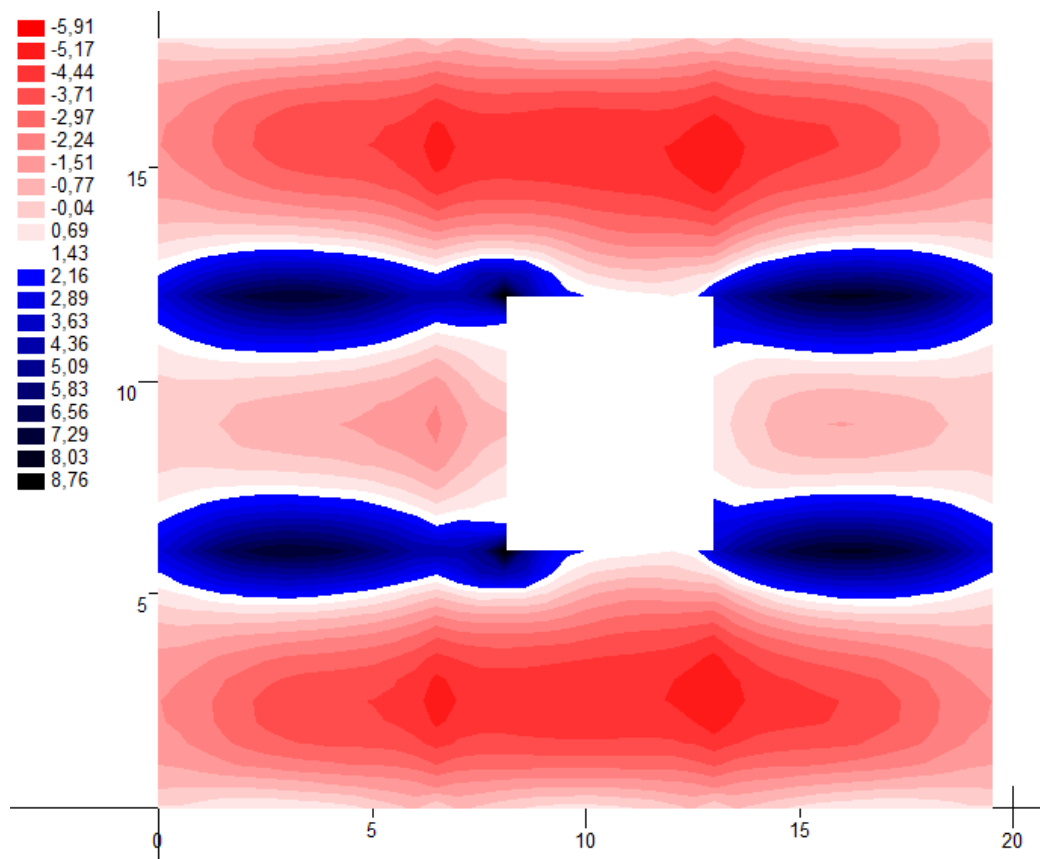

Slika 5.6. Momenti M_y (kNm)

5.1.4. Uporabno-opterečenje shema 2(max momenti u krajnjim poljima)

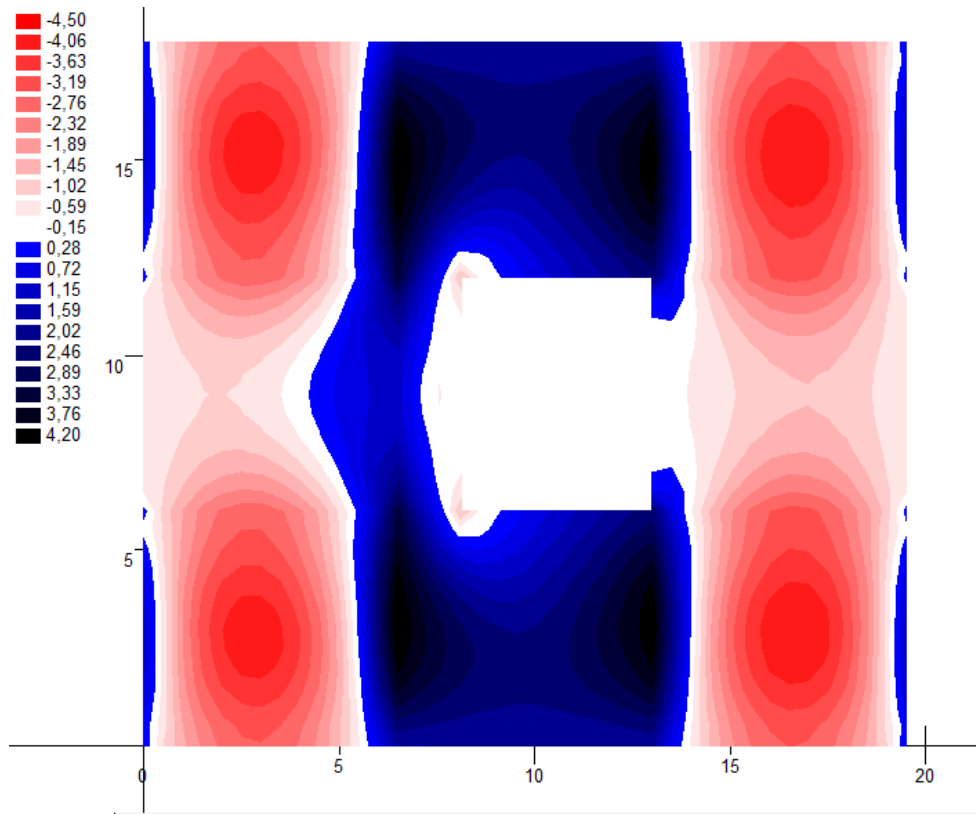

Slika 5.7. Momenti M_x (kNm)

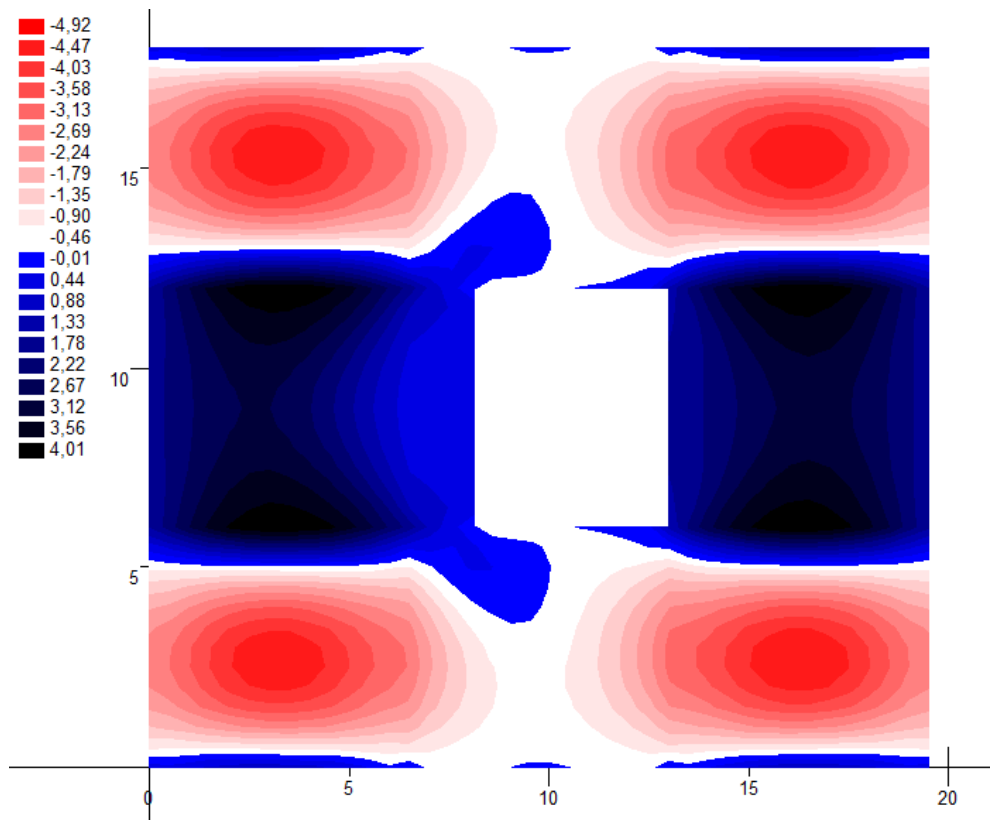

Slika 5.8. Momenti M_y (kNm)

5.1.5. Uporabnoopterećenje shema 3 (max momenti u srednjem polju)

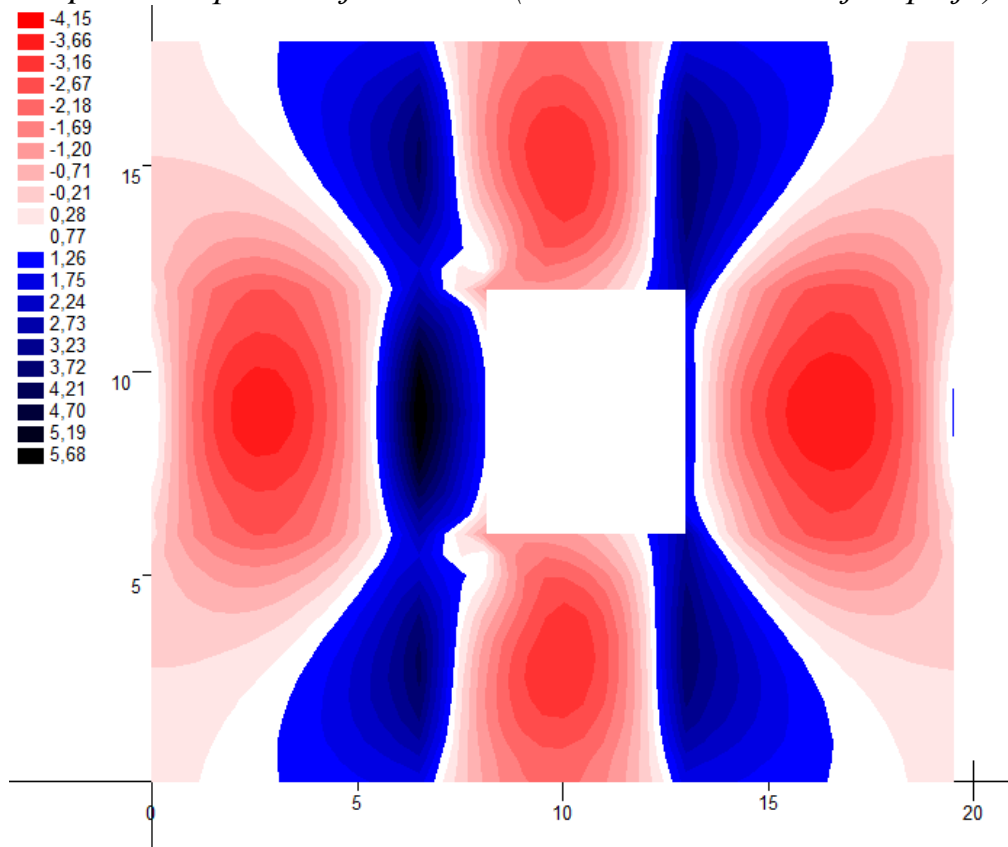

Slika 5.9. Momenti M_x (kNm)

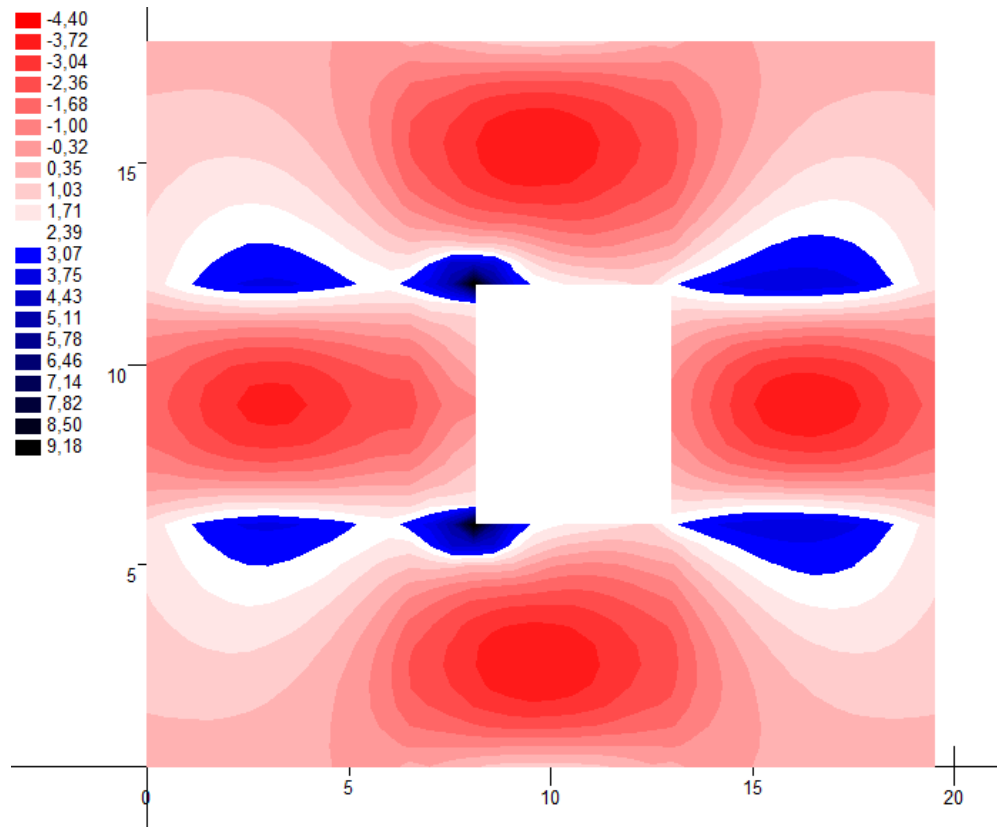

Slika 5.10. Momenti M_y (kNm)

5.1.6. GSN za ležajeve

Mjerodavna kombinacija za proračun GSN: $M_{ed}=1,35*(M_g+M_{\Delta g})+1,5*M_q$

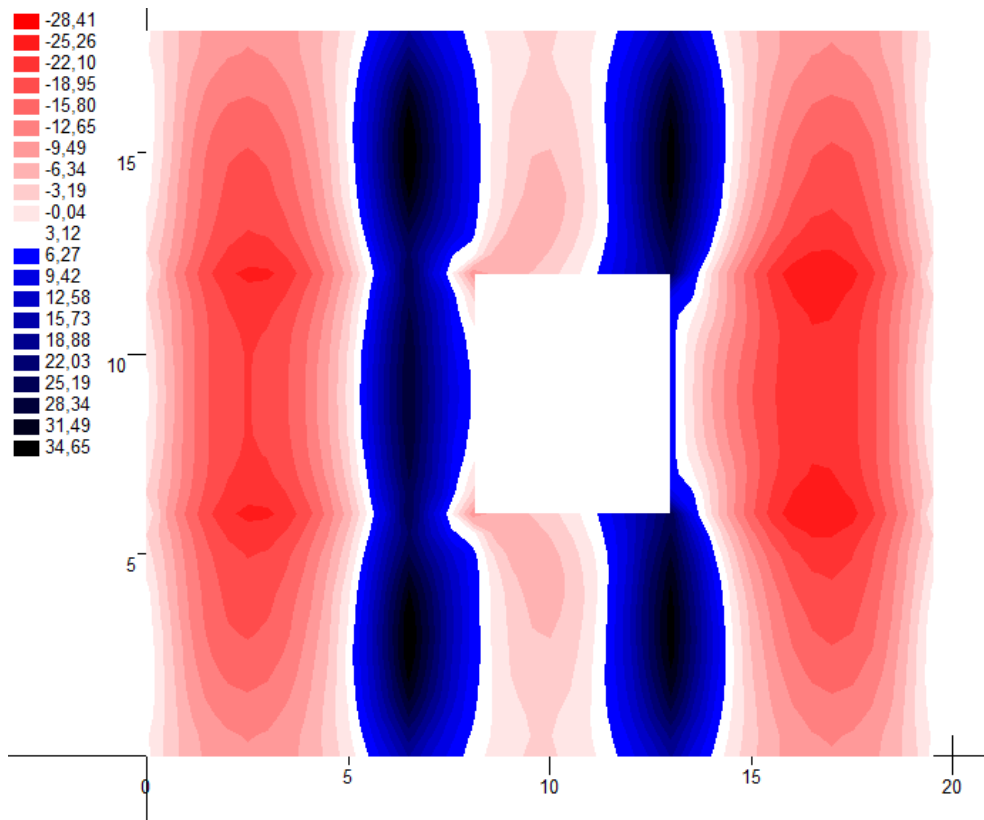

Slika 5.11. Momenti M_x (kNm)

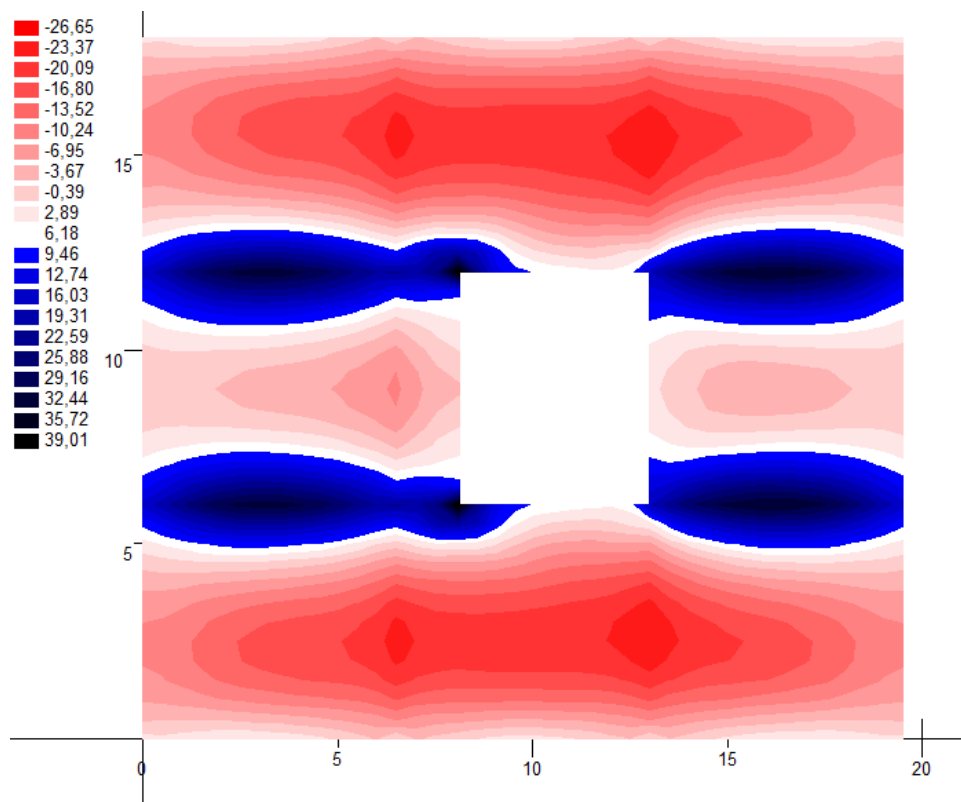

Slika 5.12. Momenti M_y (kNm)

5.1.7. GSN za krajnja polja

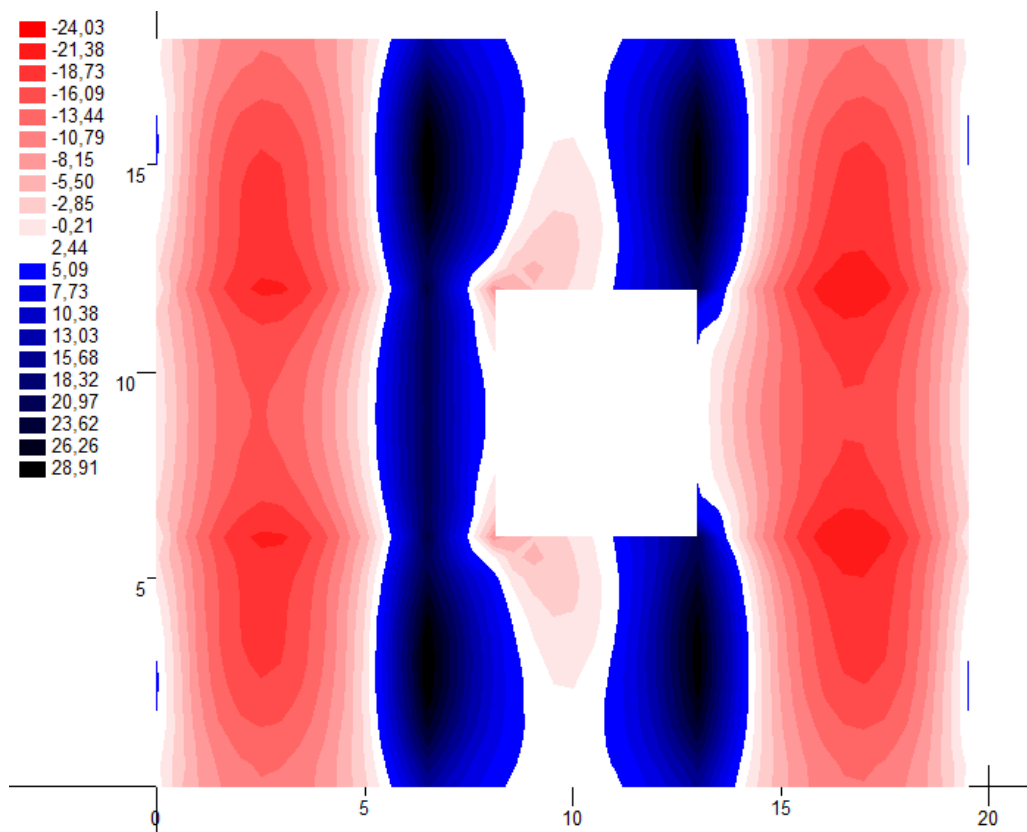

Slika 5.13. Momenti M_x (kNm)

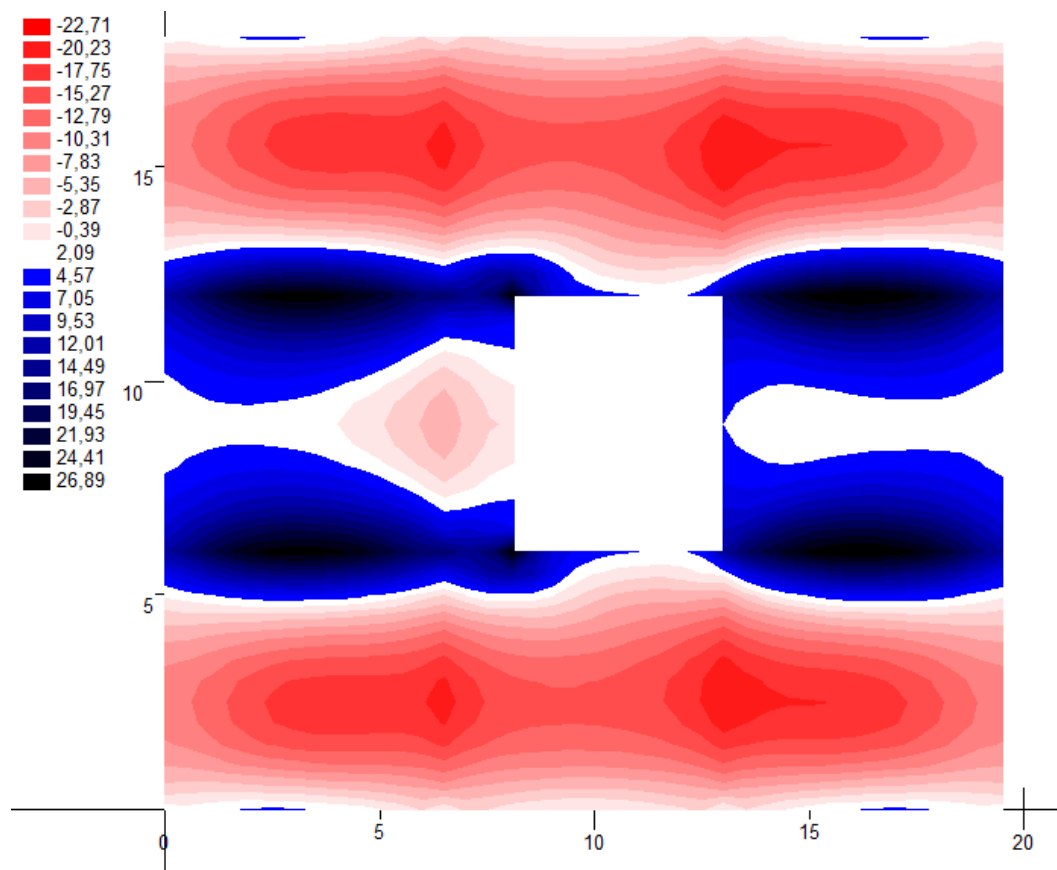

Slika 5.14. Momenti M_y (kNm)

5.1.8. GSN za srednje polje

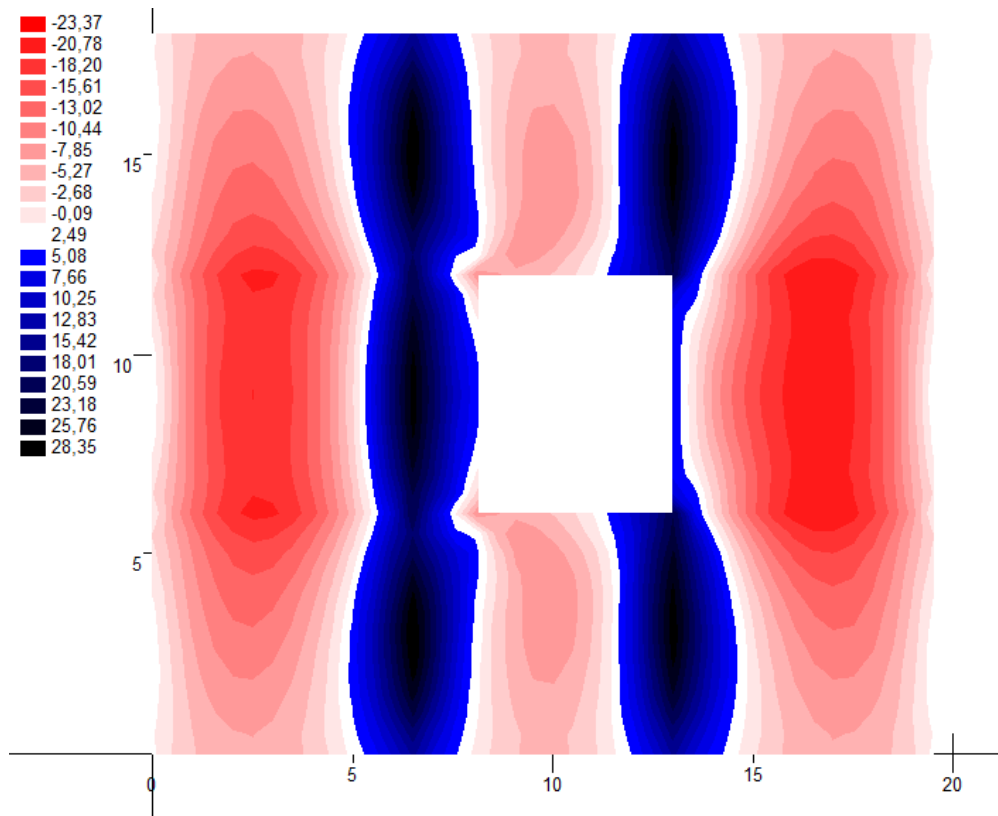

Slika 5.15. Momenti M_x (kNm)

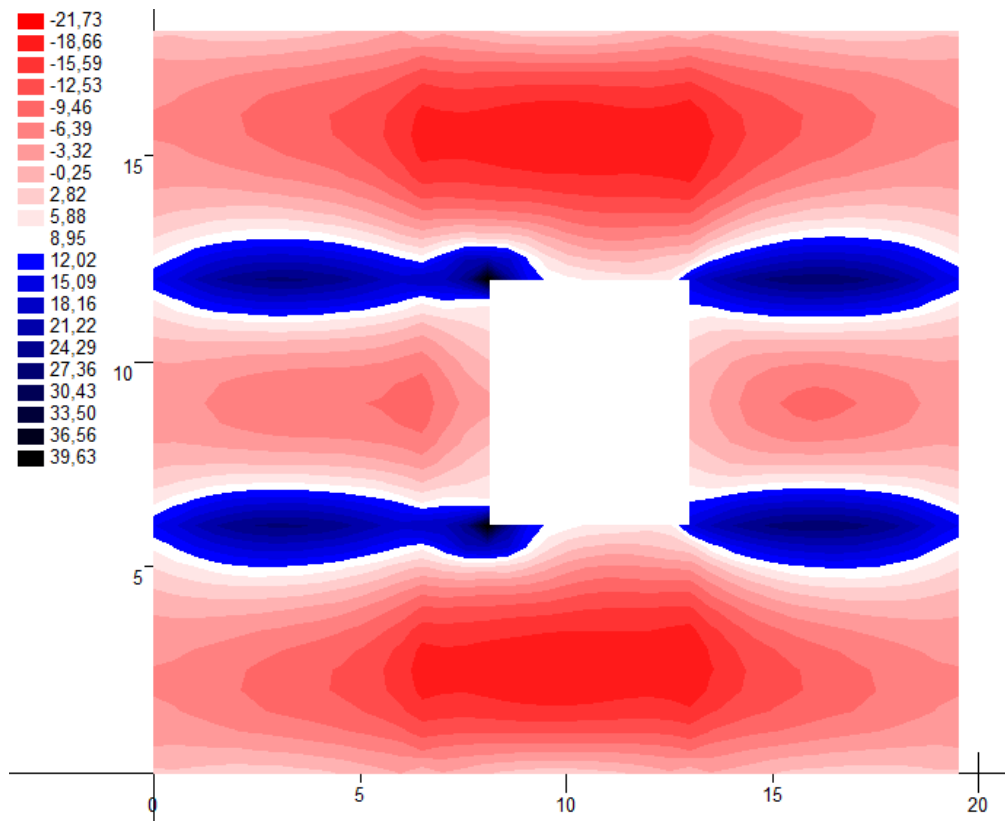

Slika 5.16. Momenti M_y (kNm)

5.2. DIMENZIONIRANJE PLOČA POZICIJE 100

BETON: C 30/37;

$$f_{ck} = 30,0 \text{ MPa} = 30 \text{ N/mm}^2; \gamma_c = 1,5$$

$$f_{cd} = f_{ck}/\gamma_c = 30,0/1,5 = 20,0 \text{ MPa} = 20,0 \text{ N/mm}^2 = 2,0 \text{ kN/cm}^2$$

ARMATURA: B 450 BC;

$$f_{yk} = 450,0 \text{ MPa} = 450 \text{ N/mm}^2; \gamma_s = 1,15$$

$$f_{yd} = f_{yk}/\gamma_s = 450,0/1,15 = 391,30 \text{ MPa} = 391,30 \text{ N/mm}^2 = 39,13 \text{ kN/cm}^2$$

Ploča 101 – polje

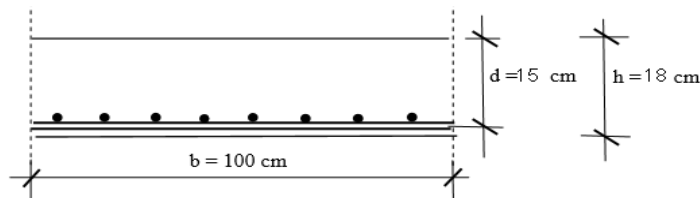

$$M_{Ed} = 24,03 \text{ kNm/m}$$

$$\mu_{sd} = \frac{M_{Ed}}{b \cdot d^2 \cdot f_{cd}} = \frac{2403}{100 \cdot 15^2 \cdot 2,0} = 0,053$$

$$\text{Očitano: } \varepsilon_{s1} = 10,0 \text{ ‰} \quad \varepsilon_{c2} = 1,4 \text{ ‰} \quad \xi = 0,123 \quad \zeta = 0,956$$

$$A_{s1} = \frac{M_{Ed}}{\zeta \cdot d \cdot f_{yd}} = \frac{2403}{0,956 \cdot 15 \cdot 39,13} = 4,28 \text{ cm}^2/\text{m}$$

Ploča 102 – polje

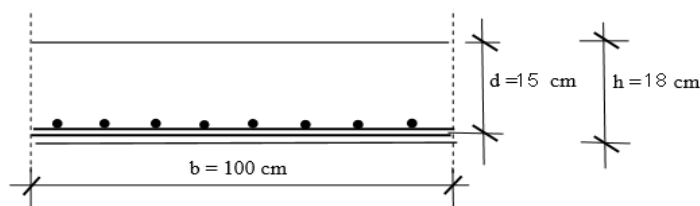

$$M_{Ed} = 21,73 \text{ kNm/m}$$

$$\mu_{sd} = \frac{M_{Ed}}{b \cdot d^2 \cdot f_{cd}} = \frac{2173}{100 \cdot 15^2 \cdot 2,0} = 0,048$$

$$\text{Očitano: } \varepsilon_{s1} = 10,0 \text{ ‰} \quad \varepsilon_{c2} = 1,3 \text{ ‰} \quad \xi = 0,115 \quad \zeta = 0,959$$

$$A_{s1} = \frac{M_{Ed}}{\zeta \cdot d \cdot f_{yd}} = \frac{2173}{0,959 \cdot 15 \cdot 39,13} = 3,86 \text{ cm}^2/\text{m}$$

Ploča 103 – polje

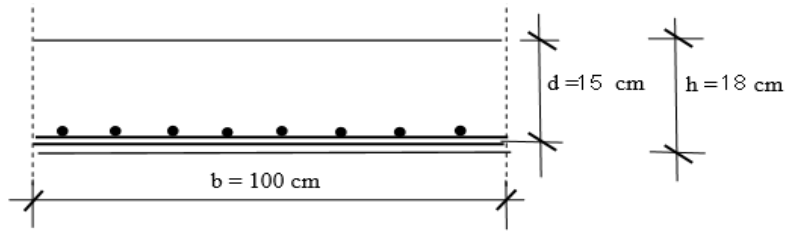

$$M_{Ed} = 23,37 \text{ kNm/m}$$

$$\mu_{sd} = \frac{M_{Ed}}{b \cdot d^2 \cdot f_{cd}} = \frac{2337}{100 \cdot 15^2 \cdot 2.0} = 0.051$$

$$\text{Očitano: } \varepsilon_{s1} = 10.0\% \quad \varepsilon_{c2} = 1.4\% \quad \xi = 0.123 \quad \zeta = 0.956$$

$$A_{s1} = \frac{M_{Ed}}{\zeta \cdot d \cdot f_{yd}} = \frac{2337}{0.956 \cdot 15 \cdot 39,13} = 4,16 \text{ cm}^2/\text{m}$$

Ploča 104 – polje

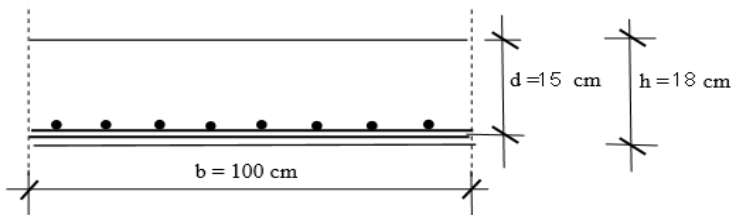

$$M_{Ed} = 18,20 \text{ kNm/m}$$

$$\mu_{sd} = \frac{M_{Ed}}{b \cdot d^2 \cdot f_{cd}} = \frac{1820}{100 \cdot 15^2 \cdot 2.0} = 0.040$$

$$\text{Očitano: } \varepsilon_{s1} = 10.0\% \quad \varepsilon_{c2} = 1.2\% \quad \xi = 0.107 \quad \zeta = 0.962$$

$$A_{s1} = \frac{M_{Ed}}{\zeta \cdot d \cdot f_{yd}} = \frac{1820}{0.962 \cdot 15 \cdot 39,13} = 3,22 \text{ cm}^2/\text{m}$$

Odabrano za sve ploče: Q-503 (5,03 cm²/m)

Ležaj 101 – 102

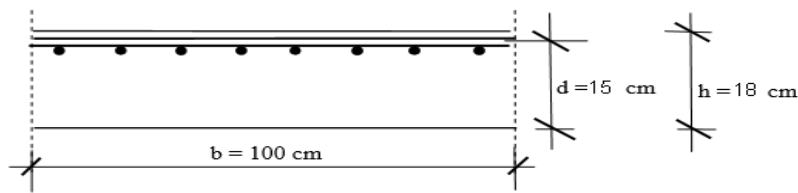

$$M_{Ed} = 34,65 \text{ kNm/m}$$

$$\mu_{sd} = \frac{M_{Ed}}{b \cdot d^2 \cdot f_{cd}} = \frac{3465}{100 \cdot 15^2 \cdot 2.0} = 0.077$$

$$\text{Očitano: } \varepsilon_{s1} = 10.0\% \quad \varepsilon_{c2} = 1.8\% \quad \xi = 0.153 \quad \zeta = 0.944$$

$$A_{s1} = \frac{M_{Ed}}{\zeta \cdot d \cdot f_{yd}} = \frac{3456}{0.944 \cdot 15 \cdot 39,13} = 6,24 \text{ cm}^2/\text{m}$$

Ležaj 101 – 103

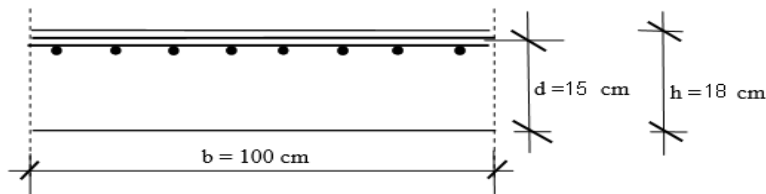

$$M_{Ed} = 39,01 \text{ kNm/m}$$

$$\mu_{sd} = \frac{M_{Ed}}{b \cdot d^2 \cdot f_{cd}} = \frac{3901}{100 \cdot 15^2 \cdot 2.0} = 0.086$$

$$\text{Očitano: } \varepsilon_{s1} = 10.0\% \quad \varepsilon_{c2} = 2,0\% \quad \xi = 0.167 \quad \zeta = 0.938$$

$$A_{s1} = \frac{M_{Ed}}{\zeta \cdot d \cdot f_{yd}} = \frac{3901}{0.938 \cdot 15 \cdot 39,13} = 7,1 \text{ cm}^2/\text{m}$$

Ležaj 103 – 104

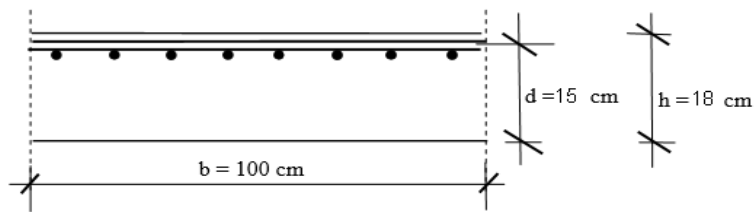

$$M_{Ed} = 26,89 \text{ kNm/m}$$

$$\mu_{sd} = \frac{M_{Ed}}{b \cdot d^2 \cdot f_{cd}} = \frac{2689}{100 \cdot 15^2 \cdot 2,0} = 0,059$$

$$\text{Očitano: } \varepsilon_{s1} = 10,0\% \quad \varepsilon_{c2} = 1,5\% \quad \xi = 0,130 \quad \zeta = 0,953$$

$$A_{s1} = \frac{M_{Ed}}{\zeta \cdot d \cdot f_{yd}} = \frac{2689}{0,953 \cdot 15 \cdot 39,13} = 4,81 \text{ cm}^2/\text{m}$$

Odabrana mreža za sve ležaje: R-785 ($A_s = 7,85 \text{ cm}^2/\text{m}$)

Minimalna armatura:

$$A_{s1, \min} \geq 0,26 \cdot [f_{ct,m} / f_{yk}] \cdot b \cdot d \geq 0,0011 \cdot b \cdot d$$

b t – širina vlačne zone

d – statička visina presjeka

f_{yk} – karakt. granica popuštanja čelika u N/mm²

[f_{yk} = 450 N/mm² za čelik B 450B]

f_{ct,m} - srednja vlačna čvrstoća betona (iz tablice)

[f_{ct,m} = 2,9 N/mm² za C 30/37]

$$A_{s1, \min} \geq 0,26 \cdot 2,9 / 450 \cdot 100 \cdot 15,0 = 2,51 \text{ cm}^2 / \text{m}$$

$$A_{s1, \min} \geq 0,0011 \cdot b \cdot d = 0,0011 \cdot 100 \cdot 15,0 = 1,65 \text{ cm}^2 / \text{m}$$

6. PRORAČUN KONTINUIRANOG NOSAČA POZICIJE 200

6.1. MOMENTI SAVIJANJA I POPREČNE SILE GREDE POZICIJE 200

6.1.1. Vlastita težina

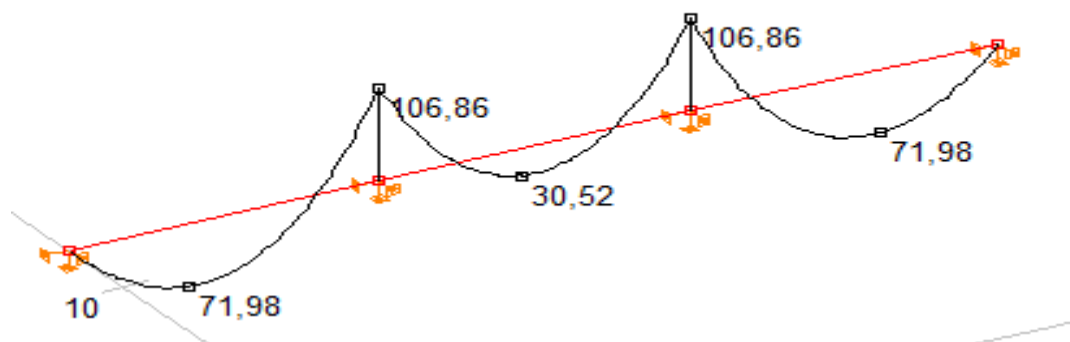

Slika 6.1. Momenti M_z (kNm)

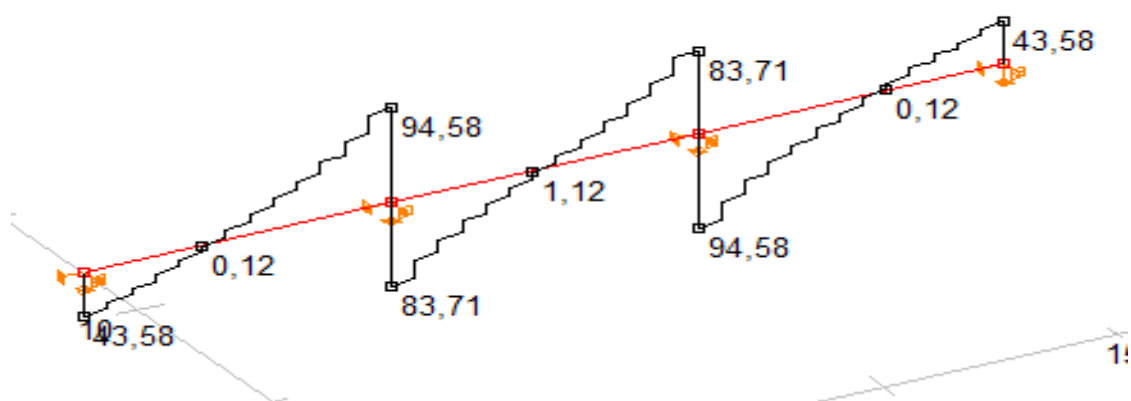

Slika 6.2. Poprečne sile T_y (kN)

6.1.2. Dodatno stalno opterećenje

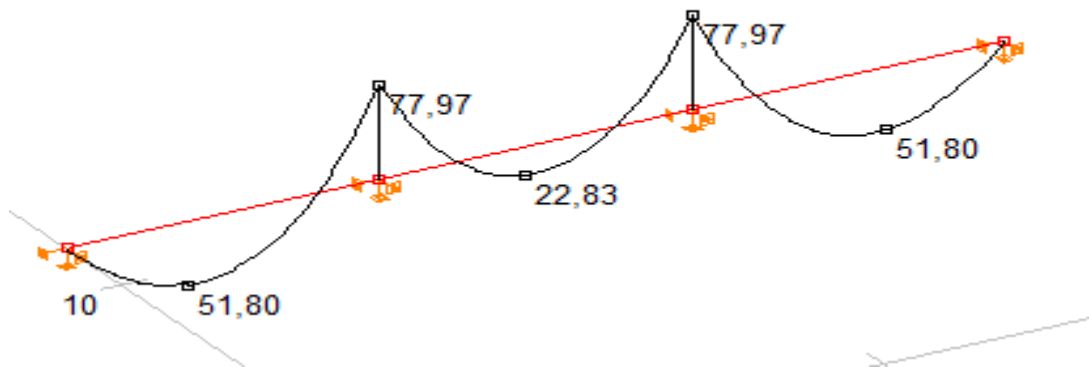

Slika 6.3. Momenti M_z (kNm)

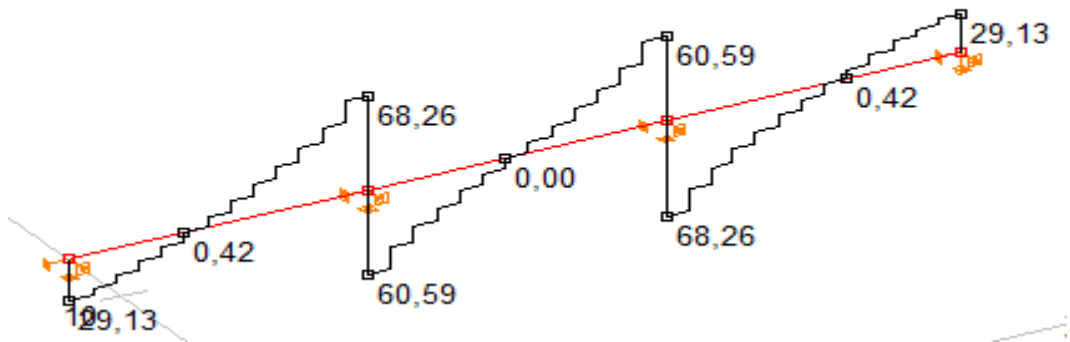

Slika 6.4. Poprečne sile T_y (kN)

6.1.3. Uporabno opterečenje

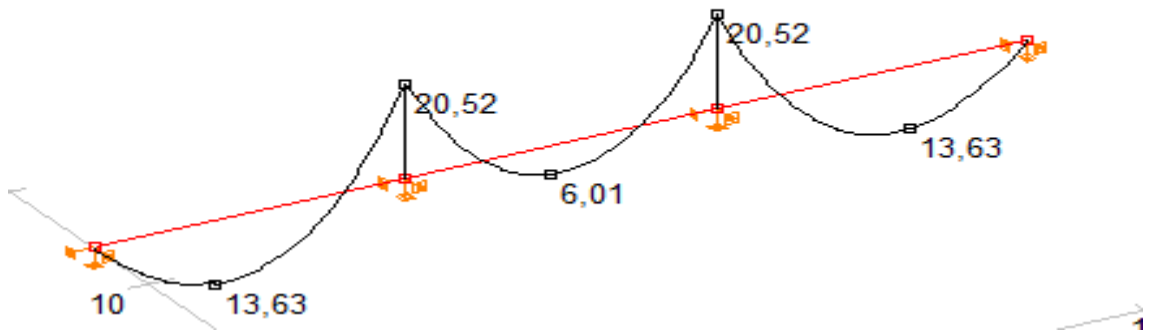

Slika 6.5. Momenti M_z (kNm)

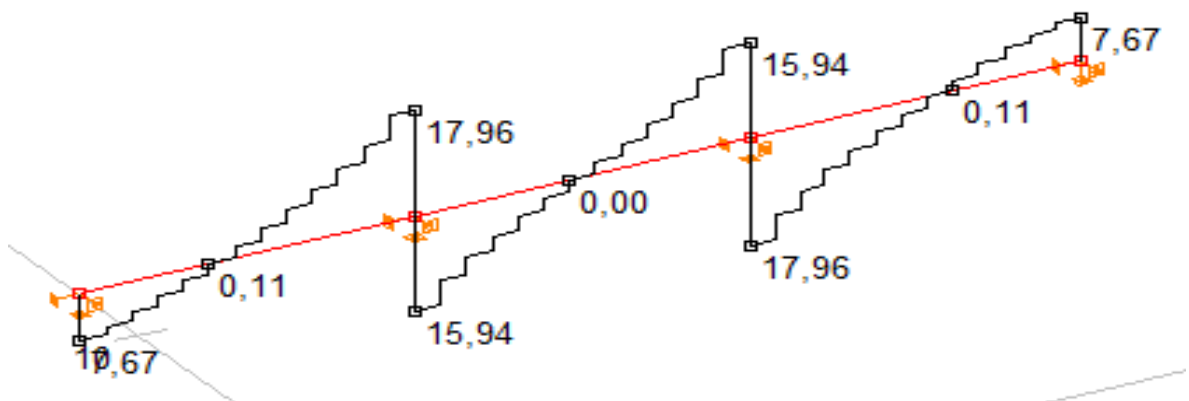

Slika 6.6. Poprečne sile T_y (kN)

6.1.4. Granično stanje nosivosti

Mjerodavna kombinacija: $M_{ed}=1,35*(M_g+M_{\Delta g})+1,5*M_q$

Momenti:

$$M_{Ed, polje1} = 187,55 \text{ kNm}$$

$$M_{Ed, ležaj} = -280,30 \text{ kNm}$$

$$M_{Ed, polje2} = 81,04 \text{ kNm}$$

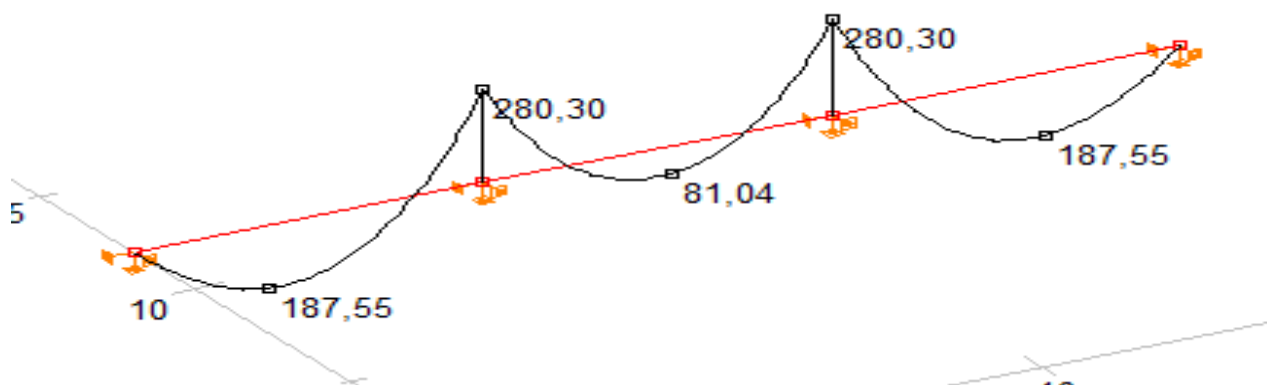

Slika 6.7. Momenti M_z (kNm)

Poprečne sile:

$$V_{Ed, ležaj1} = 246,77 \text{ kN}$$

$$V_{Ed, ležaj0} = 109,66 \text{ kN}$$

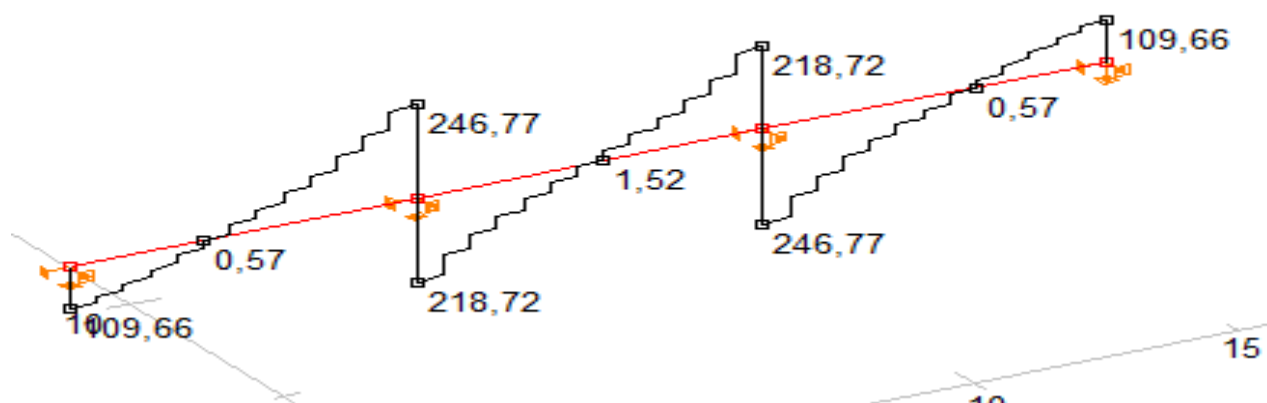

Slika 6.8. Poprečne sile T_y (kN)

6.2. DIMENZIONIRANJE GREDE NA MOMENT SAVIJANJA

BETON: C 30/37;

$$f_{ck} = 30,0 \text{ MPa} = 30 \text{ N/mm}^2; \gamma_c = 1,5$$

$$f_{cd} = f_{ck}/\gamma_c = 30,0/1,5 = 20,0 \text{ MPa} = 20,0 \text{ N/mm}^2 = 2,0 \text{ kN/cm}^2$$

ARMATURA: B 450 BC;

$$f_{yk} = 450,0 \text{ MPa} = 450 \text{ N/mm}^2; \gamma_s = 1,15$$

$$f_{yd} = f_{yk}/\gamma_s = 450,0/1,15 = 391,30 \text{ MPa} = 391,30 \text{ N/mm}^2 = 39,13 \text{ kN/cm}^2$$

Polje 1:

Utjecajna širina: $b_{eff} = b_0 + \frac{l_0}{5} \Rightarrow b_{eff} = 30 + \frac{0,85 \cdot 650}{5} = 140,5 \text{ cm}$

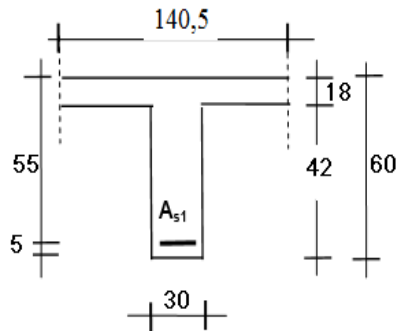

$$M_{Ed} = 187,55 \text{ kNm}$$

$$\mu_{sd} = \frac{M_{Ed}}{b_{eff} \cdot d^2 \cdot f_{cd}} = \frac{18755}{140,5 \cdot 55^2 \cdot 2,0} = 0,022$$

Očitano:

$$\varepsilon_{s1} = 10,0\text{‰} \quad \varepsilon_{c2} = 0,9\text{‰} \quad \xi = 0,083 \quad \zeta = 0,971$$

$$x = \xi \cdot d = 0,083 \cdot 55 = 4,565 \text{ cm} < h_{pl} = 18 \text{ cm}$$

$$d_1 = 5 \text{ cm}$$

$$d = h - d_1 = 60 - 5 = 55 \text{ cm}$$

$$A_{s1} = \frac{M_{Ed}}{\zeta \cdot d \cdot f_{yd}} = \frac{18755}{0,971 \cdot 55 \cdot 39,13} = 8,97 \text{ cm}^2$$

Odabrano 6Ø16 (As=12,06 cm²)

Ležaj:

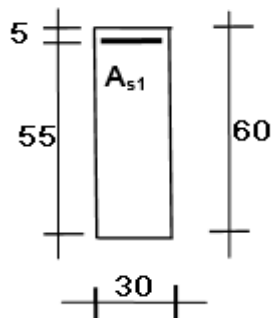

$$M_{Ed} = 280,30 \text{ kNm}$$

$$\mu_{sd} = \frac{M_{Ed}}{b_w \cdot d^2 \cdot f_{cd}} = \frac{28030}{30 \cdot 55^2 \cdot 2,0} = 0,154$$

Očitano:

$$\varepsilon_{s1} = 5,0\text{‰} \quad \varepsilon_{c2} = 2,2\text{‰} \quad \xi = 0,181 \quad \zeta = 0,883$$

$$x = \xi \cdot d = 0,181 \cdot 55 = 9,96 \text{ cm}$$

$$A_{s1} = \frac{M_{Ed}}{\zeta \cdot d \cdot f_{yd}} = \frac{28030}{0,883 \cdot 55 \cdot 39,13} = 14,75 \text{ cm}^2$$

$$d_1 = 5 \text{ cm}$$

$$d = h - d_1 = 60 - 5 = 55 \text{ cm}$$

Odabrano 8Ø16 (As=16,08 cm²)

Polje 2:

$$\text{Utjecajna širina: } b_{eff} = b_0 + \frac{l_0}{5} \Rightarrow b_{eff} = 30 + \frac{0.70 \cdot 650}{5} = 121 \text{ cm}$$

$$d_1 = 5 \text{ cm}$$

$$d = h - d_1 = 60 - 5 = 55 \text{ cm}$$

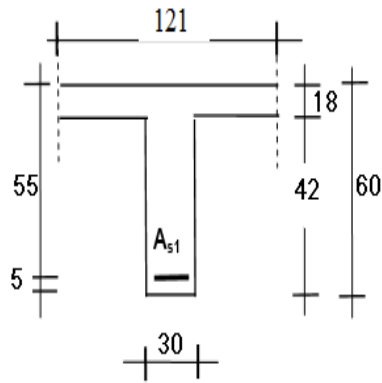

$$M_{Ed} = 81,04 \text{ kNm}$$

$$\mu_{sd} = \frac{M_{Ed}}{b_{eff} \cdot d^2 \cdot f_{cd}} = \frac{8104}{121 \cdot 55^2 \cdot 2.0} = 0.011$$

Očitano:

$$\varepsilon_{s1} = 10.0\% \quad \varepsilon_{c2} = 0.6\% \quad \xi = 0.057 \quad \zeta = 0.981$$

$$x = \xi \cdot d = 0.057 \cdot 55 = 3.14 \text{ cm} < h_{pl} = 18 \text{ cm}$$

$$A_{s1} = \frac{M_{Ed}}{\zeta \cdot d \cdot f_{yd}} = \frac{8104}{0.981 \cdot 55 \cdot 39,13} = 3,84 \text{ cm}^2$$

Odabrano 2Ø16 (As=4,02 cm²)

Minimalna armatura:

$$A_{s1, \min} \geq 0,26 \cdot [f_{ct,m} / f_{yk}] \cdot b \cdot t \cdot d \geq 0,0011 \cdot b \cdot t \cdot d$$

b t – širina vlačne zone

d – statička visina presjeka

f_{yk} – karakt. granica popuštanja čelika u N/mm²

[f_{yk} = 450 N/mm² za čelik B 450 BC]

f_{ct,m} - srednja vlačna čvrstoća betona (iz tablice)

[f_{ct,m} = 2,9 N/mm² za C 30/37]

$$A_{s1, \min} \geq 0,26 \cdot 2,9 / 450 \cdot 30 \cdot 55 = 2,76 \text{ cm}^2$$

$$A_{s1, \min} \geq 0,0011 \cdot b \cdot t \cdot d = 0,0011 \cdot 30 \cdot 55 = 1,815 \text{ cm}^2$$

Maksimalna armatura:

$$A_{s1, \max} = 0.04 \cdot A_c = 0.04 \cdot 30 \cdot 60 = 72 \text{ cm}^2$$

6.3. DIMENZIONIRANJE GREDE NA POPREČNU SILU

Ležaj 1

C 30/37

$V_{Ed} = 246,8 \text{ kN}$

$N_{Ed} = 0.0 \text{ kN}$

,

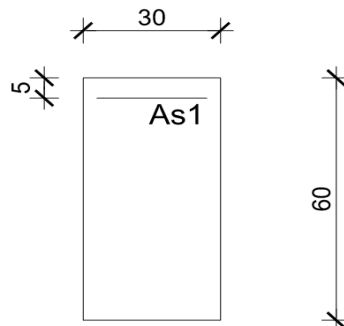

$$A_{s1} = 8\phi 16 = 16,08 \text{ cm}^2$$

$$V_{Rdc} = \left[C_{Rdc} \cdot k \cdot (100 \cdot \rho_l \cdot f_{ck})^{\frac{1}{3}} + k_1 \cdot \sigma_{cp} \right] \cdot b_w \cdot d$$

$$b_w = 30 \text{ cm} ; d = 55 \text{ cm}$$

$$k = 1 + \sqrt{\frac{200}{d}} = 1 + \sqrt{\frac{200}{550}} = 1.60 \leq 2$$

$$k_1 = 0.15$$

$$\sigma_{cp} = \frac{N_{sd}}{A_c} = 0.0$$

$$\Sigma A_s = 8\phi 16 = 16,08 \text{ cm}^2$$

$$\rho_l = \frac{\Sigma A_s}{A_c} = \frac{16,08}{30 \cdot 55} = \frac{16,08}{1650} = 0.0097$$

$$C_{Rdc} = \frac{0.18}{\gamma_c} = \frac{0.18}{1.5} = 0.12$$

$$V_{Rdc} = \left[0.12 \cdot 1.60 \cdot (100 \cdot 0.0097 \cdot 30)^{\frac{1}{3}} \right] \cdot 300 \cdot 550 = 97,44 \text{ kN}$$

$$V_{Rdc} \geq [v_{\min} + k_1 \cdot \sigma_{cp}] \cdot b_w \cdot d$$

$$v_{\min} = 0.035 \cdot k^{\frac{3}{2}} \cdot f_{ck}^{\frac{1}{2}} = 0.035 \cdot 1.60^{\frac{3}{2}} \cdot 30^{\frac{1}{2}} = 0.388$$

$$\sigma_{cp} = \frac{N_{sd}}{A_c} = 0.0$$

$$V_{Rdc} \geq v_{\min} \cdot b_w \cdot d = 0.388 \cdot 300 \cdot 550 = 64,02 \text{ kN} \leq V_{Ed}$$

$$V_{Ed, \max} = V_{Ed} = 246,77 \text{ kN}$$

$$V_{Rd, \max} = 0.5 \cdot v \cdot b_w \cdot d \cdot f_{cd}$$

$$v = 0.6 \cdot \left[1 - \frac{f_{ck}}{250} \right] = 0.6 \cdot \left[1 - \frac{30}{250} \right] = 0.528$$

$$V_{Rd, \max} = 0.5 \cdot 0.528 \cdot 300 \cdot 550 \cdot 20,0 = 871,2 \text{ kN} > V_{Ed, \max} = V_{Ed}$$

$$V_{Ed,max} / V_{Rd,max} = 246,77 / 871,2 = 0,28 \approx 0,30 \Rightarrow V_{Ed} = 0,30 V_{Rd,max}$$

$$s_{max} = \min\{0,55 \cdot d; 30\} = \min\{30,25; 30\} \Rightarrow s_{max} = 30,0 \text{ cm}$$

$$\rho_{min} = 0,0011$$

Površina minimalne armature:

$$A_{sw,min} = \frac{\rho_{min} \cdot s_w \cdot b_w}{m} = \frac{0,0011 \cdot 30 \cdot 30}{2} = 0,495 \text{ cm}^2$$

Odabrane minimalne spone: **Ø10/30** ($A_{sw}=0,79 \text{ cm}^2$)

$$f_{yw,d} = \frac{f_{yk}}{\gamma_s}; B450BC \Rightarrow f_{yw,d} = \frac{450}{1,15} = 391,3 \text{ MPa} = 39,13 \text{ kN / cm}^2$$

$$V_{Rd} = V_{Rd,s} = \frac{A_{sw}}{s} \cdot z \cdot f_{yw,d} \cdot m \cdot ctg \theta = \frac{0,79}{30} \cdot (0,9 \cdot 55) \cdot 39,13 \cdot 2 \cdot 1 = 102,01 \text{ kN}$$

$$V_{Ed} > V_{Rd}$$

Na mjestu maksimalne poprečne sile:

$$s_w \leq \frac{m \cdot A_{sw} \cdot f_{yw,d} \cdot z}{V_{Ed}} = \frac{2 \cdot 0,79 \cdot 39,13 \cdot 0,9 \cdot 55}{246,77} = 12,40 \text{ cm}$$

Odabrane spone: **Ø10/10cm** ($A_{sw}=0,79 \text{ cm}^2$)

Ležaj 0

C 30/37

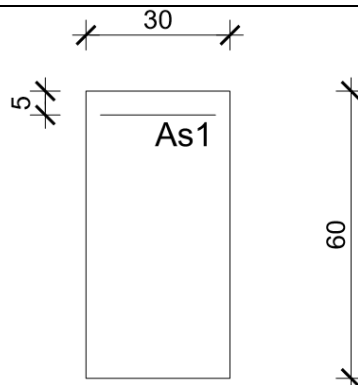
 $V_{Ed} = 109,66 \text{ kN}$ $N_{Ed} = 0.0 \text{ kN}$ 

$$A_{s1} = 6\phi 16 = 12,06 \text{ cm}^2$$

$$V_{Rdc} = \left[C_{Rdc} \cdot k \cdot (100 \cdot \rho_l \cdot f_{ck})^{\frac{1}{3}} + k_1 \cdot \sigma_{cp} \right] \cdot b_w \cdot d$$

$$b_w = 30 \text{ cm} \quad ; \quad d = 55 \text{ cm}$$

$$k = 1 + \sqrt{\frac{200}{d}} = 1 + \sqrt{\frac{200}{550}} = 1.60 \leq 2$$

$$k_1 = 0.15$$

$$\sigma_{cp} = \frac{N_{sd}}{A_c} = 0.0$$

$$\Sigma A_s = 6\phi 16 = 12,06 \text{ cm}^2$$

$$\rho_l = \frac{\Sigma A_s}{A_c} = \frac{12,06}{30 \cdot 55} = \frac{12,06}{1650} = 0.0073$$

$$C_{Rdc} = \frac{0.18}{\gamma_c} = \frac{0.18}{1.5} = 0.12$$

$$V_{Rdc} = \left[0.12 \cdot 1.60 \cdot (100 \cdot 0.0073 \cdot 30)^{\frac{1}{3}} \right] \cdot 300 \cdot 550 = 88,63 \text{ kN}$$

$$V_{Rdc} \geq [v_{\min} + k_1 \cdot \sigma_{cp}] \cdot b_w \cdot d$$

$$v_{\min} = 0.035 \cdot k^{\frac{3}{2}} \cdot f_{ck}^{\frac{1}{2}} = 0.035 \cdot 1.60^{\frac{3}{2}} \cdot 30^{\frac{1}{2}} = 0.388$$

$$\sigma_{cp} = \frac{N_{sd}}{A_c} = 0.0$$

$$V_{Rdc} \geq v_{\min} \cdot b_w \cdot d = 0.388 \cdot 300 \cdot 550 = 64,02 \text{ kN} \leq V_{Ed}$$

$$V_{Ed, \max} = V_{Ed} = 109,66 \text{ kN}$$

$$V_{Rd, \max} = 0.5 \cdot v \cdot b_w \cdot d \cdot f_{cd}$$

$$v = 0.6 \cdot \left[1 - \frac{f_{ck}}{250} \right] = 0.6 \cdot \left[1 - \frac{30}{250} \right] = 0.528$$

$$V_{Rd, \max} = 0.5 \cdot 0.528 \cdot 300 \cdot 550 \cdot 20,0 = 871,2 \text{ kN} > V_{Ed, \max} = V_{Ed}$$

$$V_{Ed,max} / V_{Rd,max} = 109,66 / 871,2 = 0,126 \approx 0,15 \Rightarrow V_{Ed} = 0,15 V_{Rd,max}$$

$$s_{max} = \min\{0,75 \cdot d; 30\} = \min\{41,25; 30\} \Rightarrow s_{max} = 30,0 \text{ cm}$$

$$\rho_{min} = 0,0011$$

Površina minimalne armature:

$$A_{sw,min} = \frac{\rho_{min} \cdot s_w \cdot b_w}{m} = \frac{0,0011 \cdot 30 \cdot 30}{2} = 0,495 \text{ cm}^2$$

Odabrane minimalne spone: **Ø10/30** ($A_{sw}=0,79 \text{ cm}^2$)

$$f_{yw,d} = \frac{f_{yk}}{\gamma_s}; B450BC \Rightarrow f_{ywd} = \frac{450}{1,15} = 391,3 \text{ MPa} = 39,13 \text{ kN / cm}^2$$

$$V_{Rd} = V_{Rd,s} = \frac{A_{sw}}{s} \cdot z \cdot f_{ywd} \cdot m \cdot ctg \theta$$
$$= \frac{0,79}{30} \cdot (0,9 \cdot 55) \cdot 39,13 \cdot 2 \cdot 1 = 102,01 \text{ kN}$$

$$V_{Ed} > V_{Rd}$$

Na mjestu maksimalne poprečne sile:

$$s_w \leq \frac{m \cdot A_{sw} \cdot f_{yw,d} \cdot z}{V_{Ed}} = \frac{2 \cdot 0,79 \cdot 39,13 \cdot 0,9 \cdot 55}{109,66} = 24,64 \text{ cm}$$

Odabrane spone: **Ø10/20cm** ($A_{sw}=0,79 \text{ cm}^2$)

6.4. KONTROLA PUKOTINA GREDE POZICIJE 200

- Kontrola pukotina i progib grede proračunava se na granično stanje uporabljivosti. Mjerodavna kombinacija djelovanja za proračun graničnog stanja uporabljivosti je: 1.0 vlastita težina "+" 1.0 dodatno stalno "+" 1.0 uporabno

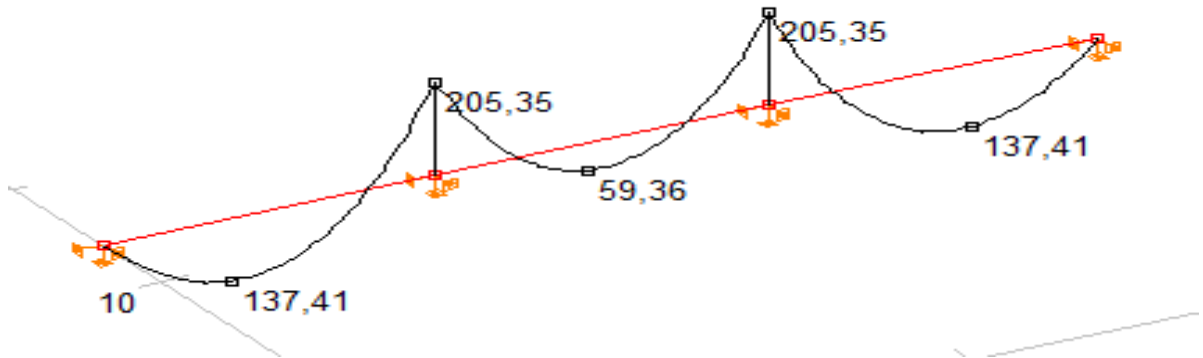

Slika 6.9.Moment (kNm)

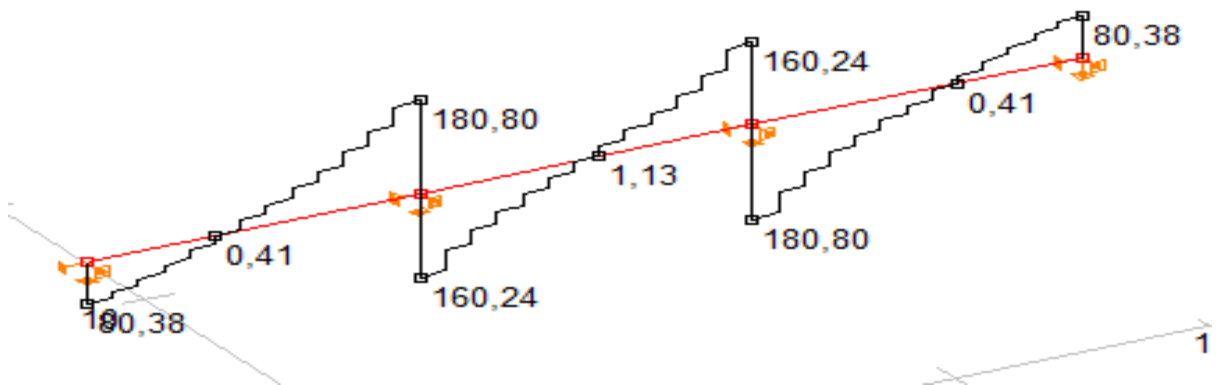

Slika 6.10.Poprečna sila (kN)

Polje 1:

$$M_{Ed} = 137,41 \text{ kNm}$$

Prognoza širine pukotine:

$$w_k = S_{r,max} \cdot (\varepsilon_{s,m} - \varepsilon_{c,m})$$

Proračun srednje deformacije armature:

$$(\varepsilon_{sm} - \varepsilon_{cm}) = \frac{\sigma_s - k_t \cdot \frac{f_{ct,eff}}{\rho_{p,eff}} \cdot (1 + \alpha_e \cdot \rho_{p,eff})}{E_s} \geq 0.6 \cdot \frac{\sigma_s}{E_s}$$

$E_{cm} = 32.00 \text{ GPa} = 32000 \text{ MPa}$ – modul elastičnosti betona

$E_s = 200.0 \text{ GPa} = 200000.0 \text{ MPa}$ – modul elastičnosti armature

$f_{ctm} = 2,9 \text{ MPa}$ - za betone klase C 30/37

$k_t = 0.4$ - dugotrajno opterećenje

$$\alpha_e = \frac{E_s}{E_{cm}} = \frac{200}{35,0} = 5.71$$

$$x = \frac{\alpha_e \cdot A_{s1}}{b} \cdot \left(-1 + \sqrt{1 + \frac{2 \cdot b \cdot d}{\alpha_e \cdot A_{s1}}} \right) = \frac{5.71 \cdot 12,06}{30} \cdot \left(-1 + \sqrt{1 + \frac{2 \cdot 30 \cdot 55}{5.71 \cdot 12,06}} \right) = 13,75 \text{ cm}$$

$$\sigma_s = \frac{M_{Ed}}{z \cdot A_{s1}} \approx \frac{M_{Ed}}{\left(d - \frac{x}{3}\right) \cdot A_{s1}} = \frac{13741}{\left(55 - \frac{13,75}{3}\right) \cdot 12,06} = 22,60 \text{ kN /cm}^2 = 225,98 \text{ MPa}$$

$$\rho_{p,eff} = \frac{A_{s1}}{A_{c,eff}} = \frac{A_{s1}}{b \cdot 2.5 \cdot d_1} = \frac{12,06}{30 \cdot 2.5 \cdot 5.0} = 0.032$$

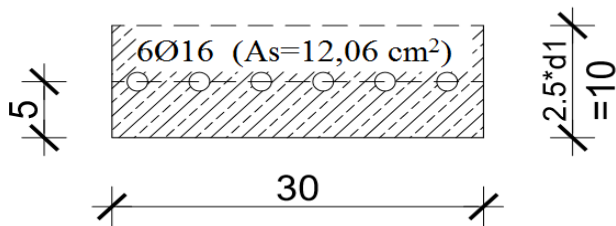

$$(\varepsilon_{sm} - \varepsilon_{cm}) = \frac{225,98 - 0.4 \cdot \frac{2,9}{0.032} \cdot (1 + 5.71 \cdot 0.032)}{200000} \geq 0.6 \cdot \frac{225,98}{200000}$$

$$\frac{183,11}{200000} > \frac{135,59}{200000}$$

$$(\varepsilon_{sm} - \varepsilon_{cm}) = 0.00092$$

Proračun srednjeg razmaka pukotina:

$$S_{r,max} = k_3 \cdot c + k_1 \cdot k_2 \cdot k_4 \cdot \frac{\phi}{\rho_{p,eff}}$$

$\phi = 16 \text{ mm}$ – promjer najdeblje šipke

$k_1 = 0.8$ - Rebrasta armatura

$k_2 = 0.5$ – Savijanje

$k_3 = 3.4$

$k_4 = 0.425$

$c = d_1 - \frac{\phi}{2} = 50 - \frac{16}{2} = 42 \text{ mm}$ - zaštitni sloj uzdužne armature

$$S_{r,max} = 3.4 \cdot 42 + 0.8 \cdot 0.5 \cdot 0.425 \cdot \frac{16}{0.034} = 222,8 \text{ mm}$$

$$W_k = w_k = S_{r,max} \cdot (\varepsilon_{s,m} - \varepsilon_{c,m}) = 222,8 \cdot 0.00092 = 0.205 \text{ mm} \leq 0.300 \text{ mm}$$

→ pukotine zadovoljavaju

Ležaj:

$$M_{Ed} = 205,35 \text{ kNm}$$

Prognoza širine pukotine:

$$w_k = S_{r,max} \cdot (\varepsilon_{s,m} - \varepsilon_{c,m})$$

Proračun srednje deformacije armature:

$$(\varepsilon_{sm} - \varepsilon_{cm}) = \frac{\sigma_s - k_t \cdot \frac{f_{ct,eff}}{\rho_{p,eff}} \cdot (1 + \alpha_e \cdot \rho_{p,eff})}{E_s} \geq 0.6 \cdot \frac{\sigma_s}{E_s}$$

$E_{cm} = 32.00 \text{ GPa} = 32000 \text{ MPa}$ – modul elastičnosti betona

$E_s = 200.0 \text{ GPa} = 200000.0 \text{ MPa}$ – modul elastičnosti armature

$f_{ctm} = 2,9 \text{ MPa}$ - za betone klase C 30/37

$k_t = 0.4$ - dugotrajno opterećenje

$$\alpha_e = \frac{E_s}{E_{cm}} = \frac{200}{35,0} = 5.71$$

$$x = \frac{\alpha_e \cdot A_{s1}}{b} \cdot \left(-1 + \sqrt{1 + \frac{2 \cdot b \cdot d}{\alpha_e \cdot A_{s1}}} \right) = \frac{5.71 \cdot 16,08}{30} \cdot \left(-1 + \sqrt{1 + \frac{2 \cdot 30 \cdot 55}{5.71 \cdot 16,08}} \right) = 15,55 \text{ cm}$$

$$\sigma_s = \frac{M_{Ed}}{z \cdot A_{s1}} \approx \frac{M_{Ed}}{\left(d - \frac{x}{3}\right) \cdot A_{s1}} = \frac{20535}{\left(55 - \frac{15,55}{3}\right) \cdot 16,08} = 25,63 \text{ kN/cm}^2 = 256,32 \text{ MPa}$$

$$\rho_{p,eff} = \frac{A_{s1}}{A_{c,eff}} = \frac{A_{s1}}{b \cdot 2.5 \cdot d_1} = \frac{16,08}{30 \cdot 2.5 \cdot 5.0} = 0.043$$

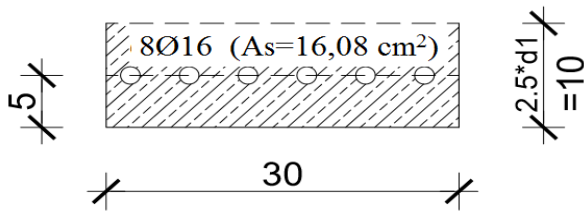

$$(\varepsilon_{sm} - \varepsilon_{cm}) = \frac{256,32 - 0.4 \cdot \frac{2,9}{0.043} \cdot (1 + 5.71 \cdot 0.043)}{200000} \geq 0.6 \cdot \frac{256,32}{200000}$$

$$\frac{222,72}{200000} > \frac{153,79}{200000}$$

$$(\varepsilon_{sm} - \varepsilon_{cm}) = 0.00111$$

Proračun srednjeg razmaka pukotina:

$$S_{r,max} = k_3 \cdot c + k_1 \cdot k_2 \cdot k_4 \cdot \frac{\phi}{\rho_{p,eff}}$$

$\phi = 16$ mm – promjer najdeblje šipke

$k_1 = 0.8$ - Rebrasta armatura

$k_2 = 0.5$ – Savijanje

$k_3 = 3.4$

$k_4 = 0.425$

$c = d_1 - \frac{\phi}{2} = 50 - \frac{16}{2} = 42$ mm - zaštitni sloj uzdužne armature

$$S_{r,max} = 3.4 \cdot 42 + 0.8 \cdot 0.5 \cdot 0.425 \cdot \frac{16}{0.043} = 206,06 \text{ mm}$$

$$W_k = w_k = S_{r,max} \cdot (\varepsilon_{s,m} - \varepsilon_{c,m}) = 206,06 \cdot 0.00111 = 0.229 \text{ mm} \leq 0.300 \text{ mm}$$

→ pukotine zadovoljavaju

6.5. KONTROLA PROGIBA GREDE POZICIJE 200

Progib kontroliramo za nefaktorizirano opterećenje i bez utjecaja puzanja.

Kontrola progiba za Polje 1:

Granični progib:

$$v_{\text{lim}} = \frac{L}{250} = \frac{650}{250} = 2.6 \text{ cm}$$

Beton: C 30/37; $f_{ck}=30.0 \text{ MPa}$

$$E_{cm} = 9500 \cdot \sqrt[3]{f_{ck} + 8} = 9500 \cdot \sqrt[3]{30 + 8} \approx 35000 \text{ MPa}$$

$$f_{ctm} = 0.3 \cdot (f_{ck})^{2/3} = 0.3 \cdot (30.0)^{2/3} = 2.9 \text{ MPa}$$

Čelik: B450BC ; $E_s= 200.0 \text{ GPa}$

$$\alpha_{el} = \frac{E_s}{E_{cm}} = \frac{200.0}{35} = 5.71$$

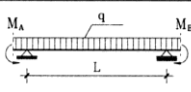
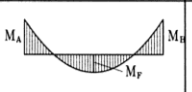
Red	Tip opterećenja	Dijagram momenata savijanja	Koeficijent k iz izraza (5.131)
7			$k = \frac{5}{48} (1 - 0.1\beta)$ $\beta = M_A + M_B / M_F $

$$v_{\text{tot}} = k \cdot L^2 \cdot \frac{1}{r_{\text{tot}}}$$

$$\beta = |M_A + M_B| / |M_F| = |0.0 + 205,35| / |137,41| = 1.494$$

$$k = \frac{5}{48} \cdot (1 - 0.1 \cdot \beta) = 0.104 \cdot (1 - 0.1 \cdot 1.494) = 0.0885$$

Presjek u polju :

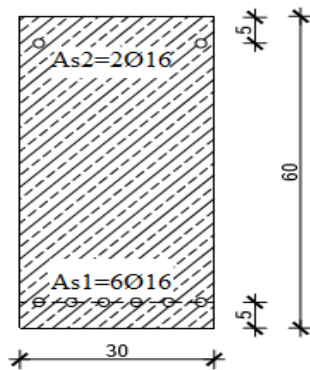

$$A_{s1} = 6\text{Ø}16 = 12,06 \text{ cm}^2$$

$$A_{s2} = 2\text{Ø}16 = 4,02 \text{ cm}^2$$

$$I_1 = \frac{bh^3}{12} + \alpha_{el} \cdot \left[A_{s1} \cdot \left(\frac{h}{2} - d_2 \right)^2 + A_{s2} \cdot \left(\frac{h}{2} - d_1 \right)^2 \right]$$

$$= \frac{30 \cdot 60^3}{12} + 5,71 \cdot \left[12,06 \cdot \left(\frac{60}{2} - 5 \right)^2 + 4,02 \cdot \left(\frac{60}{2} - 5 \right)^2 \right] =$$

$$= 60884119 \text{ cm}^4$$

$$E_{c,eff} = E_{cm} = 32,0 \text{ GN/m}^2 = 3200,0 \text{ kN/cm}^2$$

$$\frac{1}{r_I} = \frac{M_{Ed}}{E_{c,eff} \cdot I_1} = \frac{13741}{3200 \cdot 60884119} = 0,00000705 \frac{1}{\text{cm}}$$

Progib potpuno raspucanog presjeka:

$x = 13,75 \text{ cm}$ (izračunato kod pukotina)

$$I_{II} = \frac{bx^3}{12} + bx \cdot \left(\frac{x}{2} \right)^2 + \alpha_{el} \cdot \left[A_{s1} \cdot (d - x)^2 + A_{s2} \cdot (x - d_2)^2 \right]$$

$$= \frac{30 \cdot 13,75^3}{12} + (30 \cdot 13,75) \cdot \left(\frac{13,75}{2} \right)^2 + 5,71 \cdot \left[12,06 \cdot (55 - 13,75)^2 + 4,02 \cdot (13,75 - 5)^2 \right]$$

$$= 13890117 \text{ cm}^4$$

$$\frac{1}{r_{II}} = \frac{M_{Ed}}{E_{c,eff} \cdot I_{II}} = \frac{13741}{3200 \cdot 13890117} = 0,0000309 \frac{1}{\text{cm}}$$

$$\sigma_s = 225,98 \text{ MPa}$$

$$\sigma_{sr} = \frac{M_{cr}}{\left(d - \frac{x}{3}\right) \cdot A_{s1}}$$

$$M_{cr} = f_{ctm} \cdot W = f_{ctm} \cdot \frac{b \cdot h^2}{6} = 0,35 \cdot \frac{30 \cdot 60^2}{6} = 6300 \text{ kNcm}$$

$$\sigma_{sr} = \frac{6300}{\left(55 - \frac{13,75}{3}\right) \cdot 12,06} = 10,36 \frac{\text{kN}}{\text{cm}^2} = 103,6 \text{ MPa}$$

$\beta_1 = 1,0$ - Rebrasta armatura

$\beta_2 = 0,5$ - Dugotrajno opterećenje

$$\zeta = 1 - \beta_1 \cdot \beta_2 \cdot \left(\frac{\sigma_{sr}}{\sigma_s}\right)^2 = 1 - 1,0 \cdot 0,5 \cdot \left(\frac{103,6}{225,98}\right)^2 = 0,895$$

$$\frac{1}{r_I} = 0,00000705 \frac{1}{\text{cm}}$$

$$\frac{1}{r_{II}} = 0,0000309 \frac{1}{\text{cm}}$$

$$\frac{1}{r_m} = (1 - \zeta) \cdot \frac{1}{r_I} + \zeta \cdot \frac{1}{r_{II}} = (1 - 0,895) \cdot 0,00000705 + 0,895 \cdot 0,0000309 = 0,000029 \frac{1}{\text{cm}}$$

$$k = 0,0885$$

$$L = 650,0 \text{ cm}$$

$$v_{tot,t=0} = k \cdot L^2 \cdot \frac{1}{r_{tot}} = 0,0885 \cdot 650,0^2 \cdot 0,000029 = 1,08 \text{ cm} < v_{lim} = 2,6 \text{ cm}$$

7. PRORAČUN KONTINUIRANOG NOSAČA POZICIJE 100

7.1. MOMENTI SAVIJANJA I POPREČNE SILE GREDE POZICIJE 100

7.1.1. Vlastita težina

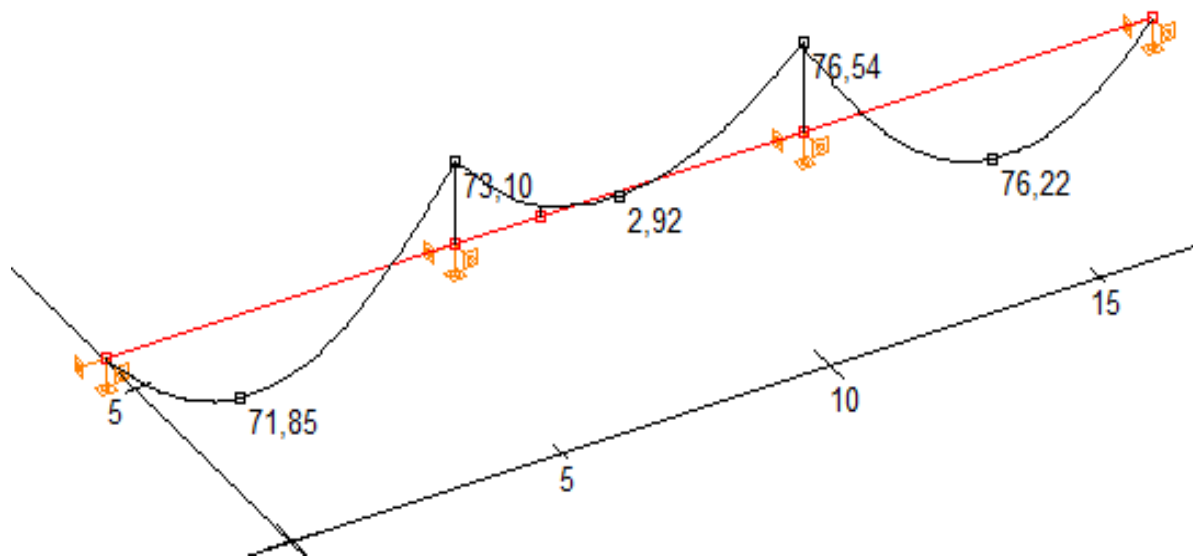

Slika 7.1. Momenti M_z (kNm)

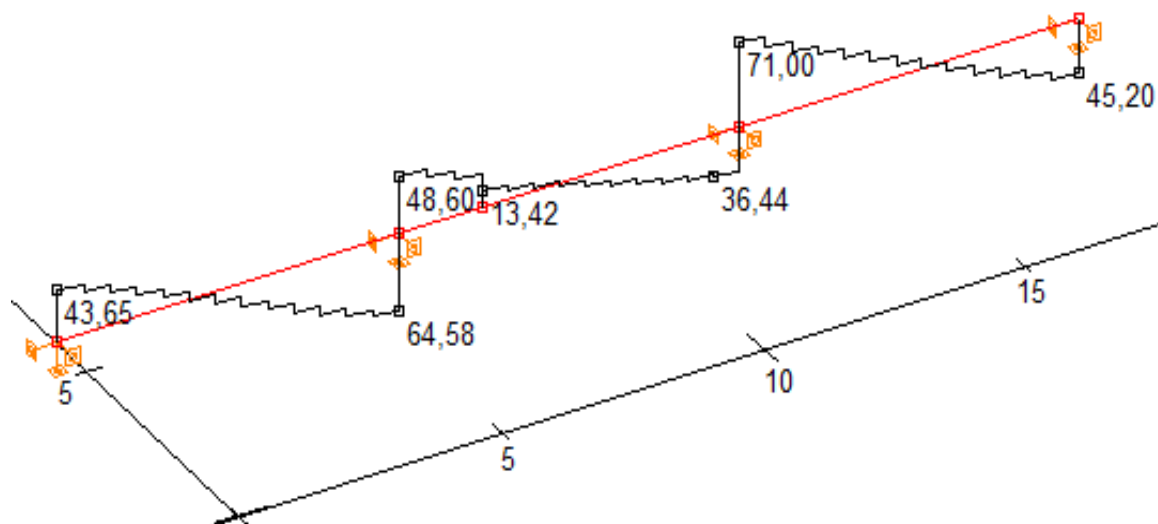

Slika 7.2. Poprečne sile V_y (kN)

7.1.2. Dodatno stalno opterećenje

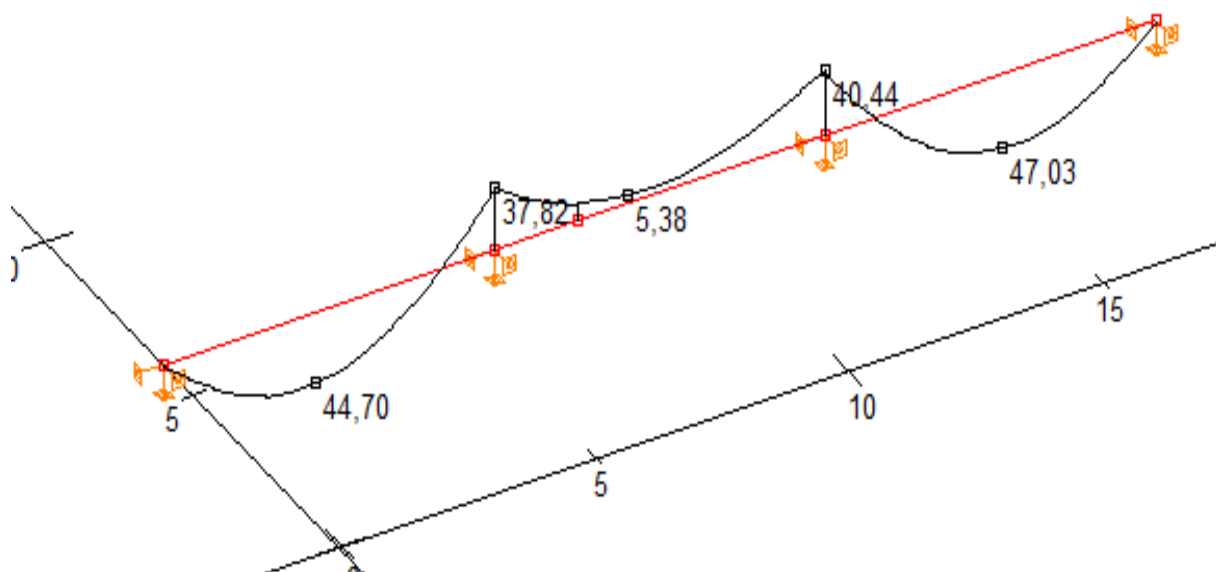

Slika 7.3. Momenti M_z (kNm)

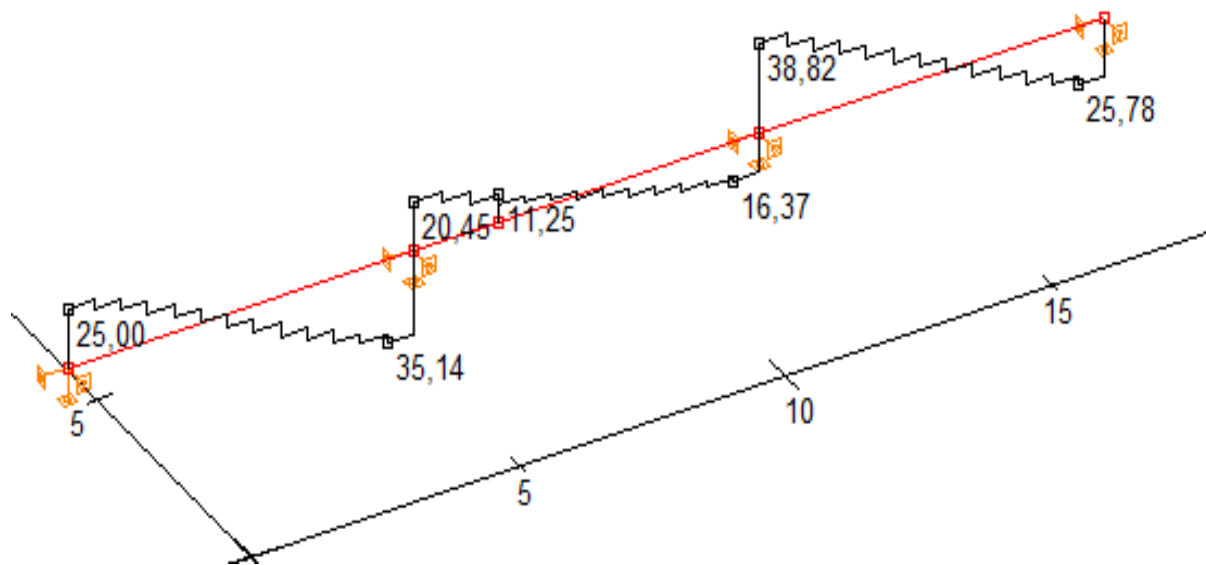

Slika 7.4. Poprečne sile V_y (kN)

7.1.3. Uporabno opterećenje shema 4 (max sile u krajnjim poljima)

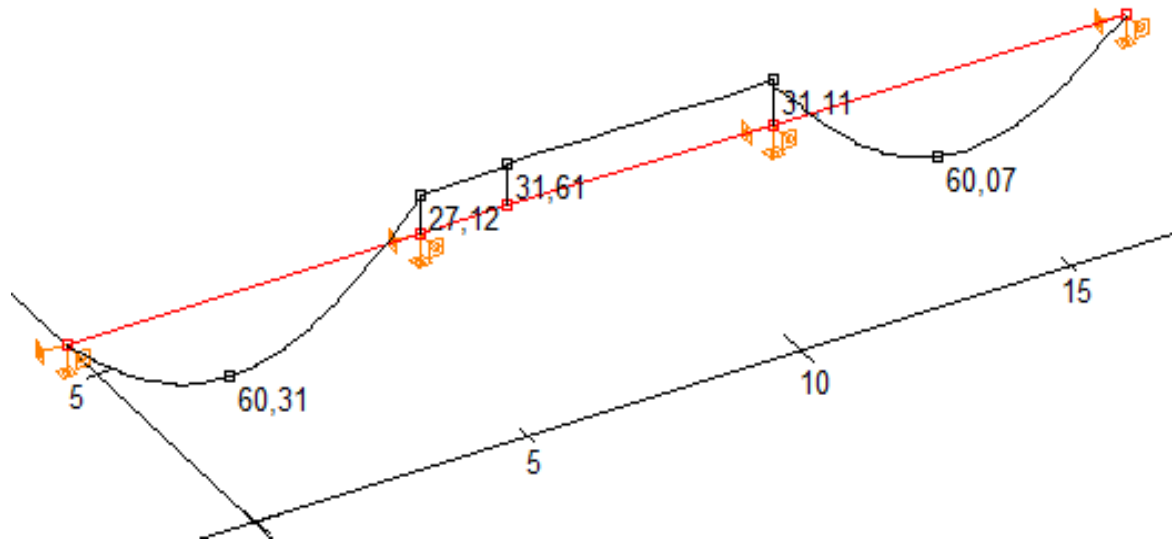

Slika 7.5. Momenti M_z (kNm)

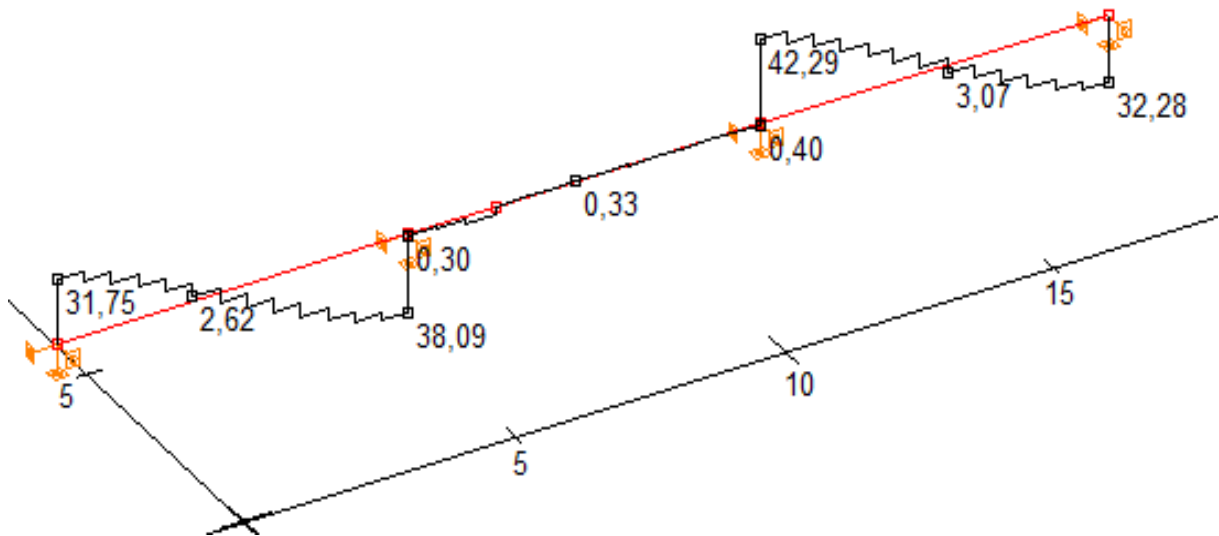

Slika 7.6. Poprečne sile V_y (kN)

7.1.4. Uporabno opterećenje shema 5 (max sile u srednjem polju)

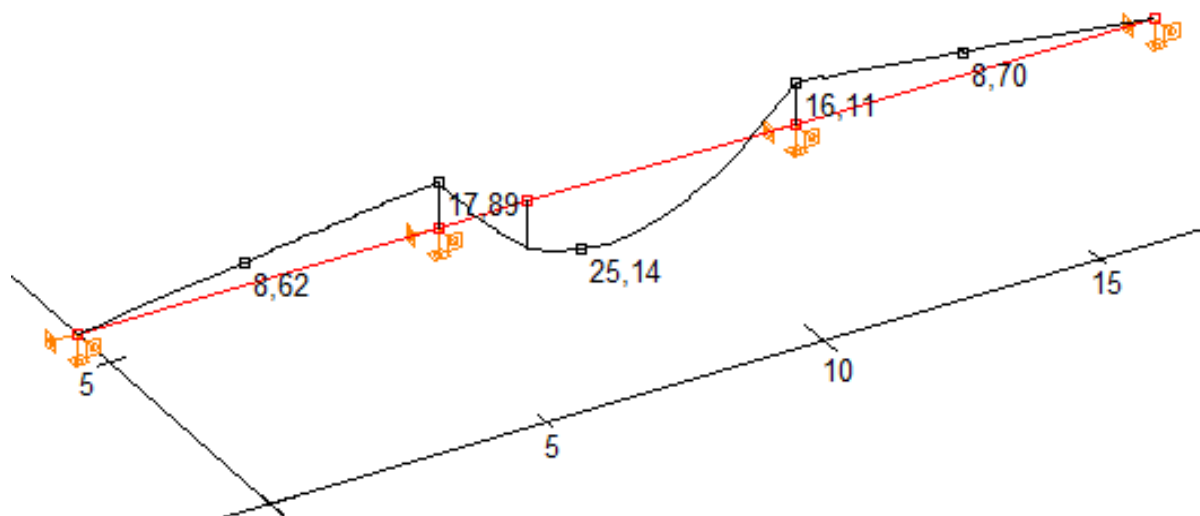

Slika 7.7. Momenti M_z (kNm)

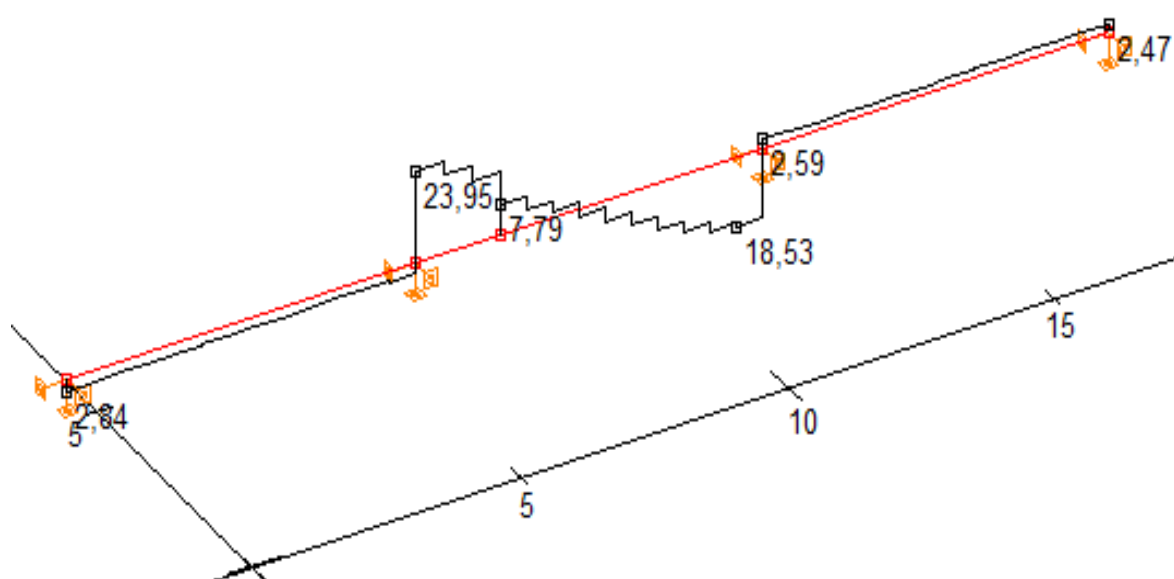

Slika 7.8. Poprečne sile V_y (kN)

7.1.5. Uporabno opterečenje shema 6 (max sile na ležaju)

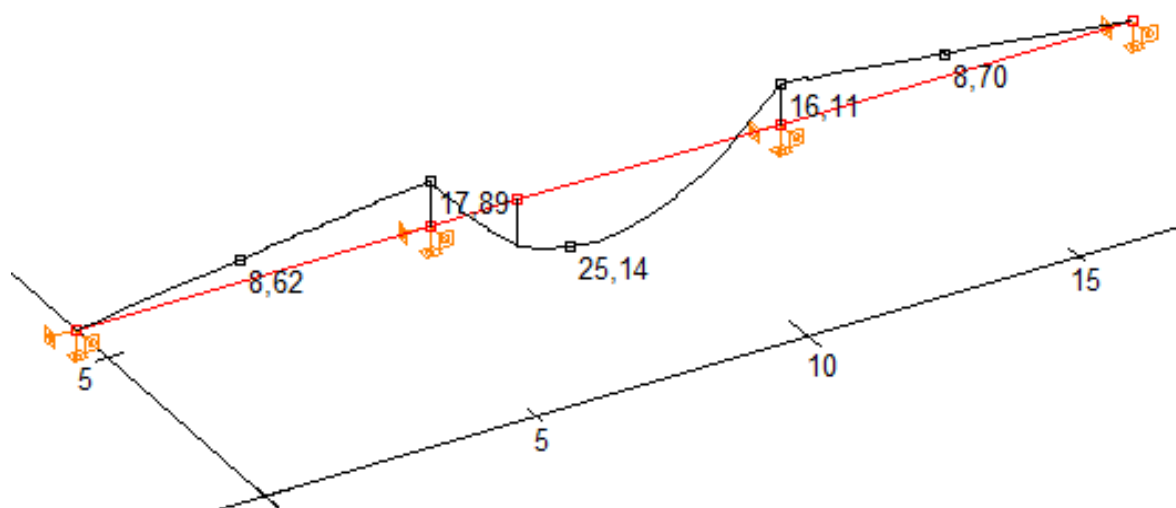

Slika 7.9. Momenti M_z (kNm)

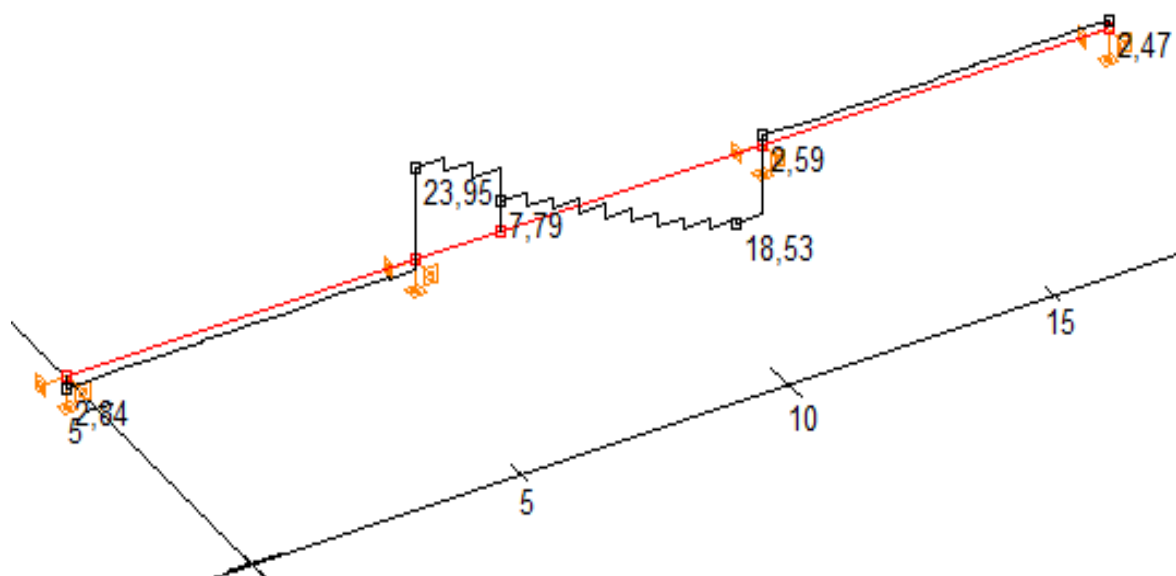

Slika 7.10. Poprečne sile V_y (kN)

7.1.6. GSN za kranja polja

Mjerodavna kombinacija za proračun GSN: $M_{ed}=1,35*(M_g+M_{\Delta g})+1,5*M_q$

Momenti:

$$M_{Ed, \text{krajnje polje}} = 259,51 \text{ kNm}$$

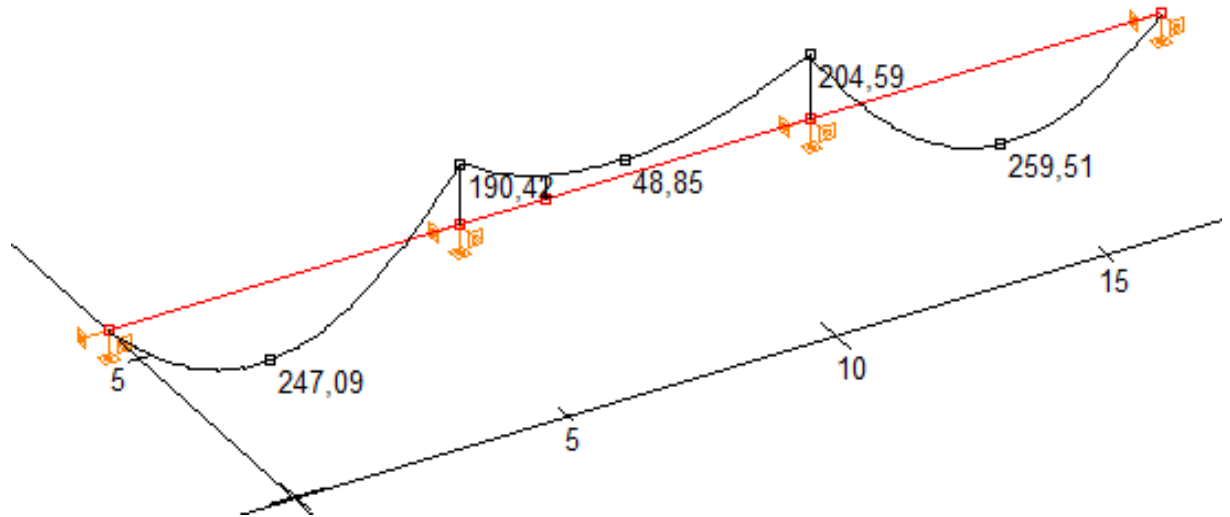

Slika 7.11. Momenti M_z (kNm)

Poprečne sile:

$$V_{Ed, \text{ležaj0}} = 144,24 \text{ kN}$$

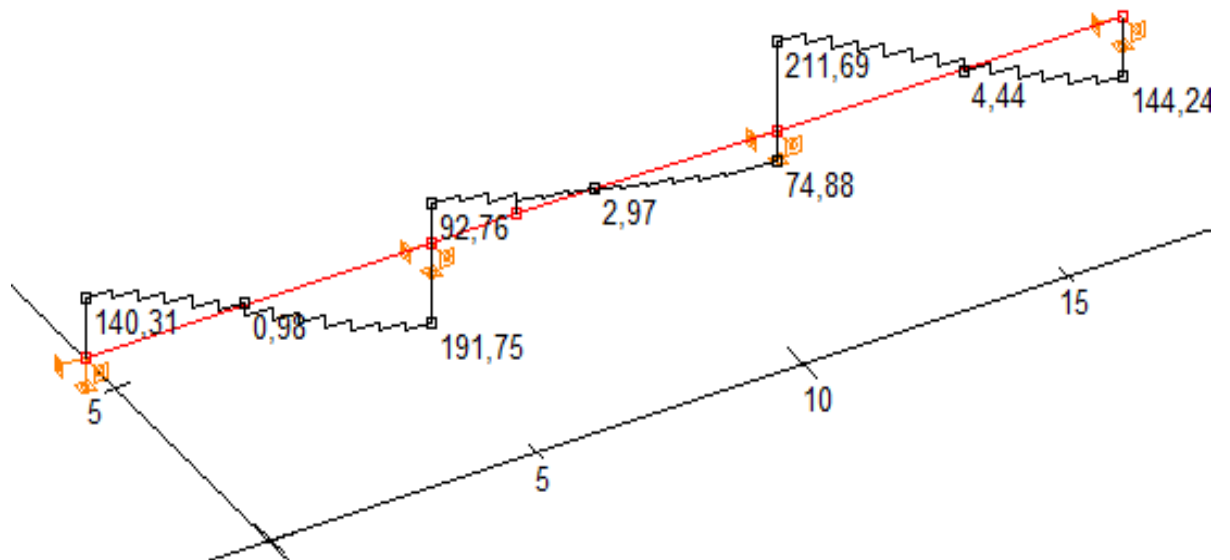

Slika 7.12. Poprečne sile V_y (kN)

7.1.7. GSN za srednje polje

$$M_{Ed, \text{srednja polje}} = 36,57 \text{ kNm}$$

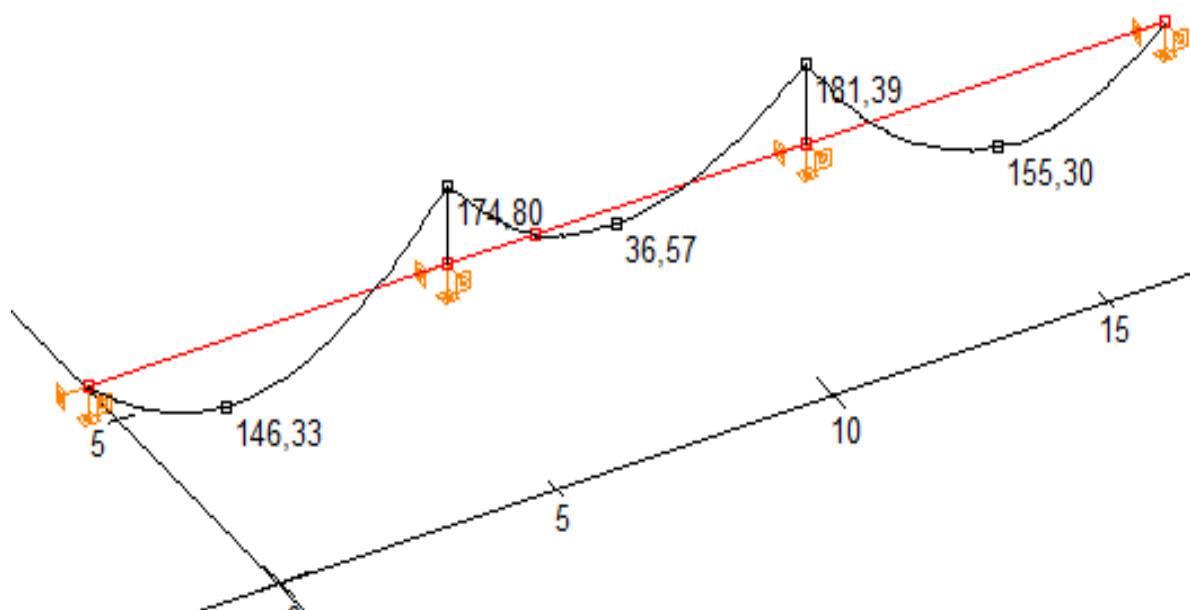

Slika 7.13. Momenti M_z (kNm)

Poprečne sile:

$$V_{Ed, \text{ležaj}} = 152,15 \text{ kN}$$

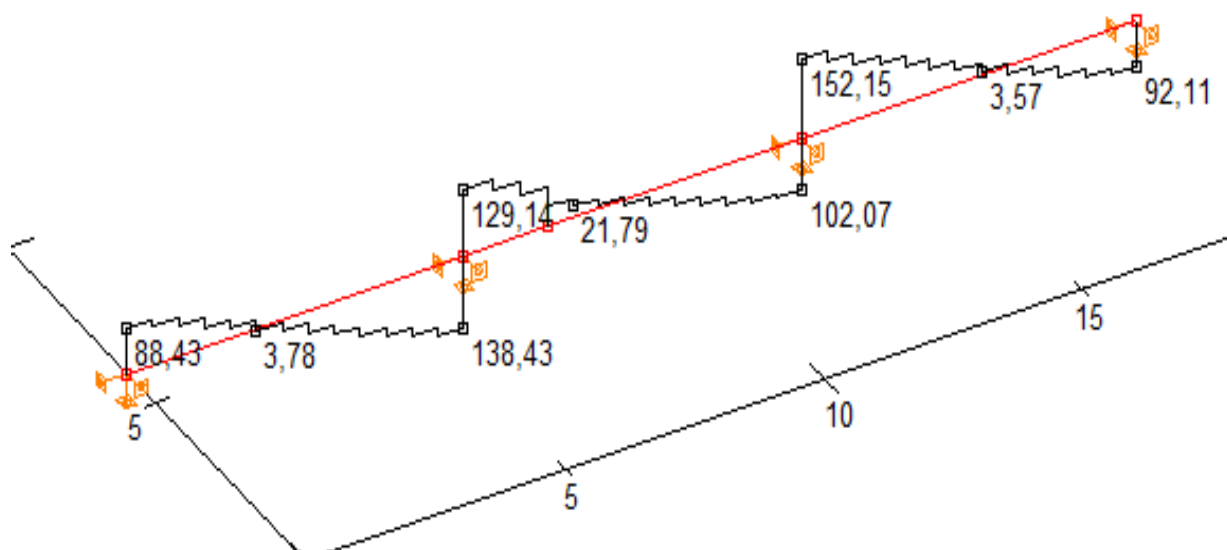

Slika 7.14. Poprečne sile V_y (kN)

7.1.8. GSN za ležaj

Momenti:

$$M_{Ed,ležaj} = -247,97 \text{ kNm}$$

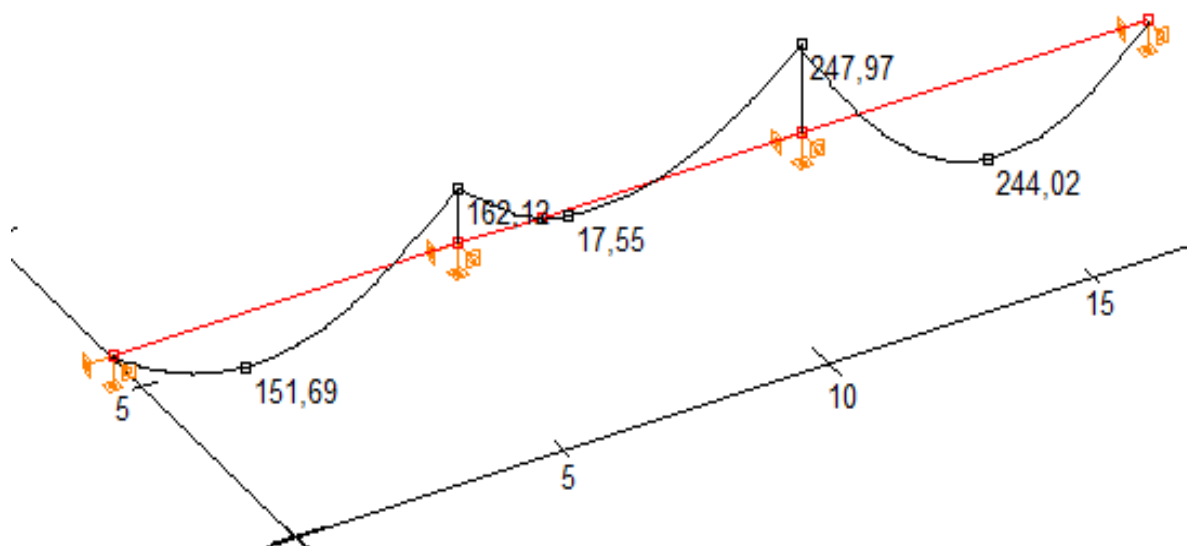

Slika 7.15. Momenti M_z (kNm)

Poprečne sile:

$$V_{Ed,ležaj1} = 222,55 \text{ kN}$$

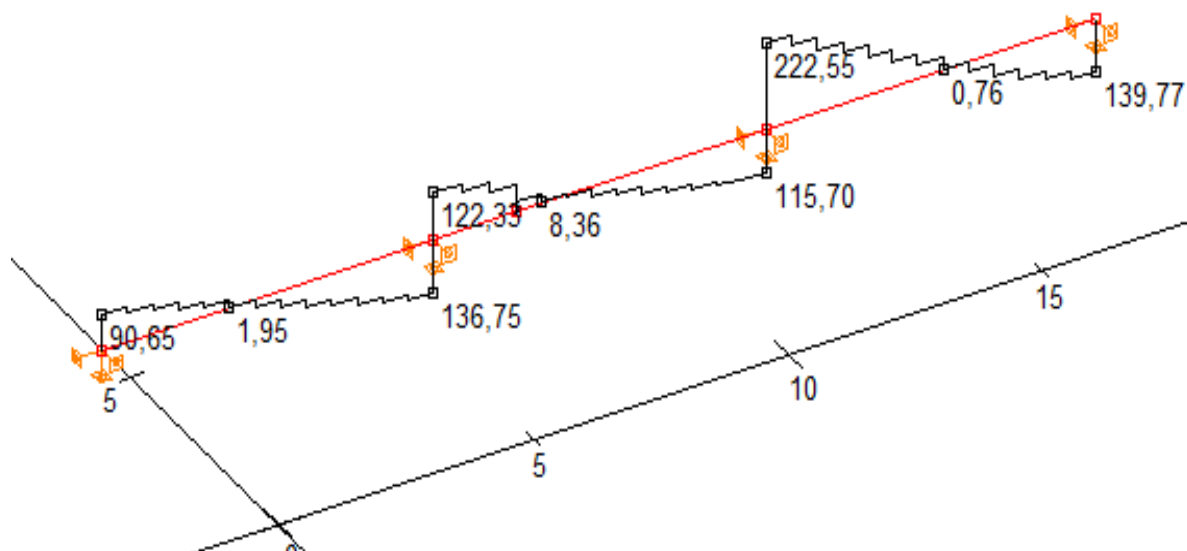

Slika 7.16. Poprečne sile V_y (kN)

7.2. DIMENZIONIRANJE GREDE NA MOMENT SAVIJANJA

BETON: C 30/37;

$$f_{ck} = 30,0 \text{ MPa} = 30 \text{ N/mm}^2; \gamma_c = 1.5$$

$$f_{cd} = f_{ck}/\gamma_c = 30,0/1,5 = 20,0 \text{ MPa} = 20,0 \text{ N/mm}^2 = 2,0 \text{ kN/cm}^2$$

ARMATURA: B 450 BC;

$$f_{yk} = 450,0 \text{ MPa} = 450 \text{ N/mm}^2; \gamma_s = 1,15$$

$$f_{yd} = f_{yk}/\gamma_s = 450,0/1,15 = 393,1 \text{ MPa} = 391,3 \text{ N/mm}^2 = 39,13 \text{ kN/cm}^2$$

Krajnje polje:

Utjecajna širina: $b_{eff} = b_0 + \frac{l_0}{5} \Rightarrow b_{eff} = 30 + \frac{0.85 \cdot 650}{5} = 140,5 \text{ cm}$

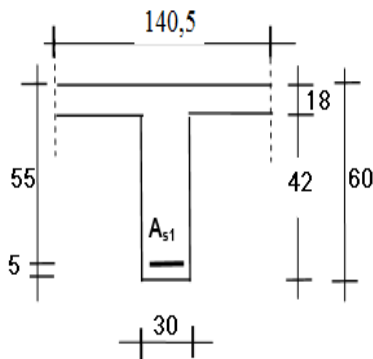

$$M_{Ed} = 259,51 \text{ kNm}$$

$$\mu_{sd} = \frac{M_{Ed}}{b_{eff} \cdot d^2 \cdot f_{cd}} = \frac{25951}{140,5 \cdot 55^2 \cdot 2,0} = 0.031$$

Očitano:

$$\varepsilon_{s1} = 10,0\% \quad \varepsilon_{c2} = 1,0\% \quad \xi = 0.091 \quad \zeta = 0.968$$

$$x = \xi \cdot d = 0.091 \cdot 55 = 5,01 \text{ cm} < h_{pl} = 18 \text{ cm}$$

$$A_{s1} = \frac{M_{Ed}}{\zeta \cdot d \cdot f_{yd}} = \frac{25951}{0.968 \cdot 55 \cdot 39,13} = 12.46 \text{ cm}^2$$

$$d_1 = 5 \text{ cm}$$

$$d = h - d_1 = 60 - 5 = 55 \text{ cm}$$

Odabrano 7Ø16 (As=14,07 cm²)

Ležaj 1:

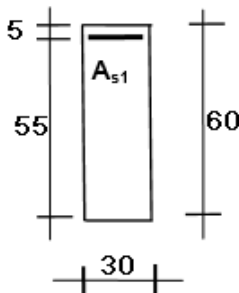

$$M_{Ed} = -247,97 \text{ kNm}$$

$$\mu_{sd} = \frac{M_{Ed}}{b_w \cdot d^2 \cdot f_{cd}} = \frac{24797}{30 \cdot 55^2 \cdot 2,0} = 0.136$$

Očitano:

$$\varepsilon_{s1} = 10,0\% \quad \varepsilon_{c2} = 3,0\% \quad \xi = 0.225 \quad \zeta = 0.907$$

$$x = \xi \cdot d = 0.225 \cdot 55 = 12,38 \text{ cm}$$

$$A_{s1} = \frac{M_{Ed}}{\zeta \cdot d \cdot f_{yd}} = \frac{24797}{0.907 \cdot 55 \cdot 39,13} = 12.70 \text{ cm}^2$$

$$d_1 = 5 \text{ cm}$$

$$d = h - d_1 = 60 - 5 = 55 \text{ cm}$$

Odabrano 7Ø16 (As=14,07 cm²)

Srednje polje – pozitivni moment:

$$\text{Utjecajna širina: } b_{eff} = b_0 + \frac{l_0}{5} \Rightarrow b_{eff} = 30 + \frac{0.70 \cdot 650}{5} = 121 \text{ cm}$$

$$d_1 = 5 \text{ cm}$$

$$d = h - d_1 = 60 - 5 = 55 \text{ cm}$$

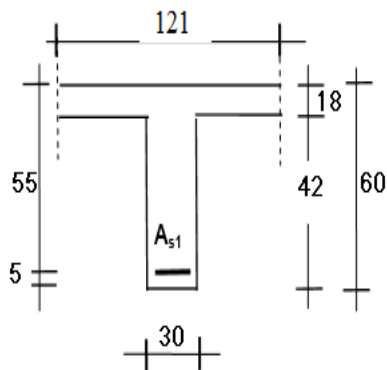

$$M_{Ed} = 36,57 \text{ kNm}$$

$$\mu_{sd} = \frac{M_{Ed}}{b_{eff} \cdot d^2 \cdot f_{cd}} = \frac{3657}{121 \cdot 55^2 \cdot 2.0} = 0.0049$$

Očitano:

$$\varepsilon_{s1} = 10.0\% \quad \varepsilon_{c2} = 0.4\% \quad \xi = 0.038 \quad \zeta = 0.987$$

$$x = \xi \cdot d = 0.038 \cdot 55 = 2.09 \text{ cm} < h_{pl} = 18 \text{ cm}$$

$$A_{s1} = \frac{M_{Ed}}{\zeta \cdot d \cdot f_{yd}} = \frac{3657}{0.987 \cdot 55 \cdot 39,13} = 1.72 \text{ cm}^2$$

Odabrano 2Ø16 (As=4,02 cm²)

Minimalna armatura:

$$A_{s1, \min} \geq 0,26 \cdot [f_{ct,m} / f_{yk}] \cdot b_t \cdot d \geq 0,0011 \cdot b_t \cdot d$$

b t – širina vlačne zone

d – statička visina presjeka

f_{yk} – karakt. granica popuštanja čelika u N/mm²

[f_{yk} = 450 N/mm² za čelik B 450BC]

f_{ct,m} - srednja vlačna čvrstoća betona (iz tablice)

[f_{ct,m} = 2,9 N/mm² za C 30/37]

$$A_{s1, \min} \geq 0,26 \cdot 2,9 / 450 \cdot 30 \cdot 55 = 2,76 \text{ cm}^2$$

$$A_{s1, \min} \geq 0,0011 \cdot b_t \cdot d = 0,0011 \cdot 30 \cdot 55 = 1,815 \text{ cm}^2$$

Maksimalna armatura:

$$A_{s1, \max} = 0.04 \cdot A_c = 0.04 \cdot 30 \cdot 60 = 72 \text{ cm}^2$$

7.3. DIMENZIONIRANJE GREDE NA POPREČNU SILU

Ležaj 1

C 30/37

$V_{Ed} = 222,55 \text{ kN}$

$N_{Ed} = 0.0 \text{ kN}$

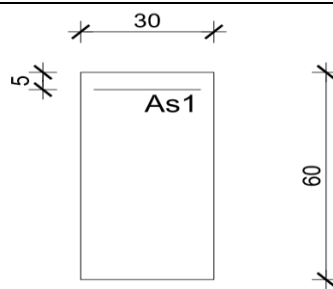

$$A_{s1} = 7\phi 16 = 14,07 \text{ cm}^2$$

$$V_{Rdc} = \left[C_{Rdc} \cdot k \cdot (100 \cdot \rho_l \cdot f_{ck})^{\frac{1}{3}} + k_1 \cdot \sigma_{cp} \right] \cdot b_w \cdot d$$

$$b_w = 30 \text{ cm} ; \quad d = 55 \text{ cm}$$

$$k = 1 + \sqrt{\frac{200}{d}} = 1 + \sqrt{\frac{200}{550}} = 1.60 \leq 2$$

$$k_1 = 0.15$$

$$\sigma_{cp} = \frac{N_{sd}}{A_c} = 0.0$$

$$\Sigma A_s = 7\phi 16 = 14,07 \text{ cm}^2$$

$$\rho_l = \frac{\Sigma A_s}{A_c} = \frac{7\phi 16}{30 \cdot 55} = \frac{14,07}{1650} = 0.0085$$

$$C_{Rdc} = \frac{0.18}{\gamma_c} = \frac{0.18}{1.5} = 0.12$$

$$V_{Rdc} = \left[0.12 \cdot 1.60 \cdot (100 \cdot 0.0085 \cdot 30)^{\frac{1}{3}} \right] \cdot 300 \cdot 550 = 93,25 \text{ kN}$$

$$V_{Rdc} \geq [v_{\min} + k_1 \cdot \sigma_{cp}] \cdot b_w \cdot d$$

$$v_{\min} = 0.035 \cdot k^{\frac{3}{2}} \cdot f_{ck}^{\frac{1}{2}} = 0.035 \cdot 1.60^{\frac{3}{2}} \cdot 30^{\frac{1}{2}} = 0.388$$

$$\sigma_{cp} = \frac{N_{sd}}{A_c} = 0.0$$

$$V_{Rdc} \geq v_{\min} \cdot b_w \cdot d = 0.388 \cdot 300 \cdot 550 = 64,02 \text{ kN} \leq V_{Ed}$$

$$V_{Ed, \max} = V_{Ed} = 222,55 \text{ kN}$$

$$V_{Rd, \max} = 0.5 \cdot v \cdot b_w \cdot d \cdot f_{cd}$$

$$v = 0.6 \cdot \left[1 - \frac{f_{ck}}{250} \right] = 0.6 \cdot \left[1 - \frac{30}{250} \right] = 0.528$$

$$V_{Rd, \max} = 0.5 \cdot 0.528 \cdot 300 \cdot 550 \cdot 20,0 = 871,2 \text{ kN} > V_{Ed, \max} = V_{Ed}$$

$$V_{Ed, \max} / V_{Rd, \max} = 222,55 / 871,2 = 0.255 \approx 0.22 \Rightarrow V_{Ed} = 0.22 V_{Rd, \max}$$

$$s_{\max} = \min\{0.75 \cdot d; 30\} = \min\{41,25; 30\} \Rightarrow s_{\max} = 30.0 \text{ cm}$$

$$\rho_{\min} = 0,0011$$

Površina minimalne armature:

$$A_{s_{w,\min}} = \frac{\rho_{\min} \cdot s_w \cdot b_w}{m} = \frac{0.0011 \cdot 30 \cdot 30}{2} = 0.495 \text{ cm}^2$$

Odabrane minimalne spone: **Ø10/30** ($A_{s_w}=0.79 \text{ cm}^2$)

$$f_{y_{w,d}} = \frac{f_{y_k}}{\gamma_s}; B450BC \Rightarrow f_{y_{w,d}} = \frac{450}{1.15} = 391,3 \text{ MPa} = 39,13 \text{ kN / cm}^2$$

$$V_{Rd} = V_{Rd,s} = \frac{A_{s_w}}{s} \cdot z \cdot f_{y_{w,d}} \cdot m \cdot \text{ctg} \theta = \frac{0.79}{30} \cdot 0.9 \cdot 55 \cdot 39,13 \cdot 2 \cdot 1$$

$$V_{Rd} = 102,01 \text{ kN}$$

$$V_{Ed} > V_{Rd}$$

Na mjestu maksimalne poprečne sile:

$$s_w \leq \frac{m \cdot A_{s_w} \cdot f_{y_{w,d}} \cdot z}{V_{Ed}} = \frac{2 \cdot 0.79 \cdot 39,13 \cdot 0.9 \cdot 55}{222,55} = 15,28 \text{ cm}$$

Odabrane spone: **Ø10/15cm** ($A_{s_w}=0.79 \text{ cm}^2$)

Ležaj 0

C 30/37

 $V_{Ed} = 152,15 \text{ kN}$ $N_{Ed} = 0,0 \text{ kN}$

B

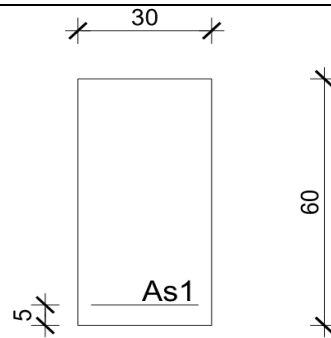

$$A_{s1} = 7\phi 16 = 14,07 \text{ cm}^2$$

$$V_{Rdc} = \left[C_{Rdc} \cdot k \cdot (100 \cdot \rho_l \cdot f_{ck})^{\frac{1}{3}} + k_1 \cdot \sigma_{cp} \right] \cdot b_w \cdot d$$

$$b_w = 30 \text{ cm} \quad ; \quad d = 55 \text{ cm}$$

$$k = 1 + \sqrt{\frac{200}{d}} = 1 + \sqrt{\frac{200}{550}} = 1,60 \leq 2$$

$$k_1 = 0,15$$

$$\sigma_{cp} = \frac{N_{sd}}{A_c} = 0,0$$

$$\Sigma A_s = 7\phi 16 = 14,07 \text{ cm}^2$$

$$\rho_l = \frac{\Sigma A_s}{A_c} = \frac{7\phi 16}{30 \cdot 55} = \frac{14,07}{1650} = 0,0085$$

$$C_{Rdc} = \frac{0,18}{\gamma_c} = \frac{0,18}{1,5} = 0,12$$

$$V_{Rdc} = \left[0,12 \cdot 1,60 \cdot (100 \cdot 0,0085 \cdot 0)^{\frac{1}{3}} \right] \cdot 300 \cdot 550 = 93,25 \text{ kN}$$

$$V_{Rdc} \geq [v_{\min} + k_1 \cdot \sigma_{cp}] \cdot b_w \cdot d$$

$$v_{\min} = 0,035 \cdot k^{\frac{3}{2}} \cdot f_{ck}^{\frac{1}{2}} = 0,035 \cdot 1,60^{\frac{3}{2}} \cdot 30^{\frac{1}{2}} = 0,388$$

$$\sigma_{cp} = \frac{N_{sd}}{A_c} = 0,0$$

$$V_{Rdc} \geq v_{\min} \cdot b_w \cdot d = 0,388 \cdot 300 \cdot 550 = 64,02 \text{ kN} \leq V_{Ed}$$

$$V_{Ed, \max} = V_{Ed} = 152,15 \text{ kN}$$

$$V_{Rd, \max} = 0,5 \cdot v \cdot b_w \cdot d \cdot f_{cd}$$

$$v = 0,6 \cdot \left[1 - \frac{f_{ck}}{250} \right] = 0,6 \cdot \left[1 - \frac{30}{250} \right] = 0,528$$

$$V_{Rd, \max} = 0,5 \cdot 0,528 \cdot 300 \cdot 550 \cdot 20,0 = 871,2 \text{ kN} > V_{Ed, \max} = V_{Ed}$$

$$V_{Ed, \max} / V_{Rd, \max} = 152,15 / 871,2 = 0,16 \approx 0,14 \Rightarrow V_{Ed} = 0,14 V_{Rd, \max}$$

$$s_{\max} = \min\{0.75 \cdot d; 30\} = \min\{41.25; 30\} \Rightarrow s_{\max} = 30.0 \text{ cm}$$

$$\rho_{\min} = 0,0011$$

Površina minimalne armature:

$$A_{s_w, \min} = \frac{\rho_{\min} \cdot s_w \cdot b_w}{m} = \frac{0.0011 \cdot 30 \cdot 30}{2} = 0.495 \text{ cm}^2$$

Odabrane minimalne spone: **Ø10/30** ($A_{s_w} = 0.79 \text{ cm}^2$)

$$f_{y_w, d} = \frac{f_{y_k}}{\gamma_s}; B450BC \Rightarrow f_{y_w, d} = \frac{450}{1.15} = 391,3 \text{ MPa} = 39,13 \text{ kN / cm}^2$$

$$V_{Rd} = V_{Rd, s} = \frac{A_{s_w}}{s} \cdot z \cdot f_{y_w, d} \cdot m \cdot \text{ctg} \theta = \frac{0.79}{30} \cdot 0.9 \cdot 55 \cdot 39,13 \cdot 2 \cdot 1$$

$$V_{Rd} = 102,01 \text{ kN}$$

$$V_{Ed} > V_{Rd}$$

Na mjestu maksimalne poprečne sile:

$$s_w \leq \frac{m \cdot A_{s_w} \cdot f_{y_w, d} \cdot z}{V_{Ed}} = \frac{2 \cdot 0.79 \cdot 39,13 \cdot 0.9 \cdot 55}{152,15} = 20,12 \text{ cm}$$

Odabrane spone **Ø10/20cm** ($A_{s_w} = 0.79 \text{ cm}^2$)

7.4. KONTROLA PUKOTINA GREDE POZICIJE 100

Granično stanje uporabljivosti: 1.0 vlastita teжина "+" 1.0 dodatno stalno "+" 1.0 uporabno

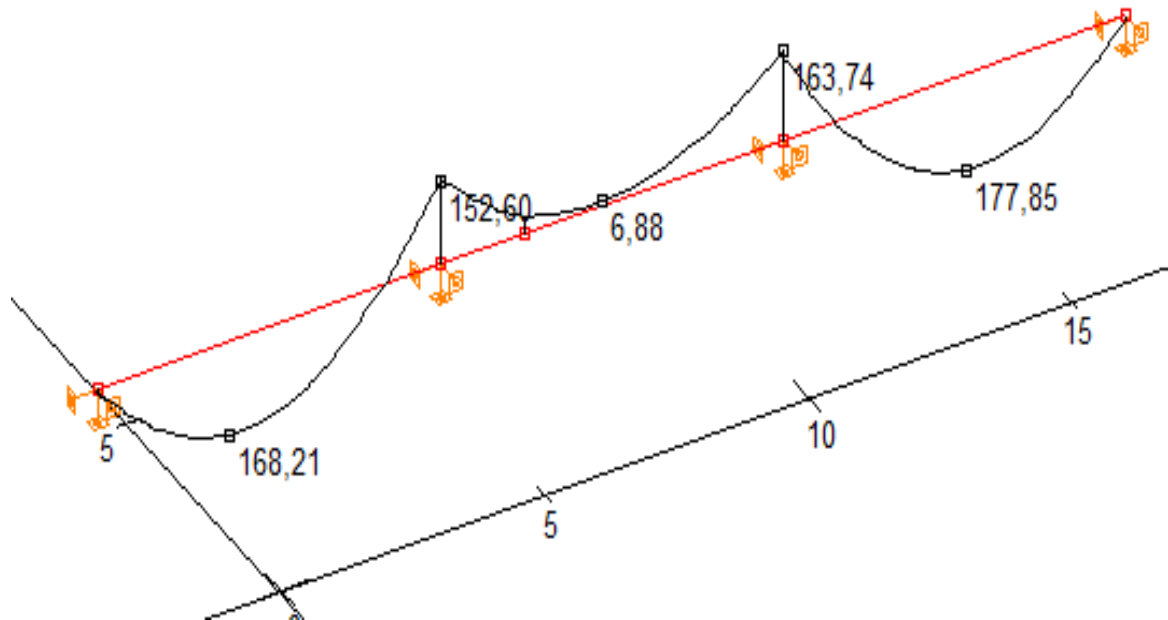

Slika7.17.Moment (kNm)

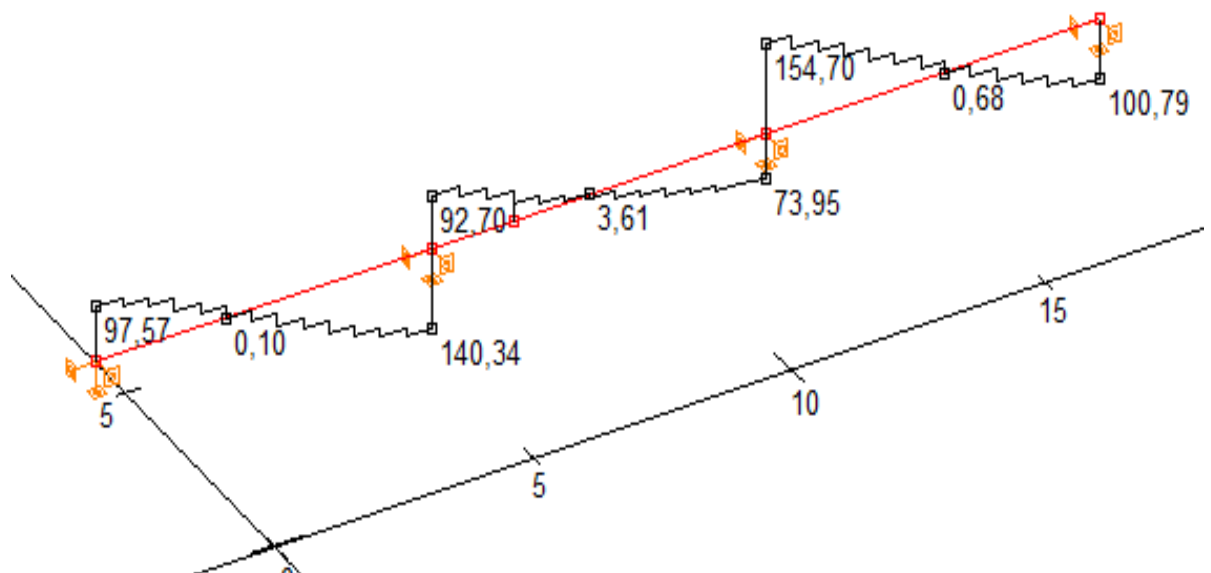

Slika7.18.Poprečna sila (kN)

Polje:

$$M_{Ed} = 177,85 \text{ kNm}$$

Prognoza širine pukotine:

$$w_k = S_{r,max} \cdot (\varepsilon_{s,m} - \varepsilon_{c,m})$$

Proračun srednje deformacije armature:

$$(\varepsilon_{sm} - \varepsilon_{cm}) = \frac{\sigma_s - k_t \cdot \frac{f_{ct,eff}}{\rho_{p,eff}} \cdot (1 + \alpha_e \cdot \rho_{p,eff})}{E_s} \geq 0.6 \cdot \frac{\sigma_s}{E_s}$$

$$E_{cm} = 32.00 \text{ GPa} = 32000 \text{ MPa} - \text{modul elastičnosti betona}$$

$$E_s = 200.0 \text{ GPa} = 200000.0 \text{ MPa} - \text{modul elastičnosti armature}$$

$$f_{ctm} = 2,9 \text{ MPa} - \text{za betone klase C 30/37}$$

$$k_t = 0.4 - \text{dugotrajno opterećenje}$$

$$\alpha_e = \frac{E_s}{E_{cm}} = \frac{200}{35,0} = 5.71$$

$$x = \frac{\alpha_e \cdot A_{s1}}{b} \cdot \left(-1 + \sqrt{1 + \frac{2 \cdot b \cdot d}{\alpha_e \cdot A_{s1}}} \right) = \frac{5.71 \cdot 14,07}{30} \cdot \left(-1 + \sqrt{1 + \frac{2 \cdot 30 \cdot 55}{5.71 \cdot 14,07}} \right) = 14,70 \text{ cm}$$

$$\sigma_s = \frac{M_{Ed}}{z \cdot A_{s1}} \approx \frac{M_{Ed}}{\left(d - \frac{x}{3}\right) \cdot A_{s1}} = \frac{17785}{\left(55 - \frac{14,70}{3}\right) \cdot 14,07} = 25,23 \text{ kN/cm}^2 = 252,30 \text{ Mpa}$$

$$\rho_{p,eff} = \frac{A_{s1}}{A_{c,eff}} = \frac{A_{s1}}{b \cdot 2.5 \cdot d_1} = \frac{14,07}{30 \cdot 2.5 \cdot 5.0} = 0.0375$$

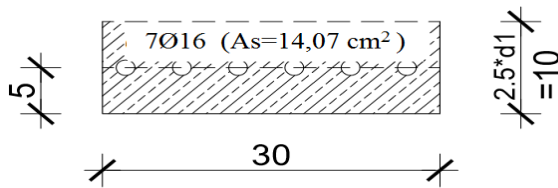

$$(\varepsilon_{sm} - \varepsilon_{cm}) = \frac{252,30 - 0.4 \cdot \frac{2,9}{0.0375} \cdot (1 + 5.71 \cdot 0.0375)}{200000} \geq 0.6 \cdot \frac{252,30}{200000}$$

$$\frac{214,74}{200000} > \frac{151,38}{200000}$$

$$(\varepsilon_{sm} - \varepsilon_{cm}) = 0.00107$$

Proračun srednjeg razmaka pukotina:

$$S_{r,max} = k_3 \cdot c + k_1 \cdot k_2 \cdot k_4 \cdot \frac{\phi}{\rho_{p,eff}}$$

$\phi = 16 \text{ mm}$ – promjer najdeblje šipke

$k_1 = 0.8$ – Rebrasta armatura

$k_2 = 0.5$ – Savijanje

$k_3 = 3.4$

$k_4 = 0.425$

$c = d_1 - \frac{\phi}{2} = 50 - \frac{16}{2} = 42 \text{ mm}$ - zaštitni sloj uzdužne armature

$$S_{r,max} = 3.4 \cdot 42 + 0.8 \cdot 0.5 \cdot 0.425 \cdot \frac{16}{0.375} = 150,05 \text{ mm}$$

$$W_k = w_k = S_{r,max} \cdot (\varepsilon_{s,m} - \varepsilon_{c,m}) = 150,05 \cdot 0.00107 = 0.161 \text{ mm} < 0.300 \text{ mm}$$

→ pukotine zadovoljavaju

Ležaj:

$$M_{Ed} = 163,74 \text{ kNm}$$

Prognoza širine pukotine:

$$w_k = S_{r,max} \cdot (\varepsilon_{s,m} - \varepsilon_{c,m})$$

Proračun srednje deformacije armature:

$$(\varepsilon_{sm} - \varepsilon_{cm}) = \frac{\sigma_s - k_t \cdot \frac{f_{ct,eff}}{\rho_{p,eff}} \cdot (1 + \alpha_e \cdot \rho_{p,eff})}{E_s} \geq 0.6 \cdot \frac{\sigma_s}{E_s}$$

$E_{cm} = 32.00 \text{ GPa} = 32000 \text{ MPa}$ – modul elastičnosti betona

$E_s = 200.0 \text{ GPa} = 200000.0 \text{ MPa}$ – modul elastičnosti armature

$f_{ctm} = 2,9 \text{ MPa}$ - za betone klase C 30/37

$k_t = 0.4$ - dugotrajno opterećenje

$$\alpha_e = \frac{E_s}{E_{cm}} = \frac{200}{35,0} = 5.71$$

$$x = \frac{\alpha_e \cdot A_{s1}}{b} \cdot \left(-1 + \sqrt{1 + \frac{2 \cdot b \cdot d}{\alpha_e \cdot A_{s1}}} \right) = \frac{5.71 \cdot 14,07}{30} \cdot \left(-1 + \sqrt{1 + \frac{2 \cdot 30 \cdot 55}{5.71 \cdot 14,07}} \right) = 14,70 \text{ cm}$$

$$\sigma_s = \frac{M_{Ed}}{z \cdot A_{s1}} \approx \frac{M_{Ed}}{\left(d - \frac{x}{3} \right) \cdot A_{s1}} = \frac{16374}{\left(55 - \frac{14,70}{3} \right) \cdot 14,07} = 23,23 \text{ kN/cm}^2 = 232,28 \text{ MPa}$$

$$\rho_{p,eff} = \frac{A_{s1}}{A_{c,eff}} = \frac{A_{s1}}{b \cdot 2.5 \cdot d_1} = \frac{14,07}{30 \cdot 2.5 \cdot 5.0} = 0.0375$$

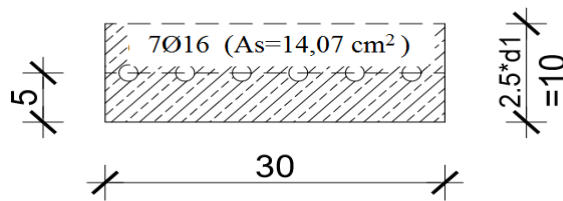

$$(\varepsilon_{sm} - \varepsilon_{cm}) = \frac{232,82 - 0.4 \cdot \frac{2,9}{0.0375} \cdot (1 + 5.71 \cdot 0.0375)}{200000} \geq 0.6 \cdot \frac{232,82}{200000}$$

$$\frac{195,26}{200000} > \frac{139,69}{200000}$$

$$(\varepsilon_{sm} - \varepsilon_{cm}) = 0.00098$$

Proračun srednjeg razmaka pukotina:

$$S_{r,max} = k_3 \cdot c + k_1 \cdot k_2 \cdot k_4 \cdot \frac{\phi}{\rho_{p,eff}}$$

$\phi = 16$ mm – promjer najdeblje šipke

$k_1 = 0.8$ - Rebrasta armatura

$k_2 = 0.5$ – Savijanje

$k_3 = 3.4$

$k_4 = 0.425$

$c = d_1 - \frac{\phi}{2} = 50 - \frac{16}{2} = 42$ mm - zaštitni sloj uzdužne armature

$$S_{r,max} = 3.4 \cdot 42 + 0.8 \cdot 0.5 \cdot 0.425 \cdot \frac{16}{0.0375} = 215,33 \text{ mm}$$

$$W_k = w_k = S_{r,max} \cdot (\varepsilon_{s,m} - \varepsilon_{c,m}) = 215,33 \cdot 0.00098 = 0.211 \text{ mm} \leq 0.300 \text{ mm}$$

→ pukotine zadovoljavaju!

7.5. KONTROLA PROGIBA GREDE POZICIJE 100

Progib kontroliramo za nefaktorizirano opterećenje i bez utjecaja puzanja.

Kontrola progiba za Polje 1:

Granični progib:

$$v_{\text{lim}} = \frac{L}{250} = \frac{650}{250} = 2.6 \text{ cm}$$

Beton: C 30/37; $f_{ck}=30.0 \text{ MPa}$

$$E_{cm} = 32000 \text{ MPa}$$

$$f_{cm} = 0.3 \cdot (f_{ck})^{2/3} = 0.3 \cdot (30.0)^{2/3} = 2.9 \text{ MPa}$$

Čelik: B450BC ; $E_s= 200.0 \text{ GPa}$

$$\alpha_{el} = \frac{E_s}{E_{cm}} = \frac{200.0}{35} = 5.71$$

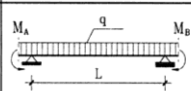
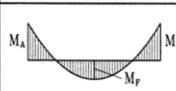
Red	Tip opterećenja	Dijagram momenata savijanja	Koeficijent k iz izraza (5.131)
7			$k = \frac{5}{48} (1 - 0.1\beta)$ $\beta = M_A + M_B / M_F $

$$v_{\text{tot}} = k \cdot L^2 \cdot \frac{1}{r_{\text{tot}}}$$

$$\beta = |M_A + M_B| / |M_F| = |0.0 + 163,74| / |177,85| = 0.921$$

$$k = \frac{5}{48} \cdot (1 - 0.1 \cdot \beta) = 0.104 \cdot (1 - 0.1 \cdot 0.921) = 0.0944$$

Presjek u polju:

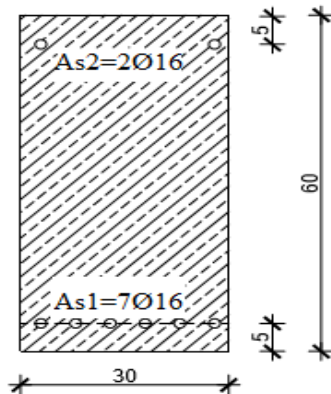

$$A_{s1} = 7\text{Ø}16 = 14,07 \text{ cm}^2$$

$$A_{s2} = 2\text{Ø}16 = 4,02 \text{ cm}^2$$

$$I_I = \frac{bh^3}{12} + \alpha_{el} \cdot \left[A_{s1} \cdot \left(\frac{h}{2} - d_2 \right)^2 + A_{s2} \cdot \left(\frac{h}{2} - d_1 \right)^2 \right]$$

$$= \frac{30 \cdot 60^3}{12} + 5,71 \cdot \left[14,07 \cdot \left(\frac{60}{2} - 5 \right)^2 + 4,02 \cdot \left(\frac{60}{2} - 5 \right)^2 \right] =$$

$$= 60455869 \text{ cm}^4$$

$$E_{c,eff} = E_{cm} = 32,0 \text{ GN/m}^2 = 3200,0 \text{ kN/cm}^2$$

$$\frac{1}{r_I} = \frac{M_{Ed}}{E_{c,eff} \cdot I_I} = \frac{17785}{3200 \cdot 60455869} = 0,0000092 \frac{1}{\text{cm}}$$

Progib potpuno raspucanog presjeka:

$$x = 14,70 \text{ cm}$$

$$I_{II} = \frac{bx^3}{12} + bx \cdot \left(\frac{x}{2} \right)^2 + \alpha_{el} \cdot \left[A_{s1} \cdot (d - x)^2 + A_{s2} \cdot (x - d_2)^2 \right]$$

$$= \frac{30 \cdot 14,70^3}{12} + (30 \cdot 14,70) \cdot \left(\frac{14,70}{2} \right)^2 + 5,71 \cdot \left[14,07 \cdot (55 - 14,70)^2 + 4,02 \cdot (14,70 - 5)^2 \right]$$

$$= 17115245 \text{ cm}^4$$

$$\frac{1}{r_{II}} = \frac{M_{Ed}}{E_{c,eff} \cdot I_{II}} = \frac{17785}{3200 \cdot 17115245} = 0,0000325 \frac{1}{\text{cm}}$$

Ukupni progib:

$$\sigma_s = 232,28 \text{ MPa}$$

$$\sigma_{sr} = \frac{M_{cr}}{\left(d - \frac{x}{3}\right) \cdot A_{s1}}$$

$$M_{cr} = f_{ctm} \cdot W = f_{ctm} \cdot \frac{b \cdot h^2}{6} = 2,9 \cdot \frac{30 \cdot 60^2}{6} = 52200$$

$$\sigma_{sr} = \frac{52200}{\left(55 - \frac{14,70}{3}\right) \cdot 14,07} = 74,05 \text{ MPa}$$

$\beta_1 = 1.0$ - Rebrasta armatura

$\beta_2 = 0.5$ - Dugotrajno opterećenje

$$\zeta = 1 - \beta_1 \cdot \beta_2 \cdot \left(\frac{\sigma_{sr}}{\sigma_s}\right)^2 = 1 - 1.0 \cdot 0.5 \cdot \left(\frac{74,05}{232,28}\right)^2 = 0.949$$

$$\frac{1}{r_I} = 0.0000092 \frac{1}{\text{cm}}$$

$$\frac{1}{r_{II}} = 0.0000325 \frac{1}{\text{cm}}$$

$$\frac{1}{r_m} = (1 - \zeta) \cdot \frac{1}{r_I} + \zeta \cdot \frac{1}{r_{II}} = (1 - 0.949) \cdot 0.0000092 + 0.949 \cdot 0.0000325 = 0.0000313 \frac{1}{\text{cm}}$$

$$k = 0.0944$$

$$L = 650.0 \text{ cm}$$

$$v_{tot,t=0} = k \cdot L^2 \cdot \frac{1}{r_{tot}} = 0.0944 \cdot 650.0^2 \cdot 0.0000313 = 1.25 \text{ cm} < v_{lim} = 2.6 \text{ cm}$$

8. PRORAČUN STUBIŠTA

8.1. MJERODAVNE REZNE SILE

- Moment savijanja mjerodavan za dimenzioniranje stubišta dobiva se iz kombinacije za granično stanje nosivosti na ležajevima pozicije 100.

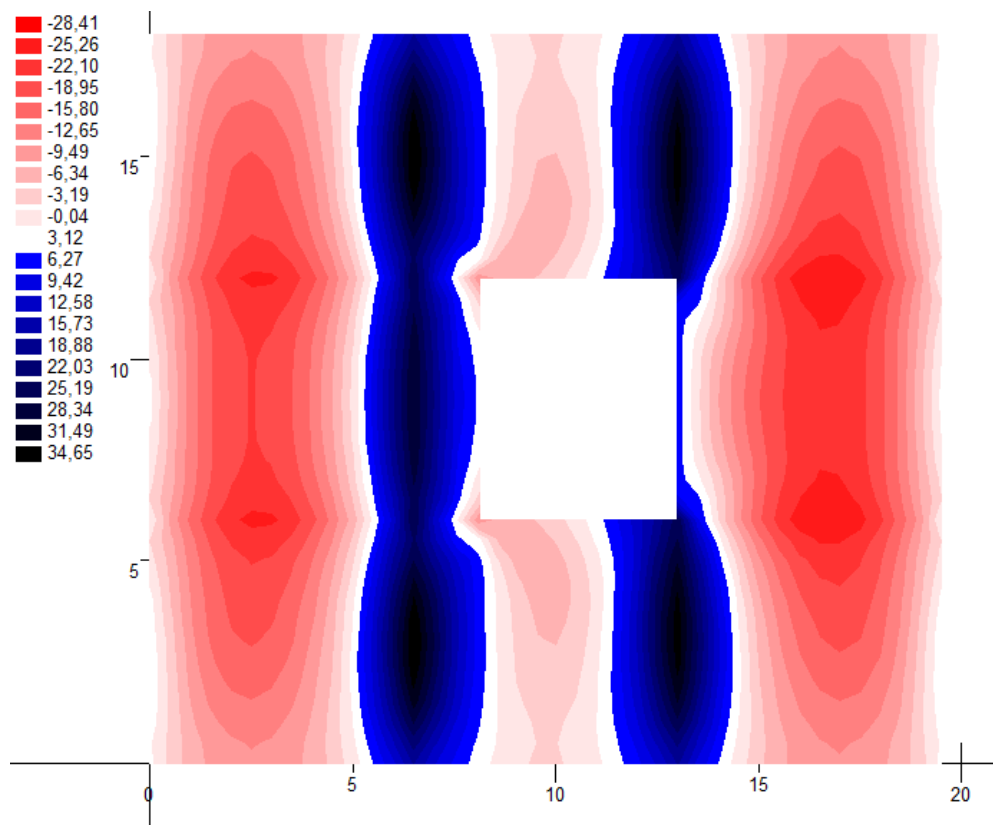

Slika 8.1. Moment M_x (kNm) za GSN na ležajevima pozicije 100

8.2. DIMENZIONIRANJE STUBIŠTA

Polje

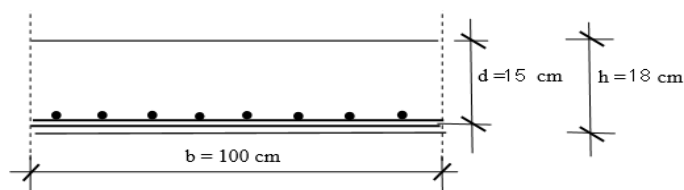

$$M_{Ed} = 25,26 \text{ kNm/m}$$

$$\mu_{sd} = \frac{M_{Ed}}{b \cdot d^2 \cdot f_{cd}} = \frac{2526}{100 \cdot 15^2 \cdot 2.0} = 0.056$$

$$\text{Očitano: } \varepsilon_{s1} = 10.0\% \quad \varepsilon_{c2} = 1.5\% \quad \xi = 0.130 \quad \zeta = 0.953$$

$$A_{s1} = \frac{M_{Ed}}{\zeta \cdot d \cdot f_{yd}} = \frac{2526}{0.953 \cdot 15 \cdot 39,13} = 4,51 \text{ cm}^2/\text{m}$$

Odabrana mreža: **R-503** - $A_s = 5,03 \text{ cm}^2/\text{m}$

Ležaj stubište – 105

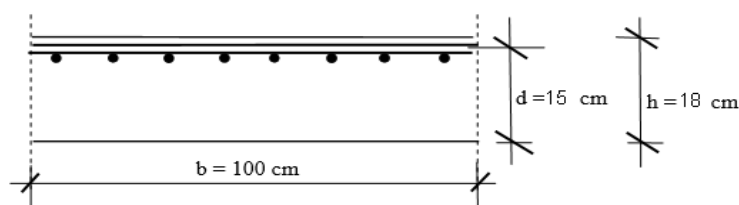

$$M_{Ed} = 31,49 \text{ kNm/m}$$

$$\mu_{sd} = \frac{M_{Ed}}{b \cdot d^2 \cdot f_{cd}} = \frac{3149}{100 \cdot 15^2 \cdot 2.0} = 0.069$$

$$\text{Očitano: } \varepsilon_{s1} = 10.0\% \quad \varepsilon_{c2} = 1.7\% \quad \xi = 0.145 \quad \zeta = 0.947$$

$$A_{s1} = \frac{M_{Ed}}{\zeta \cdot d \cdot f_{yd}} = \frac{3149}{0.947 \cdot 15 \cdot 39,13} = 5,67 \text{ cm}^2/\text{m}$$

Odabrana armatura: **R-785** - $A_s = 7,85 \text{ cm}^2/\text{m}$

9. PRORAČUN STUPOVA

9.1. MOMENTI SAVIJANJA I UZDUŽNE SILE STUPOVA

Kombinacije opterećenja s VJETROM :

1. kombinacija opterećenja: $1,35 \cdot (g + \Delta g) + 1,5 \cdot q + 1,5 \cdot W_x$

2. kombinacija opterećenja: $1,35 \cdot (g + \Delta g) + 1,5 \cdot q + 1,5 \cdot W_y$

9.1.1. Kombinacija 1

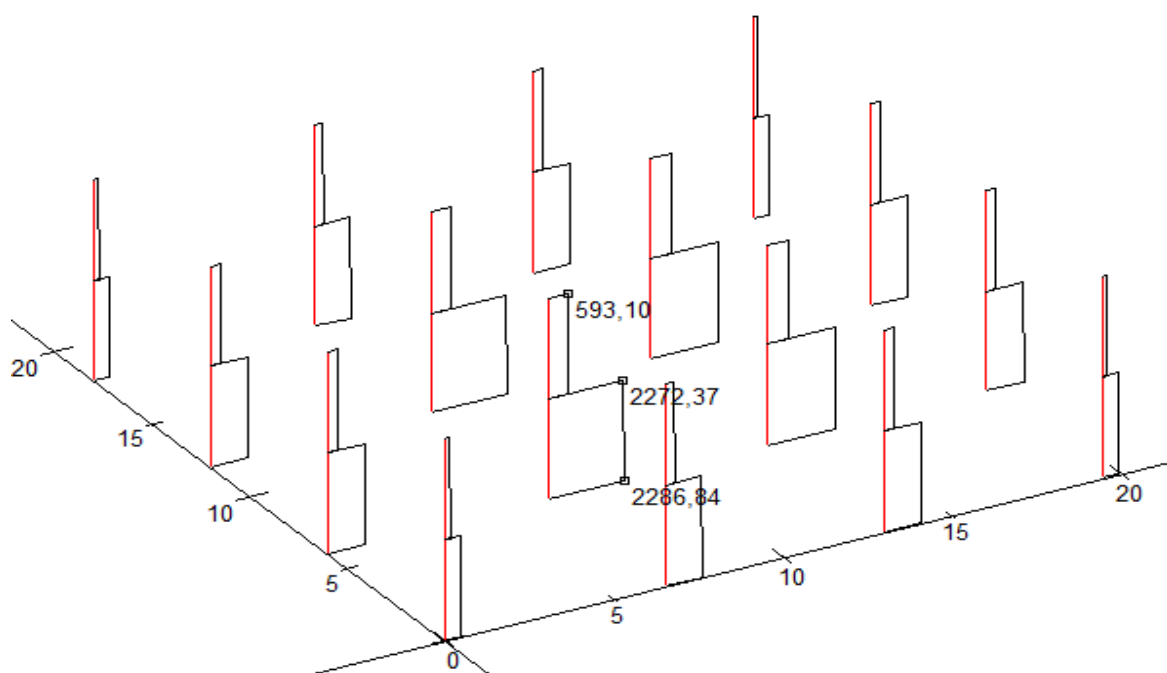

Slika 9.1. Dijagram uzdužnih sila

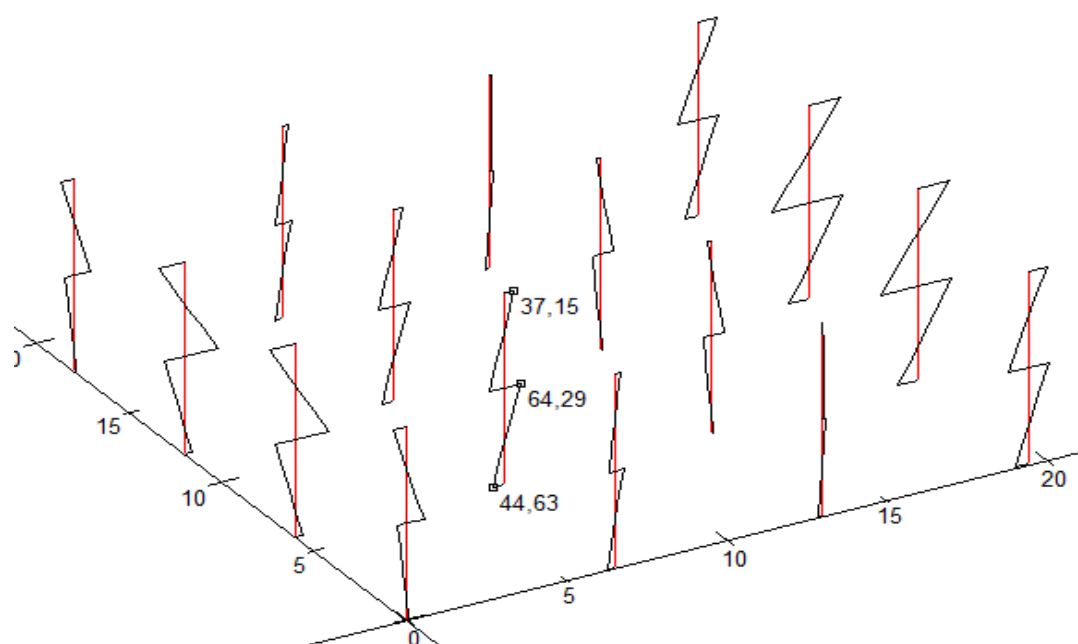

Slika 9.2. Dijagram momenta savijanja

9.1.2. Kombinacija 2

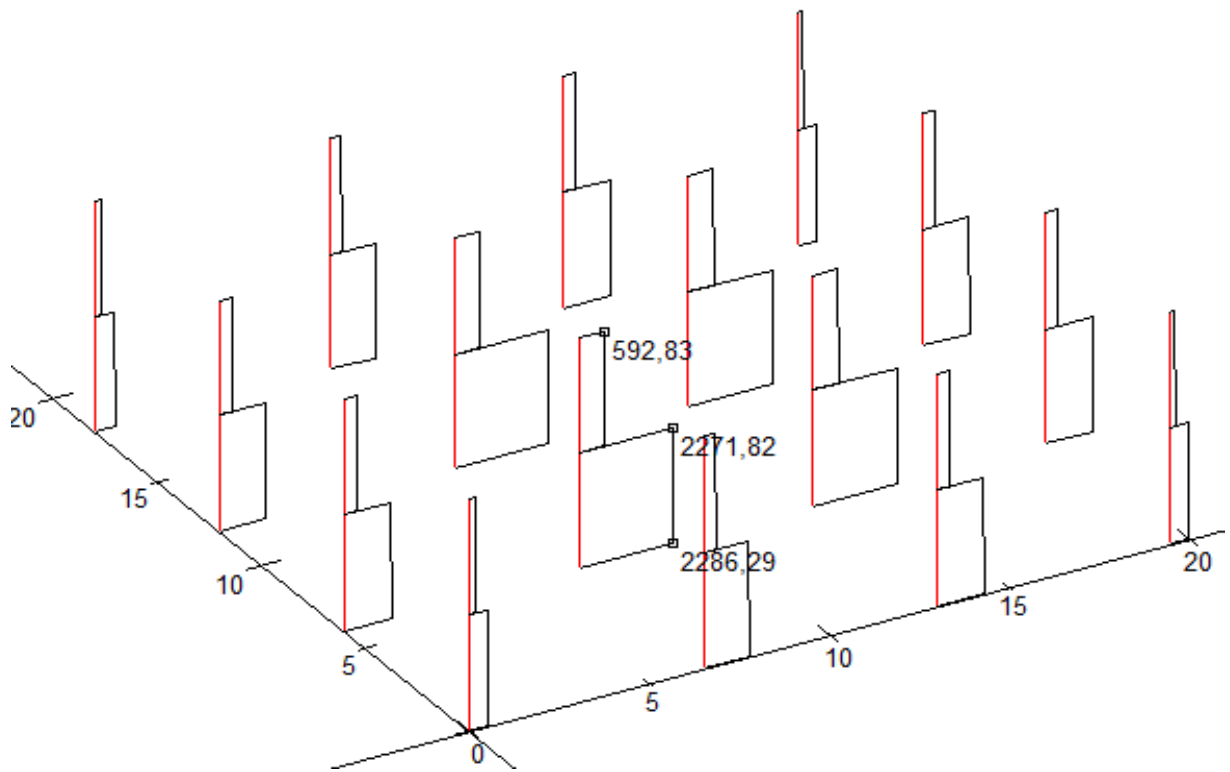

Slika 9.3. Dijagram uzdužnih sila

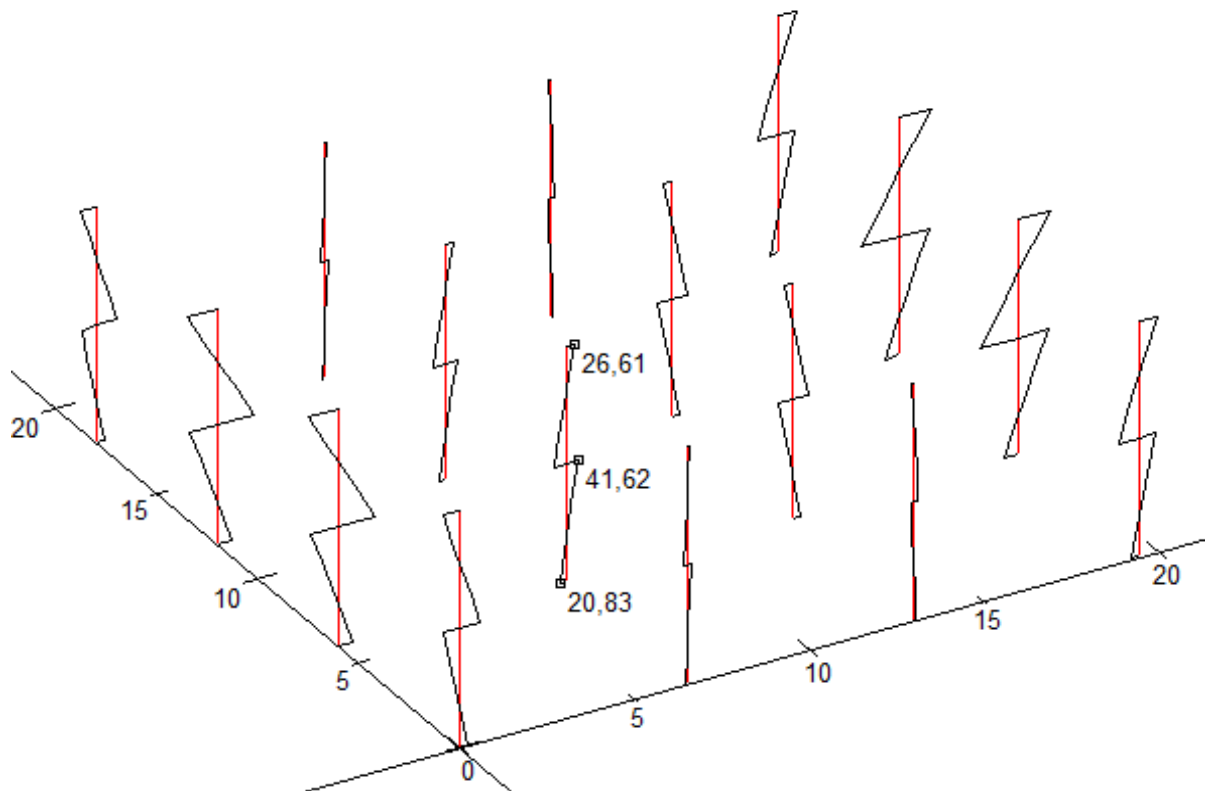

Slika 9.4. Dijagram momenta savijanja

Tablica 9.1. Rezne sile u stupovima

		M(kNm)	N(kN)
1. Kombinacija	MaxN	64,29	-2286,84
2. Kombinacija	Max N	41,62	-2286,29

9.2. DIMENZIONIRANJE STUPA

9.2.1. Određivanje dimenzija stupova

Najnepovoljniji utjecaj je na srednji stup. Vanjske stupove na koje otpada nešto manje vertikalno opterećenje nećemo razmatrati posebno već ćemo sve stupove tretirati kao da su središnji.

$$N_{100} = (\gamma_g \cdot (g_{100} + \Delta g_{100}) + \gamma_q \cdot q_{100}) \cdot L_1 \cdot L_2$$

$$N_{100} = (1.35 \cdot 7.7 + 1.5 \cdot 3.7) \cdot 6.5 \cdot 6.0$$

$$N_{100} = 621,86 \text{ kN}$$

$$N_{200} = (\gamma_g \cdot (g_{200} + \Delta g_{200}) + \gamma_q \cdot q_{200}) \cdot L_1 \cdot L_2$$

$$N_{200} = (1.35 \cdot 8.30 + 1.5 \cdot 1.0) \cdot 6.5 \cdot 6.0$$

$$N_{200} = 495,5 \text{ kN}$$

$$N = 1117,36 \text{ kN}$$

$$\text{Klasa betona: C30/37} \rightarrow f_{cd} = \frac{30}{1.5} = 20,0 \text{ MPa}$$

Radi puzanja naprezanja u betonu ograničavamo na 45% tlačne čvrstoće betona.

$$A_{c,potr} = b \cdot h > (1,35 \cdot N_G + 1,5 \cdot N_Q) / 0,45 \cdot f_{cd} = 1117,36 / 0,45 \cdot 20 = 1241,5 \text{ cm}^2$$

Zbog simetričnosti konstrukcije, a uzimajući u obzir da je stup centrično opterećen, odabiremo kvadratni presjek stupa.

$$a = \sqrt{A} = \sqrt{1241,5} = 0.3192 \text{ m} = 35,23 \text{ cm}$$

odabrano: $a = 35 \text{ cm}$

9.2.2. Dimenzioniranje pomoću dijagrama interakcije

Rezne sile dobivene u programu *AspalathosLinearsu* po teoriji I. reda.

Tablica 9.2. Rezne sile u stupovima

M(kNm)	N(kN)
64,29	-2286,84
41,62	-2286,29

Pretpostavljamo:

(za $\alpha=1,0$ –simetrična armatura; $\beta=d1/h = d2/h = 5/45=0,1$)

$$v_{sd1} = \frac{N_{Ed1}}{b \cdot h \cdot f_{cd}} = \frac{-2286,84}{35 \cdot 35 \cdot 2.0} = -0,93$$

$$v_{sd2} = \frac{N_{Ed2}}{b \cdot h \cdot f_{cd}} = \frac{-2286,29}{35 \cdot 35 \cdot 2.0} = -0,93$$

$$\mu_{sd1} = \frac{M_{Ed1}}{b \cdot h^2 \cdot f_{cd}} = \frac{64,29 \cdot 100}{35 \cdot 35^2 \cdot 2.0} = 0,08$$

$$\mu_{sd2} = \frac{M_{Ed2}}{b \cdot h^2 \cdot f_{cd}} = \frac{41,62 \cdot 100}{35 \cdot 35^2 \cdot 2.0} = 0,05$$

mehanički koeficijent armiranja $\omega_1 = 0,05$

$$\omega_2 = 0,05$$

$$A_{s1}=A_{s2}=\omega \cdot \frac{f_{cd}}{f_{yd}} \cdot b \cdot h = 0,05 \cdot \frac{2.0}{39,13} \cdot 35 \cdot 35 = 3.13 \text{ cm}^2$$

Ukupna površina armature za simetrično armiranje

$$A_{s1} + A_{s2} = 3.13 \cdot 2 = 6,26 \text{ cm}^2$$

$$A_{s,\min} = 0,1 \cdot N_{Ed} / f_{yd} = 0,1 \cdot 2286 / 39,13 = 5,8 \text{ cm}^2$$

$$A_{s,\min} = 0,002 \cdot A_c = 0,002 \cdot 1241,5 = 2.5 \text{ cm}^2$$

Odabrane šipke: 4 \emptyset 16+4 \emptyset 16 ($A_s=8,04+8,04=16,08 \text{ cm}^2$)

9.2.3. Proračun poprečne armature stupa

Površinu poprečne armature uzima se kao kod greda $\phi 10$ ($A_s = 0.79 \text{ cm}^2$)

Razmak spona:

$$S = \min (b = 45 \text{ cm} ; 15 \times \phi = 15 \times 1.6 = 27 \text{ cm})$$

ODABRANO:

Spone $\phi 10/25 \text{ cm}$

U blizini ležaja razmak spona umanjivamo faktorom 0.6 i razmak iznosi 15 cm.

10. PRORAČUN TEMELJA SAMCA ISPOD STUPA

10.1. DIMENZIONIRANJE TEMELJA

Temelj je proračunat za granično stanje nosivosti. Za dobivanje mjerodavnih naprezanja na spoju stup – temelj korištene su slijedeće kombinacije opterećenja:

$$1,35 \cdot g_{\text{vl.težina}} + 1,35 \cdot g_{\text{dodatno stalno}} + 1,5 \cdot q + 1,5 \cdot w_x$$

$$1,35 \cdot g_{\text{vl.težina}} + 1,35 \cdot g_{\text{dodatno stalno}} + 1,5 \cdot q + 1,5 \cdot w_y$$

Iz navedenih kombinacija dobiveni su parovi maksimalnih uzdužnih sila i pripadnih momenata, te maksimalnih momenata i pripadnih uzdužnih sila od kojih odabiremo dva para sila mjerodavna za dimenzioniranje temelja.

Odabrane mjerodavne sile na spoju:

- 1. kombinacija: $N_{\text{max}} = 2286,64 \text{ kN}$
 $M_{\text{pripadno}} = 64,29 \text{ kNm}$
- 2. kombinacija: $M_{\text{max}} = 41,62 \text{ kNm}$
 $N_{\text{pripadno}} = 2286,29 \text{ kN}$

10.1.1. Preliminarno određivanje dimenzija temelja

Temelj je centrično opterećen zbog čega odabiremo kvadratni poprečni presjek.

Dopuštena naprezanja u tlu (ovise o vrsti tla): $\sigma_{\text{dop}} = 0,5 \text{ MN/m}^2$

Širina i duljina temelja: $d = \check{s} = b = a_{\text{stup}} \cdot \sqrt{\frac{f_{\text{cd}}^*}{\sigma_{\text{t,dop}}}} = a_{\text{stup}} \cdot \sqrt{\frac{0,45f_{\text{ck}}}{\sigma_{\text{t,dop}}}} = 0,35 \cdot$

$$\sqrt{\frac{0,45 \cdot 30}{0,50}} = 1,85 \text{ m}$$

Visina temelja: $v = 2 \cdot a_{\text{stup}} = 2 \cdot 0,35 = 0,70 \text{ m} = 70 \text{ cm}$

Težina temelja: $N_t = 1,9 \cdot 1,9 \cdot 0,7 \cdot 25 = 63,18 \text{ (kN)}$

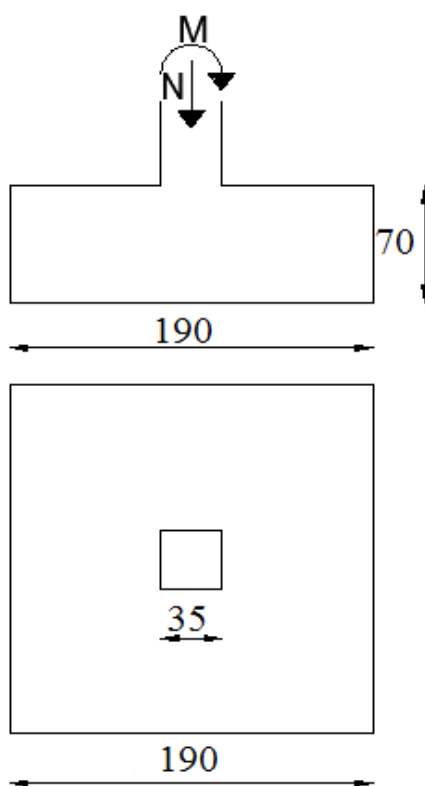

Slika 10.1. Preliminarne dimenzije temelja

10.2. NAPREZANJA NA DODIRNOJ PLOHI TEMELJ – TLO

$$\sigma_{1,2} = \frac{N}{A} \pm \frac{M}{W}$$

$$A = 1,9 \cdot 1,9 = 3,61 \text{ m}^2$$

$$W = \frac{bh^2}{6} = \frac{1,9 \cdot 1,9^2}{6} = 1.14 \text{ m}^3$$

- **1. kombinacija**

$$N_{\max} = 2286,64 \text{ kN} \quad \rightarrow N_{\text{Ed}} = N_{\max} + N_t = 2286,64 + 63,18 = 2349,82 \text{ kN}$$

$$M_{\text{pripadno}} = 64,29 \text{ kNm}$$

$$\sigma_{1,2} = \frac{N}{A} \pm \frac{M}{W} = \frac{2349,82}{3,61} \pm \frac{64,29}{1.14} = 650,92 \pm 56,39$$

$$\sigma_1 = 707,31 \text{ kN/m}^2$$

$$\sigma_2 = 594,53 \text{ kN/m}^2$$

- **2. Kombinacija**

$$M_{\max} = 41,62 \text{ kNm}$$

$$N_{\text{pripadno}} = 2286,29 \text{ kN} \quad \rightarrow N_{\text{Ed}} = N_{\text{prip}} + N_t = 2286,29 + 63,18 = 2349,47 \text{ kN}$$

$$\sigma_{1,2} = \frac{N}{A} \pm \frac{M}{W} = \frac{2349,47}{3,61} \pm \frac{41,62}{1.14} = 650,82 \pm 36,51$$

$$\sigma_1 = 687,32 \frac{\text{kN}}{\text{m}^2}$$

$$\sigma_2 = 614,21 \text{ kN}$$

10.3. PRORAČUN ARMATURE TEMELJA

➤ Momenti u presjeku 1-1

$$M_{1-1} = \sigma_{1-1} \cdot b_1 \cdot \frac{b_1}{2} + (\sigma_1 - \sigma_{1-1}) \cdot \frac{b_1}{2} \cdot \frac{2}{3} \cdot b_1$$

$$\sigma_{1-1} = \sigma_1 - \frac{b_1}{b} \cdot (\sigma_1 - \sigma_2)$$

• 1. kombinacija

$$\sigma_{1-1} = 707,31 - \frac{0,775}{1,9} \cdot (707,31 - 594,53) = 664,31 \text{ kPa}$$

$$M_{1-1} = 664,31 \cdot 0,775 \cdot \frac{0,775}{2} + (707,31 - 664,31) \cdot \frac{0,775}{2} \cdot \frac{2}{3} \cdot 0,775$$

$$M_{1-1} = 208,1 \text{ kNm}$$

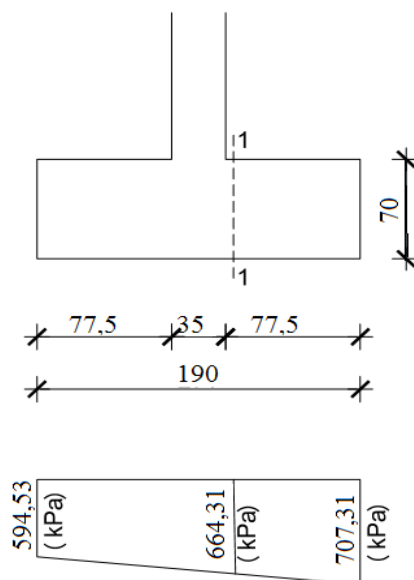

Slika 10.2. Naprezanje ispod temelja za kombinaciju 1

• 2. kombinacija

$$\sigma_{1-1} = 687,32 - \frac{0,775}{1,9} \cdot (687,32 - 614,21) = 657,55 \text{ kPa}$$

$$M_{1-1} = 657,55 \cdot 0,775 \cdot \frac{0,775}{2} + (687,32 - 657,55) \cdot \frac{0,775}{2} \cdot \frac{2}{3} \cdot 0,775$$

$$M_{1-1} = 203,43 \text{ kNm}$$

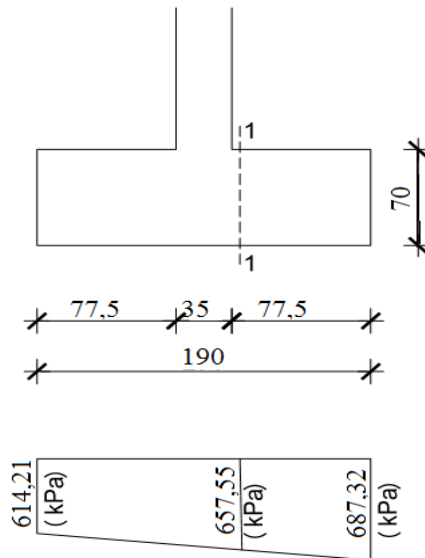

Slika 10.3. Naprezanje ispod temelja za kombinaciju 2

Mjerodavni moment za proračun armature:

$$M_{sd}^{1-1} = 208,1 \text{ kNm}$$

$$\text{Klasa betona: C30/37} \rightarrow f_{ck} = 30 \text{ MPa} \rightarrow f_{cd} = \frac{30}{1,5} = 20,0 \text{ MPa} = 2,0 \text{ kN/cm}^2$$

$$\text{Zadana armatura: B450BC} \rightarrow f_{yk} = 450 \text{ MPa} \rightarrow f_{yd} = \frac{450}{1,15} = 391,3 \text{ MPa} = 39,13 \text{ kN/cm}^2$$

$$\mu_{sd} = \frac{M_{ed}}{b \cdot d^2 \cdot f_{cd}} = \frac{208,1 \cdot 100}{100 \cdot 65^2 \cdot 2,0} = 0,024$$

$$\text{Očitano: } \varepsilon_{s1} = 10,0 \text{ ‰, } \varepsilon_{c2} = 0,8 \text{ ‰, } \xi = 0,074, \zeta = 0,974$$

$$A_{s1} = \frac{M_{ed,1-1}}{f_{yd} \cdot \zeta \cdot d} = \frac{208,1 \cdot 100}{39,13 \cdot 0,974 \cdot 65} = 8,40 \text{ cm}^2/\text{m}'$$

$$A_{s1} = \frac{8,40}{1,9} = 4,4 \left(\frac{\text{cm}^2}{\text{m}'} \right)$$

Odabrana armatura:

$$A_{s1, \text{potrebno}} = 4,4 \left(\frac{\text{cm}^2}{\text{m}'} \right)$$

U donju zonu temelja:

Odabrana armatura: mreža Q503 ($A_{s1} = 5,03 \text{ cm}^2/\text{m}$)

Konstruktivna armatura u gornjoj zoni: mreža Q226 ($A_{s1} = 2,26 \text{ cm}^2/\text{m}$)

11. PRILOZI

- 11.1. ARMATURA PLOČE POZICIJA 100- DONJA ZONA**
- 11.2. ARMATURA PLOČE POZICIJA 100- GORNJA ZONA**
- 11.3. ARMATURA PLOČE POZICIJA 200- DONJA ZONA**
- 11.4. ARMATURA PLOČE POZICIJA 200- GORNJA ZONA**
- 11.5. ARMATURNI PLAN GREDE POZICIJE 100**
- 11.6. ARMATURNI PLAN GREDE POZICIJE 200**
- 11.7. ARMATURNI PLAN STUBIŠTA**
- 11.8. ARMATURNI PLAN STUPA**

12. LITERATURA

Radnić J.,Harapin A. Osnove betonskih konstrukcija, interna skripta.
Fakultet građevinarstva arhitekture i geodezije Splitu, studeni 2013.

V. Herak Marović: Betonske konstrukcije 2, nastavni tekst (predavanja, vježbe)
<http://cigla.gradst.hr/moodle26/course/view.php?id=151>

V. Herak Marović: Betonske konstrukcije 1, nastavni tekst (predavanja, vježbe)
<http://cigla.gradst.hr/moodle26/course/view.php?id=150>

ARMATURA PLOČE POZICIJA 100 GORNJA ZONA MJ 1:100

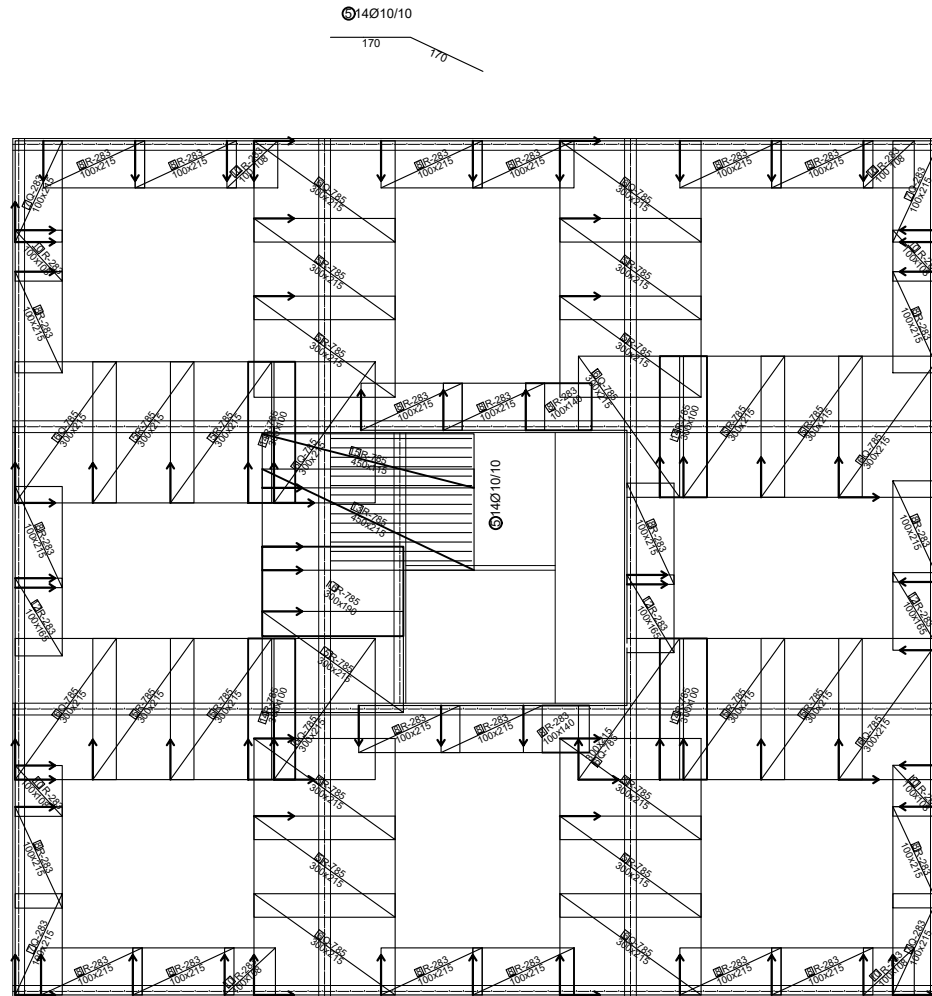

KLASA BETONA:
BETON C 30/37
ARMATURA B4508C
PREKLOP MREŽA ≥50 cm
ZAŠTITNI SLOJ C=3 cm

Mreže-specifikacija						
Pozicija	Oznaka mreže	B [cm]	L [cm]	n	Jedinična težina [kg/m ²]	Ukupna težina [kg]
POZICIJE 100 GORNJA ZONA						
5	R-785	215	300	17	7.35	805.93
6	Q-785	215	300	12	12.46	964.40
7	Q-283	215	100	4	4.48	38.53
8	R-283	215	100	22	2.77	131.02
9	R-283	140	100	2	2.77	7.80
10	R-283	108	100	8	2.77	23.93
12	R-283	165	100	3	2.77	13.70
13	R-785	215	450	1	7.35	71.11
14	R-785	100	300	4	7.35	88.20
15	R-785	115	450	1	7.35	38.00
16	R-785	190	300	1	7.35	41.90
Ukupno						2224.5

Šipke specifikacija							
ozn.	oblik i dimenzije [cm]	Ø	lg [m]	n [kom.]	lgn [m]	Jedinična-težina [kg/m ³]	Ukupna težina [kg]
POZICIJE 100 GORNJA ZONA							
5		10	3.40	14	47.60	0.79	37.60
Ukupna težina:							37.60

		SVEUČILIŠTE U SPLITU FAKULTET GRAĐEVINARSTVA, ARHITEKTURE I GEODEZIJE	UNIVERSITY OF SPLIT FACULTY OF CIVIL ENGINEERING, ARCHITECTURE AND GEODESY
ZAVRŠNI RAD			
IZRADIO		ŠIME DODIG	
AKADEMSKA GODINA 2016/2017		20.7.2017.	
ARMATURA POZ.100 GORNJA ZONA		M 1:100	

ARMATURA PLOČE POZICIJA 100 DONJA ZONA MJ 1:100

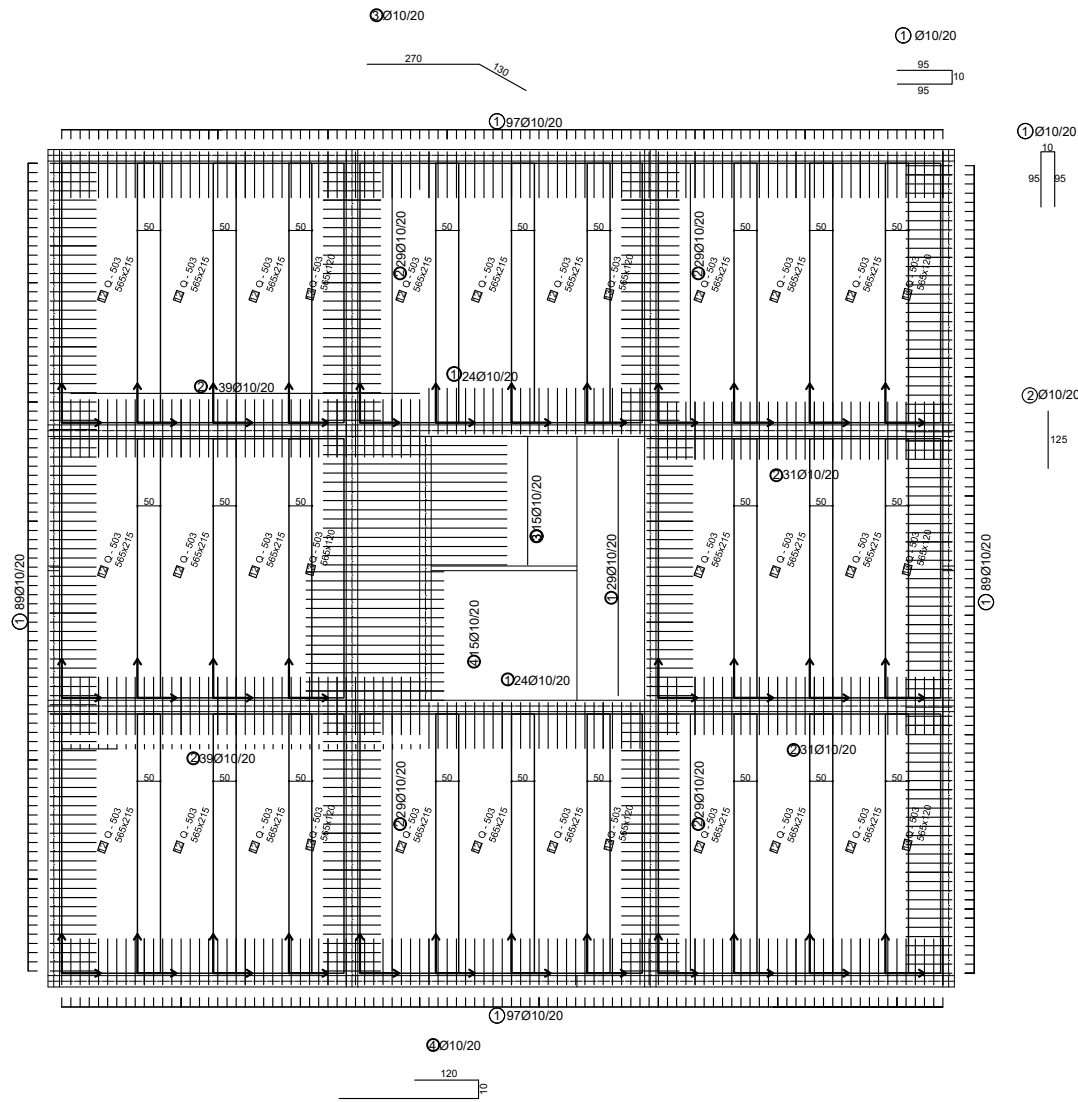

KLASA BETONA:
BETON C 30/37
ARMATURA B450BC
PREKLOP MREŽA ≥50 cm
ZAŠTITNI SLOJ C=3 cm

Mreže-specifikacija						
pozicija	Oznaka mreže	B [cm]	L [cm]	n	Jedinična težina [kg/m ²]	Ukupna težina [kg]
POZICIJE 100 DONJA ZONA						
12	Q-503	215	565	24	8.03	2341.00
13	Q-503	120	565	8	8.03	436.55
Ukupno						2777.55

Šipke specifikacija							
ozn.	oblik i dimenzije [cm]	Ø	lg [m]	n [kom.]	lgn [m]	Jedinična-težina [kg/m ³]	Ukupna težina [kg]
POZICIJE 100 DONJA ZONA							
1		10	2.00	449	898.00	0.79	709.42
2		10	1.25	256	320.00	0.79	252.80
3		10	4.00	15	60.00	0.79	47.40
4		10	4.00	15	60.00	0.79	47.40
Ukupna težina:							1057.02

SVEUČILIŠTE U SPLITU FAKULTET GRAĐEVINARSTVA, ARHITEKTURE I GEODEZIJE	
UNIVERSITY OF SPLIT FACULTY OF CIVIL ENGINEERING, ARCHITECTURE AND GEODESY	
ZAVRŠNI RAD	
IZRADIO	ŠIME DODIG
AKADEMSKA GODINA 2016/2017	20.7.2017.
ARMATURA POZ.100 DONJA ZONA	M 1:100

ARMATURA PLOČE POZICIJA 200 DONJA ZONA MJ 1:100

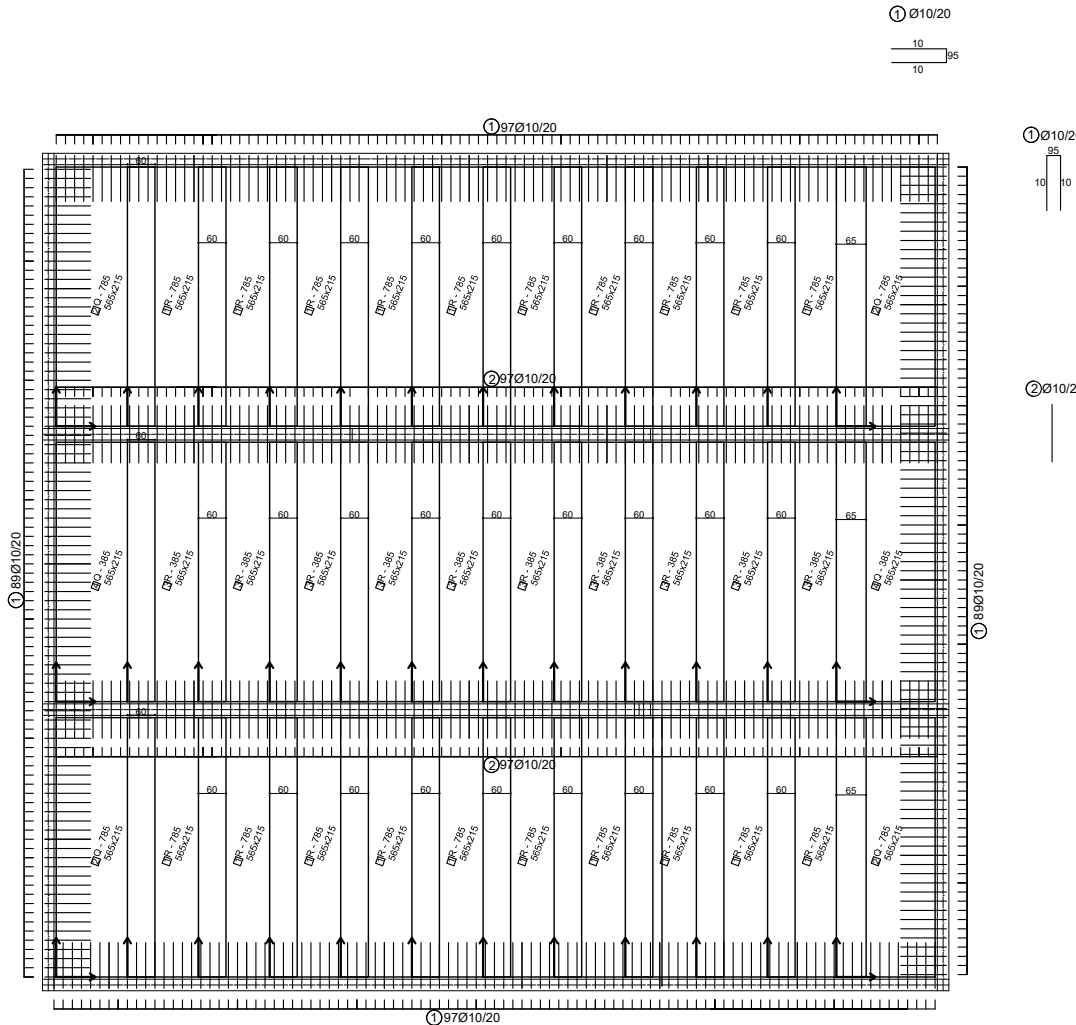

KLASA BETONA:
BETON C 30/37
ARMATURA B450BC
PREKLOP MREŽA ≥60 cm
ZAŠTITNI SLOJ C=3 cm

Mreže-specifikacija						
Pozicija	Oznaka mreže	B [cm]	L [cm]	n	Jedinična težina [kg/m ²]	Ukupna težina [kg]
POZICIJE 200 DONJA ZONA						
1	R-785	215	565	20	7.35	1760.78
2	Q-785	215	565	4	12.46	605.43
3	R-385	215	565	10	3.68	447.03
4	Q-385	215	565	2	6.10	148.20
Ukupno						2961.44

Šipke specifikacija						
ozn.	oblik i dimenzije [cm]	Ø	lg [m]	n [kom.]	lgn [m]	Jedinična-težina [kg/m ³] Ukupna težina [kg]
POZICIJE 200 DONJA ZONA						
1	95	10	2.00	372	744.00	0.79 587.80
2	125	10	1.25	194	242.50	0.79 191.58
Ukupna težina:						779.40

UCA		SVEUČILIŠTE U SPLITU FAKULTET GRAĐEVINARSTVA, ARHITEKTURA I GEODEZIJA	UNIVERSITY OF SPLIT FACULTY OF CIVIL ENGINEERING, ARCHITECTURE AND GEODESY
ZAVRŠNI RAD			
IZRADIO	ŠIME DODIG		
AKAEMSKA GODINA 2016/2017			20.7.2017.
ARMATURA POZ.200 DONJA ZONA			M 1:100

ARMATURA PLOČE POZICIJA 200 GORNJA ZONA
MJ 1:100

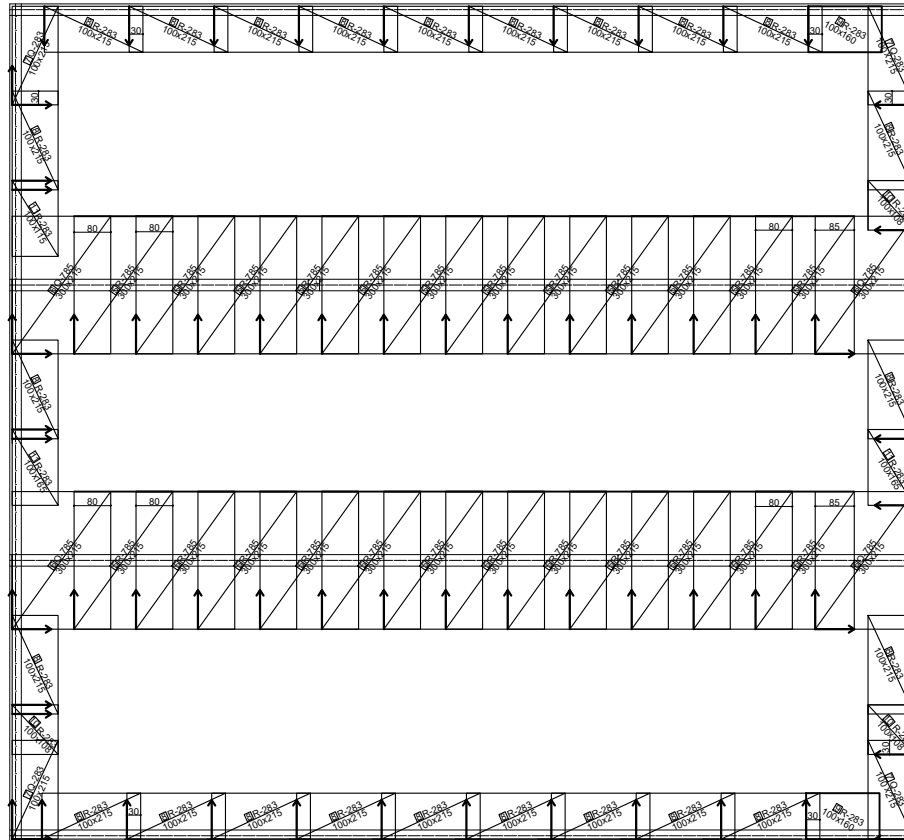

KLASA BETONA:
BETON C 30/37
ARMATURA B450BC
PREKLOP MREŽA ≥85 cm
ZAŠTITNI SLOJ C=3 cm

Mreže-specifikacija						
Pozicija	Oznaka mreže	B [cm]	L [cm]	n	Jedinična težina [kg/m ²]	Ukupna težina [kg]
POZICIJA 200 GORNJA ZONA						
5	R-785	215	300	24	7.38	1142.42
6	Q-785	215	300	4	12.46	325.08
7	Q-283	215	100	4	4.48	38.53
8	R-283	215	100	24	2.77	142.93
9	R-283	160	100	2	2.77	8.86
10	R-283	108	100	4	2.77	11.97
11	R-283	165	100	2	2.77	9.15
Ukupna težina:						1681.94

CA	SVEUČILIŠTE U SPLITU FAKULTET GRAĐEVINARSTVA, ARHITEKTURA I GEODEZIJA	UNIVERSITY OF SPLIT FACULTY OF CIVIL ENGINEERING, ARCHITECTURE AND GEODESY
	ZAVRŠNI RAD	
IZRADIO	ŠIME DODIG	
AKADEMSKA GODINA 2016/2017	20.7.2017.	
ARMATURA POZ.200 GORNJA ZONA	M 1:100	

ARMATURA GREDE POZICIJA 200 MJ 1:65

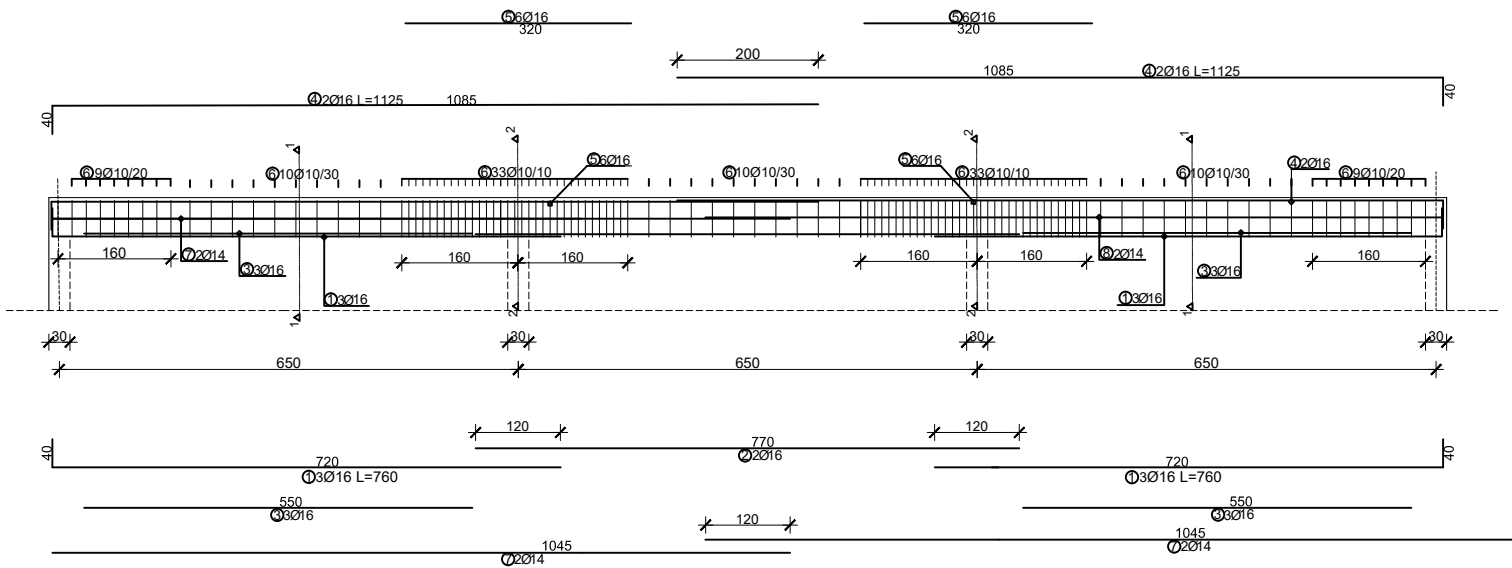

1-1
1:25

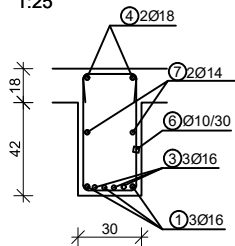

3-3
1:25

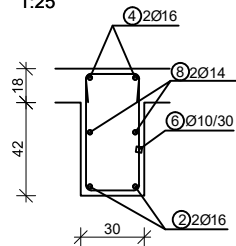

2-2
1:25

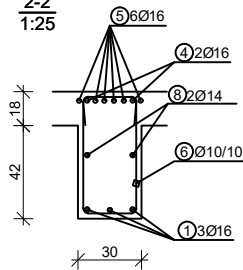

6Ø10/10/20/30 L=182 cm



Šipke specifikacija

ozn.	oblik i dimenzije [cm]	Ø	lg [m]	n [kom.]	lgn [m]	Jedinična-težina [kg/m³]	Ukupna težina [kg]
1	720	16	7.60	6	45.60	1.578	71.96
2	770	16	7.70	2	15.40	1.578	24.30
3	550	16	5.50	6	33.00	1.578	52.07
4	1085	16	11.25	4	45.00	1.578	70.01
5	320	16	3.20	12	38.40	1.578	60.60
6	55	10	1.82	114	207.48	0.617	128.02
7	1045	14	10.45	4	41.80	1.208	50.50

Ukupna težina: 457.50 [kg]

KLASA BETONA:
BETON C 30/37
ARMATURA B450BC
ZAŠTITNI SLOJ C=3 cm

UCA		SVEUČILIŠTE U SPLITU FAKULTET GRAĐEVINARSTVA, ARHITEKTURE I GEODEZIJE	UNIVERSITY OF SPLIT FACULTY OF CIVIL ENGINEERING, ARCHITECTURE AND GEODESY
ZAVRŠNI RAD			
IZRADIO		ŠIME DODIG	
AKADEMSKA GODINA 2016/2017		20.7.2017.	
ARMATURA GREDE POZ.200		M 1:65	

ARMATURA GREDE POZICIJA 100

MJ 1:65

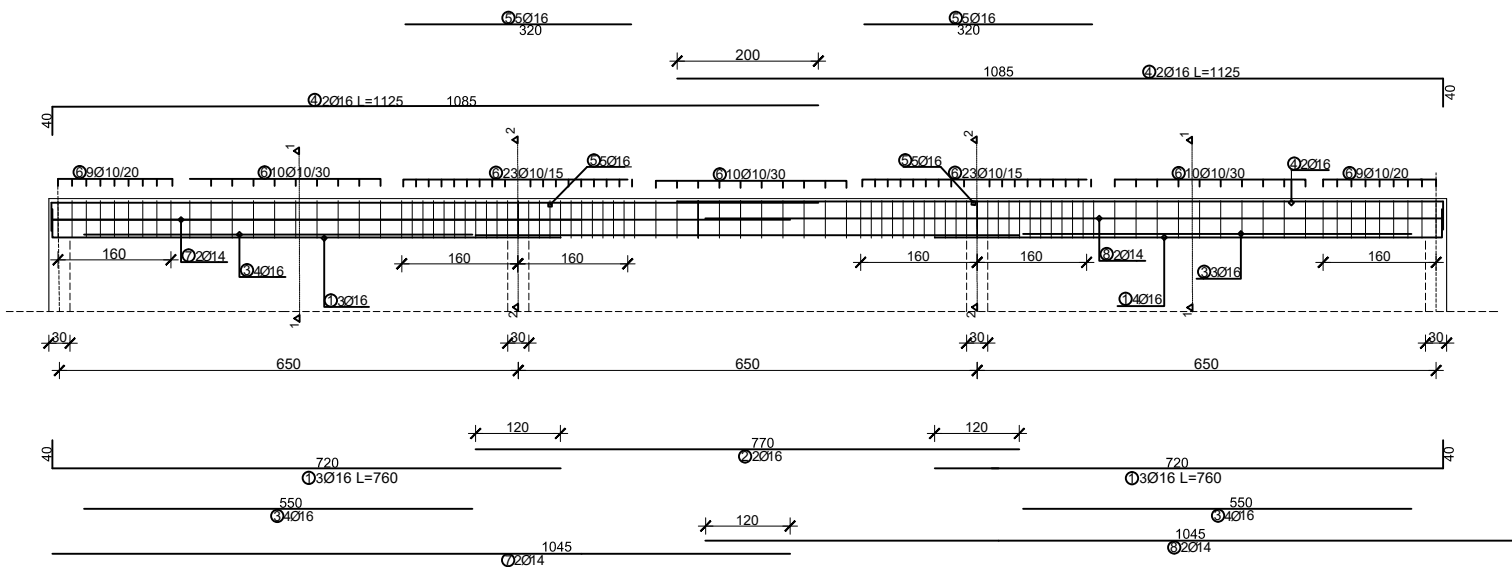

1-1
1:25

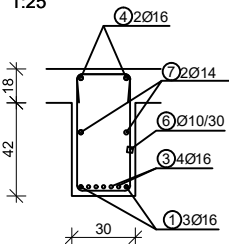

3-3
1:25

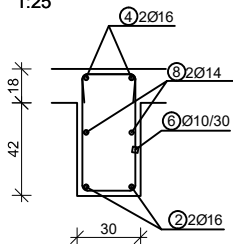

2-2
1:25

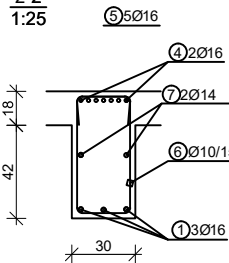

6-Ø10/15/20/30 L=182 cm

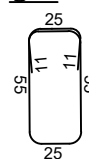

Šipke specifikacija

ozn.	oblik i dimenzije [cm]	Ø	lg [m]	n [kom.]	lgn [m]	Jedinična-težina [kg/m³]	Ukupna težina [kg]
1	40, 720	16	7.60	6	45.60	1.578	71.96
2	770	16	7.70	2	15.40	1.578	24.30
3	550	16	5.50	8	44.00	1.578	69.43
4	40, 1085	16	11.25	4	45.00	1.578	70.01
5	320	16	3.20	10	32.00	1.578	50.50
6	55, 25, 11, 11, 55	10	1.82	114	207.48	0.617	128.02
7	1045	14	10.45	4	41.80	1.208	50.50

KLASA BETONA:
BETON C 30/37
ARMATURA B450BC
ZAŠTITNI SLOJ C=3 cm

Ukupna težina: 464.72 [kg]

UCA		SVEUČILIŠTE U SPLITU FAKULTET GRAĐEVINARSTVA, ARHITEKTURA I GEODEZIJE	UNIVERSITY OF SPLIT FACULTY OF CIVIL ENGINEERING, ARCHITECTURE AND GEODESY
ZAVRŠNI RAD			
IZRADIO		ŠIME DODIG	
AKADEMSKA GODINA 2016/2017		20.7.2017.	
ARMATURA GREDE POZ.100		M 1:65	

UZDUŽNI PRESJEK KROZ STUBIŠTE

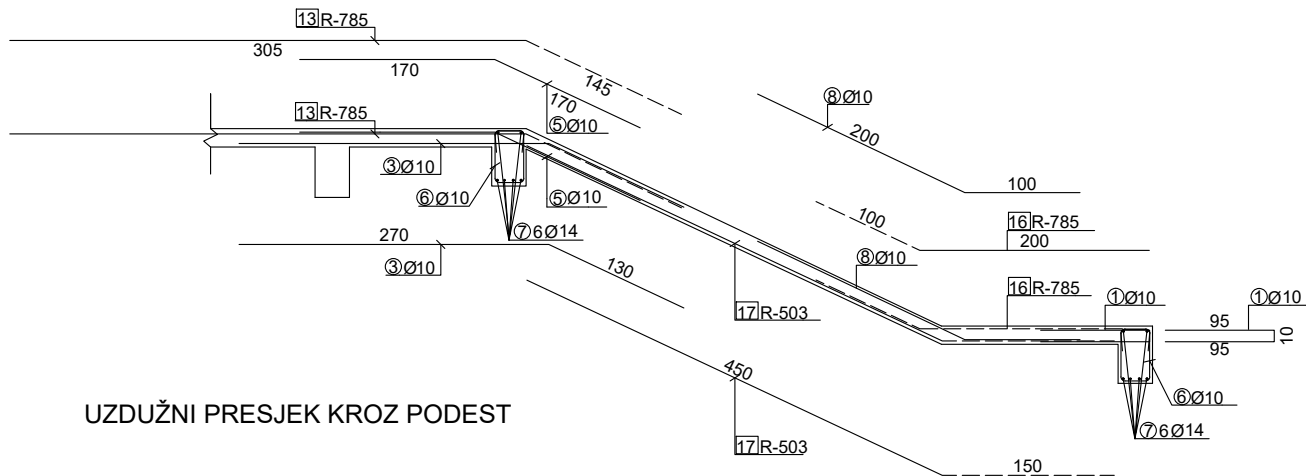

UZDUŽNI PRESJEK KROZ PODEST

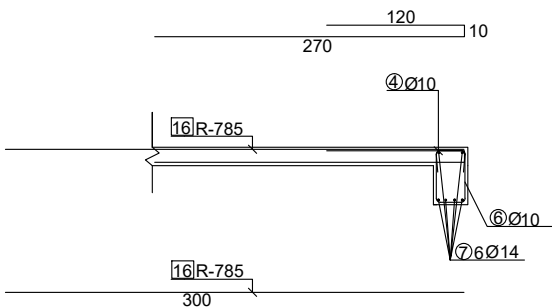

ARMATURA STUBIŠTA MJ 1:40

KLASA BETONA:
BETON C 30/37
ARMATURA B450BC
ZAŠTITNI SLOJ C=3 cm

Šipke specifikacija							
ozn.	oblik i dimenzije [cm]	Ø	lg [m]	n [kom.]	lgn [m]	Jedinična težina [kg/m³]	Ukupna težina [kg]
POZICIJE 100 GORNJA ZONA							
1		10	2.00	10	20.00	0.79	15.80
3		10	4.00	15	60.00	0.79	47.40
4		10	4.00	16	64.00	0.79	50.56
5		10	3.40	14	47.60	0.79	37.60
6		14	6.00	12	72.00	1.208	87.00
8		10	3.00	14	42.00	0.79	33.18
Ukupna težina:							271.54

Mreže-specifikacija						
Pozicija	Oznaka mreže	B [cm]	L [cm]	n	Jedinična težina [kg/m²]	Ukupna težina [kg]
ARMATURA STUBIŠTA						
13	R-785	215	450	1	7.35	71.11
15	R-785	115	450	1	7.35	38.00
16	R-785	215	300	2	7.35	94.82
17	R-503	215	600	1	4.89	63.00
18	R-503	115	600	1	4.89	38.74
Ukupno						300.67

UCA		SVEUČILIŠTE U SPLITU FAKULTET GRAĐEVINARSTVA, ARHITEKTURA I GEODEZIJA	UNIVERSITY OF SPLIT FACULTY OF CIVIL ENGINEERING, ARCHITECTURE AND GEODESY
ZAVRŠNI RAD			
IZRADIO		ŠIME DODIG	
AKADEMSKA GODINA 2016/2017		20.7.2017.	
ARMATURA STUBIŠTA		M 1:40	

ARMATURA STUPA KROZ 2 ETAŽE

MJ 1:40

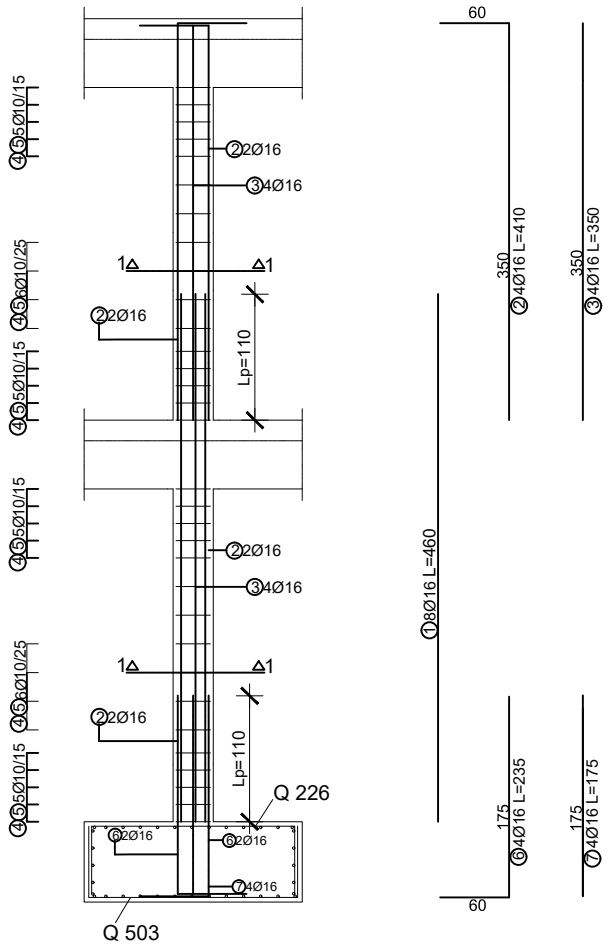

KLASA BETONA:
BETON C 30/37
ARMATURA B450BC
ZAŠTITNI SLOJ C=3 cm

Šipke specifikacija							
ozn.	oblik i dimenzije [cm]	Ø	lg [m]	n [kom.]	lgn [m]	Jedinična-težina [kg/m]	Ukupna težina [kg]
STUP 2.ETAŽA							
1	460	16	4.60	8	36.80	1.578	58.07
2	350	16	4.10	4	16.40	1.578	25.88
3	350	16	3.50	4	14.00	1.578	22.09
4		10	1.4	32	44.80	0.79	35.40
5		10	1.04	32	33.30	0.79	26.31
6	175	16	2.35	4	9.40	1.578	14.83
7	175	16	1.75	4	7.00	1.578	11.05
Ukupna težina:						193.63 [kg]	

MJ 1:20

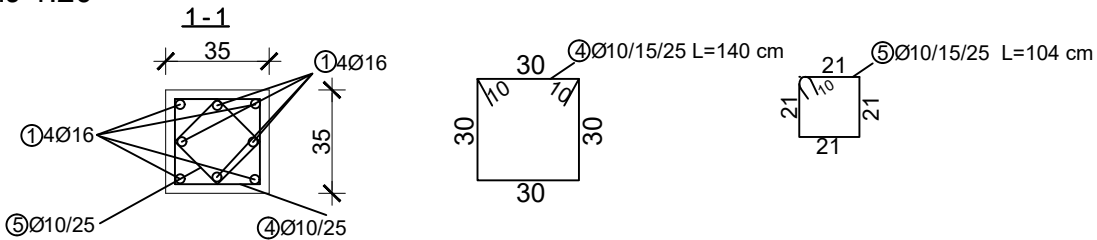

UCA		SVEUČILIŠTE U SPLITU FAKULTET GRAĐEVINARSTVA, ARHITEKTURA I GEODEZIJA	UNIVERSITY OF SPLIT FACULTY OF CIVIL ENGINEERING, ARCHITECTURE AND GEODESY
ZAVRŠNI RAD			
IZRADIO	ŠIME DODIG		
AKADEMSKA GODINA 2016/2017		20.7.2017.	
ARMATURA STUPA KROZ 2 ETAŽE		M 1:40	