

Idejni projekt lokalne ceste

Đikić, Ilija

Undergraduate thesis / Završni rad

2017

Degree Grantor / Ustanova koja je dodijelila akademski / stručni stupanj:

University of Split, Faculty of Civil Engineering, Architecture and Geodesy / Sveučilište u Splitu, Fakultet građevinarstva, arhitekture i geodezije

Permanent link / Trajna poveznica: <https://um.nsk.hr/um:nbn:hr:123:060211>

Rights / Prava: [In copyright](#)/[Zaštićeno autorskim pravom.](#)

Download date / Datum preuzimanja: **2025-02-20**



Repository / Repozitorij:

[FCEAG Repository - Repository of the Faculty of Civil Engineering, Architecture and Geodesy, University of Split](#)



UNIVERSITY OF SPLIT



**SVEUČILIŠTE U SPLITU
FAKULTET GRAĐEVINARSTVA, ARHITEKTURE I GEODEZIJE**

ZAVRŠNI RAD

Ilija Đikić

Split, 2017. godina

**SVEUČILIŠTE U SPLITU
FAKULTET GRAĐEVINARSTVA, ARHITEKTURE I GEODEZIJE**

Ilija Đikić

IDEJNI PROJEKT LOKALNE CESTE

Završni rad

Split, 2017. godina

**SVEUČILIŠTE U SPLITU
FAKULTET GRAĐEVINARSTVA, ARHITEKTURE I GEODEZIJE**

Split, Matice hrvatske 15

STUDIJ: **STRUČNI STUDIJ GRAĐEVINARSTVA**
KANDIDAT: **Ilija Đikić**
BROJ INDEKSA: **1645**
KATEDRA: **Katedra za prometnice**
PREDMET: **Ceste**

ZADATAK ZA ZAVRŠNI RAD

Tema: IDEJNI PROJEKT LOKALNE CESTE

Opis zadatka: Uz pomoć programa za projektiranje cesta CADICS potrebno je izraditi idejni projekt ceste na geodetskoj podlozi koja je korištena za izradu programa u okviru predmeta Ceste. Trasu treba položiti od točke A do točke B prema svim podacima iz programskog zadatka.

Zadatak treba sadržavati:

1. Kopiju programskog zadatka
2. Tehnički opis s prikazom korištenja programa CADICS
3. Građevinsku situaciju u MJ. 1:1000
4. Uzdužni presjek u MJ. 1:1000/100
5. Normalni poprečni presjek MJ. 1:50
6. Karakteristične poprečne presjeke u MJ. 1:100
7. Aproksimativni troškovnik
8. Računalne ispise horizontalnog i vertikalnog toka trase
9. Računalne ispise kota kolnika

U Splitu, ožujak 2017.

Voditelj Završnog rada:
Izv.prof.dr.sc. Deana Breški

Idejni projekt lokalne ceste

Sažetak:

Uz pomoć programa za projektiranje cesta CADICS izrađen je idejni projekt lokalne ceste na geodetskoj podlozi prema zadatku iz kolegija Ceste. Cesta je projektirana za prosječni godišnji dnevni promet (PGDP) od 950 vozila na dan, na brdovitom terenu. Projektna brzina ceste iznosi 30km/h. Idejni projekt izrađen je prema Pravilniku o osnovnim uvjetima za projektiranje ceste sa elementima koji zadovoljavaju važeće propise, kao i sigurnosne i estetske kriterije.

Ključne riječi:

idejni projekt, lokalna cesta, geodetska podloga, projektna brzina, os ceste, poprečni presjek, uzdužni presjek

Preliminary design of local road

Abstract:

A preliminary design of local road, on a geodetic basis according to the task from course „Roads“, is made using software for designing roads, CADICS. The road is designed for the annual average daily traffic (AADT) of 950 vehicles per day, on the hilly terrain. Design speed for the road is 30 km/h. Preliminary design of local road was created according to the Regulations on the basic conditions for the design of public roads with the elements that meet the applicable rules, as well as safety and aesthetic criteria.

Keywords:

preliminary design, local road, geodetic basis, design speed, the road axis, cross-section, longitudinal section

SADRŽAJ

0. KOPIJA PROGRAMSKOG ZADATKA

1. TEHNIČKI OPIS	1
2. GRAĐEVINSKA SITUACIJA M 1:1000	5
3. UZDUŽNI PRESJEK M 1:1000/100	6
4. NORMALNI POPREČNI PRESJEK M 1:50	7
5. KARAKTERISTIČNI POPREČNI PRESJECI M 1:100	8
5.1. KARAKTERISTIČNI POPREČNI PRESJECI 1-4	
5.2. KARAKTERISTIČNI POPREČNI PRESJECI 5-7	
5.3. KARAKTERISTIČNI POPREČNI PRESJECI 8-10	
5.4. KARAKTERISTIČNI POPREČNI PRESJECI 11-14	
5.5. KARAKTERISTIČNI POPREČNI PRESJECI 15-18	
6. OBRADA NA RAČUNALU	9
7. RAČUNALNI ISPIS HORIZONTALNOG TOKA TRASE m	11
8. RAČUNALNI ISPIS VERTIKALNOG TOKA TRASE	13
9. RAČUNALNI ISPIS KOTA KOLNIKA	15
10. RAČUNALNI ISPIS VOLUMENA	37
11. APROKSIMATIVNI TROŠKOVNIK	43
12. LITERATURA	52

1. TEHNIČKI OPIS

1. TEHNIČKI OPIS

OPĆI PODACI:

Na geodetskoj podlozi izrađen je idejni projekt ceste s početkom u točki A (240.00 m.n.m) i njenim krajem u točki B (225.00 m.n.m). Trasa se nalazi na brdovitom području, njena duljina iznosi 488.14 m i ima smjer rasta stacionaže od istoka prema zapadu. Sastoji se od 2 krivine, različitog radijusa i duljine prijelaznice, i 3 pravca.

Za izradu idejnog projekta korištena je geodetska podloga M 1:1000 odnosno prilog iz programa kolegija Ceste. Situacija je priložena u M 1:1000.

TEHNIČKI ELEMENTI IZGRADNJE :

Opis trase:

Na priloženoj geodetskoj podlozi u mjerilu 1:1000 izrađen je idejni projekt ceste na dionici od točke A (240.00 m n.m) na stacionaži 0+000,00, do točke B (225.00 m n.m.) na stacionaži 0+488,14. Cesta je projektirana za prosječni godišnji dnevni promet od 950 vozila na dan i to na brdskom terenu. Na prostorno vođenje prometnice utječu topografske karakteristike terena.

Temeljem «Pravilnika o osnovnim uvjetima kojima javne ceste izvan naselja i njihovi elementi moraju udovoljavati sa stajališta sigurnosti prometa», definirani su projektni elementi trase i elementi poprečnog profila.

U tablici 1.2, koja je sastavni dio Pravilnika, dani su elementi za definiciju kategorije prometnice.

Tablica 1.2

Kategorija ceste	Društ. gospod. značenje (1.1.1.)	Vrsta prometa (1.1.2.)	Veličina prometa (1.1.3.)	Zadaća povezivanja (1.1.4.)	Srednja duljina putovanja (km)
AC	Državna	Prom. mot. vozila	>14000	Međudržavno i državno	>100
1. kat.	Državna	Prom. mot. vozila	>12000	Međudržavno i državno-regionalno	50-100
2. kat.	Državna	Prom. mot. v. mješoviti prom.	7000-12000	Državno i županijsko	20-50
3. kat.	Državna; županijska	Mješoviti promet	3000-7000	Međuopćinsko	5-50
4. kat.	Županijska; lokalna	Mješoviti promet	1000-3000	Općinsko	5-20
5. kat.	Lokalna	Mješoviti promet	<1000	Općinsko-lokalno	<5

U pravilu se usvaja najviša kategorija ceste koja se dobije primjenom kriterija iz tablice 1.2. Predmetna cesta je lokalnog značaja s PGDP-om od 950 voz/dan što je svrstava u 5. kategoriju.

Prema tablici 1.3.1 iz Pravilnika, ceste 5. kategorije projektiraju se za projektne brzine 30-60 km/h ovisno o terenskim ograničenjima.

Tablica 1.3.1. Projektne brzine i najveći nagibi nivelete

PROMETNO -TEHNIČKO RAZVRSTAVANJE		PROJEKTNA BRZINA V_p (km/h) / NAGIB s_{max} (%)							
KAT.	Razina usluge	120	100	90	80	70	60	50	40
		a.	b.	c.	d.	e.	f.	g.	h.
AC	C/D	$\geq 120/4^\circ$	100/5*	90/5.5**	80/6***				
1. kat.	D		100/5.5°	90/5.5*	80/6**	70/7***			
2. kat.	D		100/5.5°	90/5.5*	80/6*	70/7**	60/8***		
3. kat.	E				80/7°	70/7*	60/8**	50/9***	
4. kat.	E					70/8°	60/9*	50/10**	40/11***
5. kat.	E						60/10°	50/11*	40/12** 40(30)/12***

OZNAKE: ° BEZ OGRANIČENJA BO
 * UMJERENA OGRANIČENJA UO
 ** ZNATNA OGRANIČENJA ZO
 *** VELIKA OGRANIČENJA VO

Vrijednost u zagradi primjenjuje se iznimno.

Obzirom da se radi o brdovitom terenu sa znatnim ograničenjima za predmetnu prometnicu prema navedenoj tablici, projektna brzina je 30km/h i maksimalni uzdužni nagib je 12%.

Iz odabrane projektne brzine proizlaze i projektni elementi horizontalne i vertikalne geometrije trase:

- minimalni radijus horizontalne krivine R= 25 m
- minimalna duljina klotoidne prelazne krivine L= 25 m
- maksimalni uzdužni nagib i= 12,0 %
- minimalni polumjer konveksnog zaobljenja nivelete (za 0%) R=130 m

Tlocrtni elementi trase:

Trasa ceste se sastoji od tri pravca i dvije krivine, od kojih je jedna lijeva i jedna desne. Krivina s početkom na stacionaži 0+216.51 m ima radijus R= 30 m i duljinu prijelaznice L=30 m, krivina s početkom na stacionaži 0+370.29 m ima radijus R= 70 m i duljinu prijelazne krivine L=40 m. Prvi pravac počinje na stacionaži 0+000,00 m s krajem u stacionaži 0+216.51 m te njegova duljina iznosi 216,51 m, drugi pravac počinje na stacionaži 0+307.62 s krajem u stacionaži 0+370.29 te njegova duljina iznosi 62,67 m dok treći pravac počinje na stacionaži 0+481.43 s krajem u stacionaži 0+488.14 te njegova duljina iznosi 6.71m . Krivine su konstruirane pomoću dvije prijelazne krivine klotoidnog oblika i kružnog luka.

Vertikalni elementi trase:

Vertikalni tok trase sastoji se od dva pravca koji imaju sjecište na stacionaži 0+339,06 m i jedne konkavne krivine, radijus krivine je $R=1500$ m i pripadajuća tangenta je duljine 41,017m. Uzdužni nagibi prvog pravca nivelete iznosi 4,54 %, a drugog 0,93%.

Elementi poprečnog profila:

Prometnica je projektirana za dvosmjerni promet. Ima dvije vozne trake odnosno po jednu za svaki smjer. Širina voznog traka poprečnog presjeka iznosi 2,75 m s dodatkom rubnog traka u širini od 0,2 m. Ukupna širina poprečnog presjeka iznosi 8,00 m s bankinama uzdužnog nagiba 4% prema pokosu nasipa i širini od 1,00 m, bermi širine 0,60 m kao i rigola također širine 0,50 m. Rigoli sa drenažama, koja je postavljena na glinenu posteljice, se izvode na usjecima kao element za odvodnju vode.

Poprečni nagib ceste u pravcu iznosi 2.5%, a u zavojima u ovisnosti od polumjera kružnog luka i usvojene računске brzine, $V_r = 30$ km/h . Za radijus $R=30$ m poprečni nagib iznosi 6,2%, za radijus $R=70$ m poprečni nagib iznosi 3,4 %.

Primjenjeni nagibi pokosa usjeka su 2:1, a nasipa 1:1.5 .

Kolnička konstrukcija:

Predviđen je elastični tip kolničke konstrukcije s asfaltbetonskim kolničkim zastorom u slojevima:

- I. habajući sloj asfaltbetona AB11 4.00 cm
- II. bitumenizirani nosivi sloj BNS 22s.....8.00 cm
- III. nosivi sloj od mehanički stabiliziranog drobljenog kamenog materijala..... 30.00 cm

UKUPNO.... 42.00 cm

(potrebni modul stišljivosti mjeren kružnom pločom $\varnothing 30$. modul stišljivosti $M_s \geq 100$ MN/m², a stupanj zbijenosti $S_z \geq 100\%$)

Odvodnja:

Odvodnja vode s prometnice odnosno kolnika i vode koja se slijeva niz usjek vrši se pomoću betonskih rigola, te se voda usmjerava prema njima uzdužnim i poprečnim nagibima. Dio vode preljeva se preko bankina niz nasip.

Oprema ceste:

Idejnim rješenjem predviđena je horizontalna signalizacija koja se sastoji od jedne pune razdjelne crte širine 10 cm koja se postavlja u osi prometnice i punih rubnih crta širine 10 cm koje se postavljaju na svaki od rubnih trakova.

Na bankinama nasipa visine $h > 3,00$ m je predviđeno postavljanje jednostrane zaštitne ograde.

**2. GRAĐEVINSKA SITUACIJA
MJ 1:1000**

HORIZONTALNI TOK TRASE MJ 1:1000

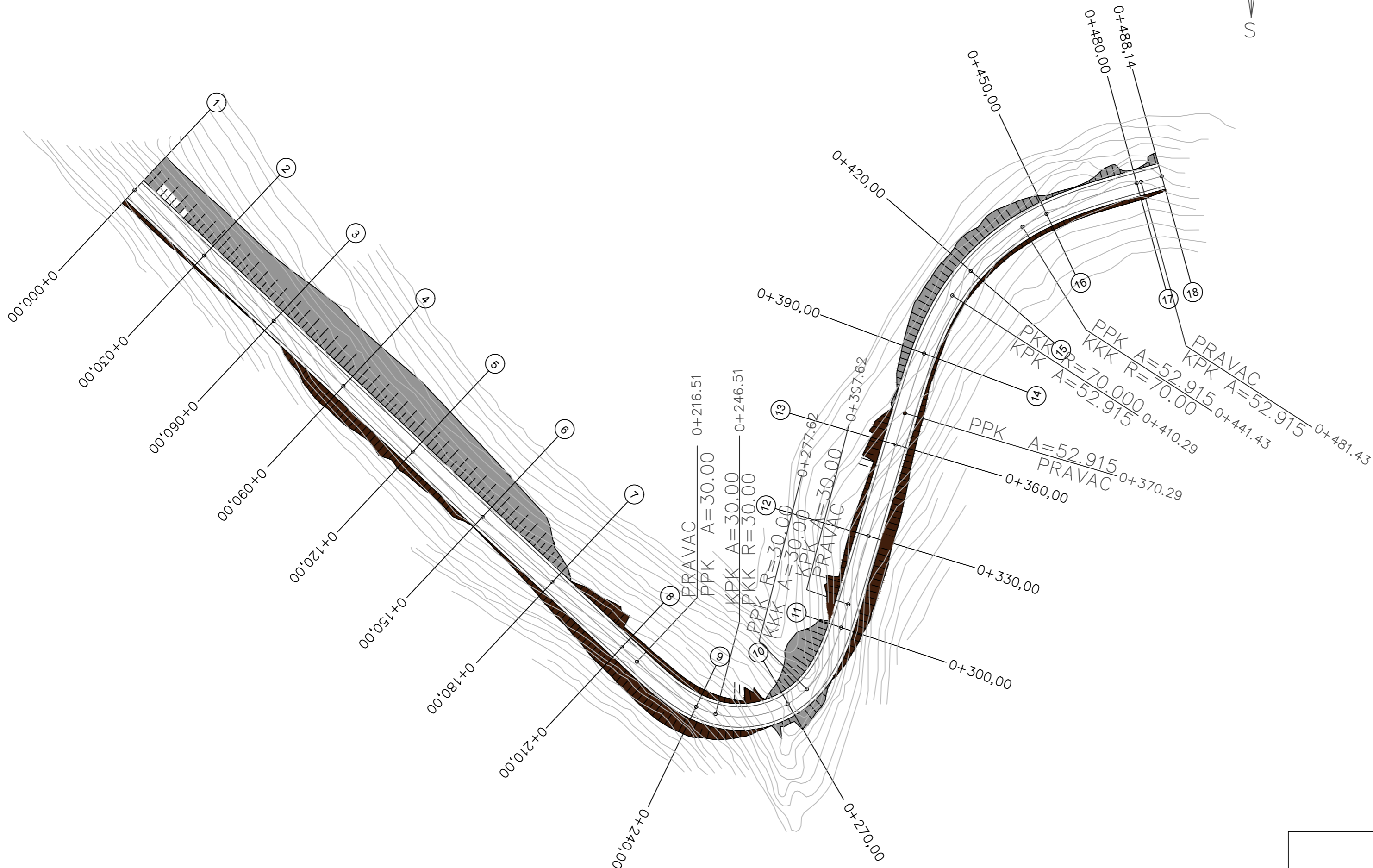
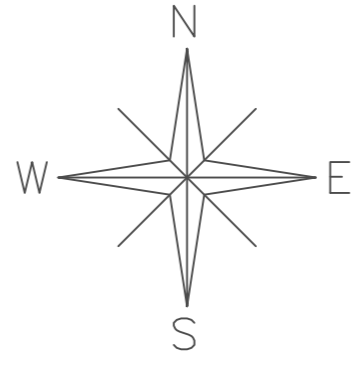

Fakultet građevinarstva, arhitekture i geodezije Sveučilišta u Splitu 	PREDMET:	ZAVRŠNI RAD - CESTE	PRILOG BROJ 2
	ZADATAK:	IDEJNI PROJEKT LOKALNE CESTE	
	SADRŽAJ:	GRAĐEVINSKA SITUACIJA	DATUM: OŽUJAK / 2017.
	IZRADIO:	ILUJA ĐIKIĆ	MJERILO: 1:1000
MENTOR:	Izv.prof. dr. sc. DEANA BREŠKI		

3. UZDUŽNI PRESJEK MJ 1:1000/100

UZDUŽNI PRESJEK M 1:1000/100

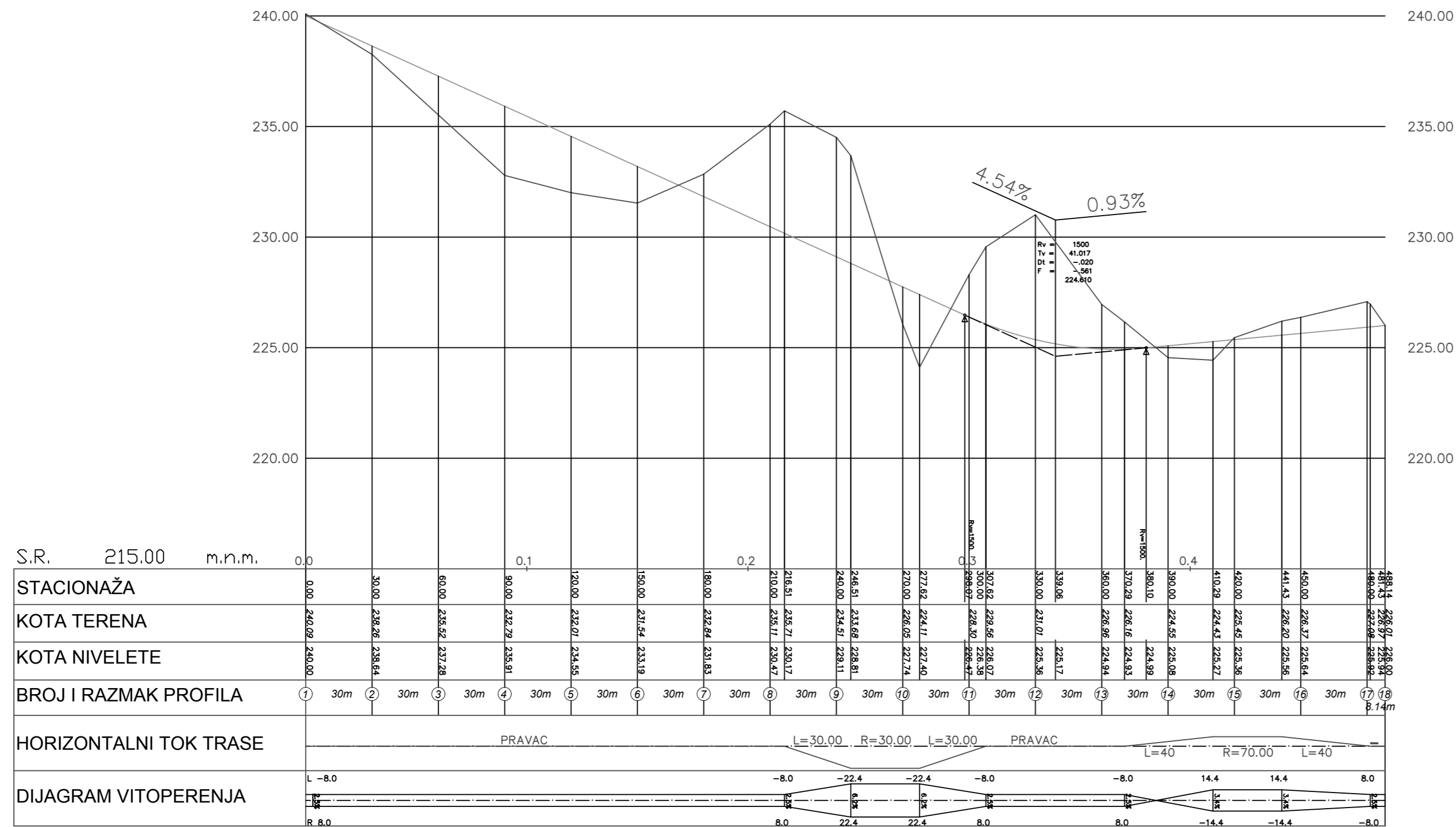

	PREMET:	ZAVRŠNI RAD - CESTE	PRILOG BROJ 3
	ZADATK:	IDEJNI PROJEKT LOKALNE CESTE	DATUM:
	SAOBUĐAJ:	UZDUŽNI PRESJEK	ODLUK/2017.
	IZRAĐIO:	ILUA BIKIĆ	MERLO
MENTOR:	izv.prof.dr.sc. DEJANA BREŠKI	1:1000/100	

4. NORMALNI POPREČNI PRESJEK MJ 1:50

5. KARAKTERISTIČNI POPREČNI PRESJECI MJ 1:100

5.1. POPREČNI PRESJECI 1-4
M 1:100

PROFIL 1
ST. 0+000.00
K.N. 240.00
K.T. 240.00

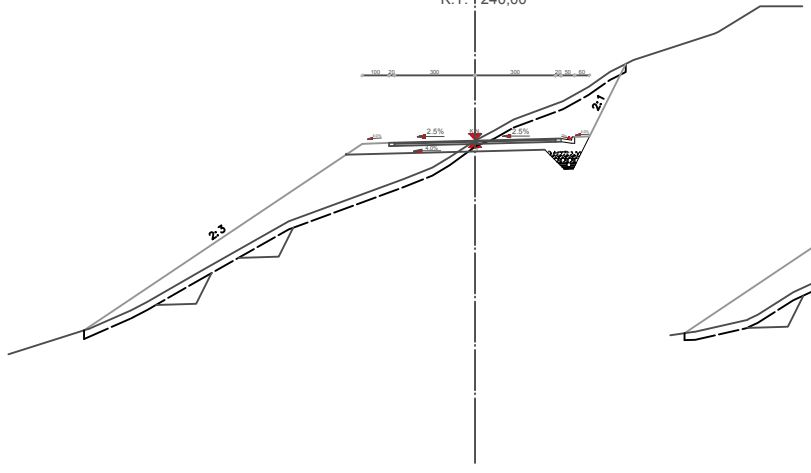

PROFIL 2
ST. 0+030.00
K.N. 238.64
K.T. 238.26

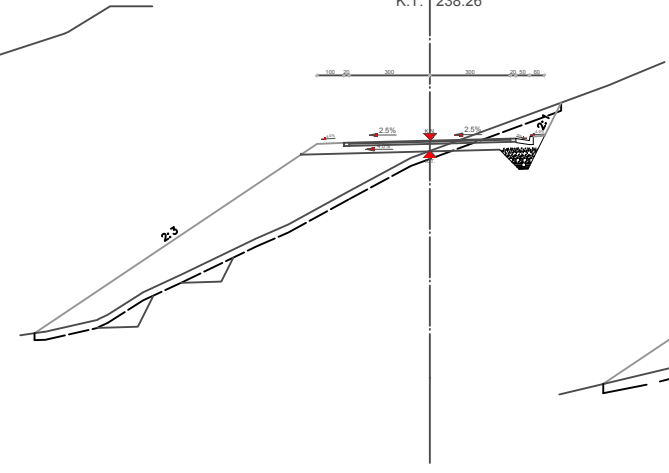

PROFIL 3
ST. 0+060.00
K.N. 237.28
K.T. 235.52

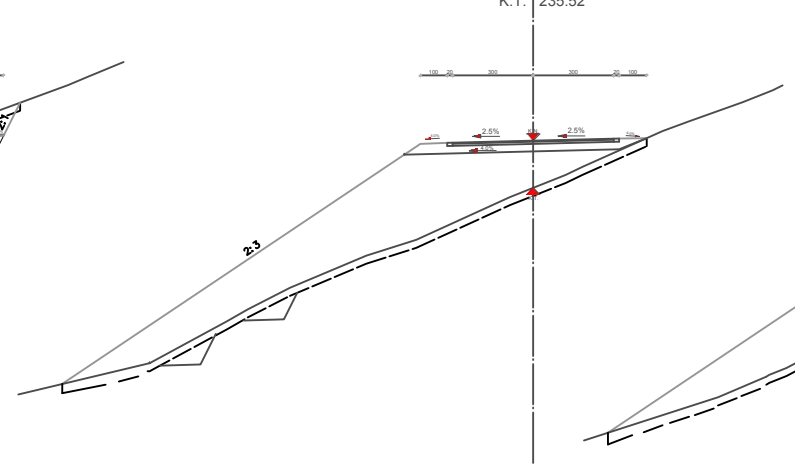

PROFIL 4
ST. 0+090.00
K.N. 235.91
K.T. 232.79

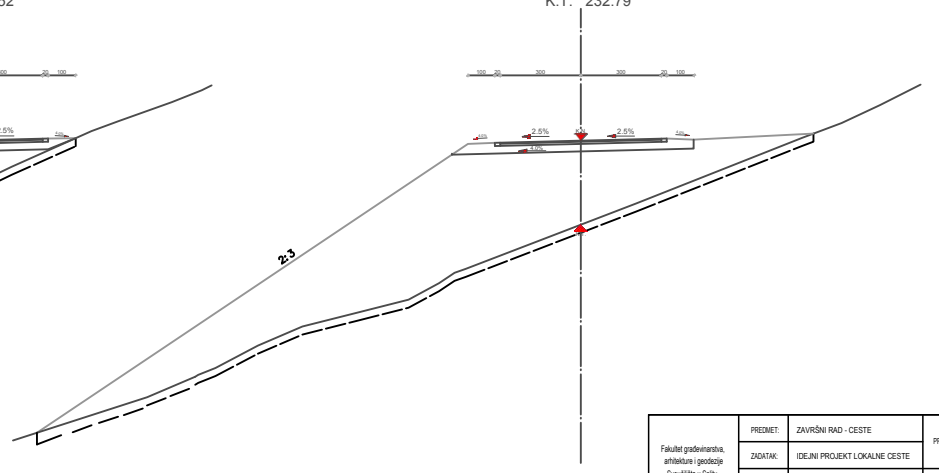

Fakultet građevinarstva, arhitekture i geodazije Sveučilište u Splitu 	PREDMET:	ZAVRŠNI RAD - CESTE	PRILOG BR. 1.1
	ZNATAK:	IDEJNI PROJEKT LOKALNE CESTE	DATA:
	SADRŽAJ:	POPREČNI PRESJECI (1-4)	OBIM:
	ODRADIO:	ELIJA ERIC	NUMERLO:
	MENTOR:	izr. prof. dr. sc. DEJANA BREŠČIĆ	

5.2. POPREČNI PRESJECI 5-7
M 1:100

PROFIL 5
ST. 0+120.00
K.N. 234.55
K.T. 232.01

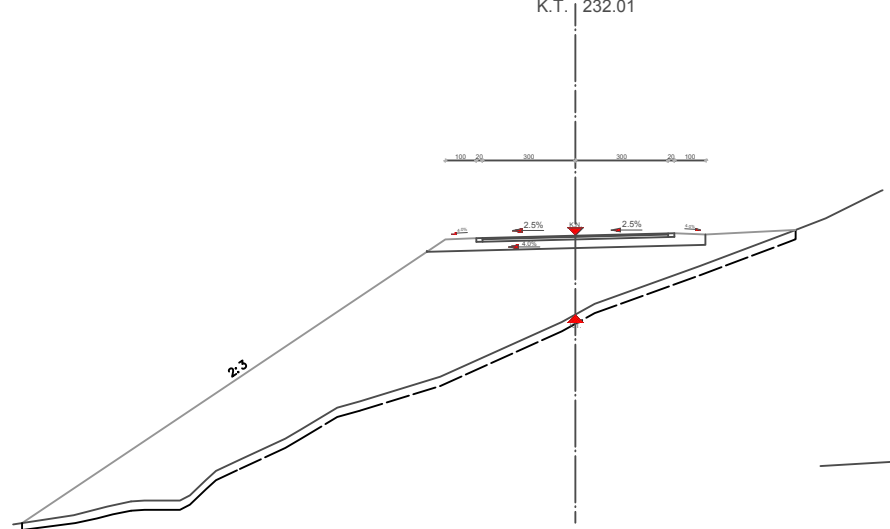

PROFIL 6
ST. 0+150.00
K.N. 233.19
K.T. 231.54

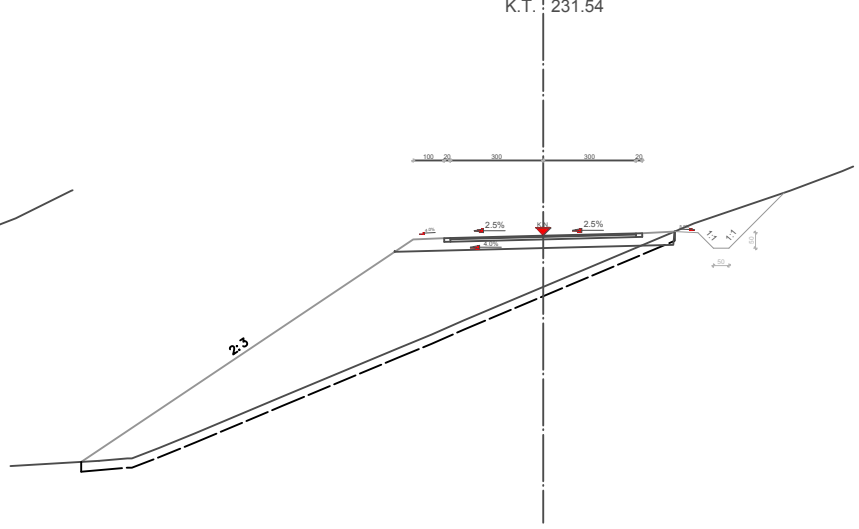

PROFIL 7
ST. 0+180.00
K.N. 231.83
K.T. 232.84

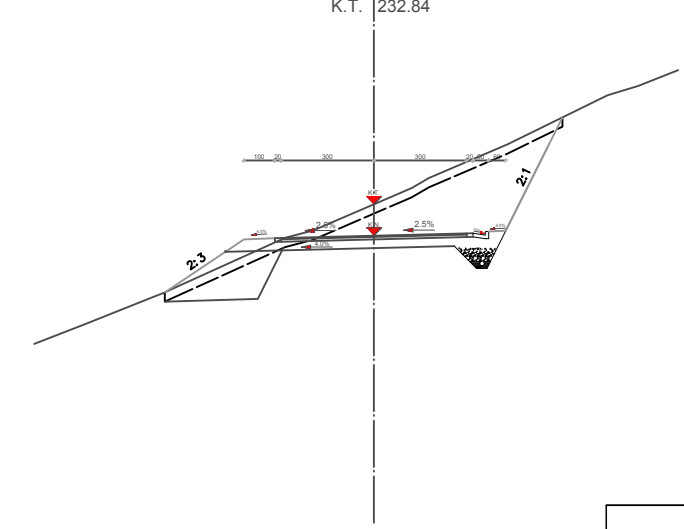

Fakultet građevinarstva, arhitekture i geodije Sveučilište u Splitu 	PREMET:	ZAVRŠNI RAD - CESTE	PRLOG BROJ 52
	ZADATAK:	IDEJNI PROJEKT LOKALNE CESTE	
	SADRŽAJ:	POPREČNI PRESJECI (5-7)	DATA:
	IZRAĐIO:	ILUA ERKIĆ	OŽUJAK 2017.
	MENTOR:	Izv.prof.dr.sc. DEJANA BREŠKI	MERLO: 1:100

PROFIL 8
ST. 0+210.00
K.N. 230.47
K.T. 235.11

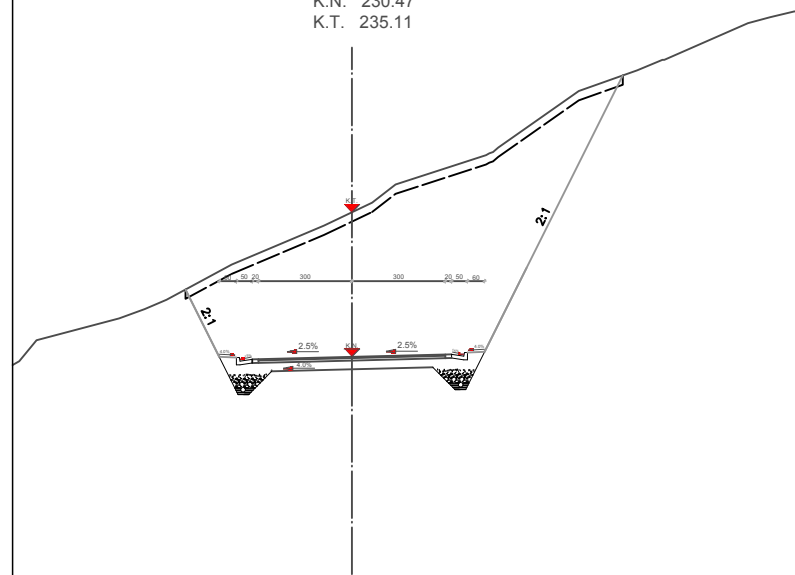

PROFIL 9
ST. 0+240.00
K.N. 229.11
K.T. 234.51

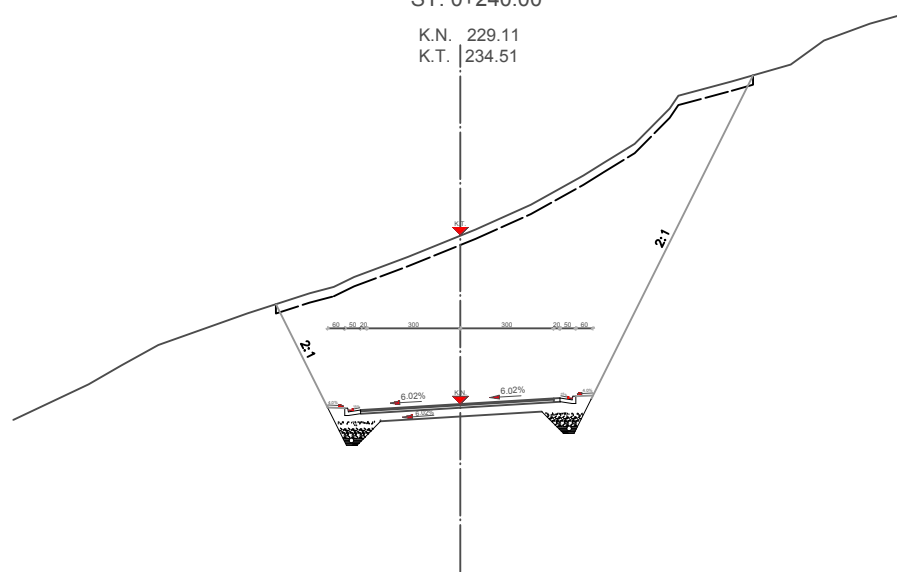

PROFIL 10
ST. 0+270.00
K.N. 227.74
K.T. 226.05

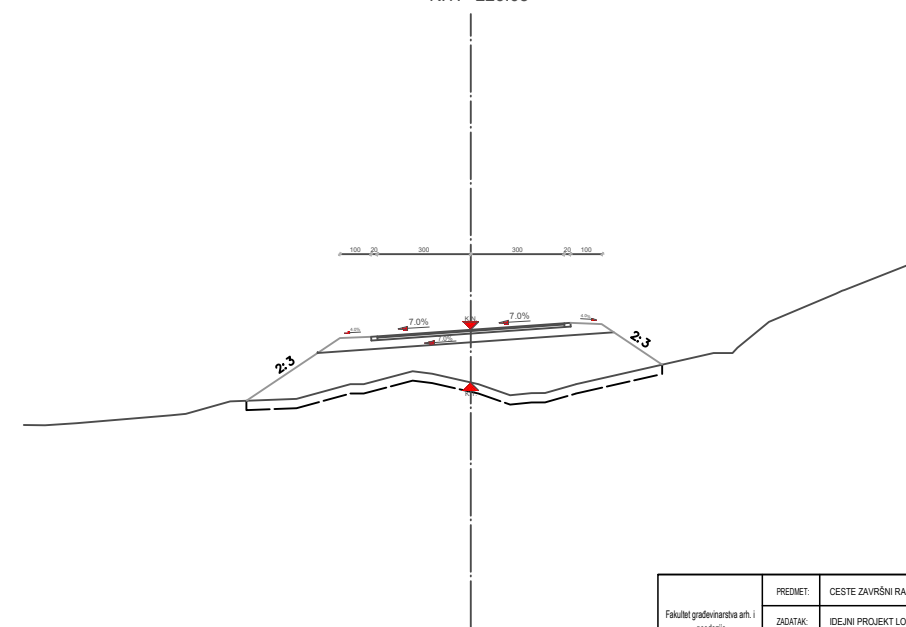

5.3. POPREČNI PRESJECI 8-10
M 1:100

Fakultet građevinarstva arh. i geodije Sveučilište u Splitu 	PREDMET:	CESTE ZAVRŠNI RAD	PRILOG BROJ 3
	ZADATAK:	IDEJNI PROJEKT LOKALNE CESTE	
	SADRŽAJ:	POPREČNI PRESJECI (8-10)	DATUM: OŽUJAK / 2017
	ISKICO:	ILIJIA BIKIĆ	MERLO 1:100
MENTOR:	Izv.prof. dr. sc. DEJANA BREŠKI		

5.4. POPREČNI PRESJECI 11-14
M 1:100

PROFIL 11
ST. 0+300.00

K.N. 226.38
K.T. 228.30

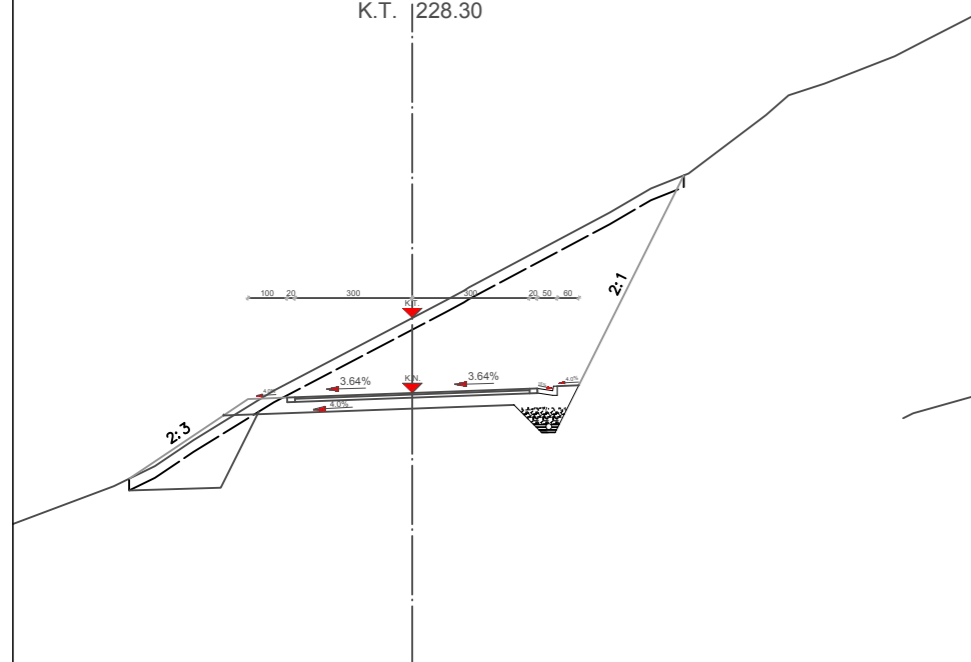

PROFIL 12
ST. 0+330.00

K.N. 225.36
K.T. 231.01

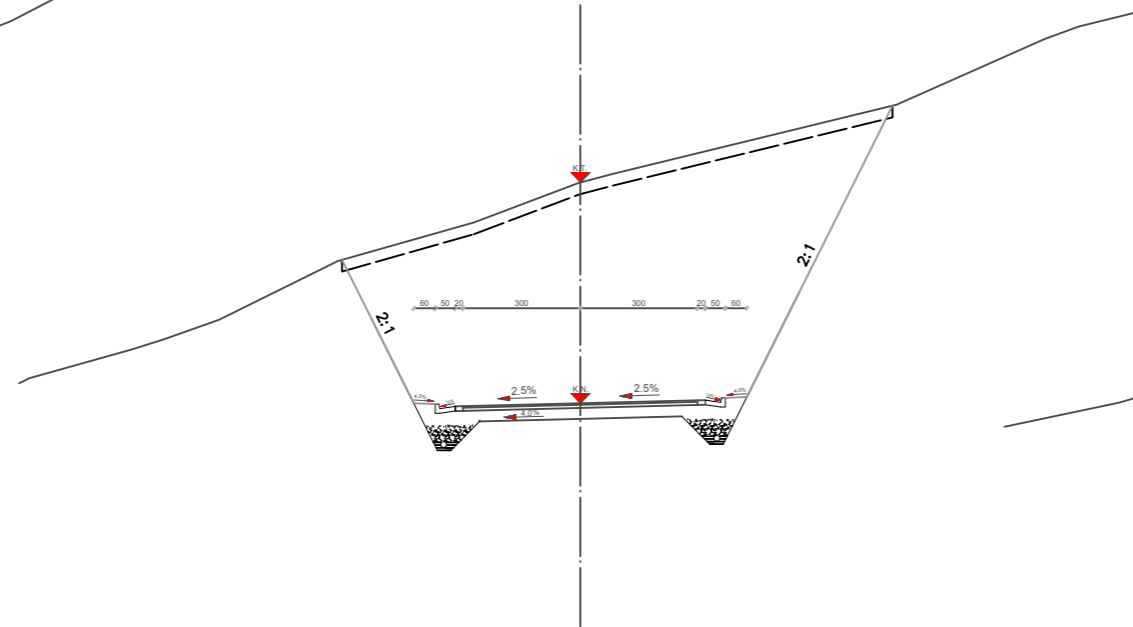

PROFIL 13
ST. 0+360.00

K.N. 224.94
K.T. 226.96

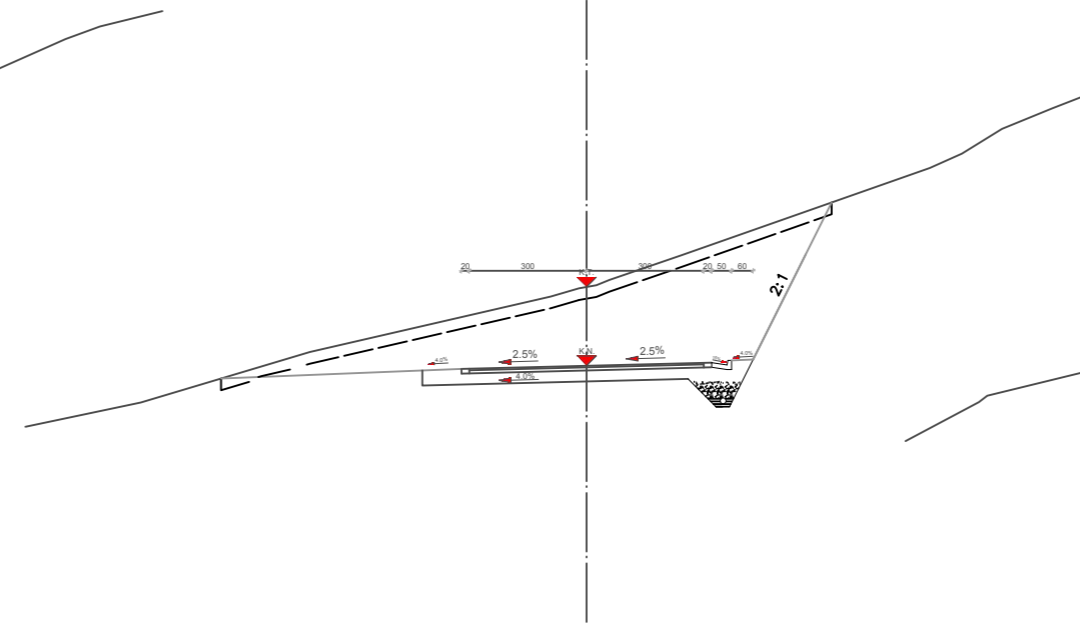

PROFIL 14
ST. 0+390.00

K.N. 225.08
K.T. 224.55

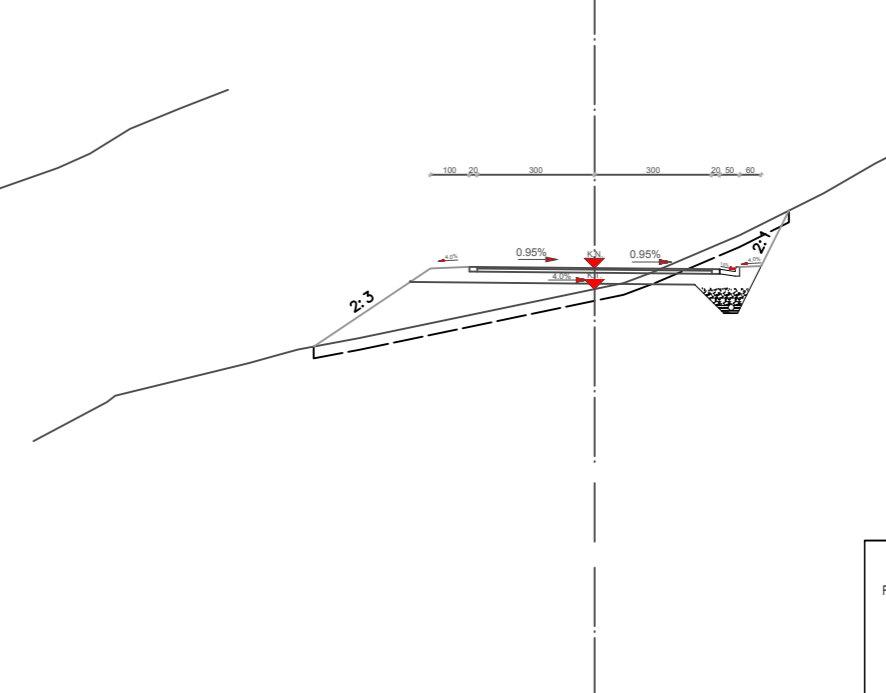

Fakultet građevinarstva arhitekture i geodezije Sveučilište u Splitu 	PREZMET	ZAVRŠNI RAD - CESTE	PRILOG BROJ 4
	ZAGATAK	IDEJNI PROJEKT LOKALNE CESTE	
	SADRŽAJ	POPREČNI PRESJECI (11-14)	DATUM: OŽUJAK 2017.
	IZRAĐIO:	ILIJIA ĐIKIĆ	MJEŠLO 1:100
MENTOR:	izr. prof. dr. sc. DEANA BREŠKI		

5.5. POPREČNI PRESJECI 15-18
M 1:100

PROFIL 15
ST. 0+420.00
K.N. 225.36
K.T. 225.45

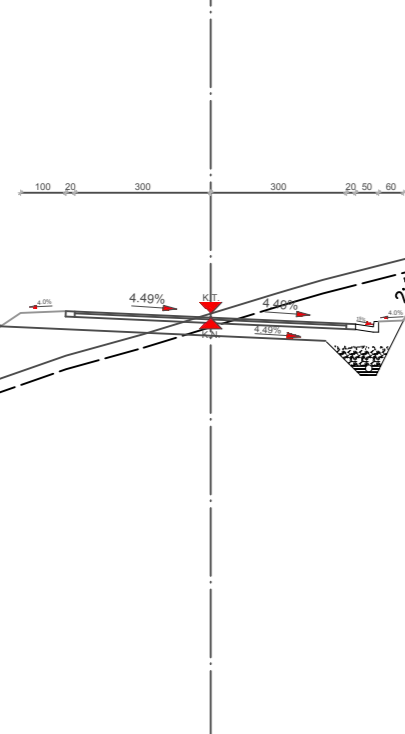

PROFIL 16
ST. 0+450.00
K.N. 225.64
K.T. 226.37

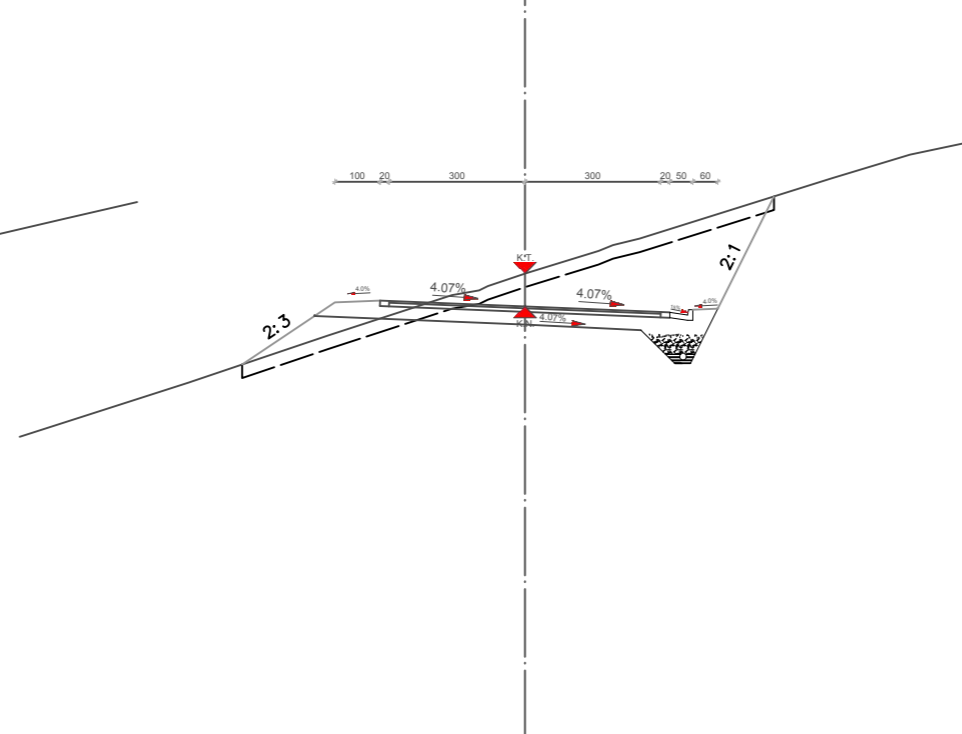

PROFIL 17
ST. 0+480.00
K.N. 225.92
K.T. 227.08

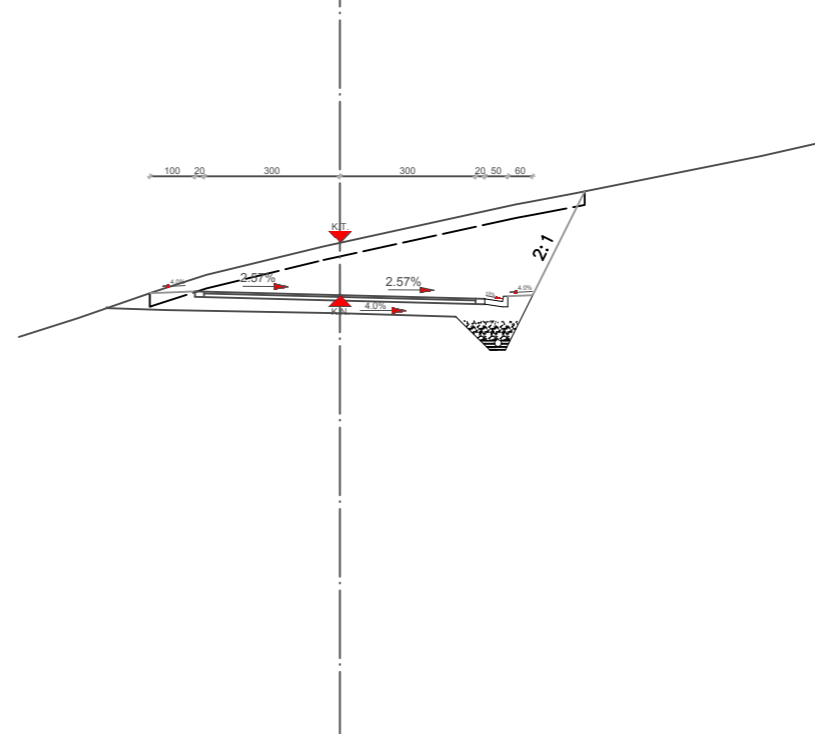

PROFIL 18
ST. 0+488.14
K.N. 226.00
K.T. 226.00

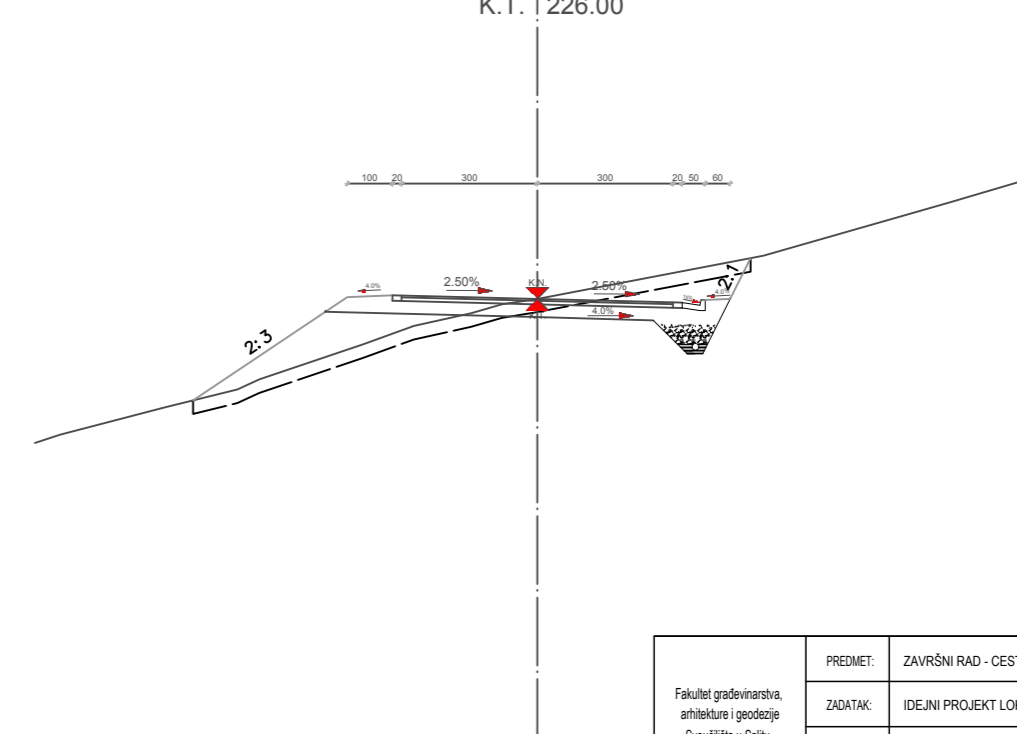

Fakultet građevinarstva, arhitekture i geodazije Sveučilišta u Splitu 	PREDMET:	ZAVRŠNI RAD - CESTE	PRILOG BROJ 5.5
	ZADATAK:	IDEJNI PROJEKT LOKALNE CESTE	
	SADRŽAJ:	POPREČNI PRESJECI (15-18)	DATUM: OŽUJAK / 2017.
	IZRAĐIO:	ILIJIA BIKIĆ	MJERILO: 1:100
	MENTOR:	izr. prof. dr. sc. DEANA BREŠKI	

6. OBRADA NA RAČUNALU

6. OBRADA NA RAČUNALU

Kod izrade idejnog projekta lokalne ceste korišten je softver za projektiranje cesta **CADICS** i **AutoCAD**. Projektiranjem na softveru pojednostavljen je i značajno ubrzan rad za izradu projekta iako je postupak uvelike sličan ručnoj izradi. Prije rada na računalu potrebno je analizirati geodetsku podlogu na kojoj projektiramo kako bi izbjegli moguće probleme i poteškoće te kako bi odredili način na koji ćemo kvalitetno, brzo, efikasno i jednostavno izraditi idejno rješenje.

Prvi korak pri izradi idejnog projekta na računalu je bilo umetanje skeniranog terena u AutoCAD te njegovo skaliranje u pravo mjerilo. Zatim smo digitalizirali izohipse (slojnice) geodetske podloge i zadali svakoj slojnici njezinu nadmorsku visinu. Nakon toga unijeli smo podlogu u softver CADICS i od nje je triangulacijom napravljen trodimenzionalni (3D) model postojećeg terena. Sljedeći korak je definiranje osi ceste te postavljanje tangenti, kružnih lukova i prijelaznih krivina kojim se dobiju horizontalni elementi ceste. Zatim se pristupa izradi uzdužnog presjeka ceste i prilikom izrade uzdužnog presjeka niveletu postavljamo tako da se riješe geometrijski i sigurnosni elementi i odvodnja te između tangenti nivelete interpoliramo odgovarajuću vertikalnu kružnu krivinu.

Poprečnim presjekom definirani su poprečni nagibi, širina kolnika i slojevi kolničke konstrukcije. Kao izlazni podaci dobiju se ispisi horizontalnog toka trase, vertikalnog toka trase, kote kolnika te volumeni iskopa, nasipa i skidanje humusa.

7. RAČUNALNI ISPIS HORIZONTALNOG TOKA TRASE

7. ISPIS HORIZONTALNOG TOKA TRASE

ICS
ROAD DESIGN V-3.80

Gradjevinski Fakultet
DJKIC

Page 1
13/06/17
11:39:29

PROJECT Name:DJIKIC

Title:

NETWORK Name:OS1

Title:

From Ch.: .000 to Ch.: 488.138

No	TYPE	Chainage	X	Y	B	L / R	L / A
1	STR.L.	.000	6382384.410	4826719.210	147.9824		216.513
		216.513	6382542.282	4826571.040	147.9824		
2	CLOTH.	216.513	6382542.282	4826571.040	147.9824		30.000
		246.513	6382566.978	4826554.598	116.1514		30.000
	CIRCLE	246.513	6382566.978	4826554.598	116.1514		31.102
		277.616	6382595.671	4826562.375	50.1501		
		Center :	6382574.507	4826583.638			-30.000
	CLOTH.	277.616	6382595.671	4826562.375	50.1501		30.000
		307.616	6382608.684	4826589.037	18.3191		30.000
3	STR.L.	307.616	6382608.684	4826589.037	18.3191		62.676
		370.292	6382626.471	4826649.136	18.3191		
4	CLOTH.	370.292	6382626.471	4826649.136	18.3191		40.000
		410.292	6382641.363	4826686.104	36.5082		52.915
	CIRCLE	410.292	6382641.363	4826686.104	36.5082		31.134
		441.426	6382663.424	4826707.709	64.8231		
		Center :	6382700.164	4826648.126			70.000
	CLOTH.	441.426	6382663.424	4826707.709	64.8231		40.000
		481.426	6382700.696	4826721.824	83.0122		52.915
5	STR.L.	481.426	6382700.696	4826721.824	83.0122		
		488.138	6382707.170	4826723.594	83.0122		6.712

8. RAČUNALNI ISPIS VERTIKALNOG TOKA TRASE

8. ISPIS VERTIKALNOG TOKA TRASE

ICS
ROAD DESIGN V-3.80

Gradjevinski Fakultet
DJKIC

Page 1
13/06/17
11:40:49

PROJECT Name:DJIKIC

Title:

NETWORK Name:OS1

Title:

From Ch.: .000 to Ch.: 488.138

!No	!TYPE!	Chainage	X	Y	PLevel	GLevel	R
!	!	!	!	!	!	Dcumul	F
!	!	!	!	!	!	Lseg	Hinf pt
!	1!STR.!	.000!	6382384.410!	4826719.210!	240.000!	L=	I(%)=
!	!	298.067!	6382605.820!	4826579.928!	226.470!	298.067!	-4.539!
!	!	!	!	!	!	!	!
!	2!CIRC!	298.067!	6382605.820!	4826579.928!	226.470!	41.017!	1500.00!
!	!	339.064!	6382617.609!	4826619.191!	225.171!	-.020!	-.561!
!	!	366.097!	6382625.281!	4826645.113!	224.927!	!	224.610!
!	!	380.101!	6382629.309!	4826658.525!	224.992!	82.034!	!
!	!	!	!	!	!	!	!
!	3!STR.!	380.101!	6382629.309!	4826658.525!	224.992!	L=	I(%)=
!	!	!	!	!	!	!	.933!
!	!	488.138!	6382707.170!	4826723.594!	226.000!	108.037!	!

9.RAČUNALNI ISPIS KOTA KOLNIKA

9.RAČUNALNI ISPIS KOTA KOLNIKA

ICS
ROAD DESIGN V-3.80

Gradjevinski Fakultet
DJKIC

Page 1
13/06/17
11:41:57

PROJECT Name:DJKIC

Title:

NETWORK Name:OS1

Title:

From Ch.: .000 to Ch.: 488.138

Chainage	no.pts!	Delta X	Z	X	Y	Z
! .000	02C!	-3.200	-.080	! 6382386.600	4826721.543	239.920
!	00C!	.000	.000	! 6382384.410	4826719.210	240.000
!	12C!	3.200	.080	! 6382382.220	4826716.877	240.080
!	!	!	!	!	!	!
! 30.000	02C!	-3.200	-.080	! 6382408.475	4826701.013	238.558
!	00C!	.000	.000	! 6382406.285	4826698.680	238.638
!	12C!	3.200	.080	! 6382404.095	4826696.346	238.718
!	!	!	!	!	!	!
! 60.000	02C!	-3.200	-.080	! 6382430.349	4826680.483	237.197
!	00C!	.000	.000	! 6382428.159	4826678.149	237.277
!	12C!	3.200	.080	! 6382425.970	4826675.816	237.357
!	!	!	!	!	!	!
! 90.000	02C!	-3.200	-.080	! 6382452.224	4826659.952	235.835
!	00C!	.000	.000	! 6382450.034	4826657.619	235.915
!	12C!	3.200	.080	! 6382447.844	4826655.286	235.995
!	!	!	!	!	!	!
! 120.000	02C!	-3.200	-.080	! 6382474.099	4826639.422	234.473
!	00C!	.000	.000	! 6382471.909	4826637.089	234.553
!	12C!	3.200	.080	! 6382469.719	4826634.755	234.633
!	!	!	!	!	!	!
! 150.000	02C!	-3.200	-.080	! 6382495.974	4826618.891	233.111
!	00C!	.000	.000	! 6382493.784	4826616.558	233.191
!	12C!	3.200	.080	! 6382491.594	4826614.225	233.271
!	!	!	!	!	!	!
! 180.000	02C!	-3.200	-.080	! 6382517.848	4826598.361	231.750
!	00C!	.000	.000	! 6382515.658	4826596.028	231.830
!	12C!	3.200	.080	! 6382513.469	4826593.695	231.910
!	!	!	!	!	!	!
! 210.000	02C!	-3.200	-.080	! 6382539.723	4826577.831	230.388
!	00C!	.000	.000	! 6382537.533	4826575.497	230.468
!	12C!	3.200	.080	! 6382535.343	4826573.164	230.548
!	!	!	!	!	!	!
! 240.000	02C!	-3.200	-.193	! 6382562.263	4826559.740	228.913
!	00C!	.000	.000	! 6382560.879	4826556.855	229.106
!	12C!	3.200	.193	! 6382559.495	4826553.970	229.299
!	!	!	!	!	!	!
! 270.000	02C!	-3.200	-.224	! 6382588.037	4826560.504	227.520
!	00C!	.000	.000	! 6382589.652	4826557.741	227.744
!	12C!	3.200	.224	! 6382591.268	4826554.979	227.968
!	!	!	!	!	!	!
! 300.000	02C!	-3.200	-.117	! 6382603.407	4826582.764	226.267
!	00C!	.000	.000	! 6382606.444	4826581.758	226.384
!	12C!	3.200	.117	! 6382609.482	4826580.751	226.500

!		!		!				!	
!	330.000	02C!	-3.200	-.080	!	6382611.968	4826611.409	225.281	!
!		00C!	.000	.000	!	6382615.036	4826610.500	225.361	!
!		12C!	3.200	.080	!	6382618.105	4826609.592	225.441	!
!		!		!				!	!
!	360.000	02C!	-3.200	-.080	!	6382620.482	4826640.175	224.859	!
!		00C!	.000	.000	!	6382623.550	4826639.267	224.939	!
!		12C!	3.200	.080	!	6382626.619	4826638.359	225.019	!

ICS	Gradjevinski Fakultet	Page 2
ROAD DESIGN V-3.80	DJIKIC	13/06/17
		11:41:57

PROJECT Name:DJIKIC

Title:

NETWORK Name:OS1

Title:

From Ch.: .000 to Ch.: 488.138

Chainage	no.pts!	Delta X	Z	X	Y	Z
390.000	02C!	-3.200	.030	6382629.500	4826669.014	225.115
	00C!	.000	.000	6382632.498	4826667.895	225.085
	12C!	3.200	-.030	6382635.497	4826666.776	225.054
420.000	02C!	-3.200	.144	6382644.755	4826695.960	225.508
	00C!	.000	.000	6382647.177	4826693.869	225.364
	12C!	3.200	-.144	6382649.600	4826691.777	225.221
450.000	02C!	-3.200	.130	6382669.590	4826714.676	225.774
	00C!	.000	.000	6382670.962	4826711.785	225.644
	12C!	3.200	-.130	6382672.334	4826708.894	225.514
480.000	02C!	-3.200	.082	6382698.475	4826724.534	226.006
	00C!	.000	.000	6382699.320	4826721.448	225.924
	12C!	3.200	-.082	6382700.165	4826718.361	225.842
488.138	02C!	-3.200	.080	6382706.326	4826726.681	226.080
	00C!	.000	.000	6382707.170	4826723.594	226.000
	12C!	3.200	-.080	6382708.014	4826720.507	225.920

ICS	Gradjevinski Fakultet	Page 1
ROAD DESIGN V-3.80	DJIKIC	13/06/17
		11:41:57

PROJECT Name:DJIKIC

Title:

NETWORK Name:OS1

Title:

From Ch.: .000 to Ch.: 488.138

Chainage	no.pts!	Delta X	Z !	X	Y	Z	!
!	.000	01A!	-14.469	-7.000 !	6382394.312	4826729.760	233.000 !
!		02A!	-4.200	-.120 !	6382387.284	4826722.272	239.880 !
!		03A!	-3.200	-.080 !	6382386.600	4826721.543	239.920 !
!		04A!	3.200	.080 !	6382382.220	4826716.877	240.080 !
!		05A!	4.200	.040 !	6382381.536	4826716.148	240.040 !
!		06A!	5.608	2.856 !	6382380.572	4826715.121	242.856 !
!		!	!	!	!	!	!
!	30.000	01A!	-14.645	-7.118 !	6382416.307	4826709.358	231.520 !
!		02A!	-4.200	-.120 !	6382409.159	4826701.742	238.518 !
!		03A!	-3.200	-.080 !	6382408.475	4826701.013	238.558 !
!		04A!	3.200	.080 !	6382404.095	4826696.346	238.718 !
!		05A!	4.200	.040 !	6382403.410	4826695.617	238.678 !
!		06A!	4.887	1.413 !	6382402.941	4826695.117	240.052 !
!		!	!	!	!	!	!
!	60.000	01A!	-16.211	-8.167 !	6382439.253	4826689.970	229.109 !
!		02A!	-4.200	-.120 !	6382431.034	4826681.212	237.157 !
!		03A!	-3.200	-.080 !	6382430.349	4826680.483	237.197 !
!		04A!	3.200	.080 !	6382425.970	4826675.816	237.357 !
!		05A!	4.200	.040 !	6382425.285	4826675.087	237.317 !
!		06A!	4.227	.094 !	6382425.267	4826675.067	237.371 !
!		!	!	!	!	!	!
!	90.000	01A!	-17.171	-8.810 !	6382461.785	4826670.139	227.104 !
!		02A!	-4.200	-.120 !	6382452.908	4826660.681	235.795 !
!		03A!	-3.200	-.080 !	6382452.224	4826659.952	235.835 !
!		04A!	3.200	.080 !	6382447.844	4826655.286	235.995 !
!		05A!	4.200	.040 !	6382447.160	4826654.556	235.955 !
!		06A!	8.659	.263 !	6382444.108	4826651.305	236.178 !
!		!	!	!	!	!	!
!	120.000	01A!	-17.095	-8.760 !	6382483.608	4826649.554	225.793 !
!		02A!	-4.200	-.120 !	6382474.783	4826640.151	234.433 !
!		03A!	-3.200	-.080 !	6382474.099	4826639.422	234.473 !
!		04A!	3.200	.080 !	6382469.719	4826634.755	234.633 !
!		05A!	4.200	.040 !	6382469.035	4826634.026	234.593 !
!		06A!	7.116	.186 !	6382467.039	4826631.900	234.739 !
!		!	!	!	!	!	!
!	150.000	01A!	-14.951	-7.323 !	6382504.015	4826627.460	225.868 !
!		02A!	-4.200	-.120 !	6382496.658	4826619.621	233.071 !
!		03A!	-3.200	-.080 !	6382495.974	4826618.891	233.111 !
!		04A!	3.200	.080 !	6382491.594	4826614.225	233.271 !
!		05A!	4.200	.040 !	6382490.909	4826613.496	233.231 !
!		06A!	4.247	.134 !	6382490.877	4826613.461	233.326 !
!		!	!	!	!	!	!
!	180.000	01A!	-6.755	-1.832 !	6382520.281	4826600.953	229.998 !
!		02A!	-4.200	-.120 !	6382518.533	4826599.090	231.710 !
!		03A!	-3.200	-.080 !	6382517.848	4826598.361	231.750 !
!		04A!	3.200	.080 !	6382513.469	4826593.695	231.910 !
!		05A!	4.200	.040 !	6382512.784	4826592.965	231.870 !
!		06A!	6.090	3.821 !	6382511.490	4826591.587	235.650 !
!		!	!	!	!	!	!

ICS	Gradjevinski Fakultet	Page 2
ROAD DESIGN V-3.80	DJIKIC	13/06/17
		11:41:57

PROJECT Name:DJIKIC

Title:

NETWORK Name:OS1

Title:

From Ch.: .000 to Ch.: 488.138

Chainage	no.pts!	Delta X	Z	X	Y	Z
210.000	01A!	-5.341	2.161	6382541.188	4826579.392	232.629
	02A!	-4.200	-.120	6382540.407	4826578.560	230.348
	03A!	-3.200	-.080	6382539.723	4826577.831	230.388
	04A!	3.200	.080	6382535.343	4826573.164	230.548
	05A!	4.200	.040	6382534.659	4826572.435	230.508
	06A!	8.696	9.032	6382531.582	4826569.157	239.499
240.000	01A!	-5.919	3.205	6382563.438	4826562.192	232.311
	02A!	-4.200	-.233	6382562.695	4826560.642	228.873
	03A!	-3.200	-.193	6382562.263	4826559.740	228.913
	04A!	3.200	.193	6382559.495	4826553.970	229.299
	05A!	4.200	.153	6382559.062	4826553.068	229.259
	06A!	9.398	10.549	6382556.814	4826548.382	239.655
270.000	01A!	-7.204	-2.277	6382586.015	4826563.960	225.467
	02A!	-4.200	-.264	6382587.532	4826561.367	227.480
	03A!	-3.200	-.224	6382588.037	4826560.504	227.520
	04A!	3.200	.224	6382591.268	4826554.979	227.968
	05A!	4.200	.184	6382591.773	4826554.116	227.928
	06A!	9.182	-.065	6382594.288	4826549.815	227.679
300.000	01A!	-7.241	-2.194	6382599.571	4826584.035	224.190
	02A!	-4.200	-.157	6382602.457	4826583.079	226.227
	03A!	-3.200	-.117	6382603.407	4826582.764	226.267
	04A!	3.200	.117	6382609.482	4826580.751	226.500
	05A!	4.200	.077	6382610.431	4826580.437	226.460
	06A!	6.945	5.567	6382613.037	4826579.573	231.951
330.000	01A!	-6.094	3.669	6382609.193	4826612.230	229.030
	02A!	-4.200	-.120	6382611.009	4826611.692	225.241
	03A!	-3.200	-.080	6382611.968	4826611.409	225.281
	04A!	3.200	.080	6382618.105	4826609.592	225.441
	05A!	4.200	.040	6382619.064	4826609.309	225.401
	06A!	7.986	7.613	6382622.694	4826608.234	232.974
360.000	01A!	-8.019	.071	6382615.861	4826641.543	225.010
	02A!	-4.200	-.120	6382619.523	4826640.459	224.819
	03A!	-3.200	-.080	6382620.482	4826640.175	224.859
	04A!	3.200	.080	6382626.619	4826638.359	225.019
	05A!	4.200	.040	6382627.578	4826638.075	224.979
	06A!	6.269	4.178	6382629.562	4826637.488	229.117
390.000	01A!	-7.185	-2.010	6382625.767	4826670.407	223.075
	02A!	-4.200	-.010	6382628.563	4826669.363	225.075
	03A!	-3.200	.030	6382629.500	4826669.014	225.115
	04A!	3.200	-.030	6382635.497	4826666.776	225.054
	05A!	4.200	-.070	6382636.434	4826666.427	225.014
	06A!	4.970	1.470	6382637.155	4826666.158	226.555

ICS	Gradjevinski Fakultet	Page 1
ROAD DESIGN V-3.80	DJIKIC	13/06/17
		11:41:57

PROJECT Name:DJIKIC

Title:

NETWORK Name:OS1

Title:

From Ch.: .000 to Ch.: 488.138

Chainage	no.pts!	Delta X	Z	X	Y	Z
! .000	01I!	-4.200	-.120	6382387.284	4826722.272	239.880
!	02I!	-4.797	-.520	6382387.693	4826722.708	239.480
!	03I!	-3.200	-.480	6382386.600	4826721.543	239.520
!	04I!	-3.200	-.480	6382386.600	4826721.543	239.520
!	05I!	.000	-.400	6382384.410	4826719.210	239.600
!	06I!	.000	-.400	6382384.410	4826719.210	239.600
!	07I!	.000	-.400	6382384.410	4826719.210	239.600
!	08I!	.000	-.400	6382384.410	4826719.210	239.600
!	09I!	3.200	-.320	6382382.220	4826716.877	239.680
!	10I!	3.200	-.320	6382382.220	4826716.877	239.680
!	11I!	4.200	-.295	6382381.536	4826716.148	239.705
!	12I!	4.200	.040	6382381.536	4826716.148	240.040
!	!	!	!	!	!	!
!	30.000	01I!	-4.200	6382409.159	4826701.742	238.518
!	!	02I!	-4.797	6382409.567	4826702.177	238.118
!	!	03I!	-3.200	6382408.475	4826701.013	238.158
!	!	04I!	-3.200	6382408.475	4826701.013	238.158
!	!	05I!	.000	6382406.285	4826698.680	238.238
!	!	06I!	.000	6382406.285	4826698.680	238.238
!	!	07I!	.000	6382406.285	4826698.680	238.238
!	!	08I!	.000	6382406.285	4826698.680	238.238
!	!	09I!	3.200	6382404.095	4826696.346	238.318
!	!	10I!	3.200	6382404.095	4826696.346	238.318
!	!	11I!	4.200	6382403.410	4826695.617	238.343
!	!	12I!	4.200	6382403.410	4826695.617	238.678
!	!	!	!	!	!	!
!	60.000	01I!	-4.200	6382431.034	4826681.212	237.157
!	!	02I!	-4.797	6382431.442	4826681.647	236.757
!	!	03I!	-3.200	6382430.349	4826680.483	236.797
!	!	04I!	-3.200	6382430.349	4826680.483	236.797
!	!	05I!	.000	6382428.159	4826678.149	236.877
!	!	06I!	.000	6382428.159	4826678.149	236.877
!	!	07I!	.000	6382428.159	4826678.149	236.877
!	!	08I!	.000	6382428.159	4826678.149	236.877
!	!	09I!	3.200	6382425.970	4826675.816	236.957
!	!	10I!	3.200	6382425.970	4826675.816	236.957
!	!	11I!	4.200	6382425.285	4826675.087	236.982
!	!	12I!	4.200	6382425.285	4826675.087	237.317
!	!	!	!	!	!	!
!	90.000	01I!	-4.200	6382452.908	4826660.681	235.795
!	!	02I!	-4.797	6382453.317	4826661.117	235.395
!	!	03I!	-3.200	6382452.224	4826659.952	235.435
!	!	04I!	-3.200	6382452.224	4826659.952	235.435
!	!	05I!	.000	6382450.034	4826657.619	235.515
!	!	06I!	.000	6382450.034	4826657.619	235.515
!	!	07I!	.000	6382450.034	4826657.619	235.515
!	!	08I!	.000	6382450.034	4826657.619	235.515
!	!	09I!	3.200	6382447.844	4826655.286	235.595
!	!	10I!	3.200	6382447.844	4826655.286	235.595
!	!	11I!	4.200	6382447.160	4826654.556	235.620
!	!	12I!	4.200	6382447.160	4826654.556	235.955

ICS	Gradjevinski Fakultet	Page 2
ROAD DESIGN V-3.80	DJIKIC	13/06/17
		11:41:57

PROJECT Name:DJIKIC

Title:

NETWORK Name:OS1

Title:

From Ch.: .000 to Ch.: 488.138

Chainage	no.pts!	Delta X	Z !	X	Y	Z	!
!	!	!	!	!	!	!	!
!	120.000	01I!	-4.200	-.120	6382474.783	4826640.151	234.433
!		02I!	-4.797	-.520	6382475.192	4826640.586	234.033
!		03I!	-3.200	-.480	6382474.099	4826639.422	234.073
!		04I!	-3.200	-.480	6382474.099	4826639.422	234.073
!		05I!	.000	-.400	6382471.909	4826637.089	234.153
!		06I!	.000	-.400	6382471.909	4826637.089	234.153
!		07I!	.000	-.400	6382471.909	4826637.089	234.153
!		08I!	.000	-.400	6382471.909	4826637.089	234.153
!		09I!	3.200	-.320	6382469.719	4826634.755	234.233
!		10I!	3.200	-.320	6382469.719	4826634.755	234.233
!		11I!	4.200	-.295	6382469.035	4826634.026	234.258
!		12I!	4.200	.040	6382469.035	4826634.026	234.593
!	!	!	!	!	!	!	!
!	150.000	01I!	-4.200	-.120	6382496.658	4826619.621	233.071
!		02I!	-4.797	-.520	6382497.066	4826620.056	232.671
!		03I!	-3.200	-.480	6382495.974	4826618.891	232.711
!		04I!	-3.200	-.480	6382495.974	4826618.891	232.711
!		05I!	.000	-.400	6382493.784	4826616.558	232.791
!		06I!	.000	-.400	6382493.784	4826616.558	232.791
!		07I!	.000	-.400	6382493.784	4826616.558	232.791
!		08I!	.000	-.400	6382493.784	4826616.558	232.791
!		09I!	3.200	-.320	6382491.594	4826614.225	232.871
!		10I!	3.200	-.320	6382491.594	4826614.225	232.871
!		11I!	4.200	-.295	6382490.909	4826613.496	232.896
!		12I!	4.200	.040	6382490.909	4826613.496	233.231
!	!	!	!	!	!	!	!
!	180.000	01I!	-4.200	-.120	6382518.533	4826599.090	231.710
!		02I!	-4.797	-.520	6382518.941	4826599.526	231.310
!		03I!	-3.200	-.480	6382517.848	4826598.361	231.350
!		04I!	-3.200	-.480	6382517.848	4826598.361	231.350
!		05I!	.000	-.400	6382515.658	4826596.028	231.430
!		06I!	.000	-.400	6382515.658	4826596.028	231.430
!		07I!	.000	-.400	6382515.658	4826596.028	231.430
!		08I!	.000	-.400	6382515.658	4826596.028	231.430
!		09I!	3.200	-.320	6382513.469	4826593.695	231.510
!		10I!	3.200	-.320	6382513.469	4826593.695	231.510
!		11I!	4.200	-.295	6382512.784	4826592.965	231.535
!		12I!	4.200	.040	6382512.784	4826592.965	231.870
!	!	!	!	!	!	!	!
!	210.000	01I!	-4.200	-.120	6382540.407	4826578.560	230.348
!		02I!	-4.200	-.505	6382540.407	4826578.560	229.963
!		03I!	-3.200	-.480	6382539.723	4826577.831	229.988
!		04I!	-3.200	-.480	6382539.723	4826577.831	229.988
!		05I!	.000	-.400	6382537.533	4826575.497	230.068
!		06I!	.000	-.400	6382537.533	4826575.497	230.068
!		07I!	.000	-.400	6382537.533	4826575.497	230.068
!		08I!	.000	-.400	6382537.533	4826575.497	230.068
!		09I!	3.200	-.320	6382535.343	4826573.164	230.148
!		10I!	3.200	-.320	6382535.343	4826573.164	230.148
!		11I!	4.200	-.295	6382534.659	4826572.435	230.173

ICS	Gradjeviniski Fakultet	Page 4
ROAD DESIGN V-3.80	DJIKIC	13/06/17
		11:41:57

PROJECT Name:DJIKIC

Title:

NETWORK Name:OS1

Title:

From Ch.: .000 to Ch.: 488.138

Chainage	no.pts!	Delta X	Z !	X	Y	Z	!
!	11I!	4.200	-.295 !	6382619.064	4826609.309	225.066	!
!	12I!	4.200	.040 !	6382619.064	4826609.309	225.401	!
!	!	!	!	!	!	!	!
!	360.000	01I!	-4.200	-.120 !	6382619.523	4826640.459	224.819 !
!		02I!	-4.200	-.505 !	6382619.523	4826640.459	224.434 !
!		03I!	-3.200	-.480 !	6382620.482	4826640.175	224.459 !
!		04I!	-3.200	-.480 !	6382620.482	4826640.175	224.459 !
!		05I!	.000	-.400 !	6382623.550	4826639.267	224.539 !
!		06I!	.000	-.400 !	6382623.550	4826639.267	224.539 !
!		07I!	.000	-.400 !	6382623.550	4826639.267	224.539 !
!		08I!	.000	-.400 !	6382623.550	4826639.267	224.539 !
!		09I!	3.200	-.320 !	6382626.619	4826638.359	224.619 !
!		10I!	3.200	-.320 !	6382626.619	4826638.359	224.619 !
!		11I!	4.200	-.295 !	6382627.578	4826638.075	224.644 !
!		12I!	4.200	.040 !	6382627.578	4826638.075	224.979 !
!	!	!	!	!	!	!	!
!	390.000	01I!	-4.200	-.010 !	6382628.563	4826669.363	225.075 !
!		02I!	-4.716	-.355 !	6382628.080	4826669.544	224.729 !
!		03I!	-3.200	-.370 !	6382629.500	4826669.014	224.715 !
!		04I!	-3.200	-.370 !	6382629.500	4826669.014	224.715 !
!		05I!	.000	-.400 !	6382632.498	4826667.895	224.685 !
!		06I!	.000	-.400 !	6382632.498	4826667.895	224.685 !
!		07I!	.000	-.400 !	6382632.498	4826667.895	224.685 !
!		08I!	.000	-.400 !	6382632.498	4826667.895	224.685 !
!		09I!	3.200	-.430 !	6382635.497	4826666.776	224.654 !
!		10I!	3.200	-.430 !	6382635.497	4826666.776	224.654 !
!		11I!	4.200	-.440 !	6382636.434	4826666.427	224.645 !
!		12I!	4.200	-.070 !	6382636.434	4826666.427	225.014 !
!	!	!	!	!	!	!	!
!	420.000	01I!	-4.200	.104 !	6382643.998	4826696.613	225.468 !
!		02I!	-4.641	-.191 !	6382643.665	4826696.901	225.173 !
!		03I!	-3.200	-.256 !	6382644.755	4826695.960	225.108 !
!		04I!	-3.200	-.256 !	6382644.755	4826695.960	225.108 !
!		05I!	.000	-.400 !	6382647.177	4826693.869	224.964 !
!		06I!	.000	-.400 !	6382647.177	4826693.869	224.964 !
!		07I!	.000	-.400 !	6382647.177	4826693.869	224.964 !
!		08I!	.000	-.400 !	6382647.177	4826693.869	224.964 !
!		09I!	3.200	-.544 !	6382649.600	4826691.777	224.821 !
!		10I!	3.200	-.544 !	6382649.600	4826691.777	224.821 !
!		11I!	4.200	-.589 !	6382650.357	4826691.124	224.776 !
!		12I!	4.200	-.184 !	6382650.357	4826691.124	225.181 !
!	!	!	!	!	!	!	!
!	450.000	01I!	-4.200	.090 !	6382669.161	4826715.579	225.734 !
!		02I!	-4.649	-.211 !	6382668.968	4826715.985	225.433 !
!		03I!	-3.200	-.270 !	6382669.590	4826714.676	225.374 !
!		04I!	-3.200	-.270 !	6382669.590	4826714.676	225.374 !
!		05I!	.000	-.400 !	6382670.962	4826711.785	225.244 !
!		06I!	.000	-.400 !	6382670.962	4826711.785	225.244 !
!		07I!	.000	-.400 !	6382670.962	4826711.785	225.244 !
!		08I!	.000	-.400 !	6382670.962	4826711.785	225.244 !
!		09I!	3.200	-.530 !	6382672.334	4826708.894	225.114 !

ICS Gradjevinski Fakultet
ROAD DESIGN V-3.80 DJIKIC

Page 5
13/06/17
11:41:57

PROJECT Name:DJIKIC

Title:

NETWORK Name:OS1

Title:

From Ch.: .000 to Ch.: 488.138

Chainage	no.pts!	Delta X	Z !	X	Y	Z	!
	10I!	3.200	-.530 !	6382672.334	4826708.894	225.114	!
	11I!	4.200	-.571 !	6382672.763	4826707.991	225.073	!
	12I!	4.200	-.170 !	6382672.763	4826707.991	225.474	!
	!	!	!	!	!	!	!
480.000	01I!	-4.200	.042 !	6382698.211	4826725.499	225.966	!
	02I!	-4.200	-.292 !	6382698.211	4826725.499	225.632	!
	03I!	-3.200	-.318 !	6382698.475	4826724.534	225.606	!
	04I!	-3.200	-.318 !	6382698.475	4826724.534	225.606	!
	05I!	.000	-.400 !	6382699.320	4826721.448	225.524	!
	06I!	.000	-.400 !	6382699.320	4826721.448	225.524	!
	07I!	.000	-.400 !	6382699.320	4826721.448	225.524	!
	08I!	.000	-.400 !	6382699.320	4826721.448	225.524	!
	09I!	3.200	-.482 !	6382700.165	4826718.361	225.442	!
	10I!	3.200	-.482 !	6382700.165	4826718.361	225.442	!
	11I!	4.200	-.508 !	6382700.429	4826717.397	225.416	!
	12I!	4.200	-.122 !	6382700.429	4826717.397	225.802	!
	!	!	!	!	!	!	!
488.138	01I!	-4.200	.040 !	6382706.063	4826727.645	226.040	!
	02I!	-4.682	-.283 !	6382705.936	4826728.110	225.717	!
	03I!	-3.200	-.320 !	6382706.326	4826726.681	225.680	!
	04I!	-3.200	-.320 !	6382706.326	4826726.681	225.680	!
	05I!	.000	-.400 !	6382707.170	4826723.594	225.600	!
	06I!	.000	-.400 !	6382707.170	4826723.594	225.600	!
	07I!	.000	-.400 !	6382707.170	4826723.594	225.600	!
	08I!	.000	-.400 !	6382707.170	4826723.594	225.600	!
	09I!	3.200	-.480 !	6382708.014	4826720.507	225.520	!
	10I!	3.200	-.480 !	6382708.014	4826720.507	225.520	!
	11I!	4.200	-.505 !	6382708.278	4826719.542	225.495	!
	12I!	4.200	-.120 !	6382708.278	4826719.542	225.880	!
	!	!	!	!	!	!	!

ICS	Gradjevinski Fakultet	Page 1
ROAD DESIGN V-3.80	DJIKIC	13/06/17
		11:41:57

PROJECT Name:DJIKIC

Title:

NETWORK Name:OS1

Title:

From Ch.: .000 to Ch.: 488.138

Chainage	no.pts!	Delta X	Z !	X	Y	Z	!
.000	01T!	-22.345	-7.343 !	6382399.702	4826735.503	232.657	!
	02T!	-22.279	-7.347 !	6382399.657	4826735.455	232.653	!
	03T!	-21.856	-7.366 !	6382399.367	4826735.147	232.634	!
	04T!	-21.689	-7.370 !	6382399.253	4826735.025	232.630	!
	05T!	-21.377	-7.371 !	6382399.040	4826734.797	232.629	!
	06T!	-16.473	-7.233 !	6382395.683	4826731.221	232.767	!
	07T!	-16.153	-7.160 !	6382395.464	4826730.988	232.840	!
	08T!	-15.266	-7.000 !	6382394.857	4826730.341	233.000	!
	09T!	-14.369	-7.000 !	6382394.243	4826729.687	233.000	!
	10T!	-12.804	-6.312 !	6382393.172	4826728.546	233.688	!
	11T!	-12.203	-6.000 !	6382392.761	4826728.108	234.000	!
	12T!	-10.492	-5.015 !	6382391.590	4826726.860	234.985	!
	13T!	-10.466	-5.000 !	6382391.572	4826726.841	235.000	!
	14T!	-10.449	-4.990 !	6382391.561	4826726.829	235.010	!
	15T!	-6.933	-3.000 !	6382389.155	4826724.265	237.000	!
	16T!	-2.629	-1.417 !	6382386.209	4826721.127	238.583	!
	17T!	-1.589	-1.000 !	6382385.497	4826720.369	239.000	!
	18T!	-.934	-.606 !	6382385.049	4826719.891	239.394	!
	19T!	-.232	.000 !	6382384.569	4826719.379	240.000	!
	20T!	.696	.367 !	6382383.933	4826718.702	240.367	!
	21T!	1.436	.788 !	6382383.427	4826718.163	240.788	!
	22T!	3.273	1.471 !	6382382.170	4826716.823	241.471	!
	23T!	4.223	2.000 !	6382381.520	4826716.131	242.000	!
	24T!	5.020	2.560 !	6382380.974	4826715.549	242.560	!
	25T!	5.894	3.000 !	6382380.376	4826714.912	243.000	!
	26T!	8.901	3.980 !	6382378.318	4826712.719	243.980	!
	27T!	9.055	4.048 !	6382378.213	4826712.608	244.048	!
	28T!	10.610	5.000 !	6382377.149	4826711.474	245.000	!
	29T!	10.744	5.000 !	6382377.058	4826711.376	245.000	!
	30T!	10.832	5.000 !	6382376.997	4826711.312	245.000	!
	31T!	11.783	5.000 !	6382376.346	4826710.618	245.000	!
	32T!	12.182	5.000 !	6382376.073	4826710.327	245.000	!
	!	!	!	!	!	!	!
30.000	01T!	-25.000	-7.409 !	6382423.393	4826716.909	231.229	!
	02T!	-14.311	-7.109 !	6382416.078	4826709.114	231.529	!
	03T!	-12.366	-6.667 !	6382414.747	4826707.696	231.971	!
	04T!	-12.332	-6.638 !	6382414.724	4826707.672	232.000	!
	05T!	-11.987	-6.478 !	6382414.488	4826707.420	232.161	!
	06T!	-10.665	-5.638 !	6382413.583	4826706.456	233.000	!
	07T!	-9.209	-4.965 !	6382412.587	4826705.395	233.674	!
	08T!	-6.459	-3.638 !	6382410.705	4826703.389	235.000	!
	09T!	-5.266	-3.116 !	6382409.889	4826702.520	235.522	!
	10T!	-2.986	-1.867 !	6382408.328	4826700.857	236.771	!
	11T!	-.764	-.671 !	6382406.807	4826699.237	237.967	!
	12T!	-.708	-.643 !	6382406.769	4826699.196	237.995	!
	13T!	-.697	-.638 !	6382406.761	4826699.188	238.000	!
	14T!	-.664	-.625 !	6382406.739	4826699.163	238.013	!
	15T!	6.677	2.071 !	6382401.715	4826693.811	240.709	!
	16T!	7.367	2.362 !	6382401.243	4826693.308	241.000	!
	17T!	9.360	3.184 !	6382399.879	4826691.855	241.822	!
	18T!	9.812	3.362 !	6382399.570	4826691.525	242.000	!

ICS
ROAD DESIGN V-3.80

Gradjevinski Fakultet
DJIKIC

Page 2
13/06/17
11:41:57

PROJECT Name:DJIKIC

Title:

NETWORK Name:OS1

Title:

From Ch.: .000 to Ch.: 488.138

Chainage	no.pts!	Delta X	Z	X	Y	Z	
!	19T!	10.609	3.809	6382399.025	4826690.944	242.447	
!	20T!	14.386	5.950	6382396.440	4826688.190	244.589	
!	21T!	14.710	6.047	6382396.218	4826687.954	244.685	
!	22T!	14.952	6.206	6382396.053	4826687.778	244.845	
!	23T!	15.014	6.229	6382396.010	4826687.732	244.867	
!	!	!	!	!	!	!	
!	60.000	01T!	-25.000	-7.731	6382445.268	4826696.378	229.545
!		02T!	-22.360	-7.804	6382443.461	4826694.453	229.473
!		03T!	-14.320	-8.279	6382437.959	4826688.591	228.997
!		04T!	-14.277	-8.281	6382437.930	4826688.559	228.996
!		05T!	-14.268	-8.277	6382437.924	4826688.553	229.000
!		06T!	-14.247	-8.267	6382437.909	4826688.538	229.010
!		07T!	-14.194	-8.235	6382437.873	4826688.499	229.042
!		08T!	-11.388	-6.716	6382435.953	4826686.453	230.561
!		09T!	-10.622	-6.277	6382435.429	4826685.895	231.000
!		10T!	-9.050	-5.473	6382434.353	4826684.748	231.803
!		11T!	-6.206	-4.277	6382432.407	4826682.674	233.000
!		12T!	-4.351	-3.689	6382431.137	4826681.322	233.588
!		13T!	-.864	-2.098	6382428.750	4826678.779	235.179
!		14T!	1.206	-1.277	6382427.334	4826677.270	236.000
!		15T!	1.847	-.969	6382426.895	4826676.802	236.307
!		16T!	4.814	.356	6382424.865	4826674.639	237.633
!		17T!	5.813	.723	6382424.182	4826673.911	238.000
!		18T!	7.803	1.433	6382422.820	4826672.460	238.709
!		19T!	8.918	1.876	6382422.056	4826671.646	239.153
!		20T!	10.617	2.723	6382420.894	4826670.408	240.000
!		21T!	12.023	3.389	6382419.932	4826669.383	240.665
!		22T!	12.773	3.723	6382419.418	4826668.836	241.000
!		23T!	13.189	3.904	6382419.133	4826668.532	241.181
!		24T!	15.178	4.723	6382417.773	4826667.082	242.000
!		25T!	15.309	4.723	6382417.683	4826666.987	242.000
!		26T!	15.384	4.826	6382417.631	4826666.932	242.102
!		27T!	15.467	4.856	6382417.575	4826666.871	242.132
!	!	!	!	!	!	!	
!	90.000	01T!	-25.000	-8.818	6382467.143	4826675.848	227.097
!		02T!	-14.390	-8.808	6382459.882	4826668.112	227.107
!		03T!	-14.242	-8.714	6382459.781	4826668.003	227.201
!		04T!	-13.597	-8.457	6382459.339	4826667.533	227.458
!		05T!	-12.018	-7.626	6382458.259	4826666.382	228.289
!		06T!	-10.361	-6.915	6382457.125	4826665.174	229.000
!		07T!	-8.254	-6.383	6382455.683	4826663.637	229.532
!		08T!	-6.411	-5.915	6382454.421	4826662.293	230.000
!		09T!	-5.276	-5.301	6382453.645	4826661.466	230.614
!		10T!	-4.698	-4.915	6382453.249	4826661.044	231.000
!		11T!	-4.284	-4.770	6382452.966	4826660.742	231.145
!		12T!	2.062	-2.336	6382448.623	4826656.115	233.579
!		13T!	8.235	.104	6382444.399	4826651.614	236.019
!		14T!	9.706	.656	6382443.392	4826650.542	236.571
!		15T!	11.135	1.325	6382442.414	4826649.500	237.240
!		16T!	12.646	2.085	6382441.380	4826648.398	238.000
!		17T!	13.698	2.637	6382440.660	4826647.631	238.552

ICS	Gradjevinski Fakultet	Page 3
ROAD DESIGN V-3.80	DJIKIC	13/06/17
		11:41:57

PROJECT Name:DJIKIC

Title:

NETWORK Name:OS1

Title:

From Ch.: .000 to Ch.: 488.138

Chainage	no.pts!	Delta X	Z !	X	Y	Z !	
!	18T!	13.911	2.752 !	6382440.515	4826647.476	238.667 !	
!	19T!	14.059	2.878 !	6382440.413	4826647.367	238.793 !	
!	20T!	14.954	3.947 !	6382439.800	4826646.715	239.862 !	
!	21T!	15.730	4.561 !	6382439.270	4826646.149	240.476 !	
!	22T!	15.828	4.634 !	6382439.202	4826646.078	240.549 !	
!	!	!	!	!	!	!	
!	120.000	01T!	-25.000	-9.103 !	6382489.018	4826655.317	225.451 !
!		02T!	-22.904	-9.082 !	6382487.583	4826653.789	225.471 !
!		03T!	-21.974	-9.077 !	6382486.947	4826653.111	225.476 !
!		04T!	-13.917	-8.553 !	6382481.433	4826647.236	226.000 !
!		05T!	-13.489	-8.553 !	6382481.140	4826646.924	226.000 !
!		06T!	-12.771	-8.553 !	6382480.649	4826646.401	226.000 !
!		07T!	-12.451	-8.386 !	6382480.430	4826646.168	226.167 !
!		08T!	-11.925	-7.883 !	6382480.069	4826645.783	226.670 !
!		09T!	-11.607	-7.596 !	6382479.852	4826645.552	226.957 !
!		10T!	-10.839	-7.234 !	6382479.326	4826644.992	227.319 !
!		11T!	-9.368	-6.553 !	6382478.320	4826643.919	228.000 !
!		12T!	-8.845	-6.247 !	6382477.962	4826643.538	228.306 !
!		13T!	-7.691	-5.553 !	6382477.172	4826642.697	229.000 !
!		14T!	-6.955	-5.349 !	6382476.668	4826642.160	229.204 !
!		15T!	-4.362	-4.553 !	6382474.894	4826640.269	230.000 !
!		16T!	-.435	-2.786 !	6382472.206	4826637.405	231.767 !
!		17T!	.624	-2.201 !	6382471.482	4826636.633	232.352 !
!		18T!	4.019	-.979 !	6382469.158	4826634.158	233.574 !
!		19T!	6.909	.106 !	6382467.181	4826632.051	234.659 !
!		20T!	8.089	.562 !	6382466.373	4826631.191	235.115 !
!		21T!	9.872	1.447 !	6382465.153	4826629.890	236.000 !
!		22T!	11.227	2.005 !	6382464.226	4826628.902	236.558 !
!		23T!	13.851	3.176 !	6382462.430	4826626.989	237.729 !
!		24T!	14.536	3.447 !	6382461.961	4826626.490	238.000 !
!		25T!	14.597	3.447 !	6382461.920	4826626.445	238.000 !
!		26T!	14.735	3.447 !	6382461.825	4826626.345	238.000 !
!		27T!	14.878	3.447 !	6382461.727	4826626.240	238.000 !
!		28T!	15.983	4.322 !	6382460.971	4826625.435	238.875 !
!		29T!	16.185	4.471 !	6382460.833	4826625.287	239.024 !
!	!	!	!	!	!	!	
!	150.000	01T!	-25.000	-8.185 !	6382510.892	4826634.787	225.007 !
!		02T!	-18.979	-7.673 !	6382506.772	4826630.397	225.518 !
!		03T!	-13.431	-7.191 !	6382502.975	4826626.352	226.000 !
!		04T!	-13.285	-7.191 !	6382502.875	4826626.245	226.000 !
!		05T!	-12.419	-6.859 !	6382502.282	4826625.613	226.333 !
!		06T!	-11.247	-6.382 !	6382501.480	4826624.759	226.810 !
!		07T!	-8.415	-5.191 !	6382499.543	4826622.694	228.000 !
!		08T!	-4.711	-3.647 !	6382497.008	4826619.993	229.544 !
!		09T!	-3.604	-3.191 !	6382496.250	4826619.186	230.000 !
!		10T!	-2.565	-2.734 !	6382495.539	4826618.428	230.457 !
!		11T!	4.878	.400 !	6382490.445	4826613.001	233.591 !
!		12T!	7.979	1.454 !	6382488.323	4826610.740	234.645 !
!		13T!	9.662	2.086 !	6382487.172	4826609.513	235.278 !
!		14T!	11.450	2.838 !	6382485.948	4826608.209	236.029 !
!		15T!	13.660	3.809 !	6382484.436	4826606.598	237.000 !

ICS	Gradjevinski Fakultet	Page 4
ROAD DESIGN V-3.80	DJIKIC	13/06/17
		11:41:57

PROJECT Name:DJIKIC

Title:

NETWORK Name:OS1

Title:

From Ch.: .000 to Ch.: 488.138

Chainage	no.pts!	Delta X	Z !	X	Y	Z !	
!	16T!	14.072	3.996 !	6382484.154	4826606.298	237.187 !	
!	17T!	16.079	4.809 !	6382482.780	4826604.834	238.000 !	
!	18T!	16.281	4.809 !	6382482.642	4826604.687	238.000 !	
!	19T!	16.313	4.885 !	6382482.620	4826604.663	238.077 !	
!	20T!	16.336	4.921 !	6382482.604	4826604.646	238.113 !	
!	21T!	16.398	4.924 !	6382482.562	4826604.601	238.115 !	
!	!	!	!	!	!	!	
!	180.000	01T!	-25.000	-6.749 !	6382532.767	4826614.257	225.081 !
!		02T!	-16.176	-5.830 !	6382526.729	4826607.823	226.000 !
!		03T!	-16.021	-5.749 !	6382526.623	4826607.710	226.081 !
!		04T!	-14.854	-5.234 !	6382525.824	4826606.859	226.595 !
!		05T!	-10.974	-3.495 !	6382523.168	4826604.029	228.335 !
!		06T!	-9.263	-2.830 !	6382521.998	4826602.782	229.000 !
!		07T!	-7.140	-1.982 !	6382520.545	4826601.234	229.847 !
!		08T!	-6.749	-1.830 !	6382520.277	4826600.949	230.000 !
!		09T!	-6.544	-1.731 !	6382520.137	4826600.800	230.099 !
!		10T!	-2.876	-.071 !	6382517.627	4826598.125	231.758 !
!		11T!	-1.960	.170 !	6382517.000	4826597.457	232.000 !
!		12T!	1.216	1.538 !	6382514.826	4826595.141	233.367 !
!		13T!	1.777	1.863 !	6382514.442	4826594.732	233.693 !
!		14T!	4.312	2.949 !	6382512.708	4826592.884	234.779 !
!		15T!	7.553	4.537 !	6382510.490	4826590.521	236.367 !
!		16T!	8.537	4.837 !	6382509.816	4826589.803	236.667 !
!		17T!	11.916	6.170 !	6382507.504	4826587.339	238.000 !
!		18T!	13.000	6.787 !	6382506.762	4826586.549	238.617 !
!		19T!	13.895	7.483 !	6382506.149	4826585.896	239.313 !
!		20T!	14.320	7.784 !	6382505.859	4826585.586	239.614 !
!		21T!	14.436	7.967 !	6382505.779	4826585.502	239.797 !
!		22T!	15.422	8.010 !	6382505.104	4826584.783	239.839 !
!	!	!	!	!	!	!	
!	210.000	01T!	-25.000	-5.242 !	6382554.642	4826593.726	225.226 !
!		02T!	-19.257	-4.468 !	6382550.712	4826589.539	226.000 !
!		03T!	-18.734	-4.038 !	6382550.353	4826589.157	226.430 !
!		04T!	-15.072	-2.330 !	6382547.848	4826586.487	228.138 !
!		05T!	-13.304	-1.468 !	6382546.638	4826585.198	229.000 !
!		06T!	-12.750	-1.149 !	6382546.259	4826584.794	229.319 !
!		07T!	-11.247	-.468 !	6382545.230	4826583.698	230.000 !
!		08T!	-10.678	-.140 !	6382544.841	4826583.283	230.328 !
!		09T!	-10.124	.532 !	6382544.462	4826582.880	231.000 !
!		10T!	-7.473	1.233 !	6382542.647	4826580.947	231.701 !
!		11T!	-6.654	1.532 !	6382542.087	4826580.349	232.000 !
!		12T!	-5.951	1.831 !	6382541.606	4826579.836	232.299 !
!		13T!	-3.860	2.961 !	6382540.175	4826578.312	233.429 !
!		14T!	-.895	4.212 !	6382538.145	4826576.150	234.680 !
!		15T!	.649	4.949 !	6382537.089	4826575.025	235.416 !
!		16T!	1.403	5.532 !	6382536.573	4826574.475	236.000 !
!		17T!	4.307	6.472 !	6382534.586	4826572.357	236.940 !
!		18T!	4.412	6.532 !	6382534.514	4826572.280	237.000 !
!		19T!	4.530	6.573 !	6382534.433	4826572.194	237.041 !
!		20T!	4.697	6.715 !	6382534.319	4826572.073	237.183 !
!		21T!	7.284	8.532 !	6382532.548	4826570.186	239.000 !

ICS	Gradjevinski Fakultet	Page 5
ROAD DESIGN V-3.80	DJIKIC	13/06/17
		11:41:57

PROJECT Name:DJIKIC

Title:

NETWORK Name:OS1

Title:

From Ch.: .000 to Ch.: 488.138

Chainage	no.pts!	Delta X	Z	X	Y	Z	
!	22T!	9.159	9.196	6382531.265	4826568.819	239.664	
!	23T!	9.969	9.532	6382530.711	4826568.228	240.000	
!	24T!	10.030	9.532	6382530.669	4826568.184	240.000	
!	25T!	12.714	10.709	6382528.833	4826566.227	241.176	
!	26T!	13.426	10.901	6382528.345	4826565.708	241.369	
!	27T!	14.201	11.084	6382527.815	4826565.143	241.552	
!	28T!	14.446	11.095	6382527.647	4826564.964	241.563	
!	!	!	!	!	!	!	
!	240.000	01T!	-25.000	-3.860	6382571.691	4826579.396	225.246
!		02T!	-22.995	-3.106	6382570.824	4826577.588	226.000
!		03T!	-16.146	-1.251	6382567.862	4826571.413	227.855
!		04T!	-15.883	-1.178	6382567.748	4826571.176	227.928
!		05T!	-15.720	-1.106	6382567.677	4826571.029	228.000
!		06T!	-15.269	-.944	6382567.482	4826570.622	228.162
!		07T!	-11.932	.632	6382566.039	4826567.614	229.738
!		08T!	-10.878	1.240	6382565.583	4826566.663	230.346
!		09T!	-9.693	1.894	6382565.071	4826565.595	231.000
!		10T!	-6.831	2.910	6382563.833	4826563.014	232.016
!		11T!	-4.834	3.555	6382562.969	4826561.213	232.661
!		12T!	-4.061	3.758	6382562.635	4826560.517	232.864
!		13T!	-3.409	4.076	6382562.353	4826559.929	233.182
!		14T!	-1.672	4.724	6382561.602	4826558.363	233.830
!		15T!	.497	5.603	6382560.664	4826556.407	234.709
!		16T!	2.266	6.396	6382559.899	4826554.812	235.502
!		17T!	3.954	7.334	6382559.169	4826553.290	236.440
!		18T!	4.609	7.744	6382558.886	4826552.700	236.850
!		19T!	5.598	8.350	6382558.458	4826551.808	237.456
!		20T!	6.724	9.485	6382557.971	4826550.793	238.591
!		21T!	7.000	9.894	6382557.851	4826550.543	239.000
!		22T!	8.713	10.353	6382557.110	4826548.999	239.459
!		23T!	10.609	10.894	6382556.291	4826547.290	240.000
!		24T!	11.674	11.665	6382555.830	4826546.330	240.772
!		25T!	13.148	12.206	6382555.192	4826545.000	241.313
!		26T!	15.605	12.894	6382554.130	4826542.785	242.000
!		27T!	15.971	12.894	6382553.972	4826542.455	242.000
!		28T!	16.587	12.894	6382553.705	4826541.899	242.000
!		29T!	16.707	12.894	6382553.653	4826541.791	242.000
!	!	!	!	!	!	!	
!	270.000	01T!	-25.000	-3.792	6382577.032	4826579.322	223.953
!		02T!	-24.748	-3.744	6382577.159	4826579.104	224.000
!		03T!	-24.726	-3.740	6382577.170	4826579.085	224.004
!		04T!	-20.575	-3.371	6382579.265	4826575.503	224.373
!		05T!	-19.529	-3.193	6382579.793	4826574.599	224.552
!		06T!	-18.952	-3.197	6382580.085	4826574.101	224.548
!		07T!	-14.941	-3.045	6382582.110	4826570.638	224.699
!		08T!	-13.667	-3.064	6382582.753	4826569.539	224.680
!		09T!	-12.658	-2.996	6382583.262	4826568.668	224.748
!		10T!	-9.635	-2.744	6382584.788	4826566.059	225.000
!		11T!	-9.149	-2.697	6382585.034	4826565.639	225.048
!		12T!	-7.723	-2.297	6382585.754	4826564.408	225.448
!		13T!	-5.595	-2.216	6382586.828	4826562.571	225.528

ICS	Gradjevinski Fakultet	Page 6
ROAD DESIGN V-3.80	DJIKIC	13/06/17
		11:41:57

PROJECT Name:DJIKIC

Title:

NETWORK Name:OS1

Title:

From Ch.: .000 to Ch.: 488.138

Chainage	no.pts!	Delta X	Z !	X	Y	Z	!	
!	14T!	-3.864	-1.744 !	6382587.702	4826561.077	226.000	!	
!	15T!	-3.437	-1.744 !	6382587.917	4826560.708	226.000	!	
!	16T!	-1.867	-1.330 !	6382588.710	4826559.353	226.414	!	
!	17T!	-1.239	-1.409 !	6382589.027	4826558.811	226.335	!	
!	18T!	.243	-1.744 !	6382589.775	4826557.532	226.000	!	
!	19T!	1.264	-2.100 !	6382590.290	4826556.651	225.644	!	
!	20T!	1.947	-2.032 !	6382590.635	4826556.061	225.713	!	
!	21T!	2.384	-2.029 !	6382590.856	4826555.684	225.715	!	
!	22T!	3.361	-1.752 !	6382591.349	4826554.840	225.993	!	
!	23T!	3.368	-1.750 !	6382591.353	4826554.834	225.994	!	
!	24T!	3.376	-1.744 !	6382591.357	4826554.827	226.000	!	
!	25T!	3.489	-1.720 !	6382591.413	4826554.730	226.025	!	
!	26T!	7.792	-.744 !	6382593.586	4826551.015	227.000	!	
!	27T!	8.403	-.744 !	6382593.894	4826550.488	227.000	!	
!	28T!	8.562	-.574 !	6382593.975	4826550.351	227.170	!	
!	29T!	9.573	.256 !	6382594.485	4826549.478	228.000	!	
!	30T!	11.725	1.162 !	6382595.571	4826547.620	228.906	!	
!	31T!	11.923	1.256 !	6382595.671	4826547.449	229.000	!	
!	32T!	12.003	1.280 !	6382595.712	4826547.380	229.024	!	
!	33T!	14.480	2.256 !	6382596.962	4826545.242	230.000	!	
!	34T!	23.939	4.196 !	6382601.737	4826537.077	231.940	!	
!	35T!	24.174	4.243 !	6382601.856	4826536.873	231.988	!	
!	36T!	24.214	4.249 !	6382601.876	4826536.840	231.993	!	
!	37T!	24.234	4.256 !	6382601.886	4826536.822	232.000	!	
!	38T!	24.789	4.404 !	6382602.167	4826536.343	232.148	!	
!	39T!	25.000	4.461 !	6382602.273	4826536.161	232.205	!	
!	!	!	!	!	!	!	!	
!	300.000	01T!	-25.000	-6.384 !	6382582.713	4826589.622	220.000	!
!		02T!	-24.595	-6.384 !	6382583.098	4826589.494	220.000	!
!		03T!	-23.016	-6.384 !	6382584.596	4826588.998	220.000	!
!		04T!	-19.211	-6.384 !	6382588.208	4826587.801	220.000	!
!		05T!	-19.037	-6.384 !	6382588.373	4826587.746	220.000	!
!		06T!	-18.775	-6.384 !	6382588.622	4826587.664	220.000	!
!		07T!	-18.566	-6.327 !	6382588.820	4826587.598	220.057	!
!		08T!	-15.062	-5.384 !	6382592.147	4826586.496	221.000	!
!		09T!	-13.487	-4.725 !	6382593.641	4826586.000	221.659	!
!		10T!	-10.310	-3.390 !	6382596.657	4826585.001	222.994	!
!		11T!	-10.297	-3.384 !	6382596.670	4826584.997	223.000	!
!		12T!	-10.286	-3.380 !	6382596.680	4826584.993	223.004	!
!		13T!	-7.630	-2.384 !	6382599.201	4826584.158	224.000	!
!		14T!	-6.581	-1.872 !	6382600.198	4826583.828	224.512	!
!		15T!	-5.593	-1.206 !	6382601.135	4826583.517	225.178	!
!		16T!	-3.535	.063 !	6382603.089	4826582.870	226.447	!
!		17T!	.852	2.365 !	6382607.253	4826581.490	228.749	!
!		18T!	1.199	2.551 !	6382607.582	4826581.381	228.935	!
!		19T!	1.321	2.616 !	6382607.698	4826581.342	229.000	!
!		20T!	1.449	2.700 !	6382607.819	4826581.302	229.084	!
!		21T!	5.049	4.616 !	6382611.237	4826580.170	231.000	!
!		22T!	6.106	5.233 !	6382612.240	4826579.837	231.617	!
!		23T!	7.069	5.616 !	6382613.154	4826579.534	232.000	!
!		24T!	9.043	7.107 !	6382615.028	4826578.913	233.491	!

ICS	Gradjevinski Fakultet	Page 7
ROAD DESIGN V-3.80	DJIKIC	13/06/17
		11:41:57

PROJECT Name:DJIKIC

Title:

NETWORK Name:OS1

Title:

From Ch.: .000 to Ch.: 488.138

Chainage	no.pts!	Delta X	Z !	X	Y	Z	!
!	25T!	9.626	7.616 !	6382615.581	4826578.730	234.000	!
!	26T!	10.551	7.917 !	6382616.460	4826578.439	234.301	!
!	27T!	12.342	8.616 !	6382618.160	4826577.876	235.000	!
!	28T!	13.204	9.062 !	6382618.978	4826577.605	235.445	!
!	29T!	15.599	10.291 !	6382621.252	4826576.851	236.675	!
!	30T!	17.829	11.315 !	6382623.368	4826576.150	237.699	!
!	31T!	18.629	11.616 !	6382624.127	4826575.898	238.000	!
!	32T!	19.010	11.789 !	6382624.489	4826575.778	238.173	!
!	33T!	20.667	12.268 !	6382626.062	4826575.257	238.651	!
!	34T!	21.395	11.953 !	6382626.754	4826575.028	238.337	!
!	35T!	22.657	11.878 !	6382627.952	4826574.631	238.262	!
!	36T!	23.163	11.393 !	6382628.432	4826574.472	237.777	!
!	37T!	25.000	10.645 !	6382630.175	4826573.894	237.029	!
!	!	!	!	!	!	!	!
!	330.000	01T!	-25.000	-4.433 !	6382591.064	4826617.595	220.928 !
!		02T!	-24.923	-4.387 !	6382591.138	4826617.574	220.974 !
!		03T!	-24.017	-3.839 !	6382592.006	4826617.317	221.522 !
!		04T!	-22.365	-2.986 !	6382593.591	4826616.848	222.375 !
!		05T!	-17.749	-1.142 !	6382598.017	4826615.538	224.219 !
!		06T!	-16.694	-.748 !	6382599.029	4826615.238	224.614 !
!		07T!	-15.322	.024 !	6382600.344	4826614.849	225.385 !
!		08T!	-14.096	.639 !	6382601.520	4826614.501	226.000 !
!		09T!	-11.449	1.382 !	6382604.058	4826613.750	226.744 !
!		10T!	-10.641	1.639 !	6382604.833	4826613.520	227.000 !
!		11T!	-9.234	2.137 !	6382606.182	4826613.121	227.498 !
!		12T!	-6.237	3.621 !	6382609.056	4826612.270	228.983 !
!		13T!	-6.214	3.635 !	6382609.078	4826612.264	228.996 !
!		14T!	-2.720	4.625 !	6382612.428	4826611.272	229.987 !
!		15T!	-2.666	4.646 !	6382612.480	4826611.257	230.008 !
!		16T!	-.037	5.639 !	6382615.001	4826610.511	231.000 !
!		17T!	.839	5.870 !	6382615.841	4826610.262	231.231 !
!		18T!	8.092	7.639 !	6382622.796	4826608.204	233.000 !
!		19T!	11.873	9.317 !	6382626.421	4826607.131	234.678 !
!		20T!	12.753	9.639 !	6382627.265	4826606.881	235.000 !
!		21T!	14.681	10.114 !	6382629.113	4826606.334	235.476 !
!		22T!	19.973	11.432 !	6382634.188	4826604.832	236.793 !
!		23T!	21.167	11.639 !	6382635.333	4826604.493	237.000 !
!		24T!	24.278	12.601 !	6382638.316	4826603.610	237.963 !
!		25T!	24.545	12.677 !	6382638.572	4826603.534	238.038 !
!		26T!	24.958	12.797 !	6382638.968	4826603.417	238.158 !
!		27T!	25.000	12.809 !	6382639.008	4826603.405	238.170 !
!	!	!	!	!	!	!	!
!	360.000	01T!	-25.000	-4.342 !	6382599.578	4826646.362	220.597 !
!		02T!	-23.830	-3.939 !	6382600.701	4826646.030	221.000 !
!		03T!	-22.239	-3.356 !	6382602.226	4826645.578	221.583 !
!		04T!	-18.622	-2.410 !	6382605.694	4826644.552	222.530 !
!		05T!	-15.133	-1.726 !	6382609.039	4826643.562	223.213 !
!		06T!	-11.400	-.939 !	6382612.619	4826642.502	224.000 !
!		07T!	-7.077	.352 !	6382616.764	4826641.276	225.292 !
!		08T!	-.915	1.772 !	6382622.673	4826639.527	226.711 !
!		09T!	-.195	1.982 !	6382623.364	4826639.322	226.922 !

ICS	Gradjevinski Fakultet	Page 8
ROAD DESIGN V-3.80	DJIKIC	13/06/17
		11:41:57

PROJECT Name:DJIKIC

Title:

NETWORK Name:OS1

Title:

From Ch.: .000 to Ch.: 488.138

Chainage	no.pts!	Delta X	Z	X	Y	Z
!	10T!	.251	2.061	6382623.791	4826639.196	227.000
!	11T!	.586	2.197	6382624.112	4826639.101	227.137
!	12T!	2.426	2.827	6382625.876	4826638.579	227.767
!	13T!	8.780	5.061	6382631.970	4826636.775	230.000
!	14T!	9.600	5.428	6382632.756	4826636.542	230.367
!	15T!	10.626	6.061	6382633.740	4826636.251	231.000
!	16T!	11.904	6.584	6382634.965	4826635.889	231.523
!	17T!	13.133	7.061	6382636.144	4826635.540	232.000
!	18T!	15.494	8.080	6382638.407	4826634.870	233.019
!	19T!	21.748	10.367	6382644.404	4826633.095	235.307
!	20T!	22.767	10.753	6382645.382	4826632.806	235.692
!	21T!	23.031	10.854	6382645.634	4826632.731	235.793
!	22T!	23.162	10.909	6382645.760	4826632.694	235.848
!	23T!	23.335	10.961	6382645.926	4826632.644	235.900
!	24T!	23.494	10.989	6382646.078	4826632.599	235.928
!	25T!	23.512	10.992	6382646.095	4826632.594	235.931
!	26T!	25.000	11.035	6382647.522	4826632.172	235.974
!	!	!	!	!	!	!
!	390.000	01T!	-25.000	6382609.076	4826676.634	220.461
!		02T!	-16.558	6382616.985	4826673.683	220.000
!		03T!	-15.585	6382617.897	4826673.343	220.000
!		04T!	-12.474	6382620.812	4826672.256	221.655
!		05T!	-12.259	6382621.013	4826672.180	221.819
!		06T!	-8.824	6382624.231	4826670.980	222.658
!		07T!	-8.138	6382624.874	4826670.740	222.850
!		08T!	-7.585	6382625.392	4826670.547	223.000
!		09T!	-6.016	6382626.862	4826669.998	223.293
!		10T!	.742	6382633.194	4826667.636	224.701
!		11T!	1.539	6382633.940	4826667.357	225.000
!		12T!	3.704	6382635.968	4826666.600	225.922
!		13T!	5.861	6382637.990	4826665.846	227.000
!		14T!	7.182	6382639.227	4826665.385	227.764
!		15T!	8.089	6382640.077	4826665.068	228.223
!		16T!	12.399	6382644.115	4826663.561	229.784
!		17T!	13.037	6382644.713	4826663.338	230.000
!		18T!	18.059	6382649.418	4826661.582	231.553
!		19T!	19.009	6382650.308	4826661.250	231.835
!		20T!	19.553	6382650.818	4826661.060	232.000
!		21T!	20.523	6382651.727	4826660.721	232.000
!		22T!	23.064	6382654.107	4826659.833	232.786
!		23T!	25.000	6382655.921	4826659.156	233.143
!	!	!	!	!	!	!
!	420.000	01T!	-25.000	6382628.254	4826710.205	220.605
!		02T!	-17.594	6382633.860	4826705.366	220.230
!		03T!	-13.570	6382636.906	4826702.736	220.000
!		04T!	-13.234	6382637.160	4826702.517	220.207
!		05T!	-12.738	6382637.535	4826702.192	220.510
!		06T!	-11.284	6382638.636	4826701.242	221.267
!		07T!	-9.651	6382639.872	4826700.175	222.000
!		08T!	-8.376	6382640.837	4826699.342	222.667
!		09T!	-7.640	6382641.394	4826698.861	223.000

ICS	Gradjevinski Fakultet	Page 9
ROAD DESIGN V-3.80	DJIKIC	13/06/17
		11:41:57

PROJECT Name:DJIKIC

Title:

NETWORK Name:OS1

Title:

From Ch.: .000 to Ch.: 488.138

Chainage	no.pts!	Delta X	Z !	X	Y	Z	!
!	10T!	-6.735	-2.077 !	6382642.080	4826698.269	223.287	!
!	11T!	-3.195	-.840 !	6382644.759	4826695.957	224.524	!
!	12T!	-1.482	-.364 !	6382646.056	4826694.837	225.000	!
!	13T!	1.407	.520 !	6382648.242	4826692.949	225.884	!
!	14T!	1.797	.636 !	6382648.537	4826692.695	226.000	!
!	15T!	2.482	.835 !	6382649.056	4826692.247	226.200	!
!	16T!	5.618	1.636 !	6382651.430	4826690.197	227.000	!
!	17T!	7.962	2.183 !	6382653.204	4826688.665	227.548	!
!	18T!	9.928	2.636 !	6382654.693	4826687.381	228.000	!
!	19T!	12.481	3.381 !	6382656.625	4826685.713	228.746	!
!	20T!	15.861	4.636 !	6382659.183	4826683.504	230.000	!
!	21T!	17.081	4.910 !	6382660.107	4826682.706	230.274	!
!	22T!	20.220	5.636 !	6382662.483	4826680.655	231.000	!
!	23T!	23.291	6.281 !	6382664.808	4826678.649	231.646	!
!	24T!	24.507	6.477 !	6382665.728	4826677.854	231.841	!
!	25T!	25.000	6.548 !	6382666.101	4826677.532	231.912	!
!	!	!	!	!	!	!	!
!	450.000	01T!	-25.000	-4.964 !	6382660.241	4826734.370	220.680 !
!		02T!	-18.967	-5.644 !	6382662.829	4826728.919	220.000 !
!		03T!	-18.819	-5.644 !	6382662.892	4826728.785	220.000 !
!		04T!	-17.100	-5.036 !	6382663.629	4826727.233	220.608 !
!		05T!	-14.670	-4.005 !	6382664.671	4826725.037	221.639 !
!		06T!	-12.459	-3.296 !	6382665.619	4826723.040	222.348 !
!		07T!	-7.427	-1.681 !	6382667.777	4826718.494	223.963 !
!		08T!	-7.322	-1.644 !	6382667.822	4826718.399	224.000 !
!		09T!	-7.295	-1.636 !	6382667.834	4826718.375	224.008 !
!		10T!	-4.358	-.644 !	6382669.093	4826715.722	225.000 !
!		11T!	-1.616	.250 !	6382670.269	4826713.245	225.894 !
!		12T!	-1.012	.356 !	6382670.528	4826712.700	226.000 !
!		13T!	-.820	.450 !	6382670.610	4826712.526	226.094 !
!		14T!	.037	.739 !	6382670.978	4826711.752	226.383 !
!		15T!	1.628	1.228 !	6382671.660	4826710.314	226.872 !
!		16T!	1.945	1.356 !	6382671.796	4826710.028	227.000 !
!		17T!	2.533	1.500 !	6382672.048	4826709.497	227.145 !
!		18T!	6.772	2.831 !	6382673.866	4826705.667	228.475 !
!		19T!	8.506	3.356 !	6382674.610	4826704.101	229.000 !
!		20T!	13.188	4.340 !	6382676.618	4826699.871	229.984 !
!		21T!	13.268	4.356 !	6382676.652	4826699.799	230.000 !
!		22T!	13.355	4.373 !	6382676.689	4826699.720	230.017 !
!		23T!	19.372	5.356 !	6382679.269	4826694.285	231.000 !
!		24T!	22.245	6.033 !	6382680.501	4826691.689	231.678 !
!		25T!	23.722	6.356 !	6382681.135	4826690.355	232.000 !
!		26T!	23.917	6.356 !	6382681.218	4826690.179	232.000 !
!		27T!	24.701	6.356 !	6382681.554	4826689.471	232.000 !
!		28T!	25.000	6.356 !	6382681.683	4826689.200	232.000 !
!		!	!	!	!	!	!

ICS
ROAD DESIGN V-3.80

Gradjevinski Fakultet
DJIKIC

Page 10
13/06/17
11:41:57

PROJECT Name:DJIKIC

Title:

NETWORK Name:OS1

Title:

From Ch.: .000 to Ch.: 488.138

Chainage	no.pts!	Delta X	Z	X	Y	Z
480.000	01T!	-20.273	-5.924	6382693.967	4826741.001	220.000
	02T!	-19.449	-5.924	6382694.185	4826740.207	220.000
	03T!	-19.291	-5.790	6382694.227	4826740.054	220.134
	04T!	-18.354	-4.924	6382694.474	4826739.150	221.000
	05T!	-15.633	-4.297	6382695.192	4826736.526	221.627
	06T!	-14.056	-3.924	6382695.609	4826735.005	222.000
	07T!	-13.740	-3.860	6382695.692	4826734.700	222.064
	08T!	-12.006	-3.220	6382696.150	4826733.027	222.704
	09T!	-8.644	-1.924	6382697.038	4826729.785	224.000
	10T!	-7.993	-1.626	6382697.210	4826729.157	224.298
	11T!	-7.093	-.924	6382697.447	4826728.289	225.000
	12T!	-5.792	-.510	6382697.791	4826727.034	225.414
	13T!	-4.103	.076	6382698.237	4826725.405	226.000
	14T!	-2.955	.447	6382698.540	4826724.298	226.371
	15T!	-.365	1.076	6382699.224	4826721.800	227.000
	16T!	3.901	2.008	6382700.350	4826717.685	227.932
	17T!	4.268	2.076	6382700.447	4826717.332	228.000
	18T!	5.225	2.257	6382700.700	4826716.408	228.181
	19T!	9.318	3.076	6382701.780	4826712.461	229.000
	20T!	10.838	3.421	6382702.182	4826710.994	229.345
	21T!	14.826	4.417	6382703.235	4826707.148	230.341
	22T!	17.755	5.076	6382704.008	4826704.323	231.000
	23T!	18.052	5.148	6382704.087	4826704.036	231.072
	24T!	21.726	6.076	6382705.057	4826700.493	232.000
	25T!	21.941	6.076	6382705.113	4826700.285	232.000
	26T!	22.136	6.076	6382705.165	4826700.097	232.000
	27T!	22.306	6.076	6382705.210	4826699.934	232.000
	28T!	24.945	6.076	6382705.907	4826697.388	232.000
	29T!	25.000	6.076	6382705.921	4826697.335	232.000
	!	!	!	!	!	!
488.138	01T!	-19.621	-6.000	6382701.996	4826742.520	220.000
	02T!	-19.545	-6.000	6382702.016	4826742.448	220.000
	03T!	-19.396	-5.887	6382702.056	4826742.303	220.113
	04T!	-18.994	-5.799	6382702.161	4826741.916	220.201
	05T!	-17.989	-5.542	6382702.427	4826740.946	220.458
	06T!	-16.104	-5.000	6382702.924	4826739.128	221.000
	07T!	-13.353	-4.181	6382703.649	4826736.474	221.819
	08T!	-12.673	-4.000	6382703.828	4826735.819	222.000
	09T!	-11.100	-3.184	6382704.243	4826734.301	222.816
	10T!	-10.543	-3.000	6382704.390	4826733.764	223.000
	11T!	-8.207	-2.390	6382705.006	4826731.510	223.610
	12T!	-6.627	-2.000	6382705.423	4826729.986	224.000
	13T!	-6.141	-1.777	6382705.551	4826729.518	224.223
	14T!	-3.844	-1.000	6382706.156	4826727.302	225.000
	15T!	-2.728	-.596	6382706.451	4826726.225	225.404
	16T!	-1.459	-.315	6382706.785	4826725.001	225.685
	17T!	-.785	-.119	6382706.963	4826724.351	225.881
	18T!	-.059	.000	6382707.154	4826723.651	226.000
	19T!	4.997	.957	6382708.488	4826718.774	226.957
	20T!	5.147	1.000	6382708.527	4826718.629	227.000
	21T!	9.113	2.135	6382709.573	4826714.803	228.135

10. RAČUNALNI ISPIS VOLUMENA

10. ISPIS VOLUMENA

ICS	Gradjevinski Fakultet	Page 1
ROAD DESIGN V-3.80	DJIKIC	13/06/17
Volume calculation results		11:44:31

+-----+
(TS = top soil, EW = earthworks)

Section:	Ch:	.000 (m)	
TS stripped=	-6.023 (m2)	Infrastructure =	2.726 (m2)
TS filling =	4.103 (m2)	EW cutting =	-5.922 (m2)
	.000	EW filling =	12.827 (m2)
TS balance =	-1.920 (m2)	EW balance =	6.905 (m2)

Volume between sections: .000 30.000 30.000 (m)

TS stripped=	-178.232 (m3)	Infrastructure =	81.768 (m3)
TS filling =	120.629 (m3)	EW cutting =	-119.791 (m3)
	.000	EW filling =	494.261 (m3)
TS balance =	-57.603 (m3)	EW balance =	374.470 (m3)

Section:	Ch:	30.000 (m)	
----------	-----	------------	--

TS stripped=	-5.860 (m2)	Infrastructure =	2.726 (m2)
TS filling =	3.940 (m2)	EW cutting =	-2.337 (m2)
	.000	EW filling =	20.416 (m2)
TS balance =	-1.920 (m2)	EW balance =	18.079 (m2)

Volume between sections: 30.000 60.000 30.000 (m)

TS stripped=	-179.848 (m3)	Infrastructure =	81.768 (m3)
TS filling =	122.241 (m3)	EW cutting =	-24.779 (m3)
	.000	EW filling =	859.522 (m3)
TS balance =	-57.607 (m3)	EW balance =	834.743 (m3)

Section:	Ch:	60.000 (m)	
----------	-----	------------	--

TS stripped=	-6.131 (m2)	Infrastructure =	2.726 (m2)
TS filling =	4.211 (m2)	EW cutting =	-.008 (m2)
	.000	EW filling =	37.767 (m2)
TS balance =	-1.920 (m2)	EW balance =	37.760 (m2)

Volume between sections: 60.000 90.000 30.000 (m)

TS stripped=	-207.731 (m3)	Infrastructure =	81.768 (m3)
TS filling =	149.948 (m3)	EW cutting =	-.076 (m3)
	.000	EW filling =	1509.420 (m3)
TS balance =	-57.783 (m3)	EW balance =	1509.344 (m3)

Section:	Ch:	90.000 (m)	
----------	-----	------------	--

TS stripped=	-7.749 (m2)	Infrastructure =	2.726 (m2)
TS filling =	5.829 (m2)	EW cutting =	.000 (m2)
	.000	EW filling =	64.007 (m2)
TS balance =	-1.920 (m2)	EW balance =	64.007 (m2)

-----+
 (TS = top soil, EW = earthworks)

Volume between sections:	90.000	120.000	30.000 (m)
TS stripped=	-225.144 (m3)	Infrastructure =	81.768 (m3)
TS filling =	167.531 (m3)	EW cutting =	.000 (m3)
	.000	EW filling =	1791.353 (m3)
TS balance =	-57.614 (m3)	EW balance =	1791.353 (m3)
Section:	Ch:	120.000 (m)	
TS stripped=	-7.263 (m2)	Infrastructure =	2.726 (m2)
TS filling =	5.343 (m2)	EW cutting =	.000 (m2)
	.000	EW filling =	55.517 (m2)
TS balance =	-1.920 (m2)	EW balance =	55.517 (m2)
Volume between sections:	120.000	150.000	30.000 (m)
TS stripped=	-194.906 (m3)	Infrastructure =	81.768 (m3)
TS filling =	137.122 (m3)	EW cutting =	-.169 (m3)
	.000	EW filling =	1322.437 (m3)
TS balance =	-57.784 (m3)	EW balance =	1322.268 (m3)
Section:	Ch:	150.000 (m)	
TS stripped=	-5.759 (m2)	Infrastructure =	2.726 (m2)
TS filling =	3.839 (m2)	EW cutting =	-.017 (m2)
	.000	EW filling =	33.562 (m2)
TS balance =	-1.920 (m2)	EW balance =	33.545 (m2)
Volume between sections:	150.000	180.000	30.000 (m)
TS stripped=	-143.241 (m3)	Infrastructure =	81.768 (m3)
TS filling =	84.977 (m3)	EW cutting =	-132.673 (m3)
	.000	EW filling =	401.328 (m3)
TS balance =	-58.264 (m3)	EW balance =	268.655 (m3)
Section:	Ch:	180.000 (m)	
TS stripped=	-3.854 (m2)	Infrastructure =	2.726 (m2)
TS filling =	1.934 (m2)	EW cutting =	-12.786 (m2)
	.000	EW filling =	.944 (m2)
TS balance =	-1.920 (m2)	EW balance =	-11.842 (m2)
Volume between sections:	180.000	210.000	30.000 (m)
TS stripped=	-120.927 (m3)	Infrastructure =	81.684 (m3)
TS filling =	63.291 (m3)	EW cutting =	-965.976 (m3)
	.000	EW filling =	9.436 (m3)
TS balance =	-57.636 (m3)	EW balance =	-956.540 (m3)
Section:	Ch:	210.000 (m)	
TS stripped=	-4.211 (m2)	Infrastructure =	2.720 (m2)
TS filling =	2.291 (m2)	EW cutting =	-56.851 (m2)
	.000	EW filling =	.000 (m2)
TS balance =	-1.920 (m2)	EW balance =	-56.851 (m2)

-----+
 (TS = top soil, EW = earthworks)

Volume between sections: 210.000 240.000 30.000 (m)

TS stripped=	-132.046 (m3)	Infrastructure =	81.600 (m3)
TS filling =	74.414 (m3)	EW cutting =	-1909.138 (m3)
	.000	EW filling =	.000 (m3)
TS balance =	-57.632 (m3)	EW balance =	-1909.138 (m3)

Section: Ch: 240.000 (m)

TS stripped=	-4.595 (m2)	Infrastructure =	2.720 (m2)
TS filling =	2.675 (m2)	EW cutting =	-70.676 (m2)
	.000	EW filling =	.000 (m2)
TS balance =	-1.920 (m2)	EW balance =	-70.676 (m2)

Volume between sections: 240.000 270.000 30.000 (m)

TS stripped=	-142.636 (m3)	Infrastructure =	81.818 (m3)
TS filling =	85.017 (m3)	EW cutting =	-706.756 (m3)
	.000	EW filling =	214.117 (m3)
TS balance =	-57.618 (m3)	EW balance =	-492.639 (m3)

Section: Ch: 270.000 (m)

TS stripped=	-4.916 (m2)	Infrastructure =	2.735 (m2)
TS filling =	2.996 (m2)	EW cutting =	.000 (m2)
	.000	EW filling =	21.412 (m2)
TS balance =	-1.920 (m2)	EW balance =	21.412 (m2)

Volume between sections: 270.000 300.000 30.000 (m)

TS stripped=	-137.456 (m3)	Infrastructure =	81.928 (m3)
TS filling =	79.770 (m3)	EW cutting =	-227.473 (m3)
	.000	EW filling =	246.012 (m3)
TS balance =	-57.686 (m3)	EW balance =	18.539 (m3)

Section: Ch: 300.000 (m)

TS stripped=	-4.256 (m2)	Infrastructure =	2.727 (m2)
TS filling =	2.336 (m2)	EW cutting =	-22.747 (m2)
	.000	EW filling =	.371 (m2)
TS balance =	-1.920 (m2)	EW balance =	-22.376 (m2)

Volume between sections: 300.000 330.000 30.000 (m)

TS stripped=	-127.200 (m3)	Infrastructure =	81.710 (m3)
TS filling =	69.600 (m3)	EW cutting =	-1248.759 (m3)
	.000	EW filling =	3.710 (m3)
TS balance =	-57.600 (m3)	EW balance =	-1245.049 (m3)

Section: Ch: 330.000 (m)

TS stripped=	-4.224 (m2)	Infrastructure =	2.720 (m2)
TS filling =	2.304 (m2)	EW cutting =	-63.979 (m2)
	.000	EW filling =	.000 (m2)
TS balance =	-1.920 (m2)	EW balance =	-63.979 (m2)

-----+
 (TS = top soil, EW = earthworks)

Volume between sections: 330.000 360.000 30.000 (m)

TS stripped=	-127.661 (m3)	Infrastructure =	81.600 (m3)
TS filling =	70.060 (m3)	EW cutting =	-1278.258 (m3)
	.000	EW filling =	.000 (m3)
TS balance =	-57.601 (m3)	EW balance =	-1278.258 (m3)

Section: Ch: 360.000 (m)

TS stripped=	-4.287 (m2)	Infrastructure =	2.720 (m2)
TS filling =	2.367 (m2)	EW cutting =	-24.364 (m2)
	.000	EW filling =	.000 (m2)
TS balance =	-1.920 (m2)	EW balance =	-24.364 (m2)

Volume between sections: 360.000 390.000 30.000 (m)

TS stripped=	-118.869 (m3)	Infrastructure =	81.629 (m3)
TS filling =	61.146 (m3)	EW cutting =	-335.544 (m3)
	.000	EW filling =	62.399 (m3)
TS balance =	-57.722 (m3)	EW balance =	-273.145 (m3)

Section: Ch: 390.000 (m)

TS stripped=	-3.647 (m2)	Infrastructure =	2.722 (m2)
TS filling =	1.727 (m2)	EW cutting =	-2.077 (m2)
	.000	EW filling =	6.240 (m2)
TS balance =	-1.920 (m2)	EW balance =	4.163 (m2)

Volume between sections: 390.000 420.000 30.000 (m)

TS stripped=	-115.110 (m3)	Infrastructure =	81.631 (m3)
TS filling =	57.462 (m3)	EW cutting =	-95.609 (m3)
	.000	EW filling =	166.551 (m3)
TS balance =	-57.648 (m3)	EW balance =	70.941 (m3)

Section: Ch: 420.000 (m)

TS stripped=	-4.031 (m2)	Infrastructure =	2.720 (m2)
TS filling =	2.111 (m2)	EW cutting =	-4.446 (m2)
	.000	EW filling =	4.891 (m2)
TS balance =	-1.920 (m2)	EW balance =	.445 (m2)

Volume between sections: 420.000 450.000 30.000 (m)

TS stripped=	-113.249 (m3)	Infrastructure =	81.607 (m3)
TS filling =	55.561 (m3)	EW cutting =	-196.965 (m3)
	.000	EW filling =	87.084 (m3)
TS balance =	-57.688 (m3)	EW balance =	-109.881 (m3)

Section: Ch: 450.000 (m)

TS stripped=	-3.525 (m2)	Infrastructure =	2.720 (m2)
TS filling =	1.605 (m2)	EW cutting =	-8.945 (m2)
	.000	EW filling =	1.298 (m2)
TS balance =	-1.920 (m2)	EW balance =	-7.647 (m2)

+-----+

(TS = top soil, EW = earthworks)

Volume between sections:	450.000	480.000	30.000 (m)
TS stripped=	-95.952 (m3)	Infrastructure =	81.603 (m3)
TS filling =	38.105 (m3)	EW cutting =	-307.658 (m3)
	.000	EW filling =	12.980 (m3)
TS balance =	-57.847 (m3)	EW balance =	-294.678 (m3)
Section:	Ch:	480.000 (m)	
TS stripped=	-2.882 (m2)	Infrastructure =	2.720 (m2)
TS filling =	.962 (m2)	EW cutting =	-11.624 (m2)
	.000	EW filling =	.000 (m2)
TS balance =	-1.920 (m2)	EW balance =	-11.624 (m2)
Volume between sections:	480.000	488.138	8.138 (m)
TS stripped=	-26.696 (m3)	Infrastructure =	22.139 (m3)
TS filling =	10.972 (m3)	EW cutting =	-53.636 (m3)
	.000	EW filling =	10.641 (m3)
TS balance =	-15.724 (m3)	EW balance =	-42.995 (m3)
Section:	Ch:	488.138 (m)	
TS stripped=	-3.695 (m2)	Infrastructure =	2.721 (m2)
TS filling =	1.775 (m2)	EW cutting =	-2.625 (m2)
	.000	EW filling =	3.923 (m2)
TS balance =	-1.920 (m2)	EW balance =	1.298 (m2)
Volume between sections:	.000	488.138	488.138 (m)
TS stripped=	-2386.905 (m3)	Infrastructure =	1329.56 (m3)
TS filling =	1447.846 (m3)	EW cutting =	-7603.259 (m3)
	.000	EW filling =	7191.25 (m3)
TS balance =	-939.059 (m3)	EW balance =	-412.009 (m3)

11. APROKSIMATIVNI TROŠKOVNIK

BROJ STAVKE	OPIS RADOVA	JED. MJERE	KOLIČINA RADOVA	JEDINIČNA CIJENA	UKUPNA CIJENA
----------------	----------------	---------------	--------------------	---------------------	------------------

1. PRIPREMNI RADOVI

1.1	Geodetski radovi. Radovi obuhvaćaju sva potrebna geodetska mjerenja, kojima se podaci sa projekta prenose na teren, osiguranje osi trase i stalnih visinskih točaka, obnavljanje i održavanje oznaka na terenu za vrijeme građenja odnosno predaje radova. Radovi se izvode u skladu sa O.T.U. 1-02. Obračun se vrši po kilometru trase i priključaka u skladu s projektima.	km	0,488		
1.2	Čišćenje i priprema terena. Stavka obuhvaća strojno i ručno uklanjanje šiblja, grmlja, drveća svih debljina. Ovi radovi izvode se na duljini cijele dionice, u širini za 2 metra od ruba projektiranog kolnika. Radovi se izvode u skladu sa OTU 3-03.1. Obračun se vrši po četvornom metru očišćene zarasle površine.	m ²	5075,2		

PRIPREMNI RADOVI UKUPNO:

BROJ STAVKE	OPIS RADOVA	JED. MJERE	KOLIČINA RADOVA	JEDINIČNA CIJENA	UKUPNA CIJENA
----------------	----------------	---------------	--------------------	---------------------	------------------

2. ZEMLJANI RADOVI

- 2.1 Iskop humusa. Rad obuhvaća površinski iskop humusa raznih debljina i njegovo prebacivanje u stalno ili privremeno odlagalište. Humus se iskopava isključivo strojno, a ručno jedino tamo gdje to strojevi ne bi mogli obaviti na zadovoljavajući način. Rad mora biti obavljen u skladu s projektom, propisima, programom kontrole i osiguranja kakvoće (PKOK), projektom organizacije građenje (POG), zahtjevima nadzornog inženjera i O.T.U.2-01
- Obračun se vrši u kubičnim metrima stvarno iskopanog humusa
- m³ 2386.905
- 2.2 Široki iskop u tlu "A", "B" i "C" ktg. U tlu "A" kategorije iskop se vrši hidrauličkim čekićem do 6 m visine. Za zasjeka veće od 6 m potrebno je predvidjeti uporabu miniranja uz prethodnu pripremu s nizom glatkih bušotina tzv. "prespliting".
- U tlu "B" kategorije iskop se vrši hidrauličkim čekićem, a za veće visine potrebno je primjeniti rovokopač s produženom (teleskopskom) granom.
- U tlu "C" kategorije iskop se vrši rovokopačem.
- Pri izradi iskopa treba provesti sve mjere sigurnosti pri radu i sva potrebna osiguranja postojećih objekata i komunikacija.
- U cijenu ulazi iskop, prebacivanje, utovar iskopanog materijala u prijevozno sredstvo, profiliranje ili planiranje terena prema poprečnim profilima u projektu ili po odredbama nadzornog inženjera u ovisnosti o terenskim prilikama.
- Pri iskopu voditi računa o postojećoj infrastrukturi da ne dođe do oštećenja ili uništenja iste i po potrebi, u područjima prolaza komunalnih instalacija iskope obavljati ručno. Izvođač nema pravo na razliku u cijeni iskopa nastalu uslijed ovakvih izmjena. Radovi se obavljaju u skladu s O.T.U. 2-02.
- kat. B (O.T.U. st. 2-02.2) m³ 7603.259

BROJ STAVKE	OPIS RADOVA	JED. MJERE	KOLIČINA RADOVA	JEDINIČNA CIJENA	UKUPNA CIJENA
2.3	<p>Iskop rovova za drenažu. Rad na iskopu rovova za instalacije i drenaže obuhvaća iskop materijala točno prema nacrtima iz projekta sa svim potrebnim razupiranjima, odvodnjom, privremenim odlaganjem iskopanog materijala, te razastiranje ili odvoz viška materijala nakon zatrpavanja rova. Rovove za instalacije i drenaže treba iskopavati strojno, jedino ako to nije moguće, mogu se raditi iznimno ručno uz potrebne mjere sigurnosti i zaštite na radu.</p> <p>Rad mora biti obavljen u skladu s OUT 2-05.</p> <p>Obračun se vrši u kubičnim metrima stvarno iskopanog rova u sraslom stanju</p>	m ³	822.68		
2.4	<p>Izrada nasipa od mješanog materijala. Stavka obuhvaća nasipanje, razastiranje te grubo planiranje materijala u nasipu prema dimenzijama i nagibima iz projekta, kao i zbijanje. Radovi se obavljaju u skladu s O.T.U. 2-09.2</p> <p>Debljina nasipnog sloja mora biti u skladu s vrstom nasipnog materijala te uporabljenim građevinskim strojevima. Kontrola kvalitete uporabljenih nasipnih materijala i zbijenosti po slojevima u svemu prema O.T.U.. Modul stišljivosti mjeren kružnom pločom $\phi 30$ treba biti $M_s \geq 40 \text{ MN/m}^2$, a stupanj zbijenosti $S_z \geq 100\%$.</p> <p>Obračun se vrši po kubičnom metru ugrađenog i zbijenog nasipa.</p>	m ³	7191.25		
2.5	<p>Uređenje posteljice od mješanih materijala. Ovaj rad obuhvaća uređenje posteljice ispod kolničke konstrukcije, zelenog pojasa te nogostupa, tj. grubo i fino planiranje i nabijanje materijala do tražene zbijenosti. Posteljicu treba izraditi prema kotama iz projekta. Radovi se obavljaju u skladu s O.T.U. 2-10.2. Modul stišljivosti mjeren kružnom pločom $\phi 30$ treba biti $M_s \geq 40 \text{ MN/m}^2$, a stupanj zbijenosti $S_z \geq 100\%$.</p> <p>Obračunava se po kvadratnom metru uređene i zbijene posteljice.</p>	m ²	3904,36		

BROJ STAVKE	OPIS RADOVA	JED. MJERE	KOLIČINA RADOVA	JEDINIČNA CIJENA	UKUPNA CIJENA
2.6	<p>Izrada humuziranih i zatravljenih bankina. Ovaj rad obuhvaća izradu bankina prema projektu Debljina humusnog sloja određena je projektom, a to može biti od 5 do 15 cm. Kad se nanose humusni sloj, površinu bankine treba isplanirati s točnošću od ± 2 cm i uvaljati lakim statičkim valjkom u jednom prijelazu. Nakon toga treba bankinu zatraviti u svemu prema potpoglavlju 2-15 O.T.U. Radovi se obavljaju u skladu s O.T.U. 2-16.2.</p> <p>Obračunava se u metrima potpuno završene i zatravljene bankine.</p>	m ²	3600,0		

ZEMLJANI RADOVI UKUPNO:

BROJ STAVKE	OPIS RADOVA	JED. MJERE	KOLIČINA RADOVA	JEDINIČNA CIJENA	UKUPNA CIJENA
----------------	----------------	---------------	--------------------	---------------------	------------------

3. ODVODNJA

3.1	<p>Izrada glinene podloge za drenažu. Na pripremljeno i preuzeto dno iskopa rova moguće je započeti ugradnju podložnog sloja od gline prema rješenjima i zadanoj geometriji iz projekta. Debljina podložnog sloja je od 5 do 15 cm ovisno o rješenju iz projekta. Dno iskopa rova, prije ugradnje glinene podloge, mora biti u nagibima i zbijenosti prema zahtjevu projekta i O.T.U. 3-02.3.2. Glina mora biti visoke plastičnosti, a ugrađuje se pri optimalnoj vlažnosti i zbija tako da stupanj zbijenosti iznosi $Sz \geq 95\%$ od standardnog postupka po Proctoru.</p> <p>Obračunava se u metrima dužnim (m1) ugrađenog sloja gline debljine i širine prema projektu.</p>	m'	628,00		
3.2	<p>Postavljanje drenažnih cijevi. Na izravnano i uređeno dno rova ugrađuje se podloga od gline prema detaljima iz projekta te potom postavljaju drenažne cijevi. Drenažne cijevi su tvornički proizvedene perforirane PEHD cijevi. Radovi se obavljaju u skladu s O.T.U. 3-02.3.3.</p> <p>Obračunava se po metru dužnom (m1) položene drenažne cijevi prema projektu.</p>	m'	628,00		
3.3	<p>Izrada betonskog rigola. Rigol širine 75 cm, izrađuje se od betona MB-30 na pripremljenoj podlozi od drobljenog kamena debljine 15 cm u uvaljanom stanju. Podloga mora imati zbijenost od $Ms \geq 80$ MN/m² mjereno kružnom pločom Ø 30 cm. U jediničnoj cijeni obuhvaćeni su svi radovi, materijali i prijevozi, priprema podloge, spravljanje, doprema, priprema i njega betona.</p> <p>Obračunava se po dužnom metru izvedenog rigola zajedno sa podlogom.</p>	m'	628,00		

ODVODNJA UKUPNO:

BROJ STAVKE	OPIS RADOVA	JED. MJERE	KOLIČINA RADOVA	JEDINIČNA CIJENA	UKUPNA CIJENA
----------------	----------------	---------------	--------------------	---------------------	------------------

4. KOLNIČKA KONSTRUKCIJA

4.1	<p>Izrada nosivog sloja kolničke konstrukcije od mehanički stabiliziranog zrnatog kamenog materijala, debljine 30 cm. Radovi se obavljaju u skladu s O.T.U. 5-01.</p> <p>Rad obuhvaća dobavu i ugradnju drobljenog kamenog materijala veličine zrna 0-63 mm u nosivi sloj konstrukcije prema projektu. Ovaj sloj se može raditi tek kada nadzorni inženjer primi posteljicu u pogledu ravnosti, projektiranih nagiba i pravilno izvedene odvodnje.</p> <p>Modul stišljivosti mjeren kružnom pločom $\phi 30$ treba biti $M_s \geq 100 \text{ MN/m}^2$, a stupanj zbijenosti $S_z \geq 100\%$.</p> <p>Rad se mjeri i obračunava u kubičnim metrima ugrađenog materijala u zbijenom stanju.</p>	m ³	1171.51		
4.2	<p>Izrada bitumeniziranog nosivog sloja BNS22 debljine 8 cm u uvaljanom stanju, prema projektu. Radovi obuhvaćaju nabavu materijala, proizvodnju mješavine i prijevoz do mjesta ugradnje, ugradnju i valjanje do potrebne zbijenosti, te sve potrebne pregradnje. Kvaliteta materijala i izvedenog sloja sve prema OTU i važećim standardima.</p> <p>Obračun u četvornim metrima stvarno položenog bitumeniziranog nosivog sloja.</p>	m ²	2928,78		
4.3	<p>Izrada habajućeg sloja kolnika od asfaltbetona AB11 debljine 4 cm. Radovi obuhvaćaju nabavu materijala, proizvodnju mješavine i prijevoz do mjesta ugradnje, ugradnju i uvaljavanje iste do potrebne zbijenosti, te sve ostale pregradnje koje je potrebno izvršiti radi osiguranja kvalitete. Radovi se obavljaju u skladu s O.T.U. 6-03.</p> <p>Rad se mjeri i obračunava u četvornim metrima gornje površine stvarno položenog sloja.</p>	m ²	2928,78		

KOLNIČKA KONSTRUKCIJA UKUPNO:

BROJ STAVKE	OPIS RADOVA	JED. MJERE	KOLIČINA RADOVA	JEDINIČNA CIJENA	UKUPNA CIJENA
----------------	----------------	---------------	--------------------	---------------------	------------------

5. OPREMA CESTE

5.1 OZNAKE NA KOLNIKU (VODORAVNA SIGNAL.)

Materijal koji se koristi za označavanje na kolniku treba biti trajan i ne smije mijenjati boju. Koeficijent trenja treba biti približno jednak kao kod kolnika, sa maksimalnim odstupanjem +5% kod suhog i +10% kod mokrog kolnika.

Vodoravnu signalizaciju treba iscrtati prema situacionom prometnom rješenju i Pravilniku o prometnim znacima (N.N. 59/2000) i prema O.T.U. 9-02.

- 5.1.1 Puna rubna linija bijele boje (sigurnosna crta), širine 10cm (O.T.U. 9-02.1).

Obračun po metru iscrtane linije.

m¹ 976

- 5.1.2 Puna razdjelna linija bijele boje širine 10cm (O.T.U. 9-02.1).

Obračun po metru iscrtane linije.

m¹ 488

OPREMA CESTE UKUPNO:

REKAPITULACIJA

1. PRIPREMNI RADOVI
2. ZEMLJANI RADOVI
3. ODVODNJA
4. POTPORNI ZIDOVI.....
5. KOLNIČKA KONSTRUKCIJA.....
6. OPREMA CESTE

SVEUKUPNO:

12. LITERATURA

Literatura

- 1) Prof. dr. sc. Željko Korlaet, "Uvod u projektiranje i građenje cesta", Građevinski Fakultet Sveučilišta u Zagrebu, Zagreb, 1995.
- 2) Ministarstvo pomorstva, prometa i veza, "Pravilnik o osnovnim uvjetima kojima javne ceste izvan naselja i njihovi elementi moraju udovoljavati sa stajališta sigurnosti prometa", Narodne novine, Zagreb, 30. studenoga 2001.
- 3) Hrvatske ceste – Hrvatske autoceste, „Opći tehnički uvjeti za radove na cestama“, Institut građevinarstva Hrvatske, Zagreb, prosinac 2001.
- 4) Ministarstvo mora, turizma, prometa i razvitka, "Pravilnik o prometnim znakovima, signalizaciji i opremi na cestama", Narodne novine, Zagreb, 03. ožujka 2005